

FCC Test Report

for

POS Terminal

Trade Name : VeriFone
Model Number : QX700
P/N : M139-XXX-XX-XXX
FCC ID : B32QX700CTLS
Report Number : RF-V040-1210-250
Date of Receipt : October 25, 2012
Date of Report : November 14, 2012

Prepared for

VeriFone Inc.

1400 West Stanford Ranch Road, Suite 200, Rocklin, CA, 95765, UNITED STATES



Prepared by

Central Research Technology Co. EMC Test Laboratory

11, Lane 41, Fushuen St., Jungshan Chiu, Taipei, Taiwan, 104, R.O.C.



NVLAP LAB CODE 200575-0

This report shall not be reproduced, except in full, without the written approval of Central Research Technology Co.. It may be duplicated completely in its entirety for legal use with the permission of the applicant. It should not be used to claim product endorsement by NVLAP, NIST or any U.S. government agency. The test result in the report applies only to the sample tested.

Certification

Equipment Under Test : POS Terminal
Model No. : QX700
P/N : M139-XXX-XX-XXX
FCC ID : B32QX700CTLS
Applicant : VeriFone Inc.
Address : 1400 West Stanford Ranch Road, Suite 200, Rocklin, CA,
95765, UNITED STATES
Applicable Standards : **FCC Part 15, Subpart C**
Date of Testing : October 25 ~ November 7, 2012
Deviation : N/A
Condition of Test Sample : Mass Production

We, **Central Research Technology Co.**, hereby certify that one sample of the designated product was tested in our facility during the period mentioned above. The test records, data evaluation and Equipment Under Test (EUT) configurations shown in the present report are true and accurate representation of the measurements of the sample's RF characteristics under the conditions herein specified.

The test results show that the EUT as described in the present report is in compliance with the requirements set forth in the standards mentioned above and apply to the tested sample identified in the present report only. The test report shall not be reproduced, except in its entirety, without the written approval of Central Research Technology Co.

PREPARED BY : Cathy Chen , **DATE** : Nov. 14, 2012
(Cathy Chen/ Technical Manager)

APPROVED BY : J. Y. Shih , **DATE** : Nov. 14, 2012
(Tsun-Yu Shih/General Manager)

Contents

1.	General Description	5
1.1	GENERAL DESCRIPTION OF EUT	5
1.2	TEST MODE	6
1.3	TEST METHODOLOGY	6
1.4	APPLIED STANDARDS	7
1.5	THE SUPPORT UNITS	10
1.6	LAYOUT OF SETUP	11
1.7	TEST CAPABILITY	12
1.8	MEASUREMENT UNCERTAINTY	14
2.	Field Strength of fundamental Measurement.....	15
2.1	APPLIED STANDARD	15
2.2	TEST INSTRUMENTS	16
2.3	MEASUREMENT PROCEDURE	17
2.4	TEST CONFIGURATION	18
2.5	TEST RESULTS	19
3.	Radiated Emission	23
3.1	APPLIED STANDARD	23
3.2	TEST INSTRUMENTS	24
3.3	MEASUREMENT PROCEDURE	25
3.4	TEST CONFIGURATION	26
3.5	TEST RESULTS	27
4.	Frequency Tolarence	29
4.1	APPLIED STANDARD	29
4.2	TEST INSTRUMENTS	30
4.3	MEASUREMENT PROCEDURE	31
4.4	TEST CONFIGURATION	31
4.5	TEST RESULTS	32
5.	20dB Bandwidth	36
5.1	APPLIED STANDARD	36
5.2	TEST INSTRUMENTS	36
5.3	MEASUREMENT PROCEDURE	37
5.4	TEST CONFIGURATION	37
5.5	TEST RESULTS	38

6.	Conducted Emission Measurement	39
6.1	APPLIED STANDARD	39
6.2	TEST INSTRUMENTS	40
6.3	TEST PROCEDURES	41
6.4	TEST CONFIGURATIONS	42
6.5	TEST RESULTS	43
7.	Antenna Requirement	49
7.1	APPLIED STANDARD	49
7.2	ANTENNA TYPE	49
7.3	APPLICABLE RESULT	49

Attachment 1 – Photographs of the Test Configurations

Attachment 2 – External Photographs of EUT

Attachment 3 – Internal Photographs of EUT

1. General Description

1.1 General Description of EUT

Equipment Under Test	:	POS Terminal
Model No.	:	QX700
Power in	:	Supplied by the power adaptor or 8Vdc~43Vdc
Power Adapter Specification	:	Trade Name: VeriFone Model No.: AU1121204n P/N: CPS11212-3D-R Input : 100-240V~, 50/60Hz, 0.5A Output : 12Vdc, 1A
Test Voltage	:	120Vac/60Hz to the power adaptor
Frequency Range	:	13.56MHz
Channel Numbers	:	1
Function Modulation	:	ASK
Function Description	:	

The EUT is used to transmit and receive signal both. Please refer to the user's manual for the details.

Since the EUT setup horizontal or vertical with table, it was pre-tested on the two axis. There for only the test data of the worse case- vertical was used for Radiated test.

1.2 Test Mode

Pre-scan Mode

Test Mode	Test Voltage
Mode 1	8Vdc
Mode 2	43Vdc
Mode 3	Supplied by the power adaptor

According to the radiated preliminary test, It was found that the Mode 3 is the worst. It was taken as the representative condition for test and its data are recorded in the present document.

1.3 Test Methodology

For this E.U.T., the radiated emissions and conducted emission measurement performed according to the procedures illustrated in ANSI C63.4:2003 and other required are illustrated in separate sections of this test report for detail.

1.4 Applied standards

(1) Field strength of Fundametal

According to 15.225(a), the field strength of any emissions within the band 13.553 - 13.567 MHz shall not exceed 15,848 microvolts/meter at 30 meters.

(2) Band Edge

According to 15.225(b), Within the bands 13.410-13.553 MHz and 13.567-13.710 MHz, the field strength of any emissions shall not exceed 334 microvolts/meter at 30 meters. According to 15.225(c), Within the bands 13.110-13.410 MHz and 13.710-14.010 MHz the field strength of any emissions shall not exceed 106 microvolts/meter at 30 meters.

(3) Radiation emission

According to 15.225(d), the field strength of any emissions appearing outside of the 13.110-14.010 MHz band shall not exceed the general radiated emission limits in § 15.209.

(4) Frequency tolerance

The frequency tolerance of the carrier signal shall be maintained within +/- 0.01% of the operating frequency over a temperature variation of -20 degrees to +50 degrees C at normal supply voltage, and for a variation in the primary supply voltage from 85% to 115% of the rated supply voltage at a temperature of 20 degrees C. For battery operated equipment, the equipment tests shall be performed using a new battery.

(5) Radiated emission limits, general requirements.

According to 15.209, except as provided elsewhere in this Subpart, the emissions from an intentional radiator shall not exceed the field strength levels specified in the following table:

Frequency (MHz)	Field Strength (uV/m)	Measurement Distance (m)
0.009 - 0.490	2400/F(kHz)	300
0.490 - 1.705	24000/F(kHz)	30
1.705 - 30.0	30	30
30 - 88	100 **	3
88 - 216	150 **	3
216 - 960	200 **	3
Above 960	500	3

** Except as provided in paragraph (g), fundamental emissions from intentional radiators operating under this Section shall not be located in the frequency bands 54-72 MHz, 76-88 MHz, 174-216 MHz or 470-806 MHz. However, operation within these frequency bands is permitted under other sections of this Part, e.g., Sections 15.231 and 15.241.

(6) 20dB Bandwidth

According to 15.215(c) requires the device must be designed to ensure that the 20 dB bandwidth of the emission, or whatever bandwidth may otherwise be specified in the specific rule section under which the equipment operates.

(7) Conduction Emission Requirement

For intentional device, according to §15.207(a) line conduction emission limit is as below table.

Frequency of Emission (MHz)	Conducted Limit (dBuV)	
	Quasi-peak	Average
0.15 – 0.5	66 to 56*	56 to 46*
0.5 - 5	56	46
5 - 30	60	50

* Decreases with the logarithm of the frequency.

(8) Restricted Band

Frequency (MHz)	Frequency (MHz)	Frequency (MHz)	Frequency (GHz)
0.090 - 0.110	16.42 - 16.423	399.9 - 410	4.5 - 5.15
¹ 0.495 - 0.505	16.69475 - 16.69525	608 - 614	5.35 - 5.46
² 1735 - 2.1905	16.80425 - 16.80475	960 - 1240	7.25 - 7.75
4.125 - 4.128	25.5 - 25.67	1300 - 1427	8.025 - 8.5
4.17725 - 4.17775	37.5 - 38.25	1435 - 1626.5	9.0 - 9.2
4.20725 - 4.20775	73 - 74.6	1645.5 - 1646.5	9.3 - 9.5
6.215 - 6.218	74.8 - 75.2	1660 - 1710	10.6 - 12.7
6.26775 - 6.26825	108 - 121.94	1718.8 - 1722.2	13.25 - 13.4
6.31175 - 6.31225	123 - 138	2200 - 2300	14.47 - 14.5
8.291 - 8.294	149.9 - 150.05	2310 - 2390	15.35 - 16.2
8.362 - 8.366	156.52475 - 156.52525	2483.5 - 2500	17.7 - 21.4
8.37625 - 8.38675	156.7 - 156.9	2690 - 2900	22.01 - 23.12
8.41425 - 8.41475	162.0125 - 167.17	3260 - 3267	23.6 - 24.0
12.29 - 12.293	167.72 - 173.2	3332 - 3339	31.2 - 31.8
12.51975 - 12.52025	240 - 285	3345.8 - 3358	36.43 - 36.5
12.57675 - 12.57725	322 - 335.4	3600 - 4400	(2)
13.36 - 13.41			

¹ Until February 1, 1999, this restricted band shall be 0.490-0.510 MHz.

² Above 38.6

(9) Antenna Requirement

An intentional radiator shall be designed to ensure that no antenna other than that furnished by the responsible party shall be used with the device. The use of a permanently attached antenna or of an antenna that uses a unique coupling to the intentional radiator shall be considered sufficient to comply with the provisions of this Section. The manufacturer may design the unit so that a broken antenna can be replaced by the user, but the use of a standard antenna jack or electrical connector is prohibited. This requirement does not apply to carrier current devices or to devices operated under the provisions of Sections 15.211, 15.213, 15.217, 15.219, or 15.221. Further, this requirement does not apply to intentional radiators that must be professionally installed, such as perimeter protection systems and some field disturbance sensors, or to other intentional radiators which, in accordance with Section 15.31(d), must be measured at the installation site. However, the installer shall be responsible for ensuring that the proper antenna is employed so that the limits in this Part are not exceeded.

1.5 The Support Units

No.	Unit	Model No.	FCC ID	Trade Name	Power Cord	Supported by lab.
1.	PC	8200E TM	DoC	HP	1.8m	✓
2.	PS/2 Keyboard	5181	DoC	HP	N/A	✓
3.	PS/2 Mouse	MO15K	DoC	HP	N/A	✓
4.	LCD MONITOR	f1723	DoC	HP	1.8m	✓
5.	IC Card	Pay Pass M/Chip (Type-A)	N/A	N/A	N/A	
6.	SAM Card	N/A	N/A	N/A	N/A	
7.	Printer	930c	N/A	HP	N/A	✓

1.6 Layout of Setup

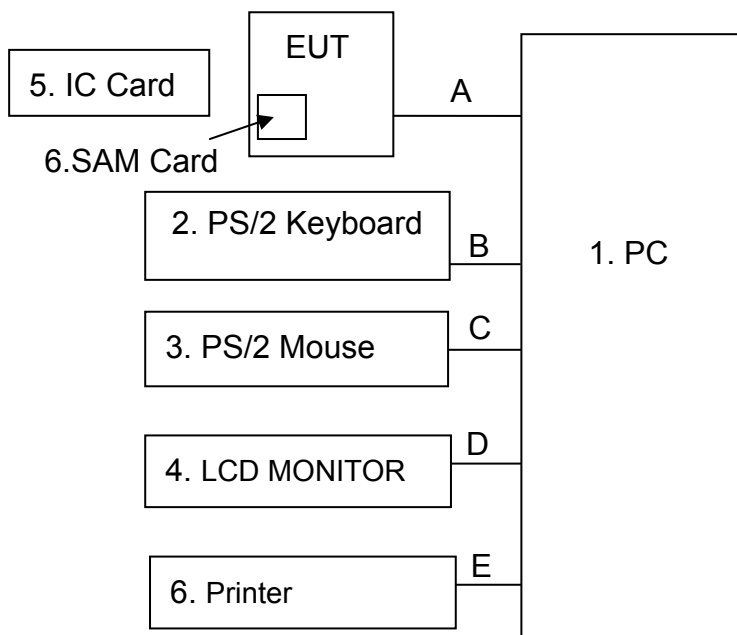

Connecting Cables :

No.	Cable	Length	Shielded	Core	Shielded Backshell	Supported by lab.
A	RS232 Cable (CBL139-005-02-A)	2.0m	✓			
B	PS/2 Keyboard Cable	1.8m	✓			✓
C	PS/2 Mouse Cable	2.0m	✓			✓
D	D-Sub Cable	1.7m	✓	✓		✓
E	USB Cable	0.9m	✓	✓		

Justification:

For both conducted and radiated emission below 1GHz, the system was configured for typical fashion as a customer could use it normally.

For radiated emission, measurement of radiated emission from digital circuit is performed with normal transmitting.

1.7 Test Capability

Test Facility

The test facility used for evaluating the conformance of the EUT with each standard in the present report meets what required in CISPR16-1-4, CISPR16-2-3 and ANSI C63.4:2003.

Test Room	Type of Test Room	Descriptions
TR1	10m semi-anechoic chamber (23m×14m×9m)	Complying with the NSA requirements set in documents CISPR 22 and ANSI C63.4:2003. For the radiated emission measurement.
TR11	3m semi-anechoic chamber (9m × 6m × 6m)	
TR13	Test site	For the RF conducted emission measurement.
TR5	Shielding Room (8m×5m×4m)	For the conducted emission measurement.

Test Laboratory Competence Information

Central Research Technology Co. has been accredited / filed / authorized by the agencies listed in the following table.

Certificate	Nation	Agency	Code	Mark
Accreditation Certificate	USA	NVLAP	200575-0	ISO/IEC 17025
	R.O.C. (Taiwan)	TAF	0905	ISO/IEC 17025
	R.O.C. (Taiwan)	BSMI	SL2-IN-E-0033, SL2-IS-E-0033, SL2-R1/R2-E-0033, SL2-A1-E-0033 SL2-L1-E-0033	ISO/IEC 17025
Site Filing Document	USA	FCC	474046,TW1053	Test facility list & NSA Data
	Canada	IC	4699A-1,-3	Test facility list & NSA Data
	Japan	VCCI	R-1527,C-1609,T-1441,G-10	Test facility list & NSA Data
Authorization Certificate	Germany	TUV	10021687	ISO/IEC 17025
	Norway	Nemko	ELA 212	ISO/IEC 17025

The copy of each certificate can be downloaded from our web site: www.crc-lab.com

1.8 Measurement Uncertainty

The assessed measurement uncertainty with a suitable coverage factor K to ensure 95% confidence level for the normal distribution are shown as below, the values are less than U_{cispr} in table 1 of CISPR 16-4-2.

Test Item	Measurement Uncertainty	
Frequency error	4.2Hz	
Radiated Emission: (30MHz~200MHz)	Horizontal: 3.5dB ; Vertical: 3.9dB	
Radiated Emission: (200MHz~1GHz)	Horizontal: 3.9dB ; Vertical: 3.9dB	
Conducted Emission	ESH2-Z5	3.1dB
	ENV 4200	2.8dB

2. Field Strength of fundamental Measurement

Test Result : PASS

2.1 Applied Standard

According to 15.225(a), the field strength of any emissions within the band 13.553 – 13.567 MHz shall not exceed 15,848 microvolts/meter at 30 meters.

According to 15.225(b), within the bands 13.410-13.553 MHz and 13.567-13.710 MHz, the field strength of any emissions shall not exceed 334 microvolts/meter at 30 meters.

According to 15.225(c), within the bands 13.110-13.410 MHz and 13.710-14.010 MHz the field strength of any emissions shall not exceed 106 microvolts/meter at 30 meters.

2.2 Test Instruments

Test Site and Equipment	Manufacturer	Model No./ Serial No.	Last Calibration Date	Calibration Due Date
EMI Test Receiver	R&S	ESCI/ 100019	June 6, 2012	June 6, 2013
Loop Antenna	EMCO	6502/ 20558	Aug. 11, 2011	Aug. 11, 2013
TR11 Semi – anechoic Chamber	ETS. LINDGREN	TR11/ 906-A	April 22, 2012	April 22, 2013

Note:

1. The calibrations are traceable to NML/ROC.
2. NCR : No Calibration Required.
3. The calibration date of the semi-anechoic chamber listed above is the date of NSA measurement.

Instrument Setting

RBW	VBW	Detector	Trace	Comment
9kHz	N/A	Quasi-Peak	Maxhold	

Climatic Condition

Ambient Temperature : 26°C ; Relative Humidity : 66%

2.3 Measurement Procedure

- a. The EUT was set up per the test configuration figured in the next section of this chapter to simulate the typical usage per the user's manual.
- b. If the EUT is tabletop equipment, it should be placed on a wooden table with a height of 0.8 meters above the reference ground plane in the semi-anechoic chamber. If the EUT is floor-standing equipment, it should be placed on a non-conducted support with a height of 12 millimeters above the reference ground plane in the semi-anechoic chamber.
- c. The EUT is set at 3m away from the receiving antenna.
- d. Rapidly sweep the signal in the test frequency range by using the receiver through the Quasi-Peak detector.
- e. Rotate the EUT from 0° to 360° and position the receiving loop antenna at 1~4 meters above the reference ground plane to determine the fundamental frequency and and bandedge and record them.
- f. Then measure each frequency found from step e. by using the receiver with rotating the EUT and positioning the receiving antenna height to determine the maximum level.
- g. Finely tune the antenna and turntable around the recorded position of each frequency found from step e.
- h. Record and compare the maximum level with the required limit.
- i. Change the receiving antenna to another polarization to measure field strength of fundamental by following step d. to g. again.

2.4 Test Configuration

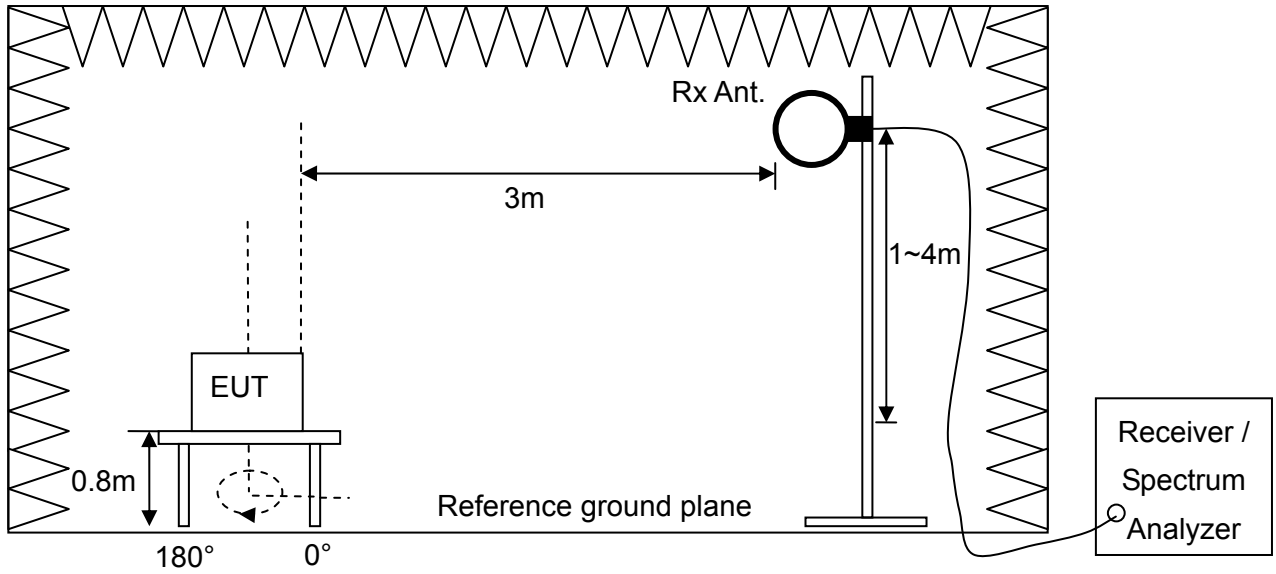

2.5 Test Results

Field strength of fundamental

Test Mode : Mode 1, Continuous Transmitting

Tester : Liu

Freq. (MHz)	Polarization	Reading Data (dBuV)	Correction Factor (dB/m)	Emission Level (dBuV/m)	Limit (dBuV/m)	Margin (dB)
13.56	H	62.97	14.33	77.30	124	46.70
13.56	V	59.22	14.33	73.55	124	50.45

Note :

1. Correction Factor (dB/m) = Cable Loss + Antenna Factor
2. Output Field Strength (dBuV/m) = Reading Data + Correction Factor
3. The limit is 15848 (uV/m)=84dBuV/m @ 30 m , for main frequency < 30MHz, the formula transfers the limit at 30 m to 3m is $L_{30}(\text{dBuV/m}) + 40 = 124 \text{ dBuV/m}$
4. Margin (dB) = Limit – Output Field Strength

H Polarization

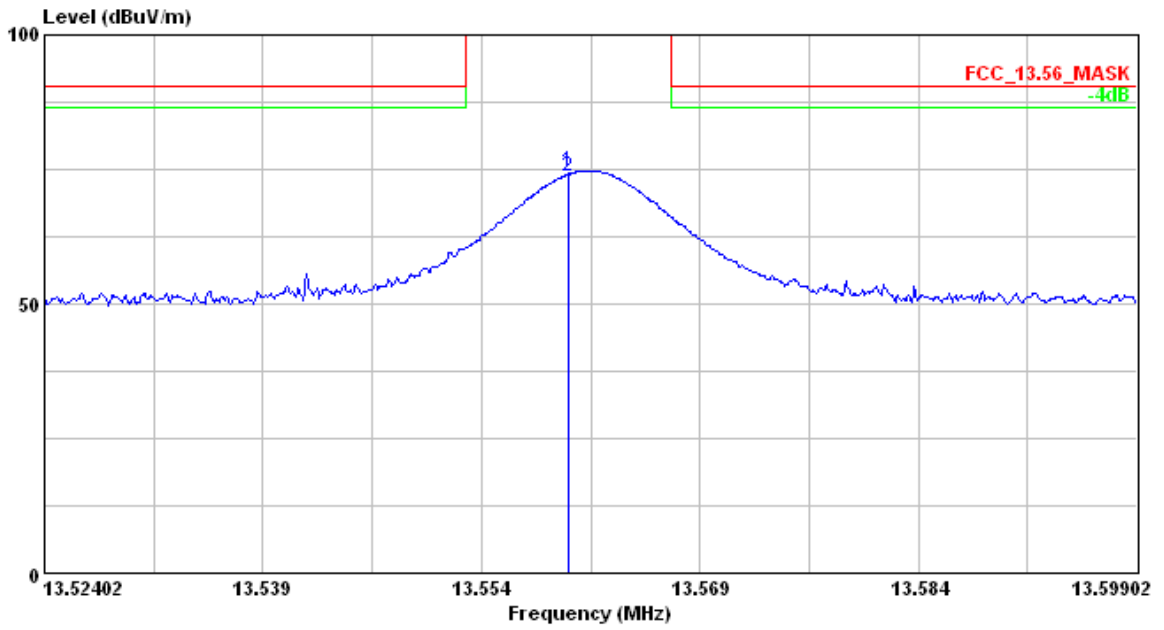

V Polarization

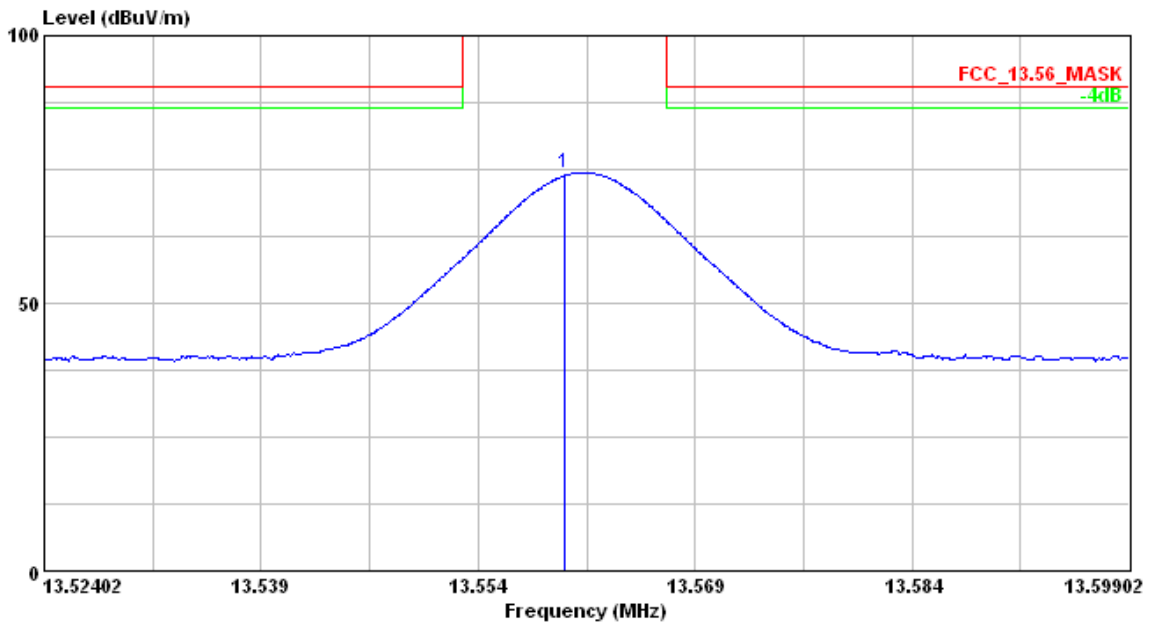

Band Edge

Test Mode : Mode 1, Continuous Transmitting

Tester : Liu

Emission Freq. (MHz)	Polarizantal	Reading Data (dBUV)	Correction Factor (dB/m)	Maximum Emission within the band (dBUV/m)	Limit (dBUV/m)	Margin (dB)
13.35	H	41.93	14.35	56.28	80.51	24.23
13.35	V	38.35	14.35	52.7	80.51	27.81
13.48	H	41.26	14.34	55.6	90.47	34.87
13.48	V	38.60	14.34	52.94	90.47	37.53
13.64	H	42.16	14.33	56.49	90.47	33.98
13.64	V	38.29	14.33	52.62	90.47	37.85
13.77	H	37.19	14.32	51.51	80.51	29.00
13.78	V	29.34	14.32	43.66	80.51	36.85

Note :

1. Correction Factor (dB/m) = Cable Loss + Antenna Factor
2. Output Field Strength (dBUV/m) = Reading Data + Correction Factor
3. For main frequency < 30MHz, the formula transfers the limit at 30 m to 3m is $L_{30}(\text{dBUV/m}) + 40$
4. Margin (dB) = Limit – Output Field Strength

H Polarization

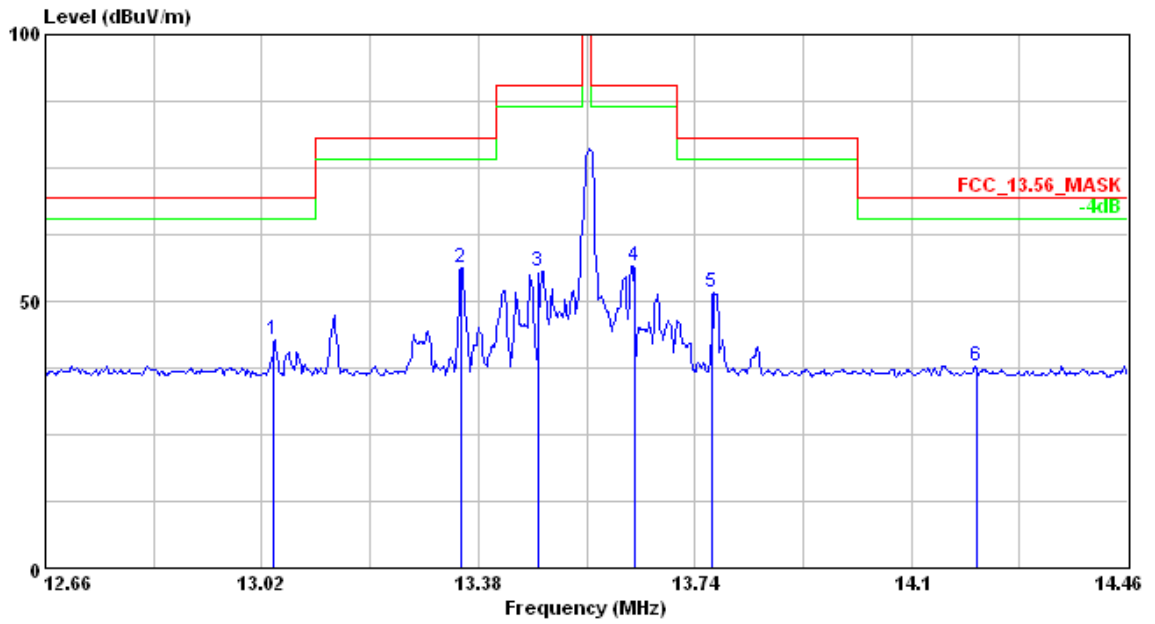

V Polarization

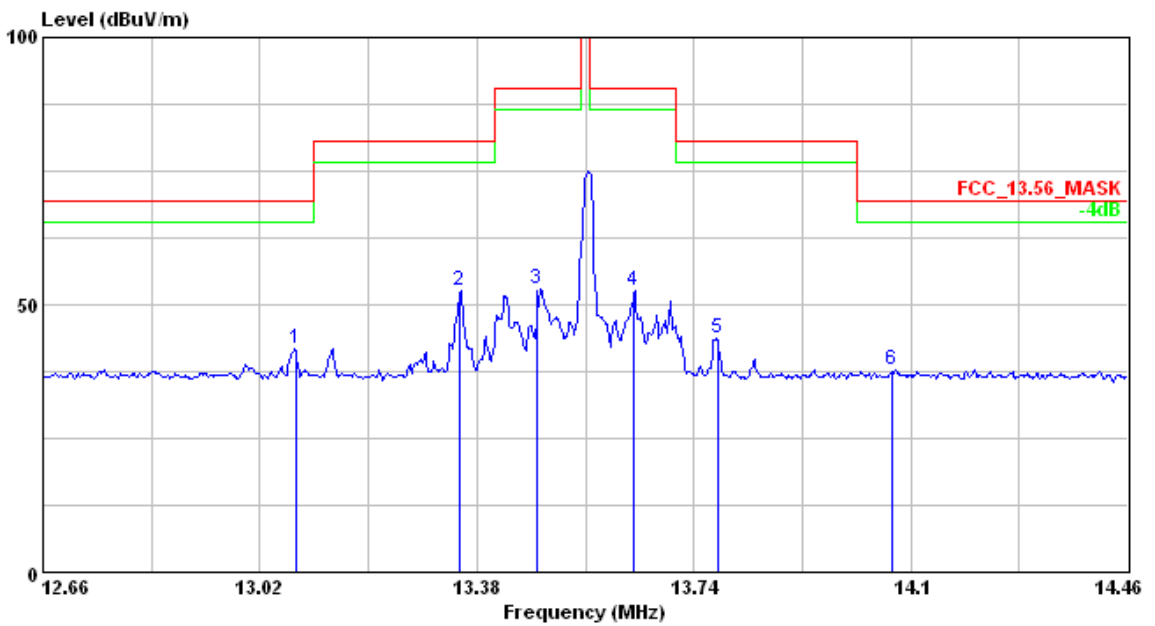

3. Radiated Emission

Test Result : PASS

3.1 Applied Standard

According to 15.225(d), The field strength of any emissions appearing outside of the 13.110-14.010 MHz band shall not exceed the general radiated emission limits in § 15.209.

Frequency (MHz)	Field Strength (uV/m)	Measurement Distance (m)
0.009 - 0.490	2400/F(kHz)	300
0.490 - 1.705	24000/F(kHz)	30
1.705 - 30.0	30	30
30 - 88	100 **	3
88 - 216	150 **	3
216 - 960	200 **	3
Above 960	500	3

** Except as provided in paragraph (g), fundamental emissions from intentional radiators operating under this Section shall not be located in the frequency bands 54-72 MHz, 76-88 MHz, 174-216 MHz or 470-806 MHz. However, operation within these frequency bands is permitted under other sections of this Part, e.g., Sections 15.231 and 15.241.

3.2 Test Instruments

Test Site and Equipment	Manufacturer	Model No./ Serial No.	Last Calibration Date	Calibration Due Date
EMI Test Receiver	R&S	ESCI/ 100019	June 6, 2012	June 6, 2013
Spectrum Analyzer	Agilent	E4407B/ MY45106795	May 4, 2012	May 4, 2013
Loop Antenna	EMCO	6502/ 20558	Aug. 11, 2011	Aug. 11, 2013
Bi-Log Antenna	EMCO	3142C/ 52088	May 22, 2012	May 22, 2013
Pre-Amplifier	Mini-circuit	ZKL-2/ 004	Aug. 6, 2012	Feb. 6, 2013
RF Cable	N/A	N/A/ C0080	Aug. 6, 2012	Feb. 6, 2013
TR11 Semi - anechoic Chamber	ETS. LINDGREN	TR11/ 906-A	April 22, 2012	April 22, 2013

Note:

1. The calibrations are traceable to NML/ROC.
2. NCR:No Calibration Required.
3. The calibration date of the semi-anechoic chamber listed above is the date of NSA measurement.

Instrument Setting

RBW	VBW	Detector	Trace	Comment
9kHz	N/A	Quasi-Peak	Maxhold	Below 30MHz
120kHz	N/A	Quasi-Peak	Maxhold	Below 1GHz

Climatic Condition

Ambient Temperature : 26°C; Relative Humidity : 66%

3.3 Measurement Procedure

- a. The EUT was set up per the test configuration figured in the next section of this chapter to simulate the typical usage per the user's manual.
- b. A software provided by client enabled the EUT to transmit and receive data at specified channel frequencies individually.
- c. If the EUT is tabletop equipment, it was placed on a non-conducted table with a height of 0.8 meters above the reference ground plane in the semi-anechoic chamber. If the EUT is floor-standing equipment, it was placed on a non-conducted support with a height of 12 millimeters above the reference ground plane in the semi-anechoic chamber.
- d. The EUT is set at 3m away from the interference receiving antenna.
- e. Rapidly sweep the signal in the test frequency range by using the spectrum through the Maximum-peak detector.
- f. Rotate the EUT from 0° to 360° and position the receiving antenna at heights from 1 to 4 meters above the reference ground plane continuously to determine at least six frequencies associated with higher emission levels and record them.
- g. For measurement of frequency above 1000MHz, the beamwidth of receiving horn antenna should keep covering EUT when the receiving horn antenna height varied.
- h. Then measure each frequency found from step e. by using the spectrum with rotating the EUT and positioning the receiving antenna height to determine the maximum level.
- i. Finely tune the antenna and turntable around the recorded position of each frequency found from step g.
- j. For measurement of frequency below 1000MHz, set the receiver detector to be Quasi-Peak per CISPR 16-1 to find out the maximum level occurred.
- k. For measurement of frequency above 1000MHz, set the spectrum detector to be Peak or Average to find out the maximum level occurred, if any.
- l. Record frequency, azimuth angle of the turntable, height, and polarization of the receiving antenna and compare the maximum level with the required limit.
- m. Change the receiving antenna to another polarization to measure radiated emission by following step e. to l. again.
- n. If the peak emission level measured from step e. is 4dB lower than the limit specified, then the emission values presented will be the peak value only. Otherwise, accurate Q.P. value will be measured and presented.

3.4 Test Configuration

Radiated Emission Measurement below 30MHz

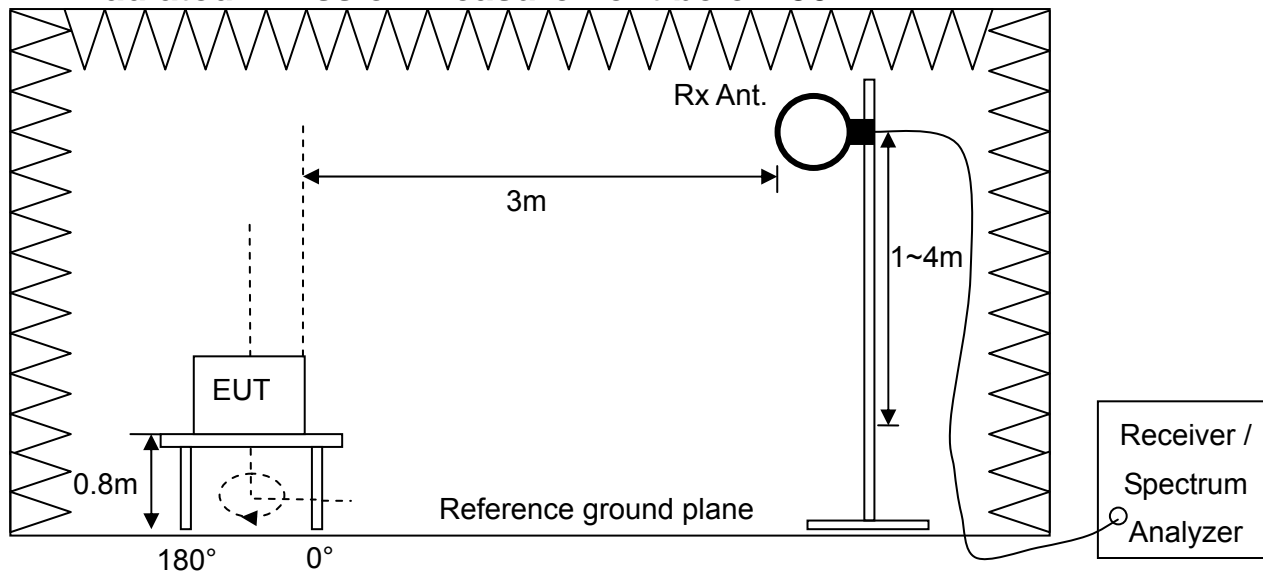

Radiated Emission Measurement above 30MHz

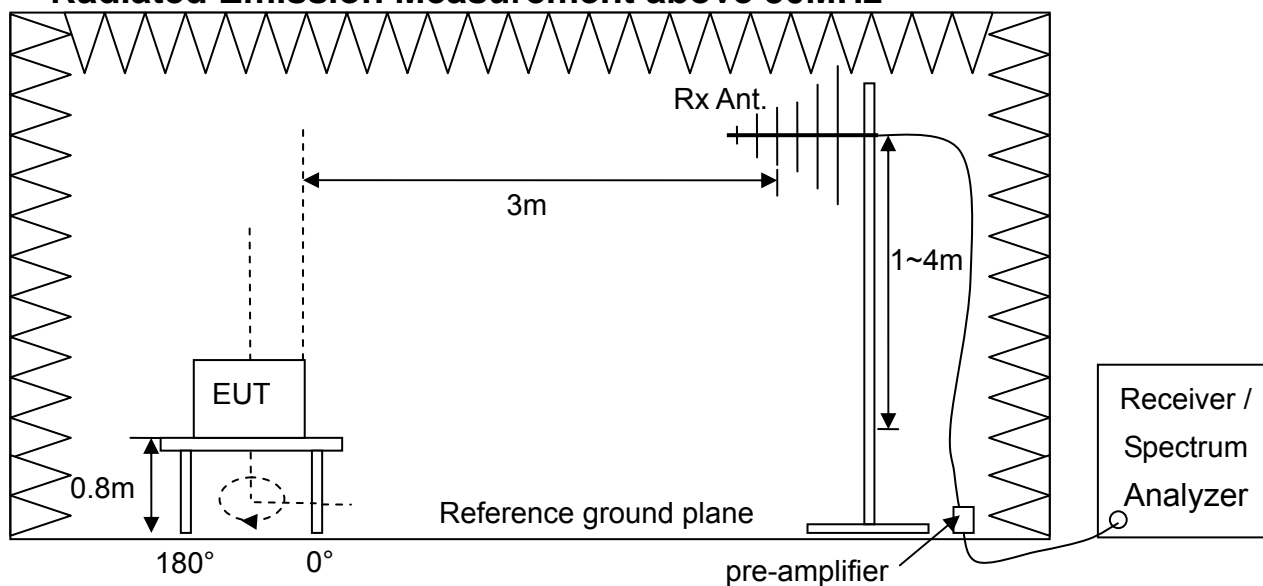

3.5 Test Results

Test Mode : Mode 1, Continuous Transmitting
Tester : Liu **Frequency Range** : 9kHz~1GHz
Polarization : Horizontal

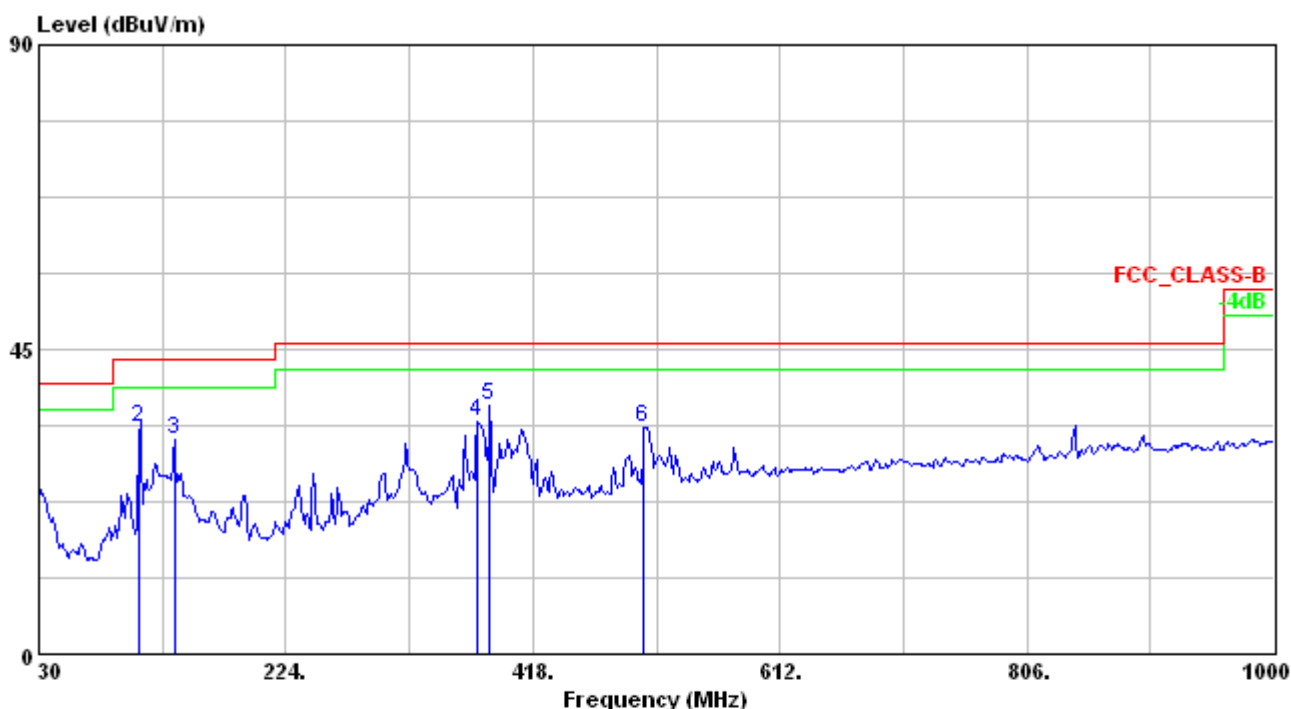

	Freq	Level	Read Level	Factor	Limit Line	Over Limit	Ant Pos	Table Pos	Pol/Phase	Remark
	MHz	dBuV/m	dBuV	dB/m	dBuV/m	dB	cm	deg		
1	30.000	24.69	32.70	-8.01	40.00	-15.31	---	---	HORIZONTAL	Peak
2	108.485	33.36	51.94	-18.58	43.50	-10.14	321	290	HORIZONTAL	QP
3	136.700	31.60	50.11	-18.51	43.50	-11.90	---	---	HORIZONTAL	Peak
4	374.350	34.40	44.04	-9.64	46.00	-11.60	---	---	HORIZONTAL	Peak
5 @	384.050	36.80	46.22	-9.42	46.00	-9.20	---	---	HORIZONTAL	Peak
6	505.300	33.56	40.44	-6.88	46.00	-12.44	---	---	HORIZONTAL	Peak

Note :

1. Correction Factor (dB/m) = Cable Loss + Antenna Factor – Gain of Preamplifier
2. Emission Level (dBuV/m) = Reading Data + Correction Factor

No signal can be detected from 9kHz to 30MHz, so the graphs are omitted below 30MHz.

Test Mode : Mode 1, Continuous Transmitting
 Tester : Liu Frequency Range : 9kHz~1GHz
 Polarization : Vertical

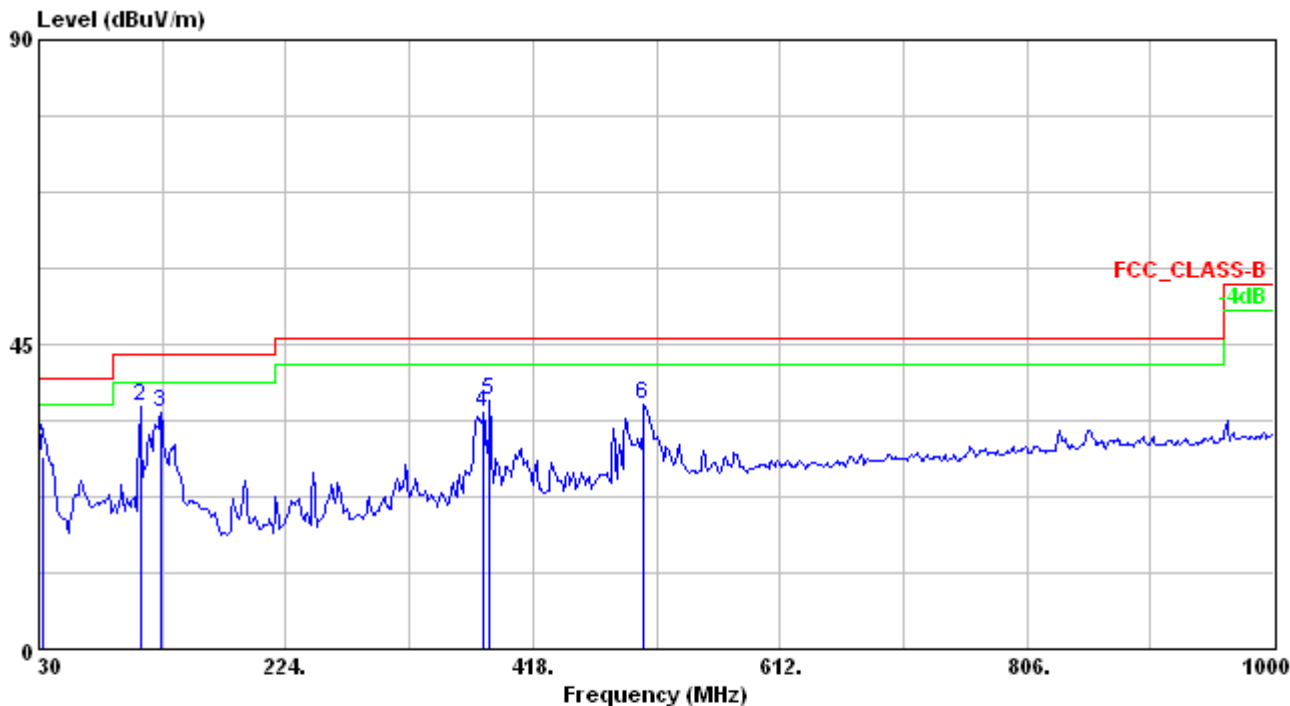

	Freq	Level	Read Level	Limit	Over	Ant	Table	Table	Pol/Phase	Remark
	MHz	dBuV/m	dBuV	dB/m	dBuV/m	dB	cm	deg		
1	33.357	28.32	38.38	-10.06	40.00	-11.68	101	165	VERTICAL	QP
2	109.540	35.86	54.50	-18.64	43.50	-7.64	---	---	VERTICAL	Peak
3	126.030	34.93	53.94	-19.01	43.50	-8.57	---	---	VERTICAL	Peak
4	379.200	34.94	44.47	-9.53	46.00	-11.06	---	---	VERTICAL	Peak
5	384.050	36.64	46.06	-9.42	46.00	-9.36	---	---	VERTICAL	Peak
6	505.300	36.14	43.02	-6.88	46.00	-9.86	---	---	VERTICAL	Peak

Note :

1. Correction Factor (dB/m) = Cable Loss + Antenna Factor – Gain of Preamplifier
2. Emission Level (dBuV/m) = Reading Data + Correction Factor

No signal can be detected from 9kHz to 30MHz, so the graphs are omitted below 30MHz.

4. Frequency Tolerance

Test Result : PASS

4.1 Applied Standard

According to 15.225(e), the frequency tolerance of the carrier signal shall be maintained within +/- 0.01% of the operating frequency over a temperature variation of -20 degrees to +50 degrees C at normal supply voltage, and for a variation in the primary supply voltage from 85% to 115% of the rated supply voltage at a temperature of 20 degrees C. For battery operated equipment, the equipment tests shall be performed using a new battery.

4.2 Test Instruments

Test Site and Equipment	Manufacturer	Model No./ Serial No.	Last Calibration Date	Calibration Due Date
Spectrum Analyzer	Agilent	E4405B/ MY45106706	March 29, 2012	March 29, 2013
Temperature Chamber	Terchy	MHG-800LF/ 920224	Aug. 13, 2012	Aug. 13, 2013
Adjustable AC Power Supply	EXTECH	6110/1102108	NCR	NCR
Voltage Meter	FLUKE	187/91050091	July 2, 2012	July 2, 2013
Test Site	N.A.	TR13	NCR	NCR

Note:

1. The calibrations are traceable to NML/ROC.
2. NCR:No Calibration Required.

Instrument Setting

RBW	VBW	Detector	Trace	Comment
300Hz	1kHz	Peak	Maxhold	

Climatic Condition

Ambient Temperature : 24°C; Relative Humidity : 55%

4.3 Measurement Procedure

- a. The EUT was set up per the test configuration figured in the next section of this chapter to simulate the typical usage described in the user's manual supported by the manufacturer in test site TR13.
- b. Measure the frequency tolerance by using the spectrum analyzer and following the test conditions described in FCC 15.225(e) to perform the normal and extreme conditions test.
- c. Record the value and compare with the required limit.

4.4 Test Configuration

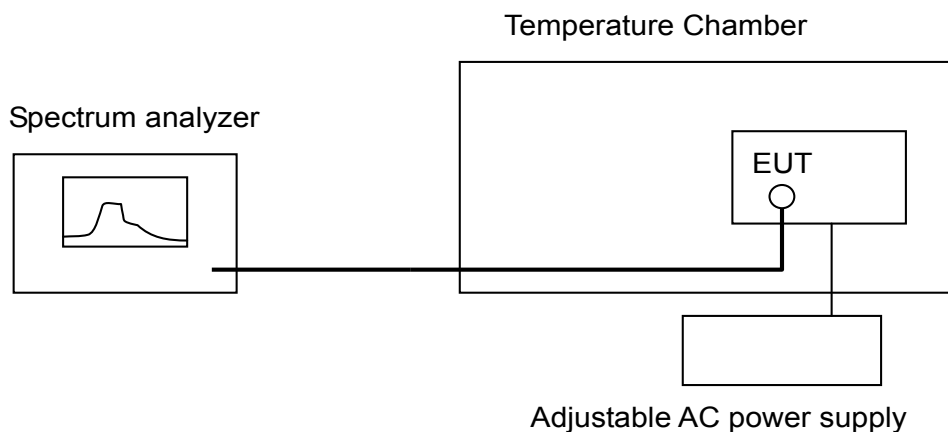

4.5 Test Results

Test Mode : Mode 1, Continuous Transmitting

Tester : Jun

Temperature (°C)	DC Voltage (Volt)	Meas. Frequency (MHz)	Deviation (kHz)	Limit (kHz)	Margin (kHz)
20°C	120	13.56131	N/A	N/A	N/A
	102	13.56130	0.01	1.356	1.346
	138	13.56130	0.01	1.356	1.346
-20°C	120	13.56133	0.02	1.356	1.336
50°C	120	13.56133	0.02	1.356	1.336

Note:

1. Deviation(kHz) = | Meas. Frequency – Meas. Frequency @20°C/120Vac |
2. Margin (kHz)= Limit – Deviation

20°C, 120Vdc

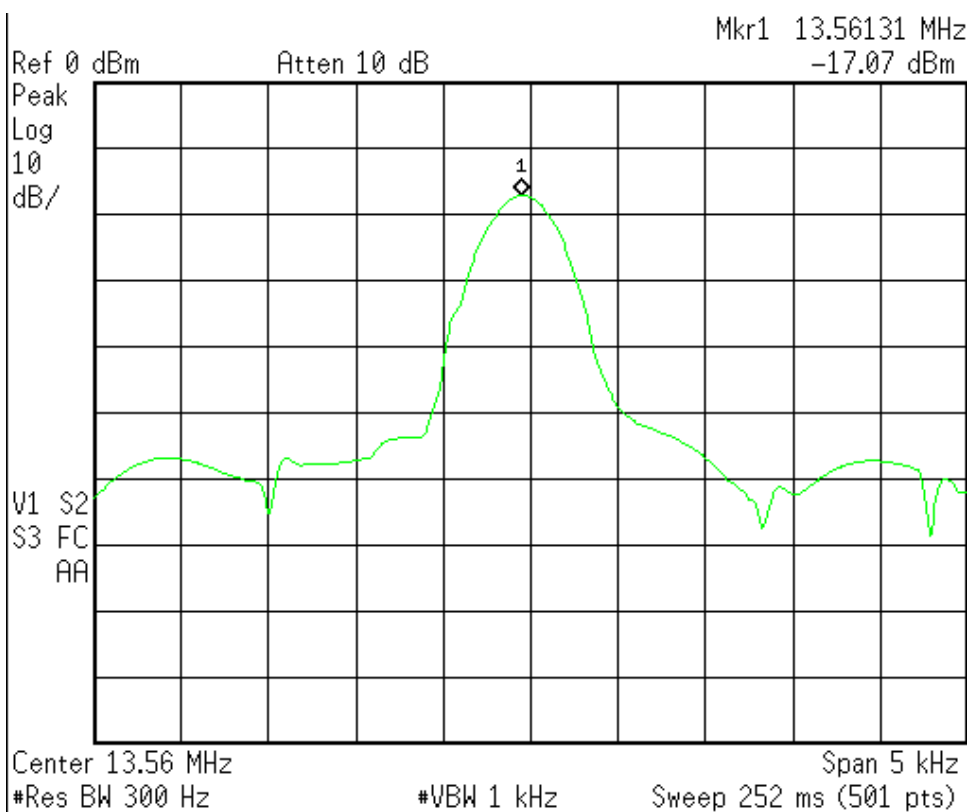

20°C, 102Vdc

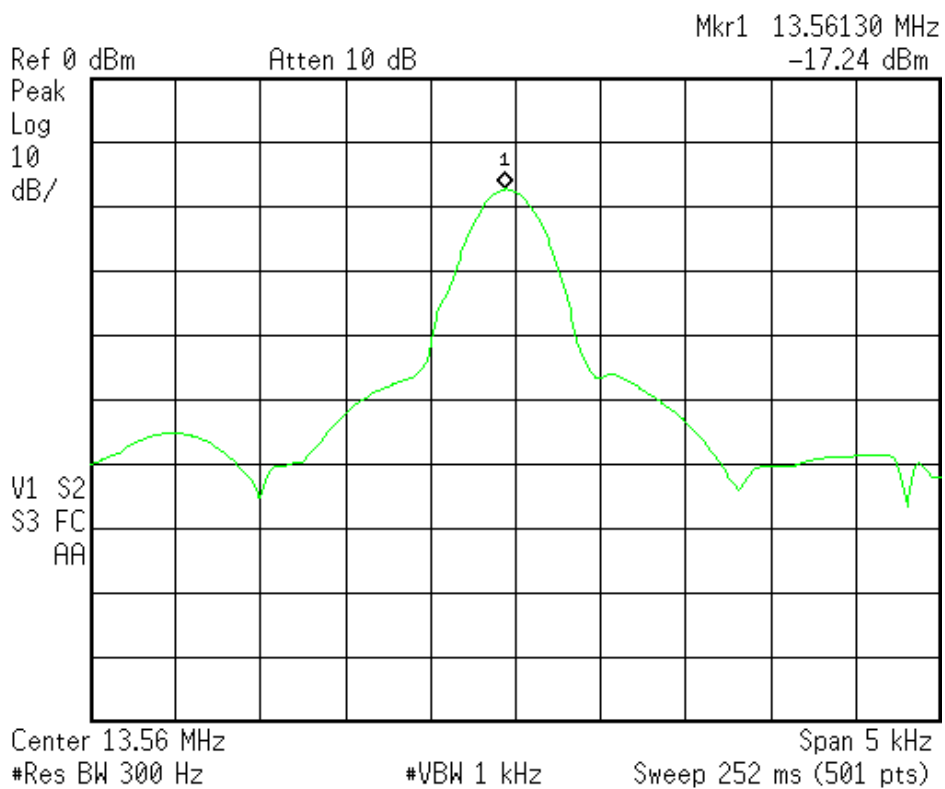

20°C, 138Vdc

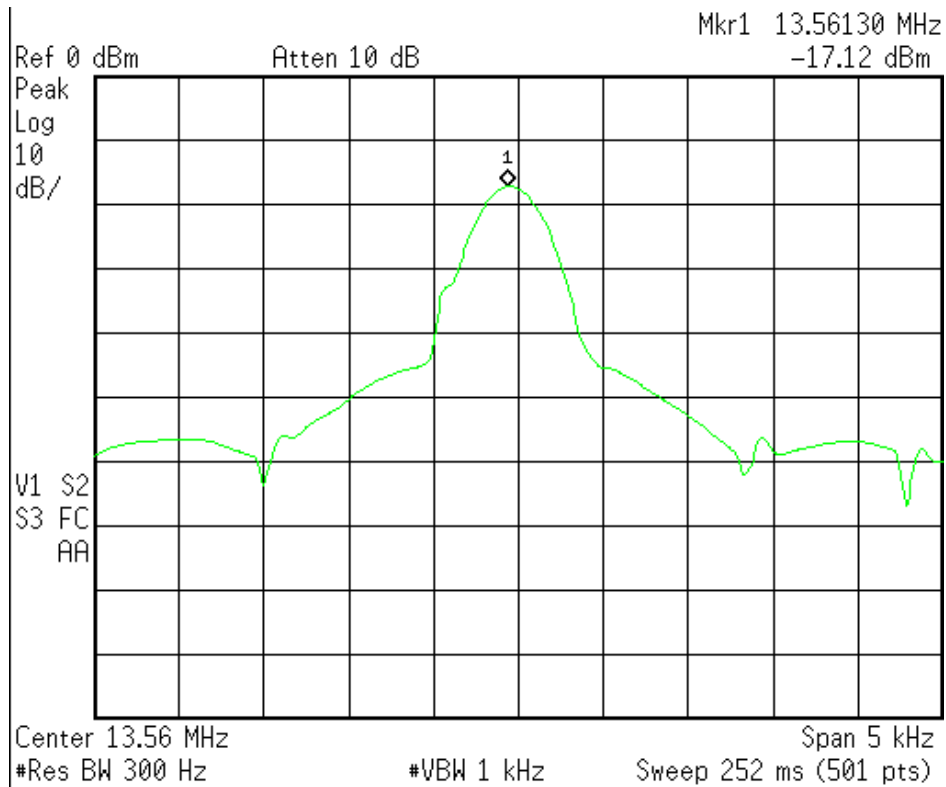

-20°C, 120Vdc

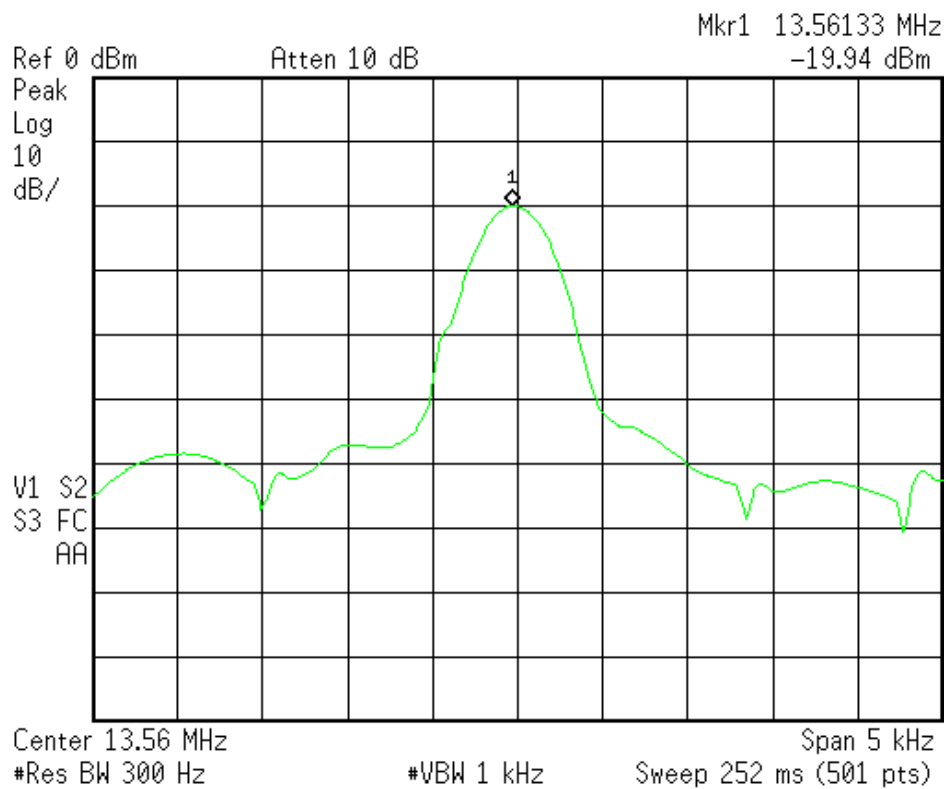

50°C, 120Vdc

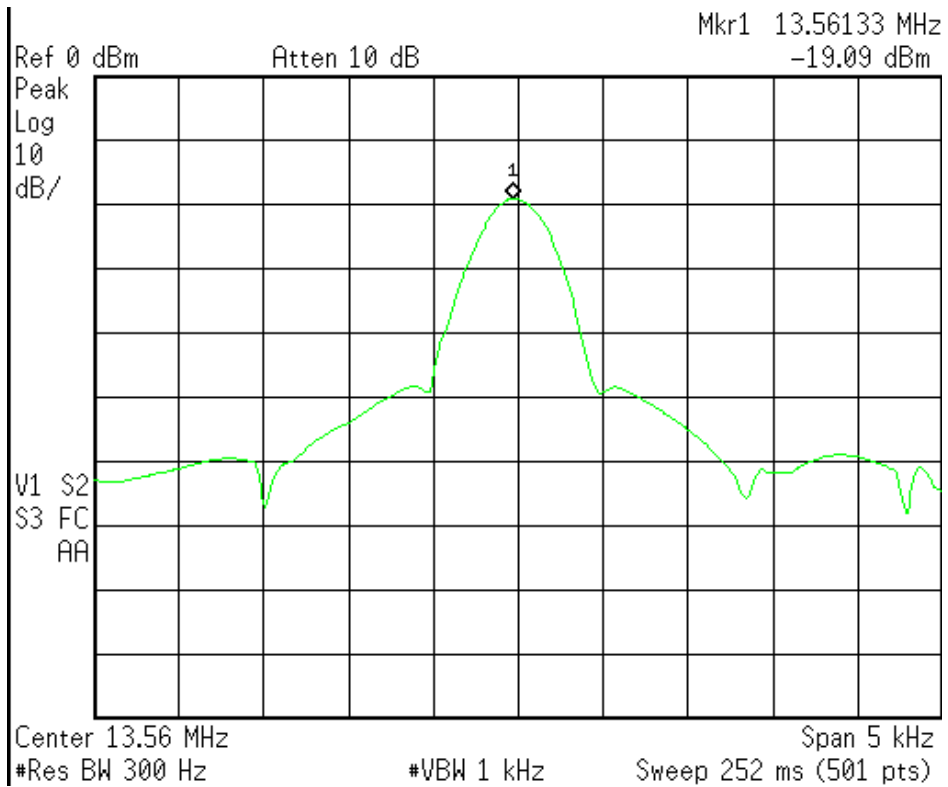

5. 20dB Bandwidth

Test Result : PASS

5.1 Applied Standard

According to 15.215(c) requires the device must be designed to ensure that the 20 dB bandwidth of the emission, or whatever bandwidth may otherwise be specified in the specific rule section under which the equipment operates.

According to 15.225, Operation should within the band 13.110 – 14.010 MHz.

5.2 Test Instruments

Test Site and Equipment	Manufacturer	Model No./ Serial No.	Last Calibration Date	Calibration Due Date
Spectrum Analyzer	Agilent	E4405B/ MY45106706	March 29, 2012	March 29, 2013
Test Site	N.A.	TR13	NCR	NCR

Note:

- 1.The calibrations are traceable to NML/ROC.
- 2.NCR : No Calibration Required.

Instrument Setting

RBW	VBW	Detector	Trace	Comment
300Hz	1kHz	Peak	Maxhold	

Climatic Condition

Ambient Temperature : 24°C; Relative Humidity : 55%

5.3 Measurement Procedure

- a. The EUT was set up per the test configuration figured in the next section of this chapter to simulate the typical usage described in the user's manual supported by the manufacturer in test site TR13.
- b. Measure the 20dB bandwidth by using the spectrum analyzer and following the test conditions described in FCC 15.215.
- c. Record the frequency and compare with the required limit.

5.4 Test Configuration



5.5 Test Results

Test Mode : Mode 1, Continuous Transmitting

Tester : Bill

Operating Frequency (MHz)	Limit (MHz)
13.56	13.110~14.01

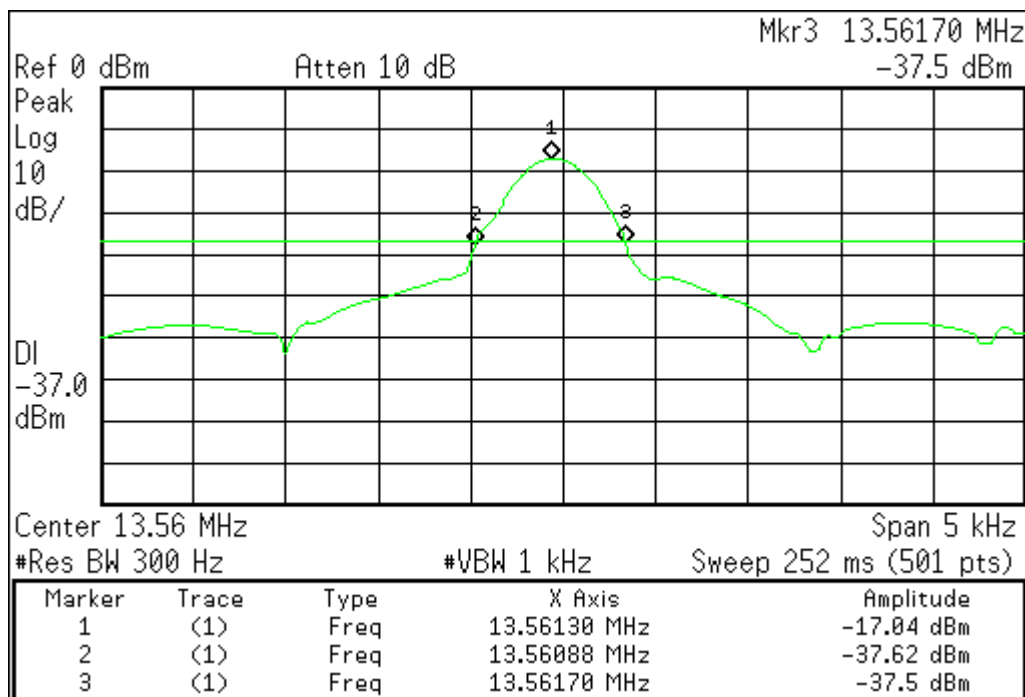

6. Conducted Emission Measurement

Test Result : PASS

6.1 Applied Standard

For intentional device, according to §15.207(a) line conduction emission limit is as below table.

Frequency of Emission (MHz)	Conducted Limit (dBuV)	
	Quasi-peak	Average
0.15 – 0.5	66 to 56*	56 to 46*
0.5 - 5	56	46
5 - 30	60	50

* Decreases with the logarithm of the frequency.

Note:

For a device with a permanent antenna operating at or below 30 MHz, the FCC will accept measurements done with a suitable dummy load, in lieu of the permanent antenna under the following conditions: (1) perform the AC line conducted tests with the permanent antenna to determine compliance with the Section 15.207 limits outside the transmitter's fundamental emission band; (2) retest with a dummy load in lieu of the permanent antenna to determine compliance with the Section 15.207 limits within the transmitter's fundamental emission band.

6.2 Test Instruments

Test Site and Equipment	Manufacturer	Model No./ Serial No.	Last Calibration Date	Calibration Due Date
Test Receiver	R&S	ESCS 30/ 836858/021	Jan. 11, 2012	Jan. 11, 2013
LISN	R&S	ESH2-Z5/ 836613/001	June 5, 2012	June 5, 2013
2 nd LISN	R&S	ENV4200/ 833209/010	Jan. 14, 2012	Jan. 14, 2013
50Ω terminator	N/A	N/A/ 001	Aug. 20, 2012	Aug. 20, 2013
RF Switch	N/A	RSU28/ 338965/002	Aug. 20, 2012	Feb. 20, 2013
RF Cable	N/A	N/A/ C0052 ~ 56	Aug. 20, 2012	Feb. 20, 2013
Test Software	Audix	e3/ Ver. 5.2004-2-19k	NCR	NCR
TR5 shielded room	ETS LINDGREN	TR5/ 15353-F	NCR	NCR

Note:

1. The calibrations are traceable to NML/ROC.
2. NCR : No Calibration Required.

Instrument Setting

IF BW	Measurement Time	Detector	Trace	Comment
9kHz	1 second	Quasi-Peak / Average	Maxhold	

Climatic Condition

Ambient Temperature : 27°C; Relative Humidity : 65%

6.3 Test Procedures

- a. The EUT was set up per the test configuration figured in the next section of this chapter to simulate the typical usage per the user's manual.
- b. If the EUT is tabletop equipment, it was placed on a non-conducted table with a height of 0.8 meters above the reference ground plane and 0.4 meters from the conducting wall of the shielded room. Also if the EUT is floor-standing equipment, it was placed on a non-conducted support with a height of 12 millimeters above the reference ground plane.
- c. Connect the EUT's power source to the appropriate power mains through the LISN.
- d. All the other peripherals are connected to the 2nd LISN, if any.
- e. The LISN was placed 0.8 meters from the EUT and at least 0.8 meters from other units and other metal planes.
- f. Measure the conducted emissions on each power line (Neutral Line and Line 1 – Hot side) of the EUT's power source by using the test receiver connected to the coupling RF output port of LISN.
- g. Rapidly scan the signal from 150kHz to 30MHz by using the receiver through the Maximum-Peak detector to determine those frequencies associated with higher emission levels for each measured line.
- h. Then measure the maximum level of conducted disturbance for each frequency found from step g. by using the receiver through the Quasi-Peak and Average detectors per CISPR 16-1.
- i. Record the level for each frequency and compare with the required limit.

6.4 Test Configurations

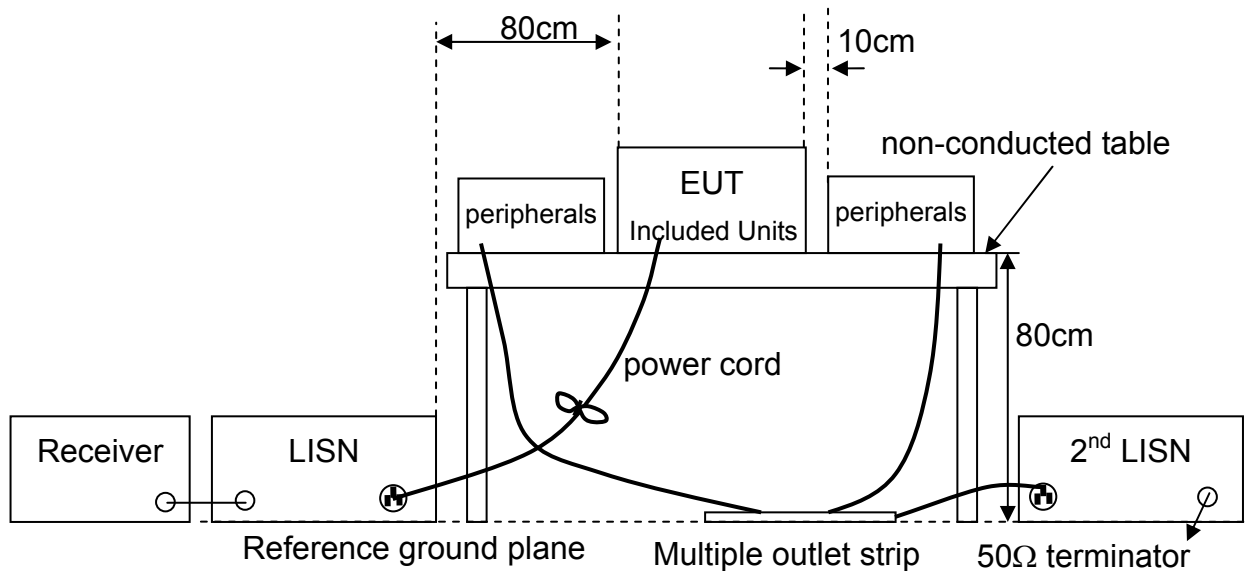

6.5 Test Results

Test Mode : Mode 3, Continuous Transmitting, with antenna
Tester : Kent Frequency Range : 150kHz~30MHz
Phase : Line

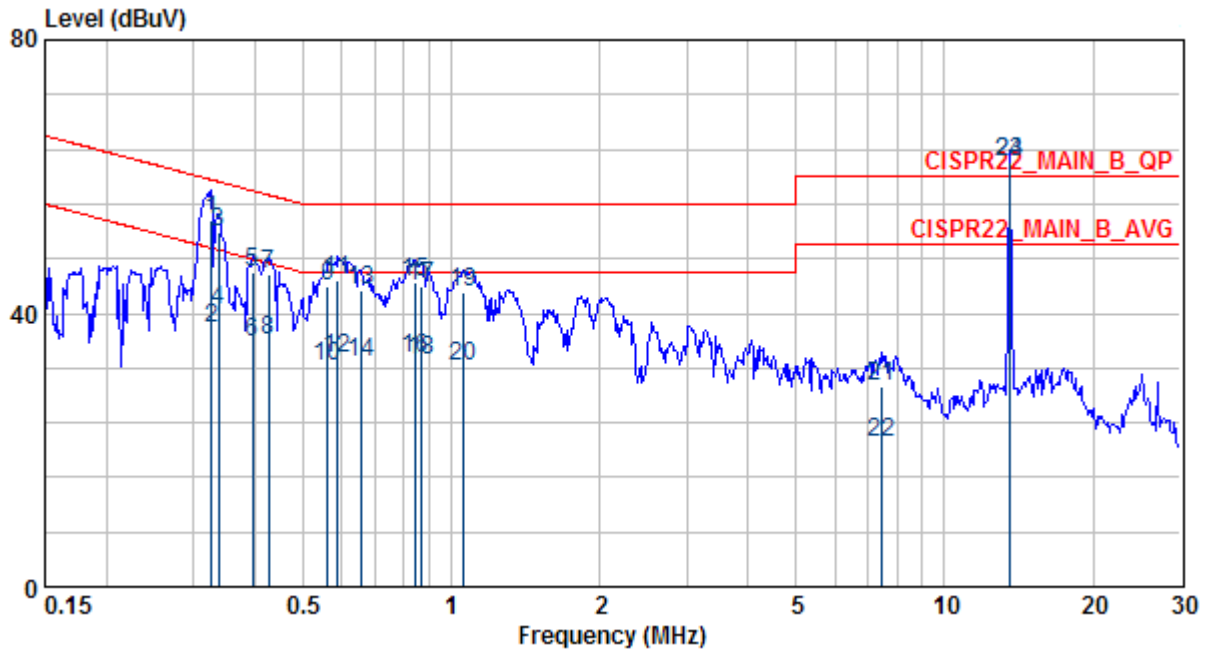

	Freq	Level	Factor	Read Level	Limit Line	Over Limit	Pol/Phase	Remark
	MHz	dBuV	dB	dBuV	dBuV	dB		
1	0.327	53.76	0.30	53.46	59.53	-5.77	LINE	QP
2	0.327	37.84	0.30	37.54	49.53	-11.69	LINE	AVERAGE
3	0.337	51.81	0.30	51.51	59.27	-7.46	LINE	QP
4	0.337	40.51	0.30	40.21	49.27	-8.76	LINE	AVERAGE
5	0.396	46.14	0.31	45.83	57.95	-11.81	LINE	QP
6	0.396	35.69	0.31	35.38	47.95	-12.26	LINE	AVERAGE
7	0.426	45.83	0.31	45.52	57.33	-11.50	LINE	QP
8	0.426	36.15	0.31	35.84	47.33	-11.18	LINE	AVERAGE
9	0.561	44.06	0.31	43.75	56.00	-11.94	LINE	QP
10	0.561	32.33	0.31	32.02	46.00	-13.67	LINE	AVERAGE
11	0.589	44.85	0.32	44.53	56.00	-11.15	LINE	QP
12	0.589	33.42	0.32	33.10	46.00	-12.58	LINE	AVERAGE
13	0.654	43.43	0.32	43.11	56.00	-12.57	LINE	QP
14	0.654	32.80	0.32	32.48	46.00	-13.20	LINE	AVERAGE
15	0.844	44.57	0.33	44.24	56.00	-11.43	LINE	QP
16	0.844	33.46	0.33	33.13	46.00	-12.54	LINE	AVERAGE
17	0.871	44.05	0.33	43.72	56.00	-11.95	LINE	QP
18	0.871	33.12	0.33	32.79	46.00	-12.88	LINE	AVERAGE
19	1.054	43.00	0.34	42.66	56.00	-13.00	LINE	QP
20	1.054	32.20	0.34	31.86	46.00	-13.80	LINE	AVERAGE
21	7.486	29.38	0.57	28.81	60.00	-30.62	LINE	QP
22	7.486	21.00	0.57	20.43	50.00	-29.00	LINE	AVERAGE
23 X	13.562	62.26	0.68	61.58	60.00	2.26	LINE	QP
24 X	13.562	62.09	0.68	61.41	50.00	12.09	LINE	AVERAGE

Note:

1. Emission Level = reading value + correction factor.
2. Correction factor = cable loss + insertion loss of LISN.
3. Q.P. is abbreviation of quasi-peak.
4. Tx Fundamental(markered 23, 24), for reference only. Please refer to next page.

Test Mode : Mode 3, Continuous Transmitting, with dummy load
Tester : Kent Frequency Range : 150kHz~30MHz
Phase : Line

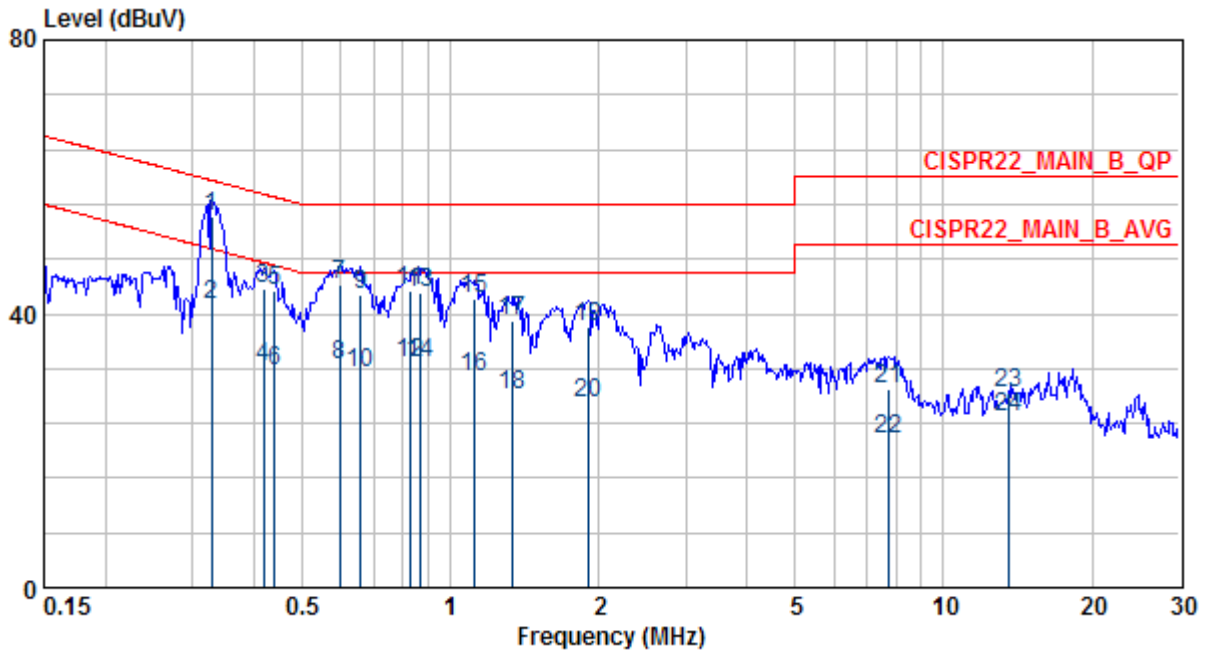

	Freq	Level	Factor	Read Level	Limit Line	Over Limit	Pol/Phase	Remark
	MHz	dBuV	dB	dBuV	dBuV	dB		
1 @	0.328	54.34	0.30	54.04	59.49	-5.16	LINE	QP
2 @	0.328	41.33	0.30	41.03	49.49	-8.17	LINE	AVERAGE
3	0.419	43.56	0.31	43.25	57.46	-13.90	LINE	QP
4	0.419	32.16	0.31	31.85	47.46	-15.30	LINE	AVERAGE
5	0.440	43.45	0.31	43.14	57.07	-13.62	LINE	QP
6	0.440	31.75	0.31	31.44	47.07	-15.32	LINE	AVERAGE
7 @	0.598	44.39	0.32	44.07	56.00	-11.61	LINE	QP
8	0.598	32.65	0.32	32.33	46.00	-13.35	LINE	AVERAGE
9	0.658	42.64	0.32	42.32	56.00	-13.36	LINE	QP
10	0.658	31.32	0.32	31.00	46.00	-14.68	LINE	AVERAGE
11	0.830	43.45	0.33	43.12	56.00	-12.55	LINE	QP
12	0.830	32.85	0.33	32.52	46.00	-13.15	LINE	AVERAGE
13	0.871	43.17	0.33	42.84	56.00	-12.83	LINE	QP
14	0.871	32.85	0.33	32.52	46.00	-13.15	LINE	AVERAGE
15	1.117	42.09	0.35	41.74	56.00	-13.91	LINE	QP
16	1.117	30.70	0.35	30.35	46.00	-15.30	LINE	AVERAGE
17	1.338	38.87	0.36	38.51	56.00	-17.13	LINE	QP
18	1.338	28.10	0.36	27.74	46.00	-17.90	LINE	AVERAGE
19	1.898	38.05	0.39	37.66	56.00	-17.95	LINE	QP
20	1.898	26.88	0.39	26.49	46.00	-19.12	LINE	AVERAGE
21	7.728	29.15	0.58	28.57	60.00	-30.85	LINE	QP
22	7.728	21.66	0.58	21.08	50.00	-28.34	LINE	AVERAGE
23	13.560	28.32	0.68	27.64	60.00	-31.68	LINE	QP
24	13.560	24.86	0.68	24.18	50.00	-25.14	LINE	AVERAGE

Note:

1. Emission Level = reading value + correction factor.
2. Correction factor = cable loss + insertion loss of LISN.
3. Q.P. is abbreviation of quasi-peak.

Test Mode : Mode 3, Continuous Transmitting, with antenna
 Tester : Kent Frequency Range : 150kHz~30MHz
 Phase : Neutral

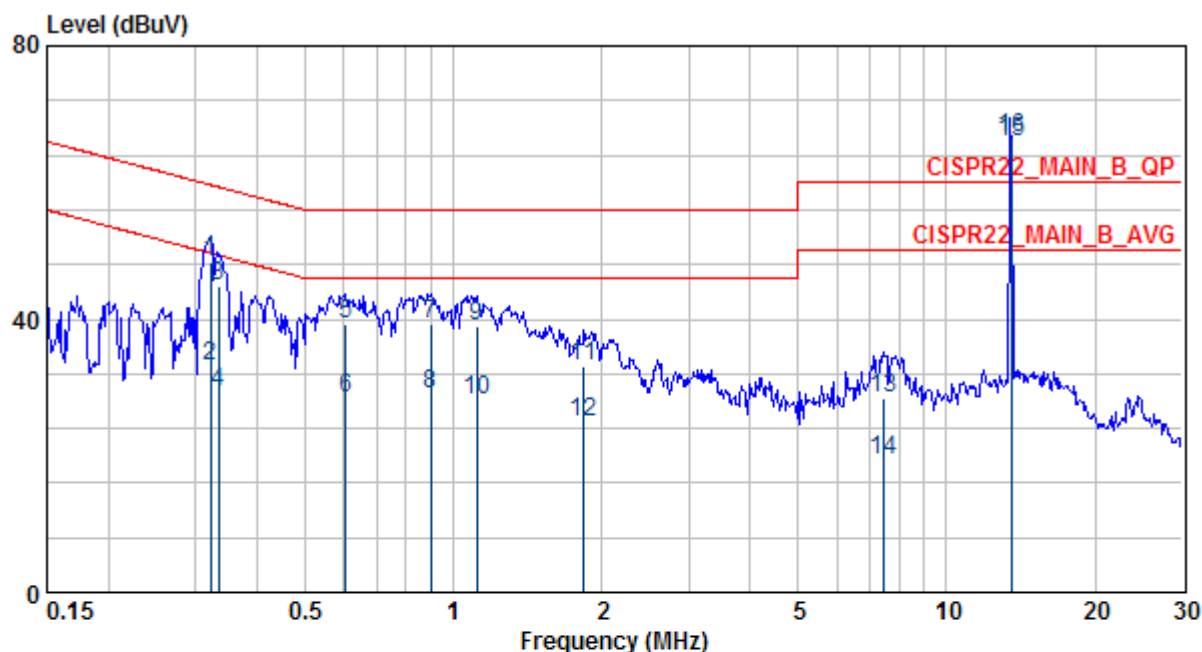

	Freq	Level	Factor	Read Level	Limit Line	Over Limit	Pol/Phase	Remark
	MHz	dBuV	dB	dBuV	dBuV	dB		
1	0.322	48.32	0.18	48.14	59.66	-11.34	NEUTRAL	QP
2	0.322	33.14	0.18	32.96	49.66	-16.52	NEUTRAL	AVERAGE
3	0.334	44.83	0.18	44.65	59.35	-14.52	NEUTRAL	QP
4	0.334	29.38	0.18	29.20	49.35	-19.97	NEUTRAL	AVERAGE
5	0.604	39.21	0.20	39.01	56.00	-16.79	NEUTRAL	QP
6	0.604	28.38	0.20	28.18	46.00	-17.62	NEUTRAL	AVERAGE
7	0.899	39.20	0.22	38.98	56.00	-16.80	NEUTRAL	QP
8	0.899	29.15	0.22	28.93	46.00	-16.85	NEUTRAL	AVERAGE
9	1.117	38.83	0.24	38.59	56.00	-17.17	NEUTRAL	QP
10	1.117	28.16	0.24	27.92	46.00	-17.84	NEUTRAL	AVERAGE
11	1.839	33.08	0.28	32.80	56.00	-22.92	NEUTRAL	QP
12	1.839	24.81	0.28	24.53	46.00	-21.19	NEUTRAL	AVERAGE
13	7.446	28.31	0.54	27.77	60.00	-31.69	NEUTRAL	QP
14	7.446	19.31	0.54	18.77	50.00	-30.69	NEUTRAL	AVERAGE
15 X	13.561	65.89	0.86	65.03	60.00	5.89	NEUTRAL	QP
16 X	13.561	66.58	0.86	65.72	50.00	16.58	NEUTRAL	AVERAGE

Note:

1. Emission Level = reading value + correction factor.
2. Correction factor = cable loss + insertion loss of LISN.
3. Q.P. is abbreviation of quasi-peak.
4. Tx Fundamental(markered 15, 16), for reference only. Please refer to next page.

Test Mode : Mode 3, Continuous Transmitting, with dummy load
 Tester : Kent Frequency Range : 150kHz~30MHz
 Phase : Neutral

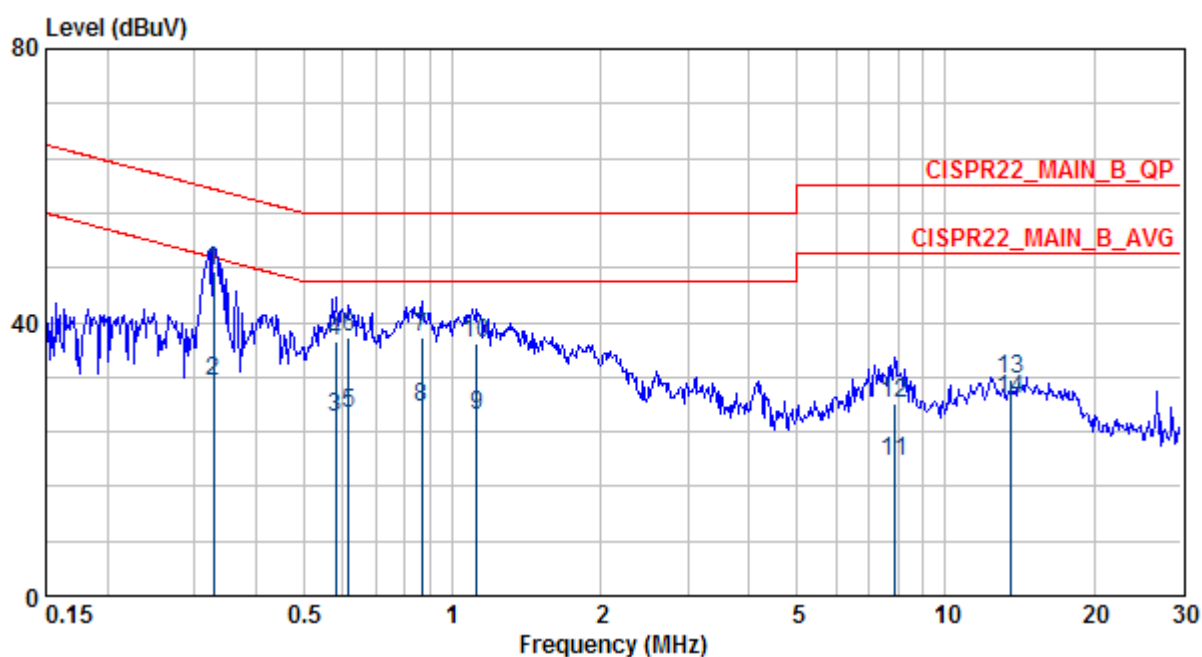

	Freq	Level	Factor	Read Level	Limit Line	Over Limit	Pol/Phase	Remark
	MHz	dBuV	dB	dBuV	dBuV	dB		
1	0.328	47.35	0.18	47.17	59.51	-12.16	NEUTRAL	QP
2	0.328	31.27	0.18	31.09	49.51	-18.24	NEUTRAL	AVERAGE
3	0.579	26.02	0.20	25.82	46.00	-19.98	NEUTRAL	AVERAGE
4	0.579	37.28	0.20	37.08	56.00	-18.72	NEUTRAL	QP
5	0.617	26.76	0.20	26.56	46.00	-19.24	NEUTRAL	AVERAGE
6	0.617	37.88	0.20	37.68	56.00	-18.12	NEUTRAL	QP
7	0.866	37.95	0.22	37.73	56.00	-18.05	NEUTRAL	QP
8	0.866	27.52	0.22	27.30	46.00	-18.48	NEUTRAL	AVERAGE
9	1.123	26.34	0.24	26.10	46.00	-19.66	NEUTRAL	AVERAGE
10	1.123	37.06	0.24	36.82	56.00	-18.94	NEUTRAL	QP
11	7.852	19.54	0.55	18.99	50.00	-30.46	NEUTRAL	AVERAGE
12	7.852	28.03	0.55	27.48	60.00	-31.97	NEUTRAL	QP
13	13.560	31.66	0.86	30.80	60.00	-28.34	NEUTRAL	QP
14	13.560	28.84	0.86	27.98	50.00	-21.16	NEUTRAL	AVERAGE

Note:

1. Emission Level = reading value + correction factor.
2. Correction factor = cable loss + insertion loss of LISN.
3. Q.P. is abbreviation of quasi-peak.

7. Antenna Requirement

7.1 Applied Standard

An intentional radiator shall be designed to ensure that no antenna other than that furnished by the responsible party shall be used with the device. The use of a permanently attached antenna or of an antenna that uses a unique coupling to the intentional radiator shall be considered sufficient to comply with the provisions of this Section. The manufacturer may design the unit so that a broken antenna can be replaced by the user, but the use of a standard antenna jack or electrical connector is prohibited. This requirement does not apply to carrier current devices or to devices operated under the provisions of Sections 15.211, 15.213, 15.217, 15.219, or 15.221. Further, this requirement does not apply to intentional radiators that must be professionally installed, such as perimeter protection systems and some field disturbance sensors, or to other intentional radiators which, in accordance with Section 15.31(d), must be measured at the installation site. However, the installer shall be responsible for ensuring that the proper antenna is employed so that the limits in this Part are not exceeded.

7.2 Antenna Type

The EUT use a permanently attached antenna

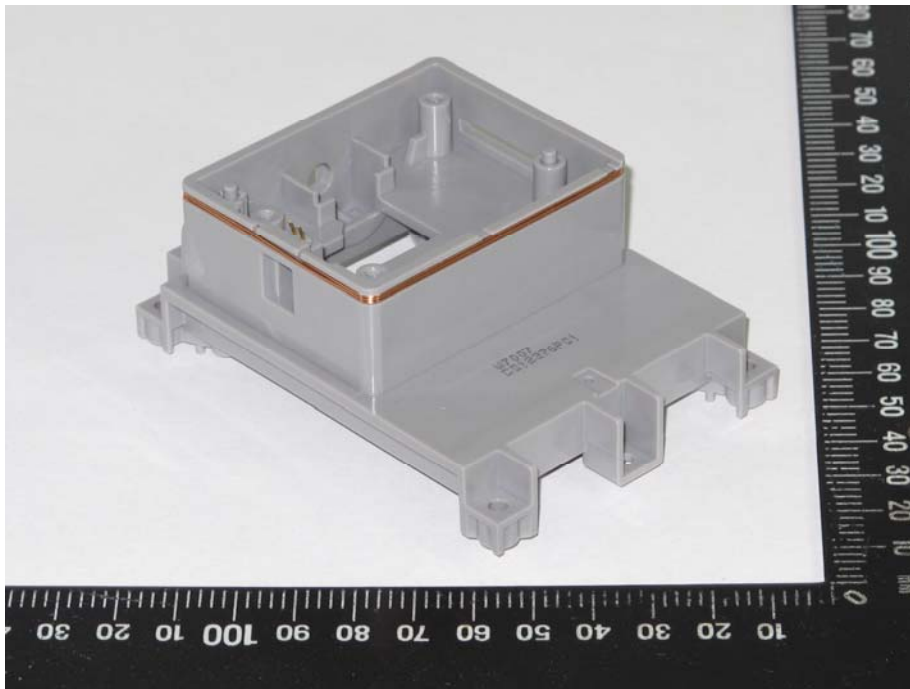

7.3 Applicable Result

Comply the requirement.