

FCC Test Report

for

POS Terminal

Trade Name : VeriFone
Model Number : PP1000se v3
FCC ID : B32PP1000SECTLS
Report Number : RF-V040-1404-158
Date of Receipt : April 14, 2014
Date of Report : May 6, 2014

Prepared for

VeriFone Inc.

1400 West Stanford Ranch Road, Suite 200, Rocklin, CA, 95765, UNITED STATES

Prepared by

Central Research Technology Co.



EMC Test Laboratory

11, Lane 41, Fushuen St., Jungshan Chiu, Taipei, Taiwan, 104, R.O.C.



NVLAP LAB CODE 200575-0

This report shall not be reproduced, except in full, without the written approval of Central Research Technology Co.. It may be duplicated completely in its entirety for legal use with the permission of the applicant. It should not be used to claim product endorsement by NVLAP, NIST or any U.S. government agency. The test result in the report applies only to the sample tested.

Certification

Equipment Under Test : POS Terminal
Model No. : PP1000se v3
FCC ID : B32PP1000SECTLS
Applicant : VeriFone Inc.
Address : 1400 West Stanford Ranch Road, Suite 200, Rocklin, CA,
95765, UNITED STATES
Applicable Standards : **FCC Part 15, Subpart C**
Date of Testing : April 15 ~ 28, 2014
Deviation : N/A
Condition of Test Sample : Mass Production

We, **Central Research Technology Co.**, hereby certify that one sample of the designated product was tested in our facility during the period mentioned above. The test records, data evaluation and Equipment Under Test (EUT) configurations shown in the present report are true and accurate representation of the measurements of the sample's RF characteristics under the conditions herein specified.

The test results show that the EUT as described in the present report is in compliance with the requirements set forth in the standards mentioned above and apply to the tested sample identified in the present report only. The test report shall not be reproduced, except in its entirety, without the written approval of Central Research Technology Co.

PREPARED BY : Cathy Chen , **DATE** : May 6, 2014
(Cathy Chen/ Technical Manager)
APPROVED BY : J. Y. Shih , **DATE** : May 6, 2014
(Tsun-Yu Shih/General Manager)

Contents

1.	General Description	5
1.1	GENERAL DESCRIPTION OF EUT	5
1.2	TEST METHODOLOGY	5
1.3	TEST MODE	6
1.4	APPLIED STANDARDS	7
1.5	THE SUPPORT UNITS	10
1.6	LAYOUT OF SETUP	11
1.7	TEST CAPABILITY	13
1.8	MEASUREMENT UNCERTAINTY	15
2.	Conducted Emission Measurement	16
2.1	LIMITS FOR EMISSION MEASUREMENT	16
2.2	TEST INSTRUMENTS	17
2.3	TEST PROCEDURES	18
2.4	TEST CONFIGURATIONS	19
2.5	TEST DATA.....	20
3.	Field Strength of fundamental Measurement.....	24
3.1	APPLIED STANDARD	24
3.2	TEST INSTRUMENTS	25
3.3	MEASUREMENT PROCEDURE	26
3.4	TEST CONFIGURATION	27
3.5	TEST RESULTS	28
4.	Radiated Emission	32
4.1	APPLIED STANDARD	32
4.2	TEST INSTRUMENTS	33
4.3	MEASUREMENT PROCEDURE	35
4.4	TEST CONFIGURATION	36
4.5	TEST RESULTS	37
5.	Frequency Tolarence	39
5.1	APPLIED STANDARD	39
5.2	TEST INSTRUMENTS	40
5.3	MEASUREMENT PROCEDURE	41
5.4	TEST CONFIGURATION	41
5.5	TEST RESULTS	42

6.	20dB Bandwidth	46
6.1	APPLIED STANDARD	46
6.2	TEST INSTRUMENTS	46
6.3	MEASUREMENT PROCEDURE	47
6.4	TEST CONFIGURATION	47
6.5	TEST RESULTS	48
7.	Antenna Requirement	49
7.1	APPLIED STANDARD	49
7.2	ANTENNA TYPE	49
7.3	APPLICABLE RESULT	49

Attachment 1 – Photographs of the Test Configurations

Attachment 2 – External Photographs of EUT

Attachment 3 – Internal Photographs of EUT

1. General Description

1.1 General Description of EUT

Equipment Under Test	:	POS Terminal
Model No.	:	PP1000se v3
Power in	:	5Vdc~12Vdc
PSU Specification	:	Trade Name: VeriFone Model No.: CAP009092U P/N: PWR282-001-01-A Input : 100-240V~, 50/60Hz, 500mA Output : 9Vdc, 1A
Test Voltage	:	120Vac/60Hz to the power adaptor
Frequency Range	:	13.56MHz
Channel Numbers	:	1
Function Modulation	:	ASK
Function Description	:	

The EUT is used to transmit and receive signal both. Please refer to the user's manual for the details.

1.2 Test Methodology

For this E.U.T., the radiated emissions and conducted emission measurement performed according to the procedures illustrated in ANSI C63.4:2009 and other required are illustrated in separate sections of this test report for detail.

1.3 Test Mode

Pre-scan Mode

Test Mode	Test Voltage
Mode 1	Power Adaptor:CAP009092U
Mode 2	5Vdc by USB
Mode 3	12Vdc by DC power source

According to the preliminary test, It was found that the Mode 1 is the worst. It was taken as the representative condition for test and its data are recorded in the present document.

1.4 Applied standards

(1) Field strength of Fundametal

According to 15.225(a), the field strength of any emissions within the band 13.553 - 13.567 MHz shall not exceed 15,848 microvolts/meter at 30 meters.

(2) Band Edge

According to 15.225(b), Within the bands 13.410-13.553 MHz and 13.567-13.710 MHz, the field strength of any emissions shall not exceed 334 microvolts/meter at 30 meters. According to 15.225(c), Within the bands 13.110-13.410 MHz and 13.710-14.010 MHz the field strength of any emissions shall not exceed 106 microvolts/meter at 30 meters.

(3) Radiation emission

According to 15.225(d), the field strength of any emissions appearing outside of the 13.110-14.010 MHz band shall not exceed the general radiated emission limits in § 15.209.

(4) Frequency tolerance

The frequency tolerance of the carrier signal shall be maintained within +/- 0.01% of the operating frequency over a temperature variation of -20 degrees to +50 degrees C at normal supply voltage, and for a variation in the primary supply voltage from 85% to 115% of the rated supply voltage at a temperature of 20 degrees C. For battery operated equipment, the equipment tests shall be performed using a new battery.

(5) Radiated emission limits, general requirements.

According to 15.209, except as provided elsewhere in this Subpart, the emissions from an intentional radiator shall not exceed the field strength levels specified in the following table:

Frequency (MHz)	Field Strength (uV/m)	Measurement Distance (m)
0.009 - 0.490	2400/F(kHz)	300
0.490 - 1.705	24000/F(kHz)	30
1.705 - 30.0	30	30
30 - 88	100 **	3
88 - 216	150 **	3
216 - 960	200 **	3
Above 960	500	3

** Except as provided in paragraph (g), fundamental emissions from intentional radiators operating under this Section shall not be located in the frequency bands 54-72 MHz, 76-88 MHz, 174-216 MHz or 470-806 MHz. However, operation within these frequency bands is permitted under other sections of this Part, e.g., Sections 15.231 and 15.241.

(6) 20dB Bandwidth

According to 15.215(c) requires the device must be designed to ensure that the 20 dB bandwidth of the emission, or whatever bandwidth may otherwise be specified in the specific rule section under which the equipment operates.

(7) Conduction Emission Requirement

For intentional device, according to §15.207(a) line conduction emission limit is as below table.

Frequency of Emission (MHz)	Conducted Limit (dBuV)	
	Quasi-peak	Average
0.15 – 0.5	66 to 56*	56 to 46*
0.5 - 5	56	46
5 - 30	60	50

* Decreases with the logarithm of the frequency.

(8) Restricted Band

Frequency (MHz)	Frequency (MHz)	Frequency (MHz)	Frequency (GHz)
0.090 - 0.110	16.42 - 16.423	399.9 - 410	4.5 - 5.15
¹ 0.495 - 0.505	16.69475 - 16.69525	608 - 614	5.35 - 5.46
² 1735 - 2.1905	16.80425 - 16.80475	960 - 1240	7.25 - 7.75
4.125 - 4.128	25.5 - 25.67	1300 - 1427	8.025 - 8.5
4.17725 - 4.17775	37.5 - 38.25	1435 - 1626.5	9.0 - 9.2
4.20725 - 4.20775	73 - 74.6	1645.5 - 1646.5	9.3 - 9.5
6.215 - 6.218	74.8 - 75.2	1660 - 1710	10.6 - 12.7
6.26775 - 6.26825	108 - 121.94	1718.8 - 1722.2	13.25 - 13.4
6.31175 - 6.31225	123 - 138	2200 - 2300	14.47 - 14.5
8.291 - 8.294	149.9 - 150.05	2310 - 2390	15.35 - 16.2
8.362 - 8.366	156.52475 - 156.52525	2483.5 - 2500	17.7 - 21.4
8.37625 - 8.38675	156.7 - 156.9	2690 - 2900	22.01 - 23.12
8.41425 - 8.41475	162.0125 - 167.17	3260 - 3267	23.6 - 24.0
12.29 - 12.293	167.72 - 173.2	3332 - 3339	31.2 - 31.8
12.51975 - 12.52025	240 - 285	3345.8 - 3358	36.43 - 36.5
12.57675 - 12.57725	322 - 335.4	3600 - 4400	(2)
13.36 - 13.41			

¹ Until February 1, 1999, this restricted band shall be 0.490-0.510 MHz.

² Above 38.6

(9) Antenna Requirement

An intentional radiator shall be designed to ensure that no antenna other than that furnished by the responsible party shall be used with the device. The use of a permanently attached antenna or of an antenna that uses a unique coupling to the intentional radiator shall be considered sufficient to comply with the provisions of this Section. The manufacturer may design the unit so that a broken antenna can be replaced by the user, but the use of a standard antenna jack or electrical connector is prohibited. This requirement does not apply to carrier current devices or to devices operated under the provisions of Sections 15.211, 15.213, 15.217, 15.219, or 15.221. Further, this requirement does not apply to intentional radiators that must be professionally installed, such as perimeter protection systems and some field disturbance sensors, or to other intentional radiators which, in accordance with Section 15.31(d), must be measured at the installation site. However, the installer shall be responsible for ensuring that the proper antenna is employed so that the limits in this Part are not exceeded.

1.5 The Support Units

Conducted Emission Test

No.	Unit	Model No.	FCC ID	Trade Name	Power Cord	Supported by lab.
1.	PC	Elite 8200 MT	N/A	HP	N/A	✓
2.	PS2 Keyboard	SK-8110	DoC	DELL	N/A	✓
3.	PS2 Mouse	MO71KC	DoC	DELL	N/A	✓
4.	LCD MONITOR	f1723	DoC	HP	N/A	✓
5.	RFID card	N/A	N/A	N/A	N/A	
6.	SAM Card	N/A	N/A	N/A	N/A	

Radiated Emission Test

No.	Unit	Model No.	FCC ID	Trade Name	Power Cord	Supported by lab.
1.	Notebook	LATITUDE D400	N/A	DELL	N/A	✓
2.	USB Mouse	N12ROU	DoC	ACER	N/A	✓
3.	RFID card	N/A	N/A	N/A	N/A	
4.	SAM Card	N/A	N/A	N/A	N/A	

1.6 Layout of Setup

Conducted Emission Test

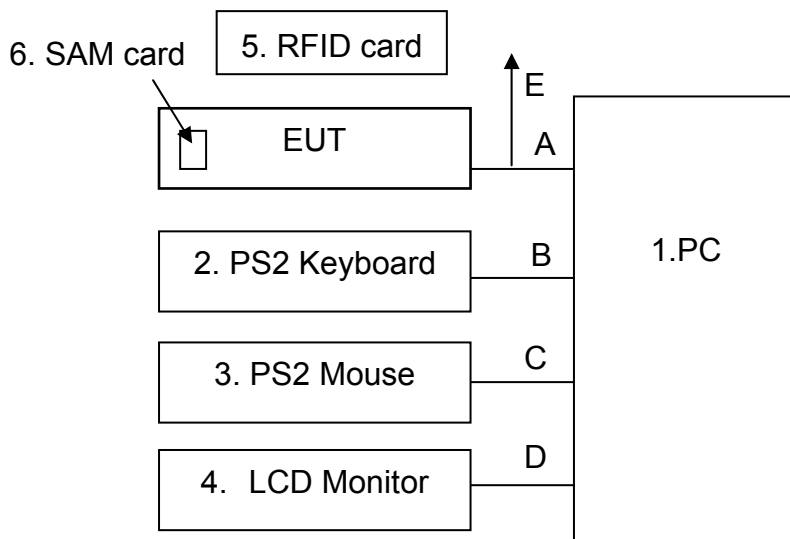

Connecting Cables :

No.	Cable	Length	Shielded	Core	Shielded Backshell	Supported by lab.
A	RJ45 to RS232 Cable	1.7m				
B	PS2 Keyboard Cable	1.8m	✓			✓
C	PS2 Mouse Cable	1.8m	✓			✓
D	VGA Cable	1.7m	✓			✓
E	DC Power Line	1.8m				

Radiated Emission Test

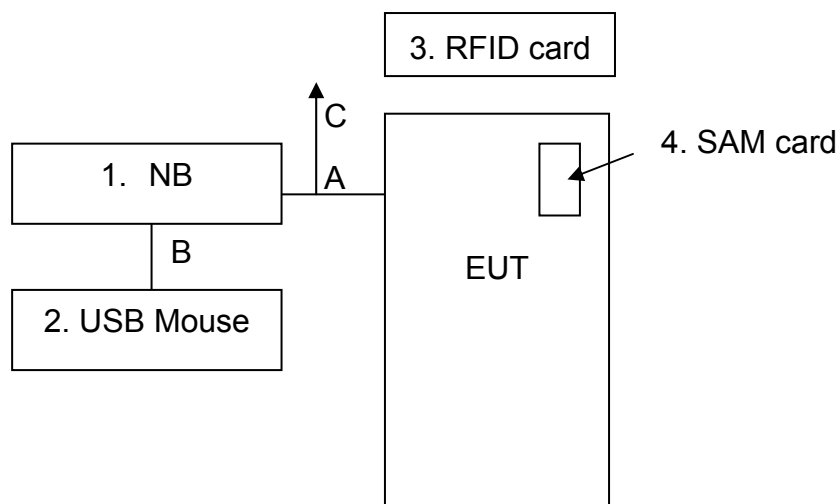

Connecting Cables :

No.	Cable	Length	Shielded	Core	Shielded Backshell	Supported by lab.
A	RJ45 to RS232 Cable	1.7m				
B	USB Mouse Cable	1.8m	✓			✓
C	DC Power Line	1.8m				

Justification:

For both conducted and radiated emission below 1GHz, the system was configured for typical fashion as a customer could use it normally.

For radiated emission, measurement of radiated emission from digital circuit is performed with normal transmitting.

1.7 Test Capability

Test Facility

The test facility used for evaluating the conformance of the EUT with each standard in the present report meets what required in CISPR16-1-4, CISPR16-2-3 and ANSI C63.4:2009.

Test Room	Type of Test Room	Descriptions
TR1	10m semi-anechoic chamber (23m×14m×9m)	Complying with the NSA requirements set in documents CISPR 22 and ANSI C63.4:2009. For the radiated emission measurement.
TR11	3m semi-anechoic chamber (9m × 6m × 6m)	
TR13	Test site	For the RF conducted emission measurement.
TR5	Shielding Room (8m×5m×4m)	For the conducted emission measurement.

Test Laboratory Competence Information

Central Research Technology Co. has been accredited / filed / authorized by the agencies listed in the following table.

Certificate	Nation	Agency	Code	Mark
Accreditation Certificate	USA	NVLAP	200575-0	ISO/IEC 17025
	R.O.C. (Taiwan)	TAF	0905	ISO/IEC 17025
	R.O.C. (Taiwan)	BSMI	SL2-IN-E-0033, SL2-IS-E-0033, SL2-R1/R2-E-0033, SL2-A1-E-0033 SL2-L1-E-0033	ISO/IEC 17025
Site Filing Document	USA	FCC	474046,TW1053	Test facility list & NSA Data
	Canada	IC	4699A-1,-3	Test facility list & NSA Data
	Japan	VCCI	R-1527,C-1609, C-4400, T-1441, T-1334, G-10, G-614	Test facility list & NSA Data
Authorization Certificate	Germany	TUV	10021687	ISO/IEC 17025
	Norway	Nemko	ELA 212	ISO/IEC 17025

The copy of each certificate can be downloaded from our web site: www.crc-lab.com

1.8 Measurement Uncertainty

The assessed measurement uncertainty with a suitable coverage factor K to ensure 95% confidence level for the normal distribution are shown as below, the values are less than U_{Cispr} in table 1 of CISPR 16-4-2.

Test Item	Measurement Uncertainty	
Radiated Emission: (30MHz~200MHz)	Horizontal: 3.3dB ; Vertical: 4.1dB	
Radiated Emission: (200MHz~1GHz)	Horizontal: 3.8dB ; Vertical: 5.1dB	
Conducted Emission	ESH2-Z5	3.0dB
	ENV 4200	3.0dB

2. Conducted Emission Measurement

Test Data: Pass

2.1 Limits for Emission Measurement

For intentional device, according to §15.207(a) line conduction emission limit is as below table.

Frequency of Emission (MHz)	Conducted Limit (dBuV)	
	Quasi-peak	Average
0.15 – 0.5	66 to 56*	56 to 46*
0.5 - 5	56	46
5 - 30	60	50

* Decreases with the logarithm of the frequency.

Note:

For a device with a permanent antenna operating at or below 30 MHz, the FCC will accept measurements done with a suitable dummy load, in lieu of the permanent antenna under the following conditions: (1) perform the AC line conducted tests with the permanent antenna to determine compliance with the Section 15.207 limits outside the transmitter's fundamental emission band; (2) retest with a dummy load in lieu of the permanent antenna to determine compliance with the Section 15.207 limits within the transmitter's fundamental emission band.

2.2 Test Instruments

Test Site and Equipment	Manufacturer	Model No./ Serial No.	Last Calibration Date	Calibration Due Date
Test Receiver	R&S	ESCS 30/ 836858/021	Jan. 15, 2014	Jan. 15, 2015
LISN	R&S	ESH2-Z5/ 880669/039	March 20, 2014	March 20, 2015
2 nd LISN	R&S	ENV4200/ 833209/010	April 2, 2014	April 2, 2015
50Ω terminator	N/A	N/A/ 001	Aug. 19, 2013	Aug. 19, 2014
RF Switch	R&S	RSU28/ 338965/002	Aug. 19, 2013	Aug. 19, 2014
RF Cable	N/A	N/A/ C0052 ~ 56	Aug. 19, 2013	Aug. 19, 2014
Dummy Load	N/A	50Ω 1/4W Resistance	NCR	NCR
Test Software	Audix	e3/ Ver. 5.2004-2-19k	NCR	NCR
TR5 shielded room	ETS LINDGREN	TR5/ 15353-F	NCR	NCR

Note:

1. The calibrations are traceable to NML/ROC.
2. NCR : No Calibration Required.

Instrument Setting

IF BW	Measurement Time	Detector	Trace	Comment
9kHz	1 second	Quasi-Peak / Average	Maxhold	

Climatic Condition

Ambient Temperature : 24°C; Relative Humidity : 35%

2.3 Test Procedures

- a. The EUT was set up per the test configuration figured in the next section of this chapter to simulate the typical usage per the user's manual.
- b. If the EUT is tabletop equipment, it was placed on a non-conducted table with a height of 0.8 meters above the reference ground plane and 0.4 meters from the conducting wall of the shielded room. Also if the EUT is floor-standing equipment, it was placed on a non-conducted support with a height of 12 millimeters above the reference ground plane.
- c. Connect the EUT's power source to the appropriate power mains through the LISN.
- d. All the other peripherals are connected to the 2nd LISN, if any.
- e. The LISN was placed 0.8 meters from the EUT and at least 0.8 meters from other units and other metal planes.
- f. Measure the conducted emissions on each power line (Neutral Line and Line 1 – Hot side) of the EUT's power source by using the test receiver connected to the coupling RF output port of LISN.
- g. Rapidly scan the signal from 150kHz to 30MHz by using the receiver through the Maximum-Peak detector to determine those frequencies associated with higher emission levels for each measured line.
- h. Then measure the maximum level of conducted disturbance for each frequency found from step g. by using the receiver through the Quasi-Peak and Average detectors per CISPR 16-1.
- i. Record the level for each frequency and compare with the required limit.

2.4 Test Configurations

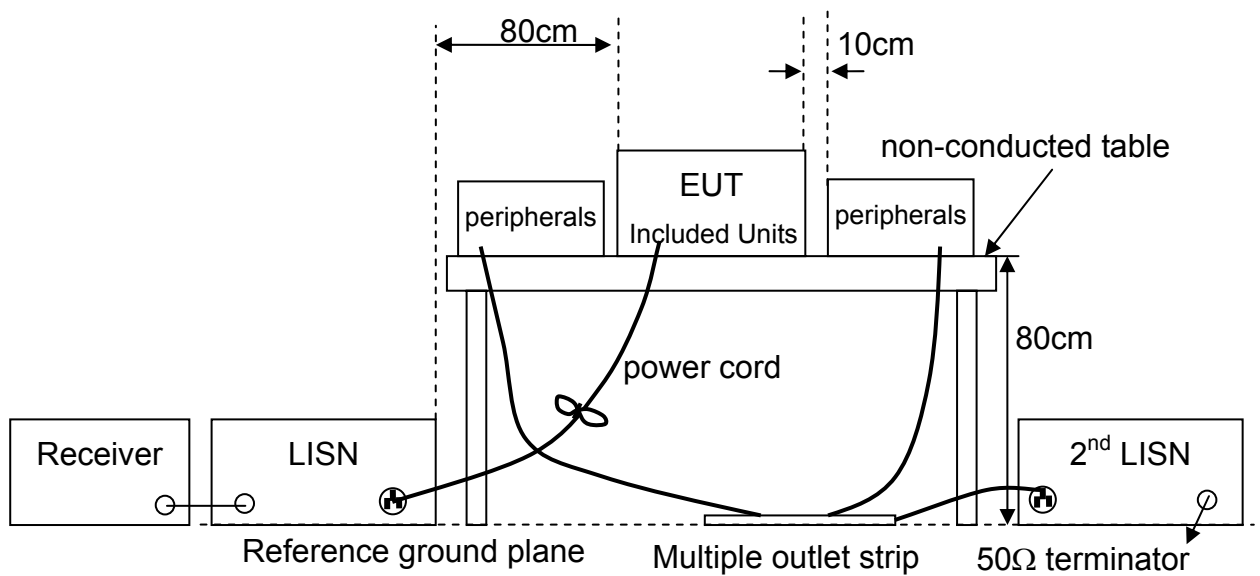

2.5 Test Data

Test Mode : Mode 1, Continuous Transmitting, with antenna
 Tester : Der-Jan Ken Frequency Range : 150kHz~30MHz
 Phase : Line

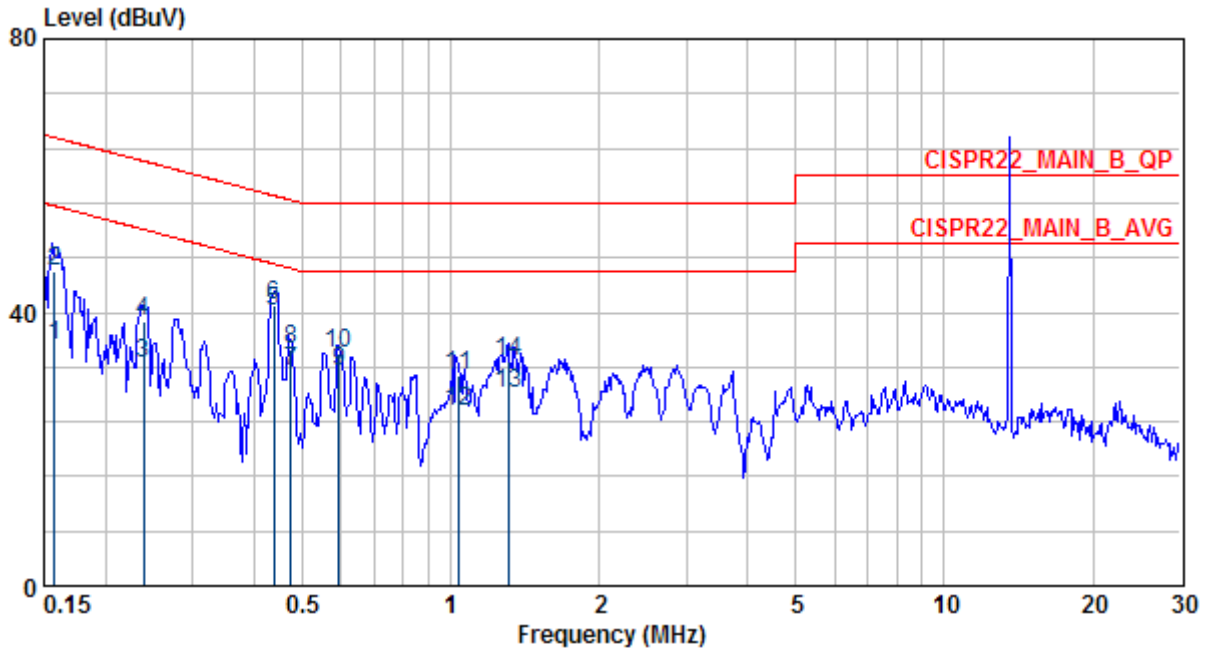

	Freq	Level	Factor	Read	Limit	Over	Pol/Phase	Remark
				Level	Line	Limit		
	MHz	dBuV	dB	dBuV	dBuV	dB		
1	0.158	35.17	0.28	34.89	55.59	-20.41	LINE	AVERAGE
2	0.158	45.92	0.28	45.64	65.59	-19.66	LINE	QP
3	0.239	32.57	0.29	32.28	52.13	-19.55	LINE	AVERAGE
4	0.239	38.63	0.29	38.34	62.13	-23.49	LINE	QP
5 @	0.439	40.12	0.31	39.81	47.08	-6.96	LINE	AVERAGE
6	0.439	40.97	0.31	40.66	57.08	-16.11	LINE	QP
7	0.475	31.38	0.31	31.07	46.42	-15.04	LINE	AVERAGE
8	0.475	34.45	0.31	34.14	56.42	-21.97	LINE	QP
9	0.595	31.28	0.32	30.96	46.00	-14.72	LINE	AVERAGE
10	0.595	33.92	0.32	33.60	56.00	-22.08	LINE	QP
11	1.036	30.75	0.36	30.39	56.00	-25.25	LINE	QP
12	1.036	25.62	0.36	25.26	46.00	-20.38	LINE	AVERAGE
13	1.310	28.07	0.38	27.69	46.00	-17.93	LINE	AVERAGE
14	1.310	32.95	0.38	32.57	56.00	-23.05	LINE	QP

Note:

1. Emission Level = reading value + correction factor.
2. Correction factor = cable loss + insertion loss of LISN.
3. Q.P. is abbreviation of quasi-peak.
4. Tx Fundamental for reference only. Please refer to next page.

Test Mode : Mode 1, Continuous Transmitting, with dummy load
 Tester : Der-Jan Ken Frequency Range : 150kHz~30MHz
 Phase : Line

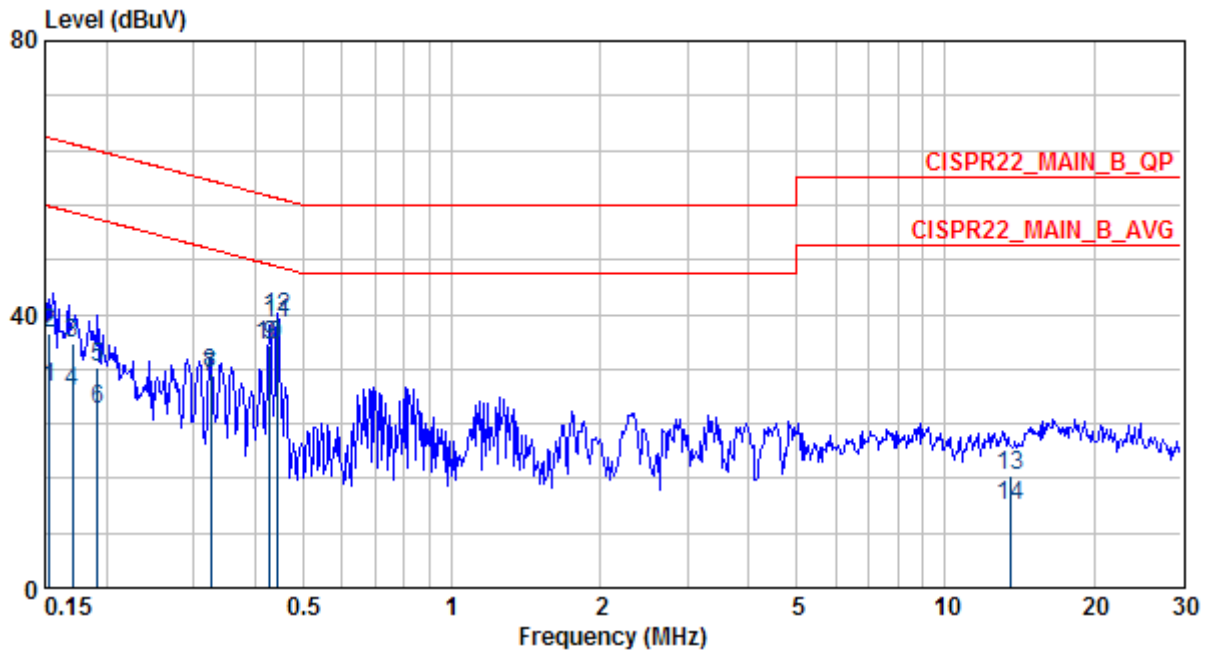

	Freq	Level	Factor	Read Level	Limit Line	Over Limit	Pol/Phase	Remark
	MHz	dBuV	dB	dBuV	dBuV	dB		
1	0.153	29.16	0.28	28.88	55.84	-26.67	LINE	AVERAGE
2	0.153	37.23	0.28	36.95	65.84	-28.60	LINE	QP
3	0.171	35.71	0.28	35.43	64.93	-29.21	LINE	QP
4	0.171	28.72	0.28	28.44	54.93	-26.20	LINE	AVERAGE
5	0.191	32.18	0.29	31.89	63.98	-31.80	LINE	QP
6	0.191	26.01	0.29	25.72	53.98	-27.97	LINE	AVERAGE
7	0.325	30.65	0.30	30.35	49.57	-18.92	LINE	AVERAGE
8	0.325	31.37	0.30	31.07	59.57	-28.20	LINE	QP
9	0.428	35.57	0.31	35.26	57.29	-21.72	LINE	QP
10	0.428	35.50	0.31	35.19	47.29	-11.79	LINE	AVERAGE
11	0.444	38.78	0.31	38.47	56.99	-18.20	LINE	QP
12	0.444	39.51	0.31	39.20	46.99	-7.47	LINE	AVERAGE
13	13.560	16.26	0.91	15.35	60.00	-43.74	LINE	QP
14	13.560	12.09	0.91	11.18	50.00	-37.91	LINE	AVERAGE

Note:

1. Emission Level = reading value + correction factor.
2. Correction factor = cable loss + insertion loss of LISN.
3. Q.P. is abbreviation of quasi-peak.

Test Mode : Mode 1, Continuous Transmitting, with antenna
 Tester : Der-Jan Ken Frequency Range : 150kHz~30MHz
 Phase : Neutral

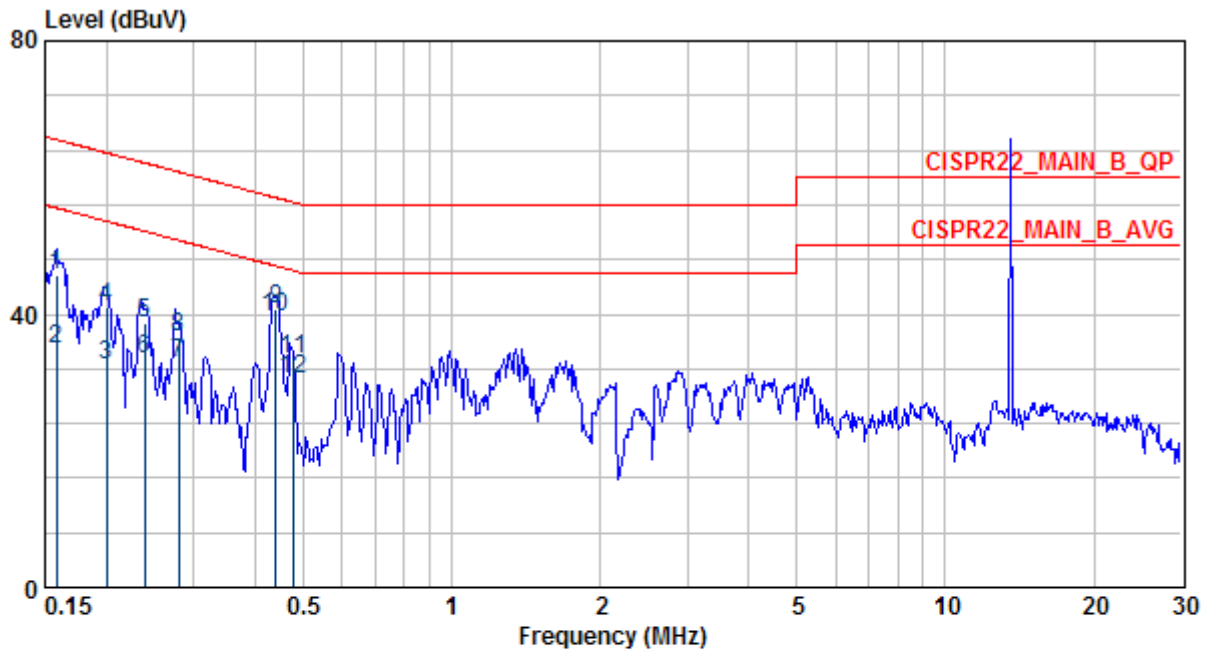

	Freq	Level	Factor	Read Level	Limit Line	Over Limit	Pol/Phase	Remark
	MHz	dBuV	dB	dBuV	dBuV	dB		
1	0.158	45.60	0.31	45.29	65.56	-19.96	NEUTRAL	QP
2	0.158	34.88	0.31	34.57	55.56	-20.68	NEUTRAL	AVERAGE
3	0.200	32.66	0.32	32.34	53.62	-20.96	NEUTRAL	AVERAGE
4	0.200	40.94	0.32	40.62	63.62	-22.68	NEUTRAL	QP
5	0.239	38.74	0.32	38.42	62.12	-23.38	NEUTRAL	QP
6	0.239	33.40	0.32	33.08	52.12	-18.72	NEUTRAL	AVERAGE
7	0.279	32.88	0.32	32.56	50.83	-17.95	NEUTRAL	AVERAGE
8	0.279	36.53	0.32	36.21	60.83	-24.30	NEUTRAL	QP
9	0.440	40.73	0.33	40.40	57.07	-16.33	NEUTRAL	QP
10	0.440	39.70	0.33	39.37	47.07	-7.36	NEUTRAL	AVERAGE
11	0.476	33.38	0.33	33.05	56.41	-23.02	NEUTRAL	QP
12	0.476	30.56	0.33	30.23	46.41	-15.84	NEUTRAL	AVERAGE

Note:

1. Emission Level = reading value + correction factor.
2. Correction factor = cable loss + insertion loss of LISN.
3. Q.P. is abbreviation of quasi-peak.
4. Tx Fundamental for reference only. Please refer to next page.

Test Mode : Mode 1, Continuous Transmitting, with dummy load
 Tester : Der-Jan Ken Frequency Range : 150kHz~30MHz
 Phase : Neutral

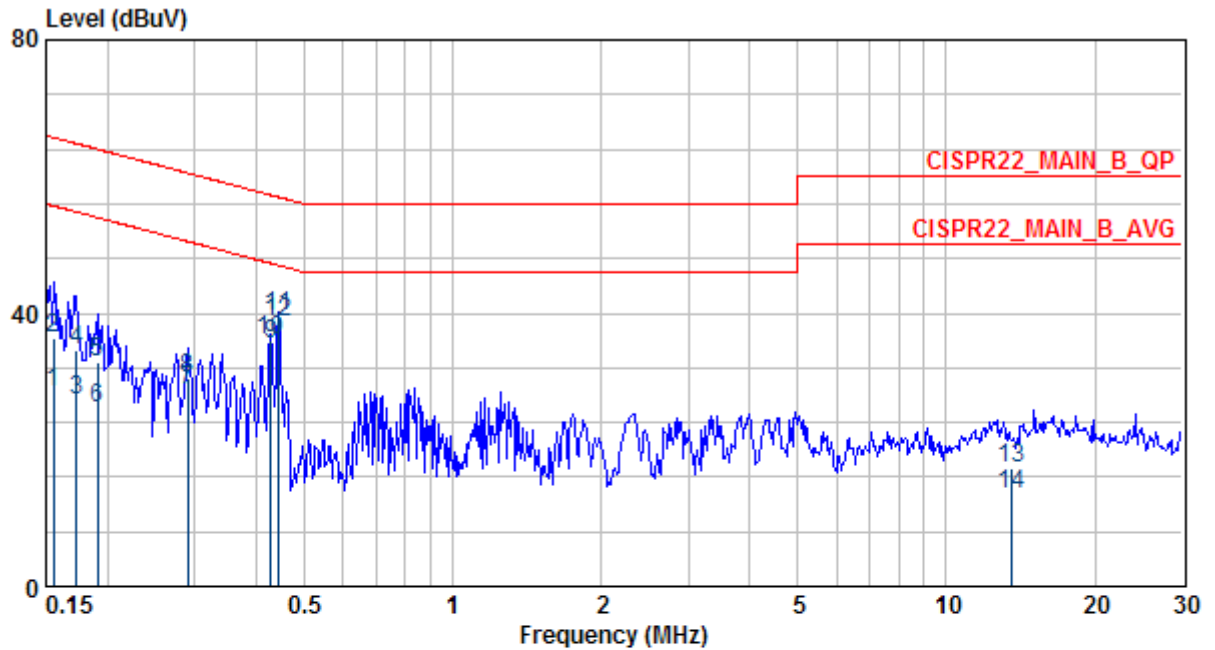

	Freq	Level	Factor	Read Level	Limit Line	Over Limit	Pol/Phase	Remark
	MHz	dBuV	dB	dBuV	dBuV	dB		
1	0.156	28.29	0.31	27.98	55.69	-27.40	NEUTRAL	AVERAGE
2	0.156	36.34	0.31	36.03	65.69	-29.35	NEUTRAL	QP
3	0.173	27.33	0.31	27.02	54.81	-27.48	NEUTRAL	AVERAGE
4	0.173	34.61	0.31	34.30	64.81	-30.20	NEUTRAL	QP
5	0.190	32.77	0.32	32.45	64.02	-31.25	NEUTRAL	QP
6	0.190	26.06	0.32	25.74	54.02	-27.96	NEUTRAL	AVERAGE
7	0.291	28.58	0.32	28.26	50.50	-21.91	NEUTRAL	AVERAGE
8	0.291	30.54	0.32	30.22	60.50	-29.95	NEUTRAL	QP
9	0.428	35.39	0.33	35.06	57.29	-21.90	NEUTRAL	QP
10	0.428	35.90	0.33	35.57	47.29	-11.39	NEUTRAL	AVERAGE
11	0.444	39.49	0.33	39.16	46.99	-7.49	NEUTRAL	AVERAGE
12	0.444	38.78	0.33	38.45	56.99	-18.20	NEUTRAL	QP
13	13.560	17.23	0.91	16.32	60.00	-42.77	NEUTRAL	QP
14	13.560	13.38	0.91	12.47	50.00	-36.62	NEUTRAL	AVERAGE

Note:

1. Emission Level = reading value + correction factor.
2. Correction factor = cable loss + insertion loss of LISN.
3. Q.P. is abbreviation of quasi-peak.

3. Field Strength of fundamental Measurement

Test Result : PASS

3.1 Applied Standard

According to 15.225(a), the field strength of any emissions within the band 13.553 – 13.567 MHz shall not exceed 15,848 microvolts/meter at 30 meters.

According to 15.225(b), within the bands 13.410-13.553 MHz and 13.567-13.710 MHz, the field strength of any emissions shall not exceed 334 microvolts/meter at 30 meters.

According to 15.225(c), within the bands 13.110-13.410 MHz and 13.710-14.010 MHz the field strength of any emissions shall not exceed 106 microvolts/meter at 30 meters.

3.2 Test Instruments

Test Site and Equipment	Manufacturer	Model No./ Serial No.	Last Calibration Date	Calibration Due Date
EMI Test Receiver	R&S	ESCI/ 100019	June 7, 2013	June 7, 2014
Loop Antenna	EMCO	6502/ 20558	Aug. 29, 2013	Aug. 29, 2014
RF Cable	N/A	N/A/ C0080	Feb. 10, 2014	Aug. 10, 2014
Test Software	Audix	e3/ ARD-SPR-000282	NCR	NCR
TR11 Semi – anechoic Chamber	ETS. LINDGREN	TR11/ 906-A	May 11, 2013	May 11, 2014

Note:

1. The calibrations are traceable to NML/ROC.
2. The calibration date of the semi-anechoic chamber listed above is the date of NSA measurement.

Instrument Setting

RBW	VBW	Detector	Trace	Comment
9kHz	N/A	Quasi-Peak	Maxhold	

Climatic Condition

Ambient Temperature : 24°C; Relative Humidity : 61%

3.3 Measurement Procedure

- a. The EUT was set up per the test configuration figured in the next section of this chapter to simulate the typical usage per the user's manual.
- b. If the EUT is tabletop equipment, it should be placed on a wooden table with a height of 0.8 meters above the reference ground plane in the semi-anechoic chamber. If the EUT is floor-standing equipment, it should be placed on a non-conducted support with a height of 12 millimeters above the reference ground plane in the semi-anechoic chamber.
- c. The EUT is set at 3m away from the receiving antenna.
- d. Rapidly sweep the signal in the test frequency range by using the receiver through the Quasi-Peak detector.
- e. Rotate the EUT from 0° to 360° and position the receiving loop antenna at 1~4 meters above the reference ground plane to determine the fundamental frequency and and bandedge and record them.
- f. Then measure each frequency found from step e. by using the receiver with rotating the EUT and positioning the receiving antenna height to determine the maximum level.
- g. Finely tune the antenna and turntable around the recorded position of each frequency found from step e.
- h. Record and compare the maximum level with the required limit.
- i. Change the receiving antenna to another polarization to measure field strength of fundamental by following step d. to g. again.

3.4 Test Configuration

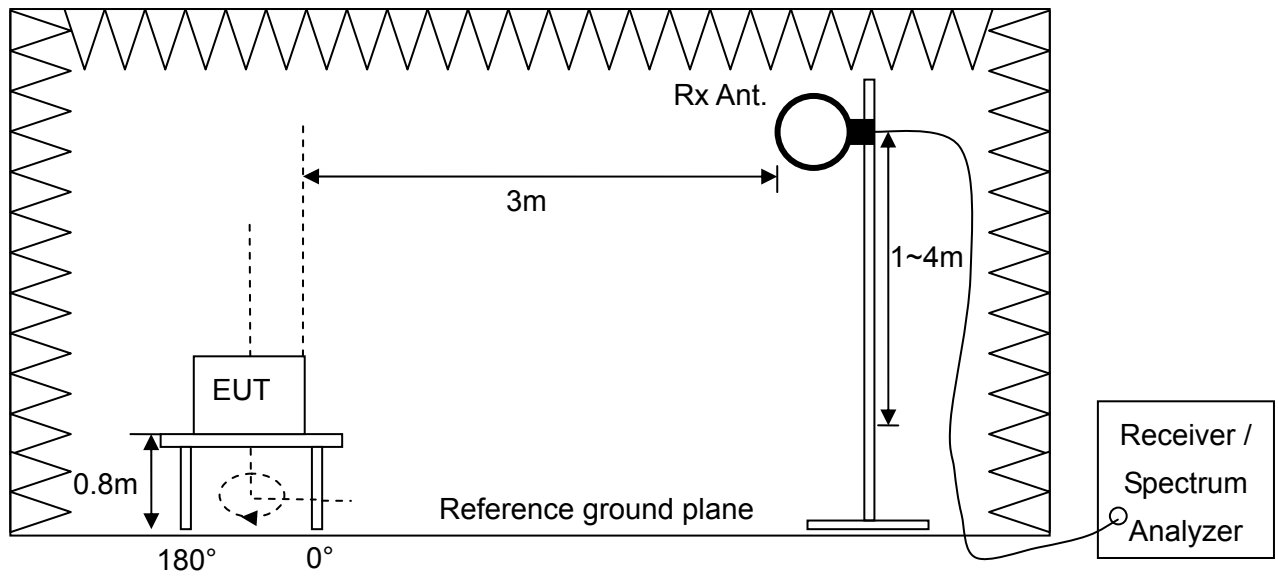

3.5 Test Results

Field strength of fundamental

Test Mode : Mode 1, Continuous Transmitting

Tester : Liu

Polarization : Horizontal

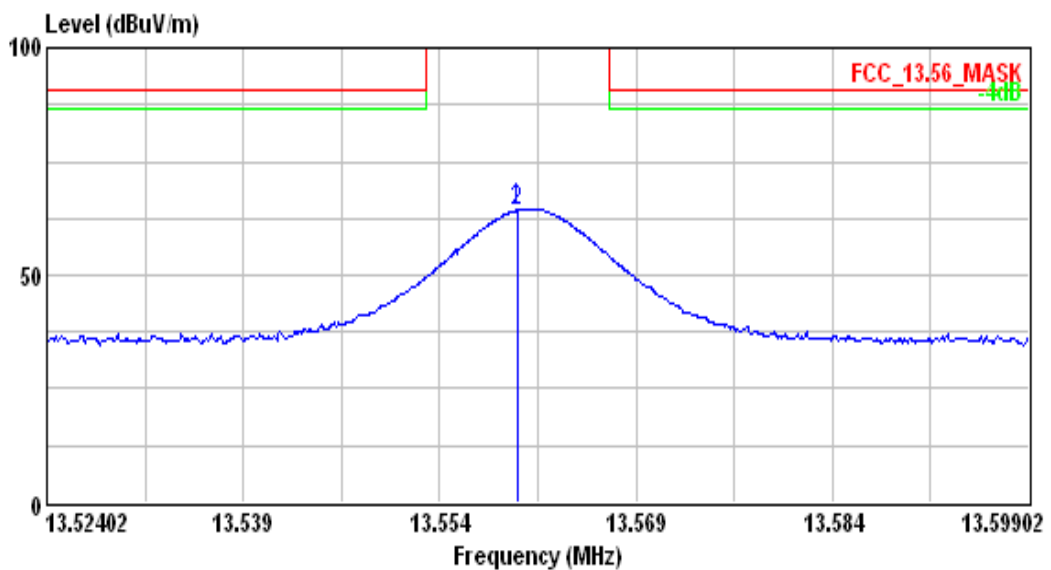

	Freq	Read		Limit	Over	Ant	Table		Remark
		Level	Level Factor				Pos	Pos Pol/Phase	
	MHz	dBuV/m	dBuV	dB/m	dBuV/m	dB	cm	deg	
1	13.560	64.59	50.23	14.36	124.00	-59.41	100	182	HORIZONTAL Peak
2	13.560	63.88	49.52	14.36	124.00	-60.12	100	182	HORIZONTAL QP

Note :

1. Factor (dB/m) = Cable Loss + Antenna Factor
2. Level (dBuV/m) @3m= Reading Level + Factor
3. Over Limit (dB) = Level – Limit Line@3m
4. The limit is 15848 (uV/m)=84dBuV/m @ 30 m , for main frequency < 30MHz, the formula transfers the limit at 30 m to 3m is $L_{30}(dBuV/m) + 40 = 124 dBuV/m$

Test Mode : Mode 1, Continuous Transmitting
 Tester : Liu
 Polarization : Vertical

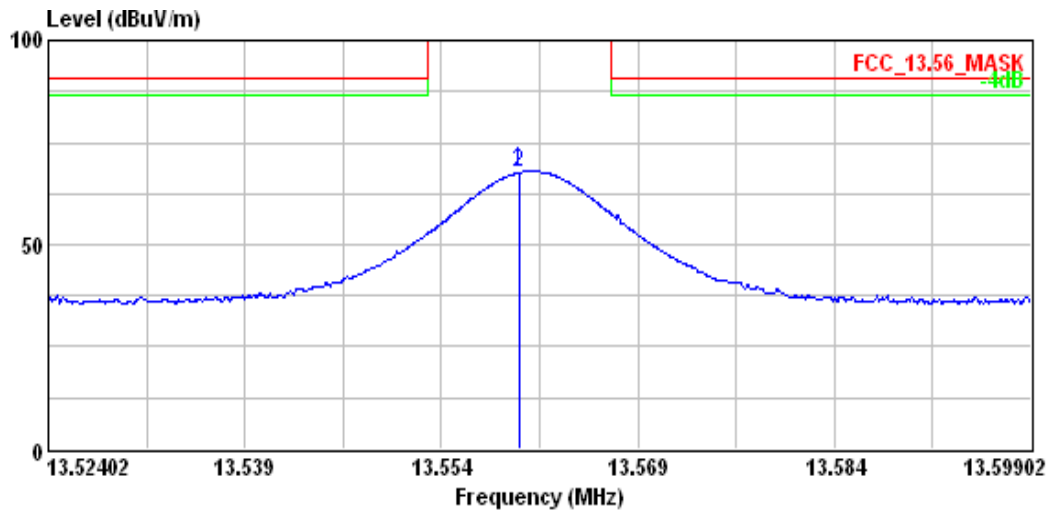

	Freq	Level	Read Level	Factor	Limit Line	Over Limit	Ant Pos	Table Pos	Pol/Phase	Remark
	MHz	dBuV/m	dBuV	dB/m	dBuV/m	dB	cm	deg		
1 @	13.560	68.01	53.65	14.36	124.00	-55.99	134	184	VERTICAL	Peak
2	13.560	67.49	53.13	14.36	124.00	-56.51	134	184	VERTICAL	QP

Note :

- Factor (dB/m) = Cable Loss + Antenna Factor
- Level (dBuV/m) @3m= Reading Level + Factor
- Over Limit (dB) = Level – Limit Line@3m
- The limit is 15848 (uV/m)=84dBuV/m @ 30 m , for main frequency < 30MHz, the formula transfers the limit at 30 m to 3m is $L_{30}(dBuV/m) + 40 = 124 dBuV/m$

Band Edge

Test Mode : Mode 1, Continuous Transmitting

Tester : Liu

Polarization : Horizontal

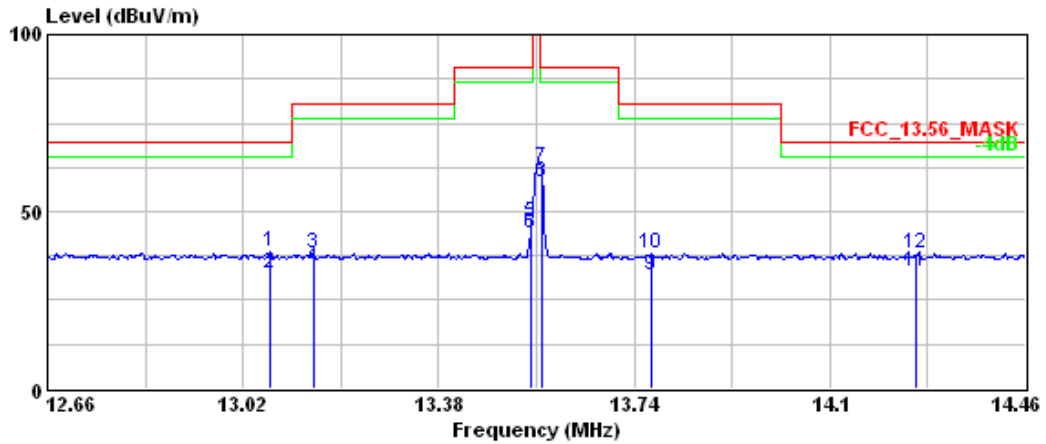

	Freq	Level	Read Level	Factor	Limit Line	Over Limit	Ant Pos	Table Pos	Pol/Phase	Remark
	MHz	dBuV/m	dBuV	dB/m	dBuV/m	dB	cm	deg		
1	13.070	38.59	24.18	14.41	69.54	-30.95	108	44	HORIZONTAL	Peak
2	13.070	32.57	18.16	14.41	69.54	-36.97	108	44	HORIZONTAL	QP
3	13.150	38.24	23.84	14.40	80.51	-42.27	110	153	HORIZONTAL	Peak
4	13.150	34.25	19.85	14.40	80.51	-46.26	110	153	HORIZONTAL	QP
5	13.550	46.67	32.31	14.36	90.47	-43.80	100	182	HORIZONTAL	Peak
6	13.550	43.75	29.39	14.36	90.47	-46.72	100	182	HORIZONTAL	QP
7 @	13.570	62.30	47.94	14.36	90.47	-28.17	100	182	HORIZONTAL	Peak
8	13.570	58.35	43.99	14.36	90.47	-32.12	100	182	HORIZONTAL	QP
9	13.770	32.10	17.75	14.35	80.51	-48.41	101	189	HORIZONTAL	QP
10	13.770	38.10	23.75	14.35	80.51	-42.41	101	189	HORIZONTAL	Peak
11	14.260	32.96	18.67	14.29	69.54	-36.58	110	214	HORIZONTAL	QP
12	14.260	38.15	23.86	14.29	69.54	-31.39	110	214	HORIZONTAL	Peak

Note :

- Factor (dB/m) = Cable Loss + Antenna Factor
- Level (dBUV/m) @3m= Reading Level + Factor
- Over Limit (dB) = Level – Limit Line@3m
- The limit is 15848 (uV/m)=84dBUV/m @ 30 m , for main frequency < 30MHz, the formula transfers the limit at 30 m to 3m is $L_{30}(dBUV/m) + 40 = 124 dBUV/m$

Test Mode : Mode 1, Continuous Transmitting
 Tester : Liu
 Polarization : Vertical

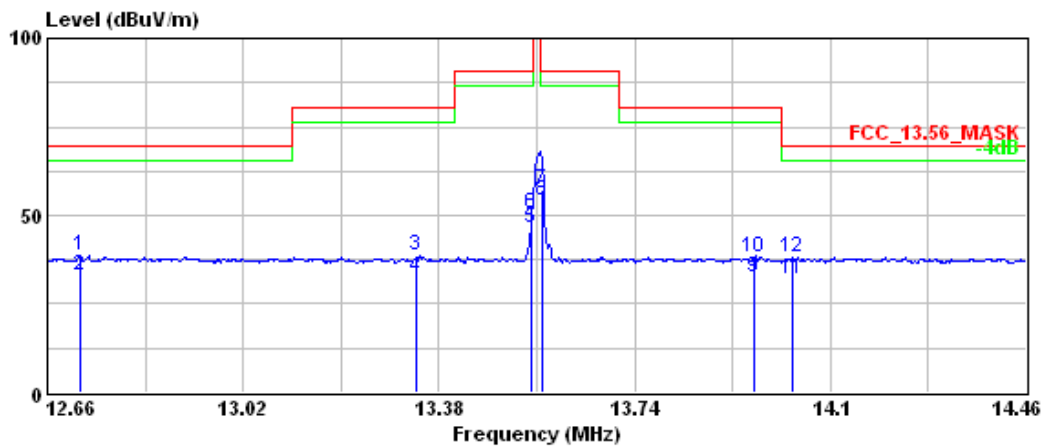

	Freq	Level	Read Level	Factor	Limit Line	Over Limit	Ant Pos	Table Pos	Pol/Phase	Remark
	MHz	dBuV/m	dBuV	dB/m	dBuV/m	dB	cm	deg		
1	12.720	38.86	24.42	14.44	69.54	-30.68	100	58	VERTICAL	Peak
2	12.720	33.00	18.56	14.44	69.54	-36.54	100	58	VERTICAL	QP
3	13.340	38.59	24.21	14.38	80.51	-41.92	102	60	VERTICAL	Peak
4	13.340	32.70	18.32	14.38	80.51	-47.81	102	60	VERTICAL	QP
5	13.550	46.55	32.19	14.36	90.47	-43.92	134	184	VERTICAL	QP
6	13.550	50.54	36.18	14.36	90.47	-39.93	134	184	VERTICAL	Peak
7	13.570	57.03	42.67	14.36	90.47	-33.44	134	184	VERTICAL	Peak
8	13.570	53.92	39.56	14.36	90.47	-36.55	134	184	VERTICAL	QP
9	13.960	32.58	18.26	14.32	80.51	-47.93	101	165	VERTICAL	QP
10	13.960	38.40	24.08	14.32	80.51	-42.11	101	165	VERTICAL	Peak
11	14.030	31.84	17.52	14.32	69.54	-37.70	103	215	VERTICAL	QP
12	14.030	38.25	23.93	14.32	69.54	-31.29	103	215	VERTICAL	Peak

Note :

- Factor (dB/m) = Cable Loss + Antenna Factor
- Level (dBuV/m) @3m= Reading Level + Factor
- Over Limit (dB) = Level – Limit Line@3m
- The limit is 15848 (uV/m)=84dBuV/m @ 30 m , for main frequency < 30MHz, the formula transfers the limit at 30 m to 3m is $L_{30}(dBuV/m) + 40 = 124 dBuV/m$

4. Radiated Emission

Test Result : PASS

4.1 Applied Standard

According to 15.225(d), The field strength of any emissions appearing outside of the 13.110-14.010 MHz band shall not exceed the general radiated emission limits in § 15.209.

Frequency (MHz)	Field Strength (uV/m)	Measurement Distance (m)
0.009 - 0.490	2400/F(kHz)	300
0.490 - 1.705	24000/F(kHz)	30
1.705 - 30.0	30	30
30 - 88	100 **	3
88 - 216	150 **	3
216 - 960	200 **	3
Above 960	500	3

** Except as provided in paragraph (g), fundamental emissions from intentional radiators operating under this Section shall not be located in the frequency bands 54-72 MHz, 76-88 MHz, 174-216 MHz or 470-806 MHz. However, operation within these frequency bands is permitted under other sections of this Part, e.g., Sections 15.231 and 15.241.

4.2 Test Instruments

Test Site and Equipment	Manufacturer	Model No./ Serial No.	Last Calibration Date	Calibration Due Date
EMI Test Receiver	R&S	ESCI/ 100019	June 7, 2013	June 7, 2014
Spectrum Analyzer	Agilent	E4407B/ MY45106795	May 29, 2013	May 29, 2014
Loop Antenna	EMCO	6502/ 20558	Aug. 29, 2013	Aug. 29, 2014
Bi-Log Antenna	EMCO	3142C/ 52088	May 27, 2013	May 27, 2014
Pre-Amplifier	Mini-circuit	ZKL-2/ 004	Feb. 10, 2014	Aug. 10, 2014
RF Cable	N/A	N/A/ C0080	Feb. 10, 2014	Aug. 10, 2014
Test Software	Audix	e3/ ARD-SPR-000282	NCR	NCR
TR11 Semi - anechoic Chamber	ETS. LINDGREN	TR11/ 906-A	May 11, 2013	May 11, 2014

Note:

1. The calibrations are traceable to NML/ROC.
2. NCR:No Calibration Required.
3. The calibration date of the semi-anechoic chamber listed above is the date of NSA measurement.

Instrument Setting

RBW	VBW	Detector	Trace	Comment
9kHz	N/A	Quasi-Peak	Maxhold	Below 30MHz
120kHz	N/A	Quasi-Peak	Maxhold	Below 1GHz

Climatic Condition

Ambient Temperature : 24°C; Relative Humidity : 61%

4.3 Measurement Procedure

- a. The EUT was set up per the test configuration figured in the next section of this chapter to simulate the typical usage per the user's manual.
- b. A software provided by client enabled the EUT to transmit and receive data at specified channel frequencies individually.
- c. If the EUT is tabletop equipment, it was placed on a non-conducted table with a height of 0.8 meters above the reference ground plane in the semi-anechoic chamber. If the EUT is floor-standing equipment, it was placed on a non-conducted support with a height of 12 millimeters above the reference ground plane in the semi-anechoic chamber.
- d. The EUT is set at 3m away from the interference receiving antenna.
- e. Rapidly sweep the signal in the test frequency range by using the spectrum through the Maximum-peak detector.
- f. Rotate the EUT from 0° to 360° and position the receiving antenna at heights from 1 to 4 meters above the reference ground plane continuously to determine at least six frequencies associated with higher emission levels and record them.
- g. For measurement of frequency above 1000MHz, the beamwidth of receiving horn antenna should keep covering EUT when the receiving horn antenna height varied.
- h. Then measure each frequency found from step e. by using the spectrum with rotating the EUT and positioning the receiving antenna height to determine the maximum level.
- i. Finely tune the antenna and turntable around the recorded position of each frequency found from step g.
- j. For measurement of frequency below 1000MHz, set the receiver detector to be Quasi-Peak per CISPR 16-1 to find out the maximum level occurred.
- k. For measurement of frequency above 1000MHz, set the spectrum detector to be Peak or Average to find out the maximum level occurred, if any.
- l. Record frequency, azimuth angle of the turntable, height, and polarization of the receiving antenna and compare the maximum level with the required limit.
- m. Change the receiving antenna to another polarization to measure radiated emission by following step e. to l. again.
- n. If the peak emission level measured from step e. is 4dB lower than the limit specified, then the emission values presented will be the peak value only. Otherwise, accurate Q.P. value will be measured and presented.

4.4 Test Configuration

Radiated Emission Measurement below 30MHz

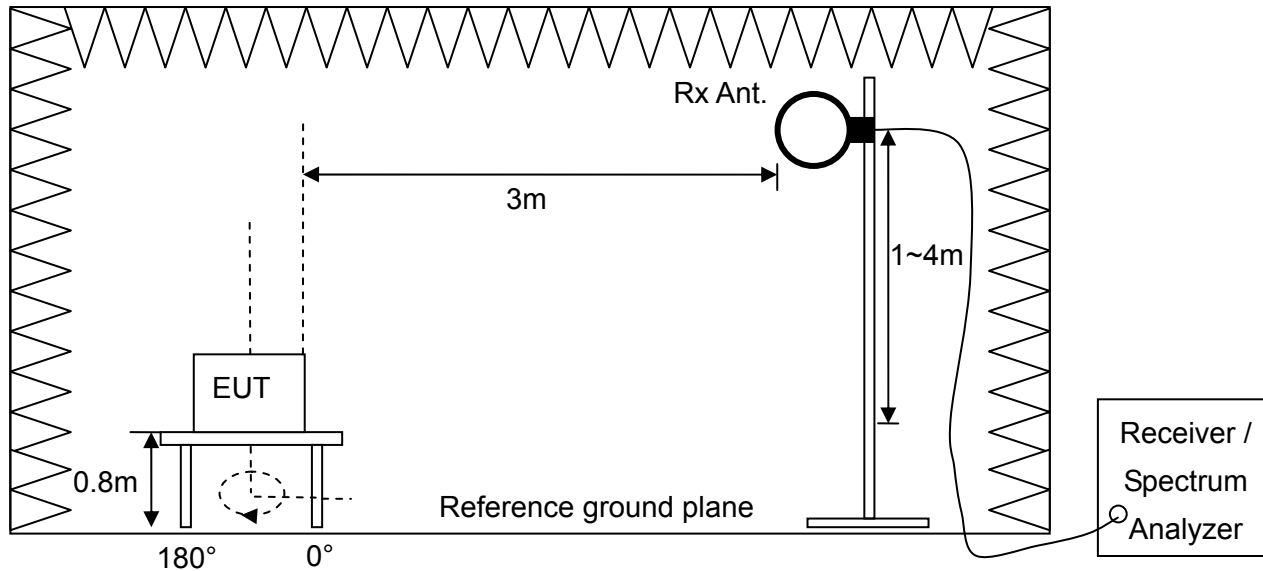

Radiated Emission Measurement above 30MHz

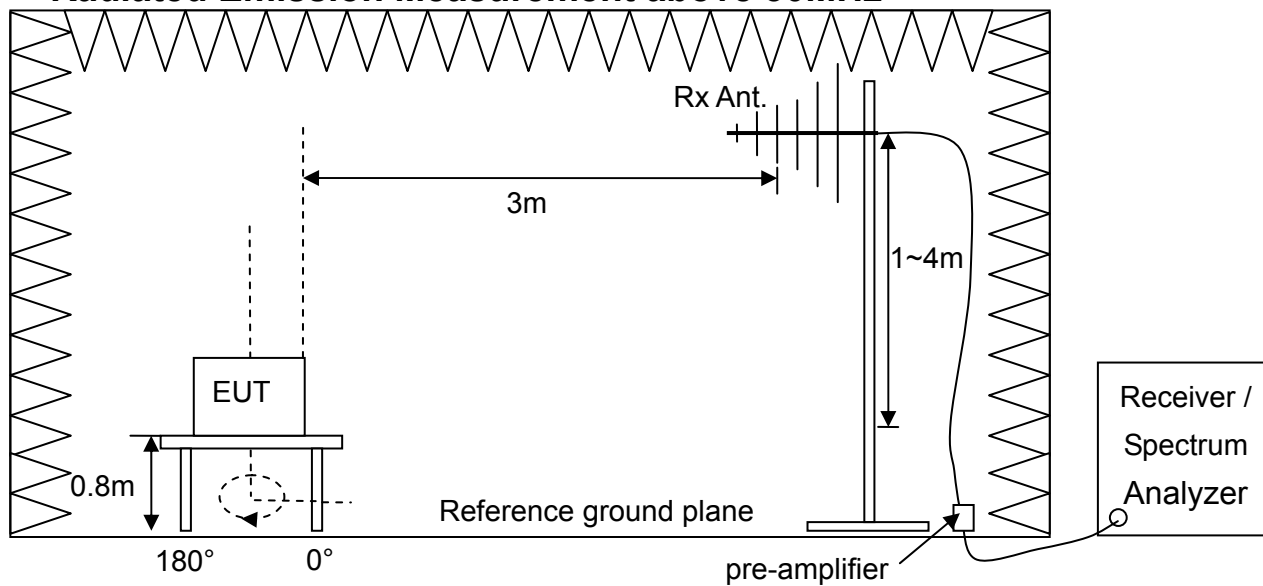

4.5 Test Results

Test Mode : Mode 1, Continuous Transmitting

Tester : Liu Frequency Range : 9kHz~1GHz

Polarization : Horizontal

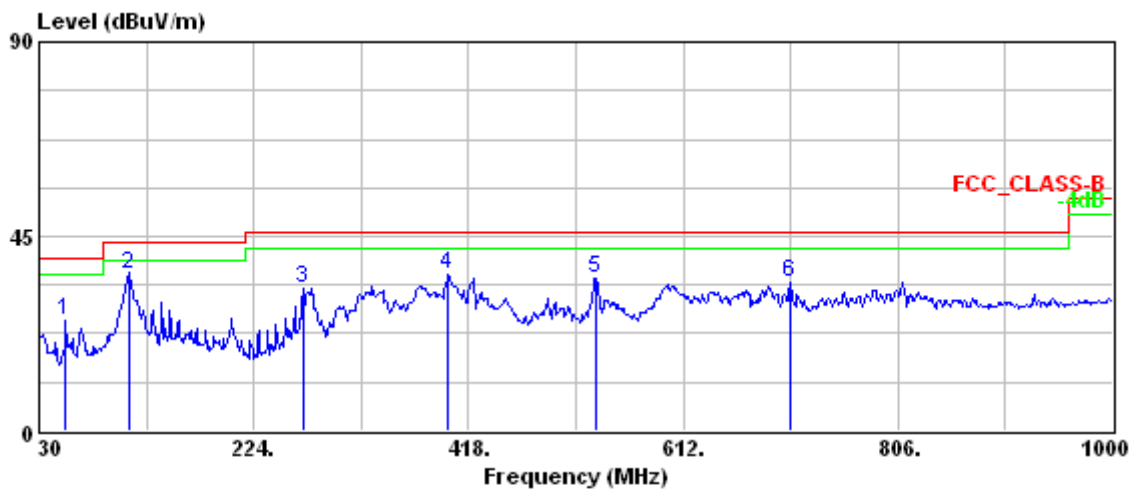

	Freq	Level	Read	Limit	Over	Ant	Table	Table	Remark
	MHz	dBuV/m	Level	Factor	Line	Limit	Pos	Pos	Pol/Phase
			dBuV	dB/m	dBuV/m	dB	cm	deg	
1	54.030	25.34	44.00	-18.66	40.00	-14.66	---	---	HORIZONTAL Peak
2	111.102	36.09	55.18	-19.09	43.50	-7.41	286	315	HORIZONTAL QP
3	268.680	32.90	45.93	-13.03	46.00	-13.10	---	---	HORIZONTAL Peak
4	399.400	36.41	45.26	-8.85	46.00	-9.59	---	---	HORIZONTAL Peak
5	533.100	35.47	41.72	-6.25	46.00	-10.53	---	---	HORIZONTAL Peak
6	708.100	34.30	37.61	-3.31	46.00	-11.70	---	---	HORIZONTAL Peak

Note :

1. Correction Factor (dB/m) = Cable Loss + Antenna Factor – Gain of Preamplifier
2. Emission Level (dBuV/m) = Reading Data + Correction Factor

No signal can be detected from 9kHz to 30MHz, so the graphs are omitted below 30MHz.

Test Mode : Mode 1, Continuous Transmitting

Tester : Liu Frequency Range : 9kHz~1GHz

Polarization : Vertical

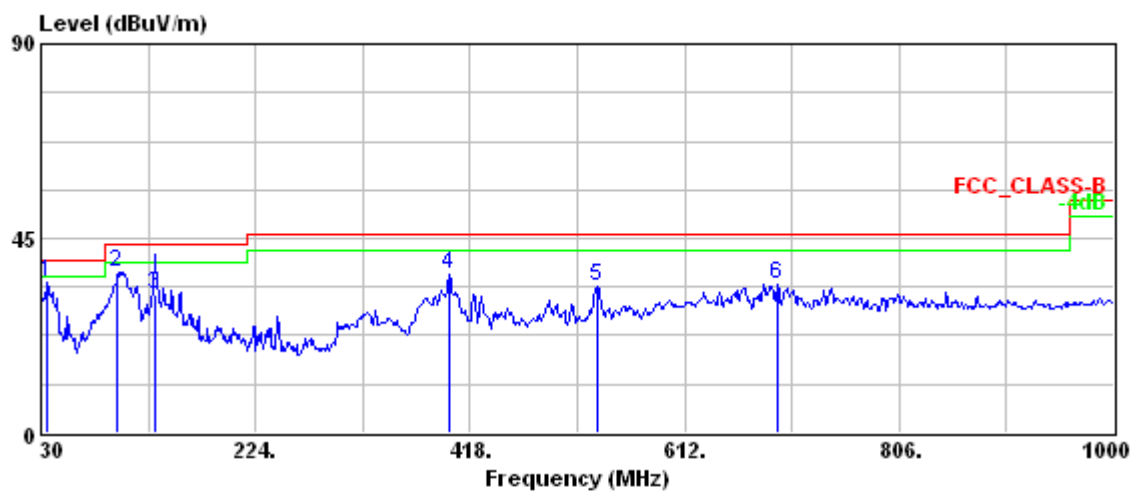

	Freq	Level	Read Level	Limit	Over	Ant	Table	Remark		
	MHz	dBuV/m	dBuV	dB/m	dBuV/m	dB	cm	deg		
1 @	35.940	34.87	46.98	-12.11	40.00	-5.13	---	VERTICAL	Peak	
2	99.390	37.11	55.71	-18.60	43.50	-6.39	---	VERTICAL	Peak	
3	132.877	31.93	50.91	-18.98	43.50	-11.57	101	167	VERTICAL	QP
4	399.400	36.63	45.48	-8.85	46.00	-9.37	---	VERTICAL	Peak	
5	533.100	33.86	40.11	-6.25	46.00	-12.14	---	VERTICAL	Peak	
6	696.200	34.48	37.97	-3.49	46.00	-11.52	---	VERTICAL	Peak	

Note :

1. Correction Factor (dB/m) = Cable Loss + Antenna Factor – Gain of Pre-amplifier
2. Emission Level (dBuV/m) = Reading Data + Correction Factor

No signal can be detected from 9kHz to 30MHz, so the graphs are omitted below 30MHz.

5. Frequency Tolerance

Test Result : PASS

5.1 Applied Standard

According to 15.225(e), the frequency tolerance of the carrier signal shall be maintained within +/- 0.01% of the operating frequency over a temperature variation of -20 degrees to +50 degrees C at normal supply voltage, and for a variation in the primary supply voltage from 85% to 115% of the rated supply voltage at a temperature of 20 degrees C. For battery operated equipment, the equipment tests shall be performed using a new battery.

5.2 Test Instruments

Test Site and Equipment	Manufacturer	Model No./ Serial No.	Last Calibration Date	Calibration Due Date
Spectrum Analyzer	Agilent	E4405B/ MY45106706	April 15, 2014	April 15, 2015
Temperature Chamber	Terchy	MHG-800LF/ 920224	Aug. 16, 2013	Aug. 16, 2014
Adjustable DC Power Supply	instek	PSP-405/ C120177	NCR	NCR
Voltage Meter	FLUKE	187/ 91050091	July 2, 2012	July 2, 2014
Test Site	N.A.	TR13	NCR	NCR

Note:

1. The calibrations are traceable to NML/ROC.
2. NCR:No Calibration Required.

Instrument Setting

RBW	VBW	Detector	Trace	Comment
300Hz	1kHz	Peak	Maxhold	

Climatic Condition

Ambient Temperature : 25°C; Relative Humidity : 55%

5.3 Measurement Procedure

- a. The EUT was set up per the test configuration figured in the next section of this chapter to simulate the typical usage described in the user's manual supported by the manufacturer in test site TR13.
- b. Measure the frequency tolerance by using the spectrum analyzer and following the test conditions described in FCC 15.225(e) to perform the normal and extreme conditions test.
- c. Record the value and compare with the required limit.

5.4 Test Configuration

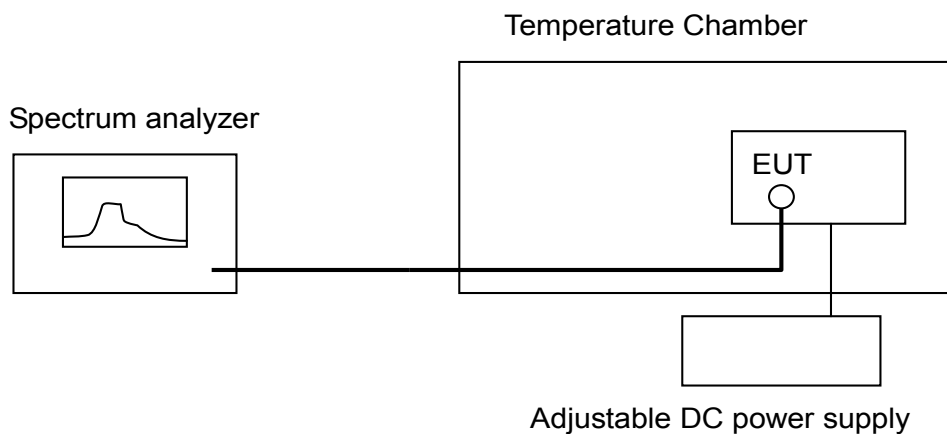

5.5 Test Results

Test Mode : Mode 1, Continuous Transmitting

Tester : Jun

Temperature (°C)	DC Voltage (Volt)	Meas. Frequency (MHz)	Deviation (kHz)	Limit (kHz)	Margin (kHz)
20°C	5	13.56066	N/A	N/A	N/A
	5.75	13.56066	0	1.356	1.356
	4.53 ^(Note 3)	13.56066	0	1.356	1.356
-20°C	5	13.56075	0.09	1.356	1.266
50°C	5	13.56064	0.02	1.356	1.336

Note:

1. Deviation(kHz) = | Meas. Frequency – Meas. Frequency @20°C/5Vdc |
2. Margin (kHz)= Limit – Deviation
3. When Input voltage below 4.53 Vdc, the device can't work normal.
4. The test results of 12Vdc is pass. The test data are omitted.

20°C, 5Vdc

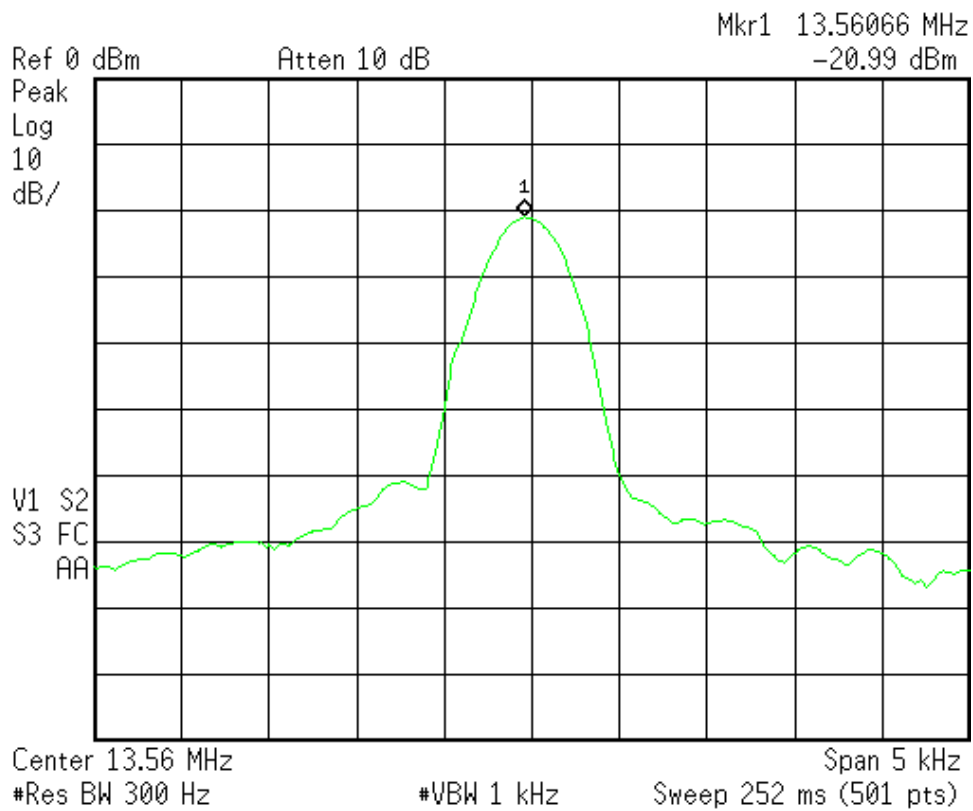

20°C, 5.75Vdc

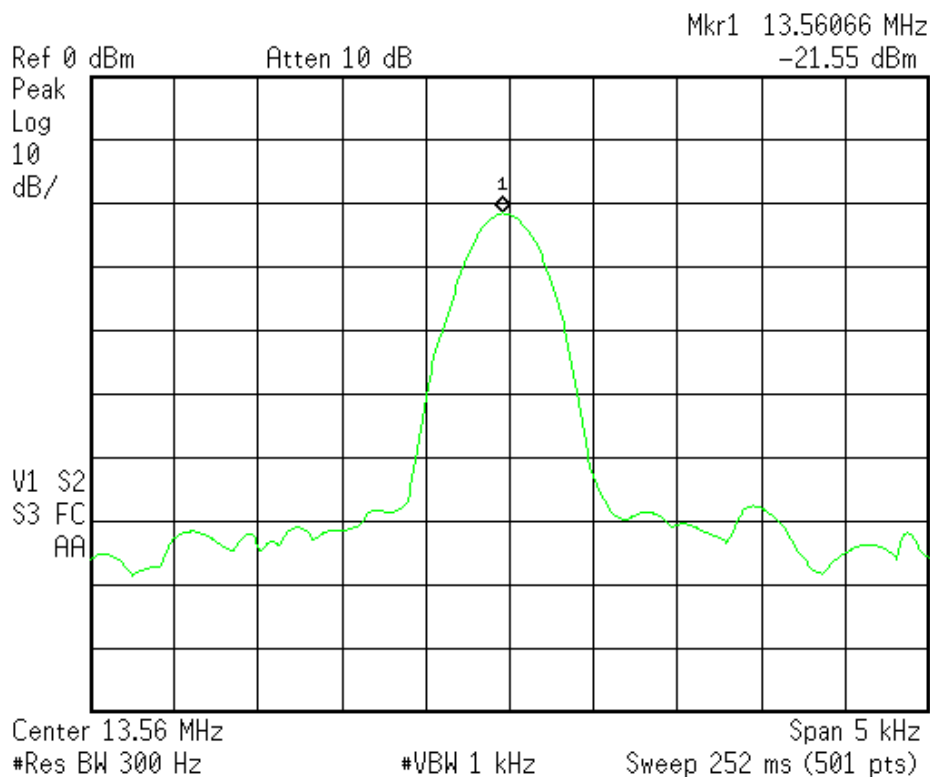

20°C, 4.53 Vdc

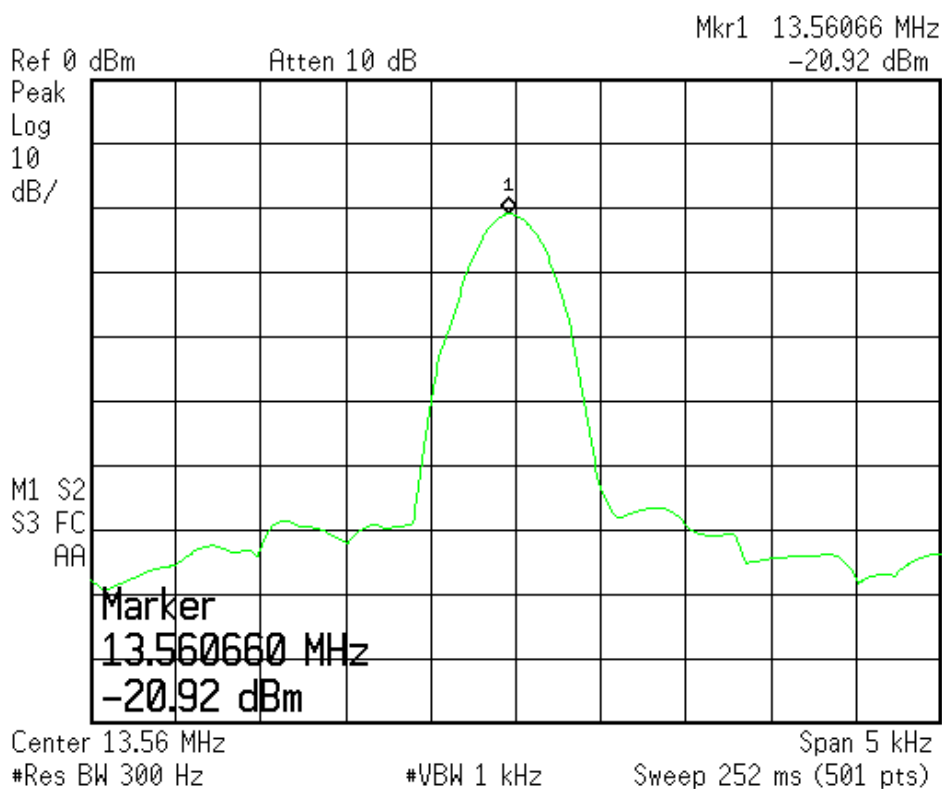

-20°C, 5Vdc

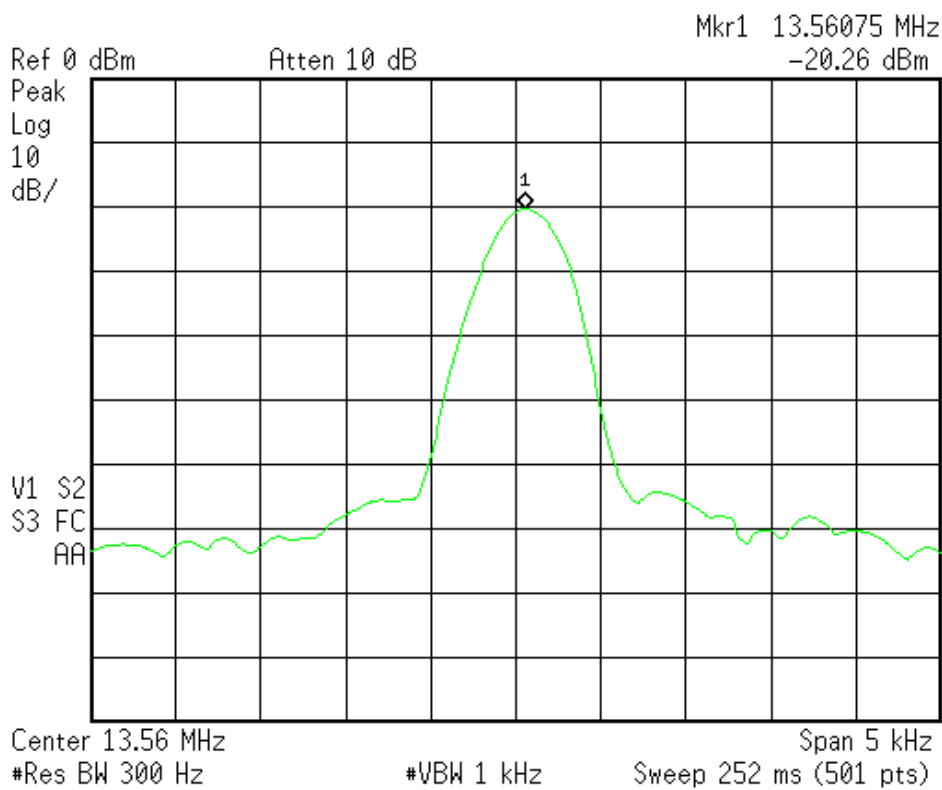

50°C, 5Vdc

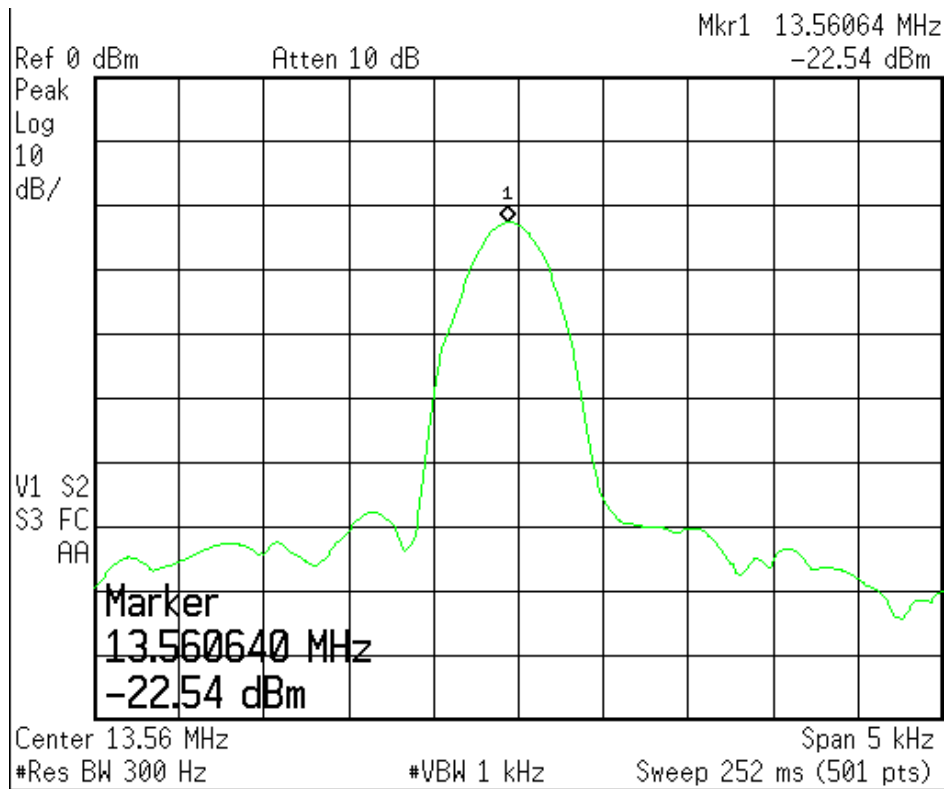

6. 20dB Bandwidth

Test Result : PASS

6.1 Applied Standard

According to 15.215(c) requires the device must be designed to ensure that the 20 dB bandwidth of the emission, or whatever bandwidth may otherwise be specified in the specific rule section under which the equipment operates.

According to 15.225, Operation should within the band 13.110 – 14.010 MHz.

6.2 Test Instruments

Test Site and Equipment	Manufacturer	Model No./ Serial No.	Last Calibration Date	Calibration Due Date
Spectrum Analyzer	Agilent	E4405B/ MY45106706	April 15, 2014	April 15, 2015
Test Site	N.A.	TR13	NCR	NCR

Note:

- 1.The calibrations are traceable to NML/ROC.
- 2.NCR : No Calibration Required.

Instrument Setting

RBW	VBW	Detector	Trace	Comment
300Hz	1kHz	Peak	Maxhold	

Climatic Condition

Ambient Temperature : 25°C; Relative Humidity : 55%

6.3 Measurement Procedure

- a. The EUT was set up per the test configuration figured in the next section of this chapter to simulate the typical usage described in the user's manual supported by the manufacturer in test site TR13.
- b. Measure the 20dB bandwidth by using the spectrum analyzer and following the test conditions described in FCC 15.215.
- c. Record the frequency and compare with the required limit.

6.4 Test Configuration



6.5 Test Results

Test Mode : Mode 1, Continuous Transmitting

Tester : Bill

Operating Frequency (MHz)	Limit (MHz)
13.56	13.110~14.01

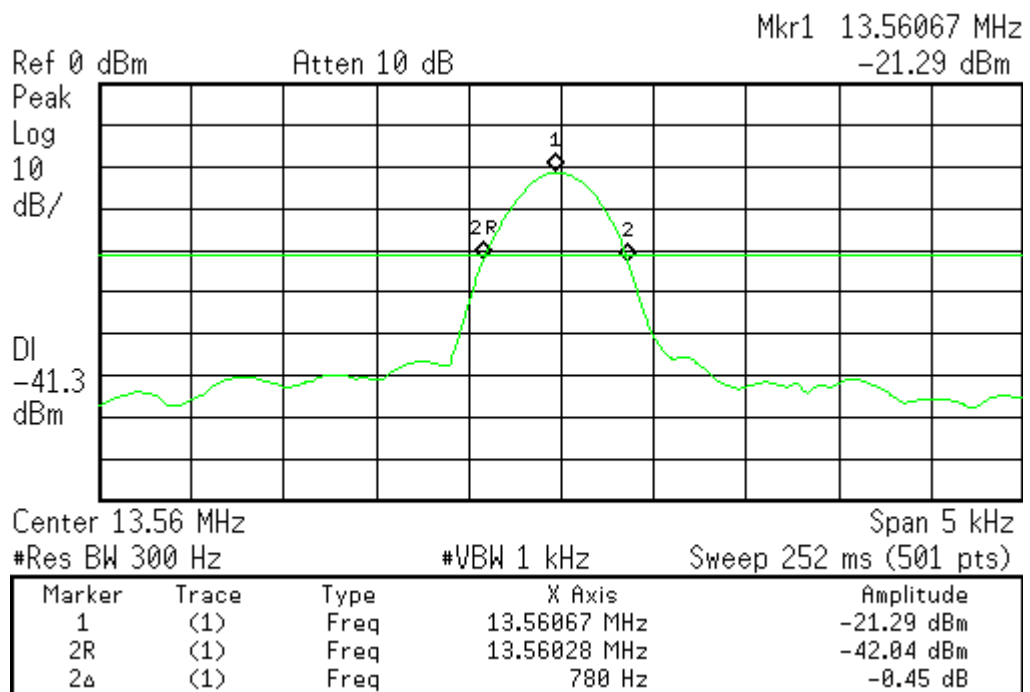

7. Antenna Requirement

7.1 Applied Standard

An intentional radiator shall be designed to ensure that no antenna other than that furnished by the responsible party shall be used with the device. The use of a permanently attached antenna or of an antenna that uses a unique coupling to the intentional radiator shall be considered sufficient to comply with the provisions of this Section. The manufacturer may design the unit so that a broken antenna can be replaced by the user, but the use of a standard antenna jack or electrical connector is prohibited. This requirement does not apply to carrier current devices or to devices operated under the provisions of Sections 15.211, 15.213, 15.217, 15.219, or 15.221. Further, this requirement does not apply to intentional radiators that must be professionally installed, such as perimeter protection systems and some field disturbance sensors, or to other intentional radiators which, in accordance with Section 15.31(d), must be measured at the installation site. However, the installer shall be responsible for ensuring that the proper antenna is employed so that the limits in this Part are not exceeded.

7.2 Antenna Type

The EUT use a permanently attached antenna

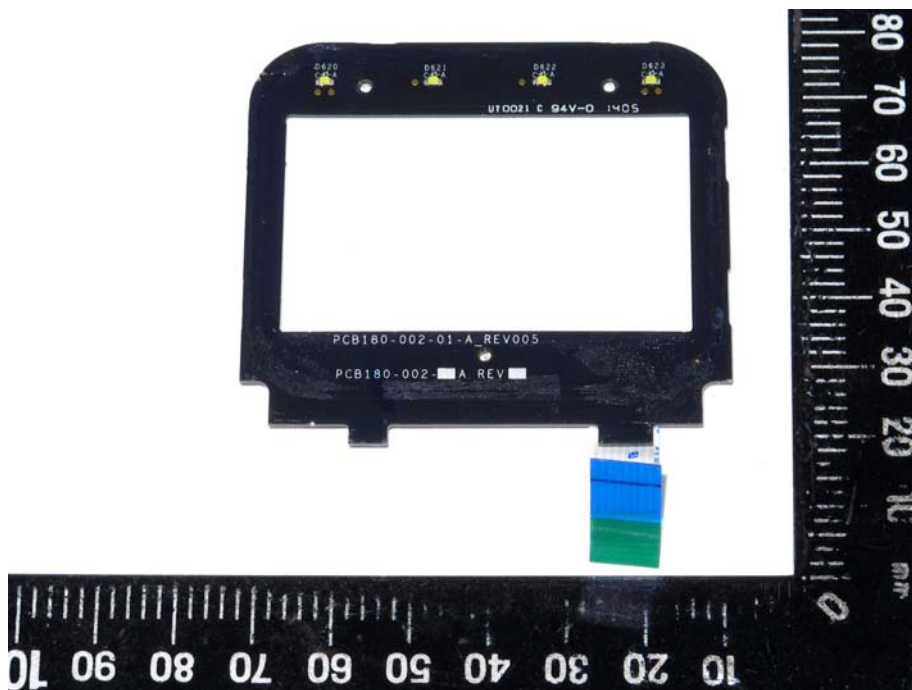

7.3 Applicable Result

Comply the requirement.