



A D T

# FCC TEST REPORT

**REPORT NO.:** RF150729C24-2  
**MODEL NO.:** P400 Plus  
**FCC ID:** B32P400PLUS  
**RECEIVED:** Jul. 29, 2015  
**TESTED:** Aug. 14, 2015 ~ Aug. 15, 2015  
**ISSUED:** Aug. 21, 2015

**APPLICANT:** Verifone, Inc.

**ADDRESS:** 1400 West Stanford Ranch Road Suite 200 Rocklin  
CA 95765 USA

**ISSUED BY:** Bureau Veritas Consumer Products Services (H.K.)  
Ltd., Taoyuan Branch

**LAB ADDRESS:** No. 47-2, 14th Ling, Chia Pau Vil., Lin Kou Dist.,  
New Taipei City, Taiwan ( R.O.C )

**TEST LOCATION:** No.19, Hwa Ya 2nd Rd., Wen Hwa Vil., Kwei Shan  
Dist., Taoyuan City 33383, Taiwan, R.O.C.

This report should not be used by the client to claim product certification, approval, or endorsement by TAF or any government agencies.



This report is for your exclusive use. Any copying or replication of this report to or for any other person or entity, or use of our name or trademark, is permitted only with our prior written permission. This report sets forth our findings solely with respect to the test samples identified herein. The results set forth in this report are not indicative or representative of the quality or characteristics of the lot from which a test sample was taken or any similar or identical product unless specifically and expressly noted. Our report includes all of the tests requested by you and the results thereof based upon the information that you provided to us. You have 60 days from date of issuance of this report to notify us of any material error or omission caused by our negligence, provided, however, that such notice shall be in writing and shall specifically address the issue you wish to raise. A failure to raise such issue within the prescribed time shall constitute your unqualified acceptance of the completeness of this report, the tests conducted and the correctness of the report contents. Unless specific mention, the uncertainty of measurement has been explicitly taken into account to declare the compliance or non-compliance to the specification.



# TABLE OF CONTENTS

RELEASE CONTROL RECORD .....	4
1. CERTIFICATION.....	5
2. SUMMARY OF TEST RESULTS .....	6
2.1 MEASUREMENT UNCERTAINTY.....	6
3. GENERAL INFORMATION .....	7
3.1 GENERAL DESCRIPTION OF EUT .....	7
3.2 DESCRIPTION OF TEST MODES .....	8
3.2.1 TEST MODE APPLICABILITY AND TESTED CHANNEL DETAIL .....	9
3.3 DESCRIPTION OF SUPPORT UNITS .....	11
3.3.1 CONFIGURATION OF SYSTEM UNDER TEST .....	11
3.4 GENERAL DESCRIPTION OF APPLIED STANDARDS .....	12
4. TEST TYPES AND RESULTS (FOR BLUETOOTH EDR) .....	13
4.1 RADIATED EMISSION AND BANDEDGE MEASUREMENT .....	13
4.1.1 LIMITS OF RADIATED EMISSION AND BANDEDGE MEASUREMENT .....	13
4.1.2 TEST INSTRUMENTS .....	14
4.1.3 TEST PROCEDURES .....	15
4.1.4 DEVIATION FROM TEST STANDARD .....	15
4.1.5 TEST SETUP .....	16
4.1.6 EUT OPERATING CONDITIONS .....	16
4.1.7 TEST RESULTS.....	17
4.2 CONDUCTED EMISSION MEASUREMENT .....	21
4.2.1 LIMITS OF CONDUCTED EMISSION MEASUREMENT .....	21
4.2.2 TEST INSTRUMENTS.....	21
4.2.3 TEST PROCEDURES .....	22
4.2.4 DEVIATION FROM TEST STANDARD .....	22
4.2.5 TEST SETUP .....	23
4.2.6 EUT OPERATING CONDITIONS .....	23
4.2.7 TEST RESULTS.....	24
4.3 NUMBER OF HOPPING FREQUENCY USED .....	26
4.3.1 LIMIT OF HOPPING FREQUENCY USED .....	26
4.3.2 TEST SETUP .....	26
4.3.3 TEST INSTRUMENTS.....	26
4.3.4 TEST PROCEDURE .....	26
4.3.5 DEVIATION FROM TEST STANDARD .....	26
4.3.6 TEST RESULTS.....	26
4.4 DWELL TIME ON EACH CHANNEL .....	28
4.4.1 LIMITS OF DWELL TIME USED .....	28
4.4.2 TEST SETUP .....	28
4.4.3 TEST INSTRUMENTS.....	28
4.4.4 TEST PROCEDURES .....	28
4.4.5 DEVIATION FROM TEST STANDARD .....	28
4.4.6 TEST RESULTS.....	29
4.5 CHANNEL BANDWIDTH.....	32
4.5.1 LIMITS OF CHANNEL BANDWIDTH .....	32
4.5.2 TEST SETUP .....	32
4.5.3 TEST INSTRUMENTS.....	32
4.5.4 TEST PROCEDURE .....	32
4.5.5 DEVIATION FROM TEST STANDARD .....	32
4.5.6 EUT OPERATING CONDITION.....	32
4.5.7 TEST RESULTS.....	33
4.6 HOPPING CHANNEL SEPARATION .....	34
4.6.1 LIMITS OF HOPPING CHANNEL SEPARATION.....	34



A D T

4.6.2	TEST SETUP .....	34
4.6.3	TEST INSTRUMENTS .....	34
4.6.4	TEST PROCEDURE .....	34
4.6.5	DEVIATION FROM TEST STANDARD .....	34
4.6.6	TEST RESULTS.....	35
4.7	MAXIMUM OUTPUT POWER .....	36
4.7.1	LIMITS OF MAXIMUM OUTPUT POWER MEASUREMENT .....	36
4.7.2	TEST SETUP .....	36
4.7.3	TEST INSTRUMENTS .....	36
4.7.4	TEST PROCEDURE .....	36
4.7.5	DEVIATION FROM TEST STANDARD .....	36
4.7.6	EUT OPERATING CONDITION.....	36
4.7.7	TEST RESULTS.....	37
4.8	CONDUCTED OUT OF BAND EMISSION MEASUREMENT .....	38
4.8.1	LIMITS OF CONDUCTED OUT OF BAND EMISSION MEASUREMENT .....	38
4.8.2	TEST INSTRUMENTS.....	38
4.8.3	TEST PROCEDURE .....	38
4.8.4	DEVIATION FROM TEST STANDARD .....	38
4.8.5	EUT OPERATING CONDITION.....	38
4.8.6	TEST RESULTS.....	38
5.	PHOTOGRAPHS OF THE TEST CONFIGURATION.....	42
6.	INFORMATION ON THE TESTING LABORATORIES .....	43
7.	APPENDIX A – MODIFICATIONS RECORDERS FOR ENGINEERING CHANGES TO THE EUT BY THE LAB .....	44



A D T

## RELEASE CONTROL RECORD

ISSUE NO.	REASON FOR CHANGE	DATE ISSUED
RF150729C24-2	Original release	Aug. 21, 2015



## 1. CERTIFICATION

**PRODUCT:** Point of Sale Terminal  
**MODEL NO.:** P400 Plus  
**BRAND:** Verifone  
**APPLICANT:** Verifone, Inc.  
**TESTED:** Aug. 14, 2015 ~ Aug. 15, 2015  
**TEST SAMPLE:** Identical Prototype  
**STANDARDS:** **FCC Part 15, Subpart C (Section 15.247)**  
ANSI C63.10-2013

The above equipment (model: P400 Plus) has been tested by **Bureau Veritas Consumer Products Services (H.K.) Ltd., Taoyuan Branch**, and found compliance with the requirement of the above standards. The test record, data evaluation & Equipment Under Test (EUT) configurations represented herein are true and accurate accounts of the measurements of the sample's EMC characteristics under the conditions specified in this report.

**PREPARED BY :** Gina Liu , **DATE :** Aug. 21, 2015  
Gina Liu / Specialist

**APPROVED BY :** Kay Wu , **DATE :** Aug. 21, 2015  
Kay Wu / Supervisor

## 2. SUMMARY OF TEST RESULTS

The EUT has been tested according to the following specifications:

APPLIED STANDARD: FCC Part 15, Subpart C (Bluetooth EDR)			
STANDARD SECTION	TEST TYPE AND LIMIT	RESULT	REMARK
15.207	AC Power Conducted Emission	PASS	Meet the requirement of limit. Minimum passing margin is -11.55dB at 17.88967MHz.
15.247(a)(1) (iii)	Number of Hopping Frequency Used	PASS	Meet the requirement of limit.
15.247(a)(1) (iii)	Dwell Time on Each Channel	PASS	Meet the requirement of limit.
15.247(a)(1)	1. Hopping Channel Separation 2. Spectrum Bandwidth of a Frequency Hopping Sequence Spread Spectrum System	PASS	Meet the requirement of limit.
15.247(b)	Maximum Peak Output Power	PASS	Meet the requirement of limit.
15.247(d)	Transmitter Radiated Emissions	PASS	Meet the requirement of limit. Minimum passing margin is -1.67dB at 31.94MHz.
15.247(d)	Band Edge Measurement	PASS	Meet the requirement of limit.
15.203	Antenna Requirement	PASS	No antenna connector is used.

**NOTE:** If The Frequency Hopping System operating in 2400-2483.5MHz band and the output power less than 125mW. The hopping channel carrier frequencies separated by a minimum of 25kHz or two-thirds of the 20dB bandwidth of hopping channel whichever is greater.

### 2.1 MEASUREMENT UNCERTAINTY

Where relevant, the following measurement uncertainty levels have been estimated for tests performed on the EUT as specified in CISPR 16-4-2:

MEASUREMENT	FREQUENCY	UNCERTAINTY
Conducted emissions	9kHz~30MHz	2.44 dB
Radiated emissions	30MHz ~ 200MHz	2.93 dB
	200MHz ~1000MHz	2.95 dB
	1GHz ~ 18GHz	2.26 dB
	18GHz ~ 40GHz	1.94 dB

This uncertainty represents an expanded uncertainty expressed at approximately the 95% confidence level using a coverage factor of  $k = 2$ .

### 3. GENERAL INFORMATION

#### 3.1 GENERAL DESCRIPTION OF EUT

<b>EUT</b>	Point of Sale Terminal	
<b>MODEL NO.</b>	P400 Plus	
<b>POWER SUPPLY</b>	9.0Vdc (adapter)	
<b>MODULATION TYPE</b>	Bluetooth EDR	GFSK, $\pi/4$ -DQPSK, 8DPSK
<b>TRANSFER RATE</b>	Bluetooth EDR	1/2/3Mbps
<b>OPERATING FREQUENCY</b>	2402 ~ 2480MHz	
<b>NUMBER OF CHANNEL</b>	Bluetooth EDR	79
<b>CHANNEL SPACING</b>	Bluetooth EDR	1MHz
<b>OUTPUT POWER</b>	Bluetooth EDR	11.561mW
<b>ANTENNA TYPE</b>	PIFA antenna with 1.49dBi gain	
<b>ANTENNA CONNECTOR</b>	NA	
<b>DATA CABLE</b>	Refer to Note as below	
<b>I/O PORTS</b>	Refer to user's manual	
<b>ACCESSORY DEVICES</b>	Refer to Note as below	

**NOTE:**

- The EUT contains following accessory devices.

ITEM	BRAND	MODEL	SPECIFICATION
Adapter 1	Verifone	A109-1090103U	I/P: 100-240Vac, 50/60Hz, 0.25A O/P: 9Vdc, 1A
Adapter 2	Verifone	2ACA009E UL	I/P: 100-240Vac, 50/60Hz, 0.5A O/P: 9Vdc, 1A
Dongle	Verifone	CBL282-044-01-B	1.0 meter with one core with shielding

- The above EUT information is declared by the manufacturer and for more detailed features description, please refer to the manufacturer's specifications or User's Manual.

### 3.2 DESCRIPTION OF TEST MODES

#### Bluetooth EDR:

79 channels are provided to this EUT:

CHANNEL	FREQ. (MHz)	CHANNEL	FREQ. (MHz)	CHANNEL	FREQ. (MHz)	CHANNEL	FREQ. (MHz)
0	2402	20	2422	40	2442	60	2462
1	2403	21	2423	41	2443	61	2463
2	2404	22	2424	42	2444	62	2464
3	2405	23	2425	43	2445	63	2465
4	2406	24	2426	44	2446	64	2466
5	2407	25	2427	45	2447	65	2467
6	2408	26	2428	46	2448	66	2468
7	2409	27	2429	47	2449	67	2469
8	2410	28	2430	48	2450	68	2470
9	2411	29	2431	49	2451	69	2471
10	2412	30	2432	50	2452	70	2472
11	2413	31	2433	51	2453	71	2473
12	2414	32	2434	52	2454	72	2474
13	2415	33	2435	53	2455	73	2475
14	2416	34	2436	54	2456	74	2476
15	2417	35	2437	55	2457	75	2477
16	2418	36	2438	56	2458	76	2478
17	2419	37	2439	57	2459	77	2479
18	2420	38	2440	58	2460	78	2480
19	2421	39	2441	59	2461		





### 3.2.1 TEST MODE APPLICABILITY AND TESTED CHANNEL DETAIL

#### BLUETOOTH EDR

EUT CONFIGURE MODE	APPLICABLE TO				DESCRIPTION
	RE≥1G	RE<1G	PLC	APCM	
-	√	√	√	√	-

Where **RE≥1G**: Radiated Emission above 1GHz      **RE<1G**: Radiated Emission below 1GHz  
**PLC**: Power Line Conducted Emission      **APCM**: Antenna Port Conducted Measurement

- NOTE:** 1. For Radiated emission test, pre-tested GFSK, π/4-DQPSK, 8DPSK modulation type and found GFSK was the worse, therefore chosen for the final test and presented in the test report.  
 2. The EUT had been pre-tested on the positioned of each 3 axis. The worst case was found when positioned on **X-plane**.

#### RADIATED EMISSION TEST (ABOVE 1GHz):

- Pre-Scan has been conducted to determine the worst-case mode from all possible combinations between available modulations, data rates and antenna ports (if EUT with antenna diversity architecture).
- Following channel(s) was (were) selected for the final test as listed below.

EUT CONFIGURE MODE	AVAILABLE CHANNEL	TESTED CHANNEL	MODULATION TYPE	PACKET TYPE
-	0 to 78	0, 39, 78	GFSK	DH5

#### RADIATED EMISSION TEST (BELOW 1GHz):

- Pre-Scan has been conducted to determine the worst-case mode from all possible combinations between available modulations, data rates and antenna ports (if EUT with antenna diversity architecture).
- Following channel(s) was (were) selected for the final test as listed below.

EUT CONFIGURE MODE	AVAILABLE CHANNEL	TESTED CHANNEL	MODULATION TYPE	PACKET TYPE
-	0 to 78	0	GFSK	DH5

#### POWER LINE CONDUCTED EMISSION TEST:

- Pre-Scan has been conducted to determine the worst-case mode from all possible combinations between available modulations, data rates and antenna ports (if EUT with antenna diversity architecture).
- Following channel(s) was (were) selected for the final test as listed below.

EUT CONFIGURE MODE	AVAILABLE CHANNEL	TESTED CHANNEL	MODULATION TYPE	PACKET TYPE
-	0 to 78	0	GFSK	DH5



**ANTENNA PORT CONDUCTED MEASUREMENT:**

- This item includes all test value of each mode, but only includes spectrum plot of worst value of each mode.
- Pre-Scan has been conducted to determine the worst-case mode from all possible combinations between available modulations, data rates and antenna ports (if EUT with antenna diversity architecture).
- Following channel(s) was (were) selected for the final test as listed below.

EUT CONFIGURE MODE	AVAILABLE CHANNEL	TESTED CHANNEL	MODULATION TYPE	PACKET TYPE
-	0 to 78	0, 39, 78	GFSK	DH5
-	0 to 78	0, 39, 78	$\pi/4$ -DQPSK	DH5
-	0 to 78	0, 39, 78	8DPSK	DH5

**TEST CONDITION:**

APPLICABLE TO	ENVIRONMENTAL CONDITIONS	INPUT POWER	TESTED BY
RE $\geq$ 1G	25deg. C, 65%RH	120Vac, 60Hz	Gavin Wu
RE<1G	25deg. C, 65%RH	120Vac, 60Hz	Gavin Wu
PLC	25deg. C, 65%RH	120Vac, 60Hz	Toby Tian
APCM	25deg. C, 65%RH	120Vac, 60Hz	Taylor Liu

### 3.3 DESCRIPTION OF SUPPORT UNITS

The EUT has been tested as an independent unit together with other necessary accessories or support units. The following support units or accessories were used to form a representative test configuration during the tests.

NO.	PRODUCT	BRAND	MODEL NO.	SERIAL NO.	FCC ID
1	Bluetooth Tester	R&S	CBT	100870	N/A

NO.	SIGNAL CABLE DESCRIPTION OF THE ABOVE SUPPORT UNITS
1	N/A

- NOTE:**
1. All power cords of the above support units are non shielded (1.8m).
  2. Item 1 as a communication partner to transfer data.

#### 3.3.1 CONFIGURATION OF SYSTEM UNDER TEST

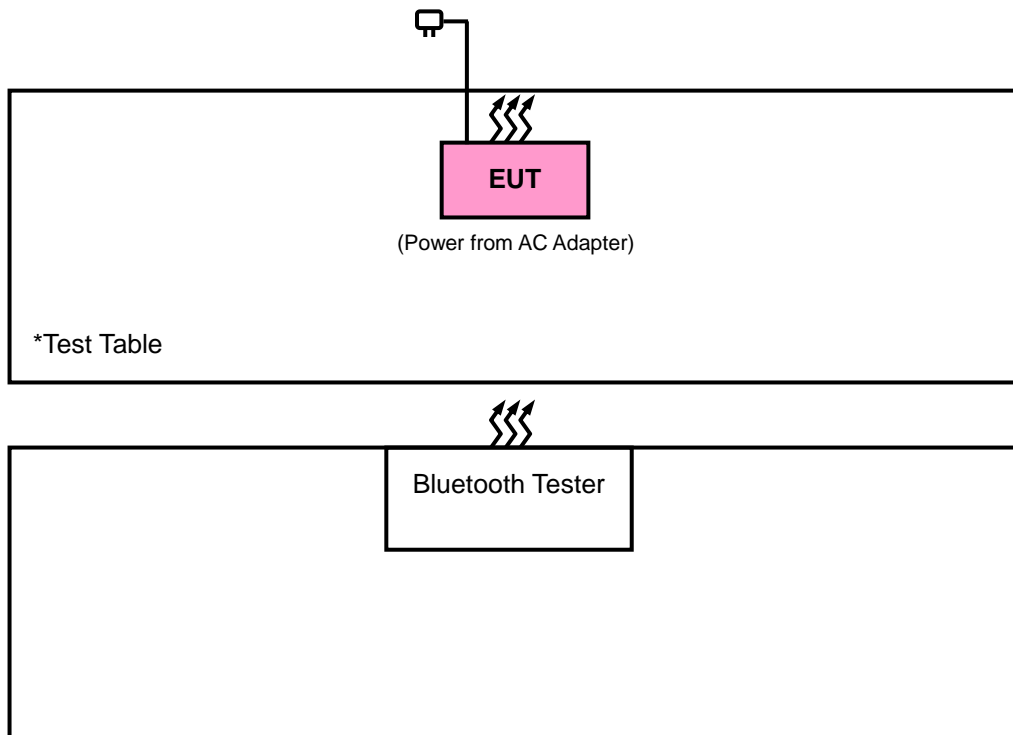



### **3.4 GENERAL DESCRIPTION OF APPLIED STANDARDS**

The EUT is a RF Product. According to the specifications of the manufacturer, it must comply with the requirements of the following standards:

**FCC Part 15, Subpart C (15.247)**

**ANSI C63.10-2013**

**FCC Public Notice DA 00-705**

All test items have been performed and recorded as per the above standards.

**NOTE:** The EUT has been verified to comply with the requirements of FCC Part 15, Subpart B, Class B (DoC). The test report has been issued separately.

## 4. TEST TYPES AND RESULTS (FOR BLUETOOTH EDR)

### 4.1 RADIATED EMISSION AND BANDEDGE MEASUREMENT

#### 4.1.1 LIMITS OF RADIATED EMISSION AND BANDEDGE MEASUREMENT

Radiated emissions which fall in the restricted bands must comply with the radiated emission limits specified as below table. Other emissions shall be at least 20dB below the highest level of the desired power:

FREQUENCIES (MHz)	FIELD STRENGTH (microvolts/meter)	MEASUREMENT DISTANCE (meters)
0.009 ~ 0.490	2400/F(kHz)	300
0.490 ~ 1.705	24000/F(kHz)	30
1.705 ~ 30.0	30	30
30 ~ 88	100	3
88 ~ 216	150	3
216 ~ 960	200	3
Above 960	500	3

**NOTE:**

1. The lower limit shall apply at the transition frequencies.
2. Emission level (dBuV/m) = 20 log Emission level (uV/m).
3. For frequencies above 1000MHz, the field strength limits are based on average detector, however, the peak field strength of any emission shall not exceed the maximum permitted average limits, specified above by more than 20dB under any condition of modulation.



**4.1.2 TEST INSTRUMENTS**

DESCRIPTION & MANUFACTURER	MODEL NO.	SERIAL NO.	DATE OF CALIBRATION	DUE DATE OF CALIBRATION
Test Receiver Agilent	N9038A	MY51210203	Jan.21, 2015	Jan.21, 2016
Spectrum Analyzer Agilent	N9010A	MY52220314	Sep.03, 2014	Sep.02, 2015
Spectrum Analyzer ROHDE & SCHWARZ	FSU43	101261	Dec. 10, 2014	Dec. 09, 2015
BILOG Antenna SCHWARZBECK	VULB9168	9168-472	Feb. 04, 2015	Feb. 04, 2016
HORN Antenna SCHWARZBECK	BBHA 9120 D	9120D-969	Feb. 09, 2015	Feb. 09, 2016
HORN Antenna SCHWARZBECK	BBHA 9170	9170-480	Feb. 04, 2015	Feb. 04, 2016
Preamplifier EMCI	EMC 012645	980115	Dec. 12, 2014	Dec. 11, 2015
Preamplifier EMCI	EMC 184045	980116	Jan. 09, 2015	Jan. 08, 2016
Preamplifier EMCI	EMC 330H	980112	Dec. 27, 2014	Dec. 26, 2015
RF signal cable HUBER+SUHNNER	SUCOFLEX 104	309219/4 2950114	Oct. 18, 2014	Oct. 17, 2015
RF signal cable HUBER+SUHNNER	SUCOFLEX 104	250130/4	Oct. 18, 2014	Oct. 17, 2015
RF signal cable Worken	RG-213	NA	Nov. 07, 2014	Nov. 06, 2015
Software BV ADT	E3 6.120103	NA	NA	NA
Antenna Tower MF	MFA-440H	NA	NA	NA
Turn Table MF	MFT-201SS	NA	NA	NA
Antenna Tower & Turn Table Controller MF	MF-7802	NA	NA	NA
Bluetooth Tester	CBT	100870	Jan. 28, 2015	Jan. 27, 2016
Power Meter	ML2495A	1232002	Sep. 17, 2014	Sep. 16, 2015
Power Sensor	MA2411B	1207325	Sep. 17, 2014	Sep. 16, 2015

- NOTE:**
1. The calibration interval of the above test instruments is 12 months and the calibrations are traceable to NML/ROC and NIST/USA.
  2. The calibration interval of the loop antenna is 24 months and the calibrations are traceable to NML/ROC and NIST/USA.
  3. The test was performed in HwaYa Chamber 10.
  4. The horn antenna and HP preamplifier (model: 8449B) are used only for the measurement of emission frequency above 1GHz if tested.
  5. The FCC Site Registration No. is 690701.
  6. The IC Site Registration No. is IC 7450F-10.

#### 4.1.3 TEST PROCEDURES

- a. The EUT was placed on the top of a rotating table 0.8 meters (for below 1GHz) / 1.5 meters (for above 1GHz) above the ground at 3 meter chamber room for test. The table was rotated 360 degrees to determine the position of the highest radiation.
- b. The EUT was set 3 meters away from the interference-receiving antenna, which was mounted on the top of a variable-height antenna tower.
- c. The antenna is a broadband antenna, and its height is varied from one meter to four meters above the ground to determine the maximum value of the field strength. Both horizontal and vertical polarizations of the antenna are set to make the measurement.
- d. For each suspected emission, the EUT was arranged to its worst case and then the antenna was tuned to heights from 1 meter to 4 meters and the rotatable table was turned from 0 degrees to 360 degrees to find the maximum reading.
- e. The test-receiver system was set to Peak Detect Function and Specified Bandwidth with Maximum Hold Mode.
- f. If the emission level of the EUT in peak mode was lower than the limit specified, then testing could be stopped and the peak values of the EUT would be reported. Otherwise the emissions would be re-tested one by one using peak, quasi-peak or average method as specified and then reported in a data sheet.

#### NOTE:

1. The resolution bandwidth and video bandwidth of test receiver/spectrum analyzer is 120kHz for Quasi-peak detection at frequency below 1GHz.
2. The resolution bandwidth of test receiver/spectrum analyzer is 1MHz and video bandwidth is 3MHz for Peak detection at frequency above 1GHz.
3. The resolution bandwidth of test receiver/spectrum analyzer is 1MHz and the video bandwidth is 10Hz for Average detection (AV) at frequency above 1GHz.

#### 4.1.4 DEVIATION FROM TEST STANDARD

No deviation.

### 4.1.5 TEST SETUP

<Frequency Range 30MHz ~ 1GHz>

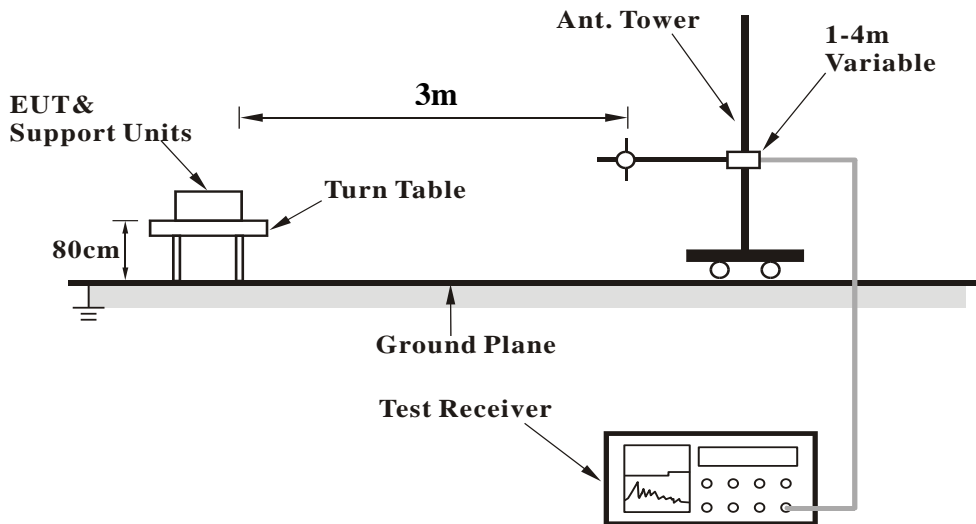

<Frequency Range above 1GHz>

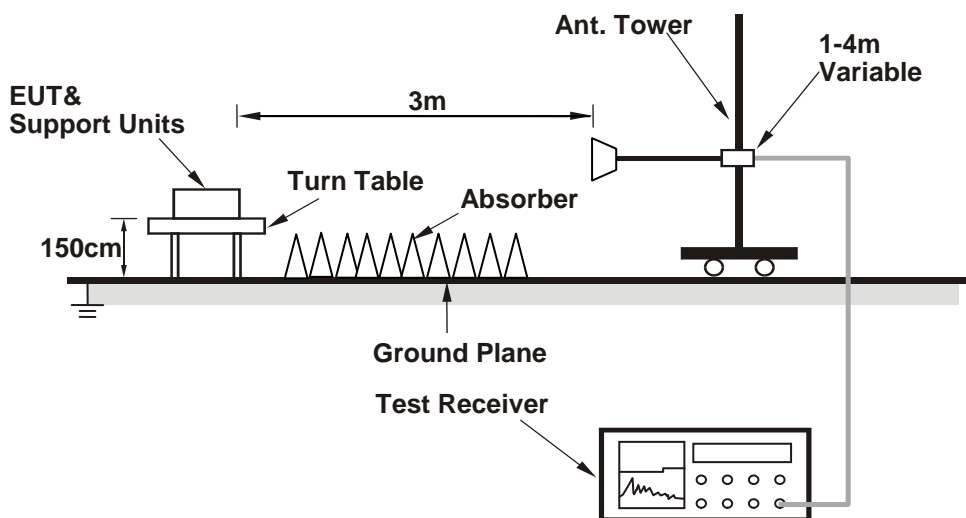

For the actual test configuration, please refer to the attached file (Test Setup Photo).

### 4.1.6 EUT OPERATING CONDITIONS

- a. Placed the EUT on a testing table.
- b. Use the software to control the EUT under transmission condition continuously at specific channel frequency.





A D T

### 4.1.7 TEST RESULTS

#### ABOVE 1GHz WORST-CASE DATA

#### GFSK

EUT TEST CONDITION		MEASUREMENT DETAIL	
CHANNEL	Channel 0	FREQUENCY RANGE	1GHz ~ 25GHz
INPUT POWER	120Vac, 60 Hz	DETECTOR FUNCTION	Peak (PK) Average (AV)
ENVIRONMENTAL CONDITIONS	25deg. C, 65%RH	TESTED BY	Gavin Wu

ANTENNA POLARITY & TEST DISTANCE: HORIZONTAL AT 3 M										
FREQ. (MHz)	EMISSION LEVEL (dBuV/m)	READ LEVEL (dBuV)	LIMIT (dBuV/m)	MARGIN (dB)	ANTENNA FACTOR (dB/m)	CABLE LOSS (dB)	PREAMP FACTOR (dB)	ANTENNA HEIGHT (cm)	TABLE ANGLE (Degree)	REMARK
2370	33.51	40.08	54	-20.49	26.86	4.07	37.5	164	195	Average
2370	56.46	63.03	74	-17.54	26.86	4.07	37.5	164	195	Peak
2402	89.79	96.31			26.91	4.09	37.52	164	195	Average
2402	101.83	108.35			26.91	4.09	37.52	164	195	Peak
2500	33.75	39.64	54	-20.25	27.2	4.16	37.25	164	195	Average
2500	56.94	62.83	74	-17.06	27.2	4.16	37.25	164	195	Peak
ANTENNA POLARITY & TEST DISTANCE: VERTICAL AT 3 M										
FREQ. (MHz)	EMISSION LEVEL (dBuV/m)	READ LEVEL (dBuV)	LIMIT (dBuV/m)	MARGIN (dB)	ANTENNA FACTOR (dB/m)	CABLE LOSS (dB)	PREAMP FACTOR (dB)	ANTENNA HEIGHT (cm)	TABLE ANGLE (Degree)	REMARK
2362	33.49	40.12	54	-20.51	26.81	4.05	37.49	133	173	Average
2362	57.92	64.55	74	-16.08	26.81	4.05	37.49	133	173	Peak
2402	91.09	97.61			26.91	4.09	37.52	133	173	Average
2402	103.21	109.73			26.91	4.09	37.52	133	173	Peak
2486	33.7	39.72	54	-20.3	27.15	4.15	37.32	133	173	Average
2486	56.93	62.95	74	-17.07	27.15	4.15	37.32	133	173	Peak

#### REMARKS:

- Emission Level = Read Level + Antenna Factor + Cable Loss - Preamp Factor  
Margin value = Emission level – Limit value
- 2402MHz: Fundamental frequency.



A D T

EUT TEST CONDITION		MEASUREMENT DETAIL	
CHANNEL	Channel 39	FREQUENCY RANGE	1GHz ~ 25GHz
INPUT POWER	120Vac, 60 Hz	DETECTOR FUNCTION	Peak (PK) Average (AV)
ENVIRONMENTAL CONDITIONS	25deg. C, 65%RH	TESTED BY	Gavin Wu

ANTENNA POLARITY & TEST DISTANCE: HORIZONTAL AT 3 M										
FREQ. (MHz)	EMISSION LEVEL (dBuV/m)	READ LEVEL (dBuV)	LIMIT (dBuV/m)	MARGIN (dB)	ANTENNA FACTOR (dB/m)	CABLE LOSS (dB)	PREAMP FACTOR (dB)	ANTENNA HEIGHT (cm)	TABLE ANGLE (Degree)	REMARK
2348	33.06	39.73	54	-20.94	26.77	4.05	37.49	179	213	Average
2348	57.4	64.07	74	-16.6	26.77	4.05	37.49	179	213	Peak
2441	89.49	95.7			27.06	4.12	37.39	179	213	Average
2441	101.6	107.81			27.06	4.12	37.39	179	213	Peak
2494	33.72	39.61	54	-20.28	27.2	4.16	37.25	179	213	Average
2494	57.8	63.69	74	-16.2	27.2	4.16	37.25	179	213	Peak

ANTENNA POLARITY & TEST DISTANCE: VERTICAL AT 3 M										
FREQ. (MHz)	EMISSION LEVEL (dBuV/m)	READ LEVEL (dBuV)	LIMIT (dBuV/m)	MARGIN (dB)	ANTENNA FACTOR (dB/m)	CABLE LOSS (dB)	PREAMP FACTOR (dB)	ANTENNA HEIGHT (cm)	TABLE ANGLE (Degree)	REMARK
2330	33.31	40.02	54	-20.69	26.72	4.04	37.47	133	154	Average
2330	57.13	63.84	74	-16.87	26.72	4.04	37.47	133	154	Peak
2441	90.97	97.18			27.06	4.12	37.39	133	154	Average
2441	102.93	109.14			27.06	4.12	37.39	133	154	Peak
2496	33.76	39.65	54	-20.24	27.2	4.16	37.25	133	154	Average
2496	57.17	63.06	74	-16.83	27.2	4.16	37.25	133	154	Peak

**REMARKS:**

- Emission Level = Read Level + Antenna Factor + Cable Loss - Preamp Factor  
Margin value = Emission level – Limit value
- 2441MHz: Fundamental frequency.



A D T

EUT TEST CONDITION		MEASUREMENT DETAIL	
CHANNEL	Channel 78	FREQUENCY RANGE	1GHz ~ 25GHz
INPUT POWER	120Vac, 60 Hz	DETECTOR FUNCTION	Peak (PK) Average (AV)
ENVIRONMENTAL CONDITIONS	25deg. C, 65%RH	TESTED BY	Gavin Wu

ANTENNA POLARITY & TEST DISTANCE: HORIZONTAL AT 3 M										
FREQ. (MHz)	EMISSION LEVEL (dBuV/m)	READ LEVEL (dBuV)	LIMIT (dBuV/m)	MARGIN (dB)	ANTENNA FACTOR (dB/m)	CABLE LOSS (dB)	PREAMP FACTOR (dB)	ANTENNA HEIGHT (cm)	TABLE ANGLE (Degree)	REMARK
2332	32.98	39.69	54	-21.02	26.72	4.04	37.47	178	204	Average
2332	56.62	63.33	74	-17.38	26.72	4.04	37.47	178	204	Peak
2480	89.13	95.15			27.15	4.15	37.32	178	204	Average
2480	101.08	107.1			27.15	4.15	37.32	178	204	Peak
2496	34.89	40.78	54	-19.11	27.2	4.16	37.25	178	204	Average
2496	57.24	63.13	74	-16.76	27.2	4.16	37.25	178	204	Peak

ANTENNA POLARITY & TEST DISTANCE: VERTICAL AT 3 M										
FREQ. (MHz)	EMISSION LEVEL (dBuV/m)	READ LEVEL (dBuV)	LIMIT (dBuV/m)	MARGIN (dB)	ANTENNA FACTOR (dB/m)	CABLE LOSS (dB)	PREAMP FACTOR (dB)	ANTENNA HEIGHT (cm)	TABLE ANGLE (Degree)	REMARK
2364	33.1	39.71	54	-20.9	26.81	4.07	37.49	130	166	Average
2364	56.68	63.29	74	-17.32	26.81	4.07	37.49	130	166	Peak
2480	90.76	96.78			27.15	4.15	37.32	130	166	Average
2480	102.74	108.76			27.15	4.15	37.32	130	166	Peak
2500	35.12	41.01	54	-18.88	27.2	4.16	37.25	130	166	Average
2500	56.44	62.33	74	-17.56	27.2	4.16	37.25	130	166	Peak

**REMARKS:**

- Emission Level = Read Level + Antenna Factor + Cable Loss - Preamp Factor  
Margin value = Emission level – Limit value
- 2480MHz: Fundamental frequency.



A D T

**BELOW 1GHz WORST-CASE DATA:**

EUT TEST CONDITION		MEASUREMENT DETAIL	
CHANNEL	Channel 0	FREQUENCY RANGE	30MHz ~ 1GHz
INPUT POWER	120Vac, 60 Hz	DETECTOR FUNCTION	Peak (PK) Quasi-peak (QP)
ENVIRONMENTAL CONDITIONS	25deg. C, 65%RH	TESTED BY	Gavin Wu

ANTENNA POLARITY & TEST DISTANCE: HORIZONTAL AT 3 M										
FREQ. (MHz)	EMISSION LEVEL (dBuV/m)	READ LEVEL (dBuV)	LIMIT (dBuV/m)	MARGIN (dB)	ANTENNA FACTOR (dB/m)	CABLE LOSS (dB)	PREAMP FACTOR (dB)	ANTENNA HEIGHT (cm)	TABLE ANGLE (Degree)	REMARK
33.88	31.95	49.8	40	-8.05	12.63	0.6	31.08	102	21	Peak
39.7	29.31	46.12	40	-10.69	13.54	0.64	30.99	123	151	Peak
94.99	23.42	45.68	43.5	-20.08	8.68	1.02	31.96	123	232	Peak
301.6	27.08	44.31	46	-18.92	12.99	1.64	31.86	130	294	Peak
513.06	32.93	44.77	46	-13.07	17.62	2.12	31.58	134	342	Peak
556.71	31.77	43	46	-14.23	18.61	2.19	32.03	105	152	Peak
ANTENNA POLARITY & TEST DISTANCE: VERTICAL AT 3 M										
FREQ. (MHz)	EMISSION LEVEL (dBuV/m)	READ LEVEL (dBuV)	LIMIT (dBuV/m)	MARGIN (dB)	ANTENNA FACTOR (dB/m)	CABLE LOSS (dB)	PREAMP FACTOR (dB)	ANTENNA HEIGHT (cm)	TABLE ANGLE (Degree)	REMARK
31.94	38.33	56.55	40	-1.67	12.3	0.59	31.11	100	185	QP
39.7	38.02	54.83	40	-1.98	13.54	0.64	30.99	100	50	QP
64.92	25.05	44.45	40	-14.95	11.35	0.84	31.59	137	233	Peak
119.24	24.03	43.84	43.5	-19.47	10.93	1.15	31.89	103	16	Peak
490.75	37.68	50.22	46	-8.32	17.14	2.08	31.76	107	294	Peak
513.06	40.77	52.61	46	-5.23	17.62	2.12	31.58	132	10	Peak

**REMARKS:** Emission Level = Read Level + Antenna Factor + Cable Loss - Preamp Factor  
Margin value = Emission level – Limit value

## 4.2 CONDUCTED EMISSION MEASUREMENT

### 4.2.1 LIMITS OF CONDUCTED EMISSION MEASUREMENT

FREQUENCY OF EMISSION (MHz)	CONDUCTED LIMIT (dB $\mu$ V)	
	Quasi-peak	Average
0.15 ~ 0.5	66 to 56	56 to 46
0.5 ~ 5	56	46
5 ~ 30	60	50

- NOTE:**
1. The lower limit shall apply at the transition frequencies.
  2. The limit decreases in line with the logarithm of the frequency in the range of 0.15 to 0.50MHz.
  3. All emanations from a class A/B digital device or system, including any network of conductors and apparatus connected thereto, shall not exceed the level of field strengths specified above.

### 4.2.2 TEST INSTRUMENTS

DESCRIPTION & MANUFACTURER	MODEL NO.	SERIAL NO.	DATE OF CALIBRATION	DUE DATE OF CALIBRATION
Test Receiver ROHDE & SCHWARZ	ESCI	100613	Nov. 11, 2014	Nov. 10, 2015
RF signal cable Woken	5D-FB	Cable-HYC01-01	Dec. 26, 2014	Dec. 25, 2015
LISN ROHDE & SCHWARZ (EUT)	ESH3-Z5	835239/001	Feb. 26, 2015	Feb. 25, 2016
LISN ROHDE & SCHWARZ (Peripheral)	ESH3-Z5	100311	Jul. 24, 2015	Jul. 23, 2016
Software ADT	BV ADT_Cond_ V7.3.7.3	NA	NA	NA

- NOTE:**
1. The calibration interval of the above test instruments is 12 months and the calibrations are traceable to NML/ROC and NIST/USA.
  2. The test was performed in HwaYa Shielded Room 1.
  3. The VCCI Site Registration No. is C-2040.

#### 4.2.3 TEST PROCEDURES

- a. The EUT was placed 0.4 meters from the conducting wall of the shielded room with EUT being connected to the power mains through a line impedance stabilization network (LISN). Other support units were connected to the power mains through another LISN. The two LISNs provide 50 ohm/ 50uH of coupling impedance for the measuring instrument.
- b. Both lines of the power mains connected to the EUT were checked for maximum conducted interference.
- c. The frequency range from 150kHz to 30MHz was searched. Emission levels under (Limit - 20dB) was not recorded.

**NOTE:** All modes of operation were investigated and the worst-case emissions are reported.

#### 4.2.4 DEVIATION FROM TEST STANDARD

No deviation.

#### 4.2.5 TEST SETUP

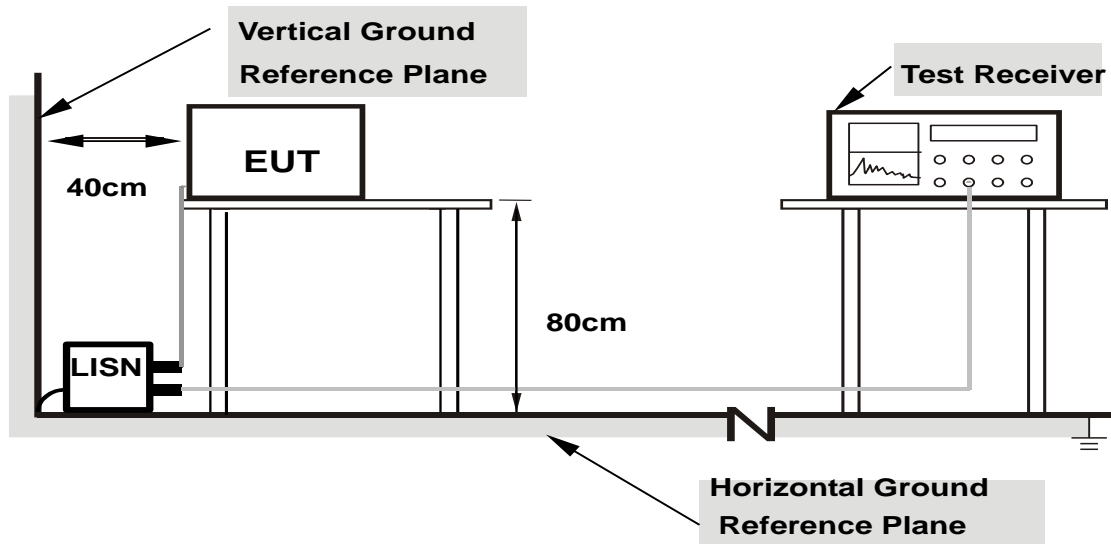

- Note:**
1. Support units were connected to second LISN.
  2. Both of LISNs (AMN) are 80 cm from EUT and at least 80 from other units and other metal planes

For the actual test configuration, please refer to the attached file (Test Setup Photo).

#### 4.2.6 EUT OPERATING CONDITIONS

Same as section 4.1.6.

#### 4.2.7 TEST RESULTS

##### CONDUCTED WORST-CASE DATA :

Frequency Range	150kHz ~ 30MHz	Detector Function & Resolution Bandwidth	Quasi-Peak (QP) / Average (AV), 9kHz
Input Power	120Vac, 60Hz	Environmental Conditions	25°C, 65%RH
Tested by	Toby Tian	Test Date	2015/8/15

Phase Of Power : Line (L)										
No	Frequency (MHz)	Correction Factor (dB)	Reading Value (dBuV)		Emission Level (dBuV)		Limit (dBuV)		Margin (dB)	
			Q.P.	AV.	Q.P.	AV.	Q.P.	AV.	Q.P.	AV.
1	0.15391	0.05	48.73	34.49	48.78	34.54	65.79	55.79	-17.01	-21.25
2	0.17651	0.06	47.76	34.78	47.82	34.84	64.65	54.65	-16.83	-19.81
3	0.20474	0.06	44.56	28.79	44.62	28.85	63.42	53.42	-18.80	-24.57
4	17.96787	0.81	44.37	33.20	45.18	34.01	60.00	50.00	-14.82	-15.99
5	20.53283	0.91	43.55	32.91	44.46	33.82	60.00	50.00	-15.54	-16.18
6	23.09779	0.99	41.38	30.17	42.37	31.16	60.00	50.00	-17.63	-18.84

##### Remarks:

1. Q.P. and AV. are abbreviations of quasi-peak and average individually.
2. The emission levels of other frequencies were very low against the limit.
3. Margin value = Emission level – Limit value
4. Correction factor = Insertion loss + Cable loss
5. Emission Level = Correction Factor + Reading Value

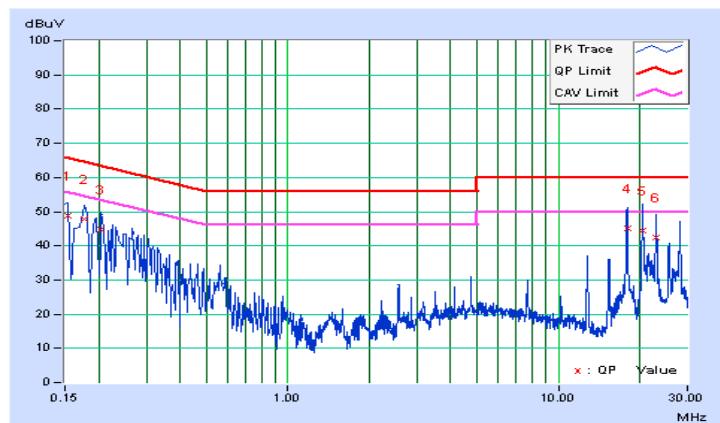





A D T

Frequency Range	150kHz ~ 30MHz	Detector Function & Resolution Bandwidth	Quasi-Peak (QP) / Average (AV), 9kHz
Input Power	120Vac, 60Hz	Environmental Conditions	25°C, 65%RH
Tested by	Toby Tian	Test Date	2015/8/15

Phase Of Power : Neutral (N)										
No	Frequency (MHz)	Correction Factor (dB)	Reading Value (dBuV)		Emission Level (dBuV)		Limit (dBuV)		Margin (dB)	
			Q.P.	AV.	Q.P.	AV.	Q.P.	AV.	Q.P.	AV.
1	0.15000	0.05	50.28	37.51	50.33	37.56	66.00	56.00	-15.67	-18.44
2	0.17237	0.05	48.15	33.97	48.20	34.02	64.85	54.85	-16.65	-20.83
3	0.20083	0.05	45.46	31.96	45.51	32.01	63.58	53.58	-18.07	-21.57
<b>4</b>	<b>17.88967</b>	<b>0.66</b>	<b>46.75</b>	<b>37.79</b>	<b>47.41</b>	<b>38.45</b>	<b>60.00</b>	<b>50.00</b>	<b>-12.59</b>	<b>-11.55</b>
5	20.44681	0.74	47.05	37.58	47.79	38.32	60.00	50.00	-12.21	-11.68
6	23.00395	0.77	42.45	33.21	43.22	33.98	60.00	50.00	-16.78	-16.02

Remarks:

1. Q.P. and AV. are abbreviations of quasi-peak and average individually.
2. The emission levels of other frequencies were very low against the limit.
3. Margin value = Emission level – Limit value
4. Correction factor = Insertion loss + Cable loss
5. Emission Level = Correction Factor + Reading Value

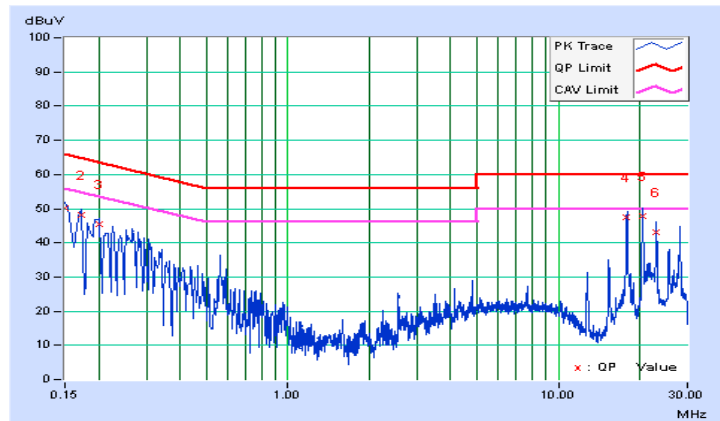

### 4.3 NUMBER OF HOPPING FREQUENCY USED

#### 4.3.1 LIMIT OF HOPPING FREQUENCY USED

At least 15 channels frequencies, and should be equally spaced.

#### 4.3.2 TEST SETUP

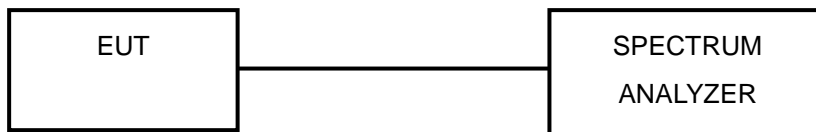

#### 4.3.3 TEST INSTRUMENTS

Refer to section 4.1.2 to get information of above instrument.

#### 4.3.4 TEST PROCEDURE

- Check the calibration of the measuring instrument (SA) using either an internal calibrator or a known signal from an external generator.
- Turn on the EUT and connect its antenna terminal to measurement via a low loss cable. Then set it to any one measured frequency within its operating range and make sure the instrument is operated in its linear range.
- Set the SA on MaxHold Mode, and then keep the EUT in hopping mode. Record all the signals from each channel until each one has been recorded.
- Set the SA on View mode and then plot the result on SA screen.
- Repeat above procedures until all frequencies measured were complete.

#### 4.3.5 DEVIATION FROM TEST STANDARD

No deviation.

#### 4.3.6 TEST RESULTS

There are 79 hopping frequencies in the hopping mode. Please refer to next page for the test result. On the plot, it shows that the hopping frequencies are equally spaced.



A D T

# GFSK

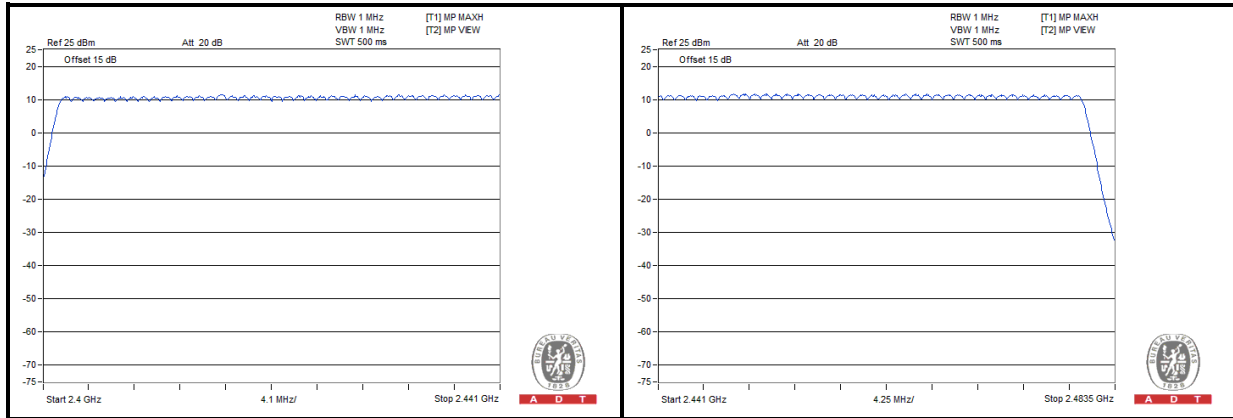

## 4.4 DWELL TIME ON EACH CHANNEL

### 4.4.1 LIMITS OF DWELL TIME USED

The average time of occupancy on any channel shall not be greater than 0.4 seconds within a period of 0.4 seconds multiplied by the number of hopping channels employed.

### 4.4.2 TEST SETUP

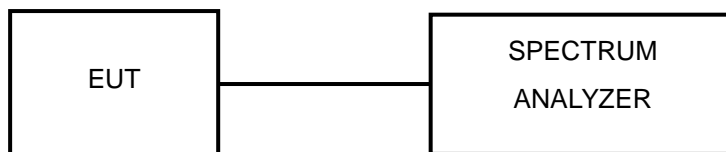

### 4.4.3 TEST INSTRUMENTS

Refer to section 4.1.2 to get information of above instrument.

### 4.4.4 TEST PROCEDURES

- a. Check the calibration of the measuring instrument (SA) using either an internal calibrator or a known signal from an external generator.
- b. Turn on the EUT and connect its antenna terminal to measurement via a low loss cable. Then set it to any one measured frequency within its operating range and make sure the instrument is operated in its linear range.
- c. Adjust the center frequency of SA on any frequency be measured and set SA to zero span mode. And then, set RBW and VBW of spectrum analyzer to proper value.
- d. Measure the time duration of one transmission on the measured frequency. And then plot the result with time difference of this time duration.
- e. Repeat above procedures until all different time-slot modes have been completed.

### 4.4.5 DEVIATION FROM TEST STANDARD

No deviation.



A D T

### 4.4.6 TEST RESULTS

#### GFSK

Mode	Average Hopping Channel	Package Transfer Time (usec)	Result (sec)	Limit (sec)
DH1	10.00	438.00	0.14	0.4
DH3	5.20	1754.00	0.29	0.4
DH5	3.20	2940.00	0.30	0.4

#### NOTE:

1. Dwell Time=79(channels) x 0.4(s) x average hopping channel x package transfer time
2. 79 channels come from the Hopping Channel number
3. Average Hopping Channel = hops/sweep time
4. t: Package Transfer Time(us)
5. Test plots of the transmitting time slot are shown as below.

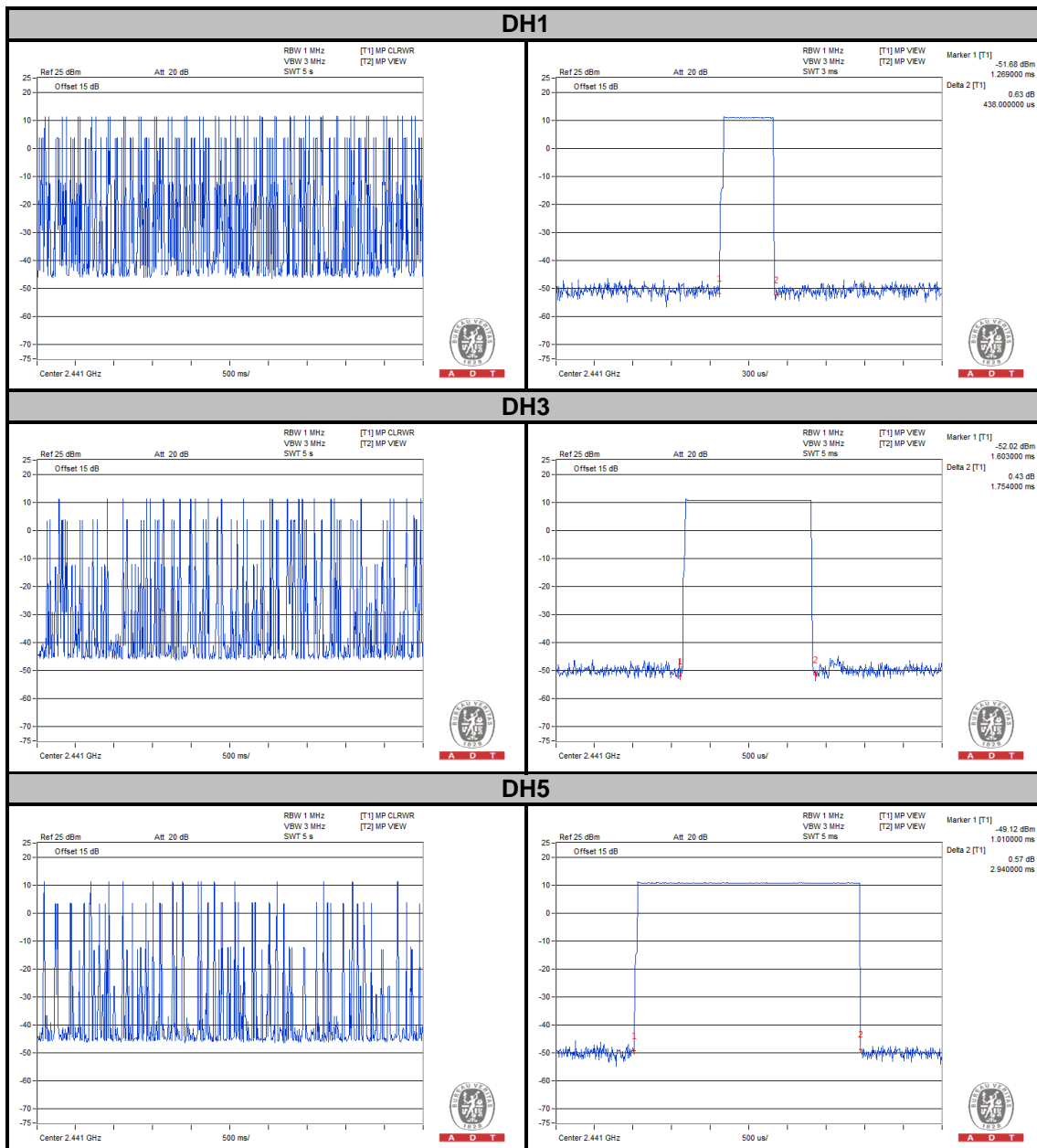



A D T

### $\pi/4$ -DQPSK

Mode	Average Hopping Channel	Package Transfer Time (usec)	Result (sec)	Limit (sec)
2DH1	10.20	438.00	0.14	0.4
2DH3	5.20	1738.00	0.29	0.4
2DH5	3.60	2948.00	0.34	0.4

#### NOTE:

1. Dwell Time=79(channels) x 0.4(s) x average hopping channel x package transfer time
2. 79 channels come from the Hopping Channel number
3. Average Hopping Channel = hops/sweep time
4. t: Package Transfer Time(us)
5. Test plots of the transmitting time slot are shown as below.





A D T

### 8DPSK

Mode	Average Hopping Channel	Package Transfer Time (usec)	Result (sec)	Limit (sec)
3DH1	10.40	452.00	0.15	0.4
3DH3	5.20	1698.00	0.28	0.4
3DH5	3.20	2957.00	0.30	0.4

#### NOTE:

1. Dwell Time=79(channels) x 0.4(s) x average hopping channel x package transfer time
2. 79 channels come from the Hopping Channel number
3. Average Hopping Channel = hops/sweep time
4. t: Package Transfer Time(us)
5. Test plots of the transmitting time slot are shown as below.



## 4.5 CHANNEL BANDWIDTH

### 4.5.1 LIMITS OF CHANNEL BANDWIDTH

For frequency hopping system operating in the 2400-2483.5MHz, If the 20dB bandwidth of hopping channel is greater than 25kHz, two-thirds 20dB bandwidth of hopping channel shall be a minimum limit for the hopping channel separation.

### 4.5.2 TEST SETUP

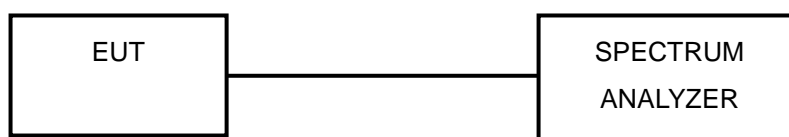

### 4.5.3 TEST INSTRUMENTS

Refer to section 4.1.2 to get information of above instrument.

### 4.5.4 TEST PROCEDURE

- a. Check the calibration of the measuring instrument using either an internal calibrator or a known signal from an external generator.
- b. Turn on the EUT and connect it to measurement instrument. Then set it to any one convenient frequency within its operating range. Set a reference level on the measuring instrument equal to the highest peak value.
- c. Measure the frequency difference of two frequencies that were attenuated 20dB from the reference level. Record the frequency difference as the emission bandwidth.
- d. Repeat above procedures until all frequencies measured were complete.

### 4.5.5 DEVIATION FROM TEST STANDARD

No deviation.

### 4.5.6 EUT OPERATING CONDITION

The software provided by client enabled the EUT to transmit and receive data at lowest, middle and highest channel frequencies individually.





A D T

### 4.5.7 TEST RESULTS

CHANNEL	FREQUENCY (MHz)	20dB BANDWIDTH (MHz)		
		GFSK	$\pi/4$ -DQPSK	8DPSK
0	2402	1.02	1.36	1.34
39	2441	1.05	1.36	1.34
78	2480	1.02	1.36	1.34



## 4.6 HOPPING CHANNEL SEPARATION

### 4.6.1 LIMITS OF HOPPING CHANNEL SEPARATION

At least 25kHz or two-third of 20dB hopping channel bandwidth (whichever is greater).

### 4.6.2 TEST SETUP

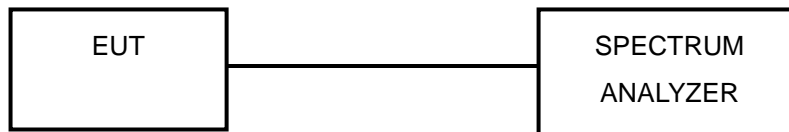

### 4.6.3 TEST INSTRUMENTS

Refer to section 4.1.2 to get information of above instrument.

### 4.6.4 TEST PROCEDURE

- a. Check the calibration of the measuring instrument using either an internal calibrator or a known signal from an external generator.
- b. Turn on the EUT and connect it to measurement instrument. Then set it to any one convenient frequency within its operating range.
- c. By using the MaxHold function record the separation of two adjacent channels.
- d. Measure the frequency difference of these two adjacent channels by SA MARK function. And then plot the result on SA screen.
- e. Repeat above procedures until all frequencies measured were complete.

### 4.6.5 DEVIATION FROM TEST STANDARD

No deviation.



A D T

### 4.6.6 TEST RESULTS

CHAN.	FREQ. (MHz)	ADJACENT CHANNEL SEPARATION (MHz)			20dB BANDWIDTH (MHz)			MINIMUM LIMIT (MHz)			PASS / FAIL
		GFSK	$\pi/4$ -DQPSK	8DPSK	GFSK	$\pi/4$ -DQPSK	8DPSK	GFSK	$\pi/4$ -DQPSK	8DPSK	
0	2402	1.10	1.00	1.00	1.02	1.36	1.34	0.680	0.907	0.893	PASS
39	2441	1.00	1.00	1.00	1.05	1.36	1.34	0.700	0.907	0.893	PASS
78	2480	1.00	1.00	1.00	1.02	1.36	1.34	0.680	0.907	0.893	PASS

**NOTE:**

- The minimum limit is two-third 20dB bandwidth.

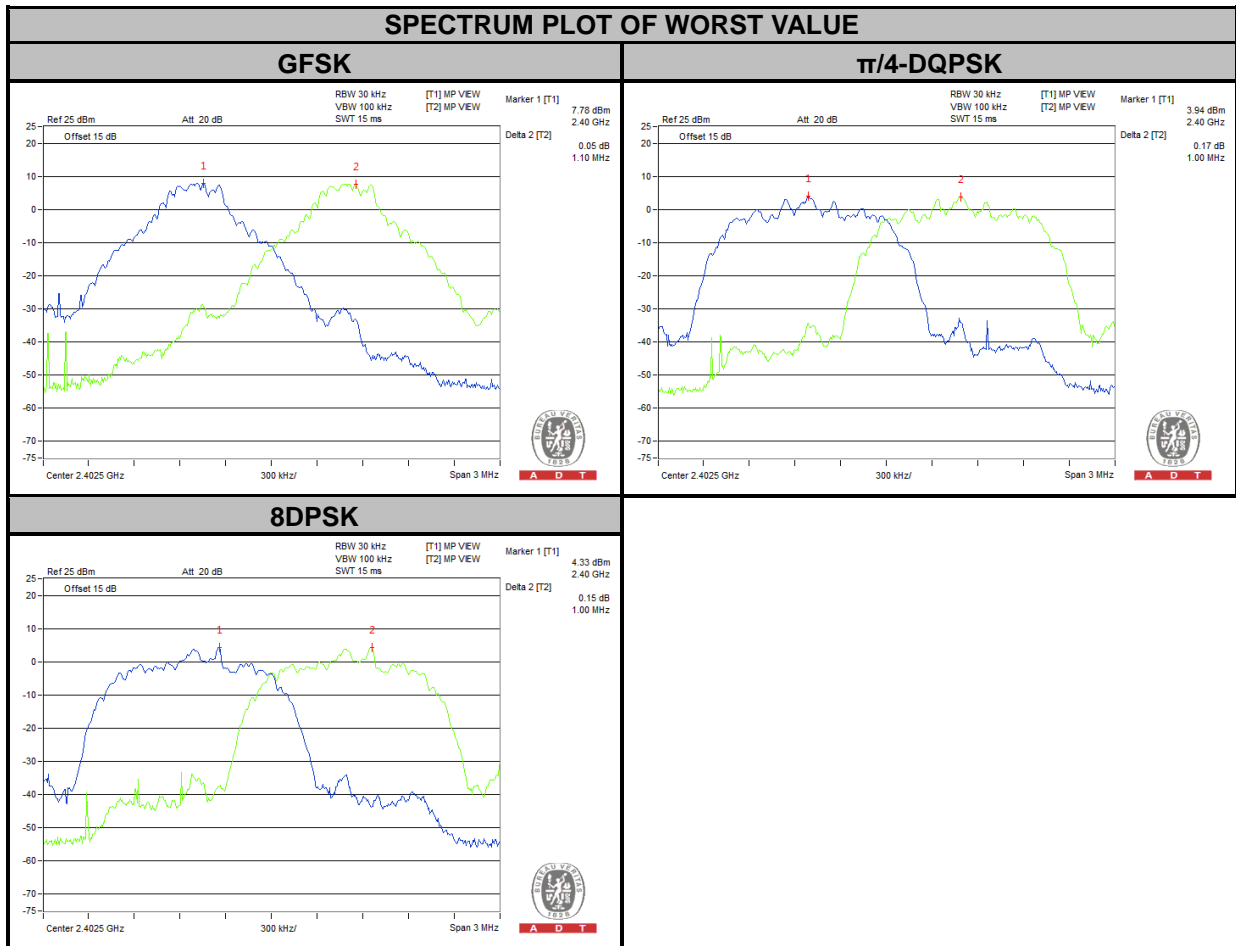

## 4.7 MAXIMUM OUTPUT POWER

### 4.7.1 LIMITS OF MAXIMUM OUTPUT POWER MEASUREMENT

The Maximum Output Power Measurement is 125mW.

### 4.7.2 TEST SETUP

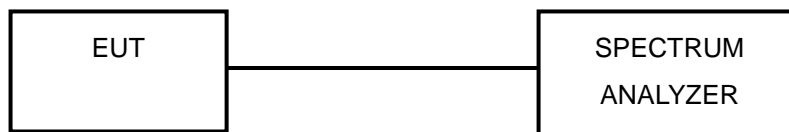

### 4.7.3 TEST INSTRUMENTS

Refer to section 4.1.2 to get information of above instrument.

### 4.7.4 TEST PROCEDURE

- Check the calibration of the measuring instrument using either an internal calibrator or a known signal from an external generator.
- Turn on the EUT and connect it to measurement instrument. Then set it to any one convenient frequency within its operating range. Set a reference level on the measuring instrument equal to the highest peak value.
- The center frequency of the spectrum analyzer is set to the fundamental frequency and using 3MHz RBW and 10 MHz VBW.
- Measure the captured power within the band and recording the plot.
- Repeat above procedures until all frequencies required were complete.

### 4.7.5 DEVIATION FROM TEST STANDARD

No deviation.

### 4.7.6 EUT OPERATING CONDITION

The software provided by client enabled the EUT to transmit and receive data at lowest, middle and highest channel frequencies individually.



A D T

### 4.7.7 TEST RESULTS

CHANNEL	FREQUENCY (MHz)	OUTPUT POWER (mW)			OUTPUT POWER (dBm)			POWER LIMIT (mW)	PASS / FAIL
		GFSK	$\pi/4$ -DQPSK	8DPSK	GFSK	$\pi/4$ -DQPSK	8DPSK		
0	2402	10.740	7.568	7.534	10.31	8.79	8.77	125	PASS
39	2441	11.561	7.261	7.430	10.63	8.61	8.71	125	PASS
78	2480	10.162	6.699	6.871	10.07	8.26	8.37	125	PASS

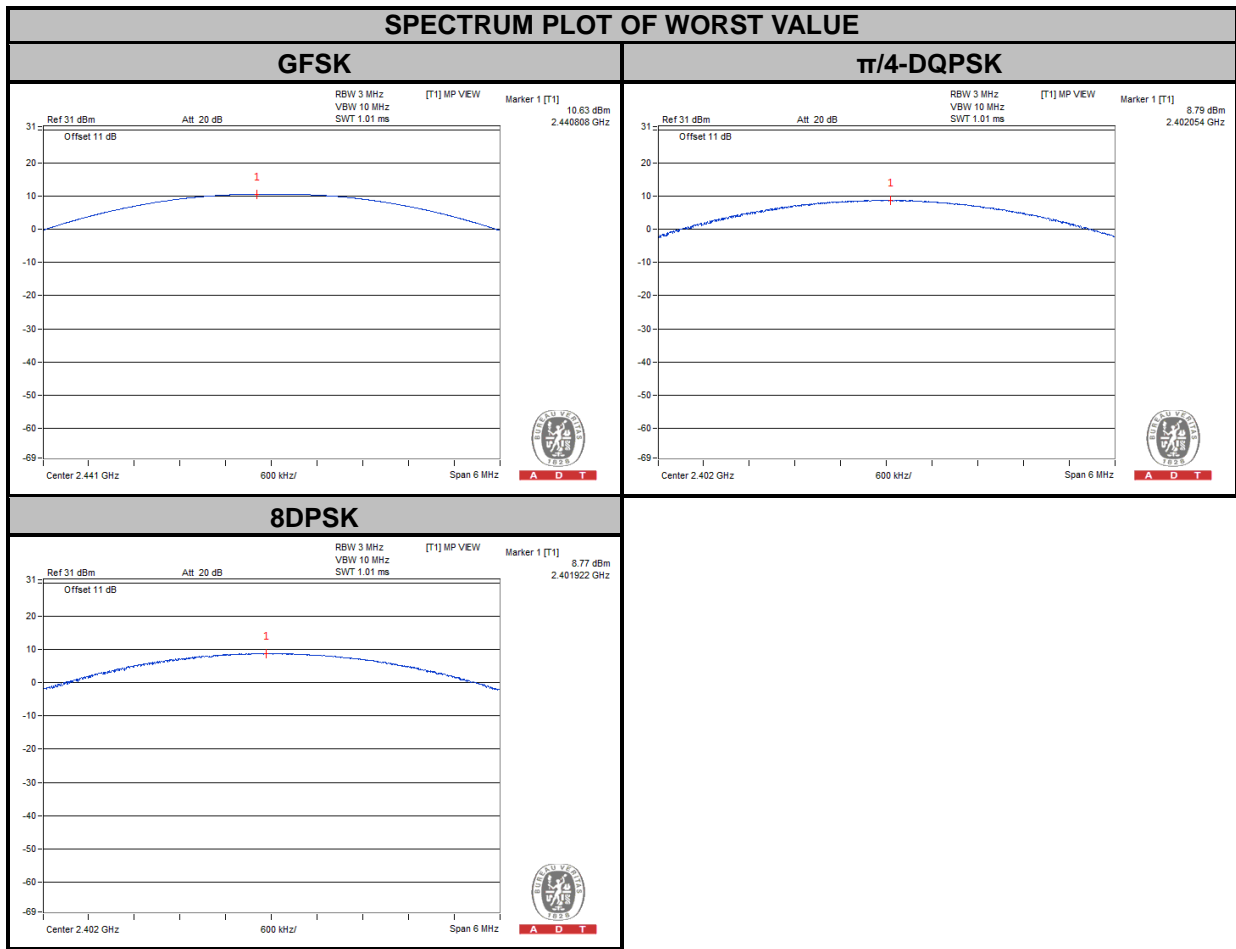

## **4.8 CONDUCTED OUT OF BAND EMISSION MEASUREMENT**

### **4.8.1 LIMITS OF CONDUCTED OUT OF BAND EMISSION MEASUREMENT**

Below  $-20\text{dB}$  of the highest emission level of operating band (in  $100\text{kHz}$  RBW).

### **4.8.2 TEST INSTRUMENTS**

Refer to section 4.1.2 to get information of above instrument.

### **4.8.3 TEST PROCEDURE**

1. Set RBW =  $100\text{ kHz}$ .
2. Set VBW =  $300\text{ kHz}$ .
3. Set span to encompass the spectrum to be examined.
4. Detector = peak.
5. Trace Mode = max hold.
6. Sweep = auto couple.

### **4.8.4 DEVIATION FROM TEST STANDARD**

No deviation.

### **4.8.5 EUT OPERATING CONDITION**

The software provided by client enabled the EUT to transmit continuously.

### **4.8.6 TEST RESULTS**

The spectrum plots are attached on the following images. D1 line indicates the highest level, D2 line indicates the  $20\text{dB}$  offset below D1. It shows compliance with the requirement.



A D T

### GFSK

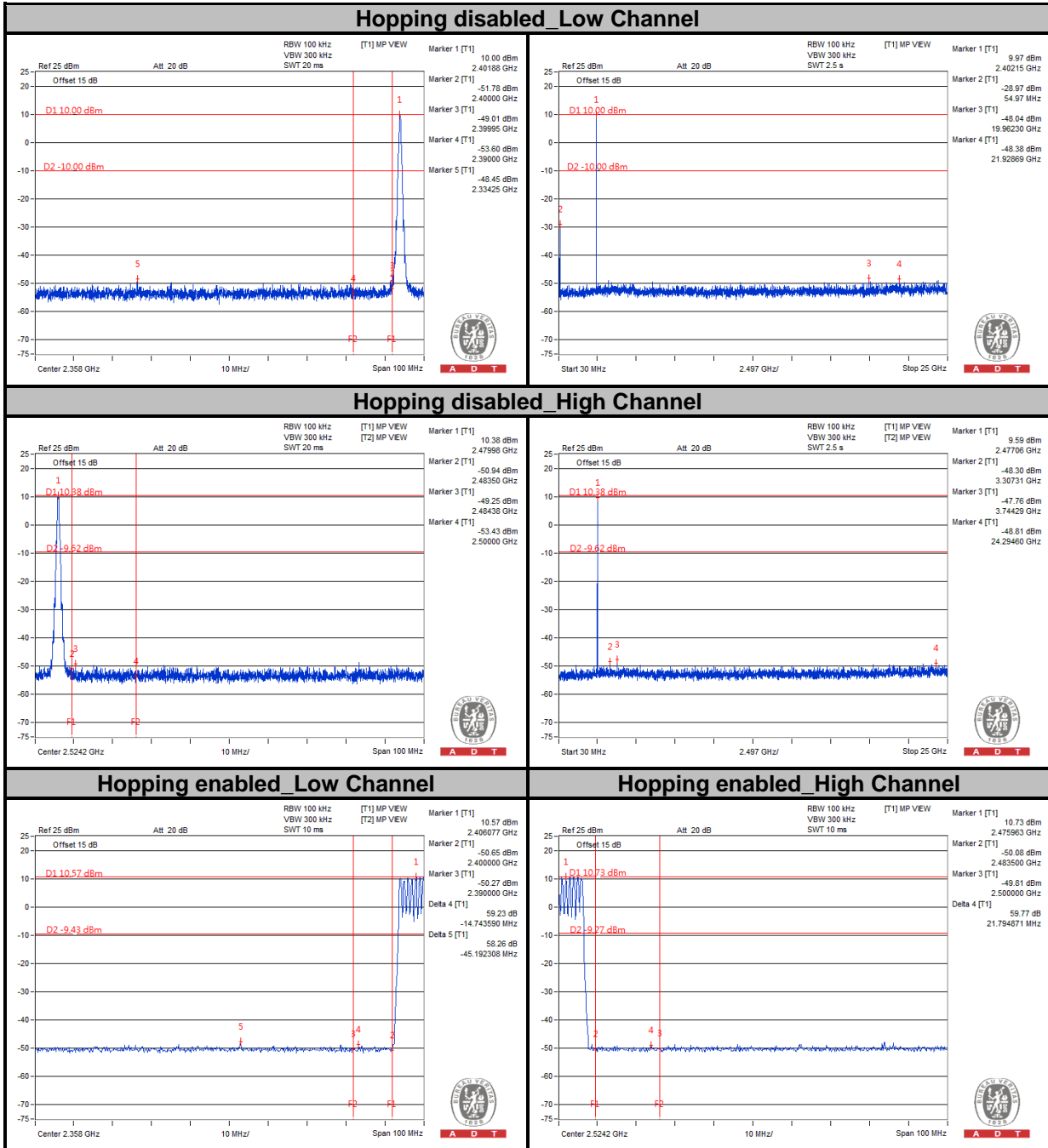



A D T

# $\pi/4$ -DQPSK

## Hopping disabled\_Low Channel

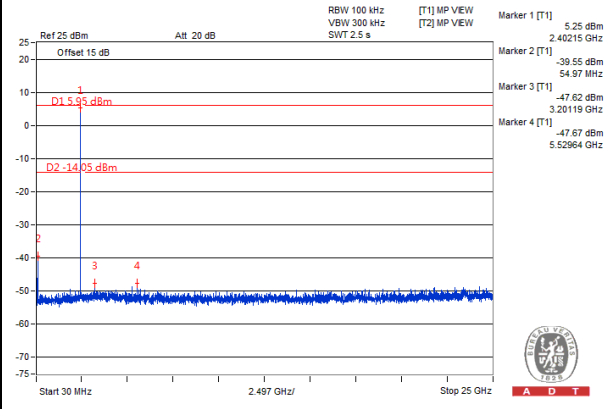
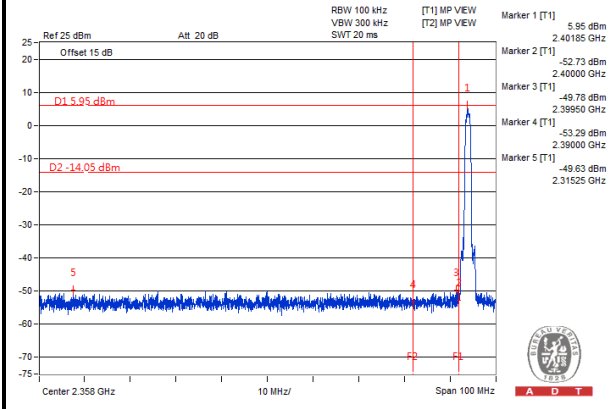

## Hopping disabled\_High Channel

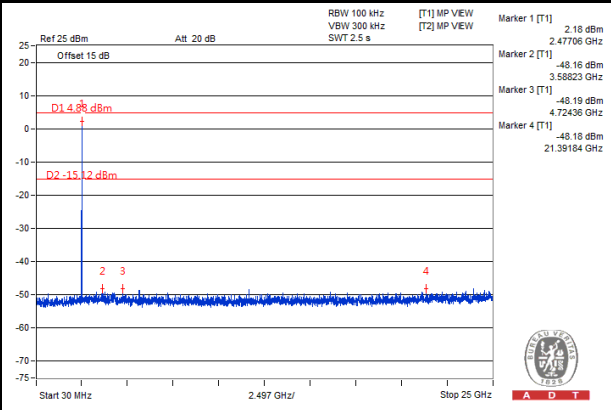
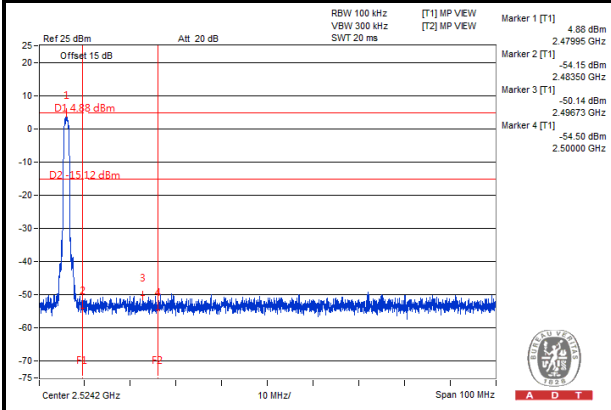

## Hopping enabled\_Low Channel

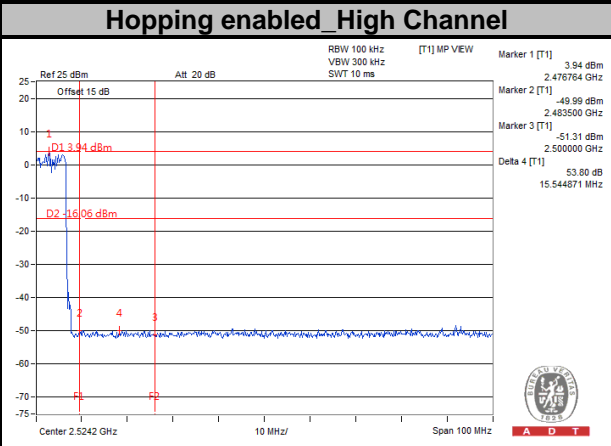
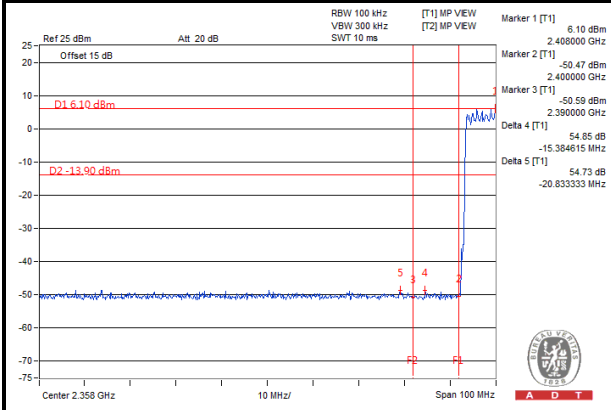





A D T

# 8DPSK

## Hopping disabled\_Low Channel

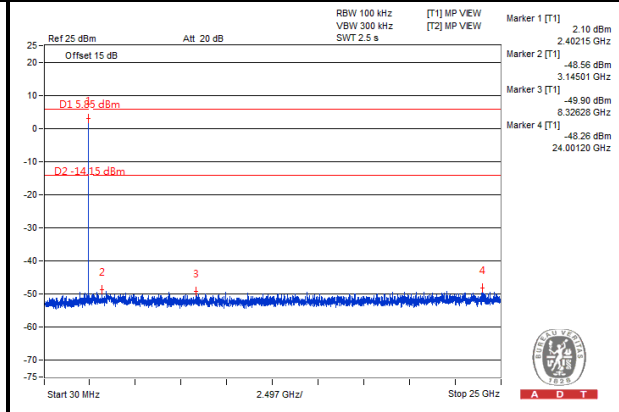
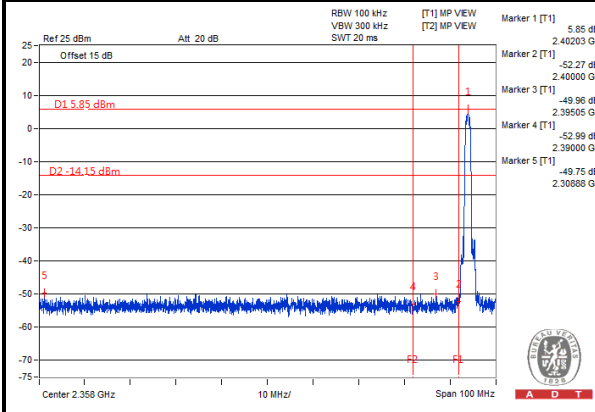

## Hopping disabled\_High Channel

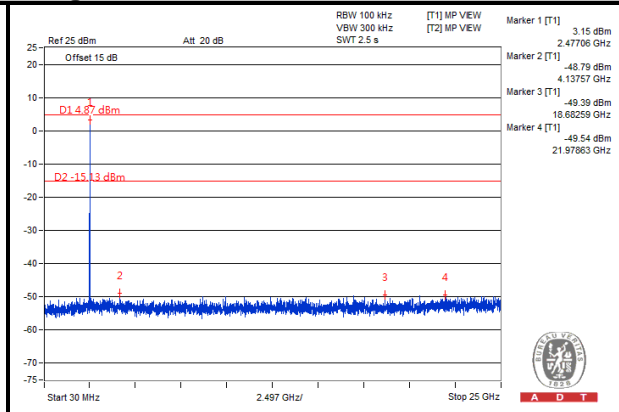
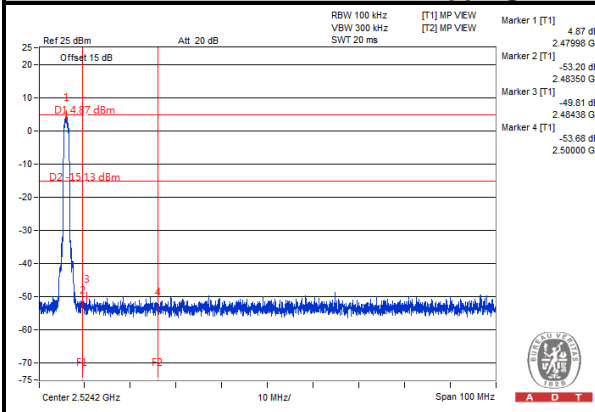

## Hopping enabled\_Low Channel

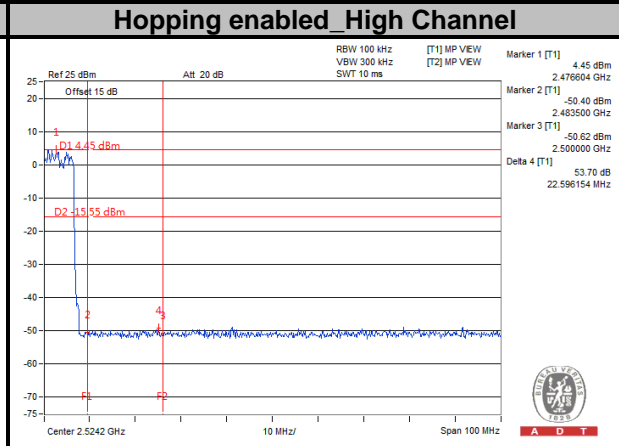
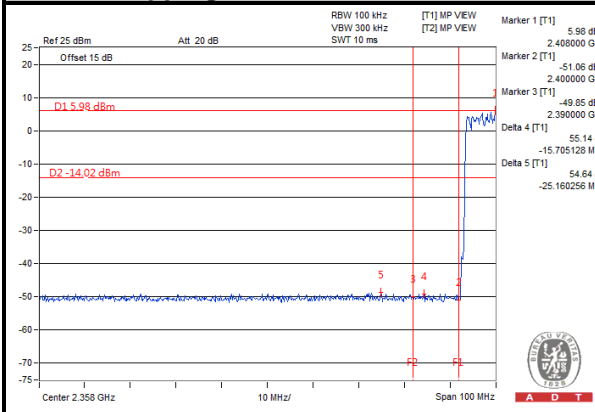



A D T

## 5. PHOTOGRAPHS OF THE TEST CONFIGURATION

Please refer to the attached file (Test Setup Photo).



## 6. INFORMATION ON THE TESTING LABORATORIES

We, Bureau Veritas Consumer Products Services (H.K.) Ltd., Taoyuan Branch, were founded in 1988 to provide our best service in EMC, Radio, Telecom and Safety consultation. Our laboratories are accredited and approved according to ISO/IEC 17025.

If you have any comments, please feel free to contact us at the following:

**Linko EMC/RF Lab:**

Tel: 886-2-26052180

Fax: 886-2-26051924

**Hsin Chu EMC/RF/Telecom Lab:**

Tel: 886-3-5935343

Fax: 886-3-5935342

**Hwa Ya EMC/RF/Safety Lab:**

Tel: 886-3-3183232

Fax: 886-3-3270892

**Email:** [service.adt@tw.bureauveritas.com](mailto:service.adt@tw.bureauveritas.com)

**Web Site:** [www.bureauveritas-adt.com](http://www.bureauveritas-adt.com)

The address and road map of all our labs can be found in our web site also.



A D T

## **7. APPENDIX A – MODIFICATIONS RECORDERS FOR ENGINEERING CHANGES TO THE EUT BY THE LAB**

No any modifications are made to the EUT by the lab during the test.

---END---