

# NURIT 8000

## *Installation Guide*

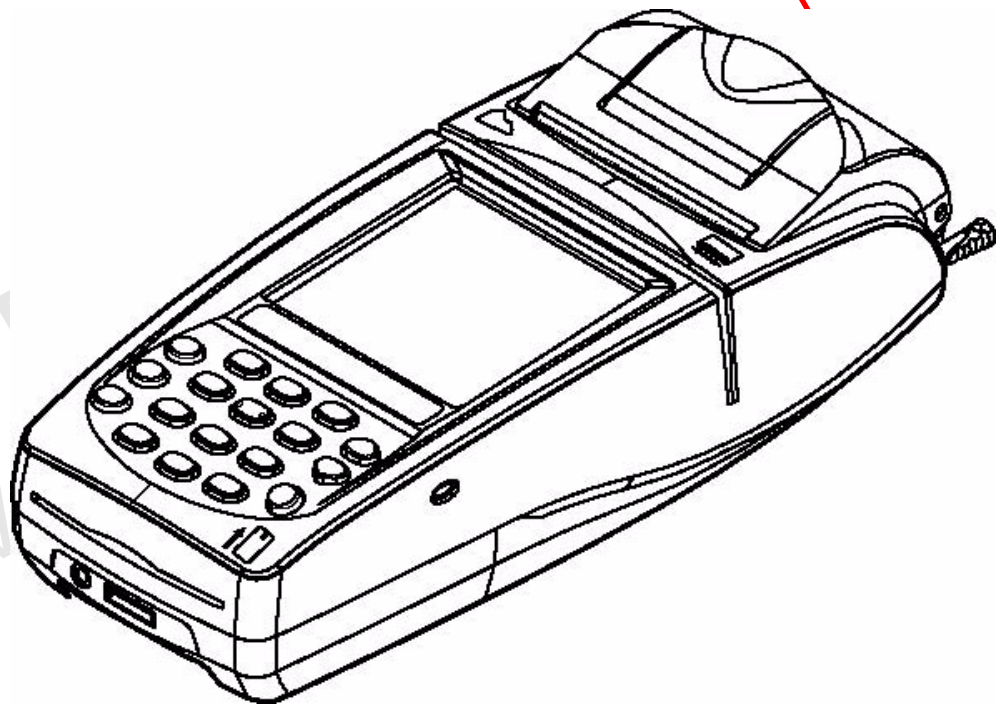

NURIT 8000 Installation Guide  
© 2008 VeriFone, Inc.

All rights reserved. No part of the contents of this document may be reproduced or transmitted in any form without the written permission of VeriFone, Inc.

The information contained in this document is subject to change without notice. Although VeriFone has attempted to ensure the accuracy of the contents of this document, this document may include errors or omissions. The examples and sample programs are for illustration only and may not be suited for your purpose. You should verify the applicability of any example or sample program before placing the software into productive use. This document, including without limitation the examples and software programs, is supplied "As-Is."

VeriFone, the VeriFone logo, VeriCentre, Verix, and NURIT are registered trademarks of VeriFone. Other brand names or trademarks associated with VeriFone's products and services are trademarks of VeriFone, Inc.

All other brand names and trademarks appearing in this manual are the property of their respective holders.

**Comments?** Please e-mail all comments on this document to your local VeriFone Support Team.

VeriFone, Inc.  
2099 Gateway Place, Suite 600  
San Jose, CA, 95110 USA  
[www.verifone.com](http://www.verifone.com)

VeriFone Part Number DOC113EN05, Revision A



	<b>PREFACE</b> .....	5
	Audience .....	5
	Organization .....	5
	Related Documentation .....	5
	Guide Conventions .....	5
	Acronym Definitions .....	6
<b>CHAPTER 1</b>		
<b>Overview</b>	NURIT 8000 .....	8
	Features at a Glance .....	8
<b>CHAPTER 2</b>		
<b>Setup</b>	Selecting Location .....	10
	Ease of Use .....	10
	Environmental Factors .....	10
	Electrical Considerations .....	11
	Unpacking Shipping Carton .....	12
	Examining	
	NURIT 8000 Features .....	13
	Terminal Front Panel .....	13
	Terminal Bottom Panel .....	14
	Using the Magnetic Stripe Card Reader .....	14
	Using the Smart Card Reader .....	15
	Using the Printer .....	16
	Loading Paper into the Printer .....	16
	Removing the Paper Roll From the Printer .....	17
	Opening and Closing the Battery/Card Compartment Cover .....	18
	Connecting the Battery .....	19
	Connecting and Removing the Battery .....	19
	Battery Maintenance .....	20
	Battery Charge Status .....	21
	Powering On and Off the Terminal With a Battery Pack .....	21
	Installing SIM, SAM, and SD Cards .....	21
	Connecting Cables .....	24
	Data Connection .....	24
	External Modem Connection .....	25
	Power Supply .....	25
	Car Adapter Connection .....	27
<b>CHAPTER 3</b>		
<b>Specifications</b>	Specifications .....	28
	Model .....	28
	Power Supply .....	28
	Printer .....	28
	Modem .....	28
	Physical .....	28

	Environmental, Regulatory, and Performance Specifications . . . . .	28
	Temperature and Humidity . . . . .	28
	User Interactions and Responsibilities . . . . .	29
<b>CHAPTER 4</b>		
<b>Maintenance and Cleaning</b>	Cleaning the NURIT 8000 . . . . .	31
<b>CHAPTER 5</b>		
<b>Troubleshooting Guidelines</b>	NURIT 8000 Appears to Have No Power. . . . .	33
	Transactions Cannot be Completed Successfully . . . . .	34
	Wireless Communication Does Not Work . . . . .	34
	Operation with Peripheral Device Not Successful . . . . .	34
	Printer Does Not Print. . . . .	34
	Printer Continues Printing When Out of Paper. . . . .	35
	Magnetic Stripe Card Reader Does Not Function Properly . . . . .	35
	Smart Card Reader Does Not Function Properly . . . . .	35
	The Keypad Does Not Respond. . . . .	35
	An Incorrect Response or Data Is Obtained. . . . .	35
	“Tampered Device” Displayed On Screen and Keypad Inoperable . . . . .	35
<b>CHAPTER 6</b>		
<b>Service and Support</b>	Service Returns . . . . .	36
	Accessories and Documentation . . . . .	37
	Power Supply . . . . .	37
	Battery. . . . .	38
	Cables. . . . .	38
	External Modem . . . . .	38
	Documentation . . . . .	38
	<b>INDEX</b> . . . . .	41



Use this guide as the primary source of information for setting up and installing the NURIT 8000.

**Audience**

This guide provides a simple description of the NURIT 8000’s features as well as basic information for the device’s installation and configuration.

**Organization**

This guide is organized as follows:

**Chapter 1, Overview.** Provides an overview of the NURIT 8000.

**Chapter 2, Setup.** Explains the setup and installation of NURIT 8000, selecting its location, and establishing connections with other devices.

**Chapter 3, Specifications.** Discusses power requirements and dimensions of the NURIT 8000.

**Chapter 4, Maintenance and Cleaning.** Explains maintenance of the NURIT 8000.

**Chapter 5, Troubleshooting Guidelines.** Provides troubleshooting guidelines for problems related to the NURIT 8000’s installation and configuration.

**Chapter 6, Service and Support.** Provides information for contacting your local VeriFone service provider and on how to order accessories or documents from VeriFone.

**Related Documentation**

To learn more about NURIT 8000, refer to the following set of documents:

NURIT 8000 Quick Installation Guide	VPN
NURIT 8000 Certifications and Regulations Sheet	VPN
NURIT 8000 External Modem Quick Installation Guide	DOC113MU01
NURIT 8000 Battery Pack Quick Installation Guide	DOC113MU02
NURIT 8000 Car Adapter Quick Installation Guide	DOC113MU03



**Guide Conventions**

Various conventions are used to help you quickly identify special formatting. **Table 1** describes these conventions and provides examples of their use.

**Table 1 Document Conventions**

Convention	Meaning	Example
Blue	Text in blue indicates terms that are cross references.	See <a href="#">Guide Conventions</a> .
<i>Italics</i>	Italic typeface indicates book titles or emphasis.	You <i>must</i> not use this unit underwater.

**Table 1 Document Conventions**

Convention	Meaning	Example
 <p><b>NOTE</b></p>	The pencil icon is used to highlight important information.	Box contents, including interconnection cable types, may vary according to specific model.
 <p><b>CAUTION</b></p>	The caution symbol indicates hardware or software failure, or loss of data.	The unit is not waterproof or dustproof, and is intended for indoor use only.
 <p><b>WARNING</b></p>	The lightning symbol is used as a warning when bodily injury might occur.	Due to risk of shock do not use the terminal near water.

**Acronym Definitions** Various acronyms are used in place of the full definition. [Table 2](#) presents acronyms and their definitions.

**Table 2 Acronym Definitions**

Acronym	Definitions
AC	Alternating Current
CCC	China Compulsory Certificate
DC	Direct Current
ECR	Electronic Cash Register
LED	Light Emitting Diode
LCD	Liquid Crystal Display
MII	Ministry of Industry and Information Technology
MRA	Merchandise Return Authorization
MSAM	Micromodule-size Security Access Module
MSR	Magnetic Stripe Reader
OS	Operating System
PC	Personal Computer
PIN	Personal Identification Number
POS	Point-of-Sale
RAM	Random Access Memory
RJ45	Registered Jack 45
RS232	Recommended Standard 232
SAM	Security Access Module
SDIO	Secure Digital Input/Output
SC	Smart Card (Integrated Chip Card)
SD Card	Secure Digital Card
SIM	Subscriber Identity Module

**Table 2** Acronym Definitions

Acronym	Definitions
VPN	VeriFone Part Number
WiFi	Wireless Fidelity

DRAFT  
REVISION A.3





## Overview

This chapter provides a brief description of the NURIT 8000.

### NURIT 8000

The NURIT 8000 Wireless Palmtop Terminal is one of the most advanced, versatile, secure, and convenient POS terminals manufactured today.



**Figure 1 The NURIT 8000 Terminal**

### Features at a Glance

The following is a list of features of the NURIT 8000:

**Table 3 NURIT 8000 Features**

Feature	Description
LCD Display	<ul style="list-style-type: none"> <li>Graphical LCD display</li> <li>Black and White</li> <li>128 x 128 pixels</li> <li>Application-dependent touch screen, with stylus</li> </ul>
Keypad	<ul style="list-style-type: none"> <li>18 keys comprised of:                             <ul style="list-style-type: none"> <li>10-key telephone-style keypad</li> <li>8 function and special keys</li> </ul> </li> </ul>
Smart Card Reader	<ul style="list-style-type: none"> <li>Integrated, front-entry, EMV-compliant smart card reader</li> </ul>
Magnetic Stripe Card Reader	<ul style="list-style-type: none"> <li>Integrated, bi-directional magnetic stripe card reader</li> </ul>



**Table 3** NURIT 8000 Features

Feature	Description
SAM-SD/MMC Cards Compartment	<ul style="list-style-type: none"> <li>• Compartment for up to two SAM cards</li> <li>• Compartment for up to one SD/MMC card</li> </ul> <p><b>Note:</b> Configuration is model-dependent.</p>
SIM Connector	<ul style="list-style-type: none"> <li>• Connector for the insertion of a SIM card (model dependent)</li> </ul>
Thermal Printer	<ul style="list-style-type: none"> <li>• Integrated printer uses thermal paper</li> <li>• Easy-load mechanism</li> </ul>
Terminal Interface Connector	<ul style="list-style-type: none"> <li>• Barrel power ( <b>POWER</b> ) connector</li> <li>• Data connector</li> </ul>
Radio	<ul style="list-style-type: none"> <li>• Internal antenna, located under paper roll, with power supply</li> <li>• GSM</li> </ul> <p><b>Note:</b> Configuration is model-dependent.</p>
Power	<ul style="list-style-type: none"> <li>• AC/DC adapter (safety approved)</li> </ul> <p>Output: 9-10 V at 1 A</p> <p><b>Note:</b> The AC/DC adapter must be approved by the relevant authorities in the country where the equipment is sold.</p>
Operating System Accessories	<ul style="list-style-type: none"> <li>• Ported NURIT for maximum application portability</li> <li>• Car adapter</li> <li>• External modem</li> </ul>



## Setup

This chapter describes the setup procedure for NURIT 8000, in the following sections:

- Selecting Location
- Unpacking Shipping Carton
- Examining NURIT 8000 Features
- Using the Magnetic Stripe Card Reader
- Using the Smart Card Reader
- Using the Printer
- Opening and Closing the Battery/Card Compartment Cover
- Connecting the Battery
- Installing SIM, SAM, and SD Cards
- Connecting Cables
- Power Supply

### Selecting Location

Use the following guidelines to select a location for the NURIT 8000.

#### Ease of Use

- When not operated from its hand-held position, place the NURIT 8000 on a flat table or countertop close to the power outlet and any peripherals.
- Maintain good ventilation.

#### Environmental Factors

- Do not use the unit where there is high heat, dust, humidity, moisture, or caustic chemicals or oils.
- Do not use the NURIT 8000 in a known blasting area.
- Do not use the NURIT 8000 in an area of potential explosive atmosphere, such as fuel or chemical storage or transfer facilities, or in any area where you would be advised to turn off a vehicle's engine.
- Do not cover slots and openings of the device. They may be provided for ventilation and protection against overheating. Never place the device near radiators, or in a place where proper ventilation is not provided.
- Do not cover the terminal.

- Maintain at least 22 cm (8.5 in) of clear space around the terminal in its fixed operating location, in order to assure good ventilation.

### Indoor Use

The NURIT 8000 is designed to be operated indoors in the following manner:

- Powered only by the built-in battery.
- Using the AC/DC power adapter for battery charging only.
- Using the optional external modem.

### Outdoor Use

The NURIT 8000 is designed to be operated outdoors in the following manner:

- Powered only by the built-in battery.
- In a vehicle, using the optional car adapter.



**CAUTION** Under no circumstances should the NURIT 8000 be powered or charged outdoors using its AC/DC adapter.



**WARNING** For persons using a pacemaker or other medical device, please read the following important safety notes:

Though most electronic equipment and critical medical devices are shielded against radio-frequency signals, it is important to realize the possibilities of potential interference and to know the standard precautions that may be taken.

Consult the manufacturer of your medical device to determine its level of shielding.

---

### NOTE



When the NURIT 8000 terminal is used as a secure PIN entry device:

- The customer should be able to obstruct visual observation of the PIN entry with his/her body and hand.
- The cardholder must be clearly instructed to obstruct visual observation of the PIN entry with his/her body and hand.

Failure to comply with these conditions may render the PIN pad non-compliant with ISO 9564 for PIN protection and may violate card association requirements for PIN entry devices.

---

### Electrical Considerations

- Avoid using this product during electrical storms.
- Avoid locations near electrical appliances or other devices that cause excessive voltage fluctuations or emit electrical noise (for example, air conditioners, electric motors, neon signs, high-frequency or magnetic security devices, or computer equipment).

- Do not use the NURIT 8000 near water or in moist conditions.
- Never spill any liquid on the device.
- Never push objects into the device through slots (other than those specifically intended for the magnetic stripe, smart cards, SAM cards, or cable ports).
- To reduce the risk of shock, do not disassemble any of the equipment or accessories referred to in this manual. If required, take the equipment to a qualified service representative. Incorrect reassembly or opening or removing covers may expose you to dangerous voltages or other risks.

**WARNING**



Due to risk of shock or damage, do not use the NURIT 8000 near water, including a bathtub, wash bowl, kitchen sink or laundry tub, in a wet basement, or near a swimming pool.

**Unpacking Shipping Carton**

Open the shipping carton and carefully inspect its contents for possible tampering or shipping damage. The NURIT 8000 is a secure product and any tampering can cause it to cease to function or to operate in an unsecured manner.

**To unpack the shipping carton**

- 1 Remove and inspect the contents of the shipping carton. The NURIT 8000 carton includes the following components:
  - NURIT 8000 terminal
  - AC/DC power adapter
  - Documentation
  - Touch screen stylus
  - Thermal paper roll
  - Paper roll spindle
  - Lithium-polymer Battery
  - RS-232 — barcode reader adapter (model dependent)
  - Keyboard emulation barcode reader adapter (model dependent)
  - PC-Terminal cable (model dependent)
  - Terminal-terminal cable (model dependent)
- 2 Remove all plastic wrapping from the components.
- 3 Remove the clear protective film from the LCD screen.
- 4 Save the shipping carton and packing material for future repacking or moving of the device.

**WARNING**



Do not use a unit that has been tampered or damaged. The NURIT 8000 comes equipped with tamper-evident labels. If a label or component appears damaged, please notify the shipping company and your VeriFone service provider immediately.

**NOTE**

The package contents, including interconnection cable types, may vary according to the specific model.

Some or all of the accessories contained in the box may already be installed in the PIN pad.

## Examining NURIT 8000 Features

Before you continue with the installation process, familiarize yourself with the NURIT 8000 features:

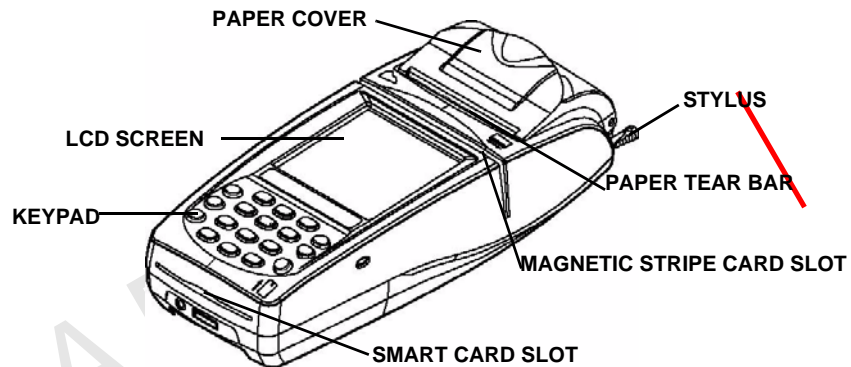

**Figure 2** NURIT 8000 Terminal Features (Front Panel)

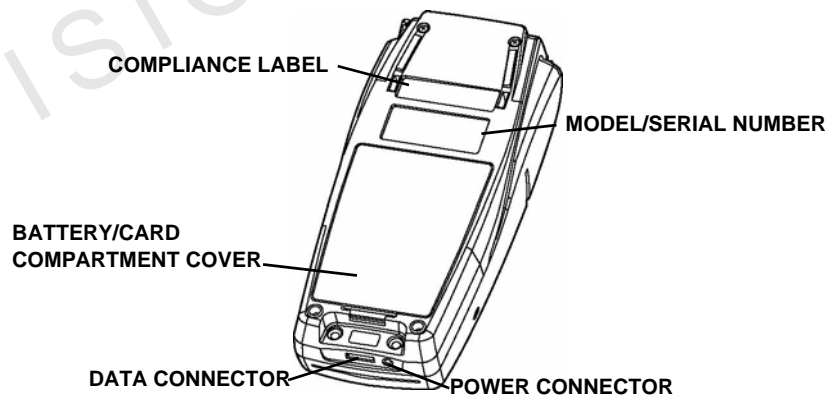

**Figure 3** NURIT 8000 Terminal Features (Bottom Panel)

### Terminal Front Panel

The front panel of the NURIT 8000 terminal (see [Figure 2](#)) includes the following features:

- A **touch screen terminal display**, backlit LCD screen.
- A **stylus**, with an **integrated stylus storage slot**.
- An 18-key, **telephone-style keypad**.
- A **magnetic card reader** on the top of the terminal. Bi-directional swiping capabilities. Swipe the card with the magnetic stripe down and left, towards the terminal and the keypad. For further directions, see [Using the Magnetic Stripe Card Reader](#).

- A **smart card reader**, built into the front of the terminal. For further directions, see [Using the Smart Card Reader](#).
- A **thermal printer**.

**Terminal Bottom Panel**

The bottom panel of the NURIT 8000 terminal (see [Figure 3](#)) includes the following features:

- An interconnection port panel. The interconnection port panel includes the following ports:
  - A **Power Socket** where the power cable is plugged. For directions on connecting the terminal to an electrical outlet, see [Power Supply](#).
  - A **Data** connector. For directions on connecting to the data port, see [For information on ordering an external modem for the NURIT 8000 terminal, see Accessories and Documentation..](#)
- A **battery pack/card compartment with removable door**. The card compartment is where the optional SIM (subscriber identity module), SAM (security access module), and SD (secure digital) cards are installed (configuration is model dependent).

For directions on installing and removing the battery pack/card compartment door, see [Opening and Closing the Battery/Card Compartment Cover](#).

For directions on installing and removing the battery pack, see [Connecting the Battery](#).

For directions on installing and removing the SIM, SAM, and SD cards, see [Installing SIM, SAM, and SD Cards](#).

**NOTE**



VeriFone ships variants of the NURIT 8000 terminal for different markets. Your terminal may have a different configuration. The following devices may or may not be present: a smart card reader, up to four MSAM cardholders, or a battery pack. However, the basic processes described in this guide remain the same, regardless of terminal configuration.

**Using the Magnetic Stripe Card Reader**

The magnetic stripe card reader is located at the top end of the NURIT 8000 terminal. Use the magnetic stripe card reader with a magnetic stripe card.

**To use the magnetic stripe card reader**

- 1 Hold the card with the magnetic stripe positioned down and facing towards the LCD display.
- 2 Insert the card into one end of the card reader slot.

- 3 Swipe the card in a smooth, continuous movement, all the way through the slot.

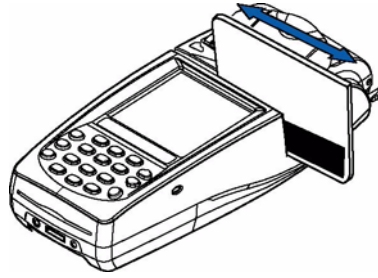

Figure 4 Swiping Magnetic Card

**NOTE**



For guidance, a pictogram near the card slot indicates how to swipe the magnetic stripe card in the card reader.

The magnetic stripe card reader supports bi-directional swiping of cards.

### Using the Smart Card Reader

The EMV-compatible smart card reader is located at the bottom end of the NURIT 8000 terminal. Use the smart card reader with a smart card.

*To use the smart card reader*

- 1 Hold the smart card horizontally, with the metal chip facing up and at the edge of the card nearest to the smart card reader slot.
- 2 Insert the card into the smart card reader slot.

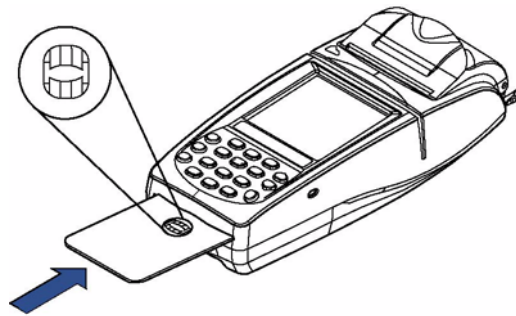

Figure 5 Inserting Smart Card

- 3 Remove the card when prompted by the POS terminal, depending on the specific application being used.

**NOTE**



For guidance, a pictogram near the card slot indicates how to insert the smart card into the smart card reader. In addition, insertion direction arrows may be engraved or inscribed on the smart card.



## Using the Printer

An integrated thermal printer is built into the NURIT 8000. Before you can process transactions in the NURIT 8000 that require a receipt or record, you *must* install paper in the printer.

### Loading Paper into the Printer

Before using the printer, load a roll of paper into the printer.

#### To load paper into the printer

- 1 Place the terminal on a flat, stable surface.
- 2 Insert two fingers into the recess on the paper compartment cover, beneath the release latch.
- 3 Pull the opening latch up until the cover unlocks.

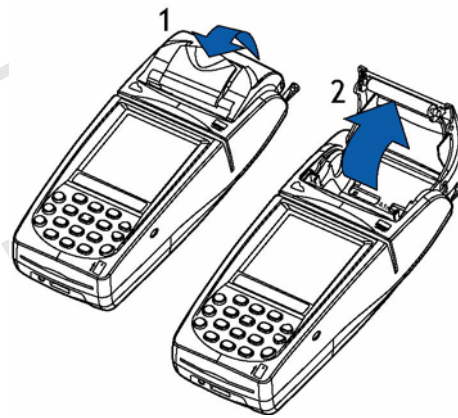

**Figure 6** Opening the Paper Compartment

- 4 Remove the tape strip from a new paper roll.
- 5 Unroll approximately 5 cm (2 in) of paper to facilitate the loading process.
- 6 Hold the paper roll with the unrolled end on the underside.
- 7 Lower the paper roll into the paper compartment.



**Figure 7** Inserting a Paper Roll

- 8 Pull the unrolled end of the paper approximately 2.5 cm (1 in) out of the paper compartment, ensuring that the paper feeds from the underside of the roll.
- 9 Make sure that the opening latch is down, in its original position.

- 10 Close the paper compartment cover, pressing down firmly, until it snaps into place.



**Figure 8** Closing the Paper Compartment

### Removing the Paper Roll From the Printer

When a roll of paper is finished, or if the paper is jammed, you may have to remove the old roll in order to replace it.

#### *To remove a roll of thermal paper from the printer*

- 1 Place the terminal on a flat, stable surface.
- 2 Insert two fingers into the recess on the paper compartment cover, beneath the release latch.
- 3 Pull the opening latch up until the cover unlocks.
- 4 Lift the paper compartment cover until it is fully open (see [Figure 6](#)).
- 5 Lift the paper roll out of the paper compartment.

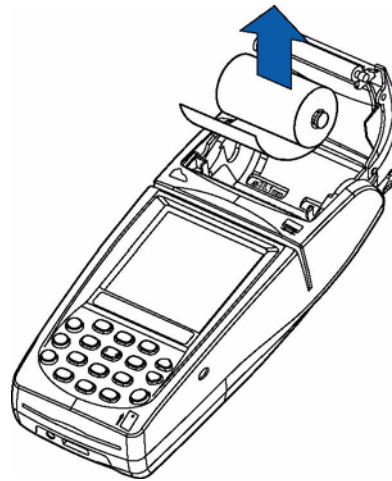

**Figure 9** Removing the Paper Roll

## Opening and Closing the Battery/Card Compartment Cover

To access the battery/card compartment, you have to first remove the compartment cover.

**NOTE**



SIM, SAM, and SD card configurations are model dependent.

**To remove the battery /card compartment cover**

- 1 Disconnect the AC/DC power adapter from the electrical power outlet.
- 2 Carefully place the NURIT 8000 face down on a soft, smooth surface, so as not to damage the LCD screen.
- 3 Secure the unit with one hand.
- 4 With your other hand, release the battery /card compartment cover by pressing and lifting its locking tab.
- 5 Lift the cover and detach it from the terminal.

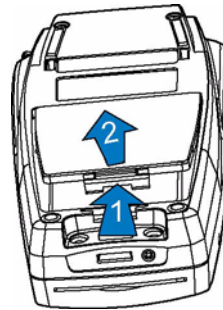

**Figure 10 Removing the Battery/Card Compartment Cover**

**To replace the battery pack/card compartment cover**

- 1 Place the NURIT 8000 face down on a soft, smooth surface, so as not to damage the LCD screen.

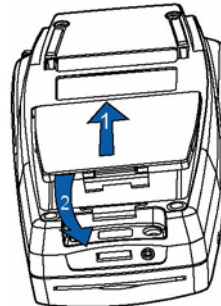

**Figure 11 Replacing the Battery/Card Compartment Cover**

- 2 Insert the two hinges of the battery/card compartment cover into the hinge slots on the edge of the battery/card compartment.
- 3 Close the compartment cover and press down until the locking tab snaps into place.

- 4 Connect the AC/DC power adapter from the electrical power outlet.

## Connecting the Battery

The NURIT 8000 terminal comes with a Lithium-polymer battery. Read this section to know how to install and remove the battery.

### NOTE



Only use batteries provided by VeriFone. For information about purchasing additional or replacement batteries, see [Accessories and Documentation](#).

Depending on your model of the NURIT 8000 terminal, the battery compartment may be shared with the SIM, SAM, and SD cards. To gain access to the battery/card compartment, you must first remove the battery/card compartment door. For information on removing and replacing the battery/card compartment cover, see [Opening and Closing the Battery/Card Compartment Cover](#).

## Connecting and Removing the Battery

The NURIT 8000 allows you to operate the terminal without an external power supply, by using a battery.

### To insert the battery

- 1 Remove the battery/card compartment cover. See [Figure 10](#).
- 2 Hold the battery, verifying that the side with the metal contacts are facing downwards and that the rounded edge is facing towards the back of the compartment.
- 3 While holding the battery at a 30° angle, slide the two tabs on the front of the battery into the slots on the front wall of the compartment.
- 4 Push the back of the battery down, until it snaps into place.

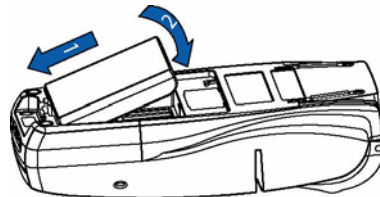

**Figure 12** Inserting the Battery

- 5 Replace the battery/card compartment cover. See [Figure 11](#).

### To remove the battery

- 1 Power off the terminal. See [Powering On and Off the Terminal With a Battery Pack](#).
- 2 Remove the battery/card compartment cover. See [Figure 10](#).
- 3 Insert your fingernail into the groove at the back of the battery and lift the battery, snapping the battery out of place.

- 4 Lift and remove the battery.

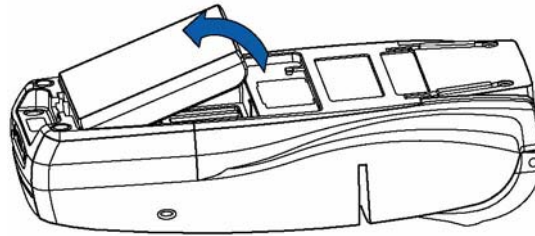

**Figure 13 Removing the Battery**

- 5 Replace the battery/card compartment cover. See [Figure 10](#).

## Battery Maintenance



Take care when installing the battery pack. If it is installed incorrectly, it may explode. Use only a VeriFone supplied battery.

- The supplied high-performance smart Lithium-polymer battery provides 7.4 VDC at 1800 mAH (minimum) capacity.
- When fully discharged, the battery fully recharges within three hours while installed in the terminal. An 80% charge capacity is reached within one hour.
- The terminal can be connected to an AC/DC power supply indefinitely without causing damage to the battery pack.



When using the VeriFone-supplied AC/DC power adapter, the Lithium-polymer battery must be installed in the terminal.

- In typical use, the life span of the battery exceeds 500 charge cycles, after which, operating time decreases slowly.
- The battery pack has a self-discharge rate. It loses approximately 1% of its charge per day when not in use. Replace the battery pack when the charge capacity is too weak for normal operation.
- Remove the battery pack from the terminal if you do not intend to use your NURIT 8000 for an extended period of time.



Do not break open, or separate the battery.



Do not dispose of the NURIT 8000 Lithium-polymer smart battery in a fire. Lithium-polymer batteries must be recycled or disposed of properly. Do not dispose of Lithium-polymer batteries in municipal waste sites.

**NOTE**



Extreme temperatures degrade the battery pack performance.

**Battery Environmental Requirements:**

- Standard Charge: 0°C to 40°C (32°F to 104°F)
- Discharge: -20°C to 50°C (-4°F to 122°F)
- Storage: -20°C to 60°C (-4°F to 140°F)

**Battery Charge Status**

The LED indicator on the car adapter lights according to the charge status.

**Table 4 Battery Charge LED Indicator Status**

Indicator	Charge Status
Red	The battery is charging (less than 80% charged)
Green	The battery is charging (80% or more charged)
No light	the battery is fully charged or the charger is disconnected from the power outlet.

**Powering On and Off the Terminal With a Battery Pack**

To power on a terminal, while using a battery pack, press the **ON/OFF** button, on the keypad. Hold down the button until the terminal powers up.

To power off a terminal, while using a battery pack, press down on both the function (**F**) and **ON/OFF** buttons, simultaneously. Hold down the button until the terminal powers down.

**NOTE**



Powering off the terminal is only possible when the terminal is running on batteries, and not connected to an AC power supply.

**Installing SIM, SAM, and SD Cards**

Configuration of SIM, SAM, and SD cards are model dependent. You can install one SIM card, up to two SAM cards, and an SD card in the NURIT 8000 terminal, depending on the particular model.

The card compartment is shared with the battery. To gain access to the battery/card compartment, you must first remove the battery/card compartment door. For information on removing and replacing the battery/card compartment door, see [Opening and Closing the Battery/Card Compartment Cover](#).

**NOTE**



A SIM card must be installed when using a model of the NURIT 8000 that implements GSM or GPRS wireless communications technology.

**To install a SIM or a SAM card**

- 1 Remove the battery/card compartment door. See Figure 10.
- 2 If necessary, remove the battery. See Figure 13.
- 3 Slide the locking-clasp in the direction indicated by the engraved arrow to the **OPEN** position.
- 4 Lift the cardholder on its hinge to a vertical position.
- 5 Hold the SIM/SAM card vertically, with the beveled corner at the top edge and the metallic contacts facing towards the contacts on the reader.
- 6 Slide the card into the cardholder.

**NOTE**



Make sure that you first slide the end closest to the chip on the card into the grooves of the holder and that the beveled corner is on the top edge of the SAM card.

- 7 Lower the SIM/SAM cardholder onto its base.

Check that the corner of the SIM/SAM card is not obstructed by the triangular protrusion at the corner of the cardholder base.

- 8 Lock the SAM cardholder by sliding the cardholder locking clasp to the **LOCK** position.

**CAUTION**



Do not bend or scratch the contacts of the SAM cardholder when installing or removing cards.

- 9 If necessary, replace the battery. See Figure 12.
- 10 Replace the battery/card compartment cover. See Figure 11.

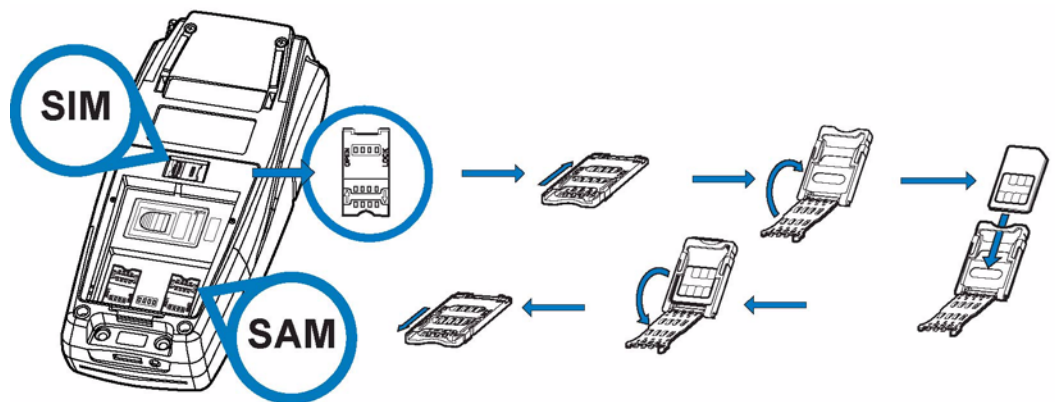

**Figure 14 Installing and Removing a SIM/SAM Card**

**To remove a SIM/SAM card**

- 1 Open the card holder, by following steps 1-4 of *To install a SIM or a SAM card* and remove the card.
- 2 Close the card holder by following steps 7-8 of *To install a SIM or a SAM card*.



For further instructions, see [Figure 14](#).

**To install an SD/MMC card**

- 1 Remove the battery/card compartment door. See [Figure 10](#).
- 2 If necessary, remove the battery. See [Figure 13](#).
- 3 Hold the SD/MMC card directly above the SD/MMC card slot, with the metal contacts facing down and the narrow edge with the beveled corner pointing towards the slot opening.
- 4 Lower the SD/MMC card into position.
- 5 Press down on the SD/MMC card while sliding it into the slot, until the card snaps into place.

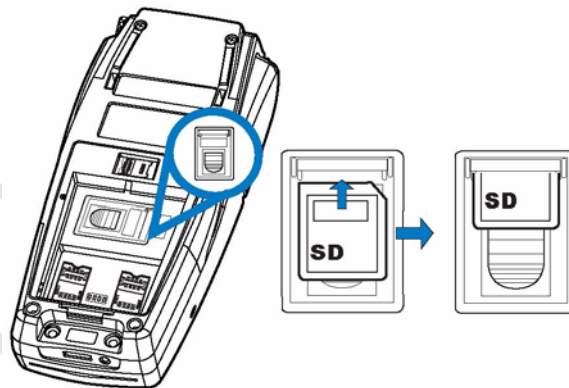
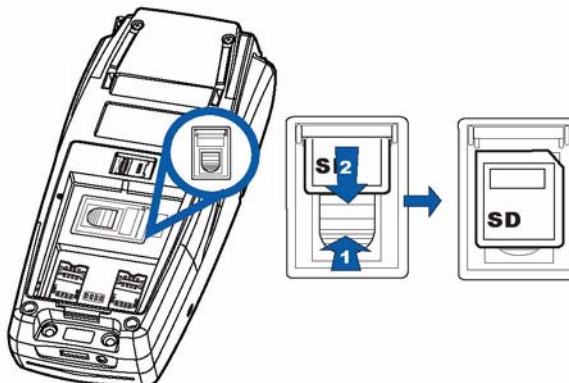

**Figure 15** Inserting the SD/MMC Card

- 6 If necessary, replace the battery. See [Figure 12](#).
- 7 Replace the battery/card compartment cover. See [Figure 11](#).

**To remove an SD/MMC Card**

- 1 Remove the battery/card compartment door. See [Figure 10](#).
- 2 If necessary, remove the battery. See [Figure 13](#).
- 3 With one hand press down on the SD/MMC locking tab, while sliding the card out with your other hand.
- 4 Remove the SD/MMC card.



**Figure 16** Removing the SD/MMC Card

- 5 If necessary, replace the battery. See [Figure 12](#).

- Replace the battery/card compartment cover. See Figure 11.

## Connecting Cables

The NURIT 8000 has the following ports to facilitate different types of cabling connections:

- For information on ordering an external modem for the NURIT 8000 terminal, see [Accessories and Documentation](#).
- Power Supply

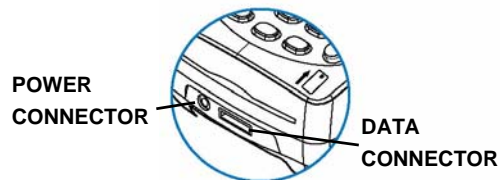

**Figure 17** NURIT 8000 Connections

### Data Connection

The data cable is an accessory which may be ordered separately.

For information on ordering an external modem for the NURIT 8000 terminal, see [Accessories and Documentation](#).



#### CAUTION

- Turn off the POS terminal, and any peripheral devices whenever you connect or disconnect the NURIT 8000.
- Do not disconnect the NURIT 8000 from an external device when it is processing data.

#### NOTE



- Peripheral devices may require special adapter cables for their connection to the NURIT 8000. In addition, certain peripheral devices require an external power supply.
- Refer to the product documentation of the specific peripheral devices, or contact your local VeriFone representative or service provider for further details.

### To connect the data cable

- Turn off the external device to which the base unit is to be connected and/or the NURIT 8000 terminal.
- Insert the plug into the data port on bottom of the unit.
- Insert the plug at the other end, into the external device.
- Turn on the external device and/or the NURIT 8000 terminal.

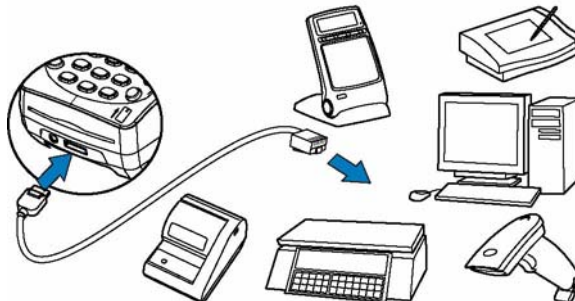

**Figure 18** Possible Data Connections

- To remove the data cable**
- 1 Turn off the external device to which the base unit is connected and/or the NURIT 8000 terminal.
  - 2 Detach the plug from the external device.
  - 3 Detach the plug from the data port on the bottom of the terminal.
  - 4 Turn on the NURIT 8000 terminal.

**External Modem Connection** The External Modem is an optional accessory that has model dependent connection capabilities. You can use the high-speed modem to download applications and parameters to the NURIT 8000 via a standard telephone line. For more information, see [Features at a Glance](#).

For information on ordering an external modem for the NURIT 8000 terminal, see [Accessories and Documentation](#).

- To connect the external modem**
- 1 Connect the modem's data plug into the data port on the front panel of the NURIT 8000 terminal.
  - 2 Connect a standard telephone line cord from the modem to a standard RJ-11 type modular telephone line outlet.

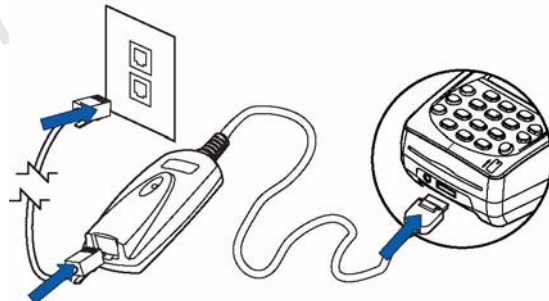

**Figure 19 External Modem Connection**

- To disconnect the external modem**
- 1 Disconnect the modem's data plug from the data port on the front panel of the NURIT 8000 terminal.
  - 2 Disconnect the standard telephone line from the telephone outlet.



**CAUTION** Do not disconnect the NURIT 8000 from an external device when it is processing data.

## **Power Supply**

The NURIT 8000 gives you the option of running the unit on battery power, or through a power adapter. The power adapter both gives power, as well as recharges the battery.

For information on using the battery, see [Connecting the Battery](#).

Before connecting a power supply, disconnect the power cord from the power outlet.

Connect and route all cables between the NURIT 8000, ECR, and PC before plugging the power pack cord into a wall outlet or surge protector.

**WARNING**



Use only the VeriFone supplied AC/DC power adapter to power the NURIT 8000. The power adapter provides electrical power to the NURIT 8000 as follows:

- AC/DC adapter (safety approved)

Output: 9-10 V at 1 A

**WARNING**



Do not plug the power pack into an outdoor outlet or operate the NURIT 8000 outdoors. Also, disconnecting power during a transaction can cause transaction data files not yet stored in memory to be lost.

**NOTE**



To protect against possible damage caused by lightning strikes and electrical surges, VeriFone recommends installing a power surge protector.

Connect one end of the power adapter cable to the Power port on the bottom of the terminal and the other into an electrical power outlet.

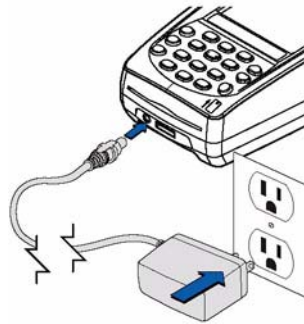
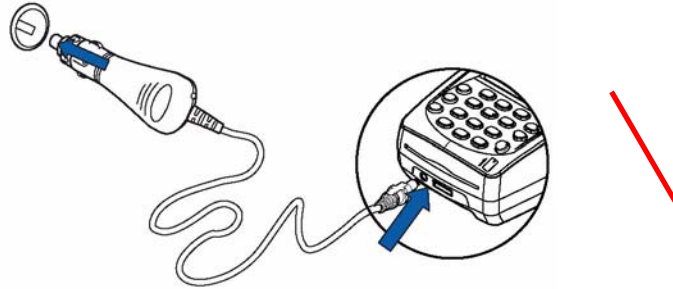

**Figure 20 Power Supply Connection**

**Car Adapter Connection** The car adapter is an optional accessory. You can use the car adapter to provide power to the NURIT 8000 and to charge the installed Lithium-polymer battery.

For information on ordering a car adapter for the NURIT 8000 terminal, see [Accessories and Documentation](#).

**To connect the car adapter** Connect one end of the car adapter cable to the Power port on the back of the terminal and the other into the vehicle's electrical power socket.



**Figure 21 Car Adapter Power Supply Connection**

**NOTE**



The LED indicator on the car adaptor indicates the charge status of the battery, as described in [Battery Charge Status](#).

**To remove the car adapter** Unplug the car adapter from the vehicle's electrical power socket and then from the power connector, at the front of the NURIT 8000 terminal.



## Specifications

This chapter discusses power requirements, dimensions, and other specifications of the NURIT 8000.

### Specifications

The following specifications describe the NURIT 8000 physical and electrical characteristics.

**Model** NURIT 8020

**Power Supply** • AC/DC adapter (safety approved)

Output: 9-10 V at 1 A

The AC/DC adapter must be compliant with the applicable standards and/or approved by the relevant authorities in the country where the equipment is sold.

**Printer** Thermal; easy-load mechanism.

**Modem** Optional accessory.

Choice of three speeds: 14.4 Kbps, 33.6 Kbps, or 56 Kbps telephone line modem (model dependent).

Implements synchronous or asynchronous, HDLC, TCP/IP protocols.

Supports Fast Connect connectivity.

May be supplied with the terminal as a standard accessory (model dependent).

**Physical** Length: 210 mm (8.27 in.). Width: 92 mm (3.62 in.). Height: 59 mm (2.32 in.).  
Weight: terminal, 625 g (22.05 oz.); full shipping, 800 g (28.2 oz.).

### Environmental, Regulatory, and Performance Specifications

The NURIT 8000 meets all the necessary environmental, regulatory, and performance standards for its intended use and expected market. VeriFone recognizes its responsibility to minimize the environmental impacts of its operations and products.

This device is *not* intended for outdoor use and is certified for indoor use only.

### Temperature and Humidity

#### **Operating Temperature and Humidity**

- Temperature: 0°C to +40°C (+32°F to +113°F)
- Humidity: 5-95% RH, non-condensing

### Storage Temperature and Humidity

- Temperature: -20°C to +60°C (-4°F to +140°F)
- Humidity: 5-95% RH, non-condensing

### User Interactions and Responsibilities

#### Reference: IEEE 1725, Section 9.2

- Do not disassemble or open crush, bend or deform, puncture or shred
- Do not modify or remanufacture, attempt to insert foreign objects into the battery, immerse or expose to water or other liquids, expose to fire, explosion or other hazard.
- Only use the battery for the system for which it is specified
- Only use the battery with a charging system that has been qualified with the system per this standard. Use of an unqualified battery or charger may present a risk of fire, explosion, leakage, or other hazard.
- Do not short circuit a battery or allow metallic conductive objects to contact battery terminals.
- Replace the battery only with another battery that has been qualified with the system per this standard, IEEE-Std-1725-200x. Use of an unqualified battery may present a risk of fire, explosion, leakage or other hazard.
- Promptly dispose of used batteries in accordance with local regulations
- Battery usage by children should be supervised.
- Avoid dropping the phone or battery. If the phone or battery is dropped, especially on a hard surface, and the user suspects damage, take it to a service center for inspection.
- Improper battery use may result in a fire, explosion or other hazard.



**WARNING**

This device complies with part 15 of the FCC Rules. Operation is subject to the following two conditions: (1) This device may not cause harmful interference, and (2) this device must accept any interference received, including interference that may cause undesired operation.

- This device has been tested and found to comply with the limits for a Class B digital device, pursuant to Part 15 of the FCC Rules. These limits are designed to provide reasonable protection against harmful interference in a residential installation. This equipment generates, uses and can radiated radio frequency energy and, if not installed and used in accordance with the instructions, may cause harmful interference to radio communications. However, there is no guarantee that interference will not occur in a particular installation. If this equipment does cause harmful interference to radio or television reception, which can be determined by turning the equipment off and on, the user is encouraged to try to correct the interference by one or more of the following measures:
  - Reorient or relocate the receiving antenna.
  - Increase the separation between the equipment and receiver.
  - Connect the equipment into an outlet on a circuit different from that to which the receiver is connected.
  - Consult the dealer or an experienced radio/TV technician for help.

Changes or modifications not expressly approved by the party responsible for compliance could void the user's authority to operate the equipment.

- This device complies with FCC radiation exposure limits set forth for an uncontrolled environment. In order to avoid the possibility of exceeding the FCC radio frequency exposure limits, human proximity to the antenna shall not be less than 20cm (8 inches) during normal operation.

## Maintenance and Cleaning

The NURIT 8000 has no user-serviceable parts.



- 
- Opening or disassembling the terminal in any way automatically erase all secret encryption keys and will render the PIN pad inoperable.
  - Opening the terminal will void any warranty and security certification. It may also result in irreversible damage to the unit's electronic circuitry.
- 

In order to maintain the NURIT 8000 in proper working condition:

- Keep the terminal dry and in the cleanest possible working and storage environment.
- Do not store the terminal in extremely hot or cold areas.
- Do not shake or drop the terminal.

### Cleaning the NURIT 8000

Disconnect the device from the power supply and any peripherals before cleaning.

#### *To clean the NURIT 8000*

- Gently wipe off dirt from the body of the terminal with a soft, damp, lint-free cloth. A very mild dishwashing detergent can be used to dampen the cloth.
- If available, a low-pressured blower can be used to remove dirt accumulated around the keypad buttons.
- Use a soft cloth, an eyeglass lens wiper, or a lens blower to remove dust and dirt from the LCD screen.

- To clean the PIN pad, use a soft, damp, lint-free cloth slightly dampened with water and a drop or two of mild soap. For stubborn stains, use alcohol or an alcohol-based cleaner. For best results, use a VeriFone Cleaning Kit (refer to the [Accessories and Documentation](#) section).

**CAUTION**



Never use abrasive compounds or solvents, thinner, trichloroethylene, ketone-based solvents, benzene, or synthetic cleansers— they can deteriorate plastic or rubber parts.

Do not spray cleaners or other solutions directly onto the keypad or display.

Never clean the unit with liquids. Use only a lightly dampened cloth or soft brush.

Never rub or strongly press on the LCD display.

Do not use liquid or aerosol cleaners. Use a damp cloth for cleaning and/or a soft brush.

- To clean the printer**
- 1 Disconnect the terminal from the power supply.
  - 2 Open the paper roll compartment cover. See [Figure 6](#).
  - 3 Carefully lift the paper roll (See [Figure 9](#)) and remove any excess pieces of paper or dirt that might be lodged in the compartment. If available, use a low-pressure compressed air gun.
  - 4 Replace the paper roll. See [Figure 7](#).
  - 5 Close the paper roll compartment cover. See [Figure 8](#).

### Troubleshooting Guidelines

The troubleshooting guidelines provided in the following section are included to assist you to successfully install and configure your NURIT 8000 device. If you have problems operating your NURIT 8000 device, please read through these troubleshooting examples.

If the problem persists even after performing the outlined guidelines or if the problem is not described below, contact your local VeriFone representative for assistance. Typical examples of malfunction you may encounter while operating your NURIT 8000 device and steps you can take to resolve them are listed.

---

#### NOTE



The NURIT 8000 comes equipped with tamper-evident labels. The device contains no user serviceable parts. Do not, under any circumstance, attempt to disassemble the device. Perform only those adjustments or repairs specified in this guide. For all other services, contact your local VeriFone service provider. Service conducted by parties other than authorized VeriFone representatives may void warranty.

---

#### CAUTION



Use only a VeriFone-supplied power cord. Using an incorrectly rated power supply may damage the device or cause it not to work as specified. Before troubleshooting, ensure that the power supply matches the requirements specified at the bottom of the device. (See [Chapter 3, Specifications](#) for detailed power supply specifications.) Obtain the appropriately rated power supply before continuing with troubleshooting.

---

### NURIT 8000 Appears to Have No Power

If the NURIT 8000 appears to have no power:

- Check all cable connections.
- Check that the voltage is reaching the AC power outlet by connecting a different device to this outlet. If you suspect any type of problem at this electric outlet, contact a certified electrician for a professional inspection.
- Check that the AC/DC power adapter is correctly connected to the power supply, as described in [Power Supply](#).
- Try adjusting the LCD screen contrast settings, using the designated, model-dependent, key combination.
- Press and hold down on the **ON/OFF** key for three (3) seconds.
- Check that the battery is securely installed and sufficiently charged, as described in [Connecting the Battery](#).

- If possible, try to operate the NURIT 8000 with a different VeriFone supplied AC/DC power adapter.
- Connect the NURIT 8000 to a different AC power outlet.
- If the problem persists, contact your VeriFone distributor or service provider.

## **Transactions Cannot be Completed Successfully**

If transactions cannot be completed successfully:

- Try to perform the transaction using a different magnetic stripe card or smart card (model dependent).
- Make sure that you insert or swipe the card in the proper manner.
- Attempt to complete several transactions manually using the terminal's keypad instead of using customer cards. If all these transactions are completed successfully, contact an authorized representative or service provider.
- If manually performed transaction is not completed successfully, verify that the wireless transmission quality is sufficient to complete the transaction. Try changing your location to obtain improved transmission quality.
- If the problem persists, contact your VeriFone distributor or service provider.

## **Wireless Communication Does Not Work**

If the wireless communication is disrupted or cannot be established:

- Try moving the terminal to a more open operating area. An enclosed area degrades the quality of wireless reception and transmission.
- Verify that the SIM card being used for wireless communication is installed correctly and is not damaged or malfunctioning.
- In general, the angle of operation does not affect terminal performance. However, for optimal usage, hold the terminal at an angle not exceeding 30°.
- If the problem persists, contact your VeriFone distributor or service provider.

## **Operation with Peripheral Device Not Successful**

If operation with a peripheral device is not successful:

- Verify that the peripheral device is properly connected to the terminal.
- Try to verify whether the peripheral device is functioning properly.
- Replace the cable or the adapter cable being used with the peripheral device.
- If the problem persists, contact your VeriFone distributor or service provider.

## **Printer Does Not Print**

If the printer does not work properly:

- Check the power connection.
- Recharge or replace the battery.
- Check that the paper roll compartment cover is fully and securely closed. (See [Loading Paper into the Printer](#)).

- Check that the printer has paper and that the paper and paper roll are properly installed. Take out and then reinsert the paper, if necessary. (See [Loading Paper into the Printer](#)).
- Check that the paper is not jammed or damaged. If it is, reload the paper. (See [Loading Paper into the Printer](#)).
- If the problem persists, contact your VeriFone distributor or service provider.

### **Printer Continues Printing When Out of Paper**

If the printer continues to operate when out of paper:

- Check that the paper sensor of the printer mechanism (inside the paper roll compartment) is not blocked by paper or debris.
- If the problem persists, contact your VeriFone distributor or service provider.

### **Magnetic Stripe Card Reader Does Not Function Properly**

If the magnetic stripe card reader does not function properly:

- Check that the card has been swiped with its magnetic stripe facing left and at the lower edge of the card, as described in [Using the Magnetic Stripe Card Reader](#).
- Swipe the magnetic stripe card in the opposite direction.
- If possible, try using a different magnetic card.
- If the problem persists, contact your VeriFone distributor or service provider.

### **Smart Card Reader Does Not Function Properly**

If the smart card reader does not function properly:

- Check that the smart card is fully inserted with the metal chip facing up and at the edge of the card nearest to the smart card reader slot, as described in [Using the Smart Card Reader](#).
- If possible, try using a different smart card.
- If the problem persists, contact your VeriFone distributor or service provider.

### **The Keypad Does Not Respond**

If the keypad does not respond:

- Refer to user documentation for the particular application in use.
- If the problem persists, contact your VeriFone distributor or service provider.

### **An Incorrect Response or Data Is Obtained**

If an incorrect response or data is obtained:

- Refer to user documentation for the particular application in use.
- If the problem persists, contact your VeriFone distributor or service provider.

### **“Tampered Device” Displayed On Screen and Keypad Inoperable**

If “Tampered Device” is displayed on the screen and the keypad is inoperable contact an authorized service representative.

## Service and Support

For NURIT 8000 problems, contact your local VeriFone representative or service provider.

For NURIT 8000 product service and repair information:

- USA – VeriFone Service and Support Group, 1-800-834-4366, Monday - Friday, 8 A.M. - 8 P.M., Eastern time.
- International – Contact your VeriFone representative.

### Service Returns

Before returning the NURIT 8000 to VeriFone, you must obtain a Merchandise Return Authorization (MRA) number. The following procedure describes how to return one or more NURIT 8000 for repair or replacement (U.S. customers only).

---

**NOTE**



International customers, please contact your local VeriFone representative for assistance with your service, return, or replacement.

---

- 1** Gather the following information from the printed labels (see [Figure 22](#)) on the bottom of each NURIT 8000 to be returned:
  - Product ID, including the model and part number. For example, “m108-xxx-xx” and “PTID xxxxxxxx.”
  - Serial number (S/N xxx-xxx-xxx).
- 2** Within the United States, call VeriFone toll-free at 1-800-834-4366.
- 3** Select the MRA option from the automated message. The MRA department is open Monday–Friday, 8 A.M.–8 P.M., eastern time.
- 4** Give the MRA representative the information gathered in [Step 1](#). If the list of serial numbers is long, you can fax the list, along with the information gathered in [Step 1](#), to the MRA department at 1-727-953-4172 (U.S.).
  - Please address the fax clearly to the attention of the “VeriFone MRA Dept.”
  - Include a telephone number where you can be reached and your fax number.



- You will be issued MRA number(s) and the fax will be returned to you.



One MRA number must be issued for each NURIT 8000 you return to VeriFone, even if you are returning several of the same model.

- 5 Describe the problem(s) and provide the shipping address where the repaired or replacement unit must be returned.
- 6 Keep a record of the following items:
  - Assigned MRA number(s).
  - VeriFone serial number assigned to the NURIT 8000 you are returning for service or repair (serial numbers are located on the bottom of the unit as illustrated in Figure 22).
  - Shipping documentation, such as air bill numbers used to trace the shipment.
  - Model(s) returned (model numbers are located on the VeriFone label on the bottom of the NURIT 8000).

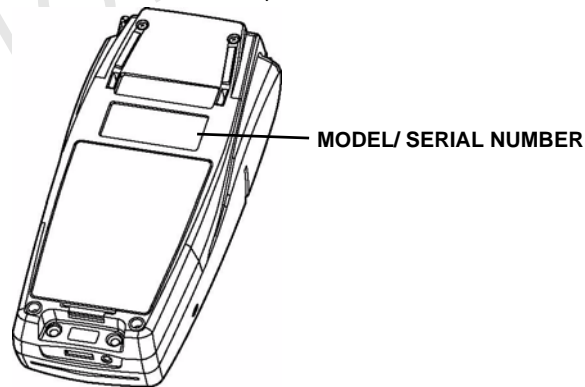

**Figure 22** Information Label on Unit Bottom

## Accessories and Documentation

VeriFone produces accessories and documentation for the NURIT 8000. When ordering, please refer to the part number in the left column.

VeriFone Online Store at [www.store.verifone.com](http://www.store.verifone.com)

- USA – VeriFone Customer Development Center, 1-800-834-4366, Monday - Friday, 7 A.M. - 8 P.M., eastern time
- International – Contact your VeriFone representative

## Power Supply

AC power cord (United States of America)	WIR 30017
Car adapter (universal)	80CA-XX-MXX-BLK

The AC power cord varies by country. Contact your local VeriFone representative or service provider to identify the best power cord for your needs.

**Battery** 802B-XX-MXX-BLK

**Cables**

Data cable FCL09503

**External Modem** 80EM-XX-MXX-GRY

**Documentation** To learn more about NURIT 8000, refer to the following set of documents:

NURIT 8000 Quick Installation Guide	VPN
NURIT 8000 Certifications and Regulations Sheet	VPN
NURIT 8000 External Modem Quick Installation Guide	DOC113MU01
NURIT 8000 Battery Pack Quick Installation Guide	DOC113MU02
NURIT 8000 Car Adapter Quick Installation Guide	DOC113MU03

DRAFT  
REVISION A.3





**A**

- accessories **37**
  - battery **38**
  - car adapter **37**
  - data cable **38**
  - documentation **38**
  - external modem **38**
  - power cord **37**
  - terminal **37**

**B**

- battery
  - ordering **38**
- bottom panel
  - features **14**
  - terminal **14**

**C**

- cables
  - connecting
    - data **24**
  - ordering data cables **38**
- car adapter
  - ordering **37**
- cleaning **31**
- connecting
  - cables **24**
  - power supply **25, 33**

**D**

- data
  - connecting
    - cables **24**
  - troubleshooting **35**
- data cable
  - ordering **38**
- data connection **24**
- documentation **37**
  - accessories **38**
  - acronym definitions **6**
  - conventions **5**

related **5**

**E**

- electrical considerations **11**
- environmental factors **10**
- environmental, regulatory, and performance specifications **28**
- external modem
  - ordering **38**

**F**

- features
  - bottom panel **14**
  - front panel **13**
  - general **8, 13**
- front panel
  - features **13**
  - terminal **13**

**I**

- inserting
  - paper **16**
- installing
  - SAM card **21**
  - SD/MMC card **23**
  - SIM card **21**
  - terminal location **10**
  - unpack the shipping carton **12**

**K**

- keypad
  - troubleshooting **35**

**L**

- loading
  - paper **16**

**M**

- magnetic stripe card reader
  - troubleshooting **35**
  - using **14**
- maintenance

cleaning **31**

returning a unit for repair or replacement **36**

model **28**

modem

specifications **28**

## O

operation with peripheral device

troubleshooting **34**

ordering

battery **38**

car adapter **37**

external modem **38**

power cord **37**

## P

paper

inserting **16**

loading **16**

removing **17**

physical

specifications **28**

power

troubleshooting **33**

power cord **37**

ordering **37**

power supply **25**

connecting **25, 33**

specifications **28**

printer

paper

inserting **16**

troubleshooting **35**

specifications **28**

troubleshooting **34**

using **16**

## R

removing

paper **17**

SAM card **22**

SIM card **22**

repair **36**

replacement **36**

returning a unit

repair **36**

replacement

returning a unit

service **36**

## S

SAM card

installing **21**

removing **22**

SD/MMC card

removing **23**

SD/MMC card installing **23**

service

returning a unit **36**

SIM card

installing **21**

removing **22**

smart card reader

troubleshooting **35**

using **15**

specifications

environmental, regulatory, and performance **28**

modem **28**

physical **28**

power supply **28**

printer **28**

product

model **28**

temperature and humidity **28**

support **36**

## T

tampered device

troubleshooting **35**

temperature and humidity

specifications **28**

terminal

accessories **37**

bottom panel **14**

cleaning **31**

documentation **37**

electrical considerations **11**

environmental factors **10**

features **13**

general **8, 13**

front panel **13**

installing **10**

- location **10**
- repair **33, 36**
- replacement **36**
- service and support **36**
- specification
  - model **28**
- troubleshooting **33**

transactions

- troubleshooting **34**

troubleshooting

- data **35**

- keypad **35**

- magnetic stripe card reader **35**

- operation with peripheral device **34**

- power **33**

- printer **34**

- paper **35**

- smart card reader **35**

- tampered device **35**

- terminal **33**

- transactions **34**

- wireless communication **34**

## U

using

- magnetic stripe card reader **14**

- printer **16**

- smart card reader **15**

## W

wireless communication

- troubleshooting **34**





VeriFone, Inc.  
2099 Gateway Place, Suite 600  
San Jose, CA, 95110 USA  
Tel: (800) VeriFone (837-4366)  
[www.verifone.com](http://www.verifone.com)

DRAFT  
REVISION A.3

# NURIT 8000

## *Installation Guide*

