

M400

Installation Guide



M400 Installation Guide
© 2018 Verifone, Inc.

All rights reserved. No part of the contents of this document may be reproduced or transmitted in any form without the written permission of Verifone, Inc.

The information contained in this document is subject to change without notice. Although Verifone has attempted to ensure the accuracy of the contents of this document, this document may include errors or omissions. The examples and sample programs are for illustration only and may not be suited for your purpose. You should verify the applicability of any example or sample program before placing the software into productive use. This document, including without limitation the examples and software programs, is supplied "As-Is."

Verifone, and the Verifone logo are registered trademarks of Verifone.

Other brand names or trademarks associated with Verifone's products and services are trademarks of Verifone, Inc. All other brand names and trademarks appearing in this manual are the property of their respective holders.

Product Warranty

For product warranty information, go to <http://www.verifone.com/terms>.

Comments? Please e-mail all comments in this document to your local Verifone Support Team.

Verifone, Inc.
1-800-Verifone

www.verifone.com



PREFACE 5

Audience 5

Organization 5

Related Documentation 5

Guide Conventions 6

 Acronym Definitions 7

CHAPTER 1
Terminal Overview

Features and Benefits 10

 Exceptional Ease of Use 10

 Performance and Durability 10

 Security 10

 Contactless Capability 10

 Communication Technology 10

CHAPTER 2
Setup

Terminal Location 11

 Ease of Use 11

 Environmental Factors 11

 Electrical Considerations 12

 Contactless Considerations 12

PIN Protection Measures 12

 Ensuring User Privacy 13

 Mounting Considerations 13

Inside the Shipping Carton 14

Terminal Features 15

 Front Panel 15

Connection Ports 16

 Connecting Cables and other Devices 16

M400 Connection Options 17

 Powered USB Cable 17

 ICE Cubes 18

Micro SD Card 18

MSAM Card 20

Terminal Power Source 21

Calibrate Touch Panel 22

Smart Card Reader 22

Magnetic Card Reader 23

Contactless Smart Card Transaction 23

VX 690 WiFi/BT Support 24

 Bluetooth Support 24

 Wireless Transaction 24

Optional Accessories 24

 Privacy Shield 24

 Stand 25

 External and Optional Devices 27

CHAPTER 3
Specifications

Power Rating	29
Power Pack	29
Temperature	29
External Dimensions	29
Weight	29
Processor	29
Memory	29
Display	29
Magnetic Card Reader	29
Primary Smart Card	29
SAM Card Reader	30
SD Card Reader	30
Integrated Contactless Reader	30
Keypad	30
Audio Jack	30
Peripheral Ports	30
Security	30

CHAPTER 4
Maintenance and
Cleaning

General Care	31
Surface Cleaning	32
Magnetic Card Reader	32
Smart Card Reader	32
Additional Safety Information	32
Power Adapter	32
Potentially Explosive Environments	32

CHAPTER 5
Service and Support

Service Returns	33
Accessories and Documentation	34

CHAPTER 6
Troubleshooting
Guidelines

Terminal Does Not Start	37
Terminal Display Does Not Show Correct/Readable Info.	37
Blank Display	38
Keypad Does Not Respond	38
Transactions Fail To Process	38



This guide is the primary source of information for setting up and installing the terminal.

Audience

This guide is useful to anyone installing and configuring the terminal.

Organization

This guide is organized as follows:

[Chapter 1, Terminal Overview](#). Provides an overview of the terminal.

[Chapter 2, Setup](#). Explains setup and installation of the terminal, selecting a location, and establishing connections with other devices.

[Chapter 3, Specifications](#). Discusses power requirements and dimensions of the terminal.

[Chapter 4, Maintenance and Cleaning](#). Explains maintenance of the terminal.

[Chapter 5, Service and Support](#). Provides information on contacting your Verifone service provider and information on how to order accessories or documentations from Verifone.

[Chapter 6, Troubleshooting Guidelines](#). Provides troubleshooting guidelines should you encounter a problem in terminal installation and configuration.

Related Documentation



Refer to the following set of documents to learn more about the terminal:

<i>M400 Certifications and Regulations</i>	VPN - DOC445-001-EN
<i>M400 Series Quick Installation Guide</i>	VPN - DOC445-002-EN
<i>M400 Series Ice Cube Certifications and Regulations</i>	VPN - DOC445-005-EN
<i>M400 Series Ice Cube Quick Installation Guide</i>	VPN - DOC445-006-EN
<i>M400 Series Stand Quick Installation Guide</i>	VPN - DOC445-007-EN
<i>M400 Series Privacy Shield Quick Installation Guide</i>	VPN - DOC445-008-EN
<i>VOS Programmers Manual</i>	VPN - DOC00501

Guide Conventions

Various conventions are used to help you quickly identify special formatting. Table 1 describes these conventions and provides examples of their use.

Table 1 Document Conventions

Convention	Meaning	Example
Blue	Text in blue indicates terms that are cross references.	See Guide Conventions .
<i>Italics</i>	Italic typeface indicates book titles or emphasis.	You <i>must</i> not use this unit underwater.
<p>NOTE</p> 	The pencil icon is used to highlight important information.	RS232-type devices do not work on the M400 communication port.
<p>CAUTION</p> 	The caution symbol indicates hardware or software failure, or loss of data.	The unit is not waterproof or dustproof, and is intended for indoor use only.
<p>WARNING</p> 	The lightning symbol is used as a warning when bodily injury might occur.	Do not use the terminal near water due to risk of shock.

Acronym Definitions Acronyms are used in place of the full definition. [Table 2](#) presents acronyms and their definitions.

Table 2 Acronym Definitions

Acronym	Definitions
3DES	Triple Data Encryption Standard
AES	Advanced Encryption Standard Algorithm
API	Application Programming Interface
ARM	Advanced RISC Machine
BBM	Battery Backed Memory
CAPK	Certification Authority Public Key
CBC	Cipher Block Chaining mode
DEA/DES	Data Encryption Algorithm/Standard
DUKPT	Derived Unique Key Per Transaction Method as defined in the VISA's POS Equipment Requirement: PIN processing and Data Authentication, International Version 1.0, August 1988
ECR	Electronic Cash Register
EMV	Joint Europay, MasterCard and Visa Standard
FSM	Fiscal Module
MAC	Message Authentication Code
MMU	Memory Management Unit
MSAM	Multiple Secure Access Module
OS	Operating System
PIN	Personal Identification Number
POS	Point-of-Sale
RFID	Radio Frequency Identification
SAM	Secure Access Module
SC	Smart Card (Integrated Chip Card)
SD	Secure Digital
SR	Ship Release
SRAM	Static Random Access Memory
UI	User Interface
USB	Universal Serial Bus
Wi-Fi	Wireless Fidelity



Terminal Overview

A media-capable consumer-facing device that connects to a POS system which allows electronic payment transactions to be processed in multi-lane scenarios. It provides better media capabilities, more reliable hardware, and more efficient processing software.

The terminal features a color 5" IPS LCD capacitive touch screen display, fast processor, abundant memory, PCI 4.x security, and an integrated contactless module. M400 WiFi/BT supports 802.11 a/b/g/n Wireless Fidelity (Wi-Fi) and Bluetooth (BT), while the M400 BT variant supports Bluetooth (BT) including BLE with iBeacon and Eddystone profiles.



Figure 1 **M400 Terminal**

Features and Benefits

The terminal focuses on optimizing cost structure and providing better form factor by combining the right features and functions.

Exceptional Ease of Use

- Large 5" LCD display for unlimited application possibilities and easy readability under various lighting conditions.
- Touchscreen for icon-based applications or electronic signature capture support.
- Intuitive telco-style keypad with colored control keys, interchangeably detects key presses from tactile keypad and the touchscreen.
- Bi-directional magnetic stripe card reader with an extended blade for optimal card reading.
- Audio jack to facilitate accessibility for the visually impaired.

Performance and Durability

- Fast transactions due to powerful 1 GHz ARM Cortex A9 processor.
- Rounded corners and drop resistant to three feet on concrete floor to minimize breakage.
- 256 MB of flash memory and 512 MB SDRAM with removable uSD.

Security

- Incorporates tamper-detection circuitry to resist unauthorized intrusion and supports a broad spectrum of software-based security features.
- PCI 4.x approved for debit and other PIN-based transactions.
- EMV Level 1 Type Approval.
- Supports reliable security available including SSL, VeriShield file authentication, and VeriShield Protect to help prevent fraud and other intrusions.
- With Kensington lock feature resident in the terminal as part of the case.

Contactless Capability

- Advanced contactless architecture that future-proofs investment with a single contactless interface (SingleCI), SoftSAMs, and side-by-side application architecture.
- On-screen tap zone for optimized user experience.
- Accepts EMV, NFC, and mag-stripe contactless payments as well as PIN-based transactions.

Communication Technology

- Bluetooth: Simple, plug-and-play installation for locations that need short-range wireless capability. Eddystone and iBeacon profiles are also supported.
- Wi-Fi: Ideal for retailers that need multiple wireless devices and have an existing IP infrastructure (M400 WiFi-BT only).



Setup

This chapter describes the setup procedure for:

- Terminal Location.
- Inside the Shipping Carton.
- Terminal Features.
- Connection Ports.
- M400 Connection Options.
- MSAM Card.
- Terminal Power Source.
- Calibrate Touch Panel.
- Smart Card Reader.
- Magnetic Card Reader.
- Contactless Smart Card Transaction.
- M400 WiFi/BT Support.
- Optional Accessories.

Terminal Location

The following are guidelines used to select an ideal location for the terminal.

Ease of Use

- Select a location convenient for both merchant and cardholder.
- Select a flat support surface, such as a countertop or table, or mount it on a mounting stand supplied by Verifone.
- Select a location near a power outlet, POS, ECR, or computer connected to the terminal. Do not string cables or cords across a walkway for safety.

Environmental Factors

- Do not use the unit where there is high heat, dust, humidity, moisture, caustic chemicals or oils.
- Keep the unit away from direct sunlight and anything that radiates heat, such as a stove or a motor.
- Do not use the terminal outdoors.

CAUTION

The terminal is not waterproof or dustproof. It is intended for indoor use only. Any damage to the unit from exposure to rain or dust can void any warranty.

Electrical Considerations

- Avoid using this product during electrical storms.
- Avoid locations near electrical appliances or other devices that cause excessive voltage fluctuations or emit electrical noise (for example, air conditioners, electric motors, neon signs, high-frequency or magnetic security devices, or computer equipment).
- Do not use the terminal near water or in moist conditions.
- Disconnect the device from its POS terminal before cleaning.

WARNING

Do not use the terminal near water, including a bathtub, wash bowl, kitchen sink or laundry tub, in a wet basement, or near a swimming pool to avoid shock or damage.

Contactless Considerations

Avoid having metallic objects in proximity of the contactless antenna. If you need to mount the terminal to vertical or inclined surfaces, use a flat, non-metallic mounting plate.

CAUTION

Using an enclosed metal frame or mount may negatively affect contactless performance

PIN Protection Measures

Use the following techniques to provide effective screening of PIN-Entry Devices (PEDs) during the PIN-entry process. You can use these methods in combination, although in some cases a single method might suffice.

- Position the terminal on the check-in stand in such a way as to block visual observation of the PIN-entry process. Examples include:
 - Visual shields designed into the check-in stand. The shields may be solely for shielding purposes, or may be part of the general check-in stand design.
 - Position the terminal so that it is angled in such a way that PIN spying is difficult.
- Install the PED on an adjustable stand that allows consumers to swivel the terminal sideways and/or tilt it forwards/backwards to a position that makes visual observation of the PIN-entry process difficult.
- Position in-store security cameras so that the PIN-entry keypad is not visible.

The following table describes the two preferred mounting methods and the recommended measures to protect against PIN capture in four observation corridors:

Table 3 Mounting Methods and Protection Measures

Method	Cashier	Customer in Queue	Customers Elsewhere	On-site Cameras
Countertop without stand	Use signage behind the PED	Install so that customer is between PED and next in queue	No action needed	Do not install within view of cameras
Countertop with stand	No action needed	Install so that customer is between PED and next in queue	No action needed	Do not install within view of cameras

Verifone also recommends instruction of the cardholder regarding safe PIN-entry. This can be done with a combination of:

- Signage on the PED
- Prompts on the display, possibly with a click-through screen
- Literature at the point of sale
- A logo for safe PIN-entry process.

Ensuring User Privacy

Use the following guidelines to protect the user’s privacy when he enters his personal identification number (PIN):

- The area of visibility should be no larger than a cone taken from the number 5 key at an angle of 45° and covering an area of 270° directly in front of the user.
- You can secure PIN entry by installing a [Privacy Shield](#) (optional).

Mounting Considerations

Verifone recommends the use of an approved stand for all mounting situations. Position the terminal conveniently in relation to power, POS, ECR, and LAN connections. Ensure the M400 terminal is located in a manner that allows customers to swipe their magnetic cards or insert their Smart Cards in a smooth and comfortable motion without encountering obstructions. If the unit will be swiveled during normal operation, Verifone requires the use of an approved swivel stand.



Special care is required when mounting the M400 terminal in sites that utilize anti-theft devices positioned at doorways or surface mounted deactivator pads. Devices of this type, such as Sensormatic brand devices, generate strong electromagnetic fields which may interfere with M400 terminal. Always select mounting locations at least six feet from doorway units and at least 18 inches from surface mounted deactivator pads.

Inside the Shipping Carton

Open the shipping carton and carefully inspect its contents for possible tampering or shipping damage. The terminal is a secure product. Tampering causes it to cease to function or to operate in an unsecured manner.

Unpacking the Shipping Carton

To unpack the shipping carton:

- 1 Remove and inspect the contents of the shipping carton. The terminal ships in multiple configurations, the carton may include all or any of the following:
 - Terminal
 - Connectivity cable

NOTE



Power supply, connectivity cubes, and base module are shipped separately or depending on customer requirements.

- 2 Remove all plastic wrapping from the terminal and components.
- 3 Remove the clear protective film from the display.
- 4 Save the shipping carton and packing material for future repacking or moving of the device.

WARNING



Do not use a tampered or damaged unit. The terminal comes equipped with tamper-evident labels. If a label or component appears damaged, please notify the shipping company and your Verifone service provider immediately.

Terminal Features

Familiarize yourself with the terminal features before continuing with the installation process:

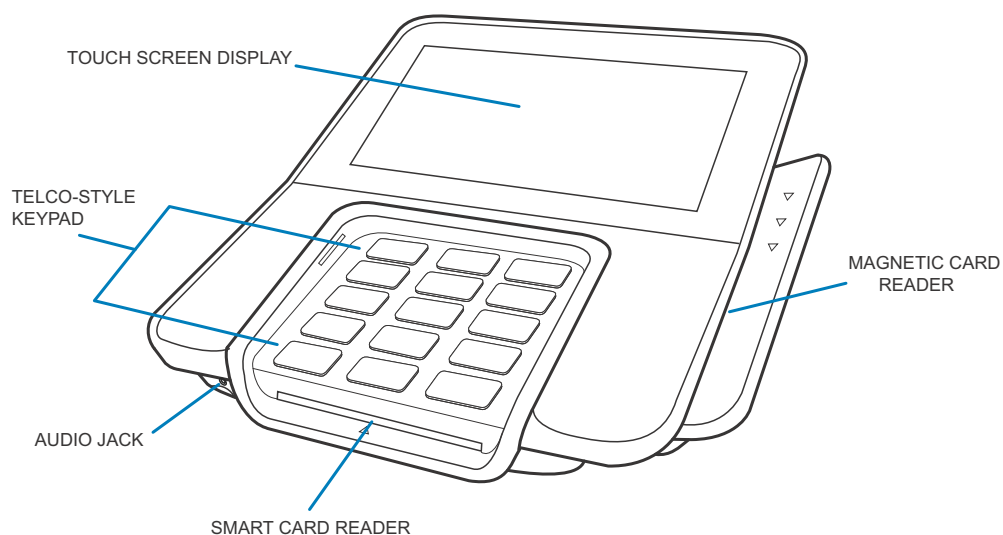

Figure 2 M400 Features

Front Panel The front panel offers the following features:

- A touchscreen display.
- A set of keys that include:
 - A 12-key, telco-style keypad (keypads may vary in style).
 - Three function keys at the bottom of the keypad (from left to right: CANCEL, CLEAR, ENTER).
- A magnetic card reader, built into the right side. LEDs shows the proper swipe direction, with the stripe facing down and towards the keypad.
- A smart card reader, built into the unit's front side. An icon indicates the proper card position and insertion direction.
- A 3.5 mm audio jack to facilitate accessibility for the visually impaired.

NOTE



On screen PIN entry is NOT supported.

Connecting Cables and other Devices

To connect required cable connections and other devices:

- 1 Unscrew and remove cable cover as shown below.

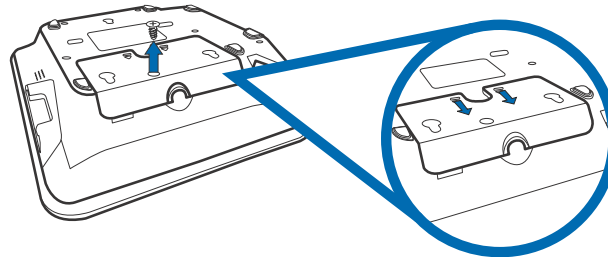

Figure 3 Removing Cable Cover

- 2 Connect required cable connections or optional devices. Attaching the USB C Cable provides multiple connection options.

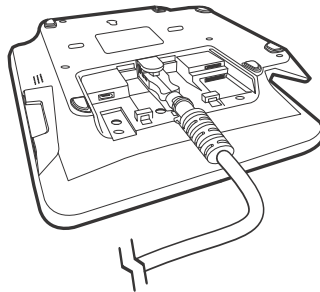

Figure 4 USB Type C Cable Connected on the Rear of the Unit

- 3 Close cable compartment as shown below (optional).

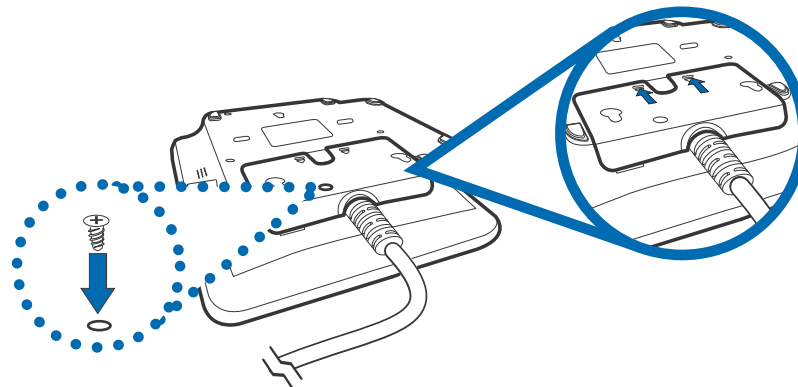

Figure 5 Closing Cable Compartment with Cable Cover

M400 Connection Options

The M400 terminal can be connected to other systems using several methods. They all connect to the M400 using the USB Type C cable connected on the rear of the unit.

Powered USB Cable Powered USB cable (PN CBL445-003-01-A) provides USB signal connectivity and power. It provides a convenient way of connecting other systems of the same type.

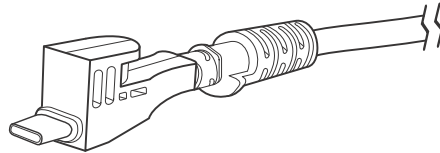

Figure 6 Powered USB Cable (USB Type C)

“M400 WIFI/BT is intended to be provided with Listed external power module with an output rating of 12 Vdc, min. 1 A and evaluated as a Limited Power Source/Class 2 Transformer, output rated SELV, non-energy hazardous.” or equivalent.

ICE Cubes Ice Cubes are devices that offer economical, efficient, flexible, and specific connectivity options. These modules are attached between a base module and an end cap to meet specific customer requirements for different communications interfaces.

The available module functions are provided below:

Base Module (PN 445-101-01-A)

Provides the interface to the M400 terminal through the USB type C connector in the rear of the unit and the optional ICE cube modules. It has:

- Interface to the M400 terminal
- Power supply connection (12 V 1 A)
- Audio out connection (line level stereo)
- ICE cube connection bus to connect to additional cubes

USB Interface Module (PN 445-103-01-A)

This module has:

- ICE cube bus in
- ICE cube bus out
- RJ-50 with USB signals

Ethernet Interface Module (PN 445-104-01-A)

This module support 10/100 Mbits/sec and has:

- ICE cube bus in
- ICE cube bus out
- RJ-50 with Ethernet signals

Supported Configurations

The currently supported ICE cubes configurations are:

Configuration Type	Part Number	Description
USB	CBL445-002-00-A	Base Module + USB Module
2 USB Ports	CBL445-003-00-A	Base Module + USB Module + USB Module
Ethernet	CBL445-006-00-A	Base Module + Ethernet Module
Ethernet with USB	CBL445-007-00-A	Base Module + Ethernet Module + USB Module

Micro SD Card M400 supports micro SD for additional memory.

Installing or Replacing Micro SD Card To install or replace Micro SD card:
1 Turn off the terminal.

- 2 Place the terminal face down on a soft and clean surface.
- 3 Remove cable cover as shown in [Figure 3](#).
- 4 Insert the micro SD card into its slot.

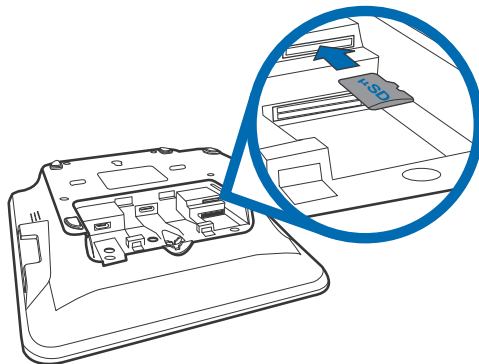

Figure 7 **Inserting a Micro SD Card**

To replace Micro SD card, gently slide out the old micro SD card before inserting a new one.

MSAM Card

You may need to install one or two Multiple Security Access Module (MSAM) cards or replace an old one.



CAUTION Observe standard precautions in handling electrostatically sensitive devices. Electrostatic discharge can damage the equipment. Verifone recommends using a grounded anti-static wrist strap.

Installing or Replacing MSAM Card

To install or replace MSAM cards:

- 1 Power off the terminal.
- 2 Place the terminal face down on a soft and clean surface.
- 3 Remove the cable cover of the unit.
- 4 Insert the SAM cards. Carefully slide the cards one at a time into the slots until fully inserted.

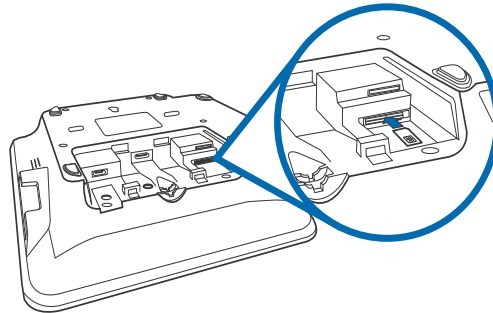

Figure 8 SAM Insertion



NOTE Position the card's gold contacts facing upward toward the user. The card slot in the terminal has a set of contacts. The MSAM card has a notch on one corner to ensure that it fits into the connector base in only one way.

To replace SAM card, gently slide out the old SAM card before inserting a new one.

Terminal Power Source

The terminal is powered by an external AC/DC power pack. When you have finished installing the necessary cards and/or optional devices, you are ready to connect the terminal to the power source.

The terminal requires connection to a power outlet with a dedicated circuit or an uninterruptible power supply (UPS). If other devices are plugged into the same circuit, the terminal can potentially experience power fluctuations that might cause it to malfunction. The terminal shuts down automatically once power source is removed.

WARNING



Do not connect the terminal to the power supply until all peripherals are attached.

Using an incorrectly rated power supply can damage the unit or cause it not to work properly. Use only a power pack with P/N PWR445-001-01-A. See [Specifications](#) for detailed power supply specifications.

Do not plug the power pack into an outdoor outlet or operate the terminal outdoors. Disconnecting power during a transaction can also cause unstored data files to be lost.

NOTE



Verifone recommends installing a power surge protector to protect against possible damage caused by lightning strikes and electrical surges.

Connecting M400 Terminal to a Power Source

To connect M400 terminal to a power source:

- 1 Connect the Powered USB cable (PN CBL445-003-01-A) to the USB Type C port at the back of the terminal.

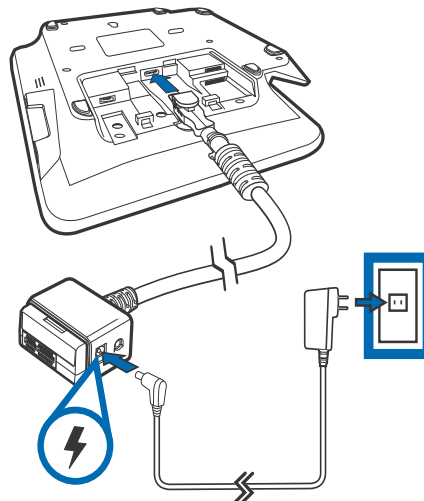

Figure 9 Connecting Base Cable to Terminal

- 2 Plug in power supply to the power connection port on the base module.
- 3 Plug the AC power cord into a wall outlet or power surge protector.
- 4 Close cable cover (optional).

Calibrate Touch Panel

The terminal requires a touch screen calibration at the time of installation. The terminal should be powered on and allowed to stabilize at normal operating temperature; usually this takes no longer than 60 seconds, even if the terminal was previously in a cooler or warmer location. The touch screen calibration procedure should then be performed. Also, while in System Mode, verify the time on the unit is correct.

Calibrating Touch Screen

To calibrate the touch screen:

- 1 Access System Mode. Login using Supervisor user profile.
- 2 Select **Administration**.
- 3 Select **Calibrate Touch Panel**.
- 4 A message is displayed on the screen, press **OK** to start calibration.
- 5 Follow on-screen prompts or instructions.

Smart Card Reader

The smart card transaction procedure can vary depending on the application. Verify the proper procedure with your application provider before performing a smart card transaction.

Using the Smart Card Reader

To use the smart card reader:

- 1 Position the smart card with the gold contacts facing upward.
- 2 Insert the card into the smart card reader slot in a smooth, continuous motion until it sets firmly.
- 3 Remove the card only when the display indicates the transaction is complete.

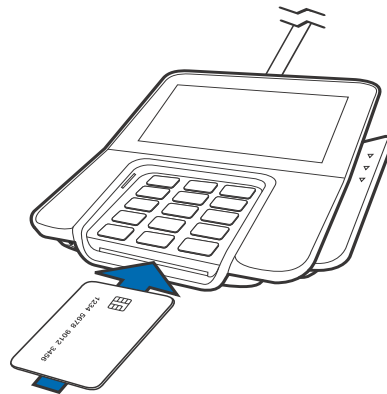

Figure 10 Smart Card Reader



Leave the smart card in the card reader until the transaction is completed. Premature card removal can invalidate a transaction.

Magnetic Card Reader

The terminal has a magnetic card reader that uses a triple track stripe reader. This gives the unit greater reliability over a wide range of swipe speeds and operating environments.

Using the Smart Card Reader (Credit/Debit Card Transaction)

To use the smart card reader (credit/debit card transaction):

- 1 Position a magnetic card with the stripe in the card reader
- 2 Swipe it through the magnetic card reader.

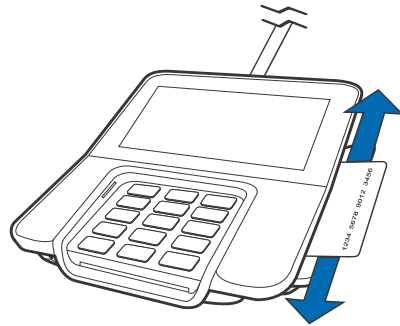

Figure 11 Using the Magnetic Card Reader

Contactless Smart Card Transaction

The terminal support contactless transactions through an integrated contactless module. The terminal only becomes active for contactless smart card transactions when initialized by an application.

Performing a Contactless Smart Card Transaction

To perform a contactless smart card transaction:

- 1 Gently tap the card onto or hold the card (within 4 cm) against the surface of the terminal display.
- 2 An activated LED visual on the display accompanied by a short beeping sound indicates a successful transaction.



Figure 12 Contactless Smart Card Transaction



Do not let metallic surfaces come in contact with the contactless module to ensure that it works properly.

M400 WiFi/BT Support

M400 WiFi/BT version includes an integrated WLAN RF transceiver for Wireless LAN systems with advanced power management, and an integrated radio transceiver for Bluetooth wireless systems.

Bluetooth Support

Supports Eddystone and iBeacon profiles only.

Wireless Transaction

M400 supports wireless transactions. Wireless transactions occur when initialized by an application.

Optional Accessories

These accessories can be used to further enhance the device's functionality. See [Accessories and Documentation](#) for additional information.

Privacy Shield

The privacy shield is used to hide the keys while the cardholder enters a PIN during a transaction.

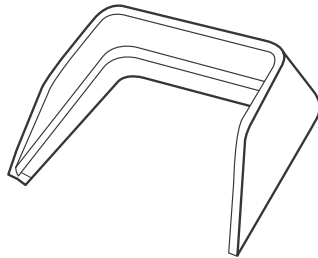

Figure 13 M400 Privacy Shield

Installing the Privacy Shield

To install a privacy shield:

- 1 Squeeze in sides to slide in hooks into the slot.

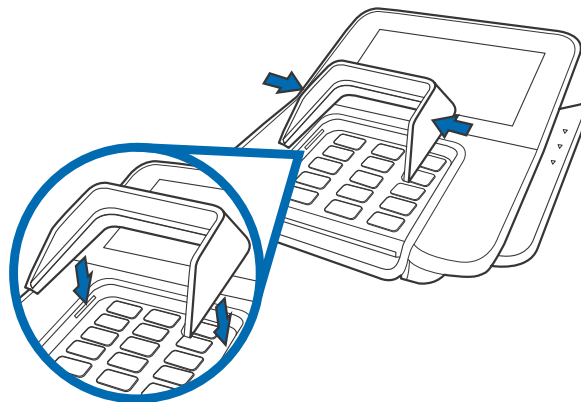

Figure 14 Installing the Privacy Shield

- 2 Release to lock-in hooks in place.



Figure 15 Privacy Shield attached to Terminal

Stand A mounting device that serves as the terminal's docking station and adds support during customer pin entry. The stand can be positioned on a countertop and can be adjusted during transactions for convenience.

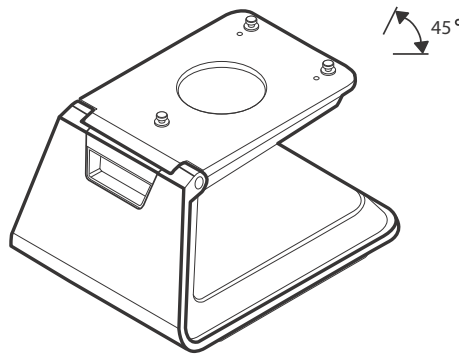

Figure 16 M400 Series Stand

Docking the Terminal on the Stand To dock the terminal on the stand:

- 1 Place the terminal on the base. Ensure that the stand screws align with the keyholes found at the back of the terminal.

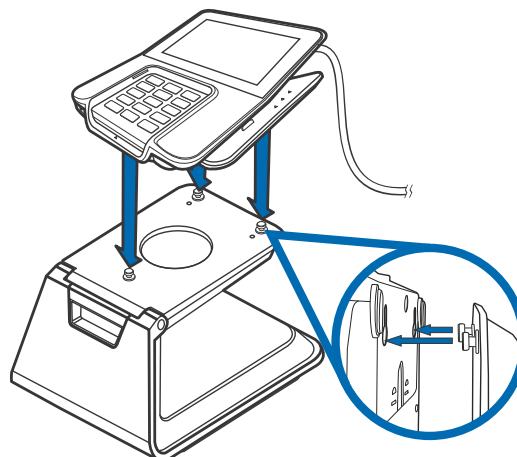

Figure 17 Docking Terminal onto the Stand

- 2 Slide down terminal to lock in place.

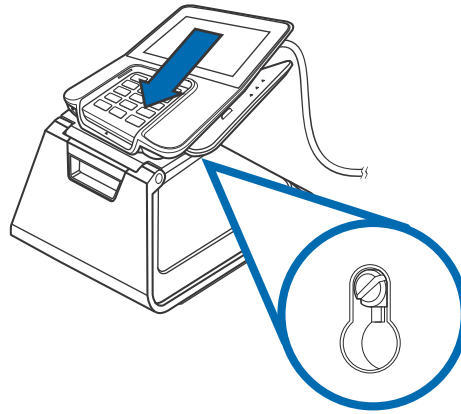

Figure 18 Locking Terminal in Place

Undocking the Terminal from the Stand

To undock the terminal from the stand:

- 1 Slide off terminal upward to unhook the terminal from the stand.

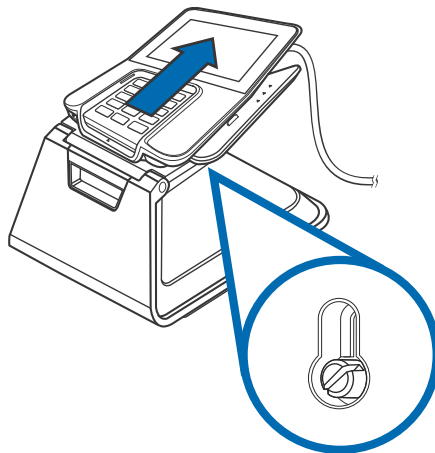

Figure 19 Undocking Terminal from the Stand

- 2 Lift terminal off the stand.

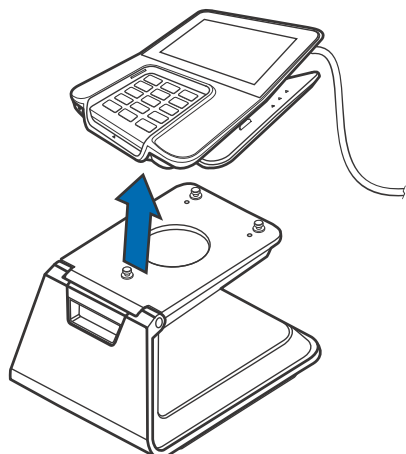

Figure 20 Lifting Terminal off the Stand

NOTE

When conducting customer transactions, you can remove the terminal or adjust the stand orientation for convenience.

**External and
Optional Devices**

The ICE Cube, while connected to a terminal, supports peripheral devices designed for use with electronic point-of-sale system such as ECR, cash drawer, barcode scanner, external keyboard, weighing scale, external printer, external speakers, and PINpad through a serial or USB Host connection.

CAUTION

Remove the power cord from the base module before connecting any peripheral device. Reconnect the power cord only *after* you have finished connecting the peripheral device(s).

Specifications

This chapter discusses power requirements, dimensions, and other specifications of the terminal.

- Power Rating** • 12 V DC, 1 A

- Power Pack** • PWR445-001-01-A
• UL/cUL, ITE listed, LPS power supply
• Input rated: 100-240 V AC, 50/60 Hz
• Output rated: 12 V DC, 1 A, 12 W

- Temperature** • Operating temperature: -5° to 40° C (23° to 122° F)
• Storage temperature: -20° to 60° C (-4° to 140° F)

- External Dimensions** • Length: 173 mm (6.81 in.)
• Width: 175 mm (6.89 in.)
• Depth: 43 mm (1.69 in.)

- Weight** • Unit weight: 430 g

- Processor** • 1 GHz ARM Cortex A9

- Memory** • 256 MB of flash memory and 512 MB SDRAM

- Display** • 5" IPS LCD

- Magnetic Card Reader** • Triple track (tracks 1, 2, 3), high coercivity, bi-directional

- Primary Smart Card** • ISO 7816, 1.8 V, 3 V, 5 V
• Synchronous and asynchronous cards

SAM Card Reader

The terminal has two dual stacking Security Access Modules (SAMs) card slots.

SD Card Reader

The terminal has one Micro Secure Digital (SD) card slot.

Integrated Contactless Reader

ISO 14443, ISO 18092, EMV, FeliCa

Keypad

- 12-key Telco-style keypad
- Three color-coded function keys below the keypad
- Keys can be simulated on touchscreen

Audio Jack

3.5 mm headphone jack

Peripheral Ports

- one USB Type C port for ICE Cube Base module connection.
- one Micro-USB port for a graphometric stylus connection.

Security

Complies to PCI 4.x requirements, as well as many regional security requirements.



Maintenance and Cleaning

The M400 device has no user-maintainable parts. It can, however, be cleaned.

General Care

Your terminal device is a product of superior design and craftsmanship and should be treated with care. The following suggestions will help you protect your warranty coverage.

- Keep the device dry. Precipitation, humidity, and all types of liquids or moisture can contain minerals that will corrode electronic circuits. If your device does get wet, switch off the power, and allow the device to dry completely before replacing it.
- Do not use or store the device in dusty and dirty areas. Its moving parts and electronic components can be damaged.
- Do not store the device in hot areas. High temperatures can shorten the life of electronic devices, damage batteries, and warp or melt certain plastics.
- Do not store the device in cold areas. Moisture can form inside the device and damage electronic circuit boards when the device returns to its normal temperature.
- Do not drop, knock, or shake the device. Rough handling can break internal circuit boards and fine mechanics.
- Do not paint the device. Paint can clog the moving parts and prevent proper operation.
- Keep the device free from any small and loose items (such as paper clips, staples, or coins) that could accidentally get inside it through an opening, such as the SD card reader slot or the primary smart card reader slot.
- Do not attempt to open the device other than as instructed in this guide. This device has security features that protect it from tampering. For example, the file content will be deleted if the device's outer casing is opened.

These suggestions apply equally to your terminal device, or any of its attachments or accessories. If your device is not working properly, take it to the nearest authorized service facility for servicing or replacement. For your safety, have this device serviced only by a Verifone-authorized service provider.

Surface Cleaning

To clean the device, use a clean cloth slightly dampened with water and a drop or two of mild soap. For stubborn stains, use alcohol or an alcohol-based cleaner.

CAUTION



Never use thinner, trichloroethylene, or ketone-based solvents – they can deteriorate plastic or rubber parts.

Do not spray cleaners or other solutions directly onto the keypad or display.

Magnetic Card Reader

Dirt accumulation can lead to MSR reading problems unless you clean the Magnetic Stripe Reader (MSR) on a regular basis (daily to once a week, depending on usage). Clean the MSR using commercially available card reader cleaning cards or using recommended Verifone MSR-cleaning card (PN 02746-02).

NOTE



If using a commercially available cleaning card use **ONLY** an approved MSR cleaning card made specifically for POS MSR Card reader terminals or Petroleum MSR card readers.

Smart Card Reader

Do not attempt to clean the Smart Card Reader (SCR). Doing so may void any warranty. For smart card reader service, contact your Verifone distributor or service provider.

CAUTION



If you find foreign objects in the SCR, send your terminal to a Verifone authorized repair center.

Do not use Verifone's recommended MSR-cleaning card (PN 02746-02) or commercially available card reader cleaning cards with the SCR.

Additional Safety Information

The following are additional safety information in using this device.

Power Adapter

Use only the power adapter that came with your device. Adapters for other electronic devices may look similar, but they may affect your device's performance or damage it.

Potentially Explosive Environments

Do not use this device in any area with a potentially explosive atmosphere. Follow all signs and instructions. Potentially explosive atmospheres include areas where you would normally be advised to turn off your vehicle engine. Sparks in such areas could cause an explosion or fire resulting in bodily injury or even death.

Service and Support

Contact your local Verifone representative or service provider for any problems on your terminal.

For product service and repair information:

- USA – Verifone Service and Support Group, 1-800-834-4366, Monday - Friday, 8 A.M. - 8 P.M., Eastern time.
- International – Contact your Verifone representative.

Service Returns

You must obtain a Merchandise Return Authorization (MRA) number before returning the terminal to Verifone. The following procedure describes how to return one or more terminals for repair or replacement (U.S. customers only).



For international customers, please contact your local Verifone representative for assistance with your service, return, or replacement.

Returning One or More Terminals for Repair or Replacement

- 1 Gather the following information from the printed labels on the bottom of each terminal to be returned:
 - Product ID, including the model and part number. For example, “M400”, “m445-xxx-xx”, and “PTID xxxxxxxx.”
 - Serial number (S/N xxx-xxx-xxx).
- 2 Obtain the MRA numbers by completing the following:
 - Call Verifone within the United States toll-free at 1-800-Verifone and follow the automated menu options.
 - Select the MRA option from the automated message. The MRA department is open Monday–Friday, 8 A.M.–8 P.M., Eastern time.
 - Give the MRA representative the information gathered in [Step 1](#). If the list of serial numbers is long, you can fax the list, along with the information gathered in [Step 1](#), to the MRA department at 1-727-953-4172 (U.S.).
 - Address the fax clearly to the attention of the “Verifone MRA Dept.” Include a telephone number where you can be reached and your fax number.
 - Complete the Inquiry Contact Form at http://www.verifone.com/aboutus/contact/contact_form.cfm.
 - Address the Subject box with to “Verifone MRA Dept.”

- Reference the model and part number in the Note box



One MRA number must be issued for each terminal you return to Verifone, even if you are returning several of the same model.

- 3 Describe the problem(s).
- 4 Provide the shipping address where the repaired or replacement unit must be returned.
- 5 Keep a record of the following items:
 - Assigned MRA number(s).
 - Verifone serial number assigned to the terminal you are returning for service or repair (serial numbers are located on the bottom of the unit).
 - Shipping documentation, such as air bill numbers used to trace the shipment.
 - Model(s) returned (model numbers are located on the Verifone label on the bottom of the terminal).

Accessories and Documentation

Verifone produces accessories and documentation for the terminal. Refer to the part number in the left column when ordering.

Verifone Online Store at www.store.verifone.com

- USA – Verifone Customer Development Center, 1-800-834-4366, Monday - Friday, 7 A.M. - 8 P.M., Eastern time
- International – Contact your Verifone representative

Below are accessories used with your terminal. Contact your Verifone distributor to determine which of the accessories fit your requirements.

Table 4 Accessories and VPNs

Part Number	Description
PWR445-001-01-A	M400 DC power pack
VPN 02746-01	MSR Cleaning kit
PPL445-013-01-A	PCI Privacy Shield
TBD	Multilane Stand
STY445-001-01-A	Passive Stylus
PPL445-008-01-A	Stylus Holster
445-101-01-A	ICE Cube Base Module
445-103-01-A	USB Interface Module
445-104-01-A	Ethernet Interface Module

Refer to the following set of documents to learn more about the terminal:

<i>M400 Certifications and Regulations</i>	VPN - DOC445-001-EN
<i>M400 Series Quick Installation Guide</i>	VPN - DOC445-002-EN
<i>M400 Series Ice Cube Certifications and Regulations</i>	VPN - DOC445-005-EN
<i>M400 Series Ice Cube Quick Installation Guide</i>	VPN - DOC445-006-EN
<i>M400 Series Stand Quick Installation Guide</i>	VPN - DOC445-007-EN
<i>M400 Series Privacy Shield Quick Installation Guide</i>	VPN - DOC445-008-EN
<i>VOS Programmers Manual</i>	VPN - DOC00501

Troubleshooting Guidelines

This chapter lists typical examples of malfunctions that you may encounter while operating your terminal and the steps that you can take to resolve them.

The troubleshooting guidelines provided in the following sections are included to assist successful installation and configuration of the terminal. Please read these troubleshooting examples if you are having problems operating your unit. Contact your local Verifone representative for assistance if the problem persists even after performing the outlined guidelines or if the problem is not described.



NOTE The terminal comes equipped with tamper-evident labels. It contains no user-serviceable parts. Do not, under any circumstance, attempt to disassemble the unit. Perform only those adjustments or repairs specified in this guide. Contact your local Verifone service provider for all other services. Service conducted by parties other than authorized Verifone representatives may void any warranty.



CAUTION All units require use of a power supply.

Use only a Verifone-supplied power pack. Using an incorrectly rated power supply may damage the unit or cause it not to work properly. Ensure that the power supply used to power the unit matches the requirements specified on the back of the unit (see [Specifications](#) for detailed power supply specifications) before troubleshooting. If not, obtain the appropriately rated power supply before continuing with troubleshooting.

Terminal Does Not Start

If the terminal does not start:

- Ensure that the terminal is plugged into a dedicated power source.
- Check power cable connector is plugged in properly.

Terminal Display Does Not Show Correct/Readable Info

If the terminal display does not show correct/readable info:

- Check all cable connections. If the problem persists, contact your local Verifone representative for assistance.

Blank Display

When the terminal display is blank:

- If the terminal display is dark, tap the screen with the stylus or your finger. If the unit was in screen-saver mode, the screen will turn on when touched.
- If the display does not show correct or readable information, check all cable connections. If the problem persists, contact your local Verifone representative for assistance.

Keypad Does Not Respond

If the keypad does not respond properly:

- Check the terminal display. If it displays the wrong character or nothing at all when you press a key, follow the steps outlined in [Transactions Fail To Process](#).
- Refer to the user documentation for that application if pressing a function key does not perform the expected action to ensure you are entering data correctly.
- Contact your local Verifone representative if the problem persists.

Transactions Fail To Process

There are several possible reasons why the unit may not be processing transactions. Use the following steps to troubleshoot failures.

Checking Magnetic Card Reader

To check magnetic card reader:

- 1 Perform a test transaction using one or more different magnetic stripe cards to ensure the problem is not a defective card.
- 2 Ensure that you are swiping cards properly (see [Magnetic Card Reader](#)).
- 3 Process a transaction manually using the keypad instead of the card reader. If the manual transaction works, the problem may be a defective card reader.
- 4 Contact your local Verifone representative if the problem persists.

Checking Smart Card Reader

To check smart card reader:

- 1 Perform a test transaction using several different smart cards to ensure the problem is not a defective card.
- 2 Ensure that the card is inserted correctly (see [Smart Card Reader](#)).
- 3 Ensure the MSAM cards are properly inserted in the slots and are properly secured (see [MSAM Card](#)).
- 4 Contact your local Verifone representative if the problem persists.



Verifone, Inc.
1-800-Verifone
www.verifone.com

M400

Installation Guide

