



# FCC TEST REPORT (15.247)

**REPORT NO.:** RF150513C14  
**MODEL NO.:** e355  
**FCC ID:** B32E355  
**RECEIVED:** May 13, 2015  
**TESTED:** May 27, 2015 ~ Jun. 10, 2015  
**ISSUED:** Jun. 18, 2015

**APPLICANT:** Verifone, Inc.

**ADDRESS:** 1400 West Stanford Ranch Road Suite 200 Rocklin  
CA 95765 USA

**ISSUED BY:** Bureau Veritas Consumer Products Services (H.K.)  
Ltd., Taoyuan Branch

**LAB ADDRESS:** No. 47-2, 14th Ling, Chia Pau Vil., Lin Kou Dist., New  
Taipei City, Taiwan ( R.O.C )

**TEST LOCATION:** No.19, Hwa Ya 2nd Rd., Wen Hwa Vil., Kwei Shan  
Dist., Taoyuan City 33383, Taiwan, R.O.C.

This report should not be used by the client to claim product certification, approval, or endorsement by TAF or any government agencies.



This report is for your exclusive use. Any copying or replication of this report to or for any other person or entity, or use of our name or trademark, is permitted only with our prior written permission. This report sets forth our findings solely with respect to the test samples identified herein. The results set forth in this report are not indicative or representative of the quality or characteristics of the lot from which a test sample was taken or any similar or identical product unless specifically and expressly noted. Our report includes all of the tests requested by you and the results thereof based upon the information that you provided to us. You have 60 days from date of issuance of this report to notify us of any material error or omission caused by our negligence, provided, however, that such notice shall be in writing and shall specifically address the issue you wish to raise. A failure to raise such issue within the prescribed time shall constitute your unqualified acceptance of the completeness of this report, the tests conducted and the correctness of the report contents. Unless specific mention, the uncertainty of measurement has been explicitly taken into account to declare the compliance or non-compliance to the specification.



# TABLE OF CONTENTS

RELEASE CONTROL RECORD .....	4
1. CERTIFICATION.....	5
2. SUMMARY OF TEST RESULTS .....	6
2.1 MEASUREMENT UNCERTAINTY.....	6
3. GENERAL INFORMATION .....	7
3.1 GENERAL DESCRIPTION OF EUT .....	7
3.2 DESCRIPTION OF TEST MODES .....	8
3.2.1 TEST MODE APPLICABILITY AND TESTED CHANNEL DETAIL.....	9
3.3 DESCRIPTION OF SUPPORT UNITS .....	11
3.3.1 CONFIGURATION OF SYSTEM UNDER TEST .....	11
3.4 DUTY CYCLE TEST SIGNAL.....	12
3.5 GENERAL DESCRIPTION OF APPLIED STANDARDS.....	13
4. TEST TYPES AND RESULTS (FOR 2.4GHz BAND).....	14
4.1 RADIATED EMISSION AND BANDEDGE MEASUREMENT .....	14
4.1.1 LIMITS OF RADIATED EMISSION AND BANDEDGE MEASUREMENT .....	14
4.1.2 TEST INSTRUMENTS.....	15
4.1.3 TEST PROCEDURES .....	16
4.1.4 DEVIATION FROM TEST STANDARD .....	16
4.1.5 TEST SETUP .....	17
4.1.6 EUT OPERATING CONDITIONS .....	17
4.1.7 TEST RESULTS.....	18
4.2 CONDUCTED EMISSION MEASUREMENT .....	28
4.2.1 LIMITS OF CONDUCTED EMISSION MEASUREMENT .....	28
4.2.2 TEST INSTRUMENTS.....	28
4.2.3 TEST PROCEDURES .....	29
4.2.4 DEVIATION FROM TEST STANDARD .....	29
4.2.5 TEST SETUP .....	30
4.2.6 EUT OPERATING CONDITIONS .....	30
4.2.7 TEST RESULTS.....	31
4.3 6dB BANDWIDTH MEASUREMENT .....	33
4.3.1 LIMITS OF 6dB BANDWIDTH MEASUREMENT .....	33
4.3.2 TEST SETUP .....	33
4.3.3 TEST INSTRUMENTS.....	33
4.3.4 TEST PROCEDURE .....	33
4.3.5 DEVIATION FROM TEST STANDARD .....	33
4.3.6 EUT OPERATING CONDITIONS .....	33
4.3.7 TEST RESULTS.....	34
4.4 CONDUCTED OUTPUT POWER .....	36
4.4.1 LIMITS OF CONDUCTED OUTPUT POWER MEASUREMENT.....	36
4.4.2 TEST SETUP .....	36
4.4.3 TEST INSTRUMENTS.....	36
4.4.4 TEST PROCEDURES .....	36
4.4.5 DEVIATION FROM TEST STANDARD .....	36
4.4.6 EUT OPERATING CONDITIONS .....	36
4.4.7 TEST RESULTS.....	37
4.5 POWER SPECTRAL DENSITY MEASUREMENT.....	38
4.5.1 LIMITS OF POWER SPECTRAL DENSITY MEASUREMENT .....	38
4.5.2 TEST SETUP .....	38
4.5.3 TEST INSTRUMENTS.....	38
4.5.4 TEST PROCEDURE .....	38
4.5.5 DEVIATION FROM TEST STANDARD .....	38
4.5.6 EUT OPERATING CONDITION.....	38



A D T

4.5.7	TEST RESULTS.....	39
4.6	CONDUCTED OUT OF BAND EMISSION MEASUREMENT .....	41
4.6.1	LIMITS OF CONDUCTED OUT OF BAND EMISSION MEASUREMENT .....	41
4.6.2	TEST SETUP .....	41
4.6.3	TEST INSTRUMENTS .....	41
4.6.4	TEST PROCEDURE .....	41
4.6.5	DEVIATION FROM TEST STANDARD .....	41
4.6.6	EUT OPERATING CONDITION.....	41
4.6.7	TEST RESULTS.....	42
5.	PHOTOGRAPHS OF THE TEST CONFIGURATION.....	48
6.	INFORMATION ON THE TESTING LABORATORIES .....	49
7.	APPENDIX A – MODIFICATIONS RECORDERS FOR ENGINEERING CHANGES TO THE EUT BY THE LAB .....	50



A D T

## RELEASE CONTROL RECORD

ISSUE NO.	REASON FOR CHANGE	DATE ISSUED
RF150513C14	Original release	Jun. 18, 2015



## 1. CERTIFICATION

**PRODUCT:** Point of Sale Terminal  
**MODEL NO.:** e355  
**BRAND:** Verifone  
**APPLICANT:** Verifone, Inc.  
**TESTED:** May 27, 2015 ~ Jun. 10, 2015  
**TEST SAMPLE:** Identical Prototype  
**STANDARDS:** **FCC Part 15, Subpart C (Section 15.247)**  
ANSI C63.10-2013

The above equipment (model: e355) has been tested by **Bureau Veritas Consumer Products Services (H.K.) Ltd., Taoyuan Branch**, and found compliance with the requirement of the above standards. The test record, data evaluation & Equipment Under Test (EUT) configurations represented herein are true and accurate accounts of the measurements of the sample's EMC characteristics under the conditions specified in this report.

**PREPARED BY** : Rona Chen , **DATE** : Jun. 18, 2015  
Rona Chen / Specialist

**APPROVED BY** : Kay Wu , **DATE** : Jun. 18, 2015  
Kay Wu / Supervisor

## 2. SUMMARY OF TEST RESULTS

The EUT has been tested according to the following specifications:

APPLIED STANDARD: FCC PART 15, SUBPART C (SECTION 15.247)			
STANDARD SECTION	TEST TYPE	RESULT	REMARK
15.207	AC Power Conducted Emission	PASS	Meet the requirement of limit. Minimum passing margin is -16.11dB at 0.15000MHz.
15.205 & 15.209	Radiated Emissions	PASS	Meet the requirement of limit. Minimum passing margin is -2.46dB at 2386MHz.
15.247(d)	Band Edge Measurement	PASS	Meet the requirement of limit.
15.247(d)	Antenna Port Emission	PASS	Meet the requirement of limit.
15.247(a)(2)	6dB bandwidth	PASS	Meet the requirement of limit.
15.247(b)	Conducted power	PASS	Meet the requirement of limit.
15.247(e)	Power Spectral Density	PASS	Meet the requirement of limit.
15.203	Antenna Requirement	PASS	No antenna connector is used.

### 2.1 MEASUREMENT UNCERTAINTY

Where relevant, the following measurement uncertainty levels have been estimated for tests performed on the EUT as specified in CISPR 16-4-2:

MEASUREMENT	FREQUENCY	UNCERTAINTY
Conducted emissions	9kHz~30MHz	2.44 dB
Radiated emissions	30MHz ~ 200MHz	2.93 dB
	200MHz ~1000MHz	2.95 dB
	1GHz ~ 18GHz	2.26 dB
	18GHz ~ 40GHz	1.94 dB

This uncertainty represents an expanded uncertainty expressed at approximately the 95% confidence level using a coverage factor of  $k = 2$ .

### 3. GENERAL INFORMATION

#### 3.1 GENERAL DESCRIPTION OF EUT

<b>EUT</b>	Point of Sale Terminal
<b>MODEL NO.</b>	e355
<b>POWER SUPPLY</b>	5.0Vdc (adapter or host equipment) 3.8Vdc (Li-ion battery)
<b>MODULATION TYPE</b>	CCK, DQPSK, DBPSK for DSSS 64QAM, 16QAM, QPSK, BPSK for OFDM
<b>MODULATION TECHNOLOGY</b>	DSSS, OFDM
<b>TRANSFER RATE</b>	802.11b: 11.0 / 5.5 / 2.0 / 1.0 Mbps 802.11g: 54.0 / 48.0 / 36.0 / 24.0 / 18.0 / 12.0 / 9.0 / 6.0 Mbps 802.11n: up to MCS7
<b>OPERATING FREQUENCY</b>	2412 ~ 2462MHz
<b>NUMBER OF CHANNEL</b>	11 for 802.11b, 802.11g, 802.11n (20MHz)
<b>OUTPUT POWER</b>	249.46mW
<b>ANTENNA TYPE</b>	PCB antenna with 1.07dBi gain
<b>ANTENNA CONNECTOR</b>	NA
<b>DATA CABLE</b>	Refer to Note as below
<b>I/O PORTS</b>	Refer to user's manual
<b>ACCESSORY DEVICES</b>	Refer to Note as below

**NOTE:**

1. The EUT contains following accessory devices.

ITEM	BRAND	MODEL	SPECIFICATION
Adapter	Verifone	MU12AF050200-A1	I/P: 100-240Vac, 50/60Hz, 400mA O/P: 5Vdc, 2A
Battery	Verifone	BPK087-500	1.8m Non-shielded cable with core 3.8Vdc, 1960mAh

2. Physically, the EUT provides 1 completed transmitter and 1 receiver.

MODULATION MODE	TX FUNCTION
802.11b	1TX
802.11g	1TX
802.11n (20MHz)	1TX

3. The above EUT information is declared by the manufacturer and for more detailed features description, please refer to the manufacturer's specifications or User's Manual.

### 3.2 DESCRIPTION OF TEST MODES

#### FOR 2.4GHz:

11 channels are provided for 802.11b, 802.11g and 802.11n (20MHz):

CHANNEL	FREQUENCY	CHANNEL	FREQUENCY
1	2412MHz	7	2442MHz
2	2417MHz	8	2447MHz
3	2422MHz	9	2452MHz
4	2427MHz	10	2457MHz
5	2432MHz	11	2462MHz
6	2437MHz		



### 3.2.1 TEST MODE APPLICABILITY AND TESTED CHANNEL DETAIL

#### WLAN 2.4GHz:

EUT CONFIGURE MODE	APPLICABLE TO				DESCRIPTION
	RE≥1G	RE<1G	PLC	APCM	
-	√	√	√	√	-

Where **RE≥1G**: Radiated Emission above 1GHz      **RE<1G**: Radiated Emission below 1GHz  
**PLC**: Power Line Conducted Emission      **APCM**: Antenna Port Conducted Measurement

**NOTE:** The EUT had been pre-tested on the positioned of each 3 axis. The worst case was found when positioned on **Z-plane**.

#### RADIATED EMISSION TEST (ABOVE 1GHz):

Pre-Scan has been conducted to determine the worst-case mode from all possible combinations between available modulations, data rates and antenna ports (if EUT with antenna diversity architecture).

Following channel(s) was (were) selected for the final test as listed below.

EUT CONFIGURE MODE	MODE	AVAILABLE CHANNEL	TESTED CHANNEL	MODULATION TECHNOLOGY	MODULATION TYPE	DATA RATE (Mbps)
-	802.11b	1 to 11	1, 6, 11	DSSS	DBPSK	1.0
-	802.11g	1 to 11	1, 6, 11	OFDM	BPSK	6.0
-	802.11n (20MHz)	1 to 11	1, 6, 11	OFDM	BPSK	MCS0

#### RADIATED EMISSION TEST (BELOW 1GHz):

Pre-Scan has been conducted to determine the worst-case mode from all possible combinations between available modulations, data rates and antenna ports (if EUT with antenna diversity architecture).

Following channel(s) was (were) selected for the final test as listed below.

EUT CONFIGURE MODE	MODE	AVAILABLE CHANNEL	TESTED CHANNEL	MODULATION TECHNOLOGY	MODULATION TYPE	DATA RATE (Mbps)
-	802.11b	1 to 11	1	DSSS	DBPSK	1.0

#### POWER LINE CONDUCTED EMISSION TEST:

Pre-Scan has been conducted to determine the worst-case mode from all possible combinations between available modulations, data rates and antenna ports (if EUT with antenna diversity architecture).

Following channel(s) was (were) selected for the final test as listed below.

EUT CONFIGURE MODE	MODE	AVAILABLE CHANNEL	TESTED CHANNEL	MODULATION TECHNOLOGY	MODULATION TYPE	DATA RATE (Mbps)
-	802.11b	1 to 11	1	DSSS	DBPSK	1.0

**BANDEDGE MEASUREMENT:**

- Pre-Scan has been conducted to determine the worst-case mode from all possible combinations between available modulations, data rates and antenna ports (if EUT with antenna diversity architecture).
- Following channel(s) was (were) selected for the final test as listed below.

EUT CONFIGURE MODE	MODE	AVAILABLE CHANNEL	TESTED CHANNEL	MODULATION TECHNOLOGY	MODULATION TYPE	DATA RATE (Mbps)
-	802.11b	1 to 11	1, 6, 11	DSSS	DBPSK	1.0
-	802.11g	1 to 11	1, 6, 11	OFDM	BPSK	6.0
-	802.11n (20MHz)	1 to 11	1, 6, 11	OFDM	BPSK	MCS0

**ANTENNA PORT CONDUCTED MEASUREMENT:**

- This item includes all test value of each mode, but only includes spectrum plot of worst value of each mode.
- Pre-Scan has been conducted to determine the worst-case mode from all possible combinations between available modulations, data rates and antenna ports (if EUT with antenna diversity architecture).
- Following channel(s) was (were) selected for the final test as listed below.

EUT CONFIGURE MODE	MODE	AVAILABLE CHANNEL	TESTED CHANNEL	MODULATION TECHNOLOGY	MODULATION TYPE	DATA RATE (Mbps)
-	802.11b	1 to 11	1, 6, 11	DSSS	DBPSK	1.0
-	802.11g	1 to 11	1, 6, 11	OFDM	BPSK	6.0
-	802.11n (20MHz)	1 to 11	1, 6, 11	OFDM	BPSK	MCS0

**TEST CONDITION:**

APPLICABLE TO	ENVIRONMENTAL CONDITIONS	INPUT POWER	TESTED BY
RE≥1G	25deg. C, 65%RH	120Vac, 60Hz	Gavin Wu
RE<1G	25deg. C, 65%RH	120Vac, 60Hz	Gavin Wu
PLC	25deg. C, 65%RH	120Vac, 60Hz	Toby Tian
APCM	25deg. C, 65%RH	120Vac, 60Hz	Taylor Liu

### 3.3 DESCRIPTION OF SUPPORT UNITS

The EUT has been tested as an independent unit together with other necessary accessories or support units.

#### 3.3.1 CONFIGURATION OF SYSTEM UNDER TEST

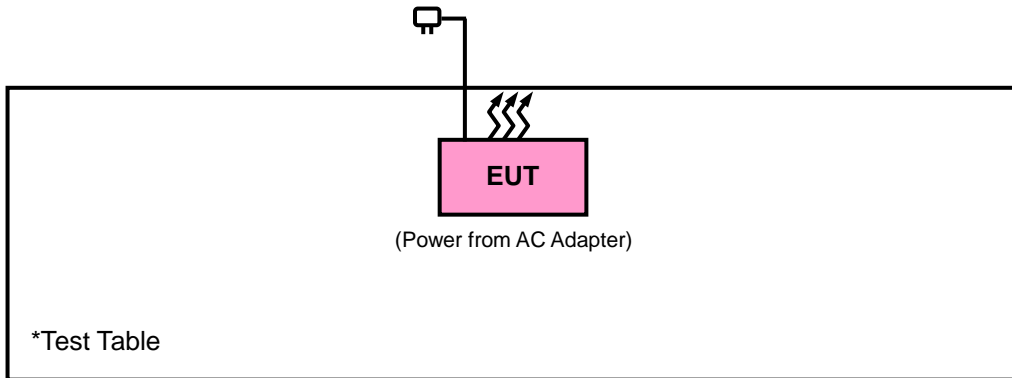

### 3.4 DUTY CYCLE TEST SIGNAL

#### WLAN 2.4GHz

**802.11b:** Duty cycle of test signal is 100 %

**802.11g:** Duty cycle =  $1.418/1.530 = 0.927$ , Duty factor =  $10 * \log(1/0.927) = 0.33$

**802.11n (20MHz):** Duty cycle =  $1.330/1.434 = 0.927$ , Duty factor =  $10 * \log(1/0.927) = 0.33$

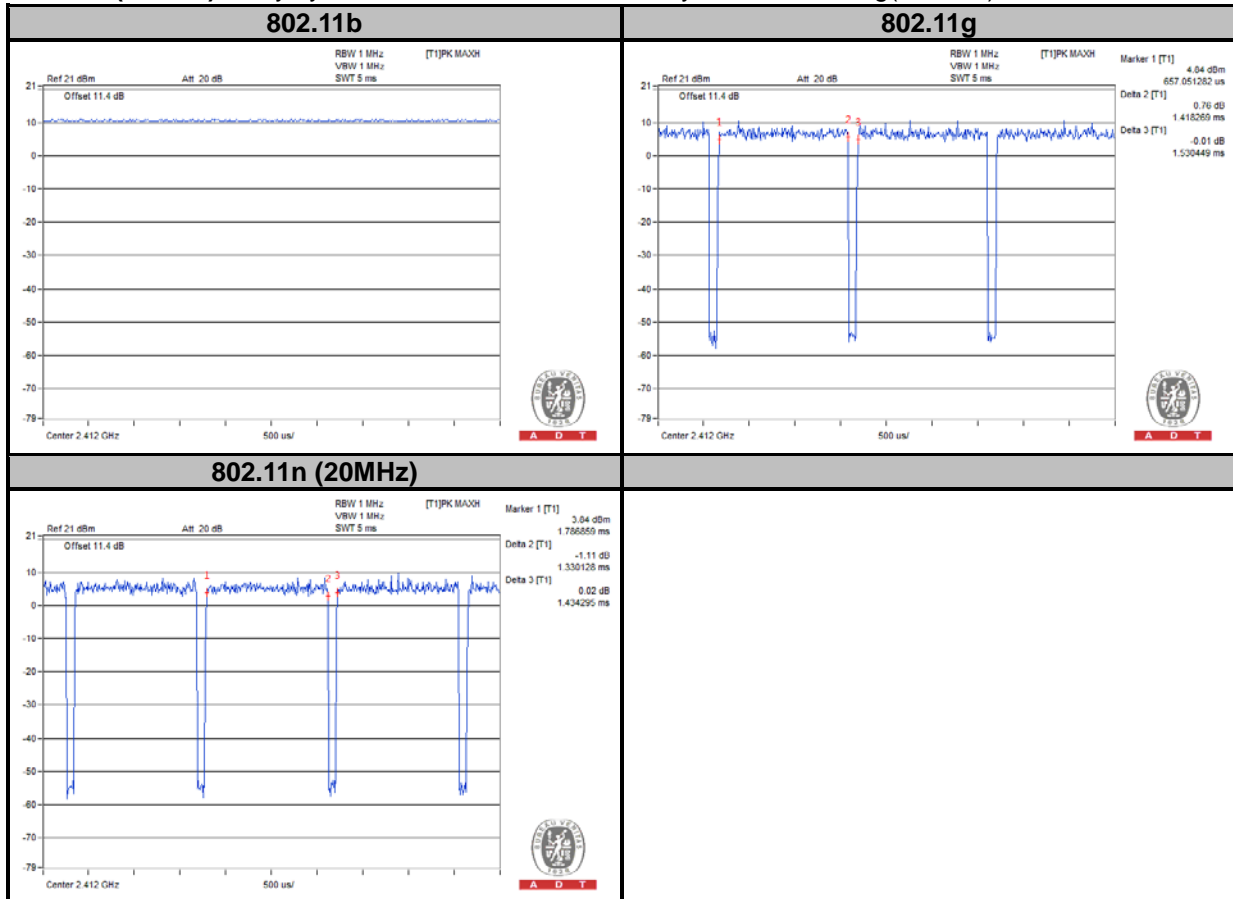



### 3.5 GENERAL DESCRIPTION OF APPLIED STANDARDS

The EUT is a RF Product. According to the specifications of the manufacturer, it must comply with the requirements of the following standards:

**FCC Part 15, Subpart C (15.247)**  
**558074 D01 DTS Meas Guidance v03r02**  
ANSI C63.10-2013

All test items have been performed and recorded as per the above standards.

**NOTE:** The EUT has been verified to comply with the requirements of FCC Part 15, Subpart B, Class B (DoC). The test report has been issued separately.

## 4. TEST TYPES AND RESULTS (FOR 2.4GHz BAND)

### 4.1 RADIATED EMISSION AND BANDEDGE MEASUREMENT

#### 4.1.1 LIMITS OF RADIATED EMISSION AND BANDEDGE MEASUREMENT

Radiated emissions which fall in the restricted bands must comply with the radiated emission limits specified as below table. Other emissions shall be at least 20dB below the highest level of the desired power:

FREQUENCIES (MHz)	FIELD STRENGTH (microvolts/meter)	MEASUREMENT DISTANCE (meters)
0.009 ~ 0.490	2400/F(kHz)	300
0.490 ~ 1.705	24000/F(kHz)	30
1.705 ~ 30.0	30	30
30 ~ 88	100	3
88 ~ 216	150	3
216 ~ 960	200	3
Above 960	500	3

**NOTE:**

1. The lower limit shall apply at the transition frequencies.
2. Emission level (dBuV/m) = 20 log Emission level (uV/m).
3. For frequencies above 1000MHz, the field strength limits are based on average detector, however, the peak field strength of any emission shall not exceed the maximum permitted average limits, specified above by more than 20dB under any condition of modulation.

**4.1.2 TEST INSTRUMENTS**

DESCRIPTION & MANUFACTURER	MODEL NO.	SERIAL NO.	DATE OF CALIBRATION	DUE DATE OF CALIBRATION
Test Receiver Agilent	N9038A	MY51210203	Jan.21, 2015	Jan.21, 2016
Spectrum Analyzer Agilent	N9010A	MY52220314	Sep.03, 2014	Sep.02, 2015
Spectrum Analyzer ROHDE & SCHWARZ	FSU43	101261	Dec. 10, 2014	Dec. 09, 2015
BILOG Antenna SCHWARZBECK	VULB9168	9168-472	Feb. 04, 2015	Feb. 04, 2016
HORN Antenna SCHWARZBECK	BBHA 9120 D	9120D-969	Feb. 09, 2015	Feb. 09, 2016
HORN Antenna SCHWARZBECK	BBHA 9170	9170-480	Feb. 04, 2015	Feb. 04, 2016
Loop Antenna	EM-6879	269	Aug.13, 2014	Aug.12, 2015
Preamplifier EMCI	EMC 012645	980115	Dec. 12, 2014	Dec. 11, 2015
Preamplifier EMCI	EMC 184045	980116	Jan. 09, 2015	Jan. 08, 2016
Preamplifier EMCI	EMC 330H	980112	Dec. 27, 2014	Dec. 26, 2015
RF signal cable HUBER+SUHNNER	SUCOFLEX 104	309219/4 2950114	Oct. 18, 2014	Oct. 17, 2015
RF signal cable HUBER+SUHNNER	SUCOFLEX 104	250130/4	Oct. 18, 2014	Oct. 17, 2015
RF signal cable Worken	RG-213	NA	Nov. 07, 2014	Nov. 06, 2015
Software BV ADT	E3 6.120103	NA	NA	NA
Antenna Tower MF	MFA-440H	NA	NA	NA
Turn Table MF	MFT-201SS	NA	NA	NA
Antenna Tower & Turn Table Controller MF	MF-7802	NA	NA	NA
Bluetooth Tester	CBT	100980	Apr. 18, 2013	Apr. 17, 2015
Power Meter	ML2495A	1232002	Sep. 17, 2014	Sep. 16, 2015
Power Sensor	MA2411B	1207325	Sep. 17, 2014	Sep. 16, 2015

- NOTE:** 1. The calibration interval of the above test instruments is 12 months and the calibrations are traceable to NML/ROC and NIST/USA.
2. The calibration interval of the loop antenna is 24 months and the calibrations are traceable to NML/ROC and NIST/USA.
3. The test was performed in HwaYa Chamber 10.
4. The horn antenna and HP preamplifier (model: 8449B) are used only for the measurement of emission frequency above 1GHz if tested.
5. The FCC Site Registration No. is 690701.
6. The IC Site Registration No. is IC 7450F-10.

#### 4.1.3 TEST PROCEDURES

- a. The EUT was placed on the top of a rotating table 0.8 meters (for below 1GHz) / 1.5 meters (for above 1GHz) above the ground at 3 meter chamber room for test. The table was rotated 360 degrees to determine the position of the highest radiation.
- b. The EUT was set 3 meters away from the interference-receiving antenna, which was mounted on the top of a variable-height antenna tower.
- c. Height of receiving antenna is varied from one meter to four meters above the ground to determine the maximum value of the field strength. Both horizontal and vertical polarizations of the antenna are set to make the measurement.
- d. For each suspected emission, the EUT was arranged to its worst case and then the antenna was tuned to heights from 1 meter to 4 meters and the rotatable table was turned from 0 degrees to 360 degrees to find the maximum reading.
- e. The test-receiver system was set to Peak Detect Function and Specified Bandwidth with Maximum Hold Mode.
- f. If the emission level of the EUT in peak mode was lower than the limit specified, then testing could be stopped and the peak values of the EUT would be reported. Otherwise the emissions would be re-tested one by one using peak, quasi-peak or average method as specified and then reported in a data sheet.

**NOTE:**

1. The resolution bandwidth and video bandwidth of test receiver/spectrum analyzer is 120kHz for Quasi-peak detection at frequency below 1GHz.
2. The resolution bandwidth of test receiver/spectrum analyzer is 1MHz and video bandwidth is 3MHz for Peak detection at frequency above 1GHz.
3. The resolution bandwidth of test receiver/spectrum analyzer is 1MHz and the video bandwidth is 1kHz (Duty cycle < 98%) or 10Hz (Duty cycle > 98%) for Average detection (AV) at frequency above 1GHz.
4. All modes of operation were investigated and the worst-case emissions are reported.

#### 4.1.4 DEVIATION FROM TEST STANDARD

No deviation.



#### 4.1.5 TEST SETUP

<Frequency Range 30MHz ~ 1GHz>

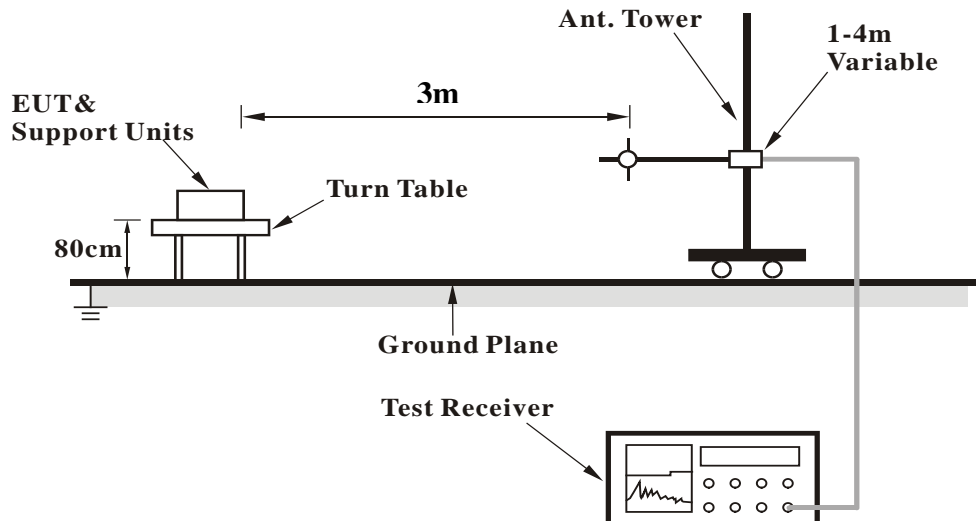

<Frequency Range above 1GHz>

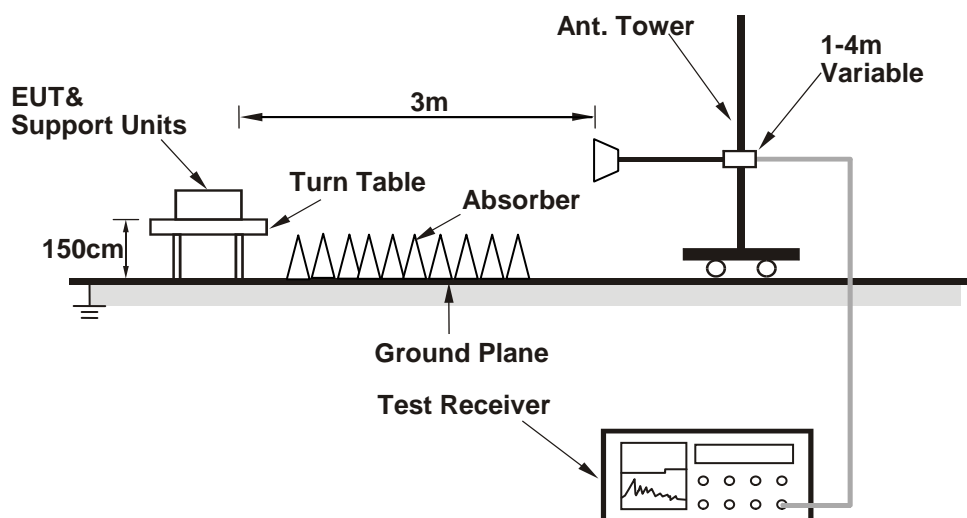

For the actual test configuration, please refer to the attached file (Test Setup Photo).

#### 4.1.6 EUT OPERATING CONDITIONS

- Placed the EUT on a testing table.
- Use the software to control the EUT under transmission condition continuously at specific channel frequency.



A D T

**4.1.7 TEST RESULTS**

**ABOVE 1GHz WORST-CASE DATA**

**802.11b**

EUT TEST CONDITION		MEASUREMENT DETAIL	
CHANNEL	Channel 1	FREQUENCY RANGE	1GHz ~ 25GHz
INPUT POWER	120Vac, 60 Hz	DETECTOR FUNCTION	Peak (PK) Average (AV)
ENVIRONMENTAL CONDITIONS	25deg. C, 65%RH	TESTED BY	Gavin Wu

**ANTENNA POLARITY & TEST DISTANCE: HORIZONTAL AT 3 M**

FREQ. (MHz)	EMISSION LEVEL (dBuV/m)	READ LEVEL (dBuV)	LIMIT (dBuV/m)	MARGIN (dB)	ANTENNA FACTOR (dB/m)	CABLE LOSS (dB)	PREAMP FACTOR (dB)	ANTENNA HEIGHT (cm)	TABLE ANGLE (Degree)	REMARK
2386	51.54	58.05	54	-2.46	26.91	4.08	37.5	203	178	Average
2386	59.51	66.02	74	-14.49	26.91	4.08	37.5	203	178	Peak
2412	103.2	109.67			26.96	4.09	37.52	203	178	Average
2412	107.73	114.2			26.96	4.09	37.52	203	178	Peak
2490	36.04	42	54	-17.96	27.2	4.16	37.32	203	178	Average
2490	56.39	62.35	74	-17.61	27.2	4.16	37.32	203	178	Peak

**ANTENNA POLARITY & TEST DISTANCE: VERTICAL AT 3 M**

FREQ. (MHz)	EMISSION LEVEL (dBuV/m)	READ LEVEL (dBuV)	LIMIT (dBuV/m)	MARGIN (dB)	ANTENNA FACTOR (dB/m)	CABLE LOSS (dB)	PREAMP FACTOR (dB)	ANTENNA HEIGHT (cm)	TABLE ANGLE (Degree)	REMARK
2386	44.68	51.19	54	-9.32	26.91	4.08	37.5	204	273	Average
2386	58.04	64.55	74	-15.96	26.91	4.08	37.5	204	273	Peak
2412	98.91	105.38			26.96	4.09	37.52	204	273	Average
2412	102.71	109.18			26.96	4.09	37.52	204	273	Peak
2500	35.65	41.54	54	-18.35	27.2	4.16	37.25	204	273	Average
2500	56.86	62.75	74	-17.14	27.2	4.16	37.25	204	273	Peak

**REMARKS:**

- Emission Level = Read Level + Antenna Factor + Cable Loss - Preamp Factor  
Margin value = Emission level – Limit value
- 2412MHz: Fundamental frequency.



A D T

EUT TEST CONDITION		MEASUREMENT DETAIL	
CHANNEL	Channel 6	FREQUENCY RANGE	1GHz ~ 25GHz
INPUT POWER	120Vac, 60 Hz	DETECTOR FUNCTION	Peak (PK) Average (AV)
ENVIRONMENTAL CONDITIONS	25deg. C, 65%RH	TESTED BY	Gavin Wu

**ANTENNA POLARITY & TEST DISTANCE: HORIZONTAL AT 3 M**

FREQ. (MHz)	EMISSION LEVEL (dBuV/m)	READ LEVEL (dBuV)	LIMIT (dBuV/m)	MARGIN (dB)	ANTENNA FACTOR (dB/m)	CABLE LOSS (dB)	PREAMP FACTOR (dB)	ANTENNA HEIGHT (cm)	TABLE ANGLE (Degree)	REMARK
2382	35.06	41.62	54	-18.94	26.86	4.08	37.5	199	174	Average
2382	56.39	62.95	74	-17.61	26.86	4.08	37.5	199	174	Peak
2437	103.43	109.71			27.06	4.12	37.46	199	174	Average
2437	107.93	114.21			27.06	4.12	37.46	199	174	Peak
2492	37.72	43.61	54	-16.28	27.2	4.16	37.25	199	174	Average
2492	57.34	63.23	74	-16.66	27.2	4.16	37.25	199	174	Peak

**ANTENNA POLARITY & TEST DISTANCE: VERTICAL AT 3 M**

FREQ. (MHz)	EMISSION LEVEL (dBuV/m)	READ LEVEL (dBuV)	LIMIT (dBuV/m)	MARGIN (dB)	ANTENNA FACTOR (dB/m)	CABLE LOSS (dB)	PREAMP FACTOR (dB)	ANTENNA HEIGHT (cm)	TABLE ANGLE (Degree)	REMARK
2378	34.88	41.45	54	-19.12	26.86	4.07	37.5	203	212	Average
2378	56.67	63.24	74	-17.33	26.86	4.07	37.5	203	212	Peak
2437	99.32	105.6			27.06	4.12	37.46	203	212	Average
2437	103.66	109.94			27.06	4.12	37.46	203	212	Peak
2498	35.55	41.44	54	-18.45	27.2	4.16	37.25	203	212	Average
2498	56.96	62.85	74	-17.04	27.2	4.16	37.25	203	212	Peak

**REMARKS:**

- Emission Level = Read Level + Antenna Factor + Cable Loss - Preamp Factor  
Margin value = Emission level – Limit value
- 2437MHz: Fundamental frequency.



A D T

EUT TEST CONDITION		MEASUREMENT DETAIL	
CHANNEL	Channel 11	FREQUENCY RANGE	1GHz ~ 25GHz
INPUT POWER	120Vac, 60 Hz	DETECTOR FUNCTION	Peak (PK) Average (AV)
ENVIRONMENTAL CONDITIONS	25deg. C, 65%RH	TESTED BY	Gavin Wu

**ANTENNA POLARITY & TEST DISTANCE: HORIZONTAL AT 3 M**

FREQ. (MHz)	EMISSION LEVEL (dBuV/m)	READ LEVEL (dBuV)	LIMIT (dBuV/m)	MARGIN (dB)	ANTENNA FACTOR (dB/m)	CABLE LOSS (dB)	PREAMP FACTOR (dB)	ANTENNA HEIGHT (cm)	TABLE ANGLE (Degree)	REMARK
2380	34.21	40.77	54	-19.79	26.86	4.08	37.5	218	178	Average
2380	56.08	62.64	74	-17.92	26.86	4.08	37.5	218	178	Peak
2462	103.21	109.37			27.1	4.13	37.39	218	178	Average
2462	107.57	113.73			27.1	4.13	37.39	218	178	Peak
2488	45.35	51.31	54	-8.65	27.2	4.16	37.32	218	178	Average
2488	58.69	64.65	74	-15.31	27.2	4.16	37.32	218	178	Peak

**ANTENNA POLARITY & TEST DISTANCE: VERTICAL AT 3 M**

FREQ. (MHz)	EMISSION LEVEL (dBuV/m)	READ LEVEL (dBuV)	LIMIT (dBuV/m)	MARGIN (dB)	ANTENNA FACTOR (dB/m)	CABLE LOSS (dB)	PREAMP FACTOR (dB)	ANTENNA HEIGHT (cm)	TABLE ANGLE (Degree)	REMARK
2348	33.65	40.32	54	-20.35	26.77	4.05	37.49	201	215	Average
2348	56.42	63.09	74	-17.58	26.77	4.05	37.49	201	215	Peak
2462	98.68	104.84			27.1	4.13	37.39	201	215	Average
2462	103.03	109.19			27.1	4.13	37.39	201	215	Peak
2488	42.89	48.85	54	-11.11	27.2	4.16	37.32	201	215	Average
2488	58.21	64.17	74	-15.79	27.2	4.16	37.32	201	215	Peak

**REMARKS:**

- Emission Level = Read Level + Antenna Factor + Cable Loss - Preamp Factor  
Margin value = Emission level – Limit value
- 2462MHz: Fundamental frequency.



A D T

802.11g

EUT TEST CONDITION		MEASUREMENT DETAIL	
CHANNEL	Channel 1	FREQUENCY RANGE	1GHz ~ 25GHz
INPUT POWER	120Vac, 60 Hz	DETECTOR FUNCTION	Peak (PK) Average (AV)
ENVIRONMENTAL CONDITIONS	25deg. C, 65%RH	TESTED BY	Gavin Wu

ANTENNA POLARITY & TEST DISTANCE: HORIZONTAL AT 3 M										
FREQ. (MHz)	EMISSION LEVEL (dBuV/m)	READ LEVEL (dBuV)	LIMIT (dBuV/m)	MARGIN (dB)	ANTENNA FACTOR (dB/m)	CABLE LOSS (dB)	PREAMP FACTOR (dB)	ANTENNA HEIGHT (cm)	TABLE ANGLE (Degree)	REMARK
2390	44.56	51.09	54	-9.44	26.91	4.08	37.52	202	172	Average
2390	65.99	72.52	74	-8.01	26.91	4.08	37.52	202	172	Peak
2412	97.36	103.83			26.96	4.09	37.52	202	172	Average
2412	106.66	113.13			26.96	4.09	37.52	202	172	Peak
2492	36.67	42.56	54	-17.33	27.2	4.16	37.25	202	172	Average
2492	56.49	62.38	74	-17.51	27.2	4.16	37.25	202	172	Peak
ANTENNA POLARITY & TEST DISTANCE: VERTICAL AT 3 M										
FREQ. (MHz)	EMISSION LEVEL (dBuV/m)	READ LEVEL (dBuV)	LIMIT (dBuV/m)	MARGIN (dB)	ANTENNA FACTOR (dB/m)	CABLE LOSS (dB)	PREAMP FACTOR (dB)	ANTENNA HEIGHT (cm)	TABLE ANGLE (Degree)	REMARK
2390	41.78	48.31	54	-12.22	26.91	4.08	37.52	204	212	Average
2390	63.4	69.93	74	-10.6	26.91	4.08	37.52	204	212	Peak
2412	93.68	100.15			26.96	4.09	37.52	204	212	Average
2412	103.26	109.73			26.96	4.09	37.52	204	212	Peak
2490	36	41.96	54	-18	27.2	4.16	37.32	204	212	Average
2490	56.51	62.47	74	-17.49	27.2	4.16	37.32	204	212	Peak

REMARKS:

- Emission Level = Read Level + Antenna Factor + Cable Loss - Preamp Factor  
Margin value = Emission level – Limit value
- 2412MHz: Fundamental frequency.



A D T

EUT TEST CONDITION		MEASUREMENT DETAIL	
CHANNEL	Channel 6	FREQUENCY RANGE	1GHz ~ 25GHz
INPUT POWER	120Vac, 60 Hz	DETECTOR FUNCTION	Peak (PK) Average (AV)
ENVIRONMENTAL CONDITIONS	25deg. C, 65%RH	TESTED BY	Gavin Wu

**ANTENNA POLARITY & TEST DISTANCE: HORIZONTAL AT 3 M**

FREQ. (MHz)	EMISSION LEVEL (dBuV/m)	READ LEVEL (dBuV)	LIMIT (dBuV/m)	MARGIN (dB)	ANTENNA FACTOR (dB/m)	CABLE LOSS (dB)	PREAMP FACTOR (dB)	ANTENNA HEIGHT (cm)	TABLE ANGLE (Degree)	REMARK
2386	39.9	46.41	54	-14.1	26.91	4.08	37.5	199	175	Average
2386	56.76	63.27	74	-17.24	26.91	4.08	37.5	199	175	Peak
2437	97.6	103.93			27.01	4.12	37.46	199	175	Average
2437	106.74	113.07			27.01	4.12	37.46	199	175	Peak
2490	44.11	50.07	54	-9.89	27.2	4.16	37.32	199	175	Average
2490	58.21	64.17	74	-15.79	27.2	4.16	37.32	199	175	Peak

**ANTENNA POLARITY & TEST DISTANCE: VERTICAL AT 3 M**

FREQ. (MHz)	EMISSION LEVEL (dBuV/m)	READ LEVEL (dBuV)	LIMIT (dBuV/m)	MARGIN (dB)	ANTENNA FACTOR (dB/m)	CABLE LOSS (dB)	PREAMP FACTOR (dB)	ANTENNA HEIGHT (cm)	TABLE ANGLE (Degree)	REMARK
2390	39.74	46.27	54	-14.26	26.91	4.08	37.52	204	214	Average
2390	56.91	63.44	74	-17.09	26.91	4.08	37.52	204	214	Peak
2437	93.75	100.03			27.06	4.12	37.46	204	214	Average
2437	103.32	109.6			27.06	4.12	37.46	204	214	Peak
2494	40.52	46.41	54	-13.48	27.2	4.16	37.25	204	214	Average
2494	58.22	64.11	74	-15.78	27.2	4.16	37.25	204	214	Peak

**REMARKS:**

- Emission Level = Read Level + Antenna Factor + Cable Loss - Preamp Factor  
Margin value = Emission level – Limit value
- 2437MHz: Fundamental frequency.



A D T

EUT TEST CONDITION		MEASUREMENT DETAIL	
CHANNEL	Channel 11	FREQUENCY RANGE	1GHz ~ 25GHz
INPUT POWER	120Vac, 60 Hz	DETECTOR FUNCTION	Peak (PK) Average (AV)
ENVIRONMENTAL CONDITIONS	25deg. C, 65%RH	TESTED BY	Gavin Wu

**ANTENNA POLARITY & TEST DISTANCE: HORIZONTAL AT 3 M**

FREQ. (MHz)	EMISSION LEVEL (dBuV/m)	READ LEVEL (dBuV)	LIMIT (dBuV/m)	MARGIN (dB)	ANTENNA FACTOR (dB/m)	CABLE LOSS (dB)	PREAMP FACTOR (dB)	ANTENNA HEIGHT (cm)	TABLE ANGLE (Degree)	REMARK
2376	36.04	42.61	54	-17.96	26.86	4.07	37.5	199	359	Average
2376	57.08	63.65	74	-16.92	26.86	4.07	37.5	199	359	Peak
2462	97.1	103.26			27.1	4.13	37.39	199	359	Average
2462	106.54	112.7			27.1	4.13	37.39	199	359	Peak
2484	50.58	56.6	54	-3.42	27.15	4.15	37.32	199	359	Average
2484	71.37	77.39	74	-2.63	27.15	4.15	37.32	199	359	Peak

**ANTENNA POLARITY & TEST DISTANCE: VERTICAL AT 3 M**

FREQ. (MHz)	EMISSION LEVEL (dBuV/m)	READ LEVEL (dBuV)	LIMIT (dBuV/m)	MARGIN (dB)	ANTENNA FACTOR (dB/m)	CABLE LOSS (dB)	PREAMP FACTOR (dB)	ANTENNA HEIGHT (cm)	TABLE ANGLE (Degree)	REMARK
2358	35.15	41.78	54	-18.85	26.81	4.05	37.49	201	220	Average
2358	56.97	63.6	74	-17.03	26.81	4.05	37.49	201	220	Peak
2462	93.03	99.19			27.1	4.13	37.39	201	220	Average
2462	102.47	108.63			27.1	4.13	37.39	201	220	Peak
2486	45.66	51.68	54	-8.34	27.15	4.15	37.32	201	220	Average
2486	64.32	70.34	74	-9.68	27.15	4.15	37.32	201	220	Peak

**REMARKS:**

- Emission Level = Read Level + Antenna Factor + Cable Loss - Preamp Factor  
Margin value = Emission level – Limit value
- 2462MHz: Fundamental frequency.



A D T

**802.11n (20MHz)**

EUT TEST CONDITION		MEASUREMENT DETAIL	
CHANNEL	Channel 1	FREQUENCY RANGE	1GHz ~ 25GHz
INPUT POWER	120Vac, 60 Hz	DETECTOR FUNCTION	Peak (PK) Average (AV)
ENVIRONMENTAL CONDITIONS	25deg. C, 65%RH	TESTED BY	Gavin Wu

**ANTENNA POLARITY & TEST DISTANCE: HORIZONTAL AT 3 M**

FREQ. (MHz)	EMISSION LEVEL (dBuV/m)	READ LEVEL (dBuV)	LIMIT (dBuV/m)	MARGIN (dB)	ANTENNA FACTOR (dB/m)	CABLE LOSS (dB)	PREAMP FACTOR (dB)	ANTENNA HEIGHT (cm)	TABLE ANGLE (Degree)	REMARK
2384	43.62	50.18	54	-10.38	26.86	4.08	37.5	203	183	Average
2384	65.94	72.5	74	-8.06	26.86	4.08	37.5	203	183	Peak
2412	95.57	102.04			26.96	4.09	37.52	203	183	Average
2412	105.05	111.52			26.96	4.09	37.52	203	183	Peak
2492	35.92	41.81	54	-18.08	27.2	4.16	37.25	203	183	Average
2492	57.4	63.29	74	-16.6	27.2	4.16	37.25	203	183	Peak

**ANTENNA POLARITY & TEST DISTANCE: VERTICAL AT 3 M**

FREQ. (MHz)	EMISSION LEVEL (dBuV/m)	READ LEVEL (dBuV)	LIMIT (dBuV/m)	MARGIN (dB)	ANTENNA FACTOR (dB/m)	CABLE LOSS (dB)	PREAMP FACTOR (dB)	ANTENNA HEIGHT (cm)	TABLE ANGLE (Degree)	REMARK
2386	40.96	47.47	54	-13.04	26.91	4.08	37.5	226	230	Average
2386	59.52	66.03	74	-14.48	26.91	4.08	37.5	226	230	Peak
2412	91.69	98.16			26.96	4.09	37.52	226	230	Average
2412	101.16	107.63			26.96	4.09	37.52	226	230	Peak
2492	35.89	41.78	54	-18.11	27.2	4.16	37.25	226	230	Average
2492	56.03	61.92	74	-17.97	27.2	4.16	37.25	226	230	Peak

**REMARKS:**

- Emission Level = Read Level + Antenna Factor + Cable Loss - Preamp Factor  
Margin value = Emission level – Limit value
- 2412MHz: Fundamental frequency.





A D T

EUT TEST CONDITION		MEASUREMENT DETAIL	
CHANNEL	Channel 6	FREQUENCY RANGE	1GHz ~ 25GHz
INPUT POWER	120Vac, 60 Hz	DETECTOR FUNCTION	Peak (PK) Average (AV)
ENVIRONMENTAL CONDITIONS	25deg. C, 65%RH	TESTED BY	Gavin Wu

**ANTENNA POLARITY & TEST DISTANCE: HORIZONTAL AT 3 M**

FREQ. (MHz)	EMISSION LEVEL (dBuV/m)	READ LEVEL (dBuV)	LIMIT (dBuV/m)	MARGIN (dB)	ANTENNA FACTOR (dB/m)	CABLE LOSS (dB)	PREAMP FACTOR (dB)	ANTENNA HEIGHT (cm)	TABLE ANGLE (Degree)	REMARK
2384	38.73	45.29	54	-15.27	26.86	4.08	37.5	199	180	Average
2384	56.18	62.74	74	-17.82	26.86	4.08	37.5	199	180	Peak
2437	95.69	101.97			27.06	4.12	37.46	199	180	Average
2437	105.07	111.35			27.06	4.12	37.46	199	180	Peak
2488	42.51	48.47	54	-11.49	27.2	4.16	37.32	199	180	Average
2488	58.34	64.3	74	-15.66	27.2	4.16	37.32	199	180	Peak

**ANTENNA POLARITY & TEST DISTANCE: VERTICAL AT 3 M**

FREQ. (MHz)	EMISSION LEVEL (dBuV/m)	READ LEVEL (dBuV)	LIMIT (dBuV/m)	MARGIN (dB)	ANTENNA FACTOR (dB/m)	CABLE LOSS (dB)	PREAMP FACTOR (dB)	ANTENNA HEIGHT (cm)	TABLE ANGLE (Degree)	REMARK
2388	38.66	45.17	54	-15.34	26.91	4.08	37.5	203	229	Average
2388	56.57	63.08	74	-17.43	26.91	4.08	37.5	203	229	Peak
2437	91.54	97.82			27.06	4.12	37.46	203	229	Average
2437	101.12	107.4			27.06	4.12	37.46	203	229	Peak
2484	38.98	45	54	-15.02	27.15	4.15	37.32	203	229	Average
2484	58	64.02	74	-16	27.15	4.15	37.32	203	229	Peak

**REMARKS:**

- Emission Level = Read Level + Antenna Factor + Cable Loss - Preamp Factor  
Margin value = Emission level – Limit value
- 2437MHz: Fundamental frequency.



A D T

EUT TEST CONDITION		MEASUREMENT DETAIL	
CHANNEL	Channel 11	FREQUENCY RANGE	1GHz ~ 25GHz
INPUT POWER	120Vac, 60 Hz	DETECTOR FUNCTION	Peak (PK) Average (AV)
ENVIRONMENTAL CONDITIONS	25deg. C, 65%RH	TESTED BY	Gavin Wu

ANTENNA POLARITY & TEST DISTANCE: HORIZONTAL AT 3 M										
FREQ. (MHz)	EMISSION LEVEL (dBuV/m)	READ LEVEL (dBuV)	LIMIT (dBuV/m)	MARGIN (dB)	ANTENNA FACTOR (dB/m)	CABLE LOSS (dB)	PREAMP FACTOR (dB)	ANTENNA HEIGHT (cm)	TABLE ANGLE (Degree)	REMARK
2378	34.91	41.48	54	-19.09	26.86	4.07	37.5	218	178	Average
2378	56.21	62.78	74	-17.79	26.86	4.07	37.5	218	178	Peak
2462	95.38	101.54			27.1	4.13	37.39	218	178	Average
2462	104.8	110.96			27.1	4.13	37.39	218	178	Peak
2484	45.66	51.68	54	-8.34	27.15	4.15	37.32	218	178	Average
2484	66.19	72.21	74	-7.81	27.15	4.15	37.32	218	178	Peak

ANTENNA POLARITY & TEST DISTANCE: VERTICAL AT 3 M										
FREQ. (MHz)	EMISSION LEVEL (dBuV/m)	READ LEVEL (dBuV)	LIMIT (dBuV/m)	MARGIN (dB)	ANTENNA FACTOR (dB/m)	CABLE LOSS (dB)	PREAMP FACTOR (dB)	ANTENNA HEIGHT (cm)	TABLE ANGLE (Degree)	REMARK
2328	34.41	41.12	54	-19.59	26.72	4.04	37.47	201	232	Average
2328	56.37	63.08	74	-17.63	26.72	4.04	37.47	201	232	Peak
2462	91.28	97.44			27.1	4.13	37.39	201	232	Average
2462	100.68	106.84			27.1	4.13	37.39	201	232	Peak
2484	43.12	49.14	54	-10.88	27.15	4.15	37.32	201	232	Average
2484	65.44	71.46	74	-8.56	27.15	4.15	37.32	201	232	Peak

**REMARKS:**

- Emission Level = Read Level + Antenna Factor + Cable Loss - Preamp Factor  
Margin value = Emission level – Limit value
- 2462MHz: Fundamental frequency.



A D T

**BELOW 1GHz WORST-CASE DATA:**

**802.11b**

EUT TEST CONDITION		MEASUREMENT DETAIL	
CHANNEL	Channel 1	FREQUENCY RANGE	30MHz ~ 1GHz
INPUT POWER	120Vac, 60 Hz	DETECTOR FUNCTION	Peak (PK) Quasi-peak (QP)
ENVIRONMENTAL CONDITIONS	25deg. C, 65%RH	TESTED BY	Gavin Wu

**ANTENNA POLARITY & TEST DISTANCE: HORIZONTAL AT 3 M**

FREQ. (MHz)	EMISSION LEVEL (dBuV/m)	READ LEVEL (dBuV)	LIMIT (dBuV/m)	MARGIN (dB)	ANTENNA FACTOR (dB/m)	CABLE LOSS (dB)	PREAMP FACTOR (dB)	ANTENNA HEIGHT (cm)	TABLE ANGLE (Degree)	REMARK
42.61	25.46	42.3	40	-14.54	13.58	0.66	31.08	123	339	Peak
138.64	18.12	36.36	43.5	-25.38	12.27	1.15	31.66	113	179	Peak
157.07	18.98	36.93	43.5	-24.52	12.72	1.13	31.8	134	359	Peak
336.52	21.74	38.01	46	-24.26	13.82	1.73	31.82	114	249	Peak
404.42	20.35	35.07	46	-25.65	15.43	1.92	32.07	130	33	Peak
555.74	22.16	33.41	46	-23.84	18.59	2.18	32.02	131	83	Peak

**ANTENNA POLARITY & TEST DISTANCE: VERTICAL AT 3 M**

FREQ. (MHz)	EMISSION LEVEL (dBuV/m)	READ LEVEL (dBuV)	LIMIT (dBuV/m)	MARGIN (dB)	ANTENNA FACTOR (dB/m)	CABLE LOSS (dB)	PREAMP FACTOR (dB)	ANTENNA HEIGHT (cm)	TABLE ANGLE (Degree)	REMARK
33.88	25.41	43.26	40	-14.59	12.63	0.6	31.08	105	105	Peak
41.64	32.12	48.95	40	-7.88	13.56	0.66	31.05	100	66	QP
58.13	26.54	44.96	40	-13.46	12.15	0.78	31.35	123	2	Peak
138.64	20	38.24	43.5	-23.5	12.27	1.15	31.66	101	243	Peak
156.1	19.7	37.63	43.5	-23.8	12.72	1.12	31.77	128	80	Peak
625.58	23.09	33.02	46	-22.91	19.92	2.3	32.15	121	19	Peak

**REMARKS:** Emission Level = Read Level + Antenna Factor + Cable Loss - Preamp Factor

Margin value = Emission level – Limit value

## 4.2 CONDUCTED EMISSION MEASUREMENT

### 4.2.1 LIMITS OF CONDUCTED EMISSION MEASUREMENT

FREQUENCY OF EMISSION (MHz)	CONDUCTED LIMIT (dB $\mu$ V)	
	Quasi-peak	Average
0.15 ~ 0.5	66 to 56	56 to 46
0.5 ~ 5	56	46
5 ~ 30	60	50

- NOTE:**
1. The lower limit shall apply at the transition frequencies.
  2. The limit decreases in line with the logarithm of the frequency in the range of 0.15 to 0.50MHz.
  3. All emanations from a class A/B digital device or system, including any network of conductors and apparatus connected thereto, shall not exceed the level of field strengths specified above.

### 4.2.2 TEST INSTRUMENTS

DESCRIPTION & MANUFACTURER	MODEL NO.	SERIAL NO.	DATE OF CALIBRATION	DUE DATE OF CALIBRATION
Test Receiver ROHDE & SCHWARZ	ESCI	100613	Nov. 11, 2014	Nov. 10, 2015
RF signal cable Woken	5D-FB	Cable-HYC01-01	Dec. 26, 2014	Dec. 25, 2015
LISN ROHDE & SCHWARZ (EUT)	ESH3-Z5	835239/001	Mar. 02, 2015	Mar. 01, 2016
LISN ROHDE & SCHWARZ (Peripheral)	ESH3-Z5	100311	Jul. 21, 2014	Jul. 20, 2015
Software ADT	BV ADT_Cond_ V7.3.7.3	NA	NA	NA

- NOTE:**
1. The calibration interval of the above test instruments is 12 months and the calibrations are traceable to NML/ROC and NIST/USA.
  2. The test was performed in HwaYa Shielded Room 1.
  3. The VCCI Site Registration No. is C-2047.

#### 4.2.3 TEST PROCEDURES

- a. The EUT was placed 0.4 meters from the conducting wall of the shielded room with EUT being connected to the power mains through a line impedance stabilization network (LISN). Other support units were connected to the power mains through another LISN. The two LISNs provide 50 ohm/50uH of coupling impedance for the measuring instrument.
- b. Both lines of the power mains connected to the EUT were checked for maximum conducted interference.
- c. The frequency range from 150kHz to 30MHz was searched. Emission levels under (Limit - 20dB) was not recorded.

**NOTE:** All modes of operation were investigated and the worst-case emissions are reported.

#### 4.2.4 DEVIATION FROM TEST STANDARD

No deviation.

#### 4.2.5 TEST SETUP

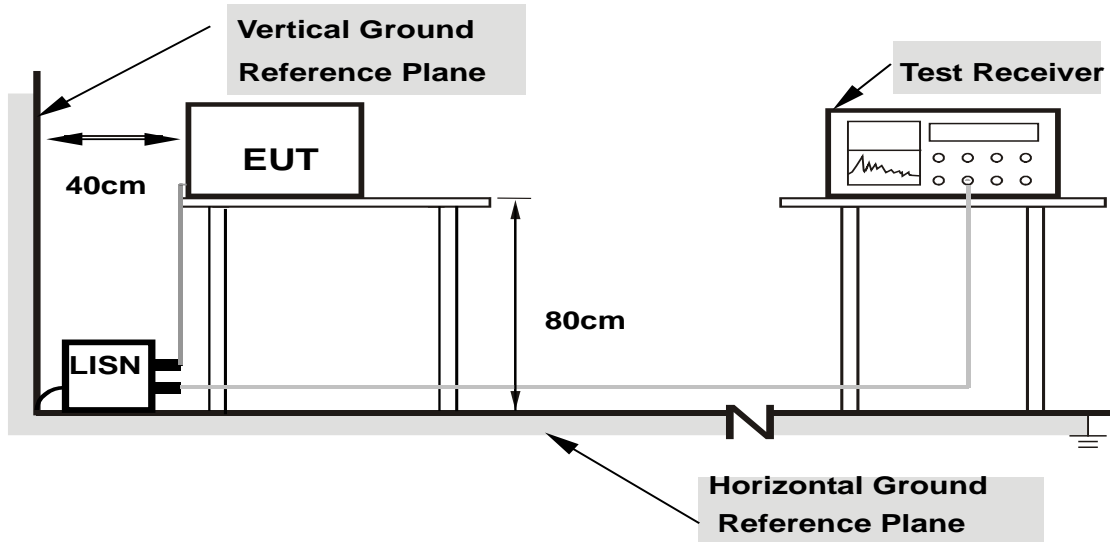

- Note: 1.Support units were connected to second LISN.  
 2.Both of LISNs (AMN) are 80 cm from EUT and at least 80 from other units and other metal planes**

For the actual test configuration, please refer to the attached file (Test Setup Photo).

#### 4.2.6 EUT OPERATING CONDITIONS

Same as section 4.1.6.

#### 4.2.7 TEST RESULTS

##### CONDUCTED WORST-CASE DATA :

Frequency Range	150kHz ~ 30MHz	Detector Function & Resolution Bandwidth	Quasi-Peak (QP), 9kHz Average (AV), 9kHz
Input Power	120Vac, 60Hz	Environmental Conditions	25°C, 65%RH
Tested by	Toby Tian	Test Date	2015/5/27

Phase Of Power : Line (L)										
No	Frequency (MHz)	Correction Factor (dB)	Reading Value (dBuV)		Emission Level (dBuV)		Limit (dBuV)		Margin (dB)	
			Q.P.	AV.	Q.P.	AV.	Q.P.	AV.	Q.P.	AV.
<b>1</b>	<b>0.15000</b>	<b>0.05</b>	<b>49.84</b>	<b>37.16</b>	<b>49.89</b>	<b>37.21</b>	<b>66.00</b>	<b>56.00</b>	<b>-16.11</b>	<b>-18.79</b>
2	0.17737	0.06	45.42	33.93	45.48	33.99	64.61	54.61	-19.13	-20.62
3	0.20474	0.06	41.59	30.07	41.65	30.13	63.42	53.42	-21.77	-23.29
4	0.23216	0.06	36.92	24.61	36.98	24.67	62.37	52.37	-25.39	-27.70
5	0.24796	0.06	35.65	23.67	35.71	23.73	61.83	51.83	-26.12	-28.10
6	0.38851	0.06	29.09	24.02	29.15	24.08	58.10	48.10	-28.95	-24.02

##### Remarks:

1. Q.P. and AV. are abbreviations of quasi-peak and average individually.
2. The emission levels of other frequencies were very low against the limit.
3. Margin value = Emission level – Limit value
4. Correction factor = Insertion loss + Cable loss
5. Emission Level = Correction Factor + Reading Value

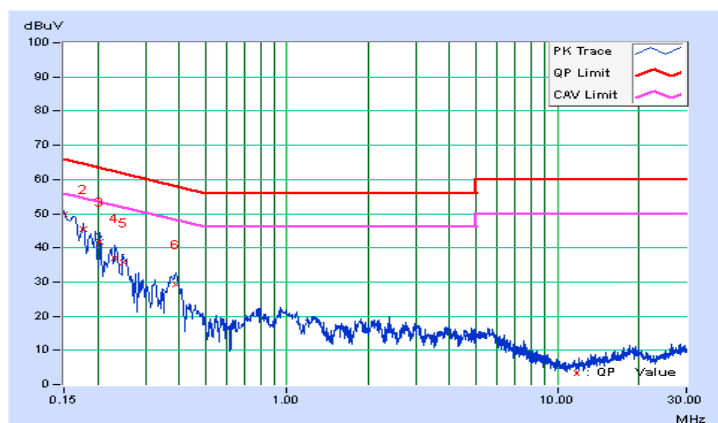

Frequency Range	150kHz ~ 30MHz	Detector Function & Resolution Bandwidth	Quasi-Peak (QP), 9kHz Average (AV), 9kHz
Input Power	120Vac, 60Hz	Environmental Conditions	25°C, 65%RH
Tested by	Toby Tian	Test Date	2015/5/27

Phase Of Power : Neutral (N)										
No	Frequency (MHz)	Correction Factor (dB)	Reading Value (dBuV)		Emission Level (dBuV)		Limit (dBuV)		Margin (dB)	
			Q.P.	AV.	Q.P.	AV.	Q.P.	AV.	Q.P.	AV.
1	0.15782	0.05	46.97	32.03	47.02	32.08	65.58	55.58	-18.56	-23.50
2	0.17698	0.05	45.53	34.86	45.58	34.91	64.63	54.63	-19.05	-19.72
3	0.19305	0.05	39.47	26.85	39.52	26.90	63.90	53.90	-24.38	-27.00
4	0.21170	0.05	37.61	22.00	37.66	22.05	63.14	53.14	-25.48	-31.09
5	0.23993	0.05	32.04	16.76	32.09	16.81	62.10	52.10	-30.01	-35.29
6	0.39242	0.06	27.83	21.67	27.89	21.73	58.01	48.01	-30.12	-26.28

Remarks:

1. Q.P. and AV. are abbreviations of quasi-peak and average individually.
2. The emission levels of other frequencies were very low against the limit.
3. Margin value = Emission level – Limit value
4. Correction factor = Insertion loss + Cable loss
5. Emission Level = Correction Factor + Reading Value

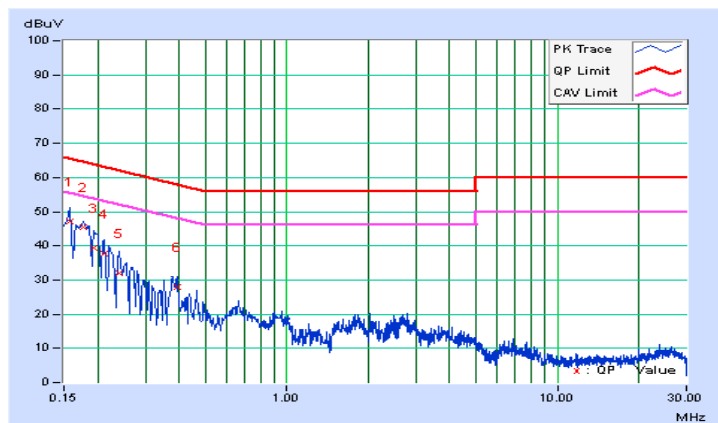



## 4.3 6dB BANDWIDTH MEASUREMENT

### 4.3.1 LIMITS OF 6dB BANDWIDTH MEASUREMENT

The minimum of 6dB Bandwidth Measurement is 0.5 MHz.

### 4.3.2 TEST SETUP

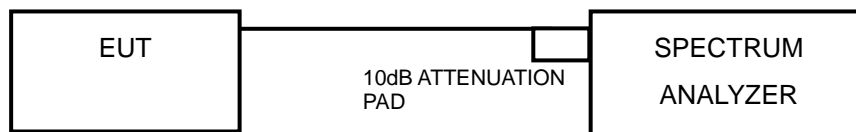

### 4.3.3 TEST INSTRUMENTS

Refer to section 4.1.2 to get information of above instrument.

### 4.3.4 TEST PROCEDURE

- Set resolution bandwidth (RBW) = 100kHz
- Set the video bandwidth (VBW)  $\geq 3 \times$  RBW, Detector = Peak.
- Trace mode = max hold.
- Sweep = auto couple.
- Measure the maximum width of the emission that is constrained by the frequencies associated with the two amplitude points (upper and lower) that are attenuated by 6 dB relative to the maximum level measured in the fundamental emission

### 4.3.5 DEVIATION FROM TEST STANDARD

No deviation.

### 4.3.6 EUT OPERATING CONDITIONS

The software provided by client to enable the EUT under transmission condition continuously at lowest, middle and highest channel frequencies individually.

#### 4.3.7 TEST RESULTS

##### 802.11b

CHANNEL	FREQUENCY (MHz)	6dB BANDWIDTH (MHz)	MINIMUM LIMIT (MHz)	PASS / FAIL
1	2412	8.80	0.5	PASS
6	2437	8.09	0.5	PASS
11	2462	8.50	0.5	PASS

##### 802.11g

CHANNEL	FREQUENCY (MHz)	6dB BANDWIDTH (MHz)	MINIMUM LIMIT (MHz)	PASS / FAIL
1	2412	15.80	0.5	PASS
6	2437	14.72	0.5	PASS
11	2462	15.15	0.5	PASS

##### 802.11n (20MHz)

CHANNEL	FREQUENCY (MHz)	6dB BANDWIDTH (MHz)	MINIMUM LIMIT (MHz)	PASS / FAIL
1	2412	15.16	0.5	PASS
6	2437	15.15	0.5	PASS
11	2462	15.16	0.5	PASS



A D T

### SPECTRUM PLOT OF WORST VALUE

#### 802.11b

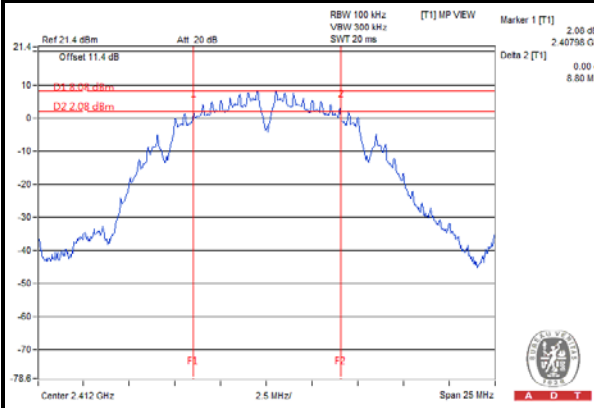

#### 802.11g

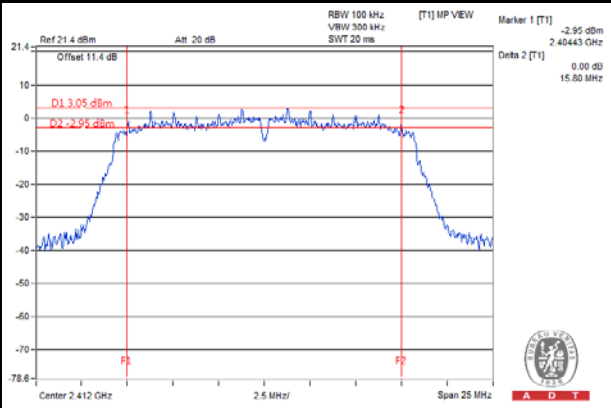

#### 802.11n (20MHz)

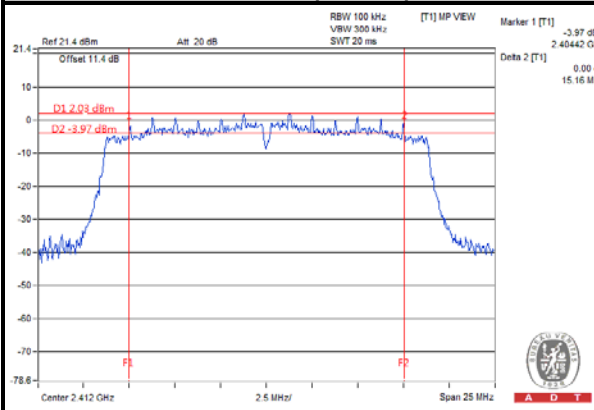

## 4.4 CONDUCTED OUTPUT POWER

### 4.4.1 LIMITS OF CONDUCTED OUTPUT POWER MEASUREMENT

For systems using digital modulation in the 2400–2483.5 MHz bands: 1 Watt (30dBm)

### 4.4.2 TEST SETUP

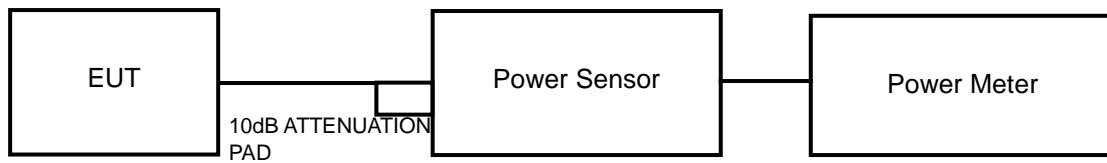

### 4.4.3 TEST INSTRUMENTS

Refer to section 4.1.2 to get information of above instrument.

### 4.4.4 TEST PROCEDURES

A peak power sensor was used on the output port of the EUT. A power meter was used to read the response of the peak power sensor. Record the peak power level.

### 4.4.5 DEVIATION FROM TEST STANDARD

No deviation.

### 4.4.6 EUT OPERATING CONDITIONS

Same as section 4.3.6.

#### 4.4.7 TEST RESULTS

##### 802.11b

CHANNEL	FREQUENCY (MHz)	PEAK POWER (mW)	PEAK POWER (dBm)	LIMIT (dBm)	PASS / FAIL
1	2412	90.57	19.57	30	PASS
6	2437	<b>93.11</b>	<b>19.69</b>	30	PASS
11	2462	89.33	19.51	30	PASS

##### 802.11g

CHANNEL	FREQUENCY (MHz)	PEAK POWER (mW)	PEAK POWER (dBm)	LIMIT (dBm)	PASS / FAIL
1	2412	242.66	23.85	30	PASS
6	2437	<b>249.46</b>	<b>23.97</b>	30	PASS
11	2462	244.34	23.88	30	PASS

##### 802.11n (20MHz)

CHANNEL	FREQUENCY (MHz)	PEAK POWER (mW)	PEAK POWER (dBm)	LIMIT (dBm)	PASS / FAIL
1	2412	242.10	23.84	30	PASS
6	2437	<b>248.89</b>	<b>23.96</b>	30	PASS
11	2462	240.99	23.82	30	PASS

## 4.5 POWER SPECTRAL DENSITY MEASUREMENT

### 4.5.1 LIMITS OF POWER SPECTRAL DENSITY MEASUREMENT

The Maximum of Power Spectral Density Measurement is 8dBm.

### 4.5.2 TEST SETUP

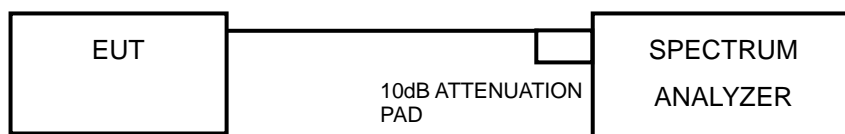

### 4.5.3 TEST INSTRUMENTS

Refer to section 4.1.2 to get information of above instrument.

### 4.5.4 TEST PROCEDURE

- Set the RBW = 3 kHz, VBW =10 kHz, Detector = peak.
- Sweep time = auto couple, Trace mode = max hold, allow trace to fully stabilize.
- Use the peak marker function to determine the maximum power level in any 100 kHz band segment within the fundamental EBW.

### 4.5.5 DEVIATION FROM TEST STANDARD

No deviation.

### 4.5.6 EUT OPERATING CONDITION

Same as section 4.3.6.

#### 4.5.7 TEST RESULTS

##### 802.11b

CHANNEL	FREQUENCY (MHz)	PSD (dBm/3kHz)	LIMIT (dBm/3kHz)	PASS / FAIL
1	2412	-6.44	8	PASS
6	2437	-5.99	8	PASS
11	2462	-6.35	8	PASS

##### 802.11g

CHANNEL	FREQUENCY (MHz)	PSD (dBm/3kHz)	LIMIT (dBm/3kHz)	PASS / FAIL
1	2412	-11.20	8	PASS
6	2437	-11.88	8	PASS
11	2462	-12.00	8	PASS

##### 802.11n (20MHz)

CHANNEL	FREQUENCY (MHz)	PSD (dBm/3kHz)	LIMIT (dBm/3kHz)	PASS / FAIL
1	2412	-11.10	8	PASS
6	2437	-12.85	8	PASS
11	2462	-12.56	8	PASS



A D T

### SPECTRUM PLOT OF WORST VALUE

#### 802.11b

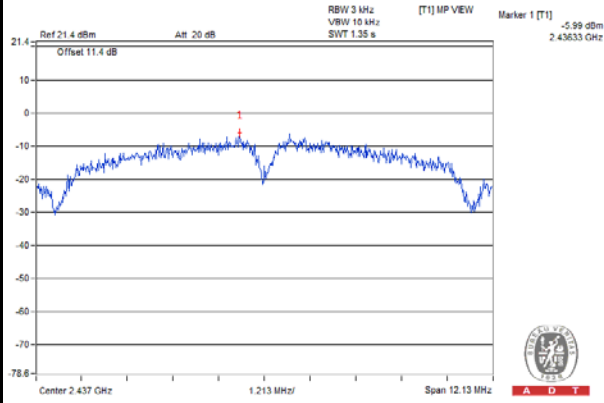

#### 802.11g

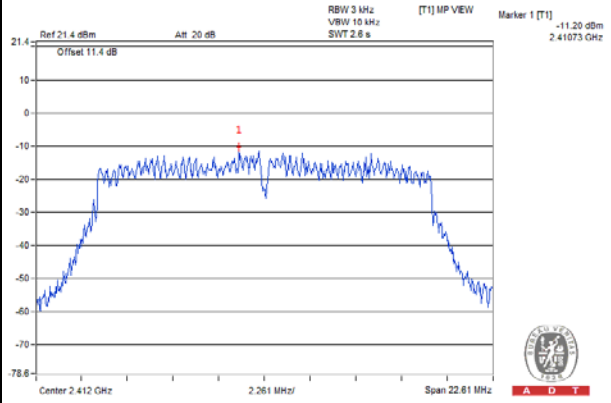

#### 802.11n (20MHz)

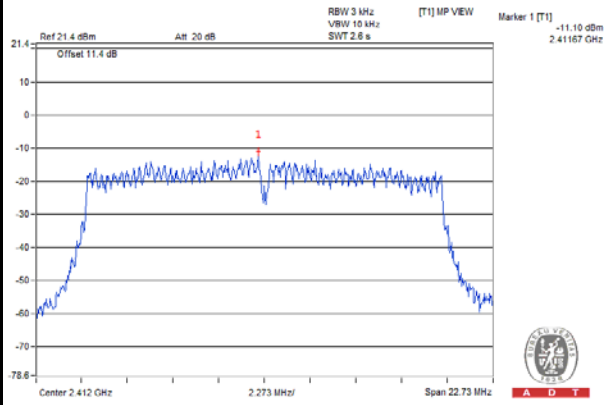



## 4.6 CONDUCTED OUT OF BAND EMISSION MEASUREMENT

### 4.6.1 LIMITS OF CONDUCTED OUT OF BAND EMISSION MEASUREMENT

Below  $-20\text{dB}$  of the highest emission level of operating band (in 100kHz Resolution Bandwidth).

### 4.6.2 TEST SETUP

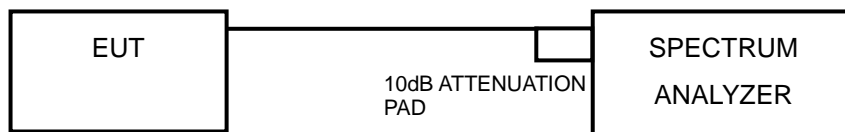

### 4.6.3 TEST INSTRUMENTS

Refer to section 4.1.2 to get information of above instrument.

### 4.6.4 TEST PROCEDURE

#### MEASUREMENT PROCEDURE REF

1. Set the RBW = 100 kHz.
2. Set the VBW  $\geq$  300 kHz.
3. Detector = peak.
4. Sweep time = auto couple.
5. Trace mode = max hold.
6. Allow trace to fully stabilize.
7. Use the peak marker function to determine the maximum power level in any 100 kHz band segment within the fundamental EBW.

#### MEASUREMENT PROCEDURE OOB

1. Set RBW = 100 kHz.
2. Set VBW  $\geq$  300 kHz.
3. Detector = peak.
4. Sweep = auto couple.
5. Trace Mode = max hold.
6. Allow trace to fully stabilize.
7. Use the peak marker function to determine the maximum amplitude level.

### 4.6.5 DEVIATION FROM TEST STANDARD

No deviation.

### 4.6.6 EUT OPERATING CONDITION

Same as section 4.3.6.

### 4.6.7 TEST RESULTS

The spectrum plots are attached on the following images. D1 line indicates the highest level, and D2 line indicates the 20dB offset below D1. It shows compliance with the requirement.

#### 802.11b

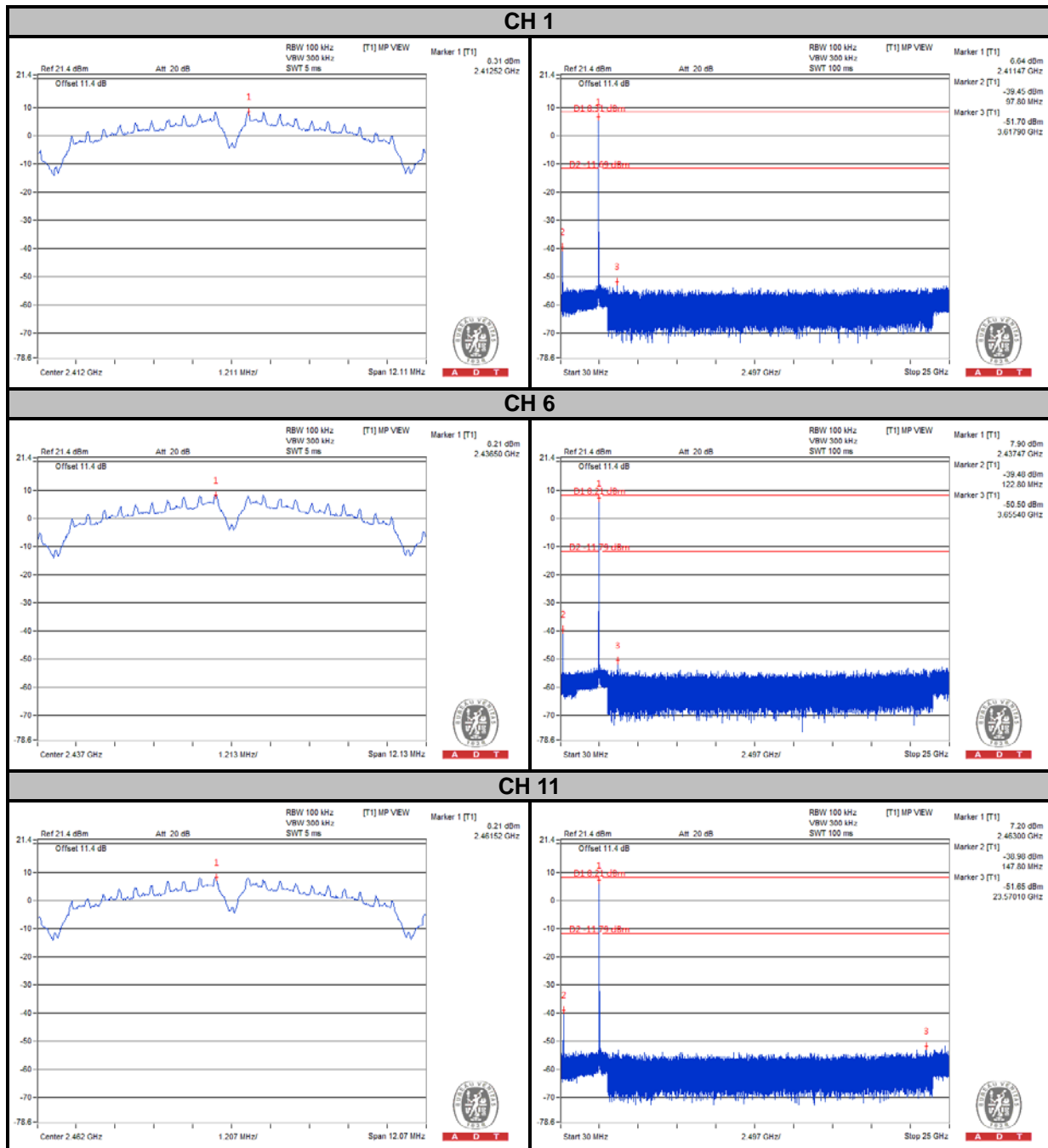



A D T

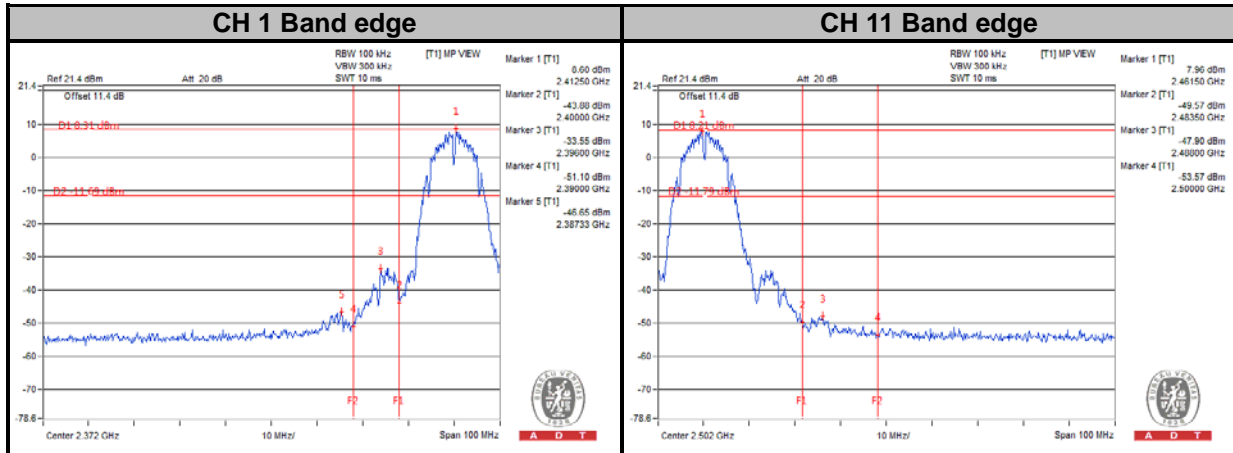



A D T

### 802.11g

#### CH 1

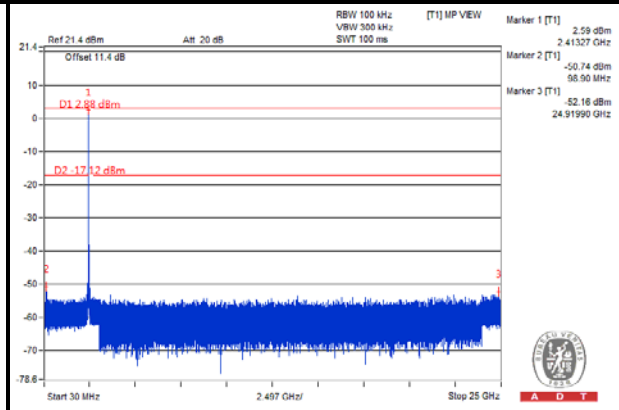
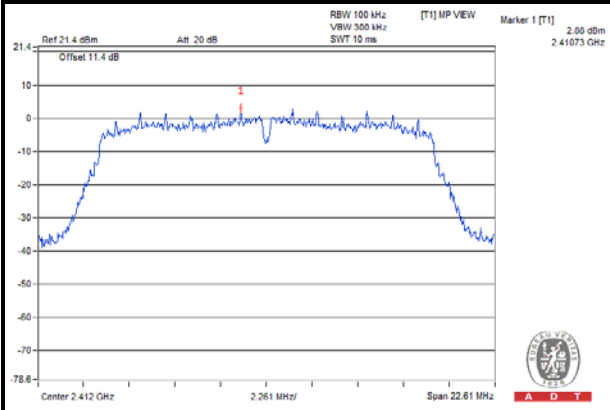

#### CH 6

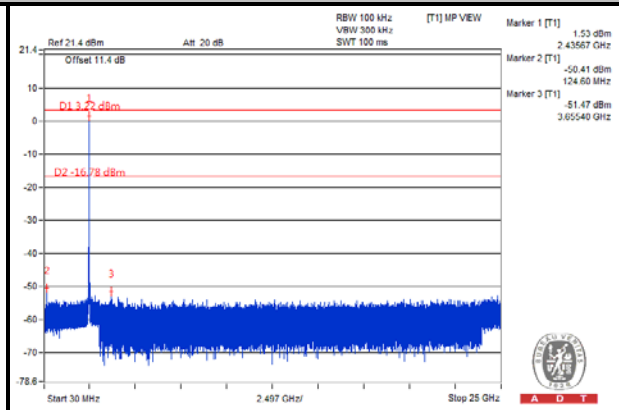
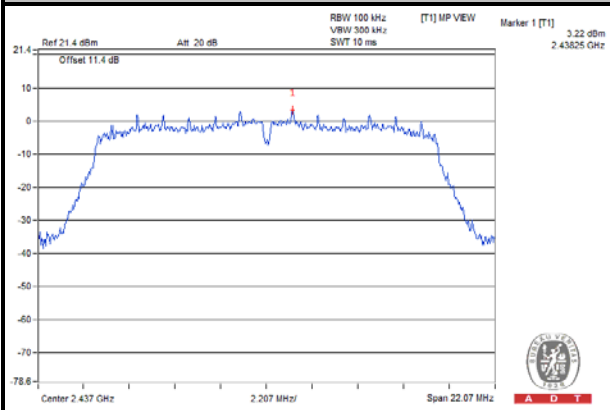

#### CH 11

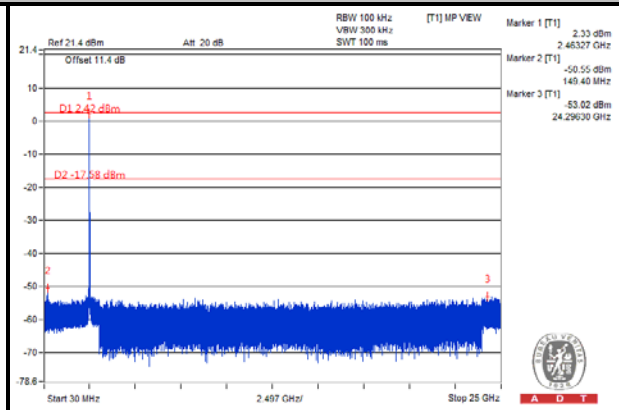
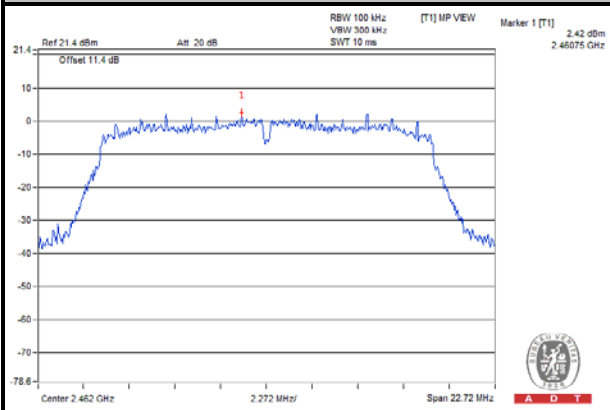



A D T

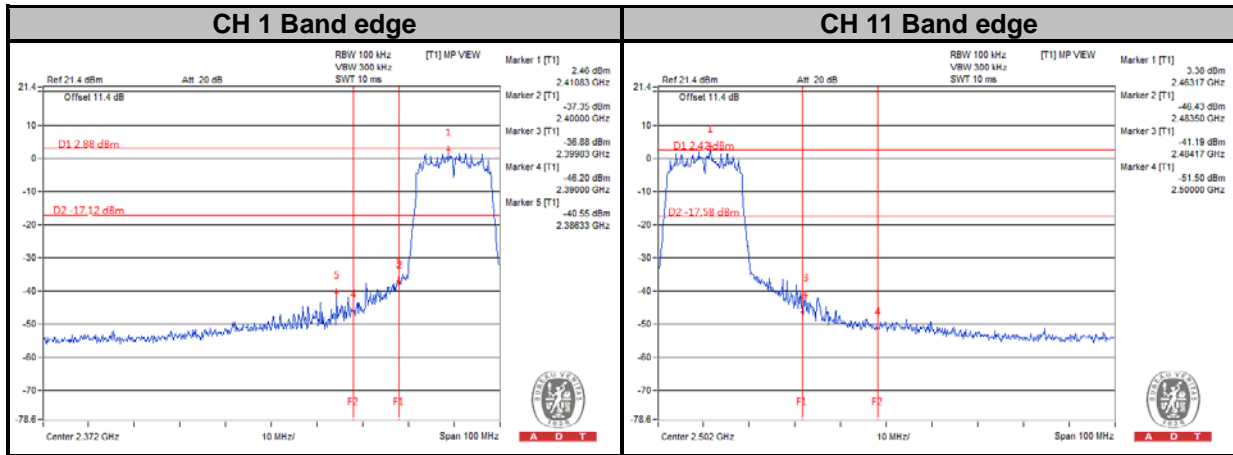



A D T

### 802.11n (20MHz)

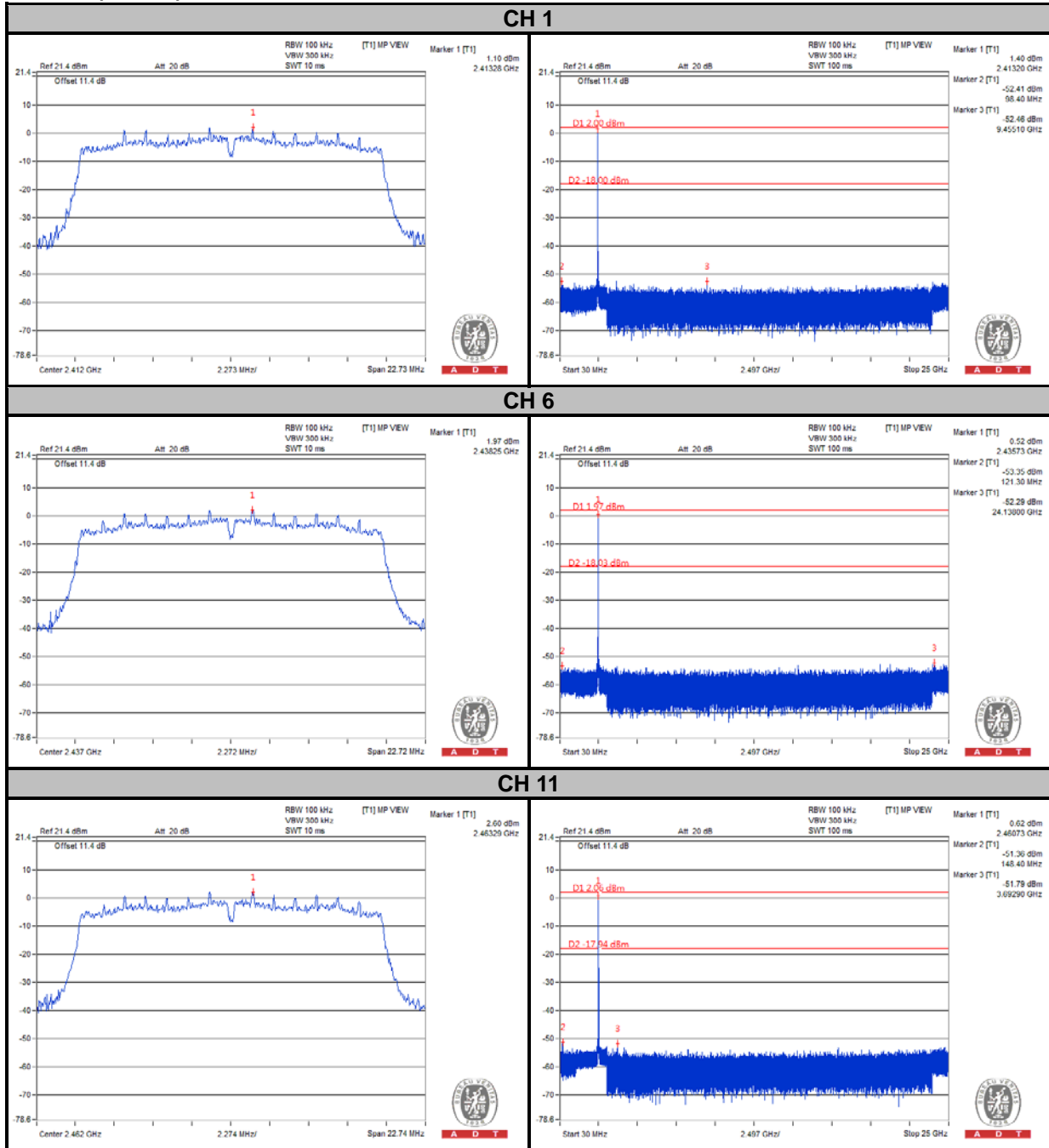



A D T

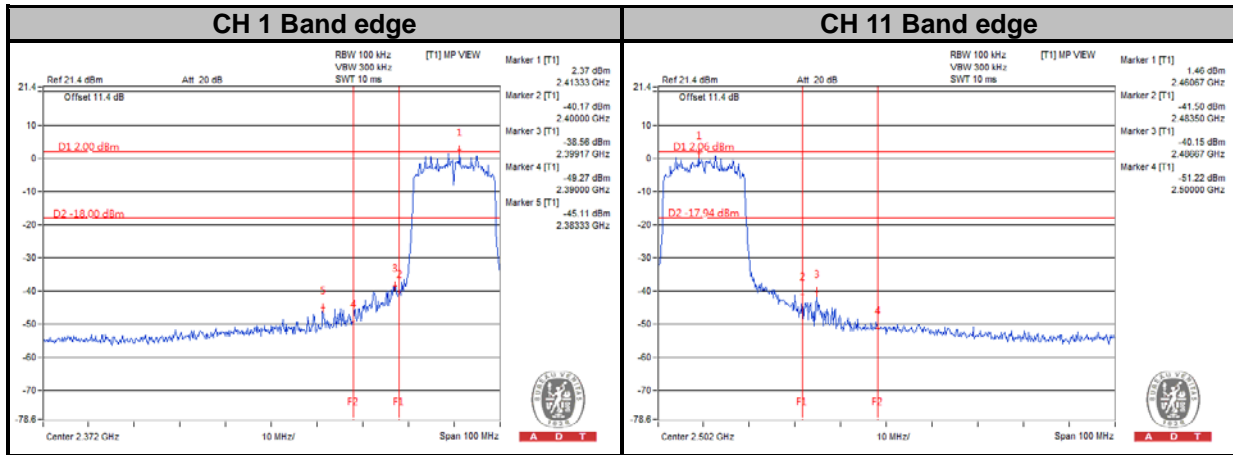



A D T

## 5. PHOTOGRAPHS OF THE TEST CONFIGURATION

Please refer to the attached file (Test Setup Photo).





## 6. INFORMATION ON THE TESTING LABORATORIES

We, Bureau Veritas Consumer Products Services (H.K.) Ltd., Taoyuan Branch, were founded in 1988 to provide our best service in EMC, Radio, Telecom and Safety consultation. Our laboratories are accredited and approved according to ISO/IEC 17025.

If you have any comments, please feel free to contact us at the following:

**Linko EMC/RF Lab:**

Tel: 886-2-26052180

Fax: 886-2-26051924

**Hsin Chu EMC/RF/Telecom Lab:**

Tel: 886-3-5935343

Fax: 886-3-5935342

**Hwa Ya EMC/RF/Safety Lab:**

Tel: 886-3-3183232

Fax: 886-3-3270892

**Email:** [service.adt@tw.bureauveritas.com](mailto:service.adt@tw.bureauveritas.com)

**Web Site:** [www.bureauveritas-adt.com](http://www.bureauveritas-adt.com)

The address and road map of all our labs can be found in our web site also.



A D T

## **7. APPENDIX A – MODIFICATIONS RECORDERS FOR ENGINEERING CHANGES TO THE EUT BY THE LAB**

No any modifications are made to the EUT by the lab during the test.

---END---