

FCC Test Report

Report No.: RF170804C13-2

FCC ID: B32E285BTWF

Test Model: e285 BT/WiFi

Received Date: Aug. 04, 2017

Test Date: Aug. 24, 2017 ~ Aug. 26, 2017

Issued Date: Sep. 04, 2017

Applicant: Verifone, Inc.

Address: 1400 West Stanford Ranch Road Suite 200 Rocklin CA 95765 USA

Issued By: Bureau Veritas Consumer Products Services (H.K.) Ltd., Taoyuan Branch

Lab Address: No. 47-2, 14th Ling, Chia Pau Vil., Lin Kou Dist., New Taipei City, Taiwan
(R.O.C)

Test Location (1): No. 19, Hwa Ya 2nd Rd, Wen Hwa Tsuen, Kwei Shan Hsiang, Taoyuan
Hsien 333, Taiwan, R.O.C.

Test Location (2): No.215, Sec. 3, Beixin Rd., Xindian Dist., New Taipei City 231, Taiwan,
R.O.C



This report is for your exclusive use. Any copying or replication of this report to or for any other person or entity, or use of our name or trademark, is permitted only with our prior written permission. This report sets forth our findings solely with respect to the test samples identified herein. The results set forth in this report are not indicative or representative of the quality or characteristics of the lot from which a test sample was taken or any similar or identical product unless specifically and expressly noted. Our report includes all of the tests requested by you and the results thereof based upon the information that you provided to us. You have 60 days from date of issuance of this report to notify us of any material error or omission caused by our negligence, provided, however, that such notice shall be in writing and shall specifically address the issue you wish to raise. A failure to raise such issue within the prescribed time shall constitute your unqualified acceptance of the completeness of this report, the tests conducted and the correctness of the report contents. Unless specific mention, the uncertainty of measurement has been explicitly taken into account to declare the compliance or non-compliance to the specification.

Table of Contents

Release Control Record	4
1 Certificate of Conformity	5
2 Summary of Test Results	6
2.1 Measurement Uncertainty	6
2.2 Modification Record	6
3 General Information	7
3.1 General Description of EUT	7
3.2 Description of Test Modes	8
3.2.1 Test Mode Applicability and Tested Channel Detail	9
3.3 Duty Cycle of Test Signal	11
3.4 Description of Support Units	12
3.4.1 Configuration of System under Test	12
3.5 General Description of Applied Standards	12
4 Test Types and Results	13
4.1 Radiated Emission and Bandedge Measurement	13
4.1.1 Limits of Radiated Emission and Bandedge Measurement	13
4.1.2 Test Instruments	14
4.1.3 Test Procedures	15
4.1.4 Deviation from Test Standard	15
4.1.5 Test Set Up	16
4.1.6 EUT Operating Conditions	16
4.1.7 Test Results	17
4.2 Conducted Emission Measurement	27
4.2.1 Limits of Conducted Emission Measurement	27
4.2.2 Test Instruments	27
4.2.3 Test Procedures	28
4.2.4 Deviation from Test Standard	28
4.2.5 Test Setup	28
4.2.6 EUT Operating Conditions	28
4.2.7 Test Results	29
4.3 6dB Bandwidth Measurement	31
4.3.1 Limits of 6dB Bandwidth Measurement	31
4.3.2 Test Setup	31
4.3.3 Test Instruments	31
4.3.4 Test Procedure	31
4.3.5 Deviation from Test Standard	31
4.3.6 EUT Operating Conditions	31
4.3.7 Test Result	32
4.4 Conducted Output Power Measurement	34
4.4.1 Limits of Conducted Output Power Measurement	34
4.4.2 Test Setup	34
4.4.3 Test Instruments	34
4.4.4 Test Procedures	34
4.4.5 Deviation from Test Standard	34
4.4.6 EUT Operating Conditions	34
4.4.7 Test Results	35
4.5 Power Spectral Density Measurement	36
4.5.1 Limits of Power Spectral Density Measurement	36
4.5.2 Test Setup	36
4.5.3 Test Instruments	36
4.5.4 Test Procedure	36
4.5.5 Deviation from Test Standard	36
4.5.6 EUT Operating Condition	36

4.5.7 Test Results	37
4.6 Conducted Out of Band Emission Measurement	39
4.6.1 Limits of Conducted Out of Band Emission Measurement.....	39
4.6.2 Test Setup.....	39
4.6.3 Test Instruments	39
4.6.4 Test Procedure	39
4.6.5 Deviation from Test Standard	39
4.6.6 EUT Operating Condition	39
4.6.7 Test Results	40
5 Pictures of Test Arrangements.....	46
Appendix – Information on the Testing Laboratories	47

Release Control Record

Issue No.	Description	Date Issued
RF170804C13-2	Original Release	Sep. 04, 2017

1 Certificate of Conformity

Product: Point of Sale Terminal

Brand: Verifone

Test Model: e285 BT/WiFi

Sample Status: Identical Prototype

Applicant: Verifone, Inc.

Test Date: Aug. 24, 2017 ~ Aug. 26, 2017

Standards: 47 CFR FCC Part 15, Subpart C (Section 15.247)
ANSI C63.10:2013

The above equipment has been tested by **Bureau Veritas Consumer Products Services (H.K.) Ltd., Taoyuan Branch**, and found compliance with the requirement of the above standards. The test record, data evaluation & Equipment Under Test (EUT) configurations represented herein are true and accurate accounts of the measurements of the sample's EMC characteristics under the conditions specified in this report.

Prepared by : Evonne Liu , **Date:** Sep. 04, 2017
Evonne Liu / Specialist

Approved by : David Huang , **Date:** Sep. 04, 2017
David Huang / Project Engineer

2 Summary of Test Results

47 CFR FCC Part 15, Subpart C (Section 15.247)			
FCC Clause	Test Item	Result	Remarks
15.207	AC Power Conducted Emission	Pass	Meet the requirement of limit. Minimum passing margin is -20.12 dB at 0.17400 MHz.
15.205 / 15.209 / 15.247(d)	Radiated Emissions and Band Edge Measurement	Pass	Meet the requirement of limit. Minimum passing margin is -3.31 dB at 2490.04 MHz.
15.247(d)	Antenna Port Emission	Pass	Meet the requirement of limit.
15.247(a)(2)	6 dB Bandwidth	Pass	Meet the requirement of limit.
15.247(b)	Conducted power	Pass	Meet the requirement of limit.
15.247(e)	Power Spectral Density	Pass	Meet the requirement of limit.
15.203	Antenna Requirement	Pass	No antenna connector is used.

2.1 Measurement Uncertainty

Where relevant, the following measurement uncertainty levels have been estimated for tests performed on the EUT:

The listed uncertainties are the worst case uncertainty for the entire range of measurement. Please note that the uncertainty values are provided for informational purposes only and are not used in determining the PASS/FAIL results.

Measurement	Frequency	Expanded Uncertainty (k=2) (±)
Conducted Emissions at mains ports	150 kHz ~ 30 MHz	2.44 dB
Radiated Emissions up to 1 GHz	30 MHz ~ 200 MHz	2.0153 dB
	200 MHz ~ 1000 MHz	2.0224 dB
Radiated Emissions above 1 GHz	1 GHz ~ 18 GHz	1.0121 dB
	18 GHz ~ 40 GHz	1.1508 dB

2.2 Modification Record

There were no modifications required for compliance.

3 General Information

3.1 General Description of EUT

Product	Point of Sale Terminal
Brand	Verifone
Test Model	e285 BT/WiFi
Status of EUT	Identical Prototype
Power Supply Rating	5.0 Vdc (adapter or host equipment) 3.8 Vdc (Li-ion battery)
Modulation Type	CCK, DQPSK, DBPSK for DSSS 64QAM, 16QAM, QPSK, BPSK for OFDM
Modulation Technology	DSSS, OFDM
Transfer Rate	802.11b: 11.0 / 5.5 / 2.0 / 1.0 Mbps 802.11g: 54.0 / 48.0 / 36.0 / 24.0 / 18.0 / 12.0 / 9.0 / 6.0 Mbps 802.11n: up to MCS7
Operating Frequency	2412 ~ 2462 MHz
Number of Channel	11 for 802.11b, 802.11g, 802.11n (HT20)
Output Power	172.187 mW
Antenna Type	PIFA antenna with 1 dBi gain
Antenna Connector	N/A
Accessory Device	Refer to Note as below
Data Cable Supplied	Refer to Note as below

Note:

- The EUT provides 1 completed transmitter and 1 receiver.

Modulation Mode	Tx Function
802.11b	1TX
802.11g	1TX
802.11n (HT20)	1TX

- The EUT contains following accessory devices.

Product	Brand	Model	Description
Adapter	Verifone	PSAA05A-050QL6V	I/P: 100-240 Vac, 50/60 Hz, 0.2 A O/P: 5 Vdc, 1.0 A Manufacturer: Phihong
Battery	Verifone	BPK087-600	3.8 Vdc, 1800mAh
BT/WLAN Module	Murata	SP-5HY1NL-B	--
USB Cable	Verifone	CBL087-500-01	1m shielded cable w/o core

- The above EUT information is declared by manufacturer and for more detailed features description, please refer to the manufacturer's specifications or user's manual.

3.2 Description of Test Modes

11 channels are provided for 802.11b, 802.11g and 802.11n (HT20):

Channel	Frequency (MHz)	Channel	Frequency (MHz)
1	2412	7	2442
2	2417	8	2447
3	2422	9	2452
4	2427	10	2457
5	2432	11	2462
6	2437		

3.2.1 Test Mode Applicability and Tested Channel Detail

EUT Configure Mode	Applicable To				Description
	RE \geq 1G	RE<1G	PLC	APCM	
-	√	√	√	√	-

Where **RE \geq 1G**: Radiated Emission above 1 GHz **RE<1G**: Radiated Emission below 1 GHz
PLC: Power Line Conducted Emission **APCM**: Antenna Port Conducted Measurement

NOTE: The EUT had been pre-tested on the positioned of each 3 axis. The worst case was found when positioned on **X-plane**.

Radiated Emission Test (Above 1 GHz):

- Pre-Scan has been conducted to determine the worst-case mode from all possible combinations between available modulations, data rates and antenna ports (if EUT with antenna diversity architecture).
- Following channel(s) was (were) selected for the final test as listed below.

EUT Configure Mode	Mode	Available Channel	Tested Channel	Modulation Technology	Modulation Type	Data Rate (Mbps)
-	802.11b	1 to 11	1, 6, 11	DSSS	DBPSK	1.0
-	802.11g	1 to 11	1, 6, 11	OFDM	BPSK	6.0
-	802.11n (HT20)	1 to 11	1, 6, 11	OFDM	BPSK	MCS0

Radiated Emission Test (Below 1 GHz):

- Pre-Scan has been conducted to determine the worst-case mode from all possible combinations between available modulations, data rates and antenna ports (if EUT with antenna diversity architecture).
- Following channel(s) was (were) selected for the final test as listed below.

EUT Configure Mode	Mode	Available Channel	Tested Channel	Modulation Technology	Modulation Type	Data Rate (Mbps)
-	802.11b	1 to 11	11	DSSS	DBPSK	1.0

Power Line Conducted Emission Test:

- Pre-Scan has been conducted to determine the worst-case mode from all possible combinations between available modulations, data rates and antenna ports (if EUT with antenna diversity architecture).
- Following channel(s) was (were) selected for the final test as listed below.

EUT Configure Mode	Mode	Available Channel	Tested Channel	Modulation Technology	Modulation Type	Data Rate (Mbps)
-	802.11b	1 to 11	11	DSSS	DBPSK	1.0

Bandedge Measurement:

- Pre-Scan has been conducted to determine the worst-case mode from all possible combinations between available modulations, data rates and antenna ports (if EUT with antenna diversity architecture).
- Following channel(s) was (were) selected for the final test as listed below.

EUT Configure Mode	Mode	Available Channel	Tested Channel	Modulation Technology	Modulation Type	Data Rate (Mbps)
-	802.11b	1 to 11	1, 11	DSSS	DBPSK	1.0
-	802.11g	1 to 11	1, 11	OFDM	BPSK	6.0
-	802.11n (HT20)	1 to 11	1, 11	OFDM	BPSK	MCS0

Antenna Port Conducted Measurement:

- This item includes all test value of each mode, but only includes spectrum plot of worst value of each mode.
- Pre-Scan has been conducted to determine the worst-case mode from all possible combinations between available modulations, data rates and antenna ports (if EUT with antenna diversity architecture).
- Following channel(s) was (were) selected for the final test as listed below.

EUT Configure Mode	Mode	Available Channel	Tested Channel	Modulation Technology	Modulation Type	Data Rate (Mbps)
-	802.11b	1 to 11	1, 6, 11	DSSS	DBPSK	1.0
-	802.11g	1 to 11	1, 6, 11	OFDM	BPSK	6.0
-	802.11n (HT20)	1 to 11	1, 6, 11	OFDM	BPSK	MCS0

Test Condition:

Applicable To	Environmental Conditions	Input Power	Tested by
RE≥1G	25 deg. C, 65 % RH	120 Vac, 60 Hz	Karl Lee
RE<1G	25 deg. C, 65 % RH	120 Vac, 60 Hz	Karl Lee
PLC	25 deg. C, 65 % RH	120 Vac, 60 Hz	Han Wu
APCM	25 deg. C, 65 % RH	3.8 Vdc	Wayne Lin

3.3 Duty Cycle of Test Signal

802.11b: Duty cycle of test signal is 100 %

802.11g: Duty cycle = $1.426/1.549 = 0.921$, Duty factor = $10 * \log(1/0.921) = 0.36$

802.11n (HT20): Duty cycle = $1.333/1.436 = 0.928$, Duty factor = $10 * \log(1/0.928) = 0.32$

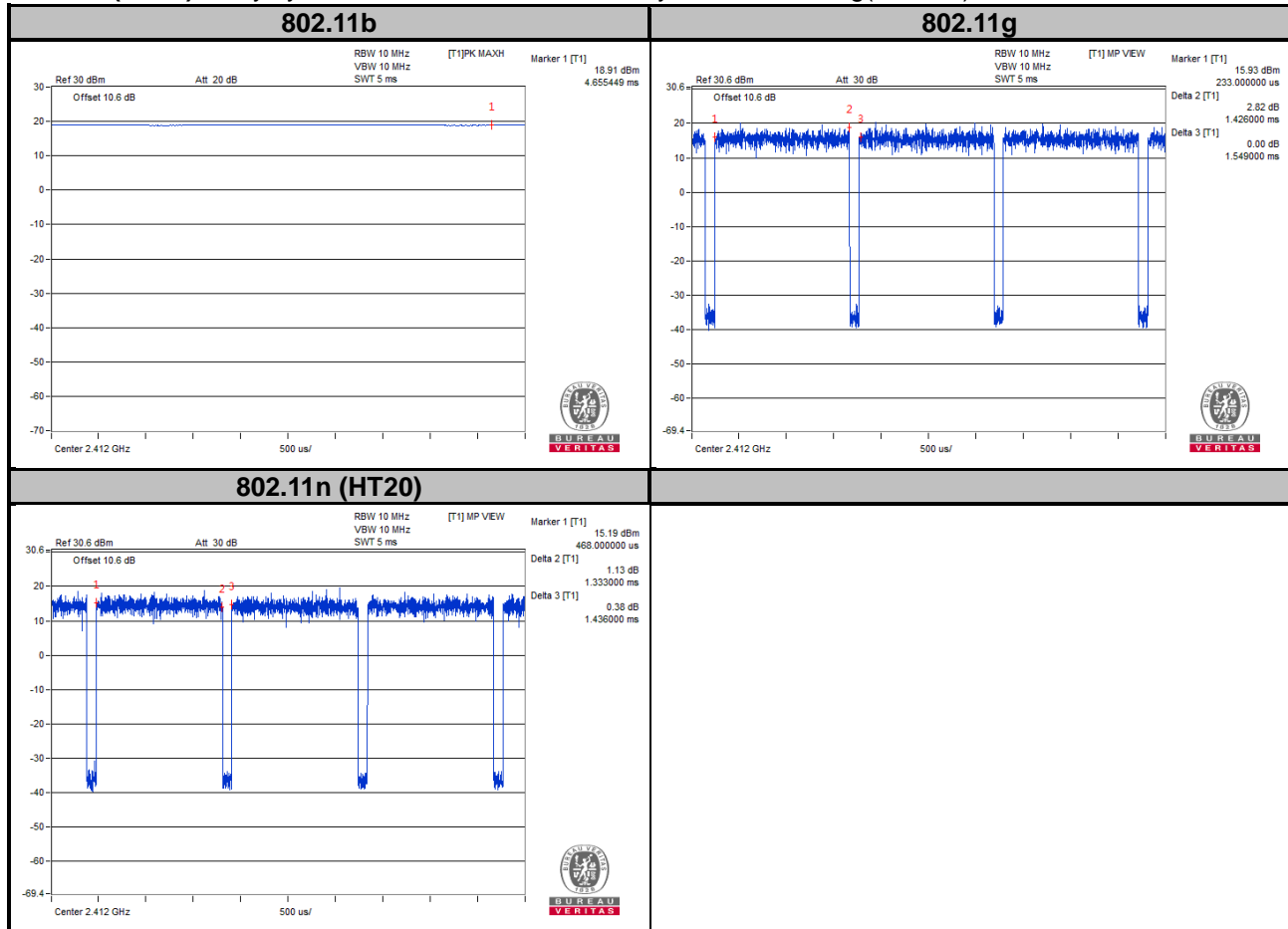

3.4 Description of Support Units

The EUT has been tested as an independent unit together with other necessary accessories or support units.

3.4.1 Configuration of System under Test

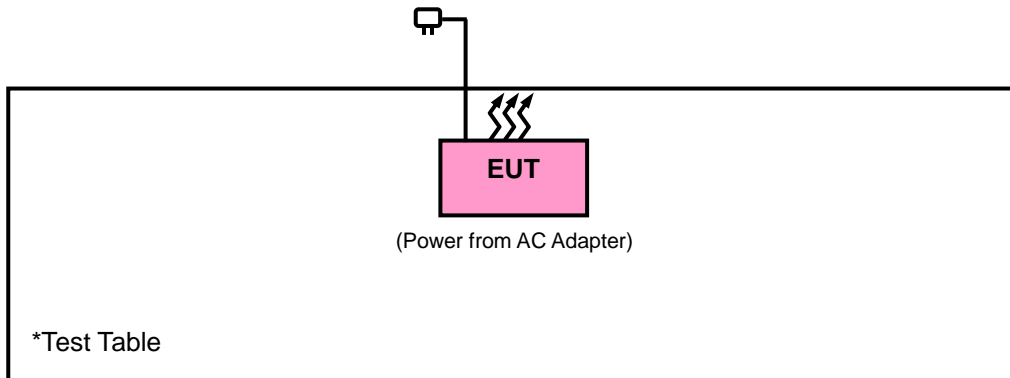

3.5 General Description of Applied Standards

The EUT is a RF Product. According to the specifications of the manufacturer, it must comply with the requirements of the following standards:

FCC Part 15, Subpart C (15.247)

558074 D01 DTS Meas Guidance v04

ANSI C63.10-2013

All test items have been performed and recorded as per the above standards.

NOTE: The EUT has been verified to comply with the requirements of FCC Part 15, Subpart B, Class B (DoC).
The test report has been issued separately.

4 Test Types and Results

4.1 Radiated Emission and Bandedge Measurement

4.1.1 Limits of Radiated Emission and Bandedge Measurement

Radiated emissions which fall in the restricted bands must comply with the radiated emission limits specified as below table. Other emissions shall be at least 20 dB below the highest level of the desired power:

Frequencies (MHz)	Field Strength (microvolts/meter)	Measurement Distance (meters)
0.009 ~ 0.490	2400/F (kHz)	300
0.490 ~ 1.705	24000/F (kHz)	30
1.705 ~ 30.0	30	30
30 ~ 88	100	3
88 ~ 216	150	3
216 ~ 960	200	3
Above 960	500	3

NOTE:

1. The lower limit shall apply at the transition frequencies.
2. Emission level (dBuV/m) = 20 log Emission level (uV/m).
3. For frequencies above 1000 MHz, the field strength limits are based on average detector, however, the peak field strength of any emission shall not exceed the maximum permitted average limits, specified above by more than 20 dB under any condition of modulation.

4.1.2 Test Instruments

Description & Manufacturer	Model No.	Serial No.	Date of Calibration	Due Date of Calibration
Test Receiver Agilent Technologies	N9038A	MY52260177	Jul. 05, 2017	Jul. 04, 2018
Spectrum Analyzer ROHDE & SCHWARZ	FSU43	101261	Dec. 13, 2016	Dec. 12, 2017
BILOG Antenna SCHWARZBECK	VULB9168	9168-472	Dec. 16, 2016	Dec. 15, 2017
HORN Antenna ETS-Lindgren	3117	00143293	Dec. 29, 2016	Dec. 28, 2017
HORN Antenna SCHWARZBECK	BBHA 9170	9170-480	Dec. 14, 2016	Dec. 13, 2017
Bluetooth Tester	CBT	100980	Apr. 19, 2017	Apr. 18, 2018
Preamplifier Agilent	310N	187226	Jun. 23, 2017	Jun. 22, 2018
Preamplifier Agilent	83017A	MY39501357	Jun. 23, 2017	Jun. 22, 2018
Power Meter Anritsu	ML2495A	1232002	Sep. 08, 2016	Sep. 07, 2017
Power Sensor Anritsu	MA2411B	1207325	Sep. 08, 2016	Sep. 07, 2017
RF signal cable ETS-LINDGREN	5D-FB	Cable-CH1-01(R FC-SMS-100-SM S-120+RFC-SMS -100-SMS-400)	Jun. 23, 2017	Jun. 22, 2018
RF signal cable ETS-LINDGREN	8D-FB	Cable-CH1-02(R FC-SMS-100-SM S-24)	Jun. 23, 2017	Jun. 22, 2018
Software BV ADT	E3 8.130425b	NA	NA	NA
Antenna Tower MF	NA	NA	NA	NA
Turn Table MF	NA	NA	NA	NA
Antenna Tower & Turn Table Controller MF	MF-7802	NA	NA	NA

- Note: 1. The calibration interval of the above test instruments is 12 months and the calibrations are traceable to NML/ROC and NIST/USA.
2. The test was performed in HsinTien Chamber 1.
3. The horn antenna and preamplifier (model: 83017A) are used only for the measurement of emission frequency above 1 GHz if tested.
4. The IC Site Registration No. is IC7450I-1.

4.1.3 Test Procedures

- a. The EUT was placed on the top of a rotating table 0.8 meters (for below 1 GHz) / 1.5 meters (for above 1 GHz) above the ground at 3 meter chamber room for test. The table was rotated 360 degrees to determine the position of the highest radiation.
- b. The EUT was set 3 meters away from the interference-receiving antenna, which was mounted on the top of a variable-height antenna tower.
- c. The height of antenna is varied from one meter to four meters above the ground to determine the maximum value of the field strength. Both horizontal and vertical polarizations of the antenna are set to make the measurement.
- d. For each suspected emission, the EUT was arranged to its worst case and then the antenna was tuned to heights from 1 meter to 4 meters and the rotatable table was turned from 0 degrees to 360 degrees to find the maximum reading.
- e. The test-receiver system was set to quasi-peak detect function and specified bandwidth with maximum hold mode when the test frequency is below 1 GHz.
- f. The test-receiver system was set to peak and average detected function and specified bandwidth with maximum hold mode when the test frequency is above 1 GHz. If the peak reading value also meets average limit, measurement with the average detector is unnecessary.

Note:

1. The resolution bandwidth and video bandwidth of test receiver/spectrum analyzer is 120 kHz & 360 KHz for Quasi-peak detection (QP) at frequency below 1 GHz.
2. The resolution bandwidth of test receiver/spectrum analyzer is 1 MHz and the video bandwidth is 3 MHz for Peak detection (PK) at frequency above 1 GHz.
3. The resolution bandwidth of test receiver/spectrum analyzer is 1 MHz and the video bandwidth is 1/T for Average (Duty cycle < 98 %) detection at frequency above 1 GHz.
4. The resolution bandwidth of test receiver/spectrum analyzer is 1 MHz and the video bandwidth is 10 Hz (Duty cycle \geq 98 %) for Average detection (AV) at frequency above 1 GHz.
5. All modes of operation were investigated and the worst-case emissions are reported.

4.1.4 Deviation from Test Standard

No deviation.

4.1.5 Test Set Up

<Frequency Range below 1 GHz>

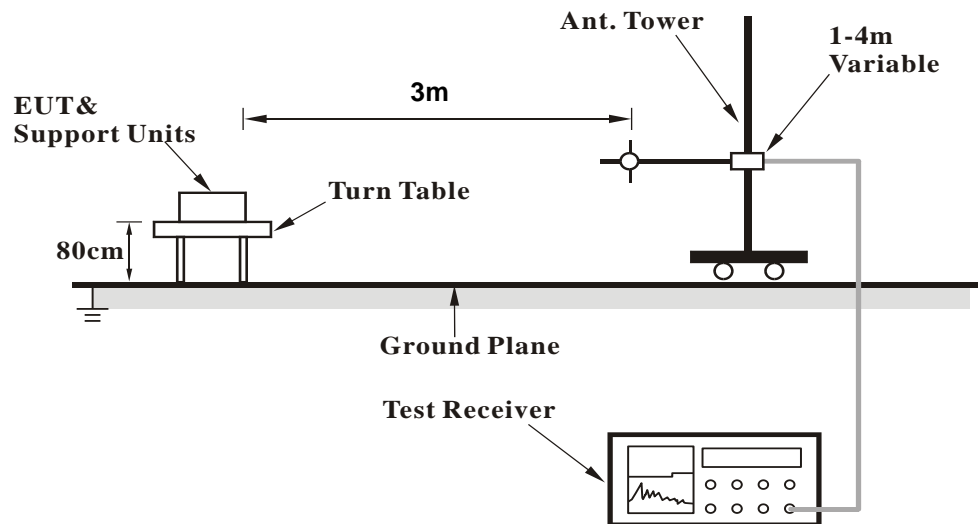

<Frequency Range above 1 GHz>

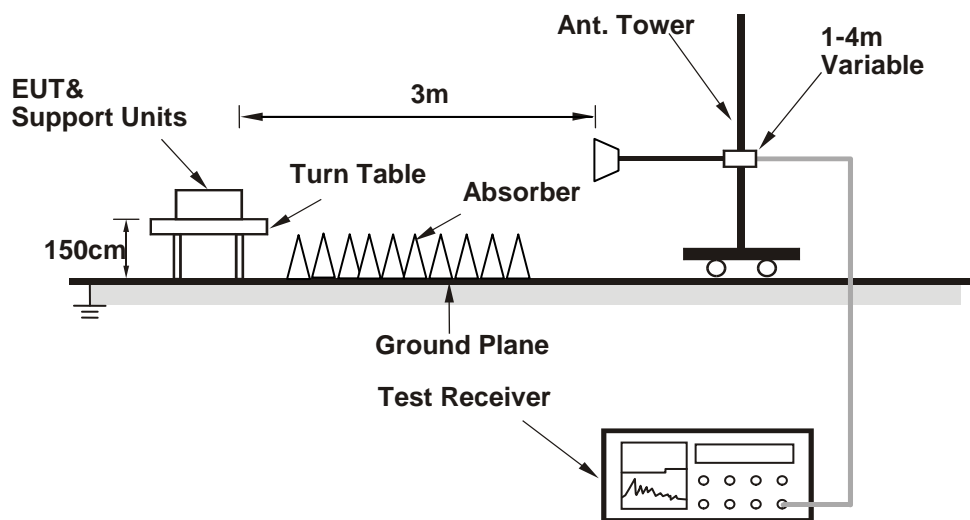

For the actual test configuration, please refer to the attached file (Test Setup Photo).

4.1.6 EUT Operating Conditions

- Placed the EUT on a testing table.
- Use the software to control the EUT under transmission condition continuously at specific channel frequency.

4.1.7 Test Results

Above 1 GHz Data :

802.11b

EUT Test Condition		Measurement Detail	
Channel	Channel 1	Frequency Range	1 GHz ~ 25 GHz
Input Power	120 Vac, 60 Hz	Detector Function	Peak (PK) Average (AV)
Environmental Conditions	25 deg. C, 65 % RH	Tested By	Karl Lee

Antennal Polarity & Test Distance: Horizontal at 3 m										
Frequency (MHz)	Emission Level (dBuV/m)	Read Level (dBuV)	Limit (dBuV/m)	Margin (dB)	Antenna Factor (dB/m)	Cable Loss (dB)	Preamp Factor (dB)	Antenna Height (cm)	Table Angle (Degree)	Remark
2383.8	46.78	45.09	54	-7.22	31.78	5.4	35.49	133	9	Average
2383.8	55.84	54.15	74	-18.16	31.78	5.4	35.49	133	9	Peak
2412	105.69	103.92			31.81	5.43	35.47	133	9	Average
2412	108.36	106.59			31.81	5.43	35.47	133	9	Peak
4824	40.35	32.22	54	-13.65	33.97	8.26	34.1	154	166	Average
4824	47.74	39.61	74	-26.26	33.97	8.26	34.1	154	166	Peak

Antennal Polarity & Test Distance: Vertical at 3 m										
Frequency (MHz)	Emission Level (dBuV/m)	Read Level (dBuV)	Limit (dBuV/m)	Margin (dB)	Antenna Factor (dB/m)	Cable Loss (dB)	Preamp Factor (dB)	Antenna Height (cm)	Table Angle (Degree)	Remark
2388.66	42.49	40.78	54	-11.51	31.8	5.4	35.49	260	337	Average
2388.66	52.6	50.89	74	-21.4	31.8	5.4	35.49	260	337	Peak
2412	99.2	97.43			31.81	5.43	35.47	260	337	Average
2412	102.9	101.13			31.81	5.43	35.47	260	337	Peak
4824	40.32	32.19	54	-13.68	33.97	8.26	34.1	104	134	Average
4824	48.23	40.1	74	-25.77	33.97	8.26	34.1	104	134	Peak

Remarks:

- Emission Level = Read Level + Antenna Factor + Cable Loss - Preamp Factor
Margin value = Emission level – Limit value
- 2412 MHz: Fundamental frequency.

EUT Test Condition		Measurement Detail	
Channel	Channel 6	Frequency Range	1 GHz ~ 25 GHz
Input Power	120 Vac, 60 Hz	Detector Function	Peak (PK) Average (AV)
Environmental Conditions	25 deg. C, 65 % RH	Tested By	Karl Lee

Antennal Polarity & Test Distance: Horizontal at 3 m										
Frequency (MHz)	Emission Level (dBuV/m)	Read Level (dBuV)	Limit (dBuV/m)	Margin (dB)	Antenna Factor (dB/m)	Cable Loss (dB)	Preamp Factor (dB)	Antenna Height (cm)	Table Angle (Degree)	Remark
2387.13	42.21	40.5	54	-11.79	31.8	5.4	35.49	273	251	Average
2387.13	52.48	50.77	74	-21.52	31.8	5.4	35.49	273	251	Peak
2437	105.07	103.22			31.85	5.46	35.46	273	251	Average
2437	108.74	106.89			31.85	5.46	35.46	273	251	Peak
2496.92	43.01	40.99	54	-10.99	31.9	5.53	35.41	273	251	Average
2496.92	53.21	51.19	74	-20.79	31.9	5.53	35.41	273	251	Peak
Antennal Polarity & Test Distance: Vertical at 3 m										
Frequency (MHz)	Emission Level (dBuV/m)	Read Level (dBuV)	Limit (dBuV/m)	Margin (dB)	Antenna Factor (dB/m)	Cable Loss (dB)	Preamp Factor (dB)	Antenna Height (cm)	Table Angle (Degree)	Remark
2385.42	40.78	39.09	54	-13.22	31.78	5.4	35.49	283	260	Average
2385.42	52.07	50.38	74	-21.93	31.78	5.4	35.49	283	260	Peak
2437	99.97	98.12			31.85	5.46	35.46	283	260	Average
2437	102.77	100.92			31.85	5.46	35.46	283	260	Peak
2491.04	41.45	39.44	54	-12.55	31.9	5.53	35.42	283	260	Average
2491.04	52.49	50.48	74	-21.51	31.9	5.53	35.42	283	260	Peak

Remarks:

- Emission Level = Read Level + Antenna Factor + Cable Loss - Preamp Factor
Margin value = Emission level – Limit value
- 2437 MHz: Fundamental frequency.

EUT Test Condition		Measurement Detail	
Channel	Channel 11	Frequency Range	1 GHz ~ 25 GHz
Input Power	120 Vac, 60 Hz	Detector Function	Peak (PK) Average (AV)
Environmental Conditions	25 deg. C, 65 % RH	Tested By	Karl Lee

Antennal Polarity & Test Distance: Horizontal at 3 m										
Frequency (MHz)	Emission Level (dBuV/m)	Read Level (dBuV)	Limit (dBuV/m)	Margin (dB)	Antenna Factor (dB/m)	Cable Loss (dB)	Preamp Factor (dB)	Antenna Height (cm)	Table Angle (Degree)	Remark
2462	105.88	103.95			31.87	5.5	35.44	283	248	Average
2462	108.53	106.6			31.87	5.5	35.44	283	248	Peak
2490.04	50.69	48.68	54	-3.31	31.9	5.53	35.42	283	248	Average
2490.04	57.37	55.36	74	-16.63	31.9	5.53	35.42	283	248	Peak
4924	40.23	31.98	54	-13.77	33.99	8.28	34.02	103	33	Average
4924	47.88	39.63	74	-26.12	33.99	8.28	34.02	103	33	Peak
Antennal Polarity & Test Distance: Vertical at 3 m										
Frequency (MHz)	Emission Level (dBuV/m)	Read Level (dBuV)	Limit (dBuV/m)	Margin (dB)	Antenna Factor (dB/m)	Cable Loss (dB)	Preamp Factor (dB)	Antenna Height (cm)	Table Angle (Degree)	Remark
2462	99.21	97.28			31.87	5.5	35.44	276	256	Average
2462	102.96	101.03			31.87	5.5	35.44	276	256	Peak
2488.84	45.2	43.19	54	-8.8	31.9	5.53	35.42	276	256	Average
2488.84	54.52	52.51	74	-19.48	31.9	5.53	35.42	276	256	Peak
4924	40.65	32.4	54	-13.35	33.99	8.28	34.02	147	344	Average
4924	48.04	39.79	74	-25.96	33.99	8.28	34.02	147	344	Peak

Remarks:

- Emission Level = Read Level + Antenna Factor + Cable Loss - Preamp Factor
Margin value = Emission level – Limit value
- 2462 MHz: Fundamental frequency.

802.11g

EUT Test Condition		Measurement Detail	
Channel	Channel 1	Frequency Range	1 GHz ~ 25 GHz
Input Power	120 Vac, 60 Hz	Detector Function	Peak (PK) Average (AV)
Environmental Conditions	25 deg. C, 65 % RH	Tested By	Karl Lee

Antennal Polarity & Test Distance: Horizontal at 3 m

Frequency (MHz)	Emission Level (dBuV/m)	Read Level (dBuV)	Limit (dBuV/m)	Margin (dB)	Antenna Factor (dB/m)	Cable Loss (dB)	Preamp Factor (dB)	Antenna Height (cm)	Table Angle (Degree)	Remark
2389.92	48.71	46.98	54	-5.29	31.8	5.4	35.47	133	9	Average
2389.92	60.78	59.05	74	-13.22	31.8	5.4	35.47	133	9	Peak
2412	99.63	97.86			31.81	5.43	35.47	133	9	Average
2412	107.22	105.45			31.81	5.43	35.47	133	9	Peak
4824	40.49	32.36	54	-13.51	33.97	8.26	34.1	104	85	Average
4824	47.49	39.36	74	-26.51	33.97	8.26	34.1	104	85	Peak

Antennal Polarity & Test Distance: Vertical at 3 m

Frequency (MHz)	Emission Level (dBuV/m)	Read Level (dBuV)	Limit (dBuV/m)	Margin (dB)	Antenna Factor (dB/m)	Cable Loss (dB)	Preamp Factor (dB)	Antenna Height (cm)	Table Angle (Degree)	Remark
2389.38	43.61	41.9	54	-10.39	31.8	5.4	35.49	260	337	Average
2389.38	56.95	55.24	74	-17.05	31.8	5.4	35.49	260	337	Peak
2412	93.87	92.1			31.81	5.43	35.47	260	337	Average
2412	101.74	99.97			31.81	5.43	35.47	260	337	Peak
4824	40.6	32.47	54	-13.4	33.97	8.26	34.1	133	255	Average
4824	49.33	41.2	74	-24.67	33.97	8.26	34.1	133	255	Peak

Remarks:

- Emission Level = Read Level + Antenna Factor + Cable Loss - Preamp Factor
Margin value = Emission level – Limit value
- 2412 MHz: Fundamental frequency.

EUT Test Condition		Measurement Detail	
Channel	Channel 6	Frequency Range	1 GHz ~ 25 GHz
Input Power	120 Vac, 60 Hz	Detector Function	Peak (PK) Average (AV)
Environmental Conditions	25 deg. C, 65 % RH	Tested By	Karl Lee

Antennal Polarity & Test Distance: Horizontal at 3 m										
Frequency (MHz)	Emission Level (dBuV/m)	Read Level (dBuV)	Limit (dBuV/m)	Margin (dB)	Antenna Factor (dB/m)	Cable Loss (dB)	Preamp Factor (dB)	Antenna Height (cm)	Table Angle (Degree)	Remark
2380.38	41.69	40	54	-12.31	31.78	5.4	35.49	273	251	Average
2380.38	52.81	51.12	74	-21.19	31.78	5.4	35.49	273	251	Peak
2437	99.21	97.36			31.85	5.46	35.46	273	251	Average
2437	107.58	105.73			31.85	5.46	35.46	273	251	Peak
2483.72	42.18	40.22	54	-11.82	31.88	5.5	35.42	273	251	Average
2483.72	54.16	52.2	74	-19.84	31.88	5.5	35.42	273	251	Peak

Antennal Polarity & Test Distance: Vertical at 3 m										
Frequency (MHz)	Emission Level (dBuV/m)	Read Level (dBuV)	Limit (dBuV/m)	Margin (dB)	Antenna Factor (dB/m)	Cable Loss (dB)	Preamp Factor (dB)	Antenna Height (cm)	Table Angle (Degree)	Remark
2387.13	40.54	38.83	54	-13.46	31.8	5.4	35.49	283	260	Average
2387.13	51.99	50.28	74	-22.01	31.8	5.4	35.49	283	260	Peak
2437	93.41	91.56			31.85	5.46	35.46	283	260	Average
2437	101.49	99.64			31.85	5.46	35.46	283	260	Peak
2483.96	41.16	39.2	54	-12.84	31.88	5.5	35.42	283	260	Average
2483.96	51.99	50.03	74	-22.01	31.88	5.5	35.42	283	260	Peak

Remarks:

- Emission Level = Read Level + Antenna Factor + Cable Loss - Preamp Factor
Margin value = Emission level – Limit value
- 2437 MHz: Fundamental frequency.

EUT Test Condition		Measurement Detail	
Channel	Channel 11	Frequency Range	1 GHz ~ 25 GHz
Input Power	120 Vac, 60 Hz	Detector Function	Peak (PK) Average (AV)
Environmental Conditions	25 deg. C, 65 % RH	Tested By	Karl Lee

Antennal Polarity & Test Distance: Horizontal at 3 m										
Frequency (MHz)	Emission Level (dBuV/m)	Read Level (dBuV)	Limit (dBuV/m)	Margin (dB)	Antenna Factor (dB/m)	Cable Loss (dB)	Preamp Factor (dB)	Antenna Height (cm)	Table Angle (Degree)	Remark
2462	99.87	97.94			31.87	5.5	35.44	283	248	Average
2462	107.57	105.64			31.87	5.5	35.44	283	248	Peak
2483.56	48.15	46.19	54	-5.85	31.88	5.5	35.42	283	248	Average
2483.56	61.68	59.72	74	-12.32	31.88	5.5	35.42	283	248	Peak
4924	41.24	32.99	54	-12.76	33.99	8.28	34.02	104	77	Average
4924	47.94	39.69	74	-26.06	33.99	8.28	34.02	104	77	Peak
Antennal Polarity & Test Distance: Vertical at 3 m										
Frequency (MHz)	Emission Level (dBuV/m)	Read Level (dBuV)	Limit (dBuV/m)	Margin (dB)	Antenna Factor (dB/m)	Cable Loss (dB)	Preamp Factor (dB)	Antenna Height (cm)	Table Angle (Degree)	Remark
2462	93.83	91.9			31.87	5.5	35.44	276	256	Average
2462	101.43	99.5			31.87	5.5	35.44	276	256	Peak
2483.64	44.55	42.59	54	-9.45	31.88	5.5	35.42	276	256	Average
2483.64	56.05	54.09	74	-17.95	31.88	5.5	35.42	276	256	Peak
4924	40.63	32.38	54	-13.37	33.99	8.28	34.02	121	104	Average
4924	48.11	39.86	74	-25.89	33.99	8.28	34.02	121	104	Peak

Remarks:

- Emission Level = Read Level + Antenna Factor + Cable Loss - Preamp Factor
Margin value = Emission level – Limit value
- 2462 MHz: Fundamental frequency.

802.11n (HT20)

EUT Test Condition		Measurement Detail	
Channel	Channel 1	Frequency Range	1 GHz ~ 25 GHz
Input Power	120 Vac, 60 Hz	Detector Function	Peak (PK) Average (AV)
Environmental Conditions	25 deg. C, 65 % RH	Tested By	Karl Lee

Antennal Polarity & Test Distance: Horizontal at 3 m

Frequency (MHz)	Emission Level (dBuV/m)	Read Level (dBuV)	Limit (dBuV/m)	Margin (dB)	Antenna Factor (dB/m)	Cable Loss (dB)	Preamp Factor (dB)	Antenna Height (cm)	Table Angle (Degree)	Remark
2389.92	48.55	46.82	54	-5.45	31.8	5.4	35.47	133	9	Average
2389.92	61.06	59.33	74	-12.94	31.8	5.4	35.47	133	9	Peak
2412	97.41	95.64			31.81	5.43	35.47	133	9	Average
2412	105.75	103.98			31.81	5.43	35.47	133	9	Peak
4824	40.87	32.74	54	-13.13	33.97	8.26	34.1	124	199	Average
4824	47.51	39.38	74	-26.49	33.97	8.26	34.1	124	199	Peak

Antennal Polarity & Test Distance: Vertical at 3 m

Frequency (MHz)	Emission Level (dBuV/m)	Read Level (dBuV)	Limit (dBuV/m)	Margin (dB)	Antenna Factor (dB/m)	Cable Loss (dB)	Preamp Factor (dB)	Antenna Height (cm)	Table Angle (Degree)	Remark
2389.47	42.98	41.27	54	-11.02	31.8	5.4	35.49	260	337	Average
2389.47	54.76	53.05	74	-19.24	31.8	5.4	35.49	260	337	Peak
2412	91.86	90.09			31.81	5.43	35.47	260	337	Average
2412	99.17	97.4			31.81	5.43	35.47	260	337	Peak
4824	40.99	32.86	54	-13.01	33.97	8.26	34.1	114	249	Average
4824	49.36	41.23	74	-24.64	33.97	8.26	34.1	114	249	Peak

Remarks:

- Emission Level = Read Level + Antenna Factor + Cable Loss - Preamp Factor
Margin value = Emission level – Limit value
- 2412 MHz: Fundamental frequency.

EUT Test Condition		Measurement Detail	
Channel	Channel 6	Frequency Range	1 GHz ~ 25 GHz
Input Power	120 Vac, 60 Hz	Detector Function	Peak (PK) Average (AV)
Environmental Conditions	25 deg. C, 65 % RH	Tested By	Karl Lee

Antennal Polarity & Test Distance: Horizontal at 3 m										
Frequency (MHz)	Emission Level (dBuV/m)	Read Level (dBuV)	Limit (dBuV/m)	Margin (dB)	Antenna Factor (dB/m)	Cable Loss (dB)	Preamp Factor (dB)	Antenna Height (cm)	Table Angle (Degree)	Remark
2385.87	41.6	39.89	54	-12.4	31.8	5.4	35.49	274	251	Average
2385.87	52.9	51.19	74	-21.1	31.8	5.4	35.49	274	251	Peak
2437	97.79	95.94			31.85	5.46	35.46	274	251	Average
2437	105.48	103.63			31.85	5.46	35.46	274	251	Peak
2489.72	42.08	40.07	54	-11.92	31.9	5.53	35.42	274	251	Average
2489.72	53.99	51.98	74	-20.01	31.9	5.53	35.42	274	251	Peak

Antennal Polarity & Test Distance: Vertical at 3 m										
Frequency (MHz)	Emission Level (dBuV/m)	Read Level (dBuV)	Limit (dBuV/m)	Margin (dB)	Antenna Factor (dB/m)	Cable Loss (dB)	Preamp Factor (dB)	Antenna Height (cm)	Table Angle (Degree)	Remark
2389.56	40.7	38.99	54	-13.3	31.8	5.4	35.49	283	260	Average
2389.56	51.76	50.05	74	-22.24	31.8	5.4	35.49	283	260	Peak
2437	91.82	89.97			31.85	5.46	35.46	283	260	Average
2437	99.63	97.78			31.85	5.46	35.46	283	260	Peak
2488.48	41.32	39.31	54	-12.68	31.9	5.53	35.42	283	260	Average
2488.48	52.58	50.57	74	-21.42	31.9	5.53	35.42	283	260	Peak

Remarks:

- Emission Level = Read Level + Antenna Factor + Cable Loss - Preamp Factor
Margin value = Emission level – Limit value
- 2437 MHz: Fundamental frequency.

EUT Test Condition		Measurement Detail	
Channel	Channel 11	Frequency Range	1 GHz ~ 25 GHz
Input Power	120 Vac, 60 Hz	Detector Function	Peak (PK) Average (AV)
Environmental Conditions	25 deg. C, 65 % RH	Tested By	Karl Lee

Antennal Polarity & Test Distance: Horizontal at 3 m										
Frequency (MHz)	Emission Level (dBuV/m)	Read Level (dBuV)	Limit (dBuV/m)	Margin (dB)	Antenna Factor (dB/m)	Cable Loss (dB)	Preamp Factor (dB)	Antenna Height (cm)	Table Angle (Degree)	Remark
2462	97.63	95.7			31.87	5.5	35.44	283	248	Average
2462	105.84	103.91			31.87	5.5	35.44	283	248	Peak
2485.28	48.18	46.19	54	-5.82	31.88	5.53	35.42	283	248	Average
2485.28	61.41	59.42	74	-12.59	31.88	5.53	35.42	283	248	Peak
4924	41.22	32.97	54	-12.78	33.99	8.28	34.02	105	334	Average
4924	48	39.75	74	-26	33.99	8.28	34.02	105	334	Peak

Antennal Polarity & Test Distance: Vertical at 3 m										
Frequency (MHz)	Emission Level (dBuV/m)	Read Level (dBuV)	Limit (dBuV/m)	Margin (dB)	Antenna Factor (dB/m)	Cable Loss (dB)	Preamp Factor (dB)	Antenna Height (cm)	Table Angle (Degree)	Remark
2462	91.56	89.63			31.87	5.5	35.44	276	256	Average
2462	99.19	97.26			31.87	5.5	35.44	276	256	Peak
2483.92	44.75	42.79	54	-9.25	31.88	5.5	35.42	276	256	Average
2483.92	56.53	54.57	74	-17.47	31.88	5.5	35.42	276	256	Peak
4924	40.79	32.54	54	-13.21	33.99	8.28	34.02	104	339	Average
4924	48.44	40.19	74	-25.56	33.99	8.28	34.02	104	339	Peak

Remarks:

- Emission Level = Read Level + Antenna Factor + Cable Loss - Preamp Factor
Margin value = Emission level – Limit value
- 2462 MHz: Fundamental frequency.

9 kHz ~ 30 MHz DATA:

The amplitude of spurious emissions attenuated more than 20 dB below the permissible value is not required to be report.

30 MHz ~ 1 GHz WORST-CASE DATA:

802.11b

EUT Test Condition		Measurement Detail	
Channel	Channel 11	Frequency Range	30 MHz ~ 1 GHz
Input Power	120 Vac, 60 Hz	Detector Function	Peak (PK) Quasi-peak (QP)
Environmental Conditions	25 deg. C, 65 % RH	Tested By	Karl Lee

Antennal Polarity & Test Distance: Horizontal at 3 m										
Frequency (MHz)	Emission Level (dBuV/m)	Read Level (dBuV)	Limit (dBuV/m)	Margin (dB)	Antenna Factor (dB/m)	Cable Loss (dB)	Preamp Factor (dB)	Antenna Height (cm)	Table Angle (Degree)	Remark
74.82	22.11	44.78	40	-17.89	8.44	1.11	32.22	127	159	Peak
128.28	17.75	39.4	43.5	-25.75	9.2	1.38	32.23	164	160	Peak
232.5	17.13	35.59	46	-28.87	11.86	1.85	32.17	158	241	Peak
379.1	15.06	30.38	46	-30.94	14.58	2.26	32.16	174	164	Peak
615	19.69	30.86	46	-26.31	18.08	2.93	32.18	169	324	Peak
864.9	24.21	31.27	46	-21.79	21.2	3.44	31.7	105	128	Peak

Antennal Polarity & Test Distance: Vertical at 3 m										
Frequency (MHz)	Emission Level (dBuV/m)	Read Level (dBuV)	Limit (dBuV/m)	Margin (dB)	Antenna Factor (dB/m)	Cable Loss (dB)	Preamp Factor (dB)	Antenna Height (cm)	Table Angle (Degree)	Remark
51.6	17.26	34.13	40	-22.74	14.46	0.9	32.23	198	123	Peak
120.18	11.48	32.29	43.5	-32.02	10.16	1.28	32.25	171	124	Peak
214.68	12.36	31.72	43.5	-31.14	11.23	1.65	32.24	164	225	Peak
405	16.76	31.58	46	-29.24	15.06	2.34	32.22	184	155	Peak
619.2	20.26	31.39	46	-25.74	18.12	2.93	32.18	131	150	Peak
791.4	21.79	30.35	46	-24.21	20.24	3.27	32.07	178	124	Peak

Remarks:

- Emission Level = Read Level + Antenna Factor + Cable Loss - Preamp Factor
Margin value = Emission level – Limit value

4.2 Conducted Emission Measurement

4.2.1 Limits of Conducted Emission Measurement

Frequency (MHz)	Conducted Limit (dBuV)	
	Quasi-peak	Average
0.15 - 0.5	66 - 56	56 - 46
0.50 - 5.0	56	46
5.0 - 30.0	60	50

Note: 1. The lower limit shall apply at the transition frequencies.

2. The limit decreases in line with the logarithm of the frequency in the range of 0.15 to 0.50 MHz.

4.2.2 Test Instruments

Description & Manufacturer	Model No.	Serial No.	Date Of Calibration	Due Date Of Calibration
Test Receiver ROHDE & SCHWARZ	ESCI	100613	Nov. 21, 2016	Nov. 20, 2017
RF signal cable (with 10dB PAD) Woken	5D-FB	Cable-cond1-01	Dec. 22, 2016	Dec. 21, 2017
LISN/AMN ROHDE & SCHWARZ (EUT)	ESH3-Z5	835239/001	Mar. 10, 2017	Mar. 09, 2018
LISN/AMN ROHDE & SCHWARZ (Peripheral)	ENV216	101196	Apr. 20, 2017	Apr. 19, 2018
Software ADT	BV ADT_Cond_ V7.3.7.3	NA	NA	NA

Note: 1. The calibration interval of the above test instruments is 12 months and the calibrations are traceable to NML/ROC and NIST/USA.

2. The test was performed in HwaYa Shielded Room 1.

3. The VCCI Site Registration No. is C-2040.

4.2.3 Test Procedures

- a. The EUT was placed 0.4 meters from the conducting wall of the shielded room with EUT being connected to the power mains through a line impedance stabilization network (LISN). Other support units were connected to the power mains through another LISN. The two LISNs provide 50 ohm/50 uH of coupling impedance for the measuring instrument.
- b. Both lines of the power mains connected to the EUT were checked for maximum conducted interference.
- c. The frequency range from 150 kHz to 30 MHz was searched. Emission levels under (Limit – 20 dB) was not recorded.

NOTE: All modes of operation were investigated and the worst-case emissions are reported.

4.2.4 Deviation from Test Standard

No deviation.

4.2.5 Test Setup

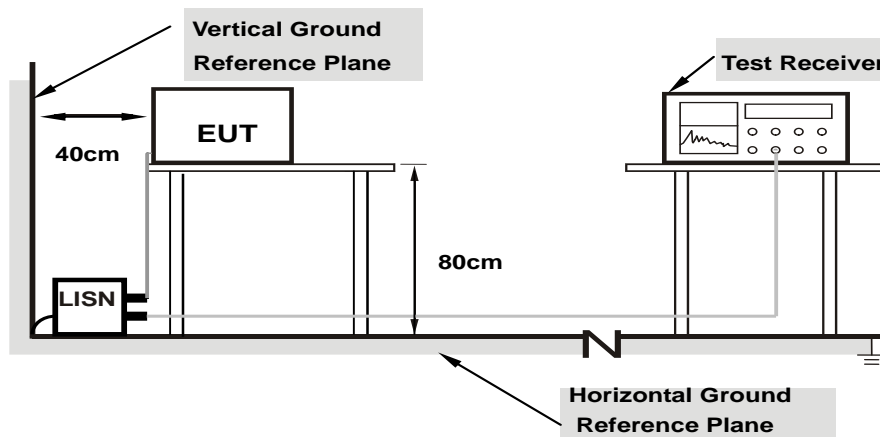

Note: 1.Support units were connected to second LISN.

For the actual test configuration, please refer to the attached file (Test Setup Photo).

4.2.6 EUT Operating Conditions

- a. Placed the EUT on a testing table.
- b. Use the software to control the EUT under transmission condition continuously at specific channel frequency.

4.2.7 Test Results

Frequency Range	150kHz ~ 30MHz	Detector Function & Resolution Bandwidth	Quasi-Peak (QP) / Average (AV), 9kHz
Input Power	120Vac, 60Hz	Environmental Conditions	25°C, 63%RH
Tested by	Han Wu	Test Date	2017/8/25

Phase Of Power : Line (L)										
No	Frequency (MHz)	Correction Factor (dB)	Reading Value (dBuV)		Emission Level (dBuV)		Limit (dBuV)		Margin (dB)	
			Q.P.	AV.	Q.P.	AV.	Q.P.	AV.	Q.P.	AV.
1	0.17400	10.36	34.29	17.69	44.65	28.05	64.77	54.77	-20.12	-26.72
2	0.50600	10.40	14.33	0.40	24.73	10.80	56.00	46.00	-31.27	-35.20
3	0.85800	10.40	6.73	-2.45	17.13	7.95	56.00	46.00	-38.87	-38.05
4	1.37400	10.42	2.48	-3.37	12.90	7.05	56.00	46.00	-43.10	-38.95
5	10.25000	10.84	14.72	0.19	25.56	11.03	60.00	50.00	-34.44	-38.97
6	23.51800	11.46	12.82	-2.61	24.28	8.85	60.00	50.00	-35.72	-41.15

Remarks:

1. Q.P. and AV. are abbreviations of quasi-peak and average individually.
2. The emission levels of other frequencies were very low against the limit.
3. Margin value = Emission level – Limit value
4. Correction factor = Insertion loss + Cable loss
5. Emission Level = Correction Factor + Reading Value

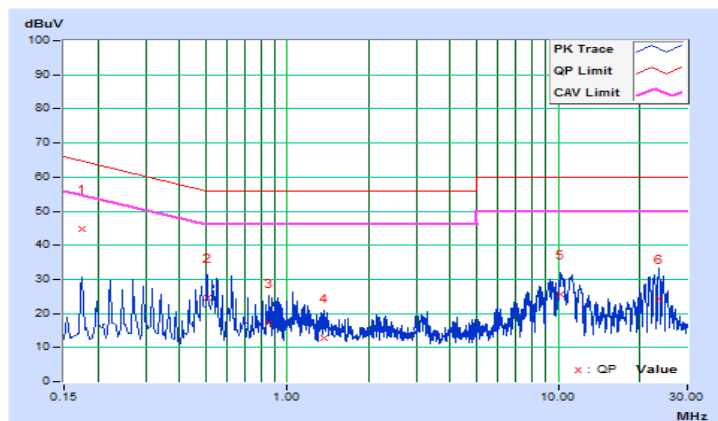

Frequency Range	150kHz ~ 30MHz	Detector Function & Resolution Bandwidth	Quasi-Peak (QP) / Average (AV), 9kHz
Input Power	120Vac, 60Hz	Environmental Conditions	25°C, 63%RH
Tested by	Han Wu	Test Date	2017/8/25

Phase Of Power : Neutral (N)										
No	Frequency (MHz)	Correction Factor (dB)	Reading Value (dBuV)		Emission Level (dBuV)		Limit (dBuV)		Margin (dB)	
			Q.P.	AV.	Q.P.	AV.	Q.P.	AV.	Q.P.	AV.
1	0.22600	10.14	6.38	-2.26	16.52	7.88	62.60	52.60	-46.08	-44.72
2	0.37000	10.16	2.08	-3.30	12.24	6.86	58.50	48.50	-46.26	-41.64
3	1.28200	10.19	2.91	-3.02	13.10	7.17	56.00	46.00	-42.90	-38.83
4	3.40600	10.31	0.97	-4.33	11.28	5.98	56.00	46.00	-44.72	-40.02
5	4.43000	10.36	1.88	-3.28	12.24	7.08	56.00	46.00	-43.76	-38.92
6	10.05800	10.55	16.91	2.78	27.46	13.33	60.00	50.00	-32.54	-36.67

Remarks:

1. Q.P. and AV. are abbreviations of quasi-peak and average individually.
2. The emission levels of other frequencies were very low against the limit.
3. Margin value = Emission level – Limit value
4. Correction factor = Insertion loss + Cable loss
5. Emission Level = Correction Factor + Reading Value

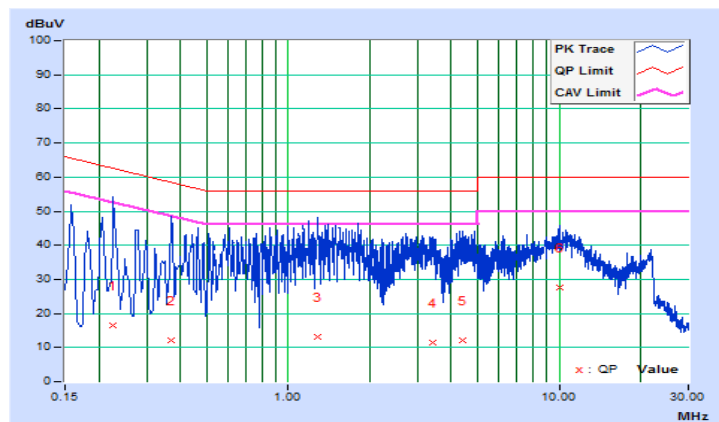

4.3 6 dB Bandwidth Measurement

4.3.1 Limits of 6 dB Bandwidth Measurement

The minimum of 6 dB Bandwidth Measurement is 0.5 MHz.

4.3.2 Test Setup

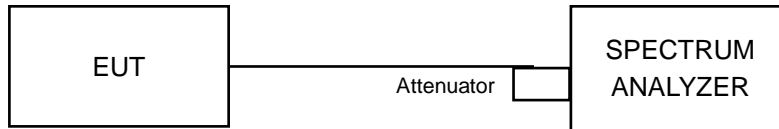

4.3.3 Test Instruments

Refer to section 4.1.2 to get information of above instrument.

4.3.4 Test Procedure

- a. Set resolution bandwidth (RBW) = 100 kHz
- b. Set the video bandwidth (VBW) $\geq 3 \times$ RBW, Detector = Peak.
- c. Trace mode = max hold.
- d. Sweep = auto couple.
- e. Measure the maximum width of the emission that is constrained by the frequencies associated with the two amplitude points (upper and lower) that are attenuated by 6 dB relative to the maximum level measured in the fundamental emission

4.3.5 Deviation from Test Standard

No deviation.

4.3.6 EUT Operating Conditions

The software provided by client to enable the EUT under transmission condition continuously at lowest, middle and highest channel frequencies individually.

4.3.7 Test Result

802.11b

Channel	Frequency (MHz)	6 dB Bandwidth (MHz)	Minimum Limit (MHz)	Pass / Fail
1	2412	9.08	0.5	Pass
6	2437	9.07	0.5	Pass
11	2462	9.57	0.5	Pass

802.11g

Channel	Frequency (MHz)	6 dB Bandwidth (MHz)	Minimum Limit (MHz)	Pass / Fail
1	2412	15.16	0.5	Pass
6	2437	15.15	0.5	Pass
11	2462	15.16	0.5	Pass

802.11n (HT20)

Channel	Frequency (MHz)	6 dB Bandwidth (MHz)	Minimum Limit (MHz)	Pass / Fail
1	2412	15.15	0.5	Pass
6	2437	15.16	0.5	Pass
11	2462	15.17	0.5	Pass

Spectrum Plot of Worst Value

802.11b

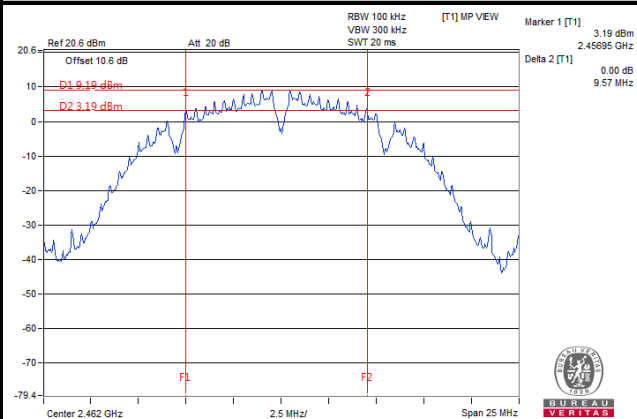

802.11g

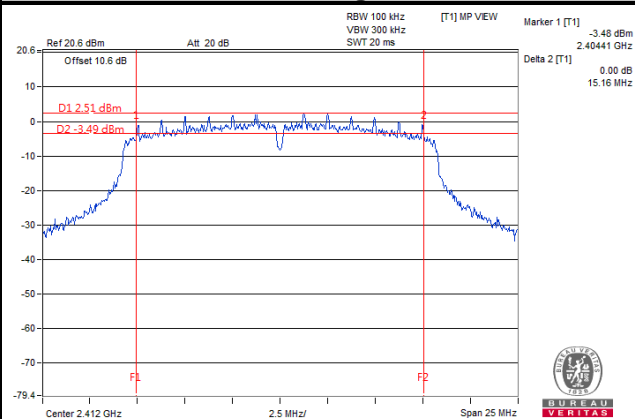

802.11n (HT20)

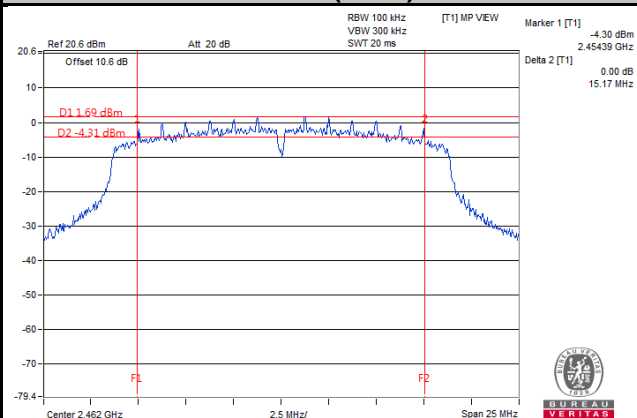

4.4 Conducted Output Power Measurement

4.4.1 Limits of Conducted Output Power Measurement

For systems using digital modulation in the 2400–2483.5 MHz bands: 1 Watt (30 dBm)

4.4.2 Test Setup

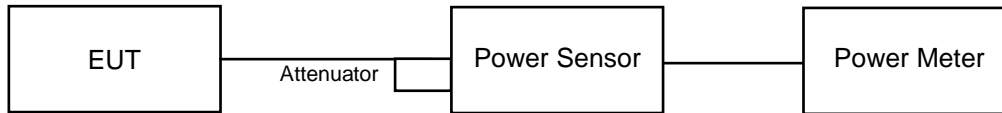

4.4.3 Test Instruments

Refer to section 4.1.2 to get information of above instrument.

4.4.4 Test Procedures

A peak power sensor was used on the output port of the EUT. A power meter was used to read the response of the peak power sensor. Record the power level.

4.4.5 Deviation from Test Standard

No deviation.

4.4.6 EUT Operating Conditions

The software provided by client to enable the EUT under transmission condition continuously at lowest, middle and highest channel frequencies individually.

4.4.7 Test Results

802.11b

Channel	Frequency (MHz)	Peak Power (mW)	Peak Power (dBm)	Limit (dBm)	Pass / Fail
1	2412	89.125	19.50	30	Pass
6	2437	90.365	19.56	30	Pass
11	2462	93.325	19.70	30	Pass

802.11g

Channel	Frequency (MHz)	Peak Power (mW)	Peak Power (dBm)	Limit (dBm)	Pass / Fail
1	2412	159.956	22.04	30	Pass
6	2437	157.398	21.97	30	Pass
11	2462	172.187	22.36	30	Pass

802.11n (HT20)

Channel	Frequency (MHz)	Peak Power (mW)	Peak Power (dBm)	Limit (dBm)	Pass / Fail
1	2412	152.055	21.82	30	Pass
6	2437	153.109	21.85	30	Pass
11	2462	161.436	22.08	30	Pass

4.5 Power Spectral Density Measurement

4.5.1 Limits of Power Spectral Density Measurement

The Maximum of Power Spectral Density Measurement is 8 dBm.

4.5.2 Test Setup

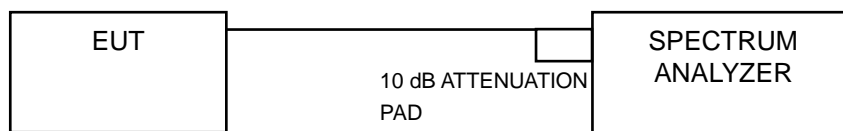

4.5.3 Test Instruments

Refer to section 4.1.2 to get information of above instrument.

4.5.4 Test Procedure

- a. Set analyzer center frequency to DTS channel center frequency.
- b. Set the span to 1.5 times the DTS bandwidth.
- c. Set the RBW to: $3 \text{ kHz} \leq \text{RBW} \leq 100 \text{ kHz}$.
- d. Set the VBW $\geq 3 \times \text{RBW}$.
- e. Detector = peak.
- f. Sweep time = auto couple.
- g. Trace mode = max hold.
- h. Allow trace to fully stabilize.
- i. Use the peak marker function to determine the maximum amplitude level within the RBW.

4.5.5 Deviation from Test Standard

No deviation.

4.5.6 EUT Operating Condition

The software provided by client to enable the EUT under transmission condition continuously at lowest, middle and highest channel frequencies individually.

4.5.7 Test Results

802.11b

Channel	Frequency (MHz)	PSD (dBm/3 kHz)	Limit (dBm/3 kHz)	Pass / Fail
1	2412	-5.51	8	Pass
6	2437	-6.07	8	Pass
11	2462	-5.44	8	Pass

802.11g

Channel	Frequency (MHz)	PSD (dBm/3 kHz)	Limit (dBm/3 kHz)	Pass / Fail
1	2412	-12.35	8	Pass
6	2437	-12.65	8	Pass
11	2462	-12.42	8	Pass

802.11n (HT20)

Channel	Frequency (MHz)	PSD (dBm/3 kHz)	Limit (dBm/3 kHz)	Pass / Fail
1	2412	-13.67	8	Pass
6	2437	-12.63	8	Pass
11	2462	-12.83	8	Pass

Spectrum Plot of Worst Value

802.11b

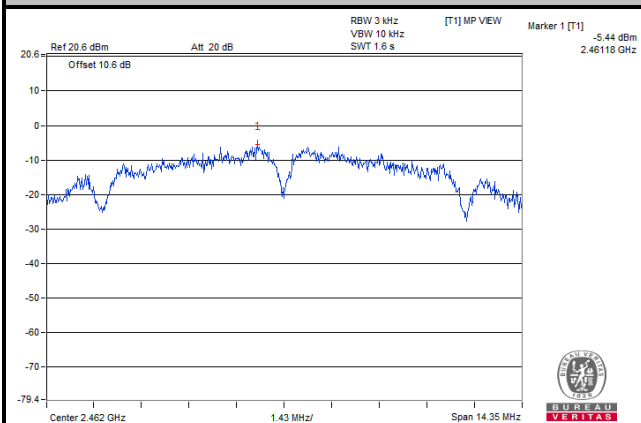

802.11g

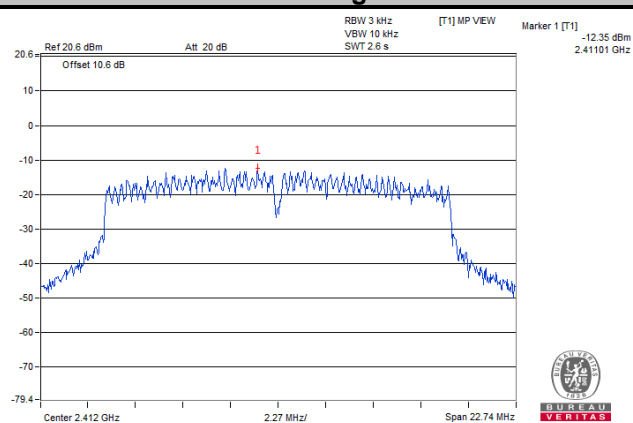

802.11n (HT20)

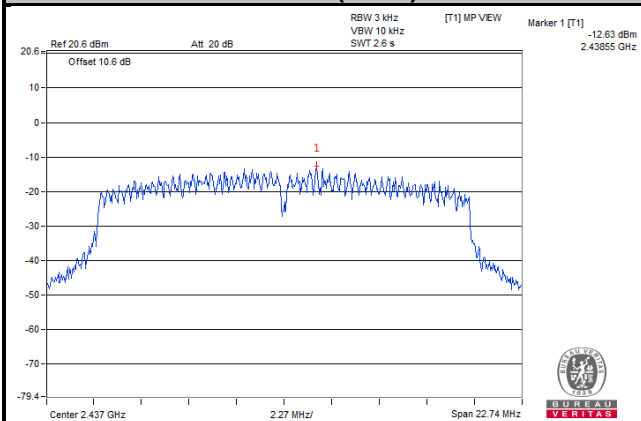

4.6 Conducted Out of Band Emission Measurement

4.6.1 Limits of Conducted Out of Band Emission Measurement

Below 20 dB of the highest emission level of operating band (in 100 kHz Resolution Bandwidth).

4.6.2 Test Setup

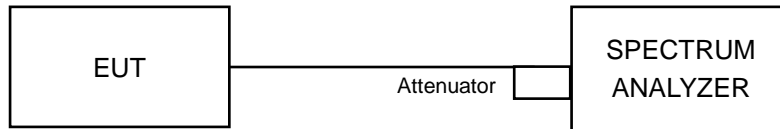

4.6.3 Test Instruments

Refer to section 4.1.2 to get information of above instrument.

4.6.4 Test Procedure

MEASUREMENT PROCEDURE REF

1. Set the RBW = 100 kHz.
2. Set the VBW \geq 300 kHz.
3. Detector = peak.
4. Sweep time = auto couple.
5. Trace mode = max hold.
6. Allow trace to fully stabilize.
7. Use the peak marker function to determine the maximum power level in any 100 kHz band segment within the fundamental EBW.

MEASUREMENT PROCEDURE OOB

1. Set RBW = 100 kHz.
2. Set VBW \geq 300 kHz.
3. Detector = peak.
4. Sweep = auto couple.
5. Trace Mode = max hold.
6. Allow trace to fully stabilize.
7. Use the peak marker function to determine the maximum amplitude level.

4.6.5 Deviation from Test Standard

No deviation.

4.6.6 EUT Operating Condition

The software provided by client to enable the EUT under transmission condition continuously at lowest, middle and highest channel frequencies individually.

4.6.7 Test Results

The spectrum plots are attached on the following images. D1 line indicates the highest level, and D2 line indicates the 20 dB offset below D1. It shows compliance with the requirement.

802.11b

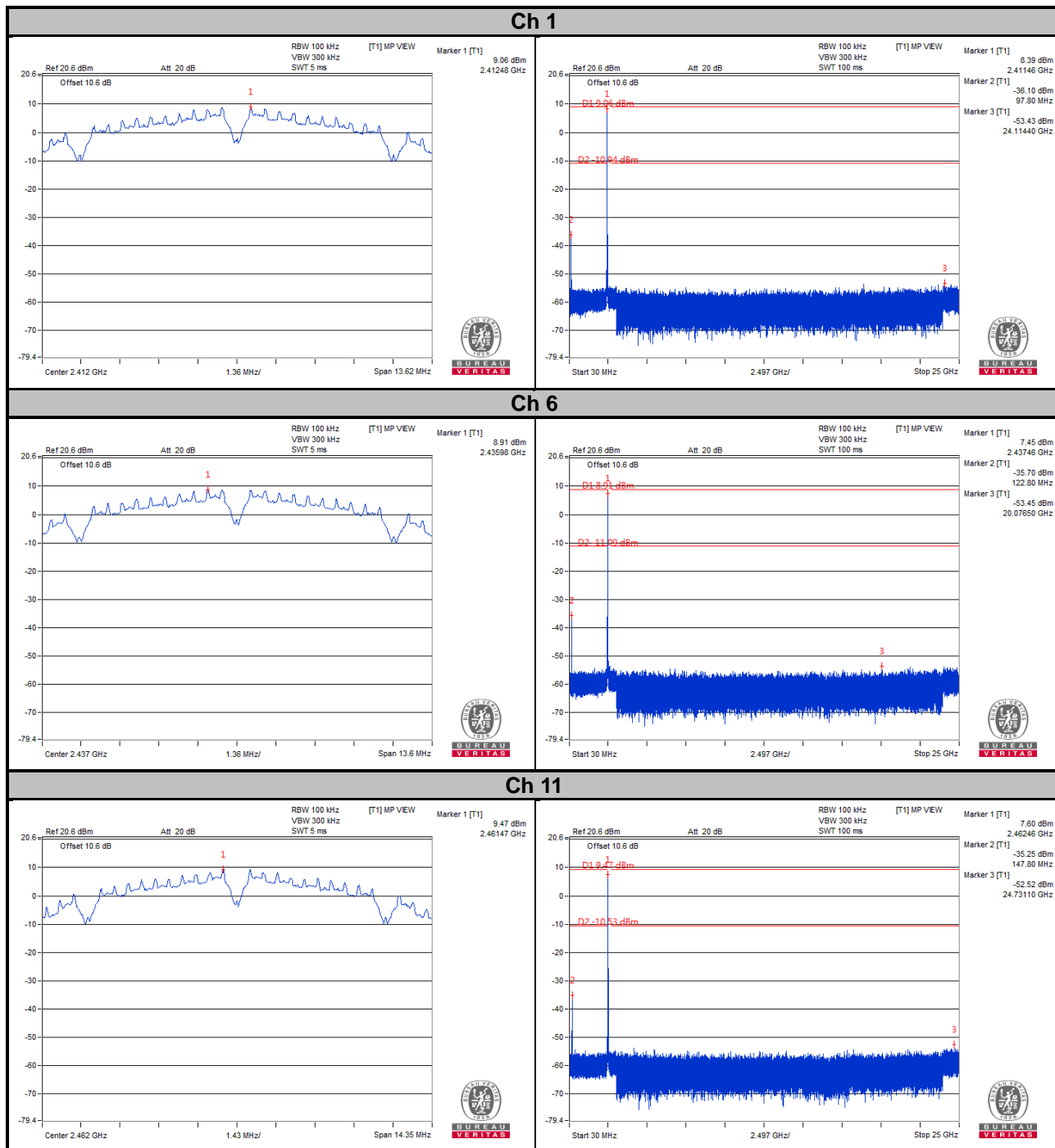

Ch 1 Band Edge

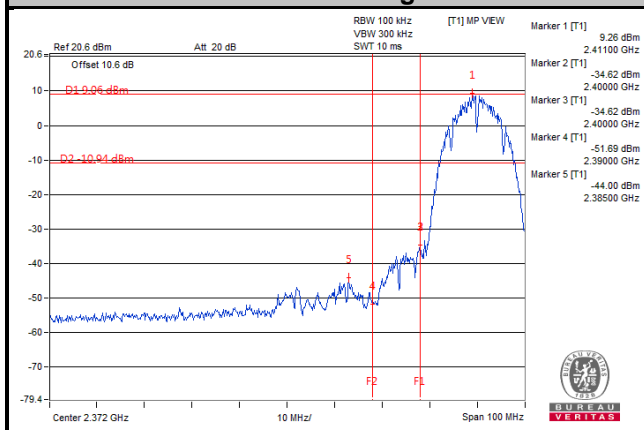

Ch 11 Band Edge



802.11g

Ch 1

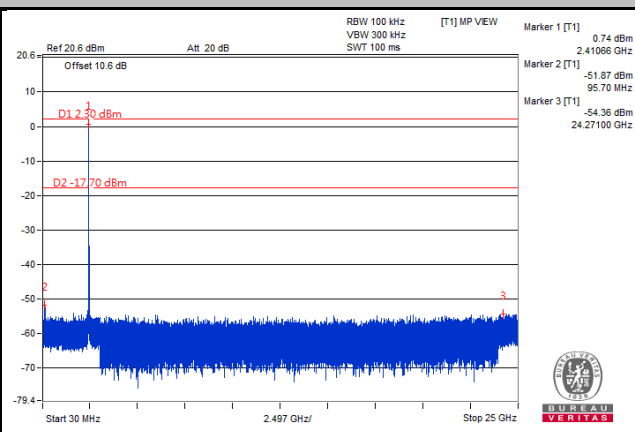
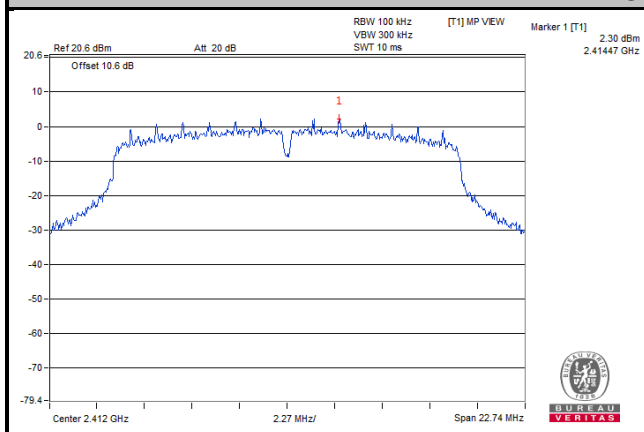

Ch 6

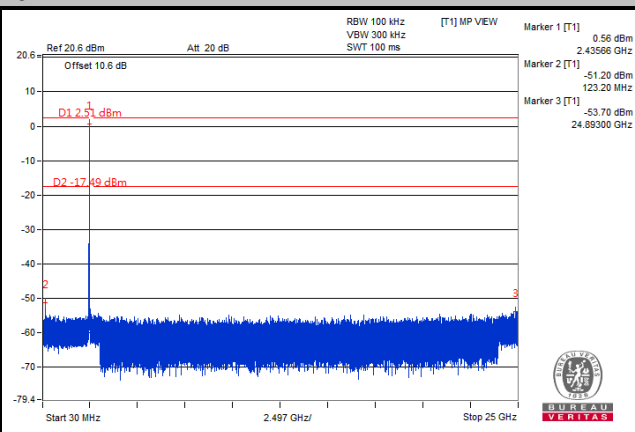
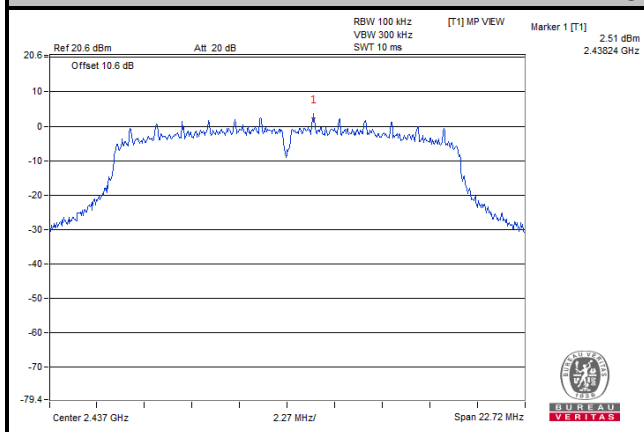

Ch 11

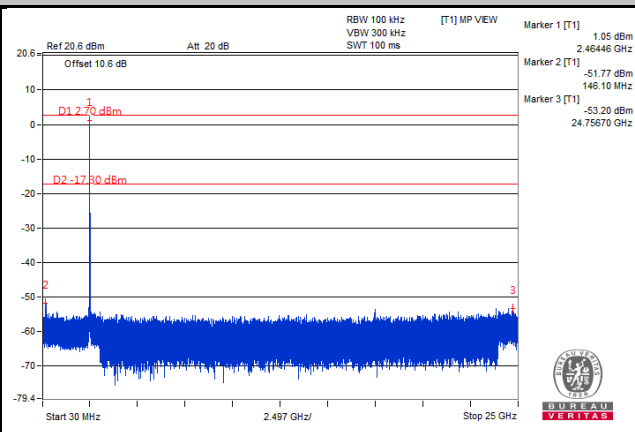
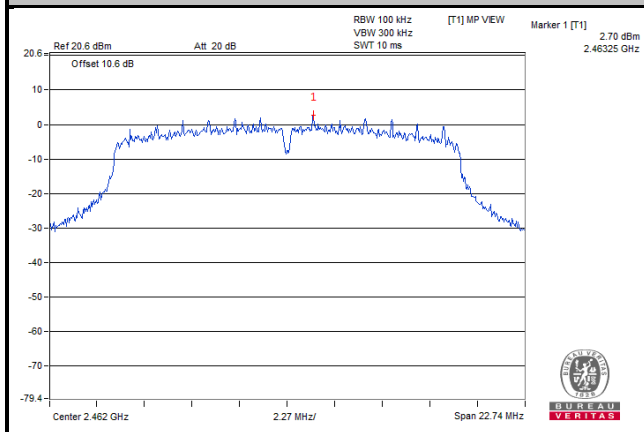

Ch 1 Band Edge

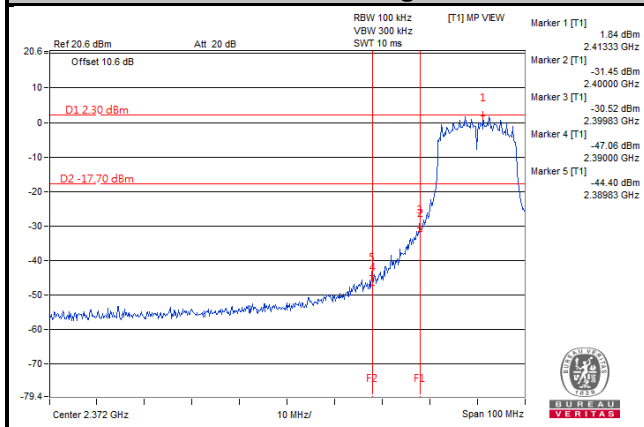

Ch 11 Band Edge

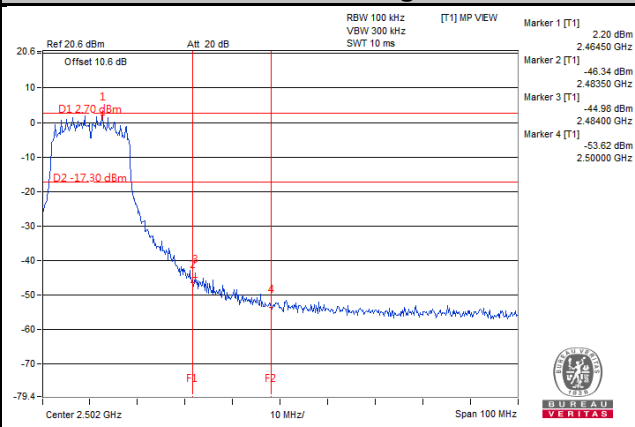

802.11n (HT20)

Ch 1

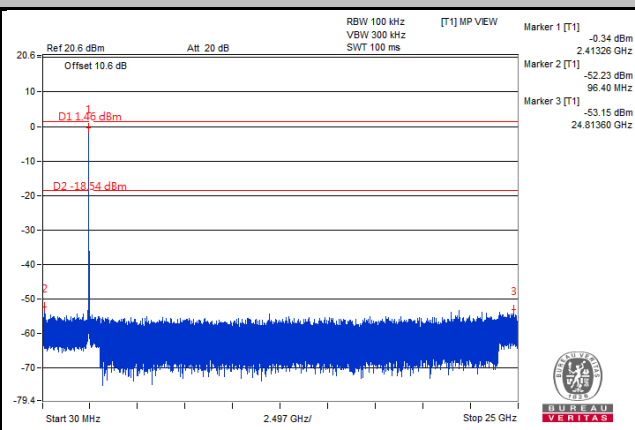
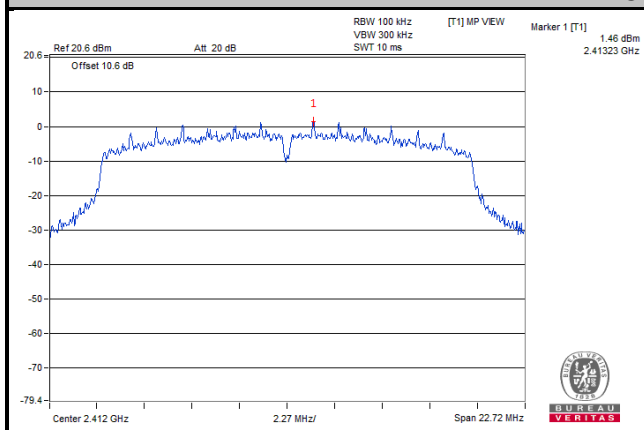

Ch 6

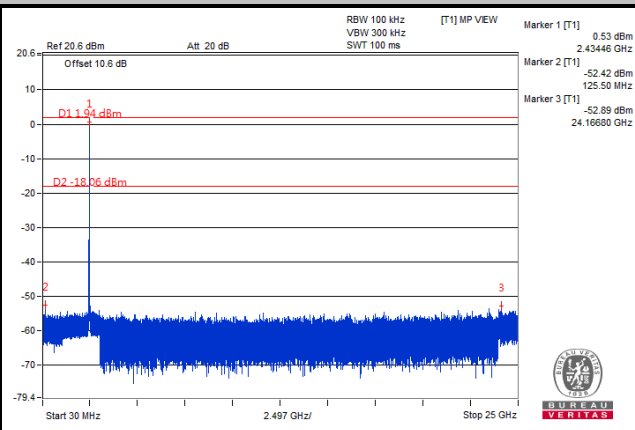
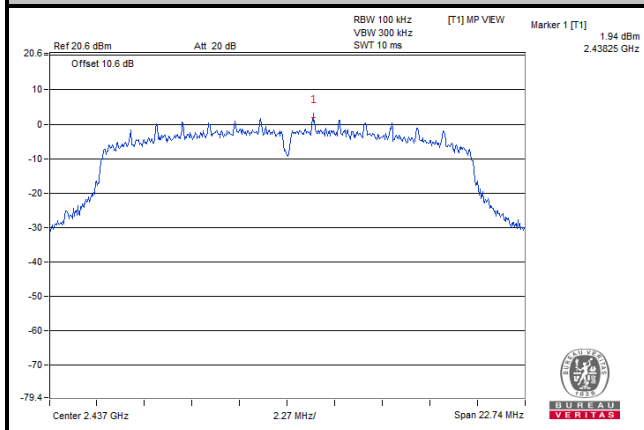

Ch 11

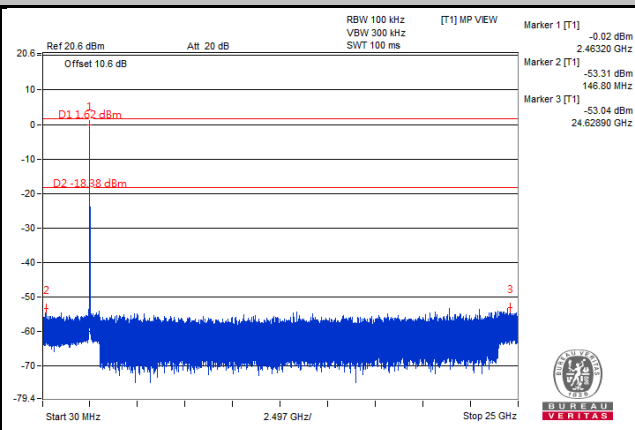
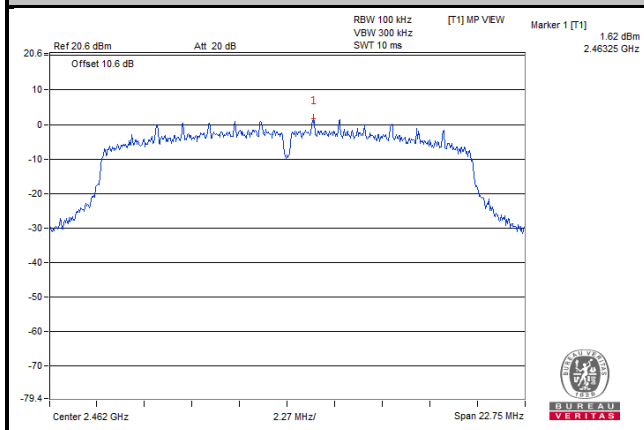

Ch 1 Band Edge

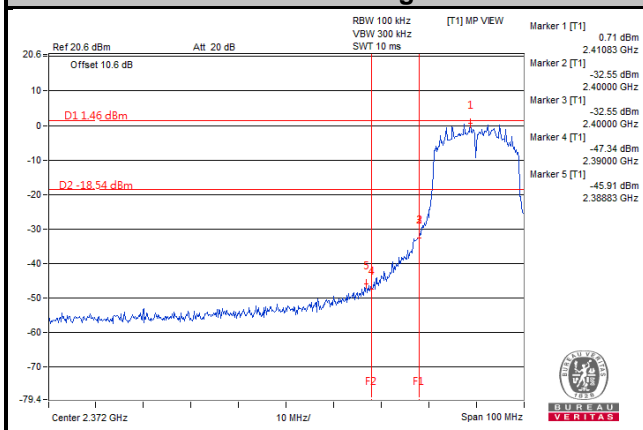

Ch 11 Band Edge

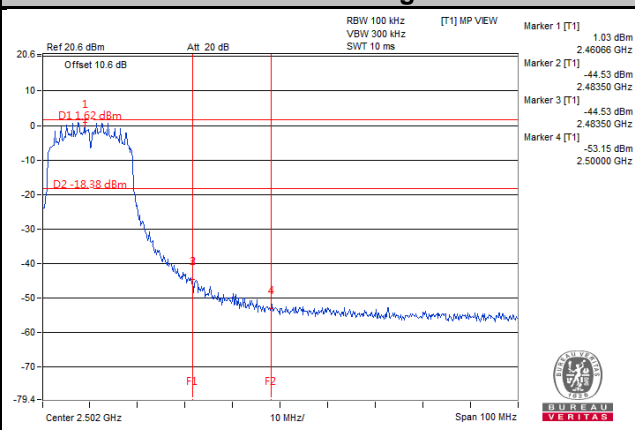

5 Pictures of Test Arrangements

Please refer to the attached file (Test Setup Photo).

Appendix – Information on the Testing Laboratories

We, Bureau Veritas Consumer Products Services (H.K.) Ltd., Taoyuan Branch, were founded in 1988 to provide our best service in EMC, Radio, Telecom and Safety consultation. Our laboratories are FCC recognized accredited test firms and accredited according to ISO/IEC 17025.

If you have any comments, please feel free to contact us at the following:

Linko EMC/RF Lab

Tel: 886-2-26052180

Fax: 886-2-26051924

Hsin Chu EMC/RF/Telecom Lab

Tel: 886-3-6668565

Fax: 886-3-6668323

Hwa Ya EMC/RF/Safety Lab

Tel: 886-3-3183232

Fax: 886-3-3270892

Email: service.adt@tw.bureauveritas.com

Web Site: www.bureauveritas-adt.com

The address and road map of all our labs can be found in our web site also.

--- END ---