

# FCC Test Report

## (PART 22)

**Report No.:** RF170804C11-3

**FCC ID:** B32E2853G

**Test Model:** e285 3G/BT/WiFi

**Received Date:** Aug. 04, 2017

**Test Date:** Aug. 04, 2017 ~ Aug. 28, 2017

**Issued Date:** Sep. 04, 2017

**Applicant:** Verifone, Inc.

**Address:** 1400 West Stanford Ranch Road Suite 200 Rocklin CA 95765 USA

**Issued By:** Bureau Veritas Consumer Products Services (H.K.) Ltd., Taoyuan Branch

**Lab Address:** No. 47-2, 14th Ling, Chia Pau Vil., Lin Kou Dist., New Taipei City, Taiwan  
( R.O.C )

**Test Location (1):** No. 19, Hwa Ya 2nd Rd, Wen Hwa Tsuen, Kwei Shan Hsiang, Taoyuan  
Hsien 333, Taiwan, R.O.C.

**Test Location (2):** No.215, Sec. 3, Beixin Rd., Xindian Dist., New Taipei City 231, Taiwan,  
R.O.C



This report is for your exclusive use. Any copying or replication of this report to or for any other person or entity, or use of our name or trademark, is permitted only with our prior written permission. This report sets forth our findings solely with respect to the test samples identified herein. The results set forth in this report are not indicative or representative of the quality or characteristics of the lot from which a test sample was taken or any similar or identical product unless specifically and expressly noted. Our report includes all of the tests requested by you and the results thereof based upon the information that you provided to us. You have 60 days from date of issuance of this report to notify us of any material error or omission caused by our negligence, provided, however, that such notice shall be in writing and shall specifically address the issue you wish to raise. A failure to raise such issue within the prescribed time shall constitute your unqualified acceptance of the completeness of this report, the tests conducted and the correctness of the report contents. Unless specific mention, the uncertainty of measurement has been explicitly taken into account to declare the compliance or non-compliance to the specification. The report must not be used by the client to claim product certification, approval, or endorsement by TAF or any government agencies

## Table of Contents

<b>Release Control Record</b> .....	<b>3</b>
<b>1 Certificate of Conformity</b> .....	<b>4</b>
<b>2 Summary of Test Results</b> .....	<b>5</b>
2.1 Measurement Uncertainty .....	5
2.2 Test Site and Instruments .....	6
<b>3 General Information</b> .....	<b>7</b>
3.1 General Description of EUT .....	7
3.2 Configuration of System under Test .....	8
3.2.1 Description of Support Units .....	8
3.3 Test Mode Applicability and Tested Channel Detail .....	9
3.4 EUT Operating Conditions .....	10
3.5 General Description of Applied Standards .....	10
<b>4 Test Types and Results</b> .....	<b>11</b>
4.1 Output Power Measurement .....	11
4.1.1 Limits of Output Power Measurement .....	11
4.1.2 Test Procedures .....	11
4.1.3 Test Setup .....	12
4.1.4 Test Results .....	13
4.2 Frequency Stability Measurement .....	15
4.2.1 Limits of Frequency Stability Measurement .....	15
4.2.2 Test Procedure .....	15
4.2.3 Test Setup .....	15
4.2.4 Test Results .....	16
4.3 Occupied Bandwidth Measurement .....	19
4.3.1 Test Procedure .....	19
4.3.2 Test Setup .....	19
4.3.3 Test Result .....	20
4.4 Band Edge Measurement .....	21
4.4.1 Limits of Band Edge Measurement .....	21
4.4.2 Test Setup .....	21
4.4.3 Test Procedures .....	21
4.4.4 Test Results .....	22
4.5 Peak to Average Ratio .....	23
4.5.1 Limits of Peak to Average Ratio Measurement .....	23
4.5.2 Test Setup .....	23
4.5.3 Test Procedures .....	23
4.5.4 Test Results .....	24
4.6 Conducted Spurious Emissions .....	25
4.6.1 Limits of Conducted Spurious Emissions Measurement .....	25
4.6.2 Test Setup .....	25
4.6.3 Test Procedure .....	25
4.6.4 Test Results .....	26
4.7 Radiated Emission Measurement .....	29
4.7.1 Limits of Radiated Emission Measurement .....	29
4.7.2 Test Procedure .....	29
4.7.3 Deviation from Test Standard .....	29
4.7.4 Test Setup .....	29
4.7.5 Test Results .....	30
<b>5 Pictures of Test Arrangements</b> .....	<b>49</b>
<b>Appendix – Information on the Testing Laboratories</b> .....	<b>50</b>

### Release Control Record

Issue No.	Description	Date Issued
RF170804C11-3	Original Release	Sep. 04, 2017

## 1 Certificate of Conformity

**Product:** Point of Sale Terminal  
**Brand:** Verifone  
**Test Model:** e285 3G/BT/WiFi  
**Sample Status:** Identical Prototype  
**Applicant:** Verifone, Inc.  
**Test Date:** Aug. 04, 2017 ~ Aug. 28, 2017  
**Standards:** FCC Part 22, Subpart H

The above equipment has been tested by **Bureau Veritas Consumer Products Services (H.K.) Ltd., Taoyuan Branch**, and found compliance with the requirement of the above standards. The test record, data evaluation & Equipment Under Test (EUT) configurations represented herein are true and accurate accounts of the measurements of the sample's EMC characteristics under the conditions specified in this report.

**Prepared by :** Evonne Liu , **Date:** Sep. 04, 2017  
Evonne Liu / Specialist

**Approved by :** David Huang , **Date:** Sep. 04, 2017  
David Huang / Project Engineer

## 2 Summary of Test Results

Applied Standard: FCC Part 22 & Part 2			
FCC Clause	Test Item	Result	Remarks
2.1046 22.913 (a)	Effective Radiated Power	Pass	Meet the requirement of limit.
---	Peak to Average Ratio	Pass	Meet the requirement of limit.
2.1055 22.355	Frequency Stability	Pass	Meet the requirement of limit.
2.1049	Occupied Bandwidth	Pass	Meet the requirement of limit.
22.917	Band Edge Measurements	Pass	Meet the requirement of limit.
2.1051 22.917	Conducted Spurious Emissions	Pass	Meet the requirement of limit.
2.1053 22.917	Radiated Spurious Emissions	Pass	Meet the requirement of limit. Minimum passing margin is -21.38 dB at 2472.60 MHz.

### 2.1 Measurement Uncertainty

Where relevant, the following measurement uncertainty levels have been estimated for tests performed on the EUT as specified in CISPR 16-4-2:

Measurement	Frequency	Expanded Uncertainty (k=2) (±)
Conducted Emissions at mains ports	150 kHz ~ 30 MHz	2.44 dB
Radiated Emissions up to 1 GHz	30 MHz ~ 200 MHz	2.0153 dB
	200 MHz ~ 1000 MHz	2.0224 dB
Radiated Emissions above 1 GHz	1 GHz ~ 18 GHz	1.0121 dB
	18 GHz ~ 40 GHz	1.1508 dB

## 2.2 Test Site and Instruments

Description & Manufacturer	Model No.	Serial No.	Date of Calibration	Due Date of Calibration
Test Receiver Agilent Technologies	N9038A	MY52260177	Jul. 05, 2017	Jul. 04, 2018
Spectrum Analyzer ROHDE & SCHWARZ	FSU43	101261	Dec. 13, 2016	Dec. 12, 2017
BILOG Antenna SCHWARZBECK	VULB9168	9168-472	Dec. 16, 2016	Dec. 15, 2017
HORN Antenna ETS-Lindgren	3117	00143293	Dec. 29, 2016	Dec. 28, 2017
Double Ridge Guide Horn Antenna EMCO	3115	5619	Dec. 27, 2016	Dec. 26, 2017
BILOG Antenna SCHWARZBECK	VULB 9168	9168-153	Dec. 13, 2016	Dec. 12, 2017
Communications Tester-Wireless Agilent	8960 Series 10	MY53201073	Jun. 28, 2017	Jun. 27, 2019
Preamplifier Agilent	310N	187226	Jun. 23, 2017	Jun. 22, 2018
Preamplifier Agilent	83017A	MY39501357	Jun. 23, 2017	Jun. 22, 2018
Power Meter Anritsu	ML2495A	1232002	Sep. 08, 2016	Sep. 07, 2017
Power Sensor Anritsu	MA2411B	1207325	Sep. 08, 2016	Sep. 07, 2017
RF signal cable ETS-LINDGREN	5D-FB	Cable-CH1-01(R FC-SMS-100-SM S-120+RFC-SMS -100-SMS-400)	Jun. 23, 2017	Jun. 22, 2018
RF signal cable ETS-LINDGREN	8D-FB	Cable-CH1-02(R FC-SMS-100-SM S-24)	Jun. 23, 2017	Jun. 22, 2018
Software BV ADT	E3 8.130425b	NA	NA	NA
Antenna Tower MF	NA	NA	NA	NA
Turn Table MF	NA	NA	NA	NA
Antenna Tower & Turn Table Controller MF	MF-7802	NA	NA	NA
Radio Communication Analyzer Anritsu	MT8820C	6201300640	Aug. 16, 2017	Aug. 15, 2019

Note: 1. The calibration interval of the above test instruments is 12 / 24 months and the calibrations are traceable to NML/ROC and NIST/USA.

2. The test was performed in HsinTien Chamber 1.

3. The horn antenna and preamplifier (model: 83017A) are used only for the measurement of emission frequency above 1 GHz if tested.

4. The IC Site Registration No. is IC7450I-1.

### 3 General Information

#### 3.1 General Description of EUT

<b>Product</b>	Point of Sale Terminal	
<b>Brand</b>	Verifone	
<b>Test Model</b>	e285 3G/BT/WiFi	
<b>Status of EUT</b>	Identical Prototype	
<b>Power Supply Rating</b>	5.0 Vdc (adapter or host equipment) 3.8 Vdc (Li-ion battery)	
<b>Modulation Type</b>	GSM/GPRS	GMSK
	EDGE	GMSK, 8PSK
	WCDMA	QPSK
<b>Frequency Range</b>	GSM/GPRS/EDGE	824.2 ~ 848.8 MHz
	WCDMA	826.4 ~ 846.6 MHz
<b>Max. ERP Power</b>	GSM/GPRS	1140.25 mW
	EDGE	289.73 mW
	WCDMA	142.63 mW
<b>Emission Designator</b>	GSM/GPRS	246KGXW
	EDGE	246KG7W
	WCDMA	4M07F9W
<b>Antenna Type</b>	Fixed Internal Antenna	
<b>Accessory Device</b>	Refer to Note as below	
<b>Data Cable Supplied</b>	Refer to Note as below	

Note:

1. The EUT contains following accessory devices.

Product	Brand	Model	Description
Adapter	Verifone	PSAA05A-050QL6V	I/P: 100-240 Vac, 50/60 Hz, 0.2 A O/P: 5 Vdc, 1.0 A Manufacturer: Phihong
Battery	Verifone	BPK087-600	3.8 Vdc, 1800mAh
BT/WLAN Module	Murata	SP-5HY1NL-B	--
USB Cable	Verifone	CBL087-500-01	1m shielded cable w/o core
WWAN Module	Gemalto	EHS6	--

2. The above EUT information is declared by manufacturer and for more detailed features description, please refer to the manufacturer's specifications or user's manual.

### 3.2 Configuration of System under Test

#### <Radiated Emission Test>

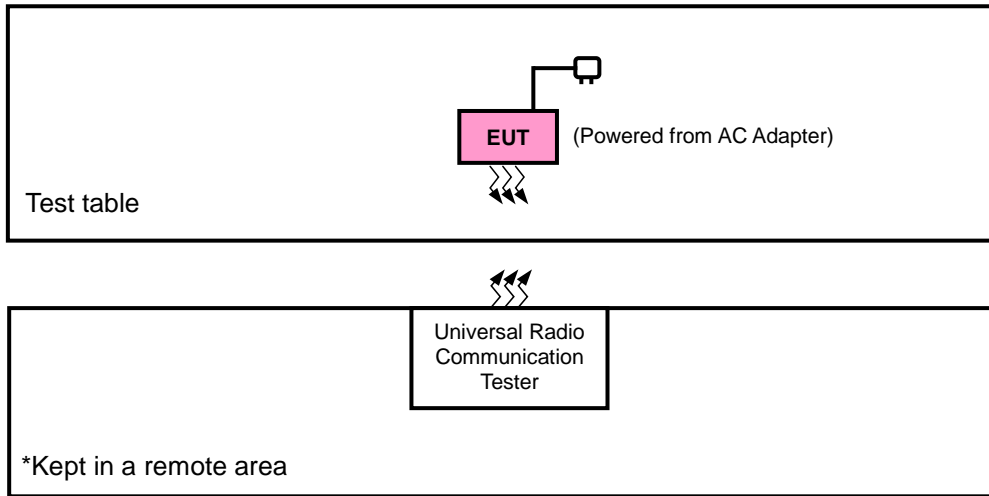

#### <E.R.P. Test>

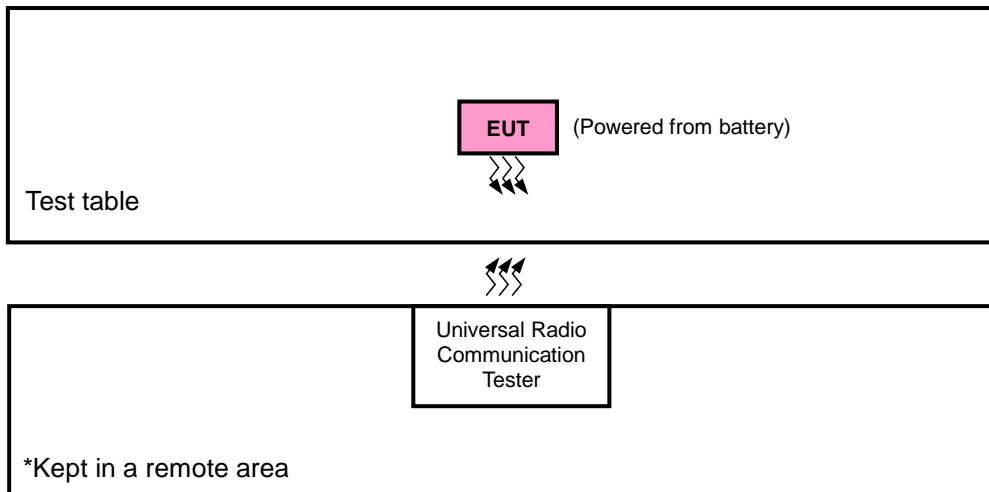

#### 3.2.1 Description of Support Units

The EUT has been tested as an independent unit together with other necessary accessories or support units.



### 3.3 Test Mode Applicability and Tested Channel Detail

Pre-Scan has been conducted to determine the worst-case mode from all possible combinations between available modulations, data rates, XYZ axis, and antenna ports.

The worst case was found when positioned as the table below. Following channel(s) was (were) selected for the final test as listed below:

Band	ERP	Radiated Emission
GSM	Y-plane	X-axis
EDGE	Y-plane	X-axis
WCDMA	Y-plane	X-axis

#### GSM

EUT Configure Mode	Test Item	Available Channel	Tested Channel	Mode
-	ERP	128 to 251	128, 189, 251	GSM, EDGE
-	Frequency Stability	128 to 251	128, 251	GSM, EDGE
-	Occupied Bandwidth	128 to 251	128, 189, 251	GSM, EDGE
-	Band Edge	128 to 251	128, 251	GSM, EDGE
-	Peak to Average Ratio	128 to 251	128, 189, 251	GSM, EDGE
-	Conducuted Emission	128 to 251	128, 189, 251	GSM, EDGE
-	Radiated Emission	128 to 251	128, 189, 251	GSM, EDGE

#### WCDMA

EUT Configure Mode	Test Item	Available Channel	Tested Channel	Mode
-	ERP	4132 to 4233	4132, 4182, 4233	WCDMA
-	Frequency Stability	4132 to 4233	4132, 4233	WCDMA
-	Occupied Bandwidth	4132 to 4233	4132, 4182, 4233	WCDMA
-	Band Edge	4132 to 4233	4132, 4233	WCDMA
-	Peak to Average Ratio	4132 to 4233	4132, 4182, 4233	WCDMA
-	Conducuted Emission	4132 to 4233	4132, 4182, 4233	WCDMA
-	Radiated Emission	4132 to 4233	4132, 4182, 4233	WCDMA

**Test Condition:**

Test Item	Environmental Conditions	Input Power	Tested By
ERP	25 deg. C, 65 % RH	3.8 Vdc	Carlos Chen
Frequency Stability	25 deg. C, 65 % RH	3.8 Vdc	Carlos Chen
Occupied Bandwidth	25 deg. C, 65 % RH	3.8 Vdc	Carlos Chen
Band Edge	25 deg. C, 65 % RH	3.8 Vdc	Carlos Chen
Peak to Average Ratio	25 deg. C, 65 % RH	3.8 Vdc	Carlos Chen
Condcudeted Emission	25 deg. C, 65 % RH	3.8 Vdc	Carlos Chen
Radiated Emission	25 deg. C, 65 % RH	120 Vac, 60 Hz	Karl Lee

**3.4 EUT Operating Conditions**

The EUT makes a call to the communication simulator. The communication simulator station system controlled a EUT to export maximum output power under transmission mode and specific channel frequency.

**3.5 General Description of Applied Standards**

The EUT is a RF Product. According to the specifications of the manufacturer, it must comply with the requirements of the following standards:

**FCC 47 CFR Part 2**

**FCC 47 CFR Part 22**

**KDB 971168 D01 Power Meas License Digital Systems v02r02**

**ANSI/TIA/EIA-603-D 2010**

**Note:** All test items have been performed and recorded as per the above standards.

## 4 Test Types and Results

### 4.1 Output Power Measurement

#### 4.1.1 Limits of Output Power Measurement

Mobile / Portable station are limited to 7 watts e.r.p.

#### 4.1.2 Test Procedures

##### **EIRP / ERP Measurement:**

- a. All measurements were done at low, middle and high operational frequency range. RBW and VBW is 1 MHz for GSM, GPRS & EDGE, and 5 MHz for WCDMA and CDMA, and 10 MHz for LTE mode.
- b. Substitution method is used for E.I.R.P measurement. In the semi-anechoic chamber, EUT placed on the 0.8 m height of Turn Table, rotated the table around 360 degrees to search the maximum radiation power and receiver antenna shall be rotated vertical and horizontal polarization and moved height from 1 m to 4 m to find the maximum polar radiated power. The "Read Value" is the spectrum reading the maximum power value.
- c. The substitution horn antenna is substituted for EUT at the same position and signals generator export the CW signal to the substitution antenna via a tx cable. Rotated the Turn Table and moved receiving antenna to find the maximum radiation power. Adjust output power level of S.G to get a Value of spectrum reading equal to "Read Value" of step b. Record the power level of S.G.
- d.  $EIRP = \text{Output power level of S.G} - \text{TX cable loss} + \text{Antenna gain of substitution horn}$ . E.R.P power can be calculated form E.I.R.P power by subtracting the gain of dipole,  $E.R.P \text{ power} = E.I.P.R \text{ power} - 2.15 \text{ dBi}$ .

##### **Conducted Power Measurement:**

The EUT was set up for the maximum power with GSM, GPRS, EDGE, WCDMA, CDMA, and LTE link data modulation and link up with simulator. Set the EUT to transmit under low, middle and high channel and record the power level shown on simulator.

### 4.1.3 Test Setup

#### EIRP / ERP Measurement:

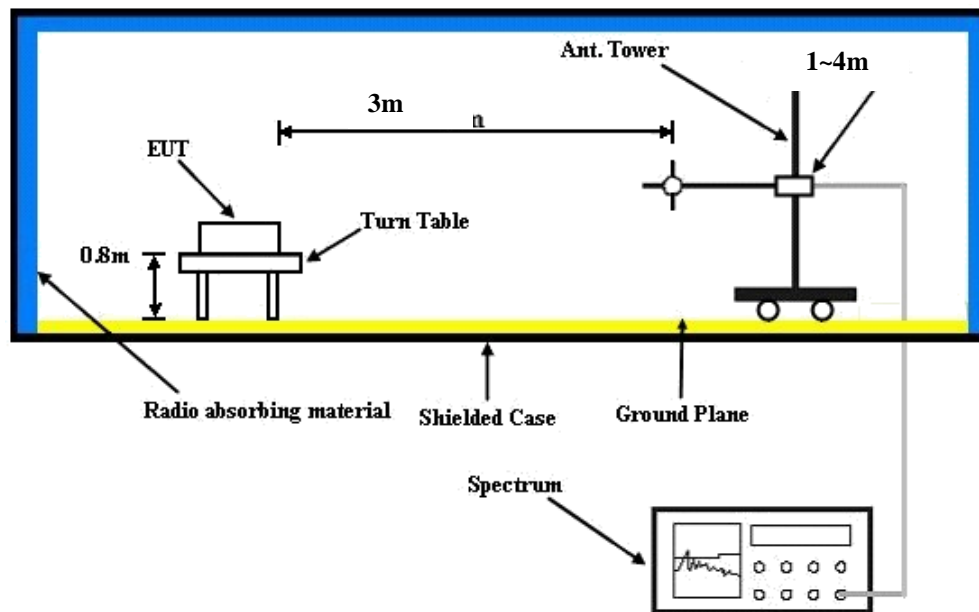

For the actual test configuration, please refer to the attached file (Test Setup Photo).

#### Conducted Power Measurement:

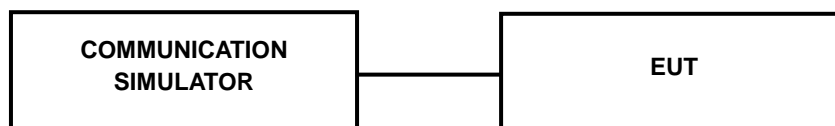

#### 4.1.4 Test Results

##### Conducted Output Power (dBm)

Band	GSM850		
Channel	128	189	251
Frequency (MHz)	824.2	836.4	848.8
GSM (GMSK, 1Tx-slot)	32.87	32.82	32.78
GPRS (GMSK, 1Tx-slot)	32.42	32.38	32.25
GPRS (GMSK, 2Tx-slot)	29.77	29.72	29.60
GPRS (GMSK, 3Tx-slot)	27.98	27.90	27.78
GPRS (GMSK, 4Tx-slot)	26.89	26.77	26.66
EDGE (8PSK, 1Tx-slot)	26.72	26.69	26.59
EDGE (8PSK, 2Tx-slot)	23.86	23.76	23.68
EDGE (8PSK, 3Tx-slot)	22.00	21.91	21.82
EDGE (8PSK, 4Tx-slot)	20.86	20.73	20.66

Band	WCDMA V		
Channel	4132	4182	4233
Frequency (MHz)	826.4	836.4	846.6
RMC 12.2K	23.98	23.88	23.84
HSDPA Subtest-1	23.93	23.87	23.80
HSDPA Subtest-2	23.91	23.78	23.72
HSDPA Subtest-3	22.92	22.85	22.73
HSDPA Subtest-4	22.76	22.59	22.54
HSUPA Subtest-1	23.19	23.10	23.09
HSUPA Subtest-2	21.27	21.15	21.12
HSUPA Subtest-3	22.04	21.94	21.87
HSUPA Subtest-4	21.53	21.43	21.39
HSUPA Subtest-5	23.37	23.30	23.24

**ERP Power (dBm)**

GSM							
Plane	Channel	Frequency (MHz)	LVL (dBm)	Correction Factor (dB)	ERP (dBm)	ERP (mW)	Polarization (H/V)
Y	128	824.2	1.47	31.208	30.53	1129.28	H
	189	836.4	1.42	31.3	30.57	1140.25	
	251	848.8	1.43	31.222	30.50	1122.54	
	128	824.2	-2.84	31.504	26.51	448.13	V
	189	836.4	-2.49	31.117	26.48	444.32	
	251	848.8	-3.23	31.922	26.54	451.02	

EDGE							
Plane	Channel	Frequency (MHz)	LVL (dBm)	Correction Factor (dB)	ERP (dBm)	ERP (mW)	Polarization (H/V)
Y	128	824.2	-4.52	31.208	24.54	284.32	H
	189	836.4	-4.53	31.3	24.62	289.73	
	251	848.8	-4.52	31.222	24.55	285.23	
	128	824.2	-8.86	31.504	20.49	112.05	V
	189	836.4	-8.46	31.117	20.51	112.38	
	251	848.8	-9.21	31.922	20.56	113.82	

WCDMA							
Plane	Channel	Frequency (MHz)	LVL (dBm)	Correction Factor (dB)	ERP (dBm)	ERP (mW)	Polarization (H/V)
Y	4132	826.4	-7.56	31.208	21.50	141.19	H
	4182	836.4	-7.62	31.3	21.53	142.23	
	4233	846.6	-7.53	31.222	21.54	142.63	
	4132	826.4	-11.84	31.504	17.51	56.42	V
	4182	836.4	-11.52	31.117	17.45	55.55	
	4233	846.6	-12.27	31.922	17.50	56.26	

## 4.2 Frequency Stability Measurement

### 4.2.1 Limits of Frequency Stability Measurement

1.5 ppm is for base and fixed station. 2.5 ppm is for mobile station.

### 4.2.2 Test Procedure

- Device is placed at the oven room. The oven room could control the temperatures and humidity. Power warm up is at least 15 min and power applied should perform before recording frequency error.
- EUT is connected the external power supply to control the DC input power. The test voltage range is from minimum to maximum working voltage. Each step shall be record the frequency error rate.
- The temperature range step is 10 degrees in this test items. All temperature levels shall be hold the  $\pm 0.5$  °C during the measurement testing. The each temperature step shall be at least 0.5 hours, consider the EUT could be test under the stability condition.

**NOTE:** The frequency error was recorded frequency error from the communication simulator.

### 4.2.3 Test Setup

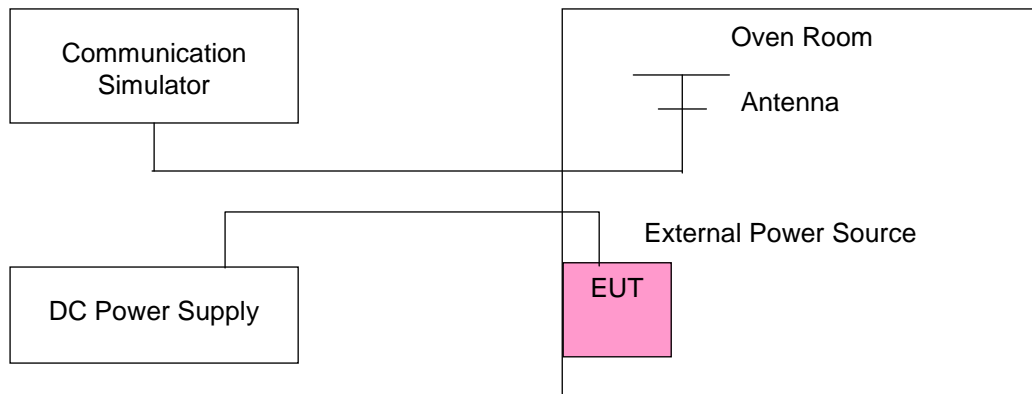

#### 4.2.4 Test Results

##### Frequency Error vs. Voltage

Voltage (Volts)	GSM				Limit (ppm)
	Low Channel		High Channel		
	Frequency (MHz)	Frequency Error (ppm)	Frequency (MHz)	Frequency Error (ppm)	
3.8	824.200001	0.001	1909.800002	0.001	2.5
3.6	824.200002	0.002	1909.800001	0.001	2.5
4.35	824.200001	0.002	1909.800003	0.001	2.5

**Note:** The applicant defined the normal working voltage of the battery is from 3.6 Vdc to 4.35 Vdc.

##### Frequency Error vs. Temperature

Temp. (°C)	GSM				Limit (ppm)
	Low Channel		High Channel		
	Frequency (MHz)	Frequency Error (ppm)	Frequency (MHz)	Frequency Error (ppm)	
-30	824.200004	0.005	1909.800003	0.002	2.5
-20	824.200002	0.002	1909.800003	0.002	2.5
-10	824.200002	0.002	1909.800002	0.001	2.5
0	824.200004	0.005	1909.800002	0.001	2.5
10	824.199997	-0.004	1909.799999	-0.001	2.5
20	824.199997	-0.004	1909.799997	-0.002	2.5
30	824.199998	-0.002	1909.799996	-0.002	2.5
40	824.199998	-0.003	1909.799998	-0.001	2.5
50	824.199999	-0.001	1909.799997	-0.001	2.5



Frequency Error vs. Voltage

Voltage (Volts)	EDGE				Limit (ppm)
	Low Channel		High Channel		
	Frequency (MHz)	Frequency Error (ppm)	Frequency (MHz)	Frequency Error (ppm)	
3.8	824.200002	0.003	1909.800003	0.002	2.5
3.6	824.200003	0.004	1909.800001	0.001	2.5
4.35	824.200003	0.004	1909.800003	0.002	2.5

**Note:** The applicant defined the normal working voltage of the battery is from 3.6 Vdc to 4.35 Vdc.

Frequency Error vs. Temperature

Temp. (°C)	EDGE				Limit (ppm)
	Low Channel		High Channel		
	Frequency (MHz)	Frequency Error (ppm)	Frequency (MHz)	Frequency Error (ppm)	
-30	824.200004	0.005	1909.800003	0.001	2.5
-20	824.200001	0.001	1909.800001	0.001	2.5
-10	824.200003	0.004	1909.800003	0.001	2.5
0	824.200002	0.003	1909.800004	0.002	2.5
10	824.199998	-0.002	1909.799999	-0.001	2.5
20	824.199998	-0.002	1909.799998	-0.001	2.5
30	824.199997	-0.004	1909.799996	-0.002	2.5
40	824.199998	-0.003	1909.799997	-0.001	2.5
50	824.199997	-0.003	1909.799997	-0.001	2.5

Frequency Error vs. Voltage

Voltage (Volts)	WCDMA				Limit (ppm)
	Low Channel		High Channel		
	Frequency (MHz)	Frequency Error (ppm)	Frequency (MHz)	Frequency Error (ppm)	
3.8	826.400003	0.003	846.600001	0.002	2.5
3.6	826.400004	0.005	846.600001	0.002	2.5
4.35	826.400003	0.003	846.600003	0.003	2.5

**Note:** The applicant defined the normal working voltage of the battery is from 3.6 Vdc to 4.35 Vdc.

Frequency Error vs. Temperature

Temp. (°C)	WCDMA				Limit (ppm)
	Low Channel		High Channel		
	Frequency (MHz)	Frequency Error (ppm)	Frequency (MHz)	Frequency Error (ppm)	
-30	826.400003	0.004	846.600004	0.004	2.5
-20	826.400001	0.001	846.600003	0.004	2.5
-10	826.400002	0.003	846.600002	0.002	2.5
0	826.400002	0.003	846.600002	0.002	2.5
10	826.399999	-0.002	846.599996	-0.004	2.5
20	826.399997	-0.004	846.599999	-0.001	2.5
30	826.399998	-0.002	846.599997	-0.004	2.5
40	826.399996	-0.004	846.599997	-0.004	2.5
50	826.399997	-0.004	846.599999	-0.002	2.5

### 4.3 Occupied Bandwidth Measurement

#### 4.3.1 Test Procedure

The EUT makes a call to the communication simulator. All measurements were done at low, middle and high operational frequency range. The communication simulator station system controlled a EUT to export maximum output power under transmission mode and specific channel frequency. Use OBW measurement function of Spectrum analyzer to measure 99 % occupied bandwidth.

#### 4.3.2 Test Setup

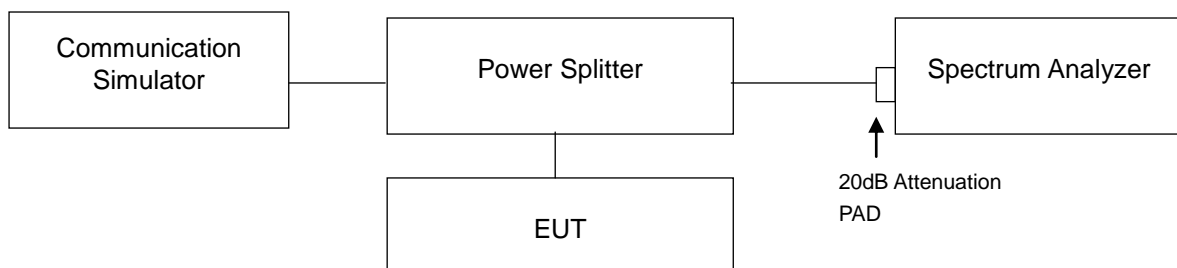

### 4.3.3 Test Result

Channel	Frequency (MHz)	99 % Occupied Bandwidth (kHz)		Channel	Frequency (MHz)	99 % Occupied Bandwidth (MHz)
		GSM	EDGE			WCDMA
128	824.2	246.36	241.72	4132	826.4	4.0696
189	836.4	246.31	245.65	4182	836.4	4.0642
251	848.8	246.02	246.20	4233	846.6	4.0717

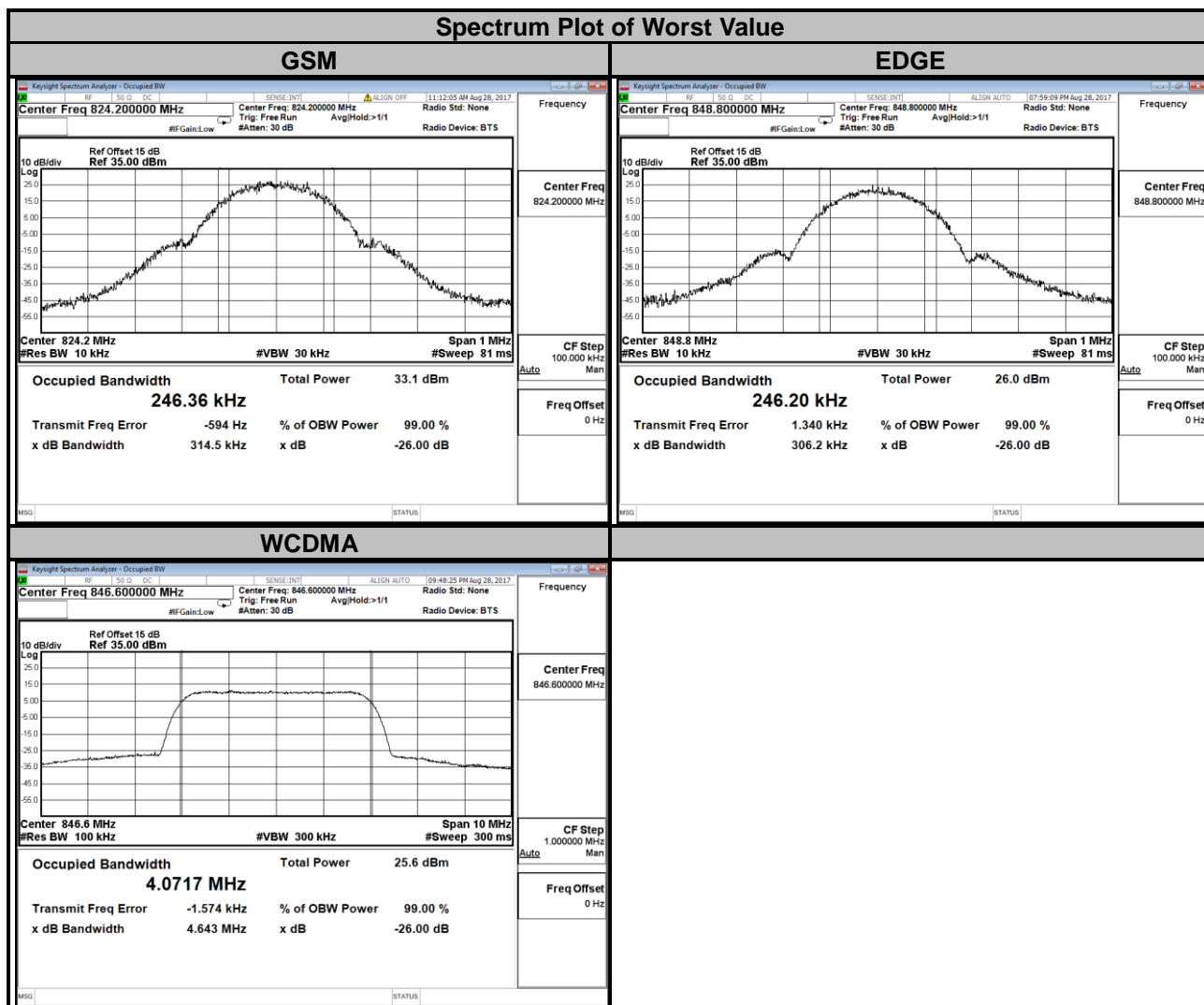

## 4.4 Band Edge Measurement

### 4.4.1 Limits of Band Edge Measurement

Power of any emission outside of the authorized operating frequency ranges must be attenuated below the transmitting power (P) by a factor of at least  $43 + 10 \log(P)$  dB. In the 1 MHz bands immediately outside and adjacent to the frequency block a resolution bandwidth of at least one percent of the emission bandwidth of the fundamental emission of the transmitter may be employed.

### 4.4.2 Test Setup

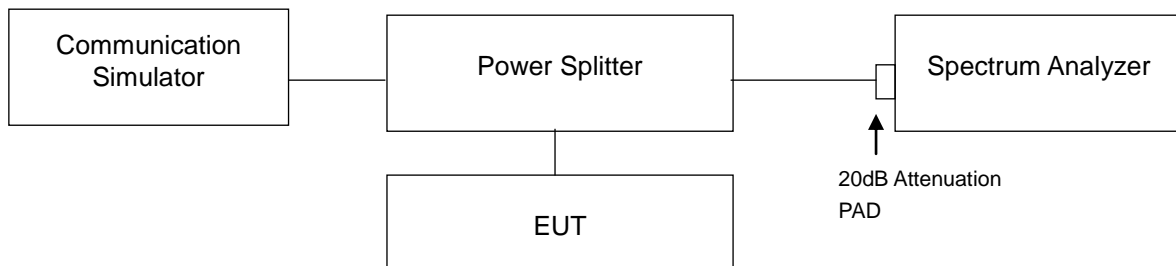

### 4.4.3 Test Procedures

- All measurements were done at low and high operational frequency range.
- The center frequency of spectrum is the band edge frequency and span is 1 MHz. RB of the spectrum is 10 kHz and VB of the spectrum is 30 kHz (GSM/GPRS/EDGE).
- The center frequency of spectrum is the band edge frequency and span is 5 MHz. RB of the spectrum is 100 kHz and VB of the spectrum is 300 kHz (WCDMA).
- Record the max trace plot into the test report.

### 4.4.4 Test Results

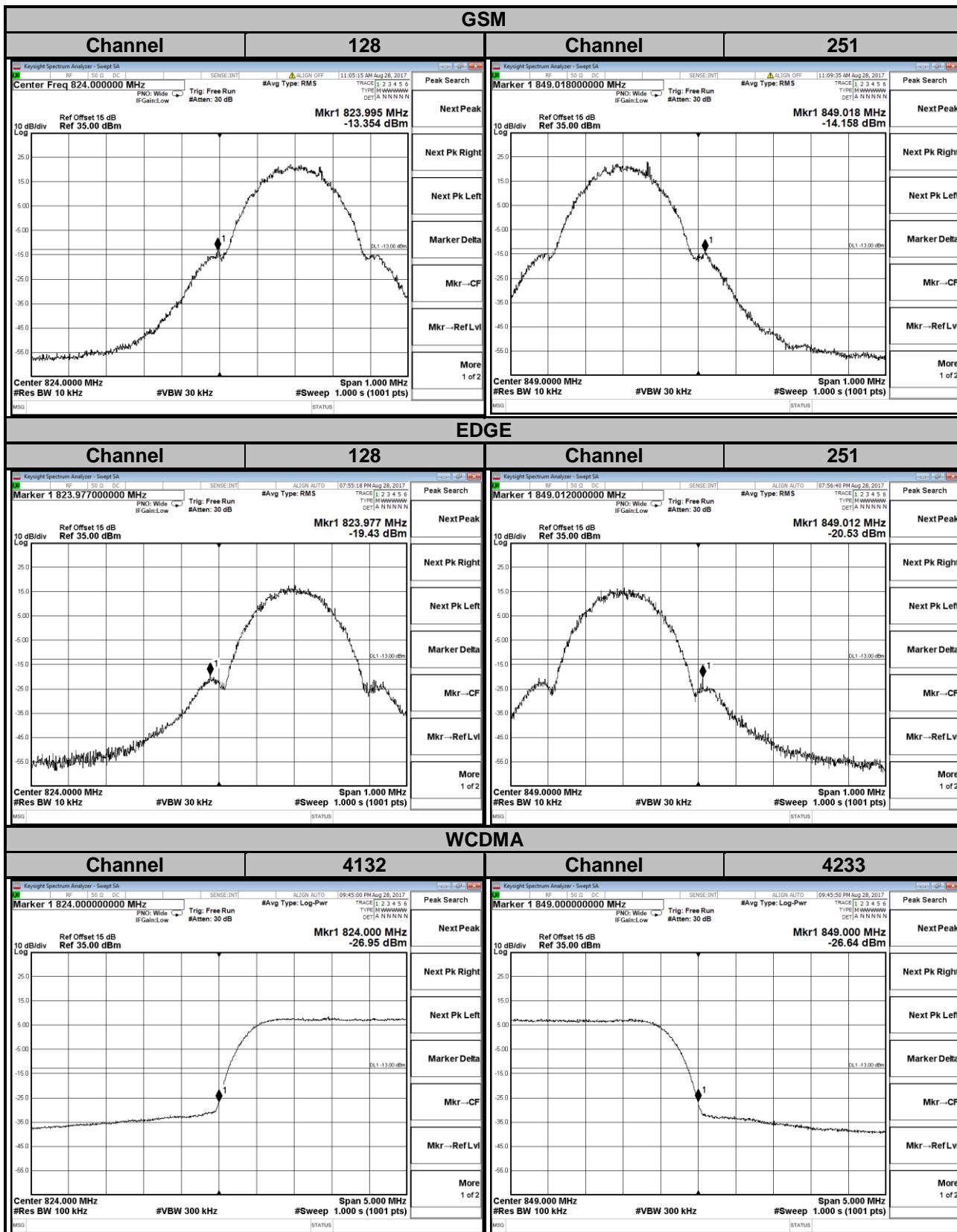

## 4.5 Peak to Average Ratio

### 4.5.1 Limits of Peak to Average Ratio Measurement

In measuring transmissions in this band using an average power technique, the peak to-average ratio (PAR) of the transmission may not exceed 13 dB.

### 4.5.2 Test Setup

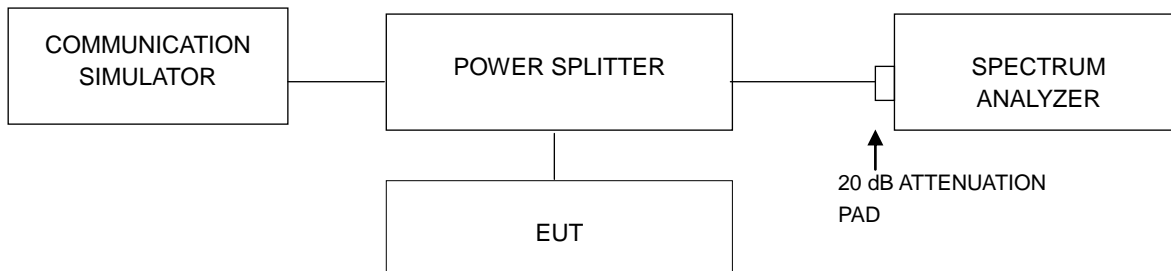

### 4.5.3 Test Procedures

1. Set resolution/measurement bandwidth  $\geq$  signal's occupied bandwidth;
2. Set the number of counts to a value that stabilizes the measured CCDF curve;
3. Record the maximum PAPR level associated with a probability of 0.1 %.

#### 4.5.4 Test Results

Channel	Frequency (MHz)	Peak to Average Ratio (dB)		Channel	Frequency (MHz)	Peak to Average Ratio (dB)
		GSM	EDGE			
128	824.2	0.18	3.14	4132	826.4	3.07
189	836.4	0.17	3.14	4182	836.4	3.19
251	848.8	0.16	3.14	4233	846.6	3.04

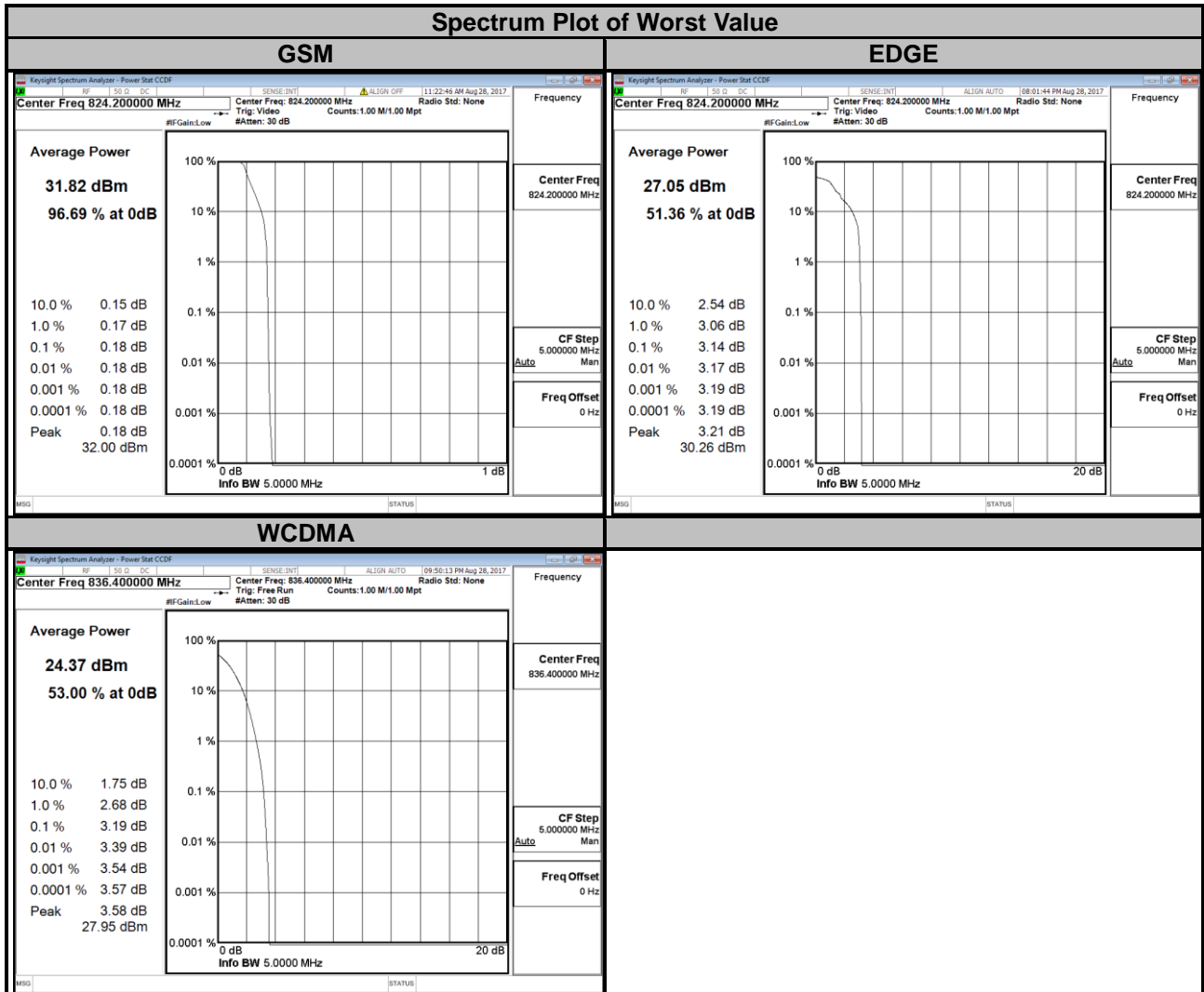



## 4.6 Conducted Spurious Emissions

### 4.6.1 Limits of Conducted Spurious Emissions Measurement

The power of any emission outside of the authorized operating frequency ranges must be attenuated below the transmitting power (P) by a factor of at least  $43 + 10 \log(P)$  dB. The emission limit equal to  $-13$  dBm.

### 4.6.2 Test Setup

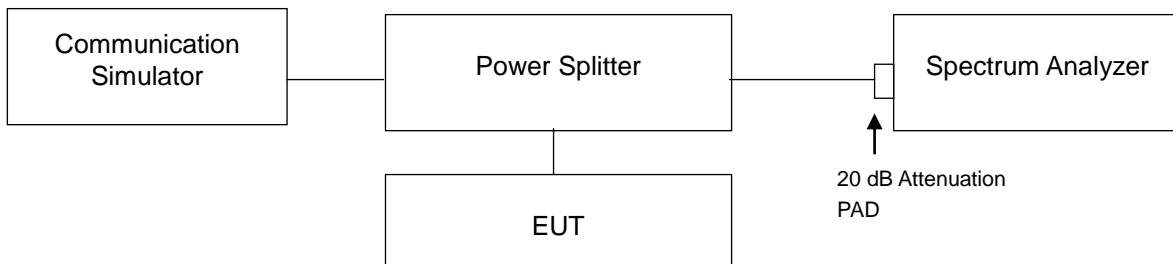

### 4.6.3 Test Procedure

- The EUT makes a phone call to the communication simulator. All measurements were done at low, middle and high operational frequency range.
- Measuring frequency range is from 9 kHz to 9 GHz. 20 dB attenuation pad is connected with spectrum. RBW=1 MHz and VBW=3 MHz is used for conducted emission measurement.

### 4.6.4 Test Results

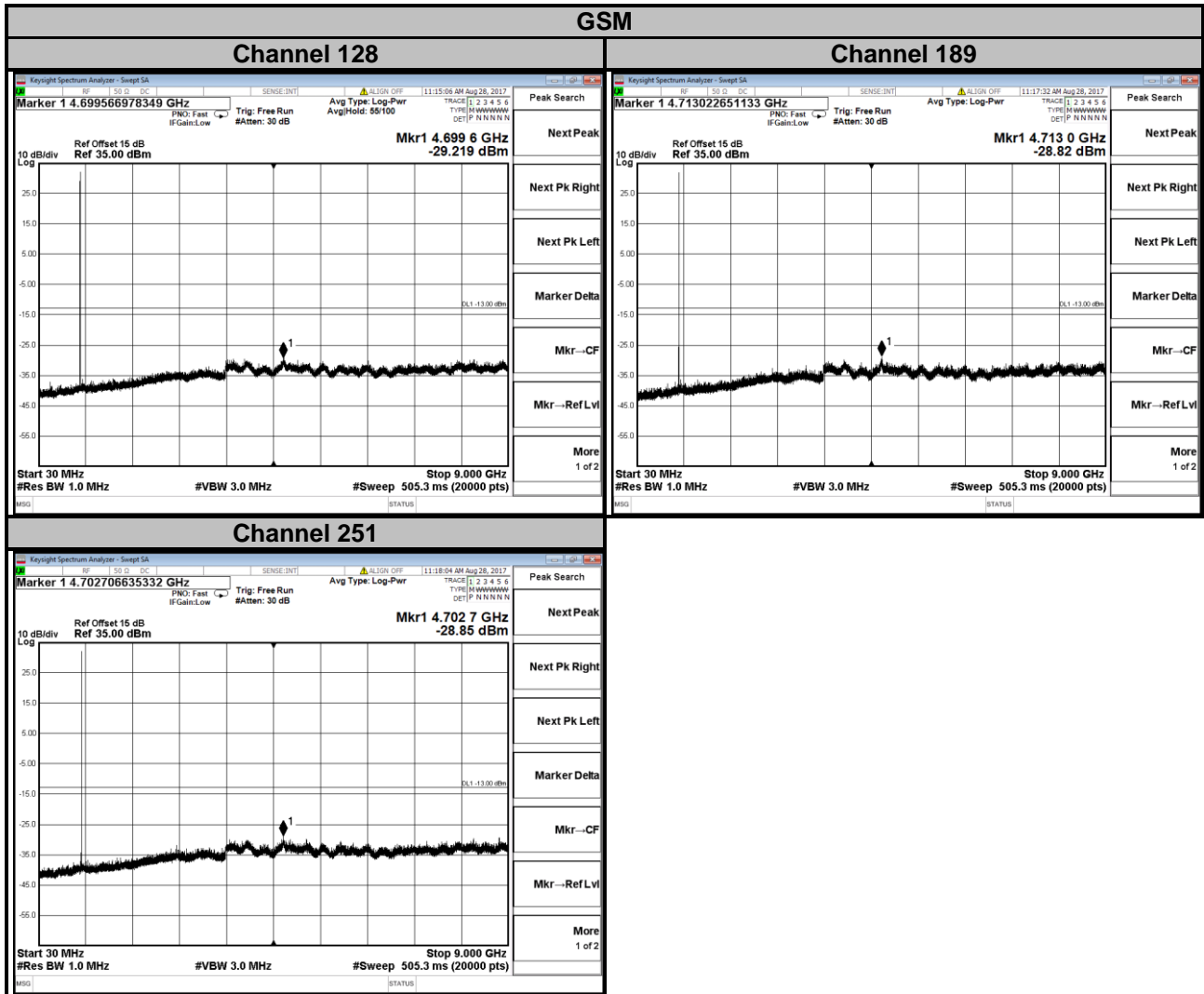

EDGE

Channel 128

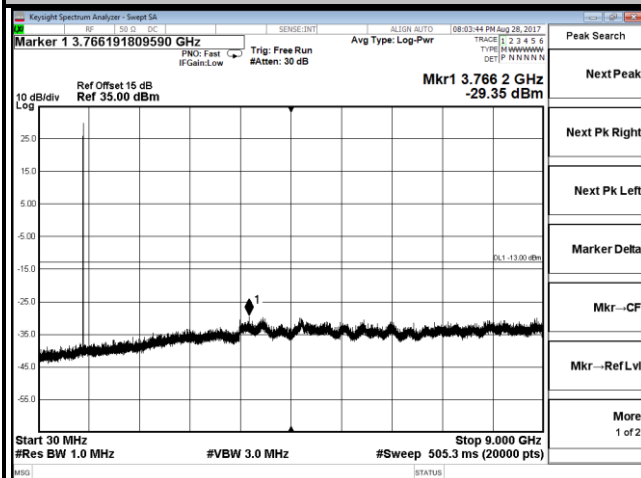

Channel 189

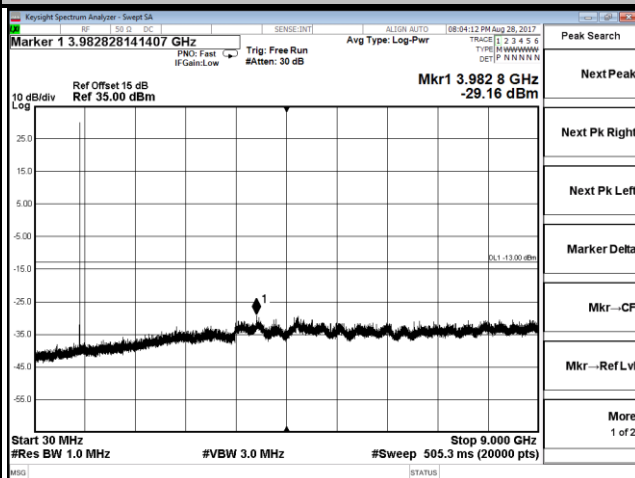

Channel 251

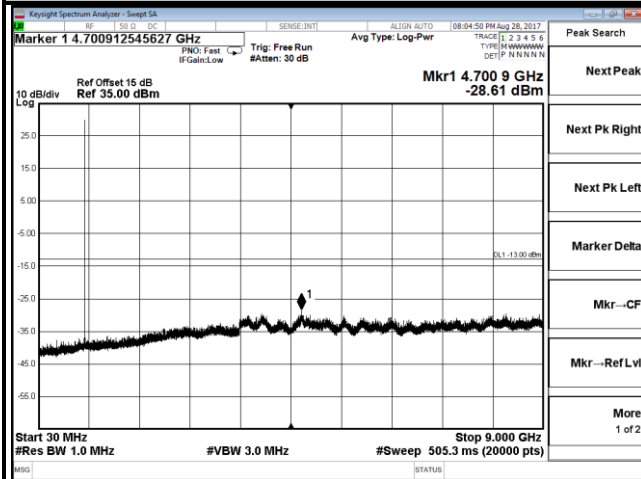

### WCDMA

#### Channel 4132

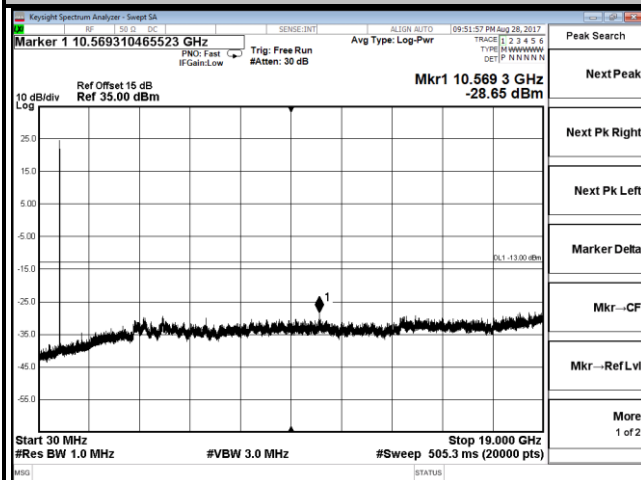

#### Channel 4182

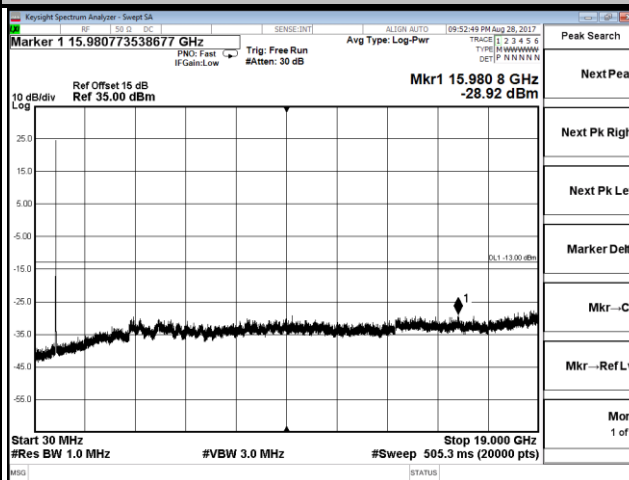

#### Channel 4233

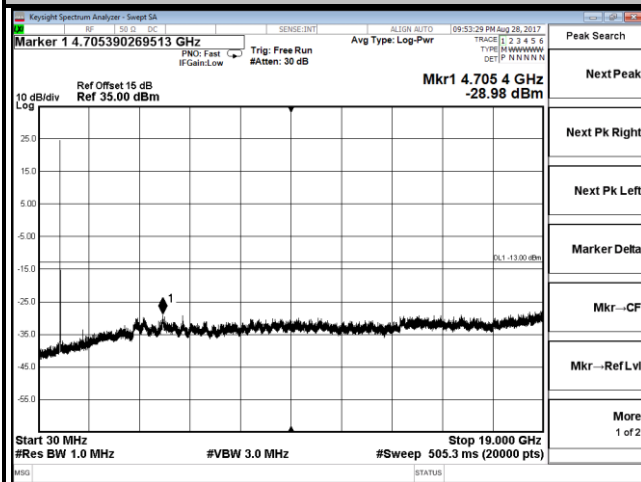

## 4.7 Radiated Emission Measurement

### 4.7.1 Limits of Radiated Emission Measurement

The power of any emission outside of the authorized operating frequency ranges must be attenuated below the transmitting power (P) by a factor of at least  $43 + 10 \log(P)$  dB. The emission limit is equal to -13 dBm.

### 4.7.2 Test Procedure

- Substitution method is used for E.I.R.P measurement. In the semi-anechoic chamber, EUT placed on the 0.8 m height of Turn Table, rotated the table around 360 degrees to search the maximum radiation power and receiver antenna shall be rotated vertical and horizontal polarization and moved height from 1 m to 4 m to find the maximum polar radiated power. The "Read Value" is the spectrum reading the maximum power value.
- The substitution horn antenna is substituted for EUT at the same position and signals generator export the CW signal to the substitution antenna via a TX cable. Rotated the Turn Table and moved receiving antenna to find the maximum radiation power. Adjust output power level of S.G to get a Value of spectrum reading equal to "Read Value" of step a. Record the power level of S.G
- $EIRP = \text{Output power level of S.G} - \text{TX cable loss} + \text{Antenna gain of substitution horn.}$
- E.R.P power can be calculated form E.I.R.P power by subtracting the gain of dipole,  $E.R.P \text{ power} = E.I.P.R \text{ power} - 2.15 \text{ dBi.}$

**NOTE:** The resolution bandwidth and video bandwidth of test receiver/spectrum analyzer is 1 MHz/3 MHz.

### 4.7.3 Deviation from Test Standard

No deviation.

### 4.7.4 Test Setup

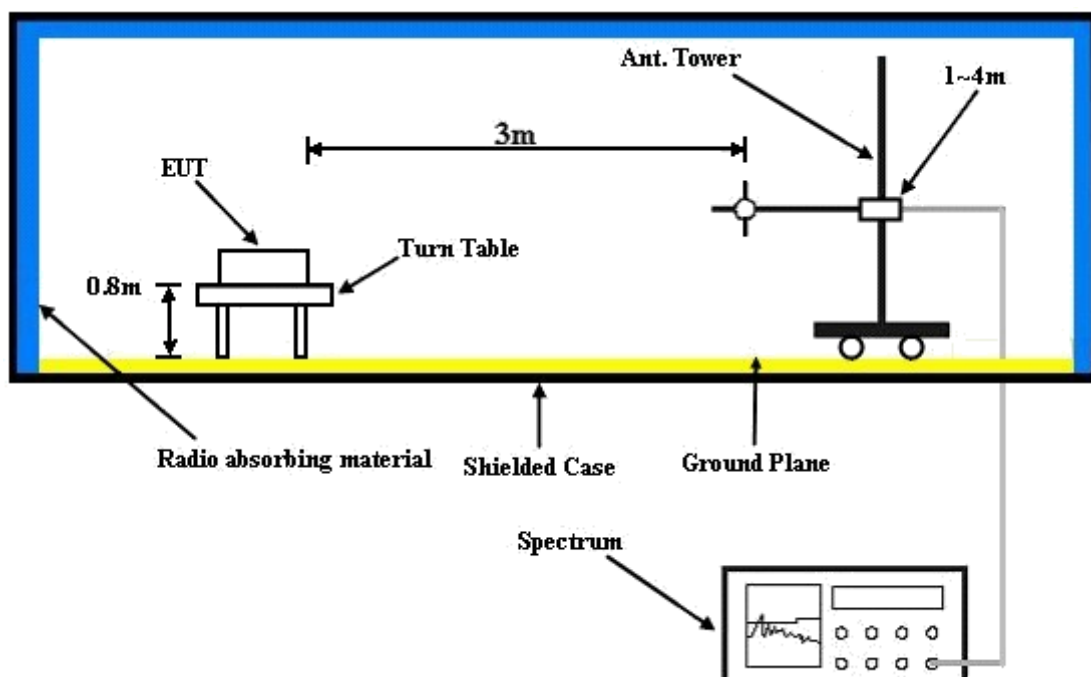

For the actual test configuration, please refer to the attached file (Test Setup Photo).

4.7.5 Test Results

GSM:  
Low Channel



Bureau Veritas Consumer Products Services Ltd., Taoyuan Branch

A D T

Data: 5

Date: 2017-08-25

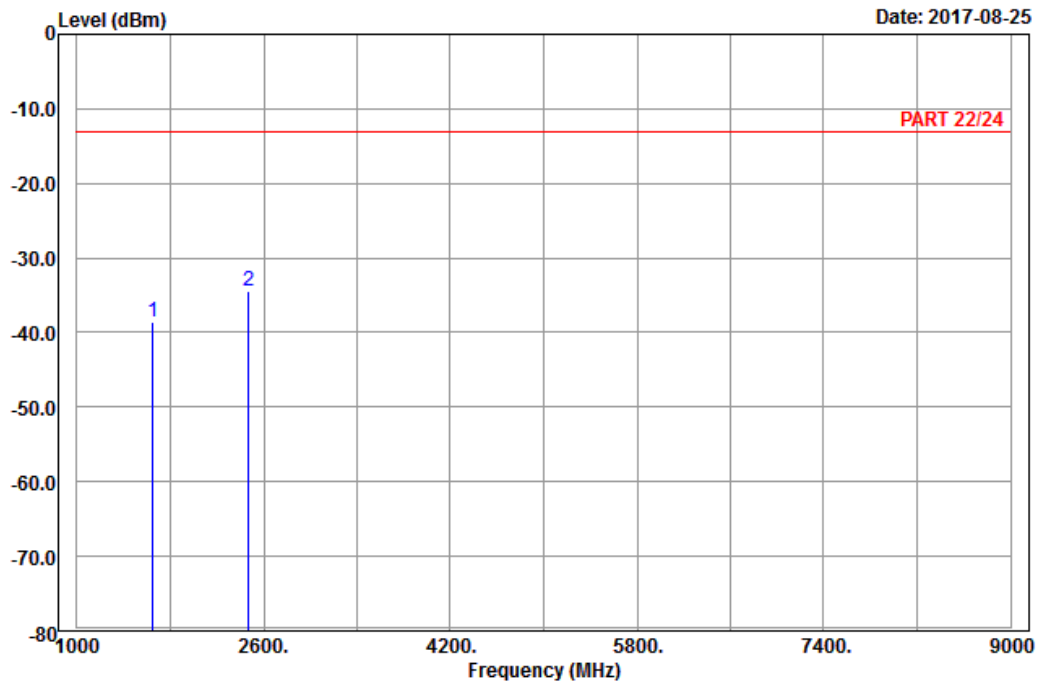

Site : 966 chamber 1  
Condition: PART 22/24 Horizontal  
Remark : GSM 850\_Link\_CH128  
Tested by: Karl Lee

	Freq	Level	Read Level	Limit Line	Over Limit	Factor	Remark
	MHz	dBm	dBm	dBm	dB	dB	
1	1648.40	-38.54	-46.27	-13.00	-25.54	7.73	Peak
2 pp	2472.60	-34.38	-45.41	-13.00	-21.38	11.03	Peak



Bureau Veritas Consumer Products Services Ltd., Taoyuan Branch

A D T

Data: 6

Date: 2017-08-25

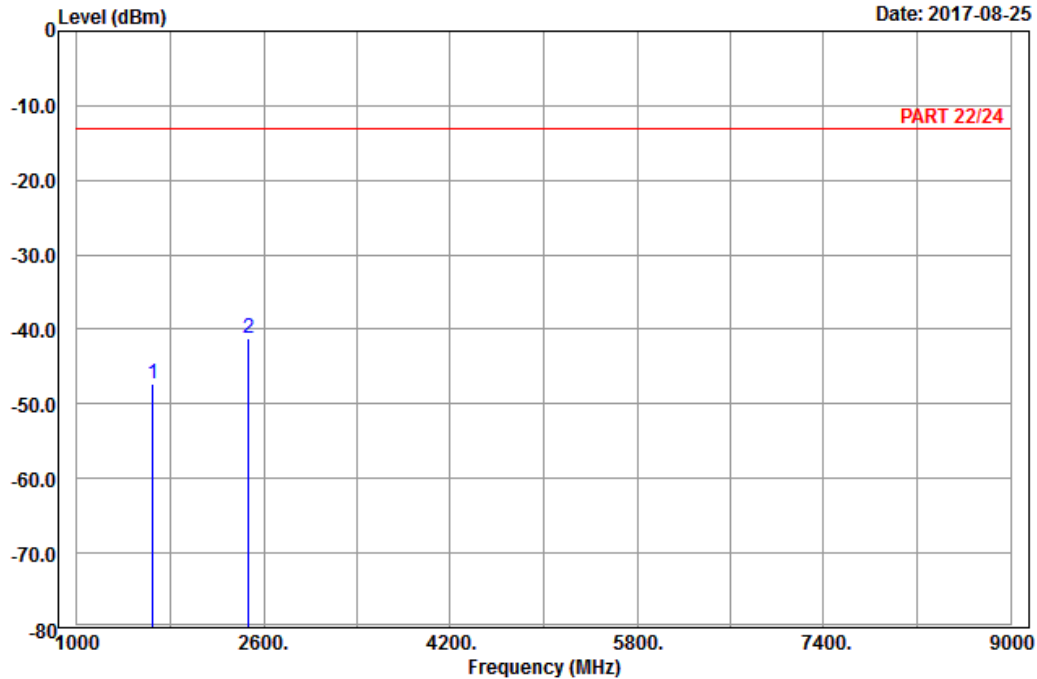

Site : 966 chamber 1  
 Condition: PART 22/24 Vertical  
 Remark : GSM 850\_Link\_CH128  
 Tested by: Karl Lee

	Freq	Level	Read Level	Limit Line	Over Limit	Factor	Remark
	MHz	dBm	dBm	dBm	dB	dB	
1	1648.40	-47.33	-55.06	-13.00	-34.33	7.73	Peak
2 pp	2472.60	-41.22	-52.25	-13.00	-28.22	11.03	Peak

Frequency (MHz)	ERP(dBm)	Limit(dBm)	Over Limit (dB)	SPA. Reading (dBm)	S.G. Power (dBm)	TX Cable loss (dB)	TX Antenna Gain (dBi)	Polarization (H/V)	Result
1648.4	-38.54	-13	-25.54	-44.16	-38.32	3.704	5.63	H	Pass
2472.6	-34.38	-13	-21.38	-43.21	-33.81	4.57	6.15	H	Pass
1648.4	-47.33	-13	-34.33	-52.90	-47.11	3.704	5.63	V	Pass
2472.6	-41.22	-13	-28.22	-50.04	-40.65	4.57	6.15	V	Pass

Middle Channel



Bureau Veritas Consumer Products Services Ltd., Taoyuan Branch

A D T

Data: 9

Date: 2017-08-04

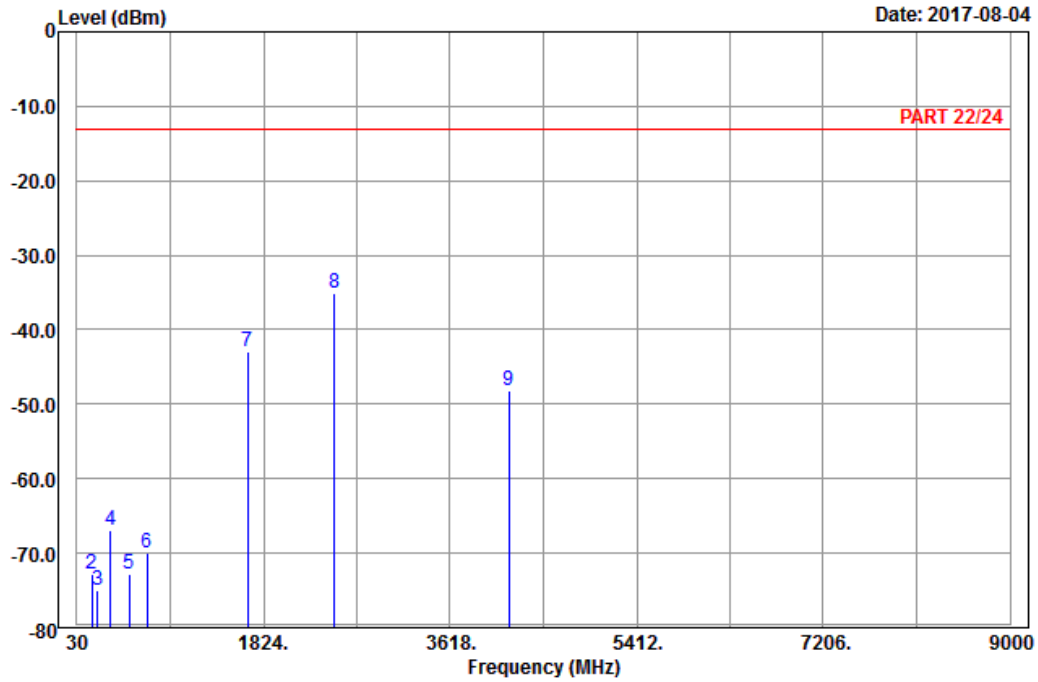

Site : 966 chamber 1  
 Condition: PART 22/24 Horizontal  
 Remark : GSM 850\_Link\_CH189  
 Tested by: Karl Lee

	Freq	Level	Read Level	Limit Line	Over Limit	Factor	Remark
	MHz	dBm	dBm	dBm	dB	dB	
1	48.63	-83.57	-70.14	-13.00	-70.57	-13.43	Peak
2	170.94	-72.90	-66.30	-13.00	-59.90	-6.60	Peak
3	225.21	-74.96	-69.11	-13.00	-61.96	-5.85	Peak
4	354.60	-66.99	-61.87	-13.00	-53.99	-5.12	Peak
5	532.40	-72.75	-69.81	-13.00	-59.75	-2.94	Peak
6	704.60	-69.90	-69.45	-13.00	-56.90	-0.45	Peak
7	1672.80	-42.87	-50.78	-13.00	-29.87	7.91	Peak
8 pp	2509.20	-35.08	-46.36	-13.00	-22.08	11.28	Peak
9	4182.00	-48.10	-65.23	-13.00	-35.10	17.13	Peak





Bureau Veritas Consumer Products Services Ltd., Taoyuan Branch

A D T

Data: 10

Date: 2017-08-04

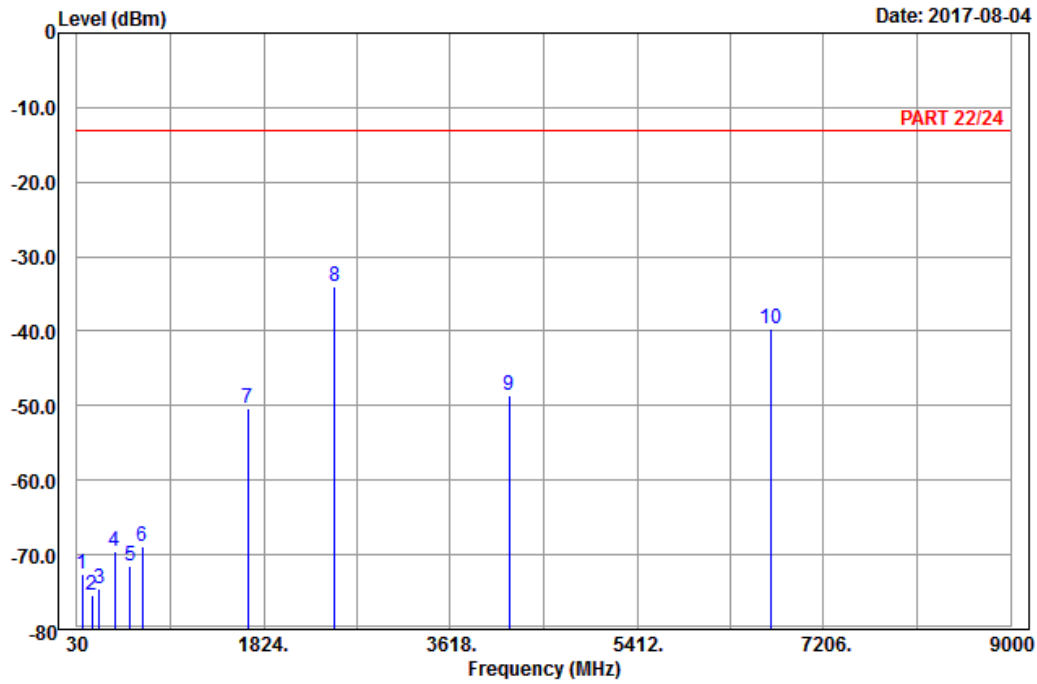

Site : 966 chamber 1  
 Condition: PART 22/24 Vertical  
 Remark : GSM 850\_Link\_CH189  
 Tested by: Karl Lee

	Freq	Level	Read Level	Limit Line	Over Limit	Factor	Remark
	MHz	dBm	dBm	dBm	dB	dB	
1	79.95	-72.53	-60.68	-13.00	-59.53	-11.85	Peak
2	170.67	-75.36	-68.76	-13.00	-62.36	-6.60	Peak
3	248.16	-74.65	-69.12	-13.00	-61.65	-5.53	Peak
4	395.20	-69.58	-66.58	-13.00	-56.58	-3.00	Peak
5	538.00	-71.42	-68.91	-13.00	-58.42	-2.51	Peak
6	659.10	-68.78	-68.60	-13.00	-55.78	-0.18	Peak
7	1672.80	-50.36	-58.27	-13.00	-37.36	7.91	Peak
8 pp	2509.20	-34.09	-45.37	-13.00	-21.09	11.28	Peak
9	4182.00	-48.63	-65.76	-13.00	-35.63	17.13	Peak
10	6691.20	-39.74	-62.14	-13.00	-26.74	22.40	Peak

Frequency (MHz)	ERP(dBm)	Limit(dBm)	Over Limit (dB)	SPA. Reading (dBm)	S.G. Power (dBm)	TX Cable loss (dB)	TX Antenna Gain (dBi)	Polarization (H/V)	Result
1672.8	-42.87	-13	-29.87	-48.56	-42.65	3.704	5.63	H	Pass
2509.2	-35.08	-13	-22.08	-44.14	-34.51	4.57	6.15	H	Pass
4182	-48.10	-13	-35.10	-63.12	-49.29	6.045	9.39	H	Pass
1672.8	-50.36	-13	-37.36	-56.15	-50.14	3.704	5.63	V	Pass
2509.2	-34.09	-13	-21.09	-43.19	-33.52	4.57	6.15	V	Pass
4182	-48.63	-13	-35.63	-63.56	-49.82	6.045	9.39	V	Pass
6691.2	-39.74	-13	-26.74	-60.02	-41.32	7.709	11.44	V	Pass

High Channel



Bureau Veritas Consumer Products Services Ltd., Taoyuan Branch

A D T

Data: 5

Date: 2017-08-25

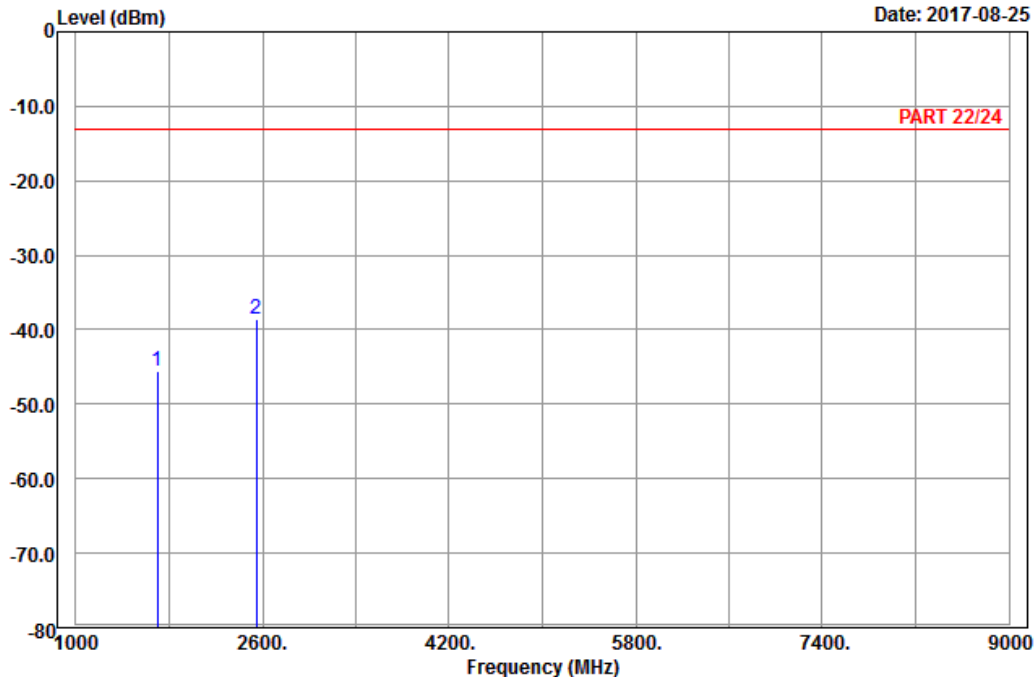

Site : 966 chamber 1  
 Condition: PART 22/24 Horizontal  
 Remark : GSM 850\_Link\_CH251  
 Tested by: Karl Lee

	Freq	Level	Read Level	Limit Line	Over Limit	Factor	Remark
	MHz	dBm	dBm	dBm	dB	dB	
1	1697.60	-45.58	-53.72	-13.00	-32.58	8.14	Peak
2	2546.40	-38.51	-49.98	-13.00	-25.51	11.47	Peak



Bureau Veritas Consumer Products Services Ltd., Taoyuan Branch

A D T

Data: 6

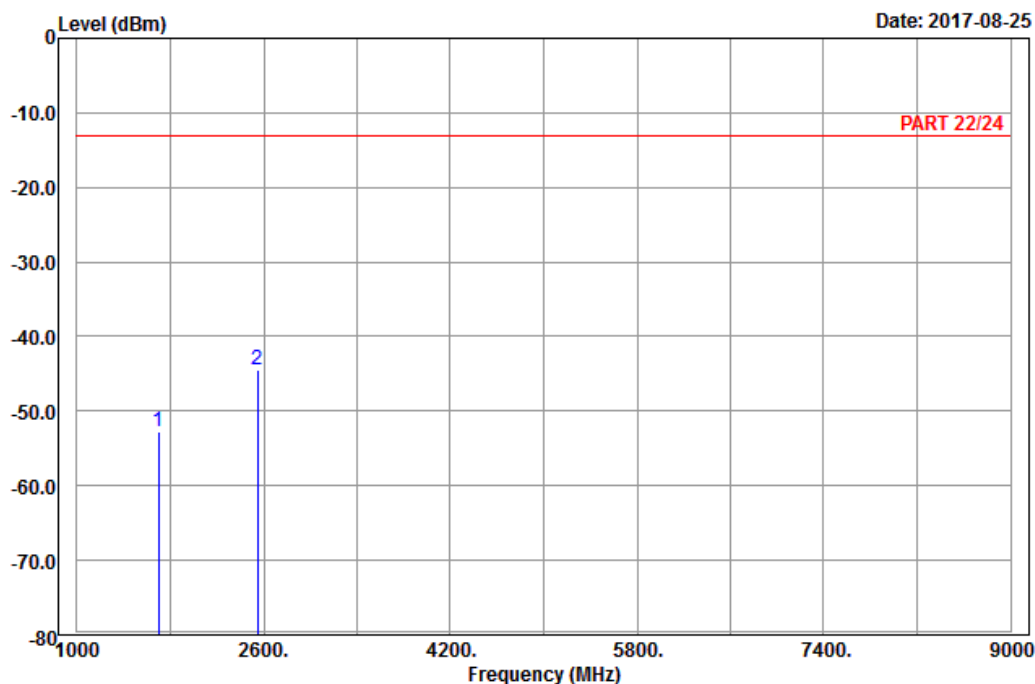

Site : 966 chamber 1  
 Condition: PART 22/24 Vertical  
 Remark : GSM 850\_Link\_CH251  
 Tested by: Karl Lee

	Freq	Level	Read Level	Limit Line	Over Limit	Factor	Remark
	MHz	dBm	dBm	dBm	dB	dB	
1	1697.60	-52.70	-60.84	-13.00	-39.70	8.14	Peak
2 pp	2546.40	-44.48	-55.95	-13.00	-31.48	11.47	Peak

Frequency (MHz)	ERP(dBm)	Limit(dBm)	Over Limit (dB)	SPA. Reading (dBm)	S.G. Power (dBm)	TX Cable loss (dB)	TX Antenna Gain (dBi)	Polarization (H/V)	Result
1697.6	-45.58	-13	-32.58	-51.55	-45.36	3.704	5.63	H	Pass
2546.4	-38.51	-13	-25.51	-47.78	-37.94	4.57	6.15	H	Pass
1697.6	-52.70	-13	-39.70	-58.67	-52.48	3.704	5.63	V	Pass
2546.4	-44.48	-13	-31.48	-53.77	-43.91	4.57	6.15	V	Pass

EDGE:  
Low Channel



Bureau Veritas Consumer Products Services Ltd., Taoyuan Branch

A D T

Data: 5

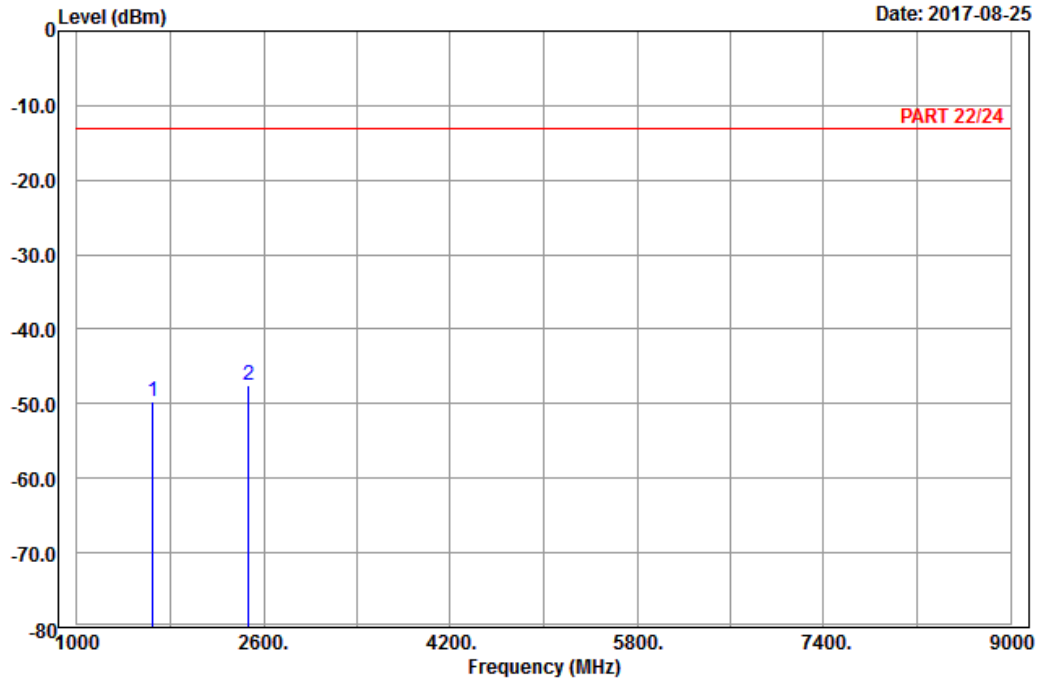

Site : 966 chamber 1  
Condition: PART 22/24 Horizontal  
Remark : EDGE 850\_Link\_CH128  
Tested by: Karl Lee

	Freq	Level	Read Level	Limit Line	Over Limit	Factor	Remark
	MHz	dBm	dBm	dBm	dB	dB	
1	1648.40	-49.76	-57.49	-13.00	-36.76	7.73	Peak
2 pp	2472.60	-47.55	-58.58	-13.00	-34.55	11.03	Peak



Bureau Veritas Consumer Products Services Ltd., Taoyuan Branch

A D T

Data: 6

Date: 2017-08-25

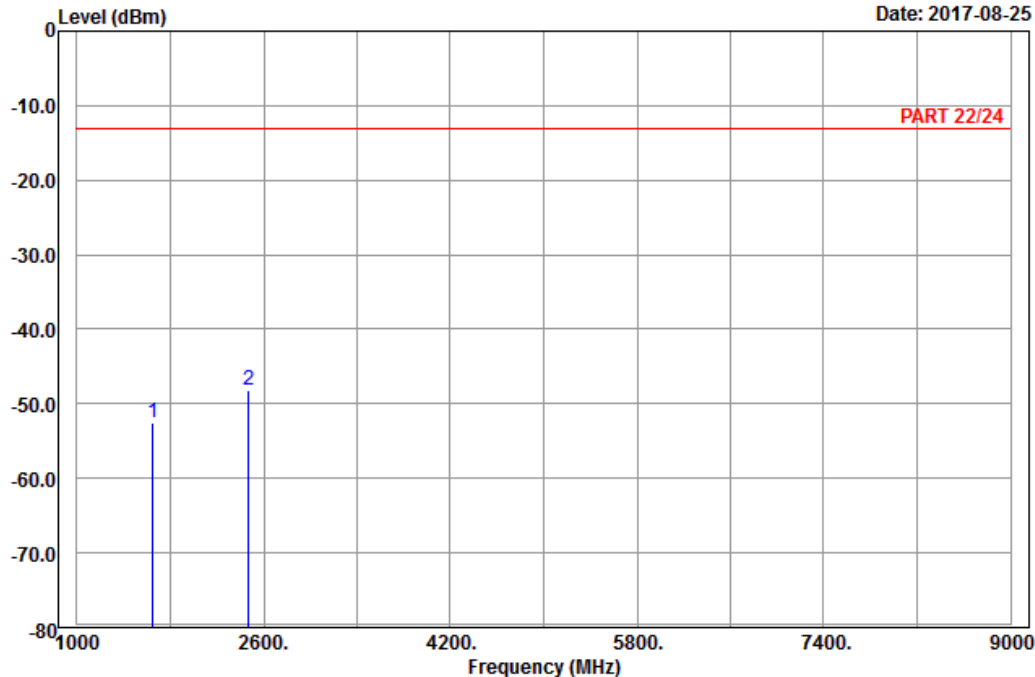

Site : 966 chamber 1  
 Condition: PART 22/24 Vertical  
 Remark : EDGE 850\_Link\_CH128  
 Tested by: Karl Lee

	Freq	Level	Read Level	Limit Line	Over Limit	Factor	Remark
	MHz	dBm	dBm	dBm	dB	dB	
1	1648.40	-52.50	-60.23	-13.00	-39.50	7.73	Peak
2 pp	2472.60	-48.28	-59.31	-13.00	-35.28	11.03	Peak

Frequency (MHz)	ERP(dBm)	Limit(dBm)	Over Limit (dB)	SPA. Reading (dBm)	S.G. Power (dBm)	TX Cable loss (dB)	TX Antenna Gain (dBi)	Polarization (H/V)	Result
1648.4	-49.76	-13	-36.76	-55.32	-49.54	3.704	5.63	H	Pass
2472.6	-47.55	-13	-34.55	-56.39	-46.98	4.57	6.15	H	Pass
1648.4	-52.50	-13	-39.50	-58.01	-52.28	3.704	5.63	V	Pass
2472.6	-48.28	-13	-35.28	-57.17	-47.71	4.57	6.15	V	Pass

Middle Channel



Bureau Veritas Consumer Products Services Ltd., Taoyuan Branch

A D T

Data: 5

Date: 2017-08-25

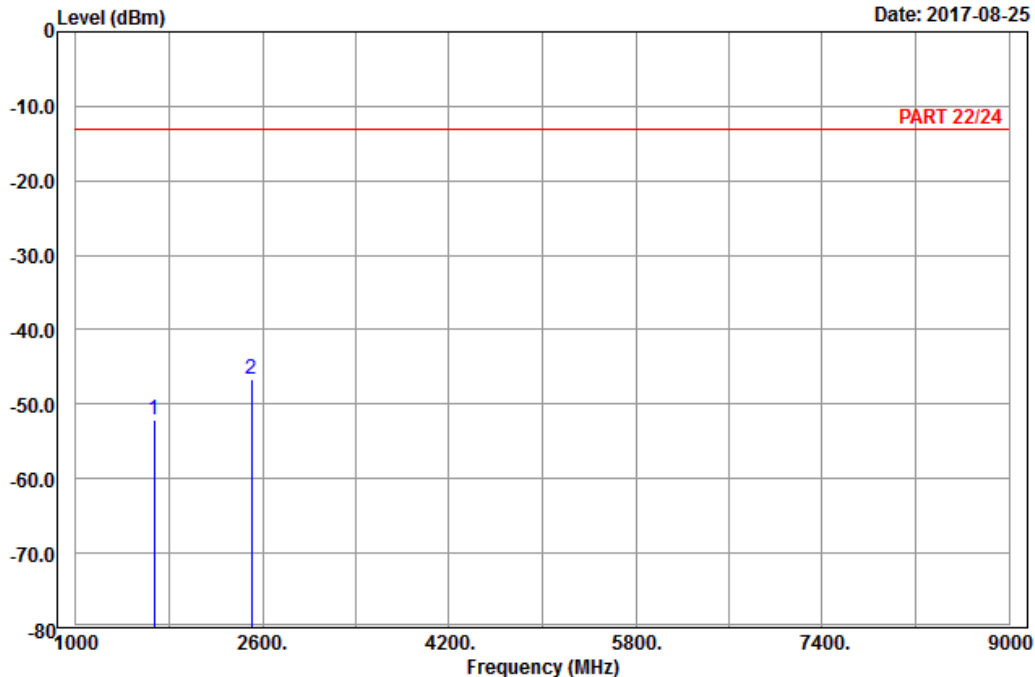

Site : 966 chamber 1  
 Condition: PART 22/24 Horizontal  
 Remark : EDGE 850\_Link\_CH189  
 Tested by: Karl Lee

	Freq	Level	Read Level	Limit Line	Over Limit	Factor	Remark
	MHz	dBm	dBm	dBm	dB	dB	
1	1672.80	-52.20	-60.11	-13.00	-39.20	7.91	Peak
2	2509.20	-46.56	-57.84	-13.00	-33.56	11.28	Peak



Bureau Veritas Consumer Products Services Ltd., Taoyuan Branch

A D T

Data: 6

Date: 2017-08-25

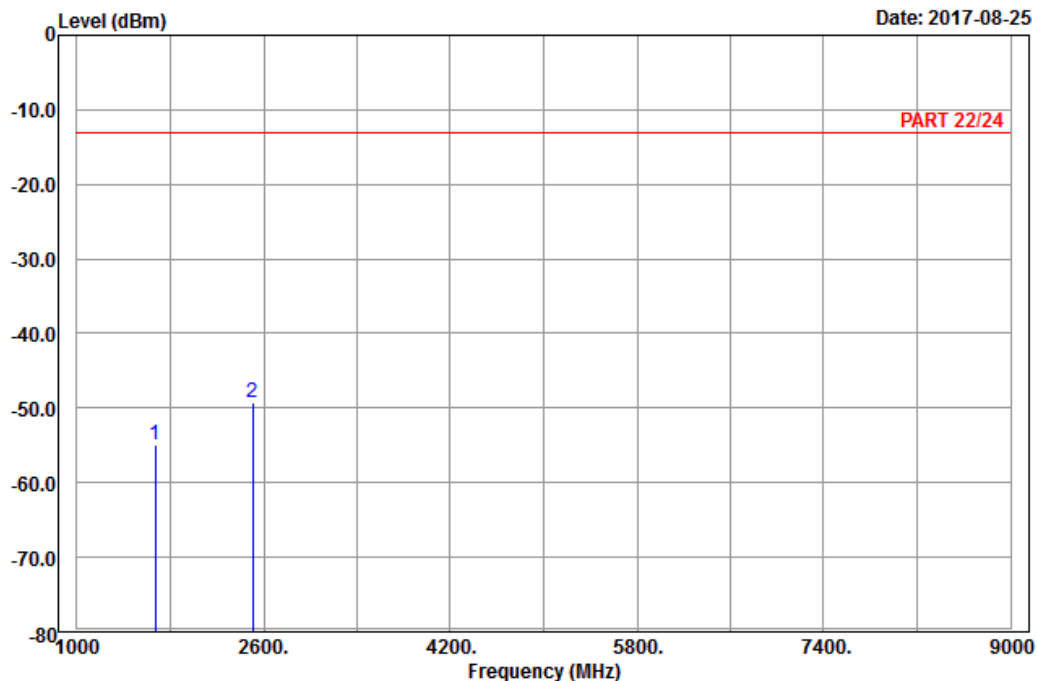

Site : 966 chamber 1  
 Condition: PART 22/24 Vertical  
 Remark : EDGE 850\_Link\_CH189  
 Tested by: Karl Lee

	Freq	Level	Read Level	Limit Line	Over Limit	Factor	Remark
	MHz	dBm	dBm	dBm	dB	dB	
1	1672.80	-55.01	-62.92	-13.00	-42.01	7.91	Peak
2 pp	2509.20	-49.28	-60.56	-13.00	-36.28	11.28	Peak

Frequency (MHz)	ERP(dBm)	Limit(dBm)	Over Limit (dB)	SPA. Reading (dBm)	S.G. Power (dBm)	TX Cable loss (dB)	TX Antenna Gain (dBi)	Polarization (H/V)	Result
1672.8	-52.20	-13	-39.20	-57.91	-51.98	3.704	5.63	H	Pass
2509.2	-46.56	-13	-33.56	-55.64	-45.99	4.57	6.15	H	Pass
1672.8	-55.01	-13	-42.01	-60.68	-54.79	3.704	5.63	V	Pass
2509.2	-49.28	-13	-36.28	-58.38	-48.71	4.57	6.15	V	Pass



High Channel



Bureau Veritas Consumer Products Services Ltd., Taoyuan Branch

A D T

Data: 5

Date: 2017-08-25

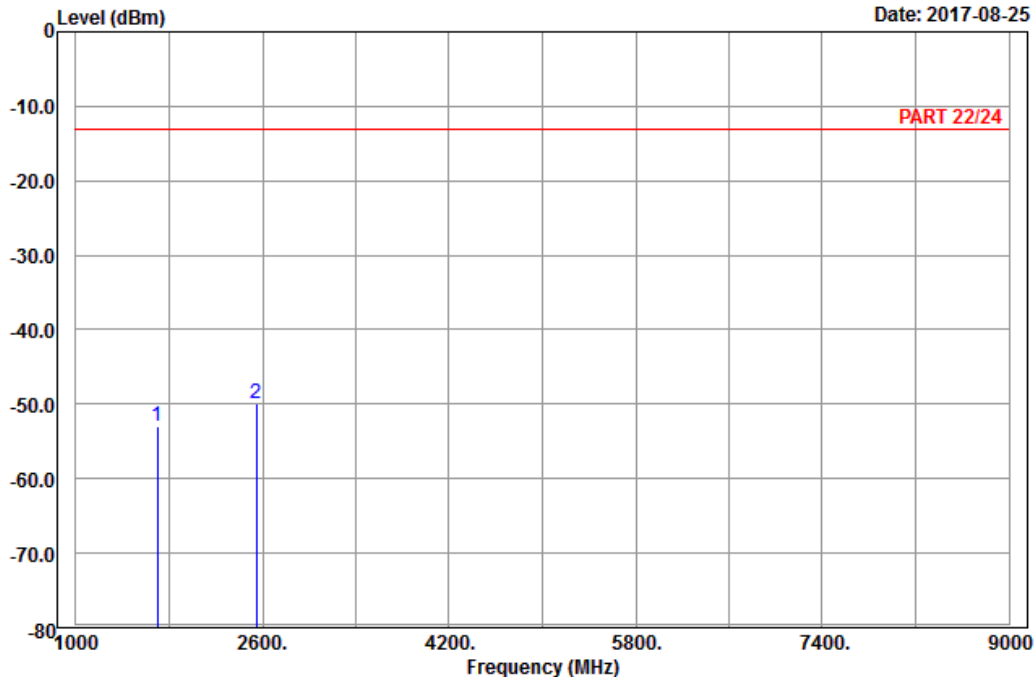

Site : 966 chamber 1  
 Condition: PART 22/24 Horizontal  
 Remark : EDGE 850\_Link\_CH251  
 Tested by: Karl Lee

	Freq	Level	Read Level	Limit Line	Over Limit	Factor	Remark
	MHz	dBm	dBm	dBm	dB	dB	
1	1697.60	-53.02	-61.16	-13.00	-40.02	8.14	Peak
2	2546.40	-49.90	-61.37	-13.00	-36.90	11.47	Peak



Bureau Veritas Consumer Products Services Ltd., Taoyuan Branch

A D T

Data: 6

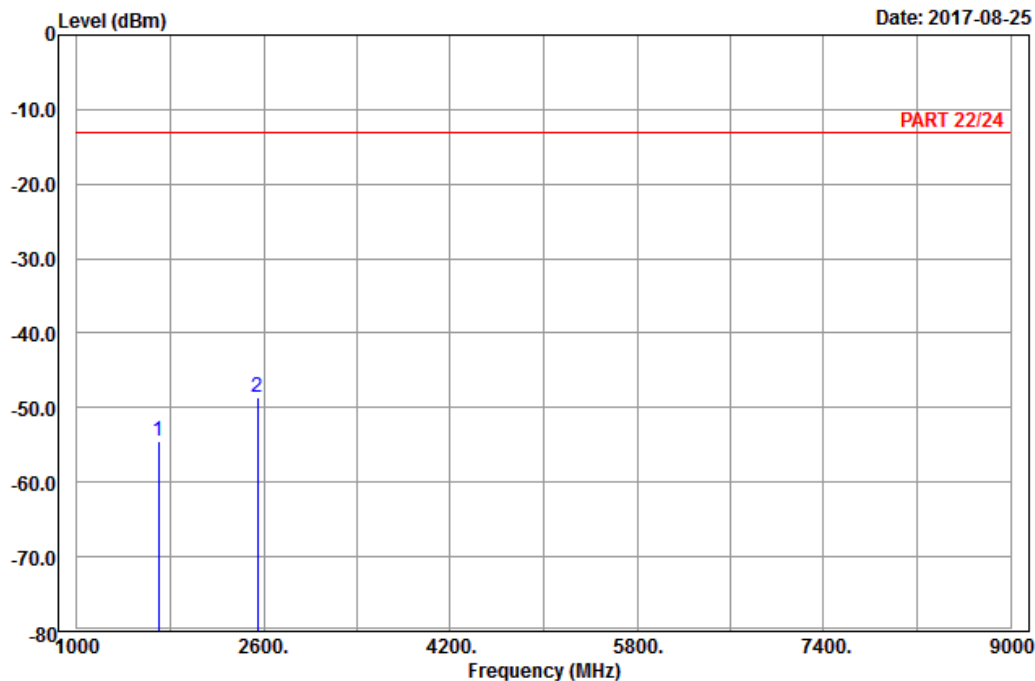

Site : 966 chamber 1  
 Condition: PART 22/24 Vertical  
 Remark : EDGE 850\_Link\_CH251  
 Tested by: Karl Lee

	Freq	Level	Read Level	Limit Line	Over Limit	Factor	Remark
	MHz	dBm	dBm	dBm	dB	dB	
1	1697.60	-54.56	-62.70	-13.00	-41.56	8.14	Peak
2 pp	2546.40	-48.60	-60.07	-13.00	-35.60	11.47	Peak

Frequency (MHz)	ERP(dBm)	Limit(dBm)	Over Limit (dB)	SPA. Reading (dBm)	S.G. Power (dBm)	TX Cable loss (dB)	TX Antenna Gain (dBi)	Polarization (H/V)	Result
1697.6	-53.02	-13	-40.02	-58.96	-52.8	3.704	5.63	H	Pass
2546.4	-49.90	-13	-36.90	-59.13	-49.33	4.57	6.15	H	Pass
1697.6	-54.56	-13	-41.56	-60.54	-54.34	3.704	5.63	V	Pass
2546.4	-48.60	-13	-35.60	-57.88	-48.03	4.57	6.15	V	Pass

WCDMA:  
Low Channel



Bureau Veritas Consumer Products Services Ltd., Taoyuan Branch

A D T

Data: 5

Date: 2017-08-25

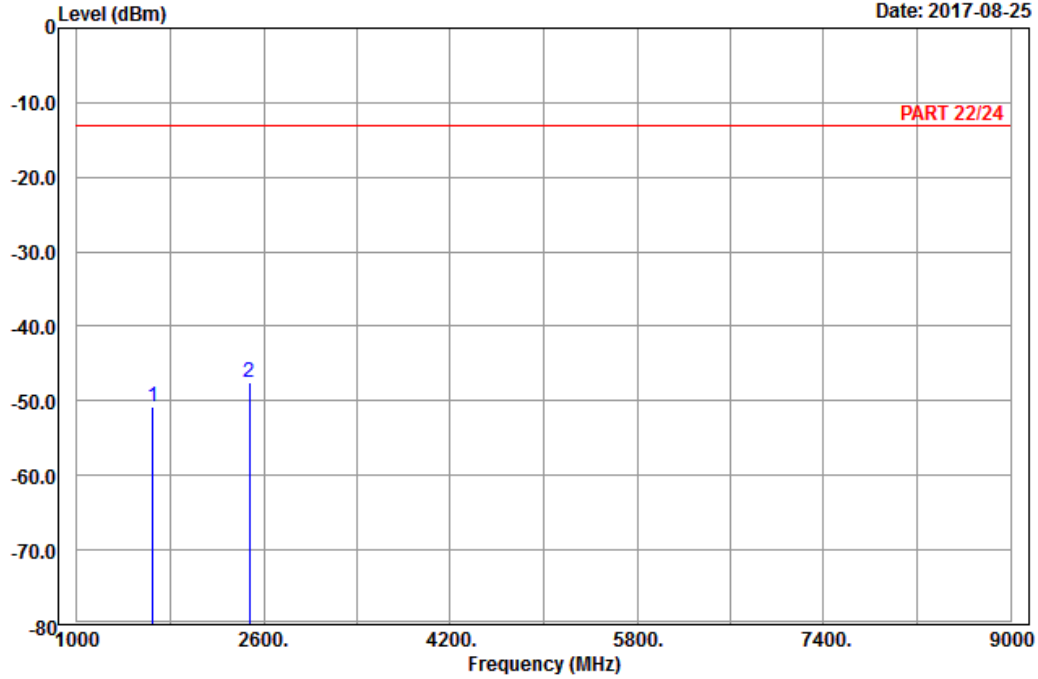

Site : 966 chamber 1  
Condition: PART 22/24 Horizontal  
Remark : Band V\_Link\_CH4132  
Tested by: Karl Lee

	Freq	Level	Read Level	Limit Line	Over Limit	Factor	Remark
	MHz	dBm	dBm	dBm	dB	dB	
1	1652.80	-50.71	-58.44	-13.00	-37.71	7.73	Peak
2 pp	2479.20	-47.55	-58.58	-13.00	-34.55	11.03	Peak



Bureau Veritas Consumer Products Services Ltd., Taoyuan Branch

A D T

Data: 6

Date: 2017-08-25

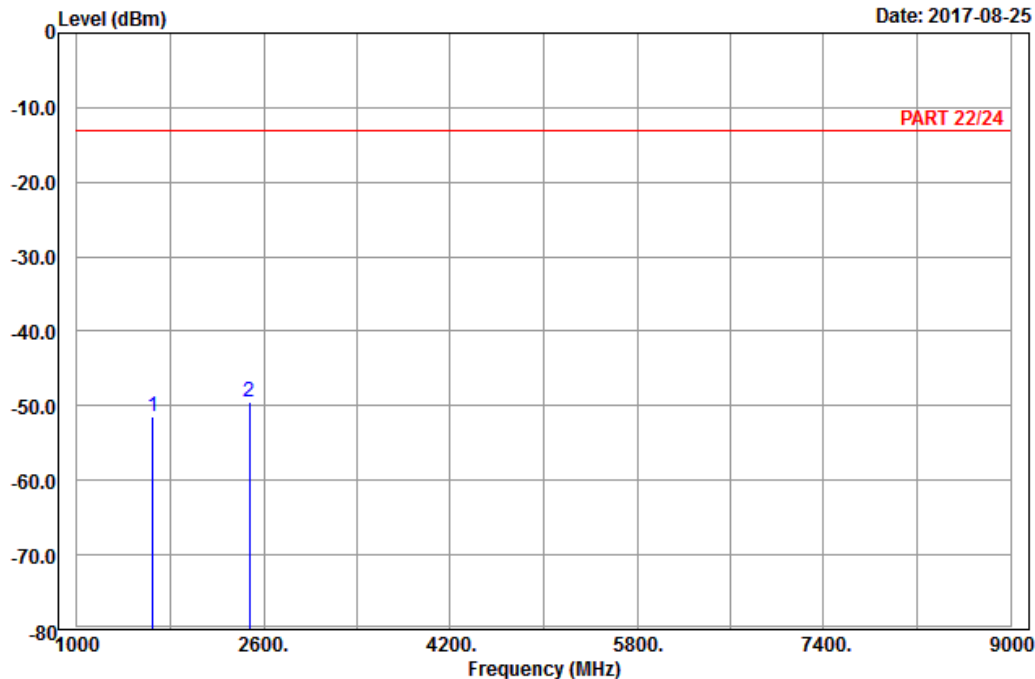

Site : 966 chamber 1  
 Condition: PART 22/24 Vertical  
 Remark : Band V\_Link\_CH4132  
 Tested by: Karl Lee

	Freq	Level	Read Level	Limit Line	Over Limit	Factor	Remark
	MHz	dBm	dBm	dBm	dB	dB	
1	1652.80	-51.55	-59.28	-13.00	-38.55	7.73	Peak
2 pp	2479.20	-49.41	-60.44	-13.00	-36.41	11.03	Peak

Frequency (MHz)	ERP(dBm)	Limit(dBm)	Over Limit (dB)	SPA. Reading (dBm)	S.G. Power (dBm)	TX Cable loss (dB)	TX Antenna Gain (dBi)	Polarization (H/V)	Result
1652.8	-50.71	-13	-37.71	-56.22	-50.49	3.704	5.63	H	Pass
2479.2	-47.55	-13	-34.55	-56.39	-46.98	4.57	6.15	H	Pass
1652.8	-51.55	-13	-38.55	-57.15	-51.33	3.704	5.63	V	Pass
2479.2	-49.41	-13	-36.41	-58.22	-48.84	4.57	6.15	V	Pass

Middle Channel



Bureau Veritas Consumer Products Services Ltd., Taoyuan Branch

A D T

Data: 5

Date: 2017-08-26

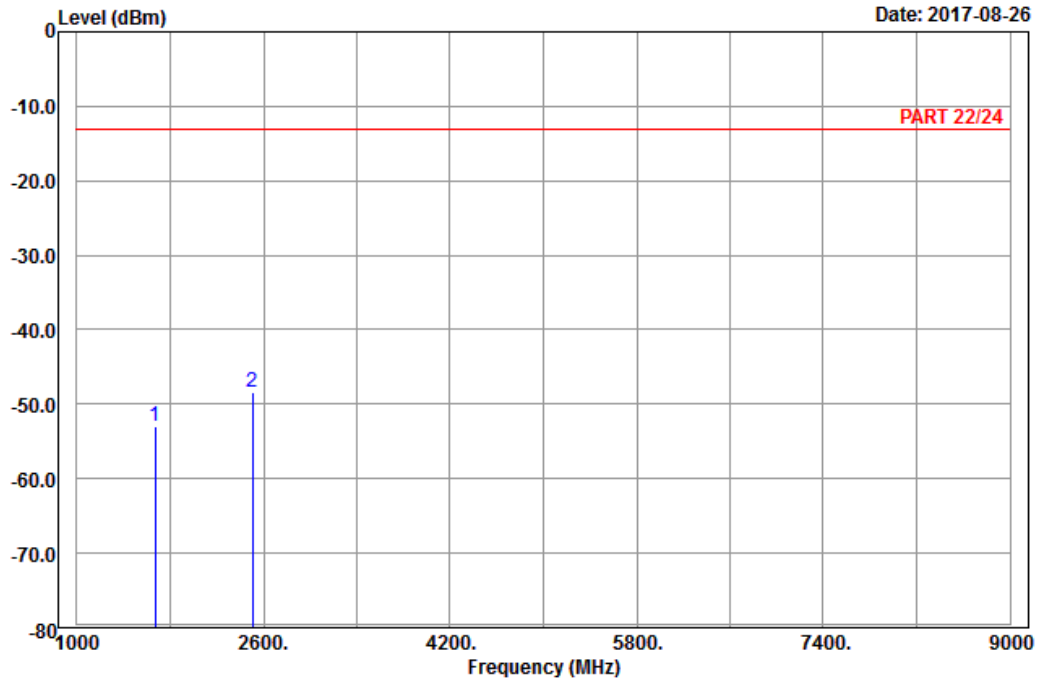

Site : 966 chamber 1  
 Condition: PART 22/24 Horizontal  
 Remark : Band V\_Link\_CH4182  
 Tested by: Karl Lee

	Freq	Level	Read Level	Limit Line	Over Limit	Factor	Remark
	MHz	dBm	dBm	dBm	dB	dB	
1	1672.80	-53.04	-60.95	-13.00	-40.04	7.91	Peak
2	2509.20	-48.31	-59.59	-13.00	-35.31	11.28	Peak



Bureau Veritas Consumer Products Services Ltd., Taoyuan Branch

A D T

Data: 6

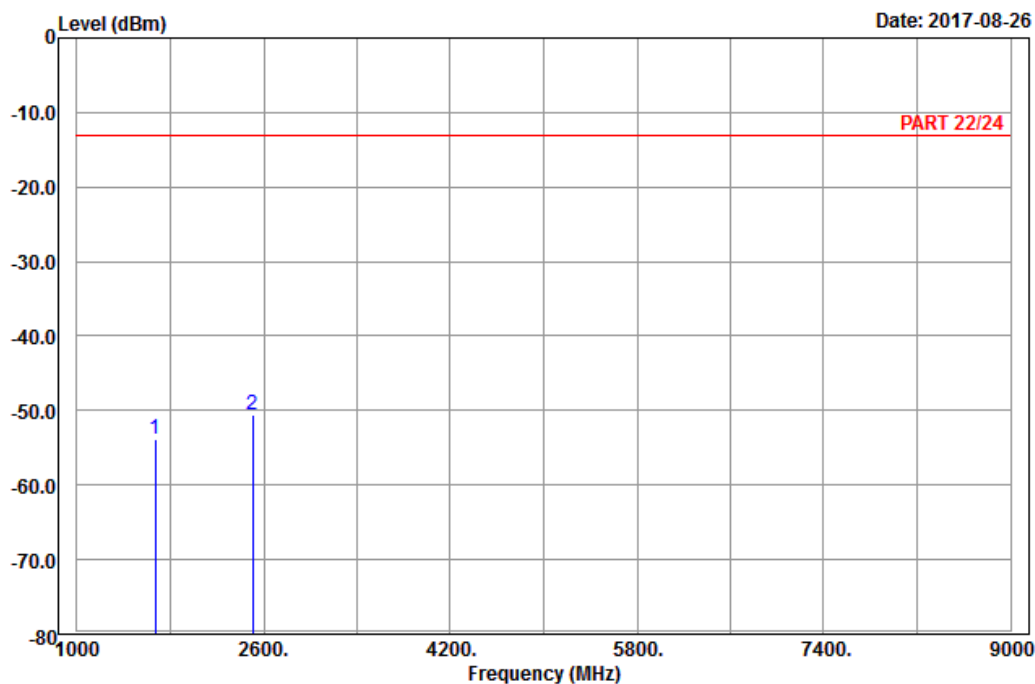

Site : 966 chamber 1  
 Condition: PART 22/24 Vertical  
 Remark : Band V\_Link\_CH4182  
 Tested by: Karl Lee

	Freq	Level	Read Level	Limit Line	Over Limit	Factor	Remark
	MHz	dBm	dBm	dBm	dB	dB	
1	1672.80	-53.77	-61.68	-13.00	-40.77	7.91	Peak
2 pp	2509.20	-50.56	-61.84	-13.00	-37.56	11.28	Peak

Frequency (MHz)	ERP(dBm)	Limit(dBm)	Over Limit (dB)	SPA. Reading (dBm)	S.G. Power (dBm)	TX Cable loss (dB)	TX Antenna Gain (dBi)	Polarization (H/V)	Result
1672.8	-53.04	-13	-40.04	-58.81	-52.82	3.704	5.63	H	Pass
2509.2	-48.31	-13	-35.31	-57.39	-47.74	4.57	6.15	H	Pass
1672.8	-53.77	-13	-40.77	-59.50	-53.55	3.704	5.63	V	Pass
2509.2	-50.56	-13	-37.56	-59.64	-49.99	4.57	6.15	V	Pass

High Channel



Bureau Veritas Consumer Products Services Ltd., Taoyuan Branch

A D T

Data: 5

Date: 2017-08-25

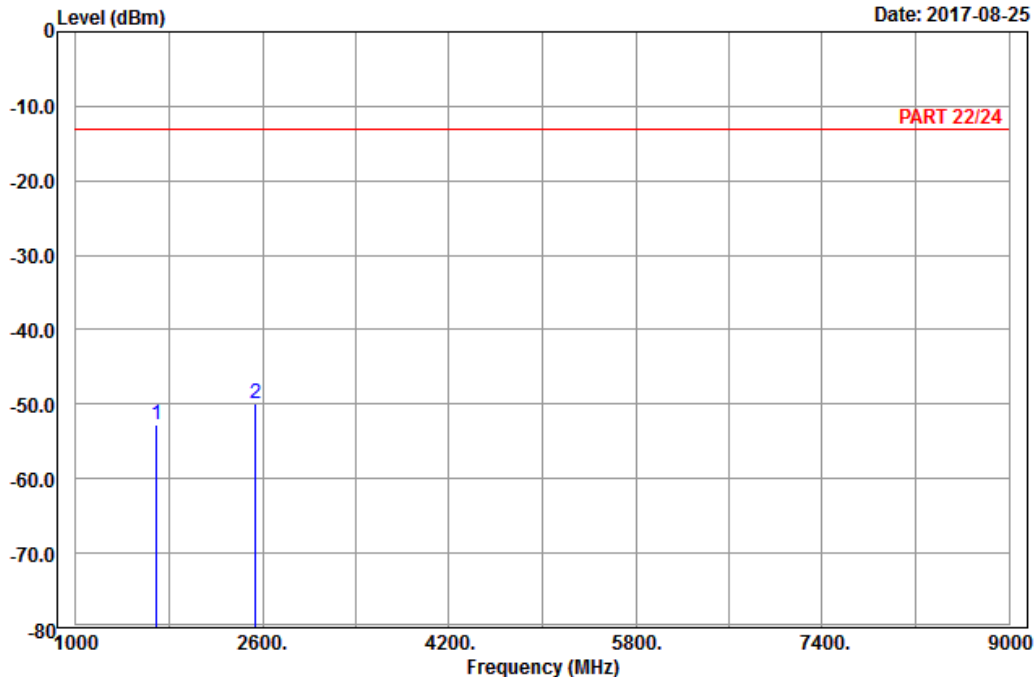

Site : 966 chamber 1  
 Condition: PART 22/24 Horizontal  
 Remark : Band V\_Link\_CH4233  
 Tested by: Karl Lee

	Freq	Level	Read Level	Limit Line	Over Limit	Factor	Remark
	MHz	dBm	dBm	dBm	dB	dB	
1	1693.20	-52.66	-60.80	-13.00	-39.66	8.14	Peak
2	2539.80	-49.82	-61.29	-13.00	-36.82	11.47	Peak



Bureau Veritas Consumer Products Services Ltd., Taoyuan Branch

A D T

Data: 6

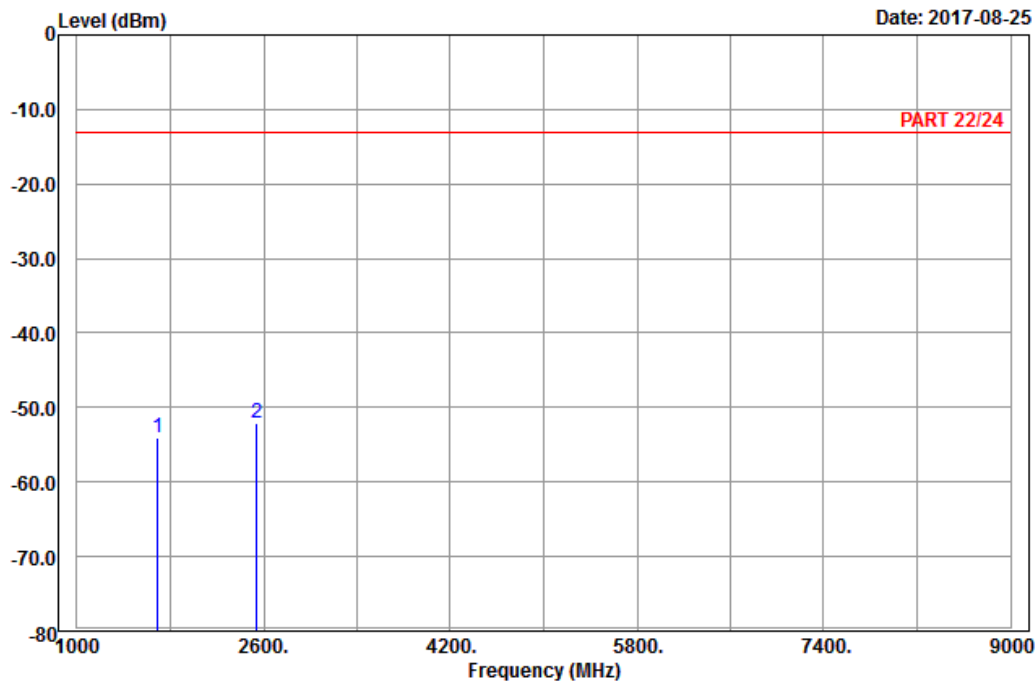

Site : 966 chamber 1  
 Condition: PART 22/24 Vertical  
 Remark : Band V\_Link\_CH4233  
 Tested by: Karl Lee

	Freq	Level	Read Level	Limit Line	Over Limit	Factor	Remark
	MHz	dBm	dBm	dBm	dB	dB	
1	1693.20	-53.98	-62.12	-13.00	-40.98	8.14	Peak
2 pp	2539.80	-52.11	-63.58	-13.00	-39.11	11.47	Peak

Frequency (MHz)	ERP(dBm)	Limit(dBm)	Over Limit (dB)	SPA. Reading (dBm)	S.G. Power (dBm)	TX Cable loss (dB)	TX Antenna Gain (dBi)	Polarization (H/V)	Result
1693.2	-52.66	-13	-39.66	-58.63	-52.44	3.704	5.63	H	Pass
2539.8	-49.82	-13	-36.82	-59.12	-49.25	4.57	6.15	H	Pass
1693.2	-53.98	-13	-40.98	-59.91	-53.76	3.704	5.63	V	Pass
2539.8	-52.11	-13	-39.11	-61.38	-51.54	4.57	6.15	V	Pass



## 5 Pictures of Test Arrangements

Please refer to the attached file (Test Setup Photo).

## Appendix – Information on the Testing Laboratories

We, Bureau Veritas Consumer Products Services (H.K.) Ltd., Taoyuan Branch, were founded in 1988 to provide our best service in EMC, Radio, Telecom and Safety consultation. Our laboratories are FCC recognized accredited test firms and accredited according to ISO/IEC 17025.

If you have any comments, please feel free to contact us at the following:

**Linko EMC/RF Lab**

Tel: 886-2-26052180

Fax: 886-2-26051924

**Hsin Chu EMC/RF/Telecom Lab**

Tel: 886-3-6668565

Fax: 886-3-6668323

**Hwa Ya EMC/RF/Safety**

Tel: 886-3-3183232

Fax: 886-3-3270892

**Email:** [service.adt@tw.bureauveritas.com](mailto:service.adt@tw.bureauveritas.com)

**Web Site:** [www.bureauveritas-adt.com](http://www.bureauveritas-adt.com)

The address and road map of all our labs can be found in our web site also.

--- END ---