

FCC SAR Test Report

Report No. : SA190813C30
Applicant : Verifone, Inc.
Address : 1400 West Stanford Ranch Road Suite 200 Rocklin CA 95765 USA
Product : Point of Sale Terminal
FCC ID : B32E2853GDB
Brand : Verifone
Model No. : e285 3G/BT/WiFi/DS/DB
Standards : FCC 47 CFR Part 2 (2.1093), IEEE C95.1:1992, IEEE Std 1528:2013
KDB 865664 D01 v01r04, KDB 865664 D02 v01r02, KDB 248227 D01 v02r02,
KDB 447498 D01 v06, KDB 941225 D01 v03r01, KDB 941225 D07 v01r02
Sample Received Date : Aug. 13, 2019
Date of Testing : Sep. 05, 2019 ~ Sep. 09, 2019
Lab Address : No. 47-2, 14th Ling, Chia Pau Vil., Lin Kou Dist., New Taipei City, Taiwan
Test Location : No. 19, Hwa Ya 2nd Rd, Wen Hwa Vil, Kwei Shan Dist., Taoyuan City 33383, Taiwan

CERTIFICATION: The above equipment have been tested by **Bureau Veritas Consumer Products Services (H.K.) Ltd., Taoyuan Branch–Lin Kou Laboratories**, and found compliance with the requirement of the above standards. The test record, data evaluation & Equipment Under Test (EUT) configurations represented herein are true and accurate accounts of the measurements of the sample's SAR characteristics under the conditions specified in this report. It should not be reproduced except in full, without the written approval of our laboratory. The client should not use it to claim product certification, approval, or endorsement by TAF or any government agencies.

This report is issued as a supplementary report to BV CPS report no.: SA170804C11. The difference compared with original report is changing BT/WLAN module for new application with new model.

Prepared By : 
Rona Chen / Specialist

Approved By : 
Gordon Lin / Manager



FCC Accredited No.: TW0003

This report is for your exclusive use. Any copying or replication of this report to or for any other person or entity, or use of our name or trademark, is permitted only with our prior written permission. This report sets forth our findings solely with respect to the test samples identified herein. The results set forth in this report are not indicative or representative of the quality or characteristics of the lot from which a test sample was taken or any similar or identical product unless specifically and expressly noted. Our report includes all of the tests requested by you and the results thereof based upon the information that you provided to us. You have 60 days from date of issuance of this report to notify us of any material error or omission caused by our negligence, provided, however, that such notice shall be in writing and shall specifically address the issue you wish to raise. A failure to raise such issue within the prescribed time shall constitute your unqualified acceptance of the completeness of this report, the tests conducted and the correctness of the report contents. Unless specific mention, the uncertainty of measurement has been explicitly taken into account to declare the compliance or non-compliance to the specification.

Table of Contents

Release Control Record	3
1. Summary of Maximum SAR Value	4
2. Description of Equipment Under Test	5
3. SAR Measurement System	6
3.1 Definition of Specific Absorption Rate (SAR)	6
3.2 SPEAG DASY6 System	6
3.2.1 Robot	7
3.2.2 Probes	8
3.2.3 Data Acquisition Electronics (DAE)	8
3.2.4 Phantoms	8
3.2.5 Device Holder	9
3.2.6 System Validation Dipoles	9
3.2.7 Tissue Simulating Liquids	10
3.3 SAR System Verification	13
3.4 SAR Measurement Procedure	14
3.4.1 Area & Zoom Scan Procedure	14
3.4.2 Volume Scan Procedure	14
3.4.3 Power Drift Monitoring	15
3.4.4 Spatial Peak SAR Evaluation	15
3.4.5 SAR Averaged Methods	15
4. SAR Measurement Evaluation	16
4.1 EUT Configuration and Setting	16
4.2 EUT Testing Position	20
4.2.1 Extremity Exposure Conditions	20
4.3 Tissue Verification	21
4.4 System Validation	21
4.5 System Verification	22
4.6 Maximum Output Power	23
4.6.1 Maximum Target Conducted Power	23
4.6.2 Measured Conducted Power Result	26
4.7 SAR Testing Results	28
4.7.1 SAR Test Reduction Considerations	28
4.7.2 SAR Results for Extremity Exposure Condition (Test Separation Distance is 0 mm)	30
4.7.3 SAR Measurement Variability	32
4.7.4 Simultaneous Multi-band Transmission Evaluation	32
5. Calibration of Test Equipment	35
6. Measurement Uncertainty	36
7. Information of the Testing Laboratories	37
Appendix A. SAR Plots of System Verification	
Appendix B. SAR Plots of SAR Measurement	
Appendix C. Calibration Certificate for Probe and Dipole	
Appendix D. Photographs of EUT and Setup	

1. Summary of Maximum SAR Value

Equipment Class	Mode	Highest SAR-10g Extremity Tested at 0 mm (W/kg)
PCB	GSM850	1.60
	GSM1900	1.89
	WCDMA II	3.21
	WCDMA V	1.61
DTS	2.4G WLAN	0.59
NII	5.3G WLAN	0.67
	5.6G WLAN	0.68
	5.8G WLAN	0.59
DSS	Bluetooth	0.09
DXX	NFC	N/A

Highest Simultaneous Transmission SAR	Highest SAR-10g Extremity Tested at 0 mm (W/kg)
	3.98

Note:

- The SAR criteria (**Head & Body: SAR-1g1.6 W/kg, and Extremity: SAR-10g 4.0 W/kg**) for general population/uncontrolled exposure is specified in FCC 47 CFR part 2 (2.1093) and ANSI/IEEE C95.1-1992.

2. Description of Equipment Under Test

EUT Type	Point of Sale Terminal
FCC ID	B32E2853GDB
Brand Name	Verifone
Model Name	e285 3G/BT/WiFi/DS/DB
Tx Frequency Bands (Unit: MHz)	GSM850 : 824.2 ~ 848.8 GSM1900 : 1850.2 ~ 1909.8 WCDMA Band II : 1852.4 ~ 1907.6 WCDMA Band V : 826.4 ~ 846.6 WLAN : 2412 ~ 2462, 5180 ~ 5240, 5260 ~ 5320, 5500 ~ 5700, 5745 ~ 5825 Bluetooth : 2402 ~ 2480 NFC : 13.56
Uplink Modulations	GSM & GPRS : GMSK EDGE : 8PSK WCDMA : QPSK 802.11b : DSSS 802.11a/g/n/ac : OFDM Bluetooth : GFSK, $\pi/4$ -DQPSK, 8-DPSK NFC : ASK
Maximum Tune-up Conducted Power (Unit: dBm)	Please refer to section 4.6.1 of this report
Antenna Type	WWAN: Fixed Internal Antenna WLAN/BT: PIFA Antenna
EUT Stage	Identical Prototype

Note:

1. This report is issued as a supplementary report to BV CPS report no.: SA170804C11. The difference compared with original report is changing BT/WLAN module for new application with new model. Therefore, only WWAN power was leveraged in this report. The BT/WLAN Power & SAR and WWAN SAR were retested.
2. The above EUT information is declared by manufacturer and for more detailed features description please refers to the manufacturer's specifications or User's Manual.

List of Accessory:

BT/WLAN Module	Brand Name	Murata
	Model Name	LBEH5HY1LC-981
WWAN Module	Brand Name	Gemalto
	Model Name	EHS6
Battery	Brand Name	Verifone
	Model Name	BPK087-600
	Power Rating	3.8 Vdc, 1800 mAh
	Type	Li-ion

3. SAR Measurement System

3.1 Definition of Specific Absorption Rate (SAR)

SAR is related to the rate at which energy is absorbed per unit mass in an object exposed to a radio field. The SAR distribution in a biological body is complicated and is usually carried out by experimental techniques or numerical modeling. The standard recommends limits for two tiers of groups, occupational/controlled and general population/uncontrolled, based on a person's awareness and ability to exercise control over his or her exposure. In general, occupational/controlled exposure limits are higher than the limits for general population/uncontrolled.

The SAR definition is the time derivative (rate) of the incremental energy (dW) absorbed by (dissipated in) an incremental mass (dm) contained in a volume element (dv) of a given density (ρ). The equation description is as below:

$$\text{SAR} = \frac{d}{dt} \left(\frac{dW}{dm} \right) = \frac{d}{dt} \left(\frac{dW}{\rho dv} \right)$$

SAR is expressed in units of Watts per kilogram (W/kg)

SAR measurement can be related to the electrical field in the tissue by

$$\text{SAR} = \frac{\sigma |E|^2}{\rho}$$

Where: σ is the conductivity of the tissue, ρ is the mass density of the tissue and E is the RMS electrical field strength.

3.2 SPEAG DASY6 System

DASY6 system consists of high precision robot, probe alignment sensor, phantom, robot controller, controlled measurement server and near-field probe. The robot includes six axes that can move to the precision position of the DASY6 software defined. The DASY6 software can define the area that is detected by the probe. The robot is connected to controlled box. Controlled measurement server is connected to the controlled robot box. The DAE includes amplifier, signal multiplexing, AD converter, offset measurement and surface detection. It is connected to the Electro-optical coupler (ECO). The ECO performs the conversion from the optical into digital electric signal of the DAE and transfers data to the PC.

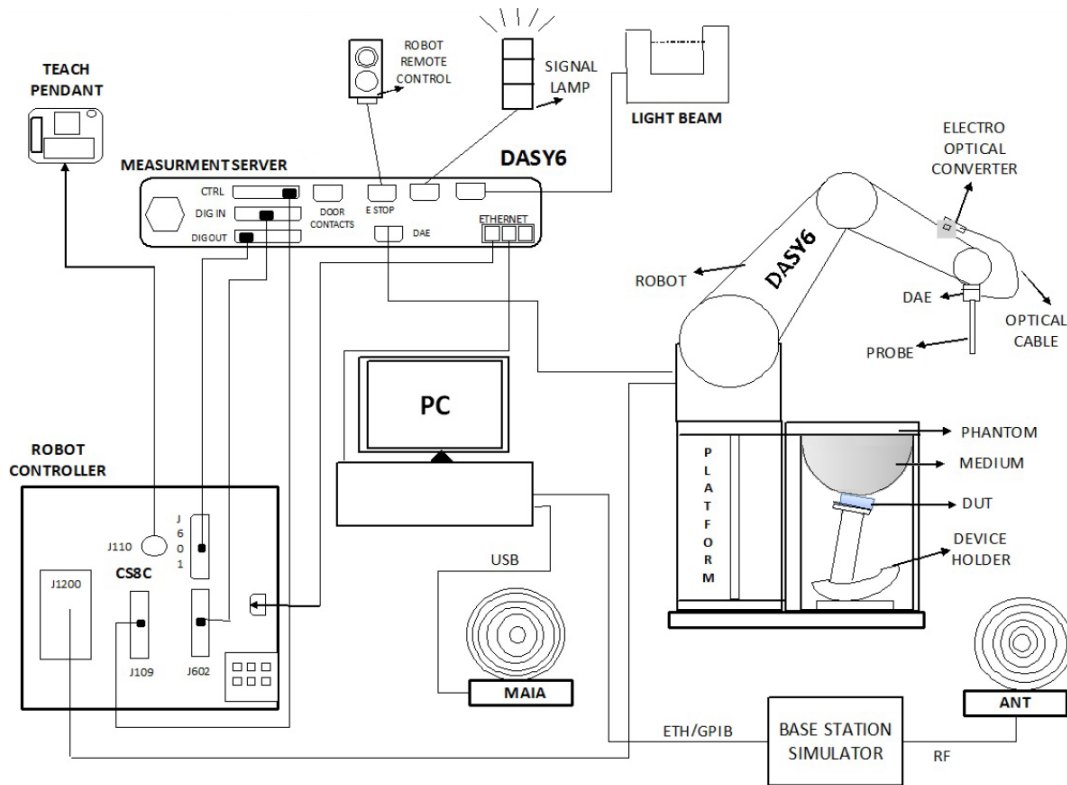

Fig-3.1 SPEAG DASY6 System Setup

3.2.1 Robot

The DASY6 systems use the high precision robots from Stäubli SA (France). For the 6-axis controller system, the robot controller version of CS8c from Stäubli is used. The Stäubli robot series have many features that are important for our application:

- High precision (repeatability ± 0.035 mm)
- High reliability (industrial design)
- Jerk-free straight movements
- Low ELF interference (the closed metallic construction shields against motor control fields)

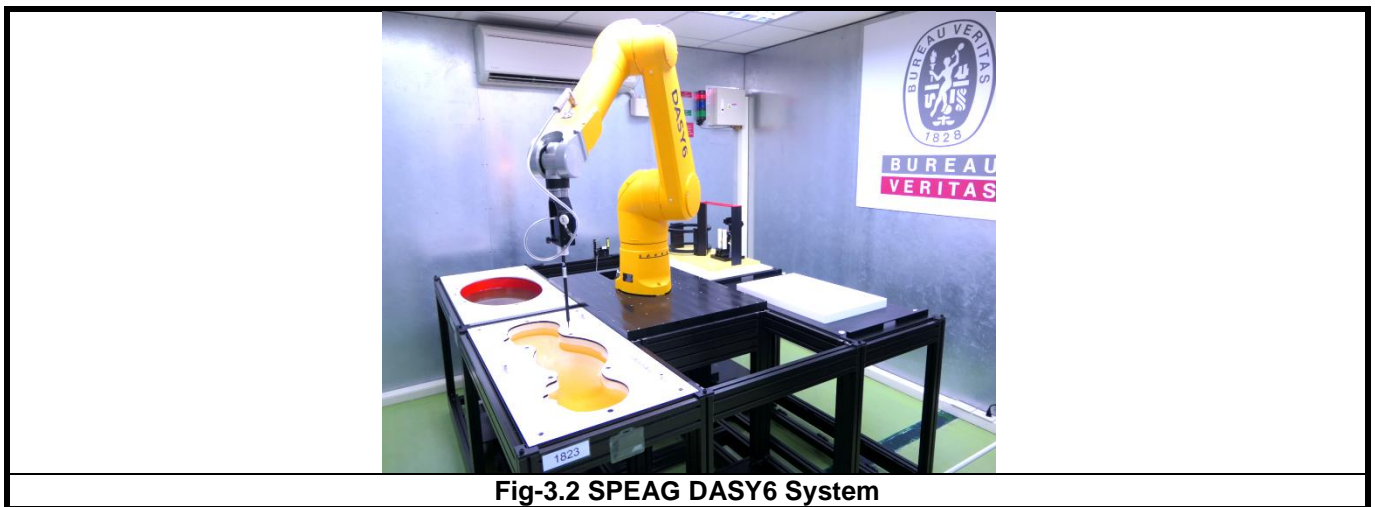



Fig-3.2 SPEAG DASY6 System

FCC SAR Test Report

3.2.2 Probes

The SAR measurement is conducted with the dosimetric probe. The probe is specially designed and calibrated for use in liquid with high permittivity. The dosimetric probe has special calibration in liquid at different frequency.

Model	EX3DV4	
Construction	Symmetrical design with triangular core. Built-in shielding against static charges. PEEK enclosure material (resistant to organic solvents, e.g., DGBE).	
Frequency	4 MHz to 10 GHz Linearity: ± 0.2 dB	
Directivity	± 0.1 dB in TSL (rotation around probe axis) ± 0.3 dB in TSL (rotation normal to probe axis)	
Dynamic Range	10 μ W/g to 100 mW/g Linearity: ± 0.2 dB (noise: typically < 1 μ W/g)	
Dimensions	Overall length: 337 mm (Tip: 20 mm) Tip diameter: 2.5 mm (Body: 12 mm) Typical distance from probe tip to dipole centers: 1 mm	

3.2.3 Data Acquisition Electronics (DAE)

Model	DAE3, DAE4	
Construction	Signal amplifier, multiplexer, A/D converter and control logic. Serial optical link for communication with DASY embedded system (fully remote controlled). Two step probe touch detector for mechanical surface detection and emergency robot stop.	
Measurement Range	-100 to +300 mV (16 bit resolution and two range settings: 4mV, 400mV)	
Input Offset Voltage	< 5 μ V (with auto zero)	
Input Bias Current	< 50 fA	
Dimensions	60 x 60 x 68 mm	

3.2.4 Phantoms

Model	Twin SAM	
Construction	The shell corresponds to the specifications of the Specific Anthropomorphic Mannequin (SAM) phantom defined in IEEE 1528 and IEC 62209-1. It enables the dosimetric evaluation of left and right hand phone usage as well as body mounted usage at the flat phantom region. A cover prevents evaporation of the liquid. Reference markings on the phantom allow the complete setup of all predefined phantom positions and measurement grids by teaching three points with the robot.	
Material	Vinylester, glass fiber reinforced (VE-GF)	
Shell Thickness	2 \pm 0.2 mm (6 \pm 0.2 mm at ear point)	
Dimensions	Length: 1000 mm Width: 500 mm Height: adjustable feet	
Filling Volume	approx. 25 liters	

FCC SAR Test Report

Model	ELI	
Construction	Phantom for compliance testing of handheld and body-mounted wireless devices in the frequency range of 30 MHz to 6 GHz. ELI is fully compatible with the IEC 62209-2 standard and all known tissue simulating liquids. ELI has been optimized regarding its performance and can be integrated into our standard phantom tables. A cover prevents evaporation of the liquid. Reference markings on the phantom allow installation of the complete setup, including all predefined phantom positions and measurement grids, by teaching three points. The phantom is compatible with all SPEAG dosimetric probes and dipoles.	
Material	Vinylester, glass fiber reinforced (VE-GF)	
Shell Thickness	2.0 ± 0.2 mm (bottom plate)	
Dimensions	Major axis: 600 mm Minor axis: 400 mm	
Filling Volume	approx. 30 liters	

3.2.5 Device Holder

Model	Mounting Device	
Construction	In combination with the Twin SAM Phantom or ELI4, the Mounting Device enables the rotation of the mounted transmitter device in spherical coordinates. Rotation point is the ear opening point. Transmitter devices can be easily and accurately positioned according to IEC, IEEE, FCC or other specifications. The device holder can be locked for positioning at different phantom sections (left head, right head, flat).	
Material	POM	

Model	Laptop Extensions Kit	
Construction	Simple but effective and easy-to-use extension for Mounting Device that facilitates the testing of larger devices according to IEC 62209-2 (e.g., laptops, cameras, etc.). It is lightweight and fits easily on the upper part of the Mounting Device in place of the phone positioner.	
Material	POM, Acrylic glass, Foam	

3.2.6 System Validation Dipoles

Model	D-Serial	
Construction	Symmetrical dipole with 1/4 balun. Enables measurement of feedpoint impedance with NWA. Matched for use near flat phantoms filled with tissue simulating solutions.	
Frequency	750 MHz to 5800 MHz	
Return Loss	> 20 dB	
Power Capability	> 100 W (f < 1GHz), > 40 W (f > 1GHz)	

3.2.7 Tissue Simulating Liquids

For SAR measurement of the field distribution inside the phantom, the phantom must be filled with homogeneous tissue simulating liquid to a depth of at least 15 cm. For head SAR testing, the liquid height from the ear reference point (ERP) of the phantom to the liquid top surface is larger than 15 cm. For body SAR testing, the liquid height from the center of the flat phantom to the liquid top surface is larger than 15 cm. The nominal dielectric values of the tissue simulating liquids in the phantom and the tolerance of 5% are listed in Table-3.1.

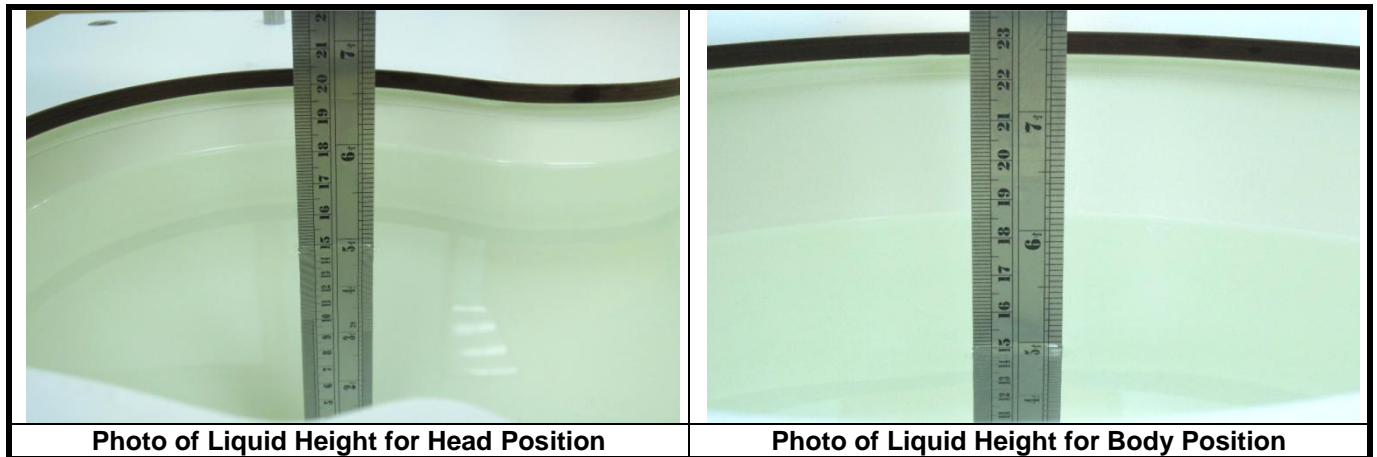

The dielectric properties of the head tissue simulating liquids are defined in IEEE1528, and KDB 865664 D01 Appendix A. For the body tissue simulating liquids, the dielectric properties are defined in KDB 865664 D01 Appendix A. The dielectric properties of the tissue simulating liquids were verified prior to the SAR evaluation using a dielectric assessment kit and a network analyzer.

Table-3.1 Targets of Tissue Simulating Liquid

Frequency (MHz)	Target Permittivity	Range of $\pm 5\%$	Target Conductivity	Range of $\pm 5\%$
For Head				
750	41.9	39.8 ~ 44.0	0.89	0.85 ~ 0.93
835	41.5	39.4 ~ 43.6	0.90	0.86 ~ 0.95
900	41.5	39.4 ~ 43.6	0.97	0.92 ~ 1.02
1450	40.5	38.5 ~ 42.5	1.20	1.14 ~ 1.26
1640	40.3	38.3 ~ 42.3	1.29	1.23 ~ 1.35
1750	40.1	38.1 ~ 42.1	1.37	1.30 ~ 1.44
1800	40.0	38.0 ~ 42.0	1.40	1.33 ~ 1.47
1900	40.0	38.0 ~ 42.0	1.40	1.33 ~ 1.47
2000	40.0	38.0 ~ 42.0	1.40	1.33 ~ 1.47
2300	39.5	37.5 ~ 41.5	1.67	1.59 ~ 1.75
2450	39.2	37.2 ~ 41.2	1.80	1.71 ~ 1.89
2600	39.0	37.1 ~ 41.0	1.96	1.86 ~ 2.06
3500	37.9	36.0 ~ 39.8	2.91	2.76 ~ 3.06
5200	36.0	34.2 ~ 37.8	4.66	4.43 ~ 4.89
5300	35.9	34.1 ~ 37.7	4.76	4.52 ~ 5.00
5500	35.6	33.8 ~ 37.4	4.96	4.71 ~ 5.21
5600	35.5	33.7 ~ 37.3	5.07	4.82 ~ 5.32
5800	35.3	33.5 ~ 37.1	5.27	5.01 ~ 5.53
For Body				
750	55.5	52.7 ~ 58.3	0.96	0.91 ~ 1.01
835	55.2	52.4 ~ 58.0	0.97	0.92 ~ 1.02
900	55.0	52.3 ~ 57.8	1.05	1.00 ~ 1.10
1450	54.0	51.3 ~ 56.7	1.30	1.24 ~ 1.37
1640	53.8	51.1 ~ 56.5	1.40	1.33 ~ 1.47
1750	53.4	50.7 ~ 56.1	1.49	1.42 ~ 1.56
1800	53.3	50.6 ~ 56.0	1.52	1.44 ~ 1.60
1900	53.3	50.6 ~ 56.0	1.52	1.44 ~ 1.60
2000	53.3	50.6 ~ 56.0	1.52	1.44 ~ 1.60
2300	52.9	50.3 ~ 55.5	1.81	1.72 ~ 1.90
2450	52.7	50.1 ~ 55.3	1.95	1.85 ~ 2.05
2600	52.5	49.9 ~ 55.1	2.16	2.05 ~ 2.27
3500	51.3	48.7 ~ 53.9	3.31	3.14 ~ 3.48
5200	49.0	46.6 ~ 51.5	5.30	5.04 ~ 5.57
5300	48.9	46.5 ~ 51.3	5.42	5.15 ~ 5.69
5500	48.6	46.2 ~ 51.0	5.65	5.37 ~ 5.93
5600	48.5	46.1 ~ 50.9	5.77	5.48 ~ 6.06
5800	48.2	45.8 ~ 50.6	6.00	5.70 ~ 6.30

FCC SAR Test Report

The following table gives the recipes for tissue simulating liquids.

Table-3.2 Recipes of Tissue Simulating Liquid

Tissue Type	Bactericide	DGBE	HEC	NaCl	Sucrose	Triton X-100	Water	Diethylene Glycol Mono-hexylether
H750	0.2	-	0.2	1.5	56.0	-	42.1	-
H835	0.2	-	0.2	1.5	57.0	-	41.1	-
H900	0.2	-	0.2	1.4	58.0	-	40.2	-
H1450	-	43.3	-	0.6	-	-	56.1	-
H1640	-	45.8	-	0.5	-	-	53.7	-
H1750	-	47.0	-	0.4	-	-	52.6	-
H1800	-	44.5	-	0.3	-	-	55.2	-
H1900	-	44.5	-	0.2	-	-	55.3	-
H2000	-	44.5	-	0.1	-	-	55.4	-
H2300	-	44.9	-	0.1	-	-	55.0	-
H2450	-	45.0	-	0.1	-	-	54.9	-
H2600	-	45.1	-	0.1	-	-	54.8	-
H3500	-	8.0	-	0.2	-	20.0	71.8	-
H5G	-	-	-	-	-	17.2	65.5	17.3
B750	0.2	-	0.2	0.8	48.8	-	50.0	-
B835	0.2	-	0.2	0.9	48.5	-	50.2	-
B900	0.2	-	0.2	0.9	48.2	-	50.5	-
B1450	-	34.0	-	0.3	-	-	65.7	-
B1640	-	32.5	-	0.3	-	-	67.2	-
B1750	-	31.0	-	0.2	-	-	68.8	-
B1800	-	29.5	-	0.4	-	-	70.1	-
B1900	-	29.5	-	0.3	-	-	70.2	-
B2000	-	30.0	-	0.2	-	-	69.8	-
B2300	-	31.0	-	0.1	-	-	68.9	-
B2450	-	31.4	-	0.1	-	-	68.5	-
B2600	-	31.8	-	0.1	-	-	68.1	-
B3500	-	28.8	-	0.1	-	-	71.1	-
B5G	-	-	-	-	-	10.7	78.6	10.7

3.3 SAR System Verification

The system check verifies that the system operates within its specifications. It is performed daily or before every SAR measurement. The system check uses normal SAR measurements in the flat section of the phantom with a matched dipole at a specified distance. The system verification setup is shown as below.

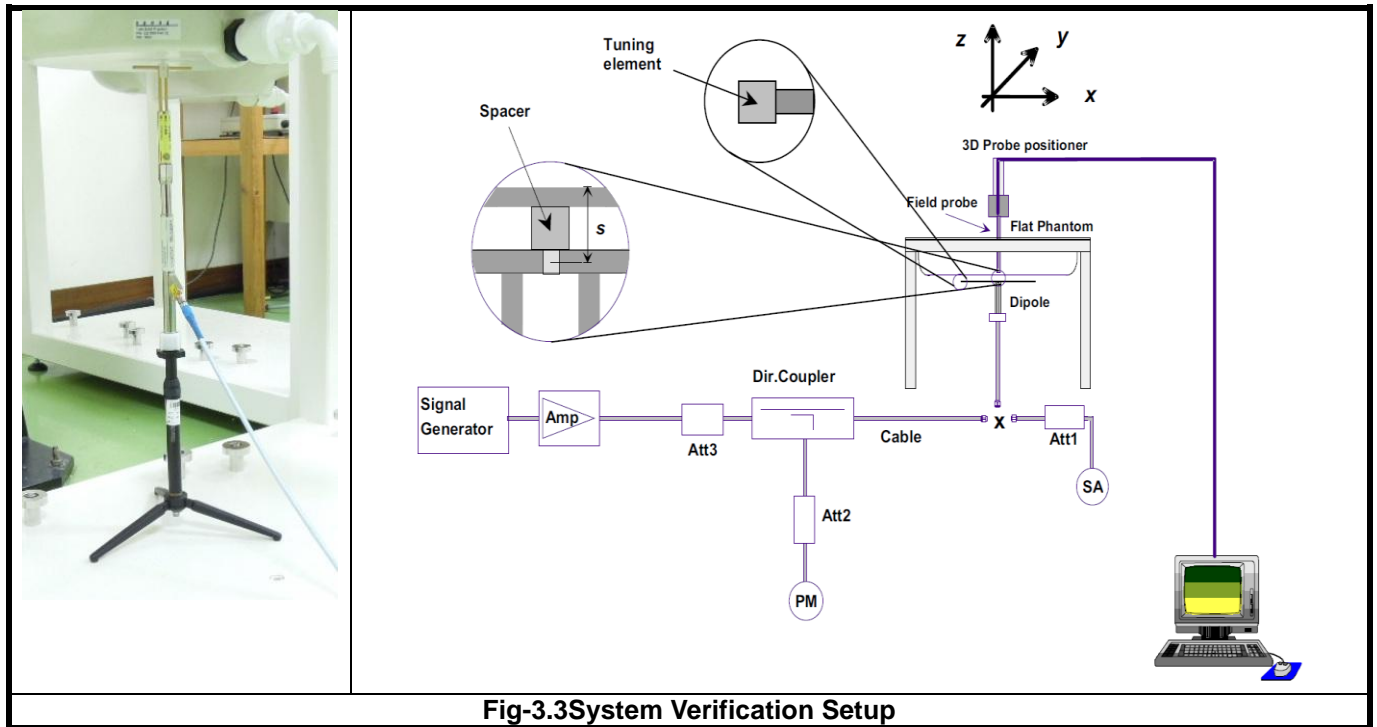

Fig-3.3 System Verification Setup

The validation dipole is placed beneath the flat phantom with the specific spacer in place. The distance spacer is touch the phantom surface with a light pressure at the reference marking and be oriented parallel to the long side of the phantom. The spectrum analyzer measures the forward power at the location of the system check dipole connector. The signal generator is adjusted for the desired forward power (250 mW is used for 700 MHz to 3 GHz, 100 mW is used for 3.5 GHz to 6 GHz) at the dipole connector and the power meter is read at that level. After connecting the cable to the dipole, the signal generator is readjusted for the same reading at power meter.

After system check testing, the SAR result will be normalized to 1W forward input power and compared with the reference SAR value derived from validation dipole certificate report. The deviation of system check should be within 10 %.

3.4 SAR Measurement Procedure

According to the SAR test standard, the recommended procedure for assessing the peak spatial-average SAR value consists of the following steps:

- (a) Power reference measurement
- (b) Area scan
- (c) Zoom scan
- (d) Power drift measurement

The SAR measurement procedures for each of test conditions are as follows:

- (a) Make EUT to transmit maximum output power
- (b) Measure conducted output power through RF cable
- (c) Place the EUT in the specific position of phantom
- (d) Perform SAR testing steps on the DASY system
- (e) Record the SAR value

3.4.1 Area & Zoom Scan Procedure

First Area Scan is used to locate the approximate location(s) of the local peak SAR value(s). The measurement grid within an Area Scan is defined by the grid extent, grid step size and grid offset. Next, in order to determine the EM field distribution in a three-dimensional spatial extension, Zoom Scan is required. The Zoom Scan is performed around the highest E-field value to determine the averaged SAR-distribution over 10 g. According to KDB 865664D01, the resolution for Area and Zoom scan is specified in the table below.

Items	<= 2 GHz	2-3 GHz	3-4 GHz	4-5 GHz	5-6 GHz
Area Scan ($\Delta x, \Delta y$)	<= 15 mm	<= 12 mm	<= 12 mm	<= 10 mm	<= 10 mm
Zoom Scan ($\Delta x, \Delta y$)	<= 8 mm	<= 5 mm	<= 5 mm	<= 4 mm	<= 4 mm
Zoom Scan (Δz)	<= 5 mm	<= 5 mm	<= 4 mm	<= 3 mm	<= 2 mm
Zoom Scan Volume	>= 30 mm	>= 30 mm	>= 28 mm	>= 25 mm	>= 22 mm

Note:

When zoom scan is required and report SAR is <=1.4 W/kg, the zoom scan resolution of $\Delta x / \Delta y$ (2-3GHz: <= 8 mm, 3-4GHz: <= 7 mm, 4-6GHz: <= 5 mm) may be applied.

3.4.2 Volume Scan Procedure

The volume scan is used for assess overlapping SAR distributions for antennas transmitting in different frequency bands. It is equivalent to an oversized zoom scan used in standalone measurements. The measurement volume will be used to enclose all the simultaneous transmitting antennas. For antennas transmitting simultaneously in different frequency bands, the volume scan is measured separately in each frequency band. In order to sum correctly to compute the 1g aggregate SAR, the EUT remain in the same test position for all measurements and all volume scan use the same spatial resolution and grid spacing. When all volume scan were completed, the software, SEMCAD postprocessor can combine and subsequently superpose these measurement data to calculating the multiband SAR.

3.4.3 Power Drift Monitoring

All SAR testing is under the EUT install full charged battery and transmit maximum output power. In DASYS measurement software, the power reference measurement and power drift measurement procedures are used for monitoring the power drift of EUT during SAR test. Both these procedures measure the field at a specified reference position before and after the SAR testing. The software will calculate the field difference in dB. If the power drift more than 5%, the SAR will be retested.

3.4.4 Spatial Peak SAR Evaluation

The procedure for spatial peak SAR evaluation has been implemented according to the test standard. It can be conducted for 1g and 10g, as well as for user-specific masses. The DASYS software includes all numerical procedures necessary to evaluate the spatial peak SAR value.

The base for the evaluation is a "cube" measurement. The measured volume must include the 1g and 10g cubes with the highest averaged SAR values. For that purpose, the center of the measured volume is aligned to the interpolated peak SAR value of a previously performed area scan.

The entire evaluation of the spatial peak values is performed within the post-processing engine (SEMCAD). The system always gives the maximum values for the 1g and 10g cubes. The algorithm to find the cube with highest averaged SAR is divided into the following stages:

- (a) Extraction of the measured data (grid and values) from the Zoom Scan
- (b) Calculation of the SAR value at every measurement point based on all stored data (A/D values and measurement parameters)
- (c) Generation of a high-resolution mesh within the measured volume
- (d) Interpolation of all measured values from the measurement grid to the high-resolution grid
- (e) Extrapolation of the entire 3-D field distribution to the phantom surface over the distance from sensor to surface
- (f) Calculation of the averaged SAR within masses of 1g and 10g

3.4.5 SAR Averaged Methods

In DASYS, the interpolation and extrapolation are both based on the modified Quadratic Shepard's method. The interpolation scheme combines a least-square fitted function method and a weighted average method which are the two basic types of computational interpolation and approximation.

Extrapolation routines are used to obtain SAR values between the lowest measurement points and the inner phantom surface. The extrapolation distance is determined by the surface detection distance and the probe sensor offset. The uncertainty increases with the extrapolation distance. To keep the uncertainty within 1% for the 1 g and 10 g cubes, the extrapolation distance should not be larger than 5 mm.

4. SAR Measurement Evaluation

4.1 EUT Configuration and Setting

<Connections between EUT and System Simulator>

For WWAN SAR testing, the EUT was linked and controlled by base station emulator. Communication between the EUT and the emulator was established by air link. The distance between the EUT and the communicating antenna of the emulator is larger than 50 cm and the output power radiated from the emulator antenna is at least 30 dB smaller than the output power of EUT. The EUT was set from the emulator to radiate maximum output power during SAR testing.

<Considerations Related to GSM / GPRS / EDGE for Setup and Testing>

The maximum multi-slot capability supported by this device is as below.

1. This EUT is class B device
2. This EUT supports GPRS multi-slot class 12 (max. uplink: 4, max. downlink: 4, total timeslots: 5)
3. This EUT supports EDGE multi-slot class 12 (max. uplink: 4, max. downlink: 4, total timeslots: 5)

For GSM850 frequency band, the power control level is set to 5 for GSM mode and GPRS (GMSK: CS1), and set to 8 for EDGE (GMSK: MCS1, 8PSK: MCS9). For GSM1900 frequency band, the power control level is set to 0 for GSM mode and GPRS (GMSK: CS1), and set to 2 for EDGE (GMSK: MCS1, 8PSK: MCS9).

SAR test reduction for GPRS and EDGE modes is determined by the source-based time-averaged output power specified for production units, including tune-up tolerance. The data mode with highest specified time-averaged output power should be tested for SAR compliance in the applicable exposure conditions. For modes with the same specified maximum output power and tolerance, the higher number time-slot configuration should be tested.

<Considerations Related to WCDMA for Setup and Testing>

Release 5 HSDPA Data Devices

The 3G SAR test reduction procedure is applied to body SAR with 12.2 kbps RMC as the primary mode. Otherwise, body SAR for HSDPA is measured using an FRC with H-Set 1 in Sub-test 1 and a 12.2 kbps RMC configured in Test Loop Mode 1, for the highest reported SAR configuration in 12.2 kbps RMC without HSDPA. HSDPA is configured according to the applicable UE category of a test device. The number of HS-DSCH/HS-PDSCHs, HARQ processes, minimum inter-TTI interval, transport block sizes and RV coding sequence are defined by the H-set. To maintain a consistent test configuration and stable transmission conditions, QPSK is used in the H-set for SAR testing. HS-DPCCH should be configured with a CQI feedback cycle of 4 ms and a CQI repetition factor of 2 to maintain a constant rate of active CQI slots. DPCCH and DPDCH gain factors (β_c , β_d), and HS-DPCCH power offset parameters (Δ_{ACK} , Δ_{NACK} , Δ_{CQI}) are set according to values indicated in below. The CQI value is determined by the UE category, transport block size, number of HS-PDSCHs and modulation used in the H-set.

Sub-test	β_c	β_d	β_d (SF)	β_d/β_c	$\beta_{HS}^{(1)(2)}$	CM ⁽³⁾ (dB)	MPR ⁽³⁾ (dB)
1	2/15	15/15	64	2/15	4/15	0.0	0.0
2	12/15 ⁽⁴⁾	15/15 ⁽⁴⁾	64	12/15 ⁽⁴⁾	24/15	1.0	0.0
3	15/15	8/15	64	15/8	30/15	1.5	0.5
4	15/15	4/15	64	15/4	30/15	1.5	0.5

Note 1: Δ_{ACK} , Δ_{NACK} and $\Delta_{CQI} = 30/15$ with $\beta_{HS} = 30/15 * \beta_c$.
 Note 2: For the HS-DPCCH power mask requirement test in clause 5.2C, 5.7A, and the Error Vector Magnitude (EVM) with HS-DPCCH test in clause 5.13.1A, and HSDPA EVM with phase discontinuity in clause 5.13.1AA, Δ_{ACK} and $\Delta_{NACK} = 30/15$ with $\beta_{HS} = 30/15 * \beta_c$, and $\Delta_{CQI} = 24/15$ with $\beta_{HS} = 24/15 * \beta_c$.
 Note 3: CM = 1 for $\beta_d/\beta_c = 12/15$, $\beta_{HS}/\beta_c = 24/15$. For all other combinations of DPDCH, DPCCH and HS-DPCCH the MPR is based on the relative CM difference. This is applicable for only UEs that support HSDPA in release 6 and later releases.
 Note 4: For subtest 2 the β_d/β_c ratio of 12/15 for the TFC during the measurement period (TF1, TF0) is achieved by setting the signalled gain factors for the reference TFC (TF1, TF0) to $\beta_c = 11/15$ and $\beta_d = 15/15$.

Release 6 HSUPA Data Devices

The 3G SAR test reduction procedure is applied to body SAR with 12.2 kbps RMC as the primary mode. Otherwise, body SAR for HSPA is measured with E-DCH Sub-test 5, using H-Set 1 and QPSK for FRC and a 12.2 kbps RMC configured in Test Loop Mode 1 and power control algorithm 2, according to the highest reported body SAR configuration in 12.2 kbps RMC without HSPA. When VOIP applies to head exposure, the 3G SAR test reduction procedure is applied with 12.2 kbps RMC as the primary mode. Otherwise, the same HSPA configuration used for body SAR measurements are applied to head exposure testing. Due to inner loop power control requirements in HSPA, a communication test set is required for output power and SAR tests. The 12.2 kbps RMC, FRC H-set 1 and E-DCH configurations for HSPA are configured according to the β values indicated in below.

FCC SAR Test Report

Sub-test	β_c	β_d	β_d (SF)	β_c/β_d	$\beta_{HS}^{(1)}$	β_{ec}	$\beta_{ed}^{(4/5)}$	β_{ed} (SF)	β_{ed} (Codes)	CM ⁽²⁾ (dB)	MPR ^(2/6) (dB)	AG ⁽⁵⁾ Index	E-TFCI
1	11/15 ⁽³⁾	15/15 ⁽³⁾	64	11/15 ⁽³⁾	22/15	209/225	1309/225	4	1	1.0	0.0	20	75
2	6/15	15/15	64	6/15	12/15	12/15	94/75	4	1	3.0	2.0	12	67
3	15/15	9/15	64	15/9	30/15	30/15	$\beta_{ed1}: 47/15$ $\beta_{ed2}: 47/15$	4 4	2	2.0	1.0	15	92
4	2/15	15/15	64	2/15	4/15	2/15	56/75	4	1	3.0	2.0	17	71
5	15/15	0	-	-	5/15	5/15	47/15	4	1	1.0	0.0	12	67

Note 1: For sub-test 1 to 4, Δ_{ACK} , Δ_{NACK} and $\Delta_{CQI} = 30/15$ with $\beta_{HS} = 30/15 * \beta_c$. For sub-test 5, Δ_{ACK} , Δ_{NACK} and $\Delta_{CQI} = 5/15$ with $\beta_{HS} = 5/15 * \beta_c$.
Note 2: CM = 1 for $\beta_c/\beta_d = 12/15$, $\beta_{HS}\beta_c = 24/15$. For all other combinations of DPDCH, DPCCH, HS-DPCCH, E-DPDCH and E-DPCCH the MPR is based on the relative CM difference.
Note 3: For subtest 1 the β_c/β_d ratio of 11/15 for the TFC during the measurement period (TF1, TF0) is achieved by setting the signalled gain factors for the reference TFC (TF1, TF1) to $\beta_c = 10/15$ and $\beta_d = 15/15$.
Note 4: In case of testing by UE using E-DPDCH Physical Layer category 1, Sub-test 3 is omitted according to TS25.306 Table 5.1g.
Note 5: β_{ed} can not be set directly; it is set by Absolute Grant Value.
Note 6: For subtests 2, 3 and 4, UE may perform E-DPDCH power scaling at max power which could result in slightly smaller MPR values.

<Considerations Related to WLAN for Setup and Testing>

In general, various vendor specific external test software and chipset based internal test modes are typically used for SAR measurement. These chipset based test mode utilities are generally hardware and manufacturer dependent, and often include substantial flexibility to reconfigure or reprogram a device. A Wi-Fi device must be configured to transmit continuously at the required data rate, channel bandwidth and signal modulation, using the highest transmission duty factor supported by the test mode tools for SAR measurement. The test frequencies established using test mode must correspond to the actual channel frequencies. When 802.11 frame gaps are accounted for in the transmission, a maximum transmission duty factor of 92 - 96% is typically achievable in most test mode configurations. A minimum transmission duty factor of 85% is required to avoid certain hardware and device implementation issues related to wide range SAR scaling. In addition, a periodic transmission duty factor is required for current generation SAR systems to measure SAR correctly. The reported SAR must be scaled to 100% transmission duty factor to determine compliance at the maximum tune-up tolerance limit.

According to KDB 248227 D01, this device has installed WLAN engineering testing software which can provide continuous transmitting RF signal. During WLAN SAR testing, this device was operated to transmit continuously at the maximum transmission duty with specified transmission mode, operating frequency, lowest data rate, and maximum output power.

Initial Test Configuration

An initial test configuration is determined for OFDM transmission modes in 2.4 GHz and 5 GHz bands according to the channel bandwidth, modulation and data rate combination(s) with the highest maximum output power specified for production units in each standalone and aggregated frequency band. When the same maximum power is specified for multiple transmission modes in a frequency band, the largest channel bandwidth, lowest order modulation, lowest data rate and lowest order 802.11a/g/n/ac mode is used for SAR measurement, on the highest measured output power channel in the initial test configuration, for each frequency band.

Subsequent Test Configuration

SAR measurement requirements for the remaining 802.11 transmission mode configurations that have not been tested in the initial test configuration are determined separately for each standalone and aggregated frequency band, in each exposure condition, according to the maximum output power specified for production units. Additional power measurements may be required to determine if SAR measurements are required for subsequent highest output power channels in a subsequent test configuration. When the highest reported SAR for the initial test configuration according to the initial test position or fixed exposure position requirements, is adjusted by the ratio of the subsequent test configuration to initial test configuration specified maximum output power and the adjusted SAR is ≤ 1.2 W/kg, SAR is not required for that subsequent test configuration.

SAR Test Configuration and Channel Selection

When multiple channel bandwidth configurations in a frequency band have the same specified maximum output power, the initial test configuration is using largest channel bandwidth, lowest order modulation, lowest data rate, and lowest order 802.11 mode (i.e., 802.11a is chosen over 802.11n then 802.11ac or 802.11g is chosen over 802.11n). After an initial test configuration is determined, if multiple test channels have the same measured maximum output power, the channel chosen for SAR measurement is determined according to the following.

- 1) The channel closest to mid-band frequency is selected for SAR measurement.
- 2) For channels with equal separation from mid-band frequency; for example, high and low channels or two mid-band channels, the higher frequency (number) channel is selected for SAR measurement.

Test Reduction for U-NII-1 (5.2 GHz) and U-NII-2A (5.3 GHz) Bands

For devices that operate in both U-NII bands using the same transmitter and antenna(s), SAR test reduction is determined according to the following.

- 1) When the same maximum output power is specified for both bands, begin SAR measurement in U-NII-2A band by applying the OFDM SAR requirements. If the highest reported SAR for a test configuration is ≤ 1.2 W/kg, SAR is not required for U-NII-1 band for that configuration (802.11 mode and exposure condition).
- 2) When different maximum output power is specified for the bands, begin SAR measurement in the band with higher specified maximum output power. The highest reported SAR for the tested configuration is adjusted by the ratio of lower to higher specified maximum output power for the two bands. When the adjusted SAR is ≤ 1.2 W/kg, SAR is not required for the band with lower maximum output power in that test configuration.

<Considerations Related to Bluetooth for Setup and Testing>

This device has installed Bluetooth engineering testing software which can provide continuous transmitting RF signal. During Bluetooth SAR testing, this device was operated to transmit continuously at the maximum transmission duty with specified transmission mode, operating frequency, lowest data rate, and maximum output power.

The Bluetooth call box has been used during SAR measurement and the EUT was set to DH5 mode at the maximum output power. Its duty factor was calculated as below and the measured SAR for Bluetooth would be scaled to the 100% transmission duty factor to determine compliance.

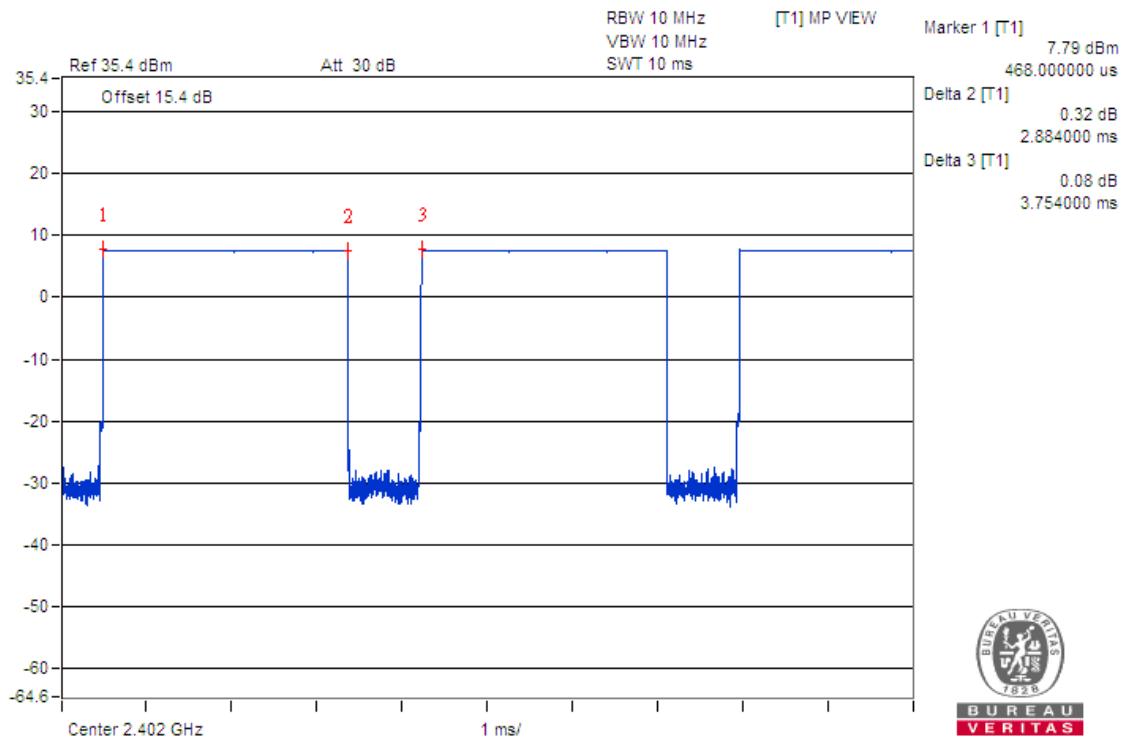

The duty factor of Bluetooth signal has been calculated as following.

$$\text{Duty Factor} = \text{Pulse Width} / \text{Total Period} = 2.884 / 3.754 = 76.80 \%$$

4.2 EUT Testing Position

4.2.1 Extremity Exposure Conditions

Extremity SAR evaluation was tested in Front Face, Rear Face, Left Side, and Top Side of the EUT with phantom 0 cm gap for WWAN antenna. And Front Face, Rear Face, Right Side, and Bottom Side of the EUT with phantom 0 cm gap for WLAN antenna.

FCC SAR Test Report

4.3 Tissue Verification

The measuring results for tissue simulating liquid are shown as below.

Test Date	Tissue Type	Frequency (MHz)	Liquid Temp. (°C)	Measured Conductivity (σ)	Measured Permittivity (ϵ_r)	Target Conductivity (σ)	Target Permittivity (ϵ_r)	Conductivity Deviation (%)	Permittivity Deviation (%)
Sep. 05, 2019	Head	835	23.3	0.926	42.011	0.9	41.5	2.89	1.23
Sep. 05, 2019	Head	1900	23.3	1.454	40.464	1.4	40	3.86	1.16
Sep. 06, 2019	Head	2450	23.3	1.87	39.051	1.8	39.2	3.89	-0.38
Sep. 09, 2019	Head	2450	23.1	1.881	38.379	1.8	39.2	4.50	-2.09
Sep. 09, 2019	Head	5250	23.1	4.703	36.115	4.71	35.9	-0.15	0.59
Sep. 09, 2019	Head	5600	23.1	5.129	35.495	5.07	35.5	1.16	-0.01
Sep. 09, 2019	Head	5750	23.1	5.303	35.218	5.22	35.4	1.59	-0.51

Note:

The dielectric properties of the tissue simulating liquid must be measured within 24 hours before the SAR testing and within $\pm 5\%$ of the target values. Liquid temperature during the SAR testing must be within ± 2 °C.

4.4 System Validation

The SAR measurement system was validated according to procedures in KDB 865664 D01. The validation status in tabulated summary is as below.

Test Date	Probe S/N	Calibration Point		Measured Conductivity (σ)	Measured Permittivity (ϵ_r)	Validation for CW			Validation for Modulation		
						Sensitivity Range	Probe Linearity	Probe Isotropy	Modulation Type	Duty Factor	PAR
Sep. 05, 2019	7537	Head	835	0.926	42.011	Pass	Pass	Pass	GMSK	Pass	N/A
Sep. 05, 2019	7537	Head	1900	1.454	40.464	Pass	Pass	Pass	GMSK	Pass	N/A
Sep. 06, 2019	3971	Head	2450	1.87	39.051	OFDM	N/A	Pass	OFDM	N/A	Pass
Sep. 09, 2019	3971	Head	2450	1.881	38.379	OFDM	N/A	Pass	OFDM	N/A	Pass
Sep. 09, 2019	3971	Head	5250	4.703	36.113	OFDM	N/A	Pass	OFDM	N/A	Pass
Sep. 09, 2019	3971	Head	5600	5.129	35.495	OFDM	N/A	Pass	OFDM	N/A	Pass
Sep. 09, 2019	3971	Head	5750	5.303	35.218	OFDM	N/A	Pass	OFDM	N/A	Pass

4.5 System Verification

The measuring result for system verification is tabulated as below.

Test Date	Mode	Frequency (MHz)	1W Target SAR-10g (W/kg)	Measured SAR-10g (W/kg)	Normalized to 1W SAR-10g (W/kg)	Deviation (%)	Dipole S/N	Probe S/N	DAE S/N
Sep. 05, 2019	Head	835	6.13	1.48	5.92	-3.43	4d092	7537	1585
Sep. 05, 2019	Head	1900	20.90	5.15	20.60	-1.44	5d036	7537	1585
Sep. 06, 2019	Head	2450	24.90	5.81	23.24	-6.67	835	3971	1431
Sep. 09, 2019	Head	2450	24.90	6.05	24.20	-2.81	835	3971	1431
Sep. 09, 2019	Head	5250	23.20	2.4	24.00	3.45	1019	3971	1431
Sep. 09, 2019	Head	5600	24.50	2.33	23.30	-4.90	1019	3971	1431
Sep. 09, 2019	Head	5750	23.20	2.18	21.80	-6.03	1019	3971	1431

Note:

Comparing to the reference SAR value provided by SPEAG, the validation data should be within its specification of 10 %. The result indicates the system check can meet the variation criterion and the plots can be referred to Appendix A of this report.

4.6 Maximum Output Power

4.6.1 Maximum Target Conducted Power

The maximum conducted average power (Unit: dBm) including tune-up tolerance is shown as below.

Mode	Maximum Burst-Averaged Output Power		Maximum Frame-Averaged Output Power	
	GSM850	GSM1900	GSM850	GSM1900
GSM (GMSK, 1Tx-slot)	33.0	30.0	24.0	21.0
GPRS (GMSK, 1Tx-slot)	32.5	30.0	23.5	21.0
GPRS (GMSK, 2Tx-slot)	30.0	27.0	24.0	21.0
GPRS (GMSK, 3Tx-slot)	28.0	25.5	23.7	21.2
GPRS (GMSK, 4Tx-slot)	27.0	24.0	24.0	21.0
EDGE (8PSK, 1Tx-slot)	27.0	26.0	18.0	17.0
EDGE (8PSK, 2Tx-slot)	24.0	23.0	18.0	17.0
EDGE (8PSK, 3Tx-slot)	22.0	21.0	17.7	16.7
EDGE (8PSK, 4Tx-slot)	21.0	20.0	18.0	17.0

Note:

1. SAR testing was performed on the maximum frame-averaged power mode.
2. The frame-averaged power is linearly proportion to the slot number configured and it is linearly scaled the maximum burst-averaged power based on time slots. The calculated method is shown as below:

$$\text{Frame-averaged power} = 10 \times \log (\text{Burst-averaged power mW} \times \text{Slot used} / 8)$$

Mode	WCDMA Band II	WCDMA Band V
RMC 12.2K	24.0	24.0
HSDPA / HSUPA / DC-HSDPA	24.0	24.0

<WLAN 2.4G>

Mode	Channel	Frequency (MHz)	Tune-up Power
802.11b	1	2412	17.0
	6	2437	17.0
	11	2462	17.0
802.11g	1	2412	14.5
	6	2437	14.5
	11	2462	14.5
802.11n (HT20)	1	2412	14.0
	6	2437	14.0
	11	2462	14.0

FCC SAR Test Report

<WLAN 5.2G>

Mode	Channel	Frequency (MHz)	Tune-up Power
802.11a	36	5180	13.0
	40	5200	13.0
	44	5220	13.0
	48	5240	13.0
802.11n (HT20)	36	5180	12.5
	40	5200	12.5
	44	5220	12.5
	48	5240	12.5
802.11n (HT40)	38	5190	9.0
	46	5230	12.0
802.11ac (VHT80)	42	5210	7.0

<WLAN 5.3G>

Mode	Channel	Frequency (MHz)	Tune-up Power
802.11a	52	5260	13.0
	56	5280	13.0
	60	5300	13.0
	64	5320	13.0
802.11n (HT20)	52	5260	12.5
	56	5280	12.5
	60	5300	12.5
	64	5320	12.5
802.11n (HT40)	54	5270	12.5
	62	5310	12.5
802.11ac (VHT80)	58	5290	9.0

<WLAN 5.6G>

Mode	Channel	Frequency (MHz)	Tune-up Power
802.11a	100	5500	13.5
	116	5580	13.5
	120	5600	13.5
	124	5620	13.5
	132	5660	13.5
	140	5700	13.5
802.11n (HT20)	100	5500	12.5
	116	5580	12.5
	120	5600	12.5
	124	5620	12.5
	132	5660	12.5
	140	5700	12.5
802.11n (HT40)	102	5510	10.0
	110	5550	13.0
	118	5590	13.0
	126	5630	13.0
	134	5670	13.0
802.11ac (VHT80)	106	5530	9.0
	122	5610	12.5

FCC SAR Test Report

<WLAN 5.8G>

Mode	Channel	Frequency (MHz)	Tune-up Power
802.11a	149	5745	13.5
	153	5765	13.5
	157	5785	13.5
	161	5805	13.5
	165	5825	13.5
802.11n (HT20)	149	5745	13.0
	153	5765	13.0
	157	5785	13.0
	161	5805	13.0
	165	5825	13.0
802.11n (HT40)	151	5755	13.0
	159	5795	13.0
802.11ac (VHT80)	155	5775	13.0

<Bluetooth>

Mode	Channel	Frequency (MHz)	Tune-up Power
Bluetooth EDR	0	2402	9.0
	39	2441	9.0
	78	2480	6.0
Bluetooth LE	0	2402	5.5
	19	2440	5.5
	39	2480	2.5

FCC SAR Test Report

4.6.2 Measured Conducted Power Result

The measuring conducted average power (Unit: dBm) is shown as below.

Band	GSM850			GSM1900		
Channel	128	189	251	512	661	810
Frequency (MHz)	824.2	836.4	848.8	1850.2	1880.0	1909.8
Maximum Burst-Averaged Output Power						
GSM (GMSK, 1Tx-slot)	32.87	32.82	32.78	29.79	29.92	29.89
GPRS (GMSK, 1Tx-slot)	32.42	32.38	32.25	29.52	29.61	29.66
GPRS (GMSK, 2Tx-slot)	29.77	29.72	29.60	26.70	26.80	26.93
GPRS (GMSK, 3Tx-slot)	27.98	27.90	27.78	24.79	25.12	24.99
GPRS (GMSK, 4Tx-slot)	26.89	26.77	26.66	23.58	23.78	23.83
EDGE (8PSK, 1Tx-slot)	26.72	26.69	26.59	25.42	25.52	25.55
EDGE (8PSK, 2Tx-slot)	23.86	23.76	23.68	22.56	22.68	22.81
EDGE (8PSK, 3Tx-slot)	22.00	21.91	21.82	20.72	20.87	20.93
EDGE (8PSK, 4Tx-slot)	20.86	20.73	20.66	19.54	19.68	19.72

Band	WCDMA Band II			WCDMA Band V			3GPP MPR (dB)
Channel	9262	9400	9538	4132	4182	4233	
Frequency (MHz)	1852.4	1880.0	1907.6	826.4	836.4	846.6	
RMC 12.2K	23.99	23.95	23.88	23.98	23.88	23.84	-
HSDPA Subtest-1	23.68	23.55	23.44	23.93	23.87	23.80	0
HSDPA Subtest-2	23.48	23.45	23.29	23.91	23.78	23.72	0
HSDPA Subtest-3	22.98	23.00	22.90	22.92	22.85	22.73	0.5
HSDPA Subtest-4	22.96	22.90	22.82	22.76	22.59	22.54	0.5
HSUPA Subtest-1	23.54	23.42	23.36	23.19	23.10	23.09	0
HSUPA Subtest-2	21.52	21.44	21.37	21.27	21.15	21.12	2
HSUPA Subtest-3	22.28	22.25	22.16	22.04	21.94	21.87	1
HSUPA Subtest-4	21.72	21.66	21.62	21.53	21.43	21.39	2
HSUPA Subtest-5	23.54	23.50	23.39	23.37	23.30	23.24	0

<WLAN 2.4G>

Mode	Channel	Frequency (MHz)	Average Power
802.11b	1	2412	16.42
	6	2437	16.63
	11	2462	16.81

FCC SAR Test Report

<WLAN 5.3G>

Mode	Channel	Frequency (MHz)	Average Power
802.11a	52	5260	12.49
	56	5280	12.43
	60	5300	12.46
	64	5320	12.33

<WLAN 5.6G>

Mode	Channel	Frequency (MHz)	Average Power
802.11a	100	5500	12.55
	116	5580	12.91
	120	5600	12.53
	124	5620	12.59
	132	5660	13.04
	140	5700	13.09

<WLAN 5.8G>

Mode	Channel	Frequency (MHz)	Average Power
802.11a	149	5745	12.88
	153	5765	12.94
	157	5785	13.05
	161	5805	12.93
	165	5825	12.84

<Bluetooth>

Mode	Channel	Frequency (MHz)	Average Power
Bluetooth EDR	0	2402	7.66
	39	2441	8.17
	78	2480	5.25
Bluetooth LE	0	2402	4.34
	19	2440	5.07
	39	2480	2.01

4.7 SAR Testing Results

4.7.1 SAR Test Reduction Considerations

<KDB 447498 D01, General RF Exposure Guidance>

Testing of other required channels within the operating mode of a frequency band is not required when the reported SAR for the mid-band or highest output power channel is:

- (1) ≤ 0.8 W/kg or 2.0 W/kg, for 1-g or 10-g respectively, when the transmission band is ≤ 100 MHz
- (2) ≤ 0.6 W/kg or 1.5 W/kg, for 1-g or 10-g respectively, when the transmission band is between 100 MHz and 200 MHz
- (3) ≤ 0.4 W/kg or 1.0 W/kg, for 1-g or 10-g respectively, when the transmission band is ≥ 200 MHz

When SAR is not measured at the maximum power level allowed for production units, the measured SAR will be scaled to the maximum tune-up tolerance limit to determine compliance. The scaling factor for the tune-up power is defined as maximum tune-up limit (mW) / measured conducted power (mW). The reported SAR would be calculated by measured SAR x tune-up power scaling factor.

The SAR has been measured with highest transmission duty factor supported by the test mode tools for WLAN and/or Bluetooth. When the transmission duty factor could not achieve 100%, the reported SAR will be scaled to 100% transmission duty factor to determine compliance at the maximum tune-up power. The scaling factor for the duty factor is defined as 100% / transmission duty cycle (%). The reported SAR would be calculated by measured SAR x tune-up power scaling factor x duty cycle scaling factor.

<KDB 941225 D01, 3G SAR Measurement Procedures>

The mode tested for SAR is referred to as the primary mode. The equivalent modes considered for SAR test reduction are denoted as secondary modes. Both primary and secondary modes must be in the same frequency band. When the maximum output power and tune-up tolerance specified for production units in a secondary mode is $\leq 1/4$ dB higher than the primary mode or when the highest reported SAR of the primary mode is scaled by the ratio of specified maximum output power and tune-up tolerance of secondary to primary mode and the adjusted SAR is ≤ 1.2 W/kg, SAR measurement is not required for the secondary mode.

<KDB 248227 D01, SAR Guidance for Wi-Fi Transmitters>

- (1) For handsets operating next to ear, hotspot mode or mini-tablet configurations, the initial test position procedures were applied. The test position with the highest extrapolated peak SAR will be used as the initial test position. When the reported SAR of initial test position is ≤ 0.4 W/kg, SAR testing for remaining test positions is not required. Otherwise, SAR is evaluated at the subsequent highest peak SAR positions until the reported SAR result is ≤ 0.8 W/kg or all test positions are measured.
- (2) For WLAN 2.4 GHz, the highest measured maximum output power channel for DSSS was selected for SAR measurement. When the reported SAR is ≤ 0.8 W/kg, no further SAR testing is required. Otherwise, SAR is evaluated at the next highest measured output power channel. When any reported SAR is >1.2 W/kg, SAR is required for the third channel. For OFDM modes (802.11g/n), SAR is not required when the highest reported SAR for DSSS is adjusted by the ratio of OFDM to DSSS specified maximum output power and it is ≤ 1.2 W/kg.
- (3) For WLAN 5GHz, the initial test configuration was selected according to the transmission mode with the highest maximum output power. When the reported SAR of initial test configuration is > 0.8 W/kg, SAR is required for the subsequent highest measured output power channel until the reported SAR result is ≤ 1.2 W/kg or all required channels are measured. For other transmission modes, SAR is not required when the highest reported SAR for initial test configuration is adjusted by the ratio of subsequent test configuration to initial test

FCC SAR Test Report

4.7.2 SAR Results for Extremity Exposure Condition (Test Separation Distance is 0 mm)

Plot No.	Band	Mode	Test Position	Ch.	Max. Tune-up Power (dBm)	Measured Conducted Power (dBm)	Scaling Factor	Power Drift (dB)	Measured SAR-10g (W/kg)	Scaled SAR-10g (W/kg)
01	GSM850	GPRS12	Front Face	128	27.0	26.89	1.03	-0.06	0.387	0.40
	GSM850	GPRS12	Rear Face	128	27.0	26.89	1.03	-0.15	1.23	1.27
	GSM850	GPRS12	Left Side	128	27.0	26.89	1.03	0.16	0.468	0.48
	GSM850	GPRS12	Top Side	128	27.0	26.89	1.03	-0.09	0.594	0.61
	GSM850	GPRS12	Rear Face	189	27.0	26.77	1.05	-0.05	1.52	1.60
	GSM850	GPRS12	Rear Face	251	27.0	26.66	1.08	0.12	1.31	1.41
02	GSM1900	GPRS11	Front Face	661	25.5	25.12	1.09	-0.04	0.542	0.59
	GSM1900	GPRS11	Rear Face	661	25.5	25.12	1.09	0.19	1.44	1.57
	GSM1900	GPRS11	Left Side	661	25.5	25.12	1.09	0.17	0.684	0.75
	GSM1900	GPRS11	Top Side	661	25.5	25.12	1.09	-0.15	0.281	0.31
	GSM1900	GPRS11	Rear Face	512	25.5	24.79	1.18	0.10	1.6	1.89
	GSM1900	GPRS11	Rear Face	810	25.5	24.99	1.12	-0.15	1.39	1.56
03	WCDMA II	RMC 12.2K	Front Face	9262	24.0	23.99	1.00	0.03	1.18	1.18
	WCDMA II	RMC 12.2K	Rear Face	9262	24.0	23.99	1.00	-0.08	3.21	3.21
	WCDMA II	RMC 12.2K	Left Side	9262	24.0	23.99	1.00	0.01	1.4	1.40
	WCDMA II	RMC 12.2K	Top Side	9262	24.0	23.99	1.00	-0.05	0.452	0.45
	WCDMA II	RMC 12.2K	Rear Face	9400	24.0	23.95	1.01	-0.06	3.14	3.17
	WCDMA II	RMC 12.2K	Rear Face	9538	24.0	23.88	1.03	-0.03	2.74	2.82
	WCDMA II	RMC 12.2K	Rear Face	9262	24.0	23.99	1.00	0.17	3.18	3.18
04	WCDMA V	RMC 12.2K	Front Face	4132	24.0	23.98	1.00	-0.16	0.542	0.54
	WCDMA V	RMC 12.2K	Rear Face	4132	24.0	23.98	1.00	0.07	1.45	1.45
	WCDMA V	RMC 12.2K	Left Side	4132	24.0	23.98	1.00	-0.08	0.563	0.56
	WCDMA V	RMC 12.2K	Top Side	4132	24.0	23.98	1.00	0.05	0.378	0.38
	WCDMA V	RMC 12.2K	Rear Face	4182	24.0	23.88	1.03	0.10	1.50	1.55
	WCDMA V	RMC 12.2K	Rear Face	4233	24.0	23.84	1.04	-0.03	1.55	1.61

FCC SAR Test Report

Plot No.	Band	Mode	Test Position	Ch.	Duty Cycle	Crest Factor	Max. Tune-up Power (dBm)	Measured Conducted Power (dBm)	Scaling Factor	Power Drift (dB)	Measured SAR-10g (W/kg)	Scaled SAR-10g (W/kg)
05	WLAN2.4G	802.11b	Front Face	11	98.70	1.01	17.0	16.81	1.04	-0.04	0.133	0.14
	WLAN2.4G	802.11b	Rear Face	11	98.70	1.01	17.0	16.81	1.04	0.10	0.562	0.59
	WLAN2.4G	802.11b	Right Side	11	98.70	1.01	17.0	16.81	1.04	0.06	0.132	0.14
	WLAN2.4G	802.11b	Bottom Side	11	98.70	1.01	17.0	16.81	1.04	0.15	0.504	0.53
	WLAN2.4G	802.11b	Rear Face	1	98.70	1.01	17.0	16.42	1.14	-0.07	0.376	0.43
	WLAN2.4G	802.11b	Rear Face	6	98.70	1.01	17.0	16.63	1.09	-0.04	0.531	0.58
06	WLAN5.3G	802.11a	Front Face	52	92.60	1.08	13.0	12.49	1.12	-0.08	0.138	0.17
	WLAN5.3G	802.11a	Rear Face	52	92.60	1.08	13.0	12.49	1.12	-0.16	0.519	0.63
	WLAN5.3G	802.11a	Right Side	52	92.60	1.08	13.0	12.49	1.12	0.19	0.495	0.60
	WLAN5.3G	802.11a	Bottom Side	52	92.60	1.08	13.0	12.49	1.12	0.04	0.271	0.33
	WLAN5.3G	802.11a	Rear Face	56	92.60	1.08	13.0	12.43	1.14	0.17	0.521	0.64
	WLAN5.3G	802.11a	Rear Face	60	92.60	1.08	13.0	12.46	1.13	0.04	0.43	0.52
07	WLAN5.6G	802.11a	Rear Face	64	92.60	1.08	13.0	12.33	1.17	0.06	0.527	0.67
	WLAN5.6G	802.11a	Front Face	140	92.60	1.08	13.5	13.09	1.10	-0.14	0.142	0.17
	WLAN5.6G	802.11a	Rear Face	140	92.60	1.08	13.5	13.09	1.10	-0.13	0.481	0.57
	WLAN5.6G	802.11a	Right Side	140	92.60	1.08	13.5	13.09	1.10	-0.01	0.464	0.55
	WLAN5.6G	802.11a	Bottom Side	140	92.60	1.08	13.5	13.09	1.10	-0.09	0.339	0.40
	WLAN5.6G	802.11a	Rear Face	100	92.60	1.08	13.5	12.55	1.24	-0.09	0.503	0.67
08	WLAN5.6G	802.11a	Rear Face	116	92.60	1.08	13.5	12.91	1.15	0.10	0.548	0.68
	WLAN5.6G	802.11a	Rear Face	120	92.60	1.08	13.5	12.53	1.25	0.03	0.459	0.62
	WLAN5.6G	802.11a	Rear Face	124	92.60	1.08	13.5	12.59	1.23	-0.01	0.461	0.61
	WLAN5.6G	802.11a	Rear Face	132	92.60	1.08	13.5	13.04	1.11	0.10	0.438	0.53
	WLAN5.8G	802.11a	Front Face	157	92.60	1.08	13.5	13.05	1.11	0.12	0.087	0.10
	WLAN5.8G	802.11a	Rear Face	157	92.60	1.08	13.5	13.05	1.11	-0.19	0.462	0.55
09	WLAN5.8G	802.11a	Right Side	157	92.60	1.08	13.5	13.05	1.11	-0.05	0.373	0.45
	WLAN5.8G	802.11a	Bottom Side	157	92.60	1.08	13.5	13.05	1.11	-0.18	0.287	0.34
	WLAN5.8G	802.11a	Rear Face	149	92.60	1.08	13.5	12.88	1.15	0.02	0.473	0.59
	WLAN5.8G	802.11a	Rear Face	153	92.60	1.08	13.5	12.94	1.14	-0.07	0.366	0.45
	WLAN5.8G	802.11a	Rear Face	161	92.60	1.08	13.5	12.93	1.14	-0.06	0.43	0.53
	WLAN5.8G	802.11a	Rear Face	165	92.60	1.08	13.5	12.84	1.16	0.03	0.44	0.55
09	BT	BR	Front Face	39	76.80	1.30	9.0	8.17	1.21	0.08	<0.001	0.00
	BT	BR	Rear Face	39	76.80	1.30	9.0	8.17	1.21	0.00	0.049	0.08
	BT	BR	Right Side	39	76.80	1.30	9.0	8.17	1.21	0.03	0.045	0.07
	BT	BR	Bottom Side	39	76.80	1.30	9.0	8.17	1.21	0.17	0.038	0.06
	BT	BR	Rear Face	0	76.80	1.30	9.0	7.66	1.36	0.04	0.051	0.09
	BT	BR	Rear Face	78	76.80	1.30	6.0	5.25	1.19	-0.14	0.030	0.04

Note: The "< 0.001" means there is no SAR value or the SAR is too low to be measured.

4.7.3 SAR Measurement Variability

According to KDB 865664 D01, SAR measurement variability was assessed for each frequency band, which is determined by the SAR probe calibration point and tissue-equivalent medium used for the device measurements. When both head and body tissue-equivalent media are required for SAR measurements in a frequency band, the variability measurement procedures should be applied to the tissue medium with the highest measured SAR, using the highest measured SAR configuration for that tissue-equivalent medium. Alternatively, if the highest measured SAR for both head and body tissue-equivalent media are ≤ 1.45 W/kg and the ratio of these highest SAR values, i.e., largest divided by smallest value, is ≤ 1.10 , the highest SAR configuration for either head or body tissue-equivalent medium maybe used to perform the repeated measurement. These additional measurements are repeated after the completion of all measurements requiring the same head or body tissue-equivalent medium in a frequency band. The test device should be returned to ambient conditions (normal room temperature) with the battery fully charged before it is re-mounted on the device holder for the repeated measurement(s) to minimize any unexpected variations in the repeated results.

Band	Mode	Test Position	Ch.	Original Measured SAR-1g (W/kg)	1st Repeated SAR-1g (W/kg)	L/S Ratio	2nd Repeated SAR-1g (W/kg)	L/S Ratio	3rd Repeated SAR-1g (W/kg)	L/S Ratio
WCDMA II	RMC12.2K	Rear Face	9262	3.21	3.18	1.01	N/A	N/A	N/A	N/A

4.7.4 Simultaneous Multi-band Transmission Evaluation

<Possibilities of Simultaneous Transmission>

The simultaneous transmission possibilities for this device are listed as below.

Simultaneous TX Combination	Capable Transmit Configurations	Extremity Exposure Condition
1	WWAN + WLAN2.4G	Yes
2	WWAN + WLAN5G	Yes
3	WWAN+ BT	Yes
4	WWAN + WLAN2.4G+BT	Yes
5	WWAN + WLAN5G+BT	Yes

Note : The WLAN 2.4G and WLAN 5G cannot transmit simultaneously.

FCC SAR Test Report

<Estimated SAR Calculation>

According to KDB 447498 D01, when standalone SAR test exclusion applies to an antenna that transmits simultaneously with other antennas, the standalone SAR was estimated according to following formula to result in substantially conservative SAR values of ≤ 0.4 W/kg to determine simultaneous transmission SAR test exclusion.

$$\text{Estimated SAR} = \frac{\text{Max. Tune up Power}_{(mW)}}{\text{Min. Test Separation Distance}_{(mm)}} \times \frac{\sqrt{f_{(GHz)}}}{7.5}$$

If the minimum test separation distance is < 5 mm, a distance of 5 mm is used for estimated SAR calculation. When the test separation distance is > 50 mm, the 0.4 W/kg is used for SAR-1g.

Mode / Band	Frequency (GHz)	Max. Tune-up Power (dBm)	Test Position	Separation Distance (mm)	Estimated SAR (W/kg)
GSM850	0.835	33.0	Body	0	0.40
GSM1900	1.909	30.0	Body	0	0.40
WCDMA II	1.907	24.0	Body	0	0.40
WCDMA V	0.846	24.0	Body	0	0.40
WLAN (DTS)	2.462	17.0	Body	0	0.40
WLAN (NII)	5.2	13.5	Body	0	0.40
WLAN (NII)	5.3	12.5	Body	0	0.40
WLAN (NII)	5.6	13.5	Body	0	0.40
WLAN (NII)	5.8	13.5	Body	0	0.40
BT(DSS)	2.48	9.0	Body	0	0.40

Note:

1. The separation distance is determined from the outer housing of the EUT to the user.
2. When standalone SAR testing is not required, an estimated SAR can be applied to determine simultaneous transmission SAR test exclusion.

FCC SAR Test Report

<SAR Summation Analysis>

Simultaneous transmission SAR test exclusion is determined for each operating configuration and exposure condition according to the reported standalone SAR of each applicable simultaneous transmitting antenna. When the sum of SAR_{1g} of all simultaneously transmitting antennas in an operating mode and exposure condition combination is within the SAR limit(SAR_{1g} 1.6 W/kg), the simultaneous transmission SAR is not required. When the sum of SAR_{1g} is greater than the SAR limit (SAR_{1g} 1.6 W/kg), SAR test exclusion is determined by the SPLSR.

Band	Mode	Position	10g SAR W/kg				Summing result 10g SAR W/kg				
			1	2	3	4	1+2	1+3	1+4	1+2+4	1+3+4
			Max WWAN	Max WLAN 2.4GHz	Max WLAN 5GHz	BT					
GSM850	Extremity	Front Face	0.40	0.14	0.17	0.00	0.54	0.57	0.40	0.54	0.57
		Rear Face	1.60	0.59	0.68	0.09	2.19	2.28	1.69	2.28	2.37
		Left Side	0.48	0.40	0.40	0.40	0.88	0.88	0.88	1.28	1.28
		Right Side	0.40	0.14	0.60	0.07	0.54	1.00	0.47	0.61	1.07
		Top Side	0.61	0.40	0.40	0.40	1.01	1.01	1.01	1.41	1.41
		Bottom Side	0.40	0.53	0.40	0.06	0.93	0.80	0.46	0.99	0.86
GSM1900	Extremity	Front Face	0.59	0.14	0.23	0.40	0.73	0.82	0.99	1.13	1.22
		Rear Face	1.89	0.59	0.68	0.09	2.48	2.57	1.98	2.57	2.66
		Left Side	0.75	0.40	0.40	0.40	1.15	1.15	1.15	1.55	1.55
		Right Side	0.40	0.14	0.61	0.07	0.54	1.01	0.47	0.61	1.08
		Top Side	0.31	0.40	0.40	0.40	0.71	0.71	0.71	1.11	1.11
		Bottom Side	0.40	0.53	0.40	0.06	0.93	0.80	0.46	0.99	0.86
WCDMA II	Extremity	Front Face	1.18	0.14	0.23	0.40	1.32	1.41	1.58	1.72	1.81
		Rear Face	3.21	0.59	0.68	0.09	3.80	3.89	3.30	3.89	3.98
		Left Side	1.40	0.40	0.40	0.40	1.80	1.80	1.80	2.20	2.20
		Right Side	0.40	0.14	0.61	0.07	0.54	1.01	0.47	0.61	1.08
		Top Side	0.45	0.40	0.40	0.40	0.85	0.85	0.85	1.25	1.25
		Bottom Side	0.40	0.53	0.40	0.06	0.93	0.80	0.46	0.99	0.86
WCDMA V	Extremity	Front Face	0.54	0.14	0.23	0.40	0.68	0.77	0.94	1.08	1.17
		Rear Face	1.61	0.59	0.68	0.09	2.20	2.29	1.70	2.29	2.38
		Left Side	0.56	0.40	0.40	0.40	0.96	0.96	0.96	1.36	1.36
		Right Side	0.40	0.14	0.61	0.07	0.54	1.01	0.47	0.61	1.08
		Top Side	0.38	0.40	0.40	0.40	0.78	0.78	0.78	1.18	1.18
		Bottom Side	0.40	0.53	0.40	0.06	0.93	0.80	0.46	0.99	0.86

Test Engineer : Chienlun Huang, and Antony Yin

5. Calibration of Test Equipment

Equipment	Manufacturer	Model	SN	Cal. Date	Cal. Interval
System Validation Dipole	SPEAG	D835V2	4d092	Jun. 20, 2019	1 Year
System Validation Dipole	SPEAG	D1900V2	5d036	Jan. 25, 2019	1 Year
System Validation Dipole	SPEAG	D2450V2	835	Jun. 27, 2019	1 Year
System Validation Dipole	SPEAG	D5GHzV2	1019	Mar. 21, 2019	1 Year
Dosimetric E-Field Probe	SPEAG	EX3DV4	3971	Mar. 29, 2019	1 Year
Dosimetric E-Field Probe	SPEAG	EX3DV4	7537	Jun. 18, 2019	1 Year
Data Acquisition Electronics	SPEAG	DAE4	1431	Mar. 25, 2019	1 Year
Data Acquisition Electronics	SPEAG	DAE4	1585	Jun. 07, 2019	1 Year
Wireless Communication Test Set	Agilent	E5515C	MY50266628	Dec. 06, 2018	1 Year
Radio Communication Analyzer	Anritsu	MT8820C	6201300638	Jun. 27, 2019	1 Year
Spectrum Analyzer	R&S	FSL6	102006	Mar. 26, 2019	1 Year
ENA Series Network Analyzer	Agilent	E5071C	MY46214281	Jun. 17, 2019	1 Year
MXG Analog Signal Generator	Agilent	N5181A	MY50143868	Jun. 27, 2019	1 Year
Power Meter	Anritsu	ML2495A	1218009	Jun. 28, 2019	1 Year
Power Sensor	Anritsu	MA2411B	1207252	Jun. 28, 2019	1 Year
Thermometer	YFE	YF-160A	130504591	Mar. 22, 2019	1 Year

6. Measurement Uncertainty

According to KDB 865664 D01, SAR measurement uncertainty analysis is required in SAR reports only when the highest measured SAR in a frequency band is ≥ 1.5 W/kg for 1-g SAR, and ≥ 3.75 W/kg for 10-g SAR. The procedures described in IEEE Std 1528-2013 should be applied. The expanded SAR measurement uncertainty must be $\leq 30\%$, for a confidence interval of $k = 2$. When the highest measured SAR within a frequency band is < 1.5 W/kg for 1-g and < 3.75 W/kg for 10-g, the extensive SAR measurement uncertainty analysis described in IEEE Std 1528-2013 is not required in SAR reports submitted for equipment approval. Hence, the measurement uncertainty analysis is not required in this SAR report because the test result met the condition.

7. Information of the Testing Laboratories

We, Bureau Veritas Consumer Products Services (H.K.) Ltd., Taoyuan Branch, were founded in 1988 to provide our best service in EMC, Radio, Telecom and Safety consultation. Our laboratories are accredited and approved according to ISO/IEC 17025.

If you have any comments, please feel free to contact us at the following:

Taiwan HwaYa EMC/RF/Safety Lab:

Add: No. 19, Hwa Ya 2nd Rd, Wen Hwa Vil, Kwei Shan Dist., Taoyuan City 33383, Taiwan R.O.C.

Tel: 886-3-318-3232

Fax: 886-3-327-0892

Taiwan LinKou EMC/RF Lab:

Add: No. 47-2, 14th Ling, Chia Pau Vil., Linkou Dist., New Taipei City 244, Taiwan, R.O.C.

Tel: 886-2-2605-2180

Fax: 886-2-2605-1924

Taiwan HsinChu EMC/RF/Telecom Lab:

Add: E-2, No.1, Li Hsin 1st Road, Hsinchu Science Park, Hsinchu City 30078, Taiwan, R.O.C.

Tel: 886-3-666-8565

Fax: 886-3-666-8323

Email: service.adt@tw.bureauveritas.com

Web Site: www.bureauveritas-adt.com

The road map of all our labs can be found in our web site also.

---END---

Appendix A. SAR Plots of System Verification

The plots for system verification with largest deviation for each SAR system combination are shown as follows.

System Check_H835_190905

DUT: Dipole 835 MHz; Type: D835V2; SN: 4d092

Communication System: CW; Frequency: 835 MHz; Duty Cycle: 1:1

Medium: H07T10N1_0905 Medium parameters used: $f = 835 \text{ MHz}$; $\sigma = 0.926 \text{ S/m}$; $\epsilon_r = 42.011$; $\rho = 1000 \text{ kg/m}^3$

Ambient Temperature : $23.7 \text{ }^\circ\text{C}$; Liquid Temperature : $23.3 \text{ }^\circ\text{C}$

DASY5 Configuration:

- Probe: EX3DV4 - SN7537; ConvF(10.48, 10.48, 10.48); Calibrated: 2019/06/18
- Sensor-Surface: 1.4mm (Mechanical Surface Detection)
- Electronics: DAE4 Sn1585; Calibrated: 2019/06/07
- Phantom: SAM Phantom_1982; Type: QD 000 P41 Ax; Serial: 1982
- Measurement SW: DASY52, Version 52.10 (2); SEMCAD X Version 14.6.12 (7470)

Pin=250mW/Area Scan (61x61x1): Interpolated grid: $dx=1.500 \text{ mm}$, $dy=1.500 \text{ mm}$
Maximum value of SAR (interpolated) = 3.12 W/kg

Pin=250mW/Zoom Scan (5x5x7)/Cube 0: Measurement grid: $dx=8\text{mm}$, $dy=8\text{mm}$, $dz=5\text{mm}$
Reference Value = 60.40 V/m ; Power Drift = -0.01 dB
Peak SAR (extrapolated) = 3.55 W/kg
SAR(1 g) = 2.29 W/kg ; SAR(10 g) = 1.48 W/kg
Maximum value of SAR (measured) = 3.11 W/kg

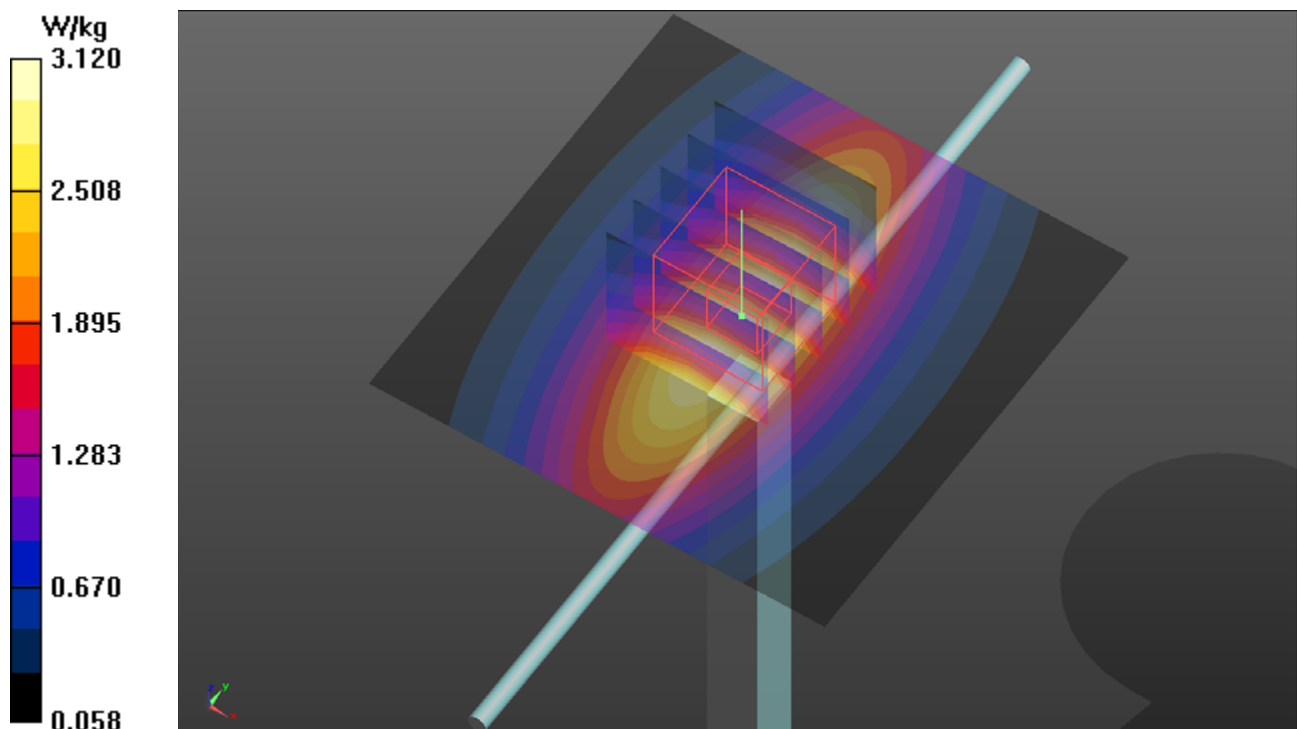

System Check_H1900_190905

DUT: Dipole 1900 MHz; Type: D1900V2; SN: 5d036

Communication System: CW; Frequency: 1900 MHz; Duty Cycle: 1:1

Medium: H16T20N1_0905 Medium parameters used: $f = 1900$ MHz; $\sigma = 1.454$ S/m; $\epsilon_r = 40.464$; $\rho = 1000$ kg/m³

Ambient Temperature : 23.7 °C ; Liquid Temperature : 23.3 °C

DASY5 Configuration:

- Probe: EX3DV4 - SN7537; ConvF(8.13, 8.13, 8.13); Calibrated: 2019/06/18
- Sensor-Surface: 1.4mm (Mechanical Surface Detection)
- Electronics: DAE4 Sn1585; Calibrated: 2019/06/07
- Phantom: SAM Phantom_1982; Type: QD 000 P41 Ax; Serial: 1982
- Measurement SW: DASY52, Version 52.10 (2); SEMCAD X Version 14.6.12 (7470)

Pin=250mW/Area Scan (61x61x1): Interpolated grid: dx=1.500 mm, dy=1.500 mm
Maximum value of SAR (interpolated) = 15.1 W/kg

Pin=250mW/Zoom Scan (5x5x7)/Cube 0: Measurement grid: dx=8mm, dy=8mm, dz=5mm
Reference Value = 97.45 V/m; Power Drift = 0.18 dB
Peak SAR (extrapolated) = 18.2 W/kg
SAR(1 g) = 9.87 W/kg; SAR(10 g) = 5.15 W/kg
Maximum value of SAR (measured) = 15.3 W/kg

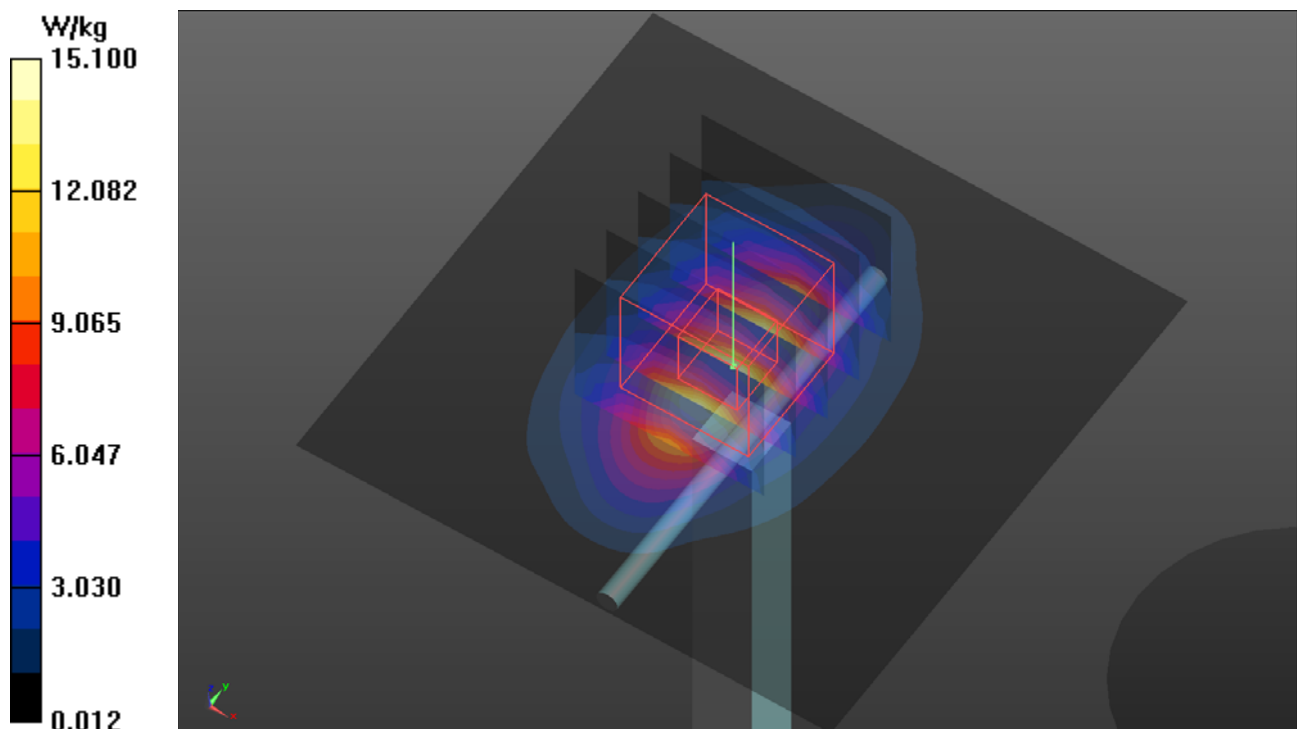

System Check_H2450_190906

DUT: Dipole 2450 MHz; Type: D2450V2; SN: 835

Communication System: CW; Frequency: 2450 MHz; Duty Cycle: 1:1

Medium: H19T27N1_0906 Medium parameters used: $f = 2450$ MHz; $\sigma = 1.87$ S/m; $\epsilon_r = 39.051$; $\rho = 1000$ kg/m³

Ambient Temperature : 23.6 °C ; Liquid Temperature : 23.3 °C

DASY5 Configuration:

- Probe: EX3DV4 - SN3971; ConvF(7.65, 7.65, 7.65); Calibrated: 2019/03/29
- Sensor-Surface: 1.4mm (Mechanical Surface Detection)
- Electronics: DAE4 Sn1431; Calibrated: 2019/03/25
- Phantom: Twin SAM Phantom_1496; Type: QD000P40CB;
- Measurement SW: DASY52, Version 52.10 (2); SEMCAD X Version 14.6.12 (7470)

Pin=250mW/Area Scan (81x81x1): Interpolated grid: dx=1.200 mm, dy=1.200 mm

Maximum value of SAR (interpolated) = 21.3 W/kg

Pin=250mW/Zoom Scan (7x7x7)/Cube 0: Measurement grid: dx=5mm, dy=5mm, dz=5mm

Reference Value = 102.4 V/m; Power Drift = -0.04 dB

Peak SAR (extrapolated) = 26.2 W/kg

SAR(1 g) = 12.5 W/kg; SAR(10 g) = 5.81 W/kg

Maximum value of SAR (measured) = 21.1 W/kg

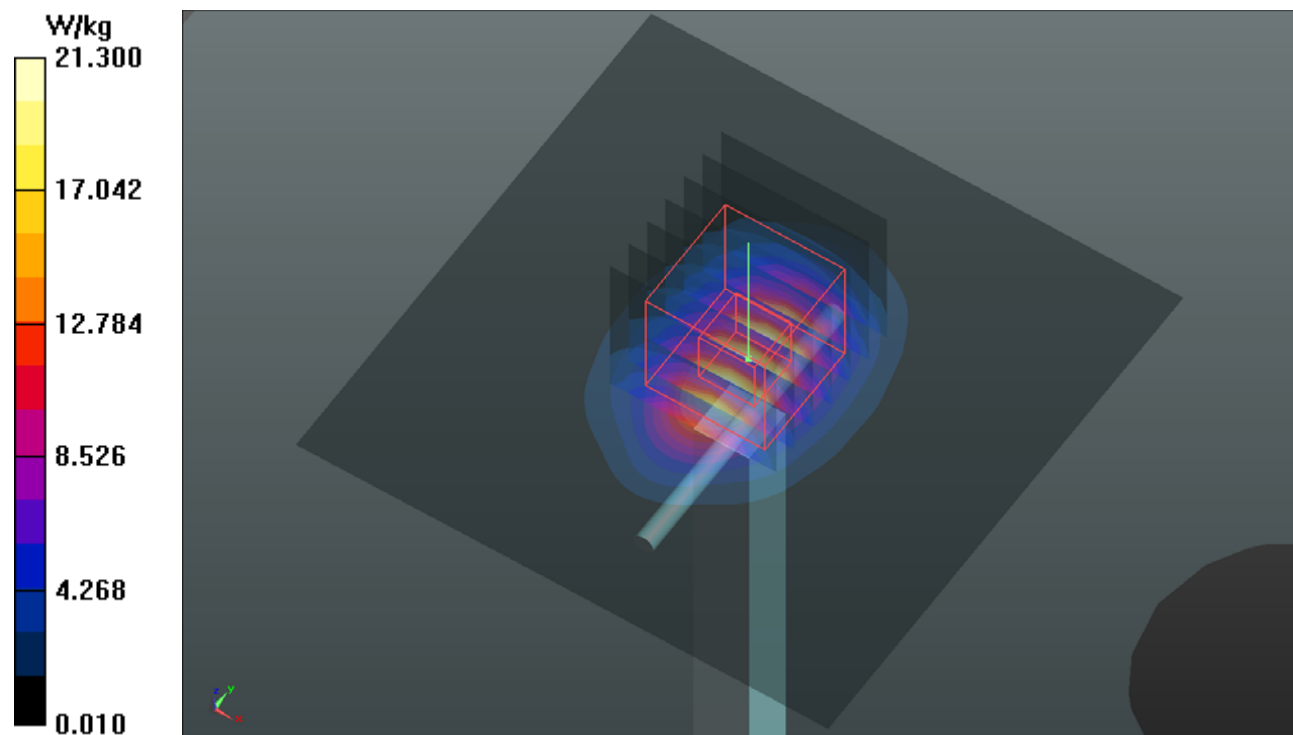

System Check_H5250_190909

DUT: Dipole 5 GHz; Type: D5GHzV2; SN: 1019

Communication System: CW; Frequency: 5250 MHz; Duty Cycle: 1:1

Medium: H34T60N1_0909 Medium parameters used: $f = 5250$ MHz; $\sigma = 4.703$ S/m; $\epsilon_r = 36.115$; $\rho = 1000$ kg/m³

Ambient Temperature : 23.6 °C ; Liquid Temperature : 23.1 °C

DASY5 Configuration:

- Probe: EX3DV4 - SN3971; ConvF(5.12, 5.12, 5.12); Calibrated: 2019/03/29
- Sensor-Surface: 1.4mm (Mechanical Surface Detection)
- Electronics: DAE4 Sn1431; Calibrated: 2019/03/25
- Phantom: Twin SAM Phantom_1496; Type: QD000P40CB;
- Measurement SW: DASY52, Version 52.10 (2); SEMCAD X Version 14.6.12 (7470)

Pin=100mW/Area Scan (91x91x1): Interpolated grid: dx=1.000 mm, dy=1.000 mm
Maximum value of SAR (interpolated) = 19.2 W/kg

Pin=100mW/Zoom Scan (7x7x12)/Cube 0: Measurement grid: dx=4mm, dy=4mm, dz=2mm
Reference Value = 73.69 V/m; Power Drift = 0.04 dB
Peak SAR (extrapolated) = 34.1 W/kg
SAR(1 g) = 8.32 W/kg; SAR(10 g) = 2.4 W/kg
Maximum value of SAR (measured) = 20.8 W/kg

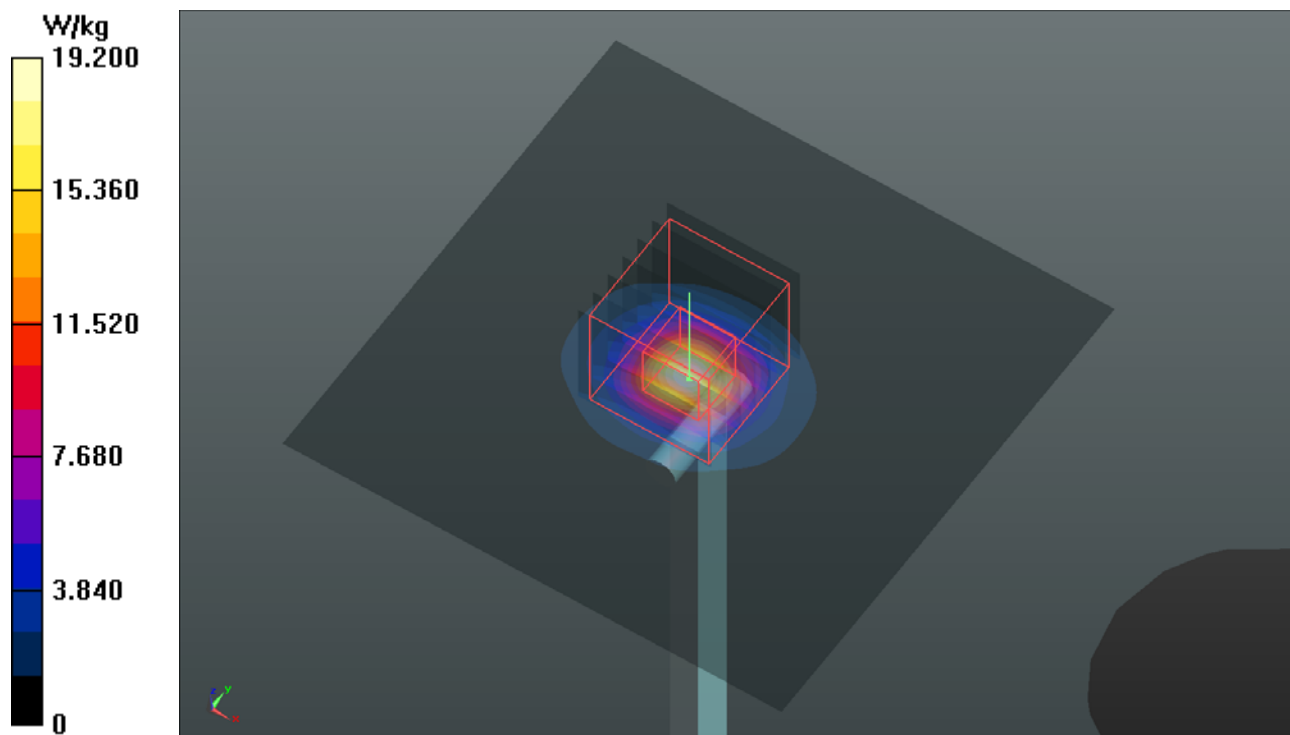

System Check_H5600_190909

DUT: Dipole 5 GHz; Type: D5GHzV2; SN: 1019

Communication System: CW; Frequency: 5600 MHz; Duty Cycle: 1:1

Medium: H34T60N1_0909 Medium parameters used: $f = 5600$ MHz; $\sigma = 5.129$ S/m; $\epsilon_r = 35.495$; $\rho = 1000$ kg/m³

Ambient Temperature : 23.6 °C ; Liquid Temperature : 23.1 °C

DASY5 Configuration:

- Probe: EX3DV4 - SN3971; ConvF(4.78, 4.78, 4.78); Calibrated: 2019/03/29
- Sensor-Surface: 1.4mm (Mechanical Surface Detection)
- Electronics: DAE4 Sn1431; Calibrated: 2019/03/25
- Phantom: Twin SAM Phantom_1496; Type: QD000P40CB;
- Measurement SW: DASY52, Version 52.10 (2); SEMCAD X Version 14.6.12 (7470)

Pin=100mW/Area Scan (91x91x1): Interpolated grid: dx=1.000 mm, dy=1.000 mm
Maximum value of SAR (interpolated) = 19.7 W/kg

Pin=100mW/Zoom Scan (7x7x12)/Cube 0: Measurement grid: dx=4mm, dy=4mm, dz=2mm
Reference Value = 61.93 V/m; Power Drift = 0.05 dB
Peak SAR (extrapolated) = 34.6 W/kg
SAR(1 g) = 8.14 W/kg; SAR(10 g) = 2.33 W/kg
Maximum value of SAR (measured) = 21.0 W/kg

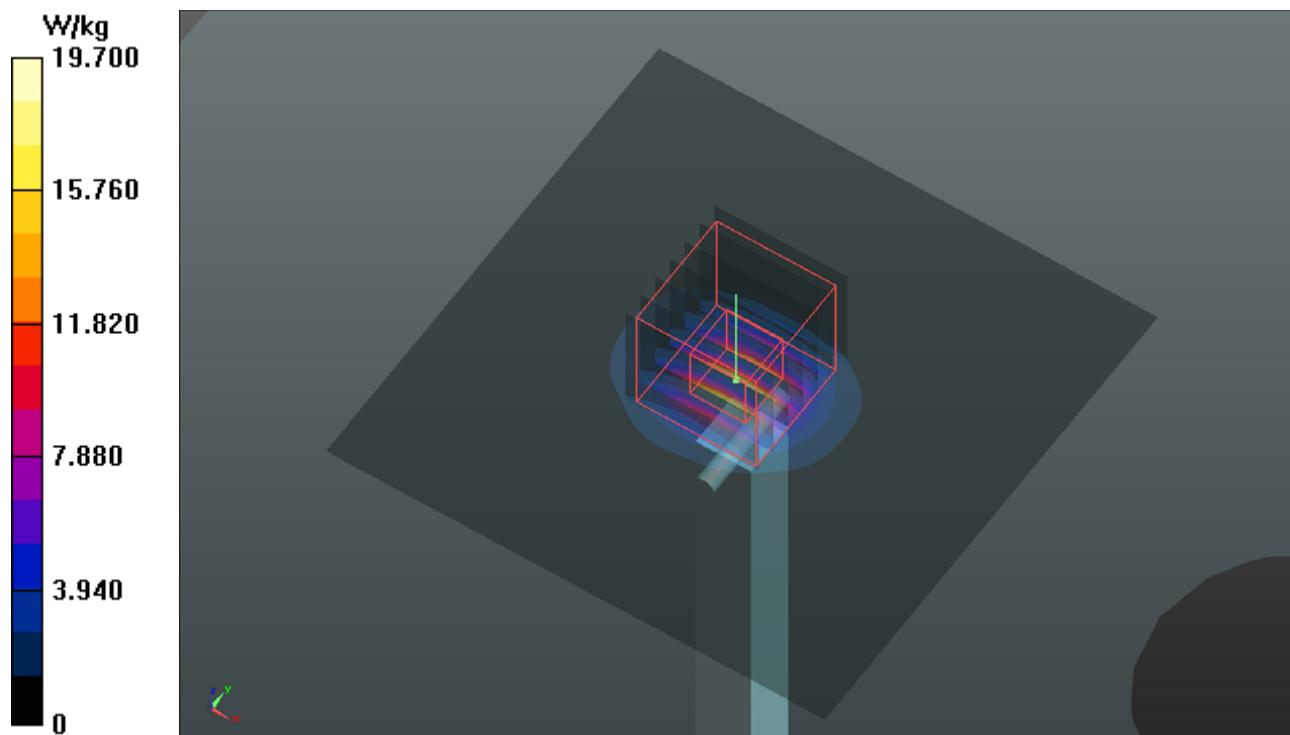

System Check_H5750_190909

DUT: Dipole 5 GHz; Type: D5GHzV2; SN: 1019

Communication System: CW; Frequency: 5750 MHz; Duty Cycle: 1:1

Medium: H34T60N1_0909 Medium parameters used: $f = 5750$ MHz; $\sigma = 5.303$ S/m; $\epsilon_r = 35.218$; $\rho = 1000$ kg/m³

Ambient Temperature : 23.6 °C ; Liquid Temperature : 23.1 °C

DASY5 Configuration:

- Probe: EX3DV4 - SN3971; ConvF(4.92, 4.92, 4.92); Calibrated: 2019/03/29
- Sensor-Surface: 1.4mm (Mechanical Surface Detection)
- Electronics: DAE4 Sn1431; Calibrated: 2019/03/25
- Phantom: Twin SAM Phantom_1496; Type: QD000P40CB;
- Measurement SW: DASY52, Version 52.10 (2); SEMCAD X Version 14.6.12 (7470)

Pin=100mW/Area Scan (91x91x1): Interpolated grid: dx=1.000 mm, dy=1.000 mm
Maximum value of SAR (interpolated) = 18.0 W/kg

Pin=100mW/Zoom Scan (7x7x12)/Cube 0: Measurement grid: dx=4mm, dy=4mm, dz=2mm
Reference Value = 66.93 V/m; Power Drift = 0.05 dB
Peak SAR (extrapolated) = 33.1 W/kg
SAR(1 g) = 7.26 W/kg; SAR(10 g) = 2.18 W/kg
Maximum value of SAR (measured) = 19.5 W/kg

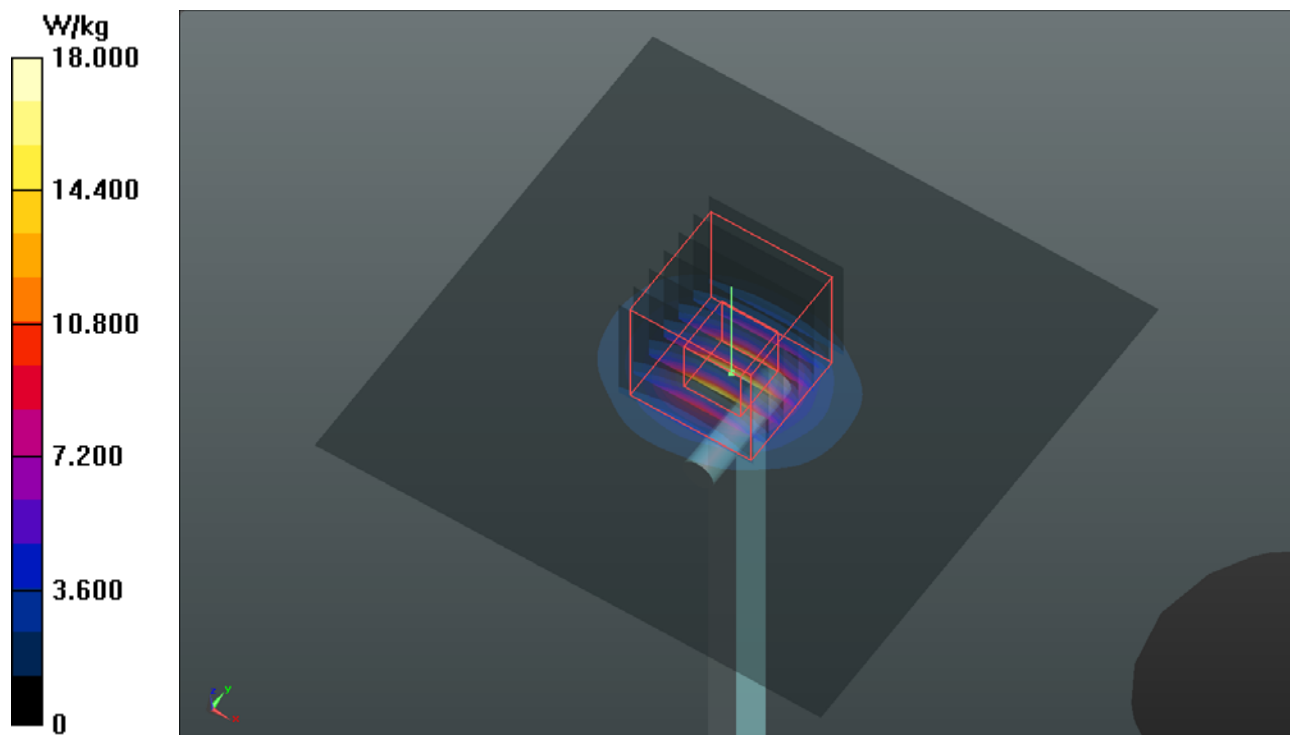

Appendix B. SAR Plots of SAR Measurement

The SAR plots for highest measured SAR in each exposure configuration, wireless mode and frequency band combination, and measured SAR > 1.5 W/kg are shown as follows.

P01_GSM850_GPRS12_Rear Face_0mm_ch189

DUT: 190813C30

Communication System: GPRS12; Frequency: 836.4 MHz; Duty Cycle: 1:2

Medium: H07T10N1_0909 Medium parameters used: $f = 836.4$ MHz; $\sigma = 0.92$ S/m; $\epsilon_r = 42.019$; $\rho = 1000$ kg/m³

Ambient Temperature : 23.6 °C ; Liquid Temperature : 23.1 °C

DASY5 Configuration:

- Probe: EX3DV4 - SN3971; ConvF(10.18, 10.18, 10.18); Calibrated: 2019/03/29
- Sensor-Surface: 1.4mm (Mechanical Surface Detection)
- Electronics: DAE4 Sn1431; Calibrated: 2019/03/25
- Phantom: Twin SAM Phantom_1496; Type: QD000P40CB;
- Measurement SW: DASY52, Version 52.10 (2); SEMCAD X Version 14.6.12 (7470)

- **Area Scan (71x121x1):** Interpolated grid: dx=1.500 mm, dy=1.500 mm

Maximum value of SAR (interpolated) = 6.18 W/kg

- **Zoom Scan (5x5x7)/Cube 0:** Measurement grid: dx=8mm, dy=8mm, dz=5mm

Reference Value = 70.80 V/m; Power Drift = -0.05 dB

Peak SAR (extrapolated) = 6.83 W/kg

SAR(1 g) = 2.92 W/kg; SAR(10 g) = 1.52 W/kg

Maximum value of SAR (measured) = 4.89 W/kg

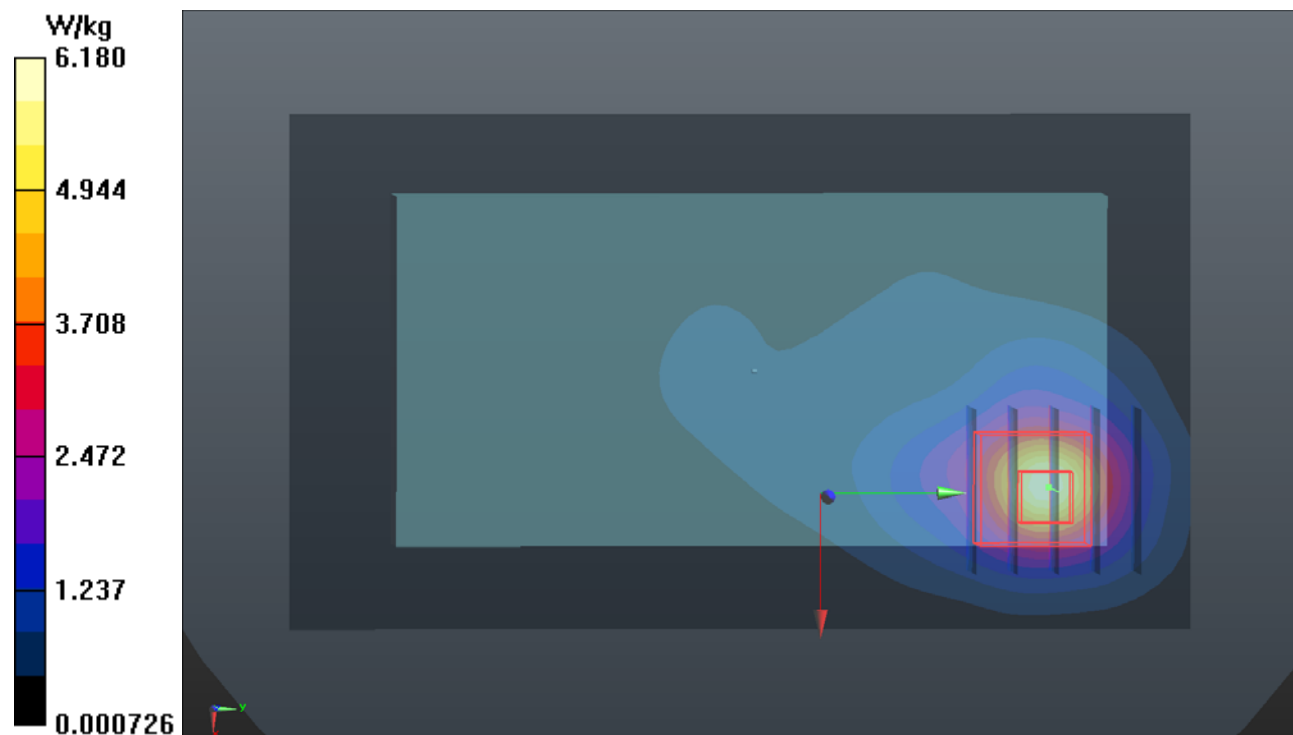

P02_GSM1900_GPRS11_Rear Face_0mm_ch512

DUT: 190813C30

Communication System: GPRS11; Frequency: 1850.2 MHz; Duty Cycle: 1:2.67

Medium: H16T20N1_0909 Medium parameters used: $f = 1850.2$ MHz; $\sigma = 1.422$ S/m; $\epsilon_r = 39.297$;

$\rho = 1000$ kg/m³

Ambient Temperature : 23.6 °C ; Liquid Temperature : 23.1 °C

DASY5 Configuration:

- Probe: EX3DV4 - SN3971; ConvF(8.47, 8.47, 8.47); Calibrated: 2019/03/29
- Sensor-Surface: 1.4mm (Mechanical Surface Detection)
- Electronics: DAE4 Sn1431; Calibrated: 2019/03/25
- Phantom: Twin SAM Phantom_1496; Type: QD000P40CB;
- Measurement SW: DASY52, Version 52.10 (2); SEMCAD X Version 14.6.12 (7470)

- **Area Scan (71x121x1):** Interpolated grid: dx=1.500 mm, dy=1.500 mm

Maximum value of SAR (interpolated) = 3.77 W/kg

- **Zoom Scan (5x5x7)/Cube 0:** Measurement grid: dx=8mm, dy=8mm, dz=5mm

Reference Value = 44.90 V/m; Power Drift = 0.10 dB

Peak SAR (extrapolated) = 5.58 W/kg

SAR(1 g) = 3.04 W/kg; SAR(10 g) = 1.6 W/kg

Maximum value of SAR (measured) = 4.43 W/kg

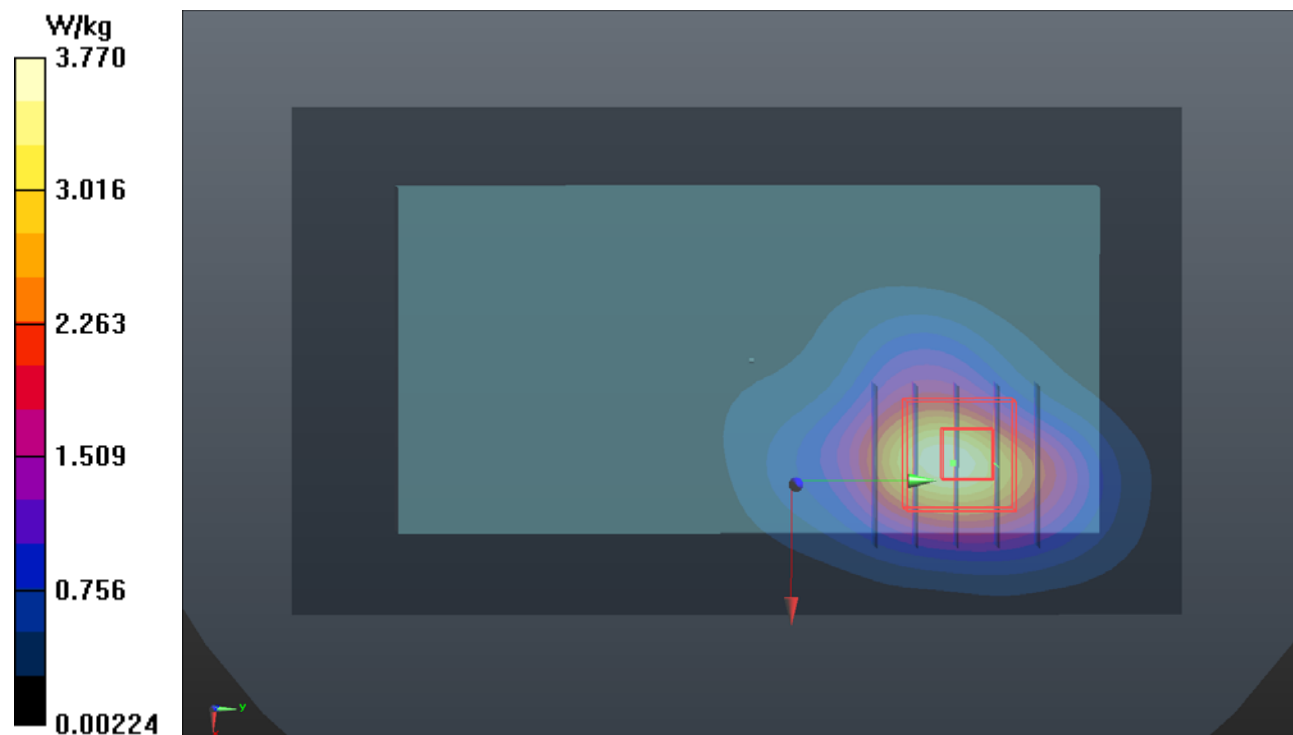

P03 WCDMA II_RMC12.2K_Rear Face_0mm_Ch9262

DUT: 190813C30

Communication System: WCDMA; Frequency: 1852.4 MHz; Duty Cycle: 1:1

Medium: H16T20N1_0905 Medium parameters used: $f = 1852.4$ MHz; $\sigma = 1.415$ S/m; $\epsilon_r = 40.584$; $\rho = 1000$ kg/m³

Ambient Temperature : 23.7 °C ; Liquid Temperature : 23.3 °C

DASY5 Configuration:

- Probe: EX3DV4 - SN7537; ConvF(8.13, 8.13, 8.13); Calibrated: 2019/06/18

- Sensor-Surface: 1.4mm (Mechanical Surface Detection)

- Electronics: DAE4 Sn1585; Calibrated: 2019/06/07

- Phantom: SAM Phantom_1982; Type: QD 000 P41 Ax; Serial: 1982

- Measurement SW: DASY52, Version 52.10 (2); SEMCAD X Version 14.6.12 (7470)

- **Area Scan (71x141x1)**: Interpolated grid: dx=1.500 mm, dy=1.500 mm

Maximum value of SAR (interpolated) = 9.83 W/kg

- **Zoom Scan (5x5x7)/Cube 0**: Measurement grid: dx=8mm, dy=8mm, dz=5mm

Reference Value = 82.70 V/m; Power Drift = -0.08 dB

Peak SAR (extrapolated) = 12.9 W/kg

SAR(1 g) = 6.56 W/kg; SAR(10 g) = 3.21 W/kg

Maximum value of SAR (measured) = 9.89 W/kg

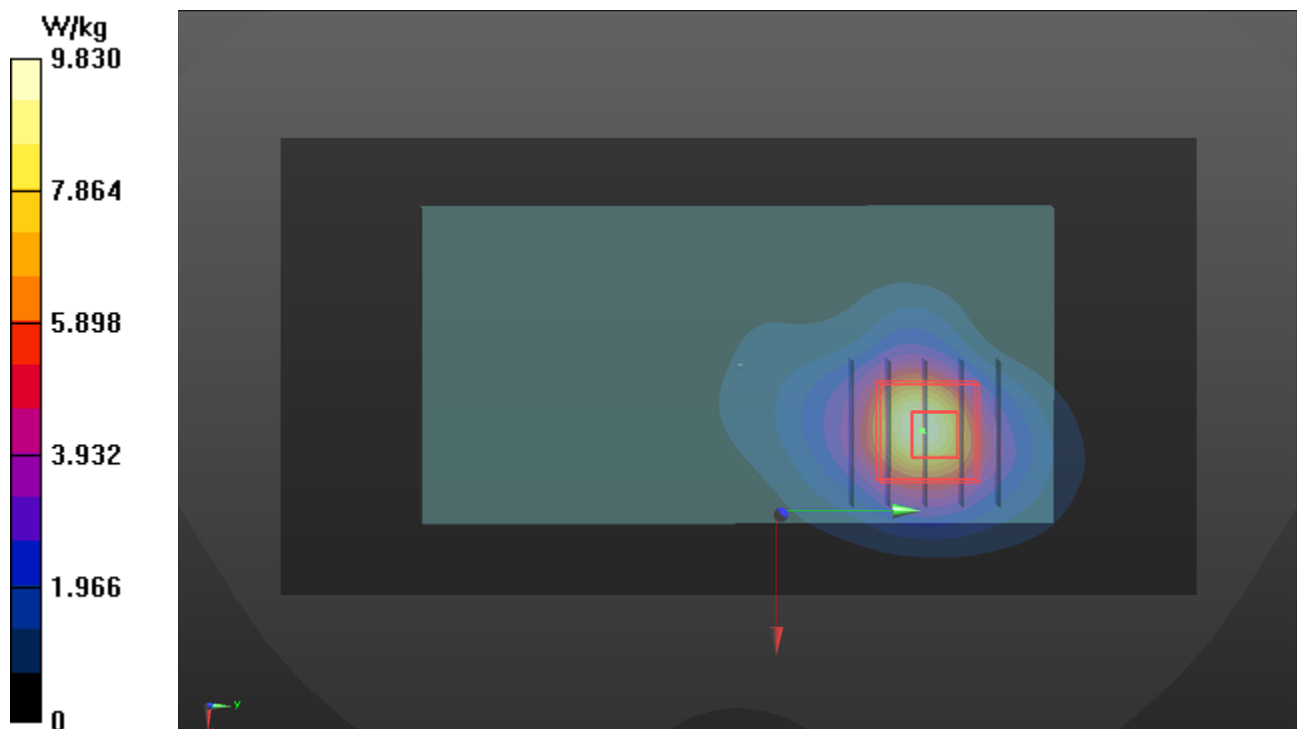

P04 WCDMA V_RMC12.2K_Rear Face_0mm_Ch4233

DUT: 190813C30

Communication System: WCDMA; Frequency: 846.6 MHz; Duty Cycle: 1:1
Medium: H07T10N1_0905 Medium parameters used: $f = 847$ MHz; $\sigma = 0.937$ S/m; $\epsilon_r = 41.855$; $\rho = 1000$ kg/m³
Ambient Temperature : 23.7 °C ; Liquid Temperature : 23.3 °C

DASY5 Configuration:

- Probe: EX3DV4 - SN7537; ConvF(10.48, 10.48, 10.48); Calibrated: 2019/06/18
- Sensor-Surface: 1.4mm (Mechanical Surface Detection)
- Electronics: DAE4 Sn1585; Calibrated: 2019/06/07
- Phantom: SAM Phantom_1982; Type: QD 000 P41 Ax; Serial: 1982
- Measurement SW: DASY52, Version 52.10 (2); SEMCAD X Version 14.6.12 (7470)

- **Area Scan (71x141x1)**: Interpolated grid: dx=1.500 mm, dy=1.500 mm
Maximum value of SAR (interpolated) = 4.58 W/kg

- **Zoom Scan (5x5x7)/Cube 0**: Measurement grid: dx=8mm, dy=8mm, dz=5mm
Reference Value = 63.15 V/m; Power Drift = -0.03 dB
Peak SAR (extrapolated) = 6.53 W/kg
SAR(1 g) = 2.92 W/kg; SAR(10 g) = 1.55 W/kg
Maximum value of SAR (measured) = 4.63 W/kg

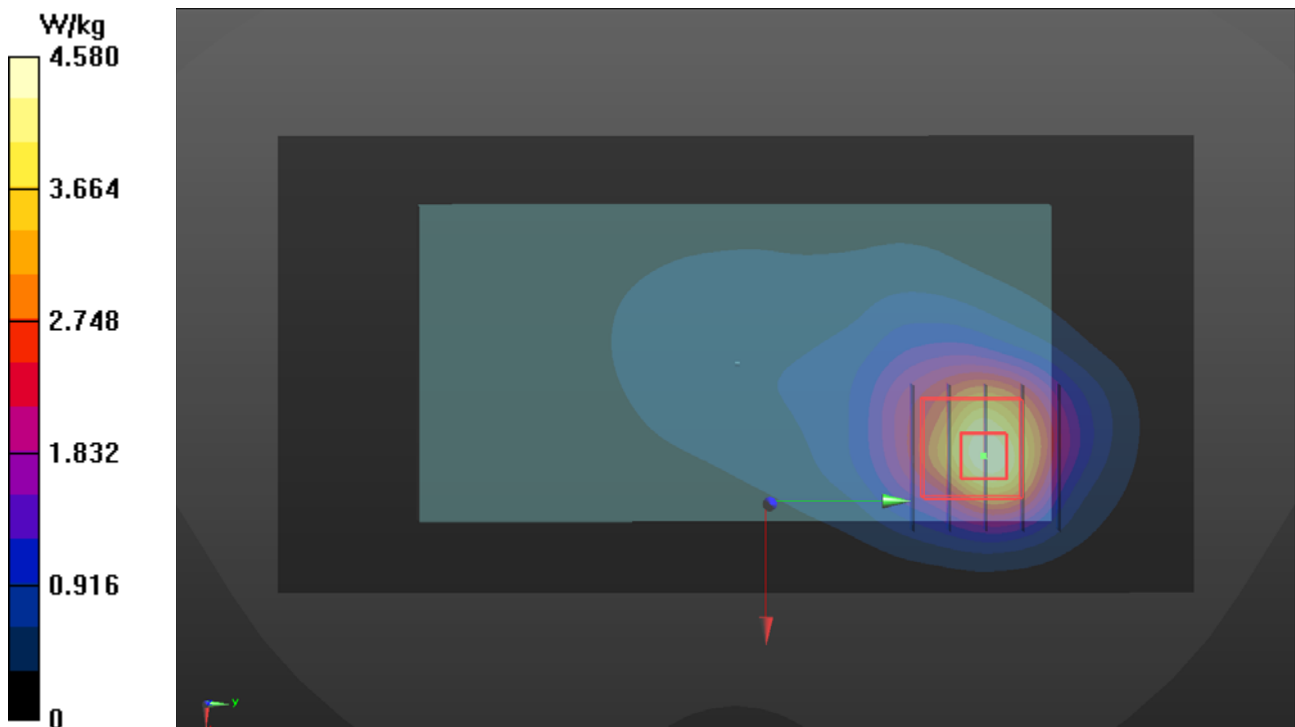

P05_WLAN2.4G_802.11b_Rear Face_0mm_ch11

DUT: 190813C30

Communication System: WLAN_2.4G; Frequency: 2462 MHz; Duty Cycle: 1:1.01

Medium: H19T27N1_0906 Medium parameters used: $f = 2462$ MHz; $\sigma = 1.837$ S/m; $\epsilon_r = 39.238$; $\rho = 1000$ kg/m³

Ambient Temperature : 23.6 °C ; Liquid Temperature : 23.3 °C

DASY5 Configuration:

- Probe: EX3DV4 - SN3971; ConvF(7.65, 7.65, 7.65); Calibrated: 2019/03/29
- Sensor-Surface: 1.4mm (Mechanical Surface Detection)
- Electronics: DAE4 Sn1431; Calibrated: 2019/03/25
- Phantom: Twin SAM Phantom_1496; Type: QD000P40CB;
- Measurement SW: DASY52, Version 52.10 (2); SEMCAD X Version 14.6.12 (7470)

- **Area Scan (91x151x1):** Interpolated grid: dx=1.200 mm, dy=1.200 mm

Maximum value of SAR (interpolated) = 2.25 W/kg

- **Zoom Scan (5x5x7)/Cube 0:** Measurement grid: dx=8mm, dy=8mm, dz=5mm

Reference Value = 32.14 V/m; Power Drift = 0.10 dB

Peak SAR (extrapolated) = 3.06 W/kg

SAR(1 g) = 1.26 W/kg; SAR(10 g) = 0.562 W/kg

Maximum value of SAR (measured) = 2.55 W/kg

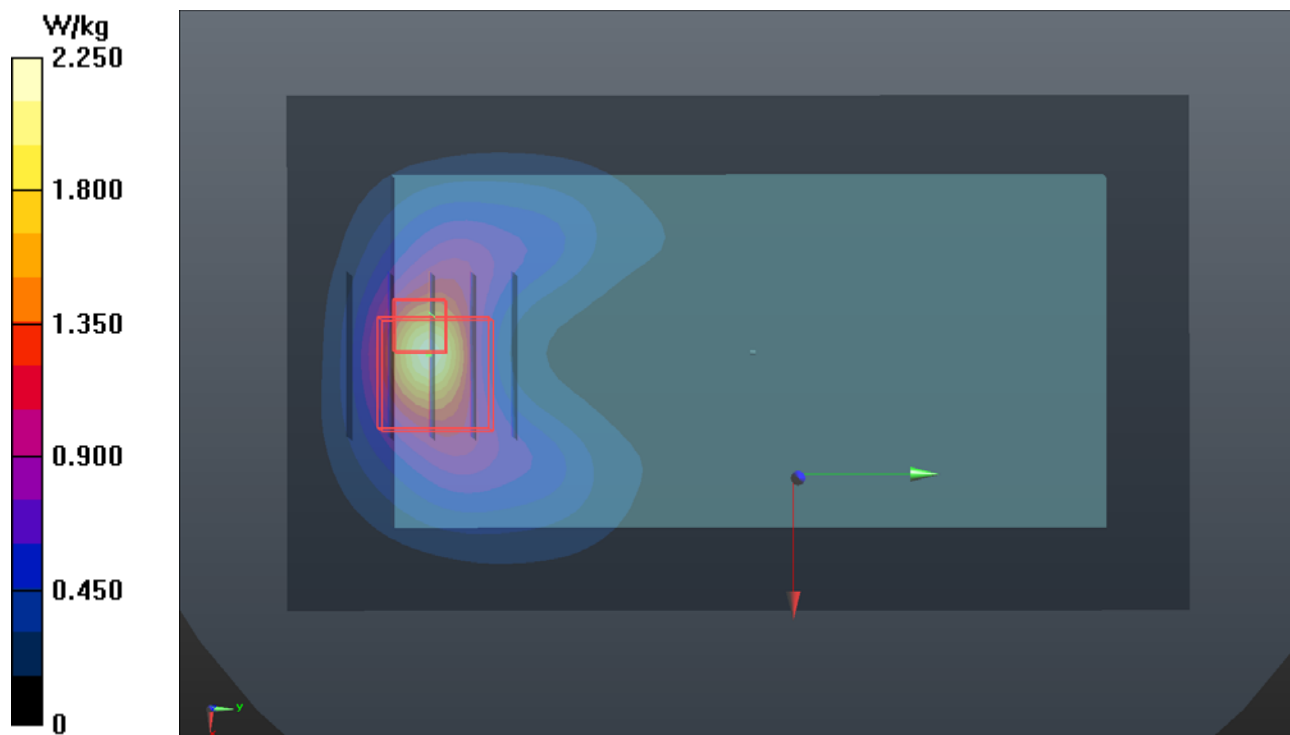

P06_WLAN5.3G_802.11a_Rear Face_0mm_Ch64

DUT: 190813C31

Communication System: WLAN_5G; Frequency: 5320 MHz; Duty Cycle: 1:1.08

Medium: H34T60N1_0909 Medium parameters used: $f = 5320$ MHz; $\sigma = 4.792$ S/m; $\epsilon_r = 36.015$; $\rho = 1000$ kg/m³

Ambient Temperature : 23.8 °C ; Liquid Temperature : 23.2 °C

DASY5 Configuration:

- Probe: EX3DV4 - SN3971; ConvF(5.12, 5.12, 5.12); Calibrated: 2019/03/29
- Sensor-Surface: 1.4mm (Mechanical Surface Detection)
- Electronics: DAE4 Sn1431; Calibrated: 2019/03/25
- Phantom: Twin SAM Phantom_1496; Type: QD000P40CB;
- Measurement SW: DASY52, Version 52.10 (2); SEMCAD X Version 14.6.12 (7470)

- **Area Scan (101x181x1)**: Interpolated grid: dx=1.000 mm, dy=1.000 mm

Maximum value of SAR (interpolated) = 2.46 W/kg

- **Zoom Scan (6x6x12)/Cube 0**: Measurement grid: dx=5mm, dy=5mm, dz=2mm

Reference Value = 18.32 V/m; Power Drift = 0.06 dB

Peak SAR (extrapolated) = 6.00 W/kg

SAR(1 g) = 1.77 W/kg; SAR(10 g) = 0.527 W/kg

Maximum value of SAR (measured) = 4.04 W/kg

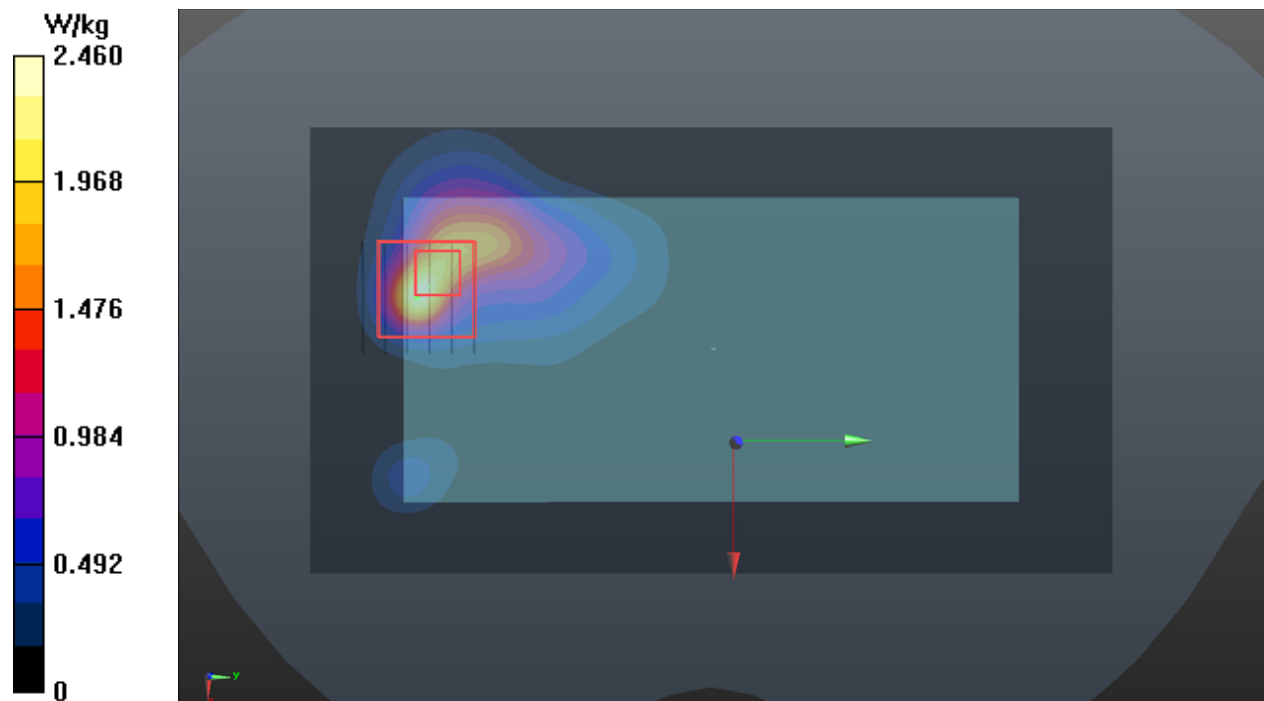

P07_WLAN5.6G_802.11a_Rear Face_0mm_Ch116

DUT: 190813C30

Communication System: WLAN_5G; Frequency: 5580 MHz; Duty Cycle: 1:1.08

Medium: H34T60N1_0909 Medium parameters used: $f = 5580$ MHz; $\sigma = 5.1$ S/m; $\epsilon_r = 35.538$; $\rho = 1000$ kg/m³

Ambient Temperature : 23.6 °C ; Liquid Temperature : 23.1 °C

DASY5 Configuration:

- Probe: EX3DV4 - SN3971; ConvF(4.78, 4.78, 4.78); Calibrated: 2019/03/29
- Sensor-Surface: 1.4mm (Mechanical Surface Detection)
- Electronics: DAE4 Sn1431; Calibrated: 2019/03/25
- Phantom: Twin SAM Phantom_1496; Type: QD000P40CB;
- Measurement SW: DASY52, Version 52.10 (2); SEMCAD X Version 14.6.12 (7470)

- **Area Scan (101x181x1):** Interpolated grid: dx=1.000 mm, dy=1.000 mm

Maximum value of SAR (interpolated) = 1.94 W/kg

- **Zoom Scan (6x6x12)/Cube 0:** Measurement grid: dx=5mm, dy=5mm, dz=2mm

Reference Value = 17.50 V/m; Power Drift = 0.10 dB

Peak SAR (extrapolated) = 7.45 W/kg

SAR(1 g) = 1.81 W/kg; SAR(10 g) = 0.548 W/kg

Maximum value of SAR (measured) = 4.53 W/kg

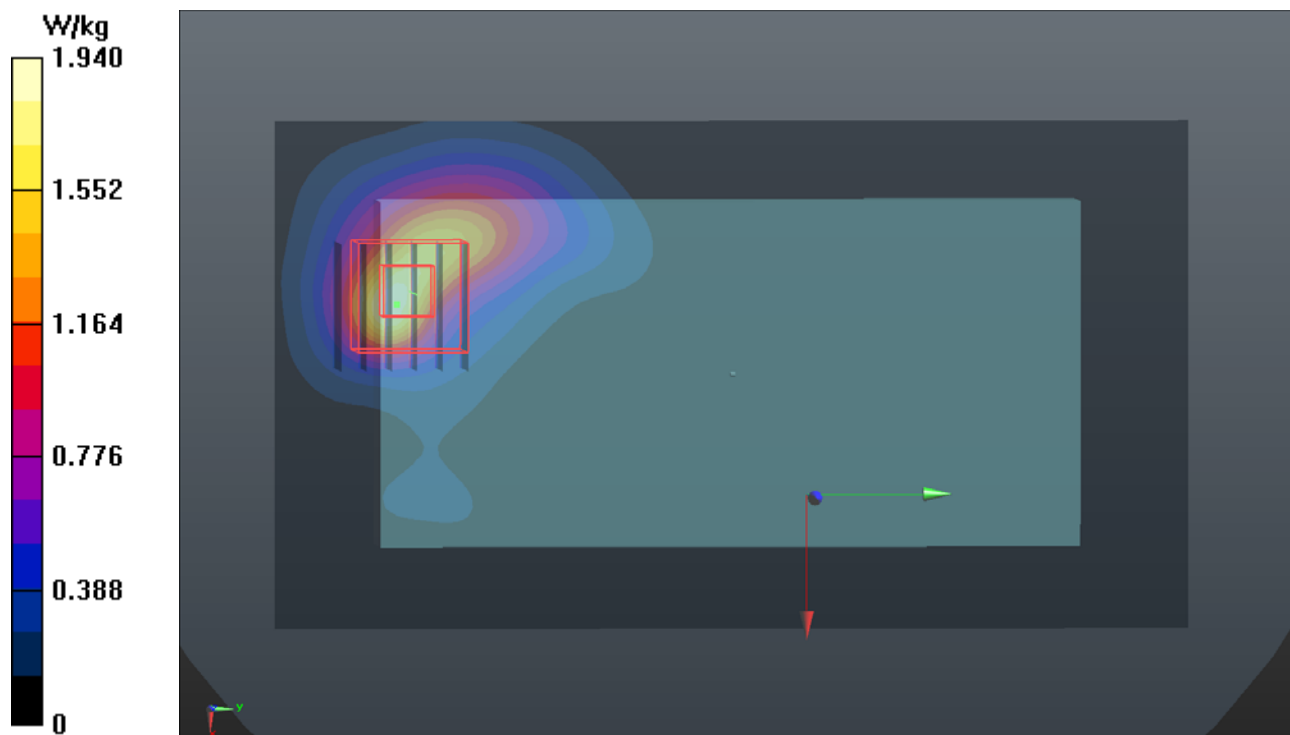

P08_WLAN5.8G_802.11a_Rear Face_0mm_Ch149

DUT: 190813C30

Communication System: WLAN_5G; Frequency: 5745 MHz; Duty Cycle: 1:1.08
Medium: H34T60N1_0909 Medium parameters used: $f = 5745$ MHz; $\sigma = 5.296$ S/m; $\epsilon_r = 35.227$; $\rho = 1000$ kg/m³
Ambient Temperature : 23.8 °C ; Liquid Temperature : 23.2 °C

DASY5 Configuration:

- Probe: EX3DV4 - SN3971; ConvF(4.92, 4.92, 4.92); Calibrated: 2019/03/29
- Sensor-Surface: 1.4mm (Mechanical Surface Detection)
- Electronics: DAE4 Sn1431; Calibrated: 2019/03/25
- Phantom: Twin SAM Phantom_1496; Type: QD000P40CB;
- Measurement SW: DASY52, Version 52.10 (2); SEMCAD X Version 14.6.12 (7470)

- **Area Scan (101x181x1)**: Interpolated grid: dx=1.000 mm, dy=1.000 mm
Maximum value of SAR (interpolated) = 2.06 W/kg

- **Zoom Scan (6x6x12)/Cube 0**: Measurement grid: dx=5mm, dy=5mm, dz=2mm
Reference Value = 13.92 V/m; Power Drift = 0.02 dB
Peak SAR (extrapolated) = 7.03 W/kg
SAR(1 g) = 1.73 W/kg; SAR(10 g) = 0.473 W/kg
Maximum value of SAR (measured) = 4.38 W/kg

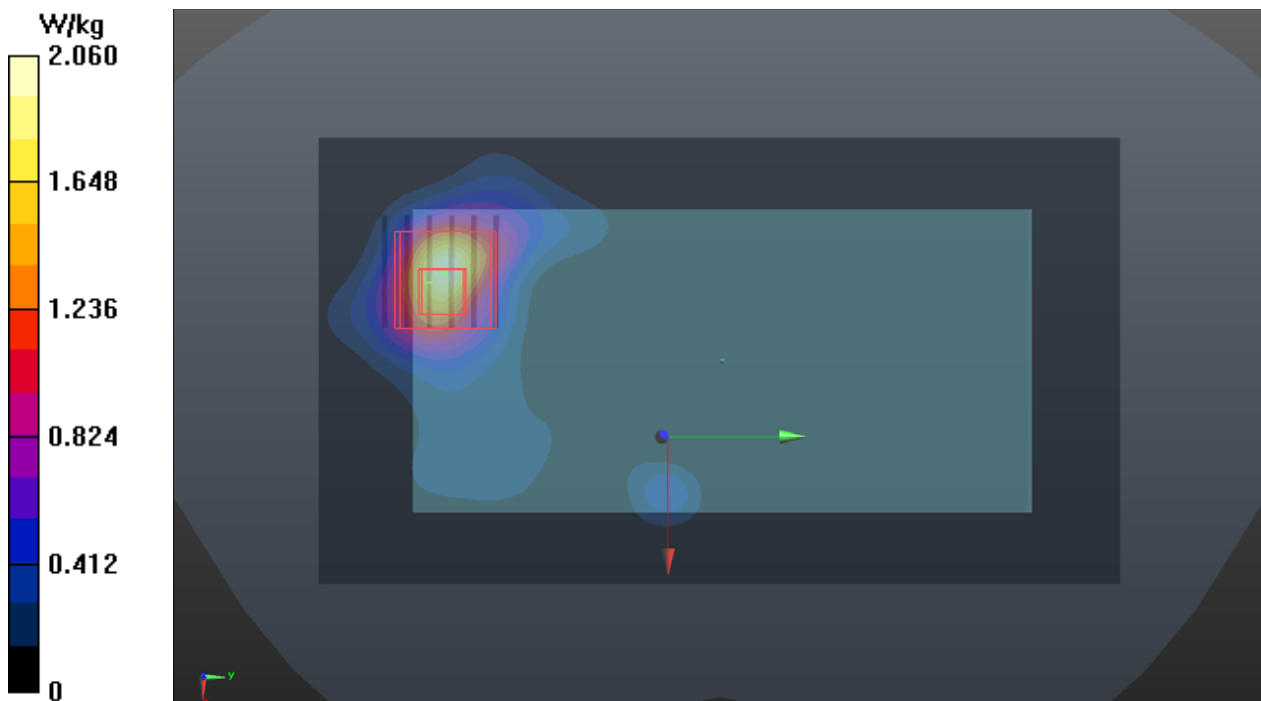

P09_BT_BR_Rear Face_0mm_Ch0

DUT: 190813C30

Communication System: BT; Frequency: 2402 MHz; Duty Cycle: 1:1.30

Medium: H19T27N1_0909 Medium parameters used: $f = 2402$ MHz; $\sigma = 1.833$ S/m; $\epsilon_r = 38.604$; $\rho = 1000$ kg/m³

Ambient Temperature : 23.6 °C ; Liquid Temperature : 23.1 °C

DASY5 Configuration:

- Probe: EX3DV4 - SN3971; ConvF(7.65, 7.65, 7.65); Calibrated: 2019/03/29
- Sensor-Surface: 1.4mm (Mechanical Surface Detection)
- Electronics: DAE4 Sn1431; Calibrated: 2019/03/25
- Phantom: Twin SAM Phantom_1496; Type: QD000P40CB;
- Measurement SW: DASY52, Version 52.10 (2); SEMCAD X Version 14.6.12 (7470)

- **Area Scan (91x151x1):** Interpolated grid: dx=1.200 mm, dy=1.200 mm

Maximum value of SAR (interpolated) = 0.150 W/kg

- **Zoom Scan (5x5x7)/Cube 0:** Measurement grid: dx=8mm, dy=8mm, dz=5mm

Reference Value = 9.172 V/m; Power Drift = 0.04 dB

Peak SAR (extrapolated) = 0.286 W/kg

SAR(1 g) = 0.134 W/kg; SAR(10 g) = 0.051 W/kg

Maximum value of SAR (measured) = 0.201 W/kg

