

FCC Test Report

Report No.: RF190813C30-2

FCC ID: B32E2853GDB

Test Model: e285 3G/BT/WiFi/DS/DB

Received Date: Aug. 13, 2019

Test Date: Aug. 23, 2019 ~ Sep. 11, 2019

Issued Date: Sep. 19, 2019

Applicant: Verifone, Inc.

Address: 1400 West Stanford Ranch Road Suite 200 Rocklin CA 95765 USA

Issued By: Bureau Veritas Consumer Products Services (H.K.) Ltd., Taoyuan Branch
Lin Kou Laboratories

Lab Address: No. 47-2, 14th Ling, Chia Pau Vil., Lin Kou Dist., New Taipei City, Taiwan

Test Location: No.19, Hwa Ya 2nd Rd., Wen Hwa Vil., Kwei Shan Dist., Taoyuan City
33383, Taiwan

**FCC Registration /
Designation Number:** 788550 / TW0003



This report is for your exclusive use. Any copying or replication of this report to or for any other person or entity, or use of our name or trademark, is permitted only with our prior written permission. This report sets forth our findings solely with respect to the test samples identified herein. The results set forth in this report are not indicative or representative of the quality or characteristics of the lot from which a test sample was taken or any similar or identical product unless specifically and expressly noted. Our report includes all of the tests requested by you and the results thereof based upon the information that you provided to us. You have 60 days from date of issuance of this report to notify us of any material error or omission caused by our negligence, provided, however, that such notice shall be in writing and shall specifically address the issue you wish to raise. A failure to raise such issue within the prescribed time shall constitute your unqualified acceptance of the completeness of this report, the tests conducted and the correctness of the report contents. Unless specific mention, the uncertainty of measurement has been explicitly taken into account to declare the compliance or non-compliance to the specification. The report must not be used by the client to claim product certification, approval, or endorsement by TAF or any government agencies.

Table of Contents

Release Control Record	4
1 Certificate of Conformity	5
2 Summary of Test Results	6
2.1 Measurement Uncertainty	6
2.2 Modification Record	6
3 General Information	7
3.1 General Description of EUT	7
3.2 Description of Test Modes	9
3.2.1 Test Mode Applicability and Tested Channel Detail	11
3.3 Duty Cycle of Test Signal	13
3.4 Description of Support Units	14
3.4.1 Configuration of System under Test	14
3.5 General Description of Applied Standards	14
4 Test Types and Results	15
4.1 Radiated Emission and Bandedge Measurement	15
4.1.1 Limits of Radiated Emission and Bandedge Measurement	15
4.1.2 Limits of Unwanted Emission Out of the Restricted Bands	16
4.1.3 Test Instruments	17
4.1.4 Test Procedures	19
4.1.5 Deviation from Test Standard	20
4.1.6 Test Setup	20
4.1.7 EUT Operating Conditions	21
4.1.8 Test Results	22
4.2 Conducted Emission Measurement	62
4.2.1 Limits of Conducted Emission Measurement	62
4.2.2 Test Instruments	62
4.2.3 Test Procedures	63
4.2.4 Deviation from Test Standard	63
4.2.5 Test Setup	63
4.2.6 EUT Operating Conditions	63
4.2.7 Test Results	64
4.3 Transmit Power Measurement	66
4.3.1 Limits of Transmit Power Measurement	66
4.3.2 Test Setup	66
4.3.3 Test Instruments	67
4.3.4 Test Procedure	67
4.3.5 Deviation from Test Standard	67
4.3.6 EUT Operating Conditions	67
4.3.7 Test Results	68
4.4 Occupied Bandwidth Measurement	73
4.4.1 Test Setup	73
4.4.2 Test Instruments	73
4.4.3 Test Procedure	73
4.4.4 Test Results	74
4.5 Peak Power Spectral Density Measurement	77
4.5.1 Limits of Peak Power Spectral Density Measurement	77
4.5.2 Test Setup	77
4.5.3 Test Instruments	77
4.5.4 Test Procedures	77
4.5.5 Deviation from Test Standard	78
4.5.6 EUT Operating Conditions	78
4.5.7 Test Results	79
4.6 Frequency Stability	84

4.6.1	Limit of Frequency Stability Measurement	84
4.6.2	Test Setup	84
4.6.3	Test Instruments	84
4.6.4	Test Procedure	84
4.6.5	Deviation from Test Standard	84
4.6.6	EUT Operating Condition	84
4.6.7	Test Results	85
4.7	6 dB Bandwidth Measurement.....	86
4.7.1	Limits of 6 dB Bandwidth Measurement.....	86
4.7.2	Test Setup.....	86
4.7.3	Test Instruments	86
4.7.4	Test Procedure	86
4.7.5	Deviation from Test Standard	86
4.7.6	EUT Operating Condition	86
4.7.7	Test Results	87
5	Pictures of Test Arrangements.....	89
	Annex A- Radiated Out of Band Emission (OOBE) Measurement (For U-NII-3 band).....	90
	Appendix – Information of the Testing Laboratories	93

Release Control Record

Issue No.	Description	Date Issued
RF190813C30-2	Original Release	Sep. 19, 2019

1 Certificate of Conformity

Product: Point of Sale Terminal

Brand: Verifone

Test Model: e285 3G/BT/WiFi/DS/DB

Sample Status: Identical Prototype

Applicant: Verifone, Inc.

Test Date: Aug. 23, 2019 ~ Sep. 11, 2019

Standards: 47 CFR FCC Part 15, Subpart E (Section 15.407)
ANSI C63.10:2013

The above equipment has been tested by **Bureau Veritas Consumer Products Services (H.K.) Ltd., Taoyuan Branch**, and found compliance with the requirement of the above standards. The test record, data evaluation & Equipment Under Test (EUT) configurations represented herein are true and accurate accounts of the measurements of the sample's RF characteristics under the conditions specified in this report.

Prepared by : Rona Chen, **Date:** Sep. 19, 2019
Rona Chen / Specialist

Approved by : Dylan Chiou, **Date:** Sep. 19, 2019
Dylan Chiou / Project Engineer

2 Summary of Test Results

47 CFR FCC Part 15, Subpart E (Section 15.407)			
FCC Clause	Test Item	Result	Remarks
15.407(b)(6)	AC Power Conducted Emissions	Pass	Meet the requirement of limit. Minimum passing margin is -27.78 dB at 0.67003 MHz.
15.407(b) (1/2/3/4(i/ii)/6)	Radiated Emissions & Band Edge Measurement	Pass	Meet the requirement of limit. Minimum passing margin is -2.05 dB at 5460 MHz.
15.407(a)(1/2/3)	Max Average Transmit Power	Pass	Meet the requirement of limit.
---	Occupied Bandwidth Measurement	-	Reference only
15.407(a)(1/2/3)	Peak Power Spectral Density	Pass	Meet the requirement of limit.
15.407(e)	6 dB Bandwidth	Pass	Meet the requirement of limit. (U-NII-3 Band only)
15.407(g)	Frequency Stability	Pass	Meet the requirement of limit.
15.203	Antenna Requirement	Pass	No antenna connector is used.

Note:

- For U-NII-3 band compliance with rule part 15.407(b)(4)(i), the OOB test plots were recorded in Annex A.
- Determining compliance based on the results of the compliance measurement, not taking into account measurement instrumentation uncertainty.

2.1 Measurement Uncertainty

Where relevant, the following measurement uncertainty levels have been estimated for tests performed on the EUT as specified in CISPR 16-4-2:

Measurement	Frequency	Expanded Uncertainty (k=2) (±)
Conducted Emissions at mains ports	150 kHz ~ 30 MHz	2.94 dB
Radiated Emissions up to 1 GHz	9 kHz ~ 30 MHz	3.04 dB
	30 MHz ~ 200 MHz	2.93 dB
	200 MHz ~ 1000 MHz	2.95 dB
Radiated Emissions above 1 GHz	1 GHz ~ 18 GHz	2.26 dB
	18 GHz ~ 40 GHz	1.94 dB

2.2 Modification Record

There were no modifications required for compliance.

3 General Information

3.1 General Description of EUT

Product	Point of Sale Terminal
Brand	Verifone
Test Model	e285 3G/BT/WiFi/DS/DB
Status of EUT	Identical Prototype
Power Supply Rating	5.0 Vdc (adapter or host equipment) 3.8 Vdc (Li-ion battery)
Modulation Type	256QAM, 64QAM, 16QAM, QPSK, BPSK
Modulation Technology	OFDM
Transfer Rate	802.11a: 54.0/ 48.0/ 36.0/ 24.0/ 18.0/ 12.0/ 9.0/ 6.0 Mbps 802.11n: up to 150.0 Mbps 802.11ac: up to 433.3 Mbps
Operating Frequency	5180 ~ 5240 MHz, 5260 ~ 5320 MHz, 5500 ~ 5700 MHz, 5745 ~ 5825 MHz
Number of Channel	5180 ~ 5240 MHz: 4 for 802.11a, 802.11n (HT20) 2 for 802.11n (HT40) 1 for 802.11ac (VHT80) 5260 ~ 5320 MHz: 4 for 802.11a, 802.11n (HT20) 2 for 802.11n (HT40) 1 for 802.11ac (VHT80) 5500 ~ 5700 MHz: 11 for 802.11a, 802.11n (HT20) 5 for 802.11n (HT40) 2 for 802.11ac (VHT80) 5745 ~ 5825 MHz: 5 for 802.11a, 802.11n (HT20) 2 for 802.11n (HT40) 1 for 802.11ac (VHT80)
Output Power	19.724 mW for 5180 ~ 5240 MHz 17.742 mW for 5260 ~ 5320 MHz 20.37 mW for 5500 ~ 5700 MHz 20.184 mW for 5745 ~ 5825 MHz
Antenna Type	PIFA antenna with 2.85 dBi gain (5180 ~ 5240 MHz) PIFA antenna with 2.99 dBi gain (5260 ~ 5320 MHz) PIFA antenna with 3.74 dBi gain (5500 ~ 5700 MHz) PIFA antenna with 3.54 dBi gain (5745 ~ 5825 MHz)
Antenna Connector	N/A
Accessory Device	Refer to Note as below
Data Cable Supplied	Refer to Note as below

Note:

- The EUT provides 1 completed transmitter and 1 receiver.

Modulation Mode	Tx Function
802.11a	1TX
802.11n (HT20)	1TX
802.11n (HT40)	1TX
802.11ac (VHT80)	1TX

2. The EUT contains following accessory devices.

Product	Brand	Model	Description
Adapter	Verifone	PSAA05A-050QL6V	I/P: 100-240 Vac, 50/60 Hz, 0.2 A O/P: 5 Vdc, 1.0 A Manufacturer: Pihong
Battery	Verifone	BPK087-600	3.8 Vdc, 1800mAh
BT/WLAN Module	Murata	LBEH5HY1LC-981	--
WWAN Module	Gemalto	EHS6	--
USB Cable	Verifone	CBL087-500-01	1m shielded cable w/o core

3. The above EUT information is declared by manufacturer and for more detailed features description, please refers to the manufacturer's specifications or user's manual.

3.2 Description of Test Modes

For 5180 ~ 5240 MHz

4 channels are provided for 802.11a, 802.11n (HT20):

Channel	Frequency (MHz)	Channel	Frequency (MHz)
36	5180	44	5220
40	5200	48	5240

2 channels are provided for 802.11n (HT40):

Channel	Frequency (MHz)	Channel	Frequency (MHz)
38	5190	46	5230

1 channel is provided for 802.11ac (VHT80):

Channel	Frequency (MHz)
42	5210

For 5260 ~ 5320 MHz

4 channels are provided for 802.11a, 802.11n (HT20):

Channel	Frequency (MHz)	Channel	Frequency (MHz)
52	5260	60	5300
56	5280	64	5320

2 channels are provided for 802.11n (HT40):

Channel	Frequency (MHz)	Channel	Frequency (MHz)
54	5270	62	5310

1 channel is provided for 802.11ac (VHT80):

Channel	Frequency (MHz)
58	5290

For 5500 ~ 5700 MHz

11 channels are provided for 802.11a, 802.11n (HT20):

Channel	Frequency (MHz)	Channel	Frequency (MHz)
100	5500	124	5620
104	5520	128	5640
108	5540	132	5660
112	5560	136	5680
116	5580	140	5700
120	5600		

5 channels are provided for 802.11n (HT40):

Channel	Frequency (MHz)	Channel	Frequency (MHz)
102	5510	126	5630
110	5550	134	5670
118	5590		

2 channels are provided for 802.11ac (VHT80):

Channel	Frequency (MHz)	Channel	Frequency (MHz)
106	5530	122	5610

For 5745 ~ 5825 MHz:

5 channels are provided for 802.11a, 802.11n (HT20):

Channel	Frequency (MHz)	Channel	Frequency (MHz)
149	5745	161	5805
153	5765	165	5825
157	5785		

2 channels are provided for 802.11n (HT40):

Channel	Frequency (MHz)	Channel	Frequency (MHz)
151	5755	159	5795

1 channel is provided for 802.11ac (VHT80):

Channel	Frequency (MHz)
155	5775

3.2.1 Test Mode Applicability and Tested Channel Detail

EUT Configure Mode	Applicable To				Description
	RE \geq 1G	RE $<$ 1G	PLC	APCM	
-	√	√	√	√	-

Where **RE \geq 1G**: Radiated Emission above 1 GHz **RE $<$ 1G**: Radiated Emission below 1 GHz
PLC: Power Line Conducted Emission **APCM**: Antenna Port Conducted Measurement

Note: The EUT had been pre-tested on the positioned of each 3 axis. The worst case was found when positioned on **Y-plane**.

Radiated Emission Test (Above 1 GHz):

- Pre-Scan has been conducted to determine the worst-case mode from all possible combinations between available modulations, data rates and antenna ports (if EUT with antenna diversity architecture).
- Following channel(s) was (were) selected for the final test as listed below.

EUT Configure Mode	Frequency Band (MHz)	Mode	Available Channel	Tested Channel	Modulation Technology	Modulation Type	Data Rate (Mbps)
-	5180-5240	802.11a	36 to 48	36, 40, 48	OFDM	BPSK	6.0
-		802.11n (HT20)	36 to 48	36, 40, 48	OFDM	BPSK	6.5
-		802.11n (HT40)	38 to 46	38, 46	OFDM	BPSK	13.5
-		802.11ac (VHT80)	42	42	OFDM	BPSK	29.3
-	5260-5320	802.11a	52 to 64	52, 60, 64	OFDM	BPSK	6.0
-		802.11n (HT20)	52 to 64	52, 60, 64	OFDM	BPSK	6.5
-		802.11n (HT40)	54 to 62	54, 62	OFDM	BPSK	13.5
-		802.11ac (VHT80)	58	58	OFDM	BPSK	29.3
-	5500-5700	802.11a	100 to 140	100, 116, 140	OFDM	BPSK	6.0
-		802.11n (HT20)	100 to 140	100, 116, 140	OFDM	BPSK	6.5
-		802.11n (HT40)	102 to 134	102, 110, 134	OFDM	BPSK	13.5
-		802.11ac (VHT80)	106 to 122	106, 122	OFDM	BPSK	29.3
-	5745-5825	802.11a	149 to 165	149, 157, 165	OFDM	BPSK	6.0
-		802.11n (HT20)	149 to 165	149, 157, 165	OFDM	BPSK	6.5
-		802.11n (HT40)	151 to 159	151, 159	OFDM	BPSK	13.5
-		802.11ac (VHT80)	155	155	OFDM	BPSK	29.3

Radiated Emission Test (Below 1 GHz):

- Pre-Scan has been conducted to determine the worst-case mode from all possible combinations between available modulations, data rates and antenna ports (if EUT with antenna diversity architecture).
- Following channel(s) was (were) selected for the final test as listed below.

EUT Configure Mode	Frequency Band (MHz)	Mode	Available Channel	Tested Channel	Modulation Technology	Modulation Type	Data Rate (Mbps)
-	5500-5700	802.11ac (VHT80)	106 to 122	106	OFDM	BPSK	29.3

Power Line Conducted Emission Test:

- Pre-Scan has been conducted to determine the worst-case mode from all possible combinations between available modulations, data rates and antenna ports (if EUT with antenna diversity architecture).
- Following channel(s) was (were) selected for the final test as listed below.

EUT Configure Mode	Frequency Band (MHz)	Mode	Available Channel	Tested Channel	Modulation Technology	Modulation Type	Data Rate (Mbps)
-	5500-5700	802.11ac (VHT80)	106 to 122	106	OFDM	BPSK	29.3

Antenna Port Conducted Measurement:

- This item includes all test value of each mode, but only includes spectrum plot of worst value of each mode.
- Pre-Scan has been conducted to determine the worst-case mode from all possible combinations between available modulations, data rates and antenna ports (if EUT with antenna diversity architecture).
- Following channel(s) was (were) selected for the final test as listed below.

EUT Configure Mode	Frequency Band (MHz)	Mode	Available Channel	Tested Channel	Modulation Technology	Modulation Type	Data Rate (Mbps)
-	5180-5240	802.11a	36 to 48	36, 40, 48	OFDM	BPSK	6.0
-		802.11n (HT20)	36 to 48	36, 40, 48	OFDM	BPSK	6.5
-		802.11n (HT40)	38 to 46	38, 46	OFDM	BPSK	13.5
-		802.11ac (VHT80)	42	42	OFDM	BPSK	29.3
-	5260-5320	802.11a	52 to 64	52, 60, 64	OFDM	BPSK	6.0
-		802.11n (HT20)	52 to 64	52, 60, 64	OFDM	BPSK	6.5
-		802.11n (HT40)	54 to 62	54, 62	OFDM	BPSK	13.5
-		802.11ac (VHT80)	58	58	OFDM	BPSK	29.3
-	5500-5700	802.11a	100 to 140	100, 116, 140	OFDM	BPSK	6.0
-		802.11n (HT20)	100 to 140	100, 116, 140	OFDM	BPSK	6.5
-		802.11n (HT40)	102 to 134	102, 110, 134	OFDM	BPSK	13.5
-		802.11ac (VHT80)	106 to 122	106, 122	OFDM	BPSK	29.3
-	5745-5825	802.11a	149 to 165	149, 157, 165	OFDM	BPSK	6.0
-		802.11n (HT20)	149 to 165	149, 157, 165	OFDM	BPSK	6.5
-		802.11n (HT40)	151 to 159	151, 159	OFDM	BPSK	13.5
-		802.11ac (VHT80)	155	155	OFDM	BPSK	29.3

Test Condition:

Applicable To	Environmental Conditions	Input Power	Tested by
RE≥1G	25 deg. C, 65 % RH	120 Vac, 60 Hz	Tim Chen
RE<1G	25 deg. C, 65 % RH	120 Vac, 60 Hz	Tim Chen
PLC	25 deg. C, 65 % RH	120 Vac, 60 Hz	Thomas Wei
APCM	25 deg. C, 65 % RH	3.8 Vdc	Vincent Huang

3.3 Duty Cycle of Test Signal

MODULATION TYPE: BPSK

802.11a: Duty cycle = $1.425/1.539 = 0.926$, Duty factor = $10 * \log(1/0.926) = 0.33$

802.11n (HT20): Duty cycle = $1.334/1.445 = 0.923$, Duty factor = $10 * \log(1/0.923) = 0.35$

802.11n (HT40): Duty cycle = $0.965/1.07 = 0.902$, Duty factor = $10 * \log(1/0.902) = 0.45$

802.11ac (VHT80): Duty cycle = $0.666/0.690 = 0.965$, Duty factor = $10 * \log(1/0.965) = 0.15$

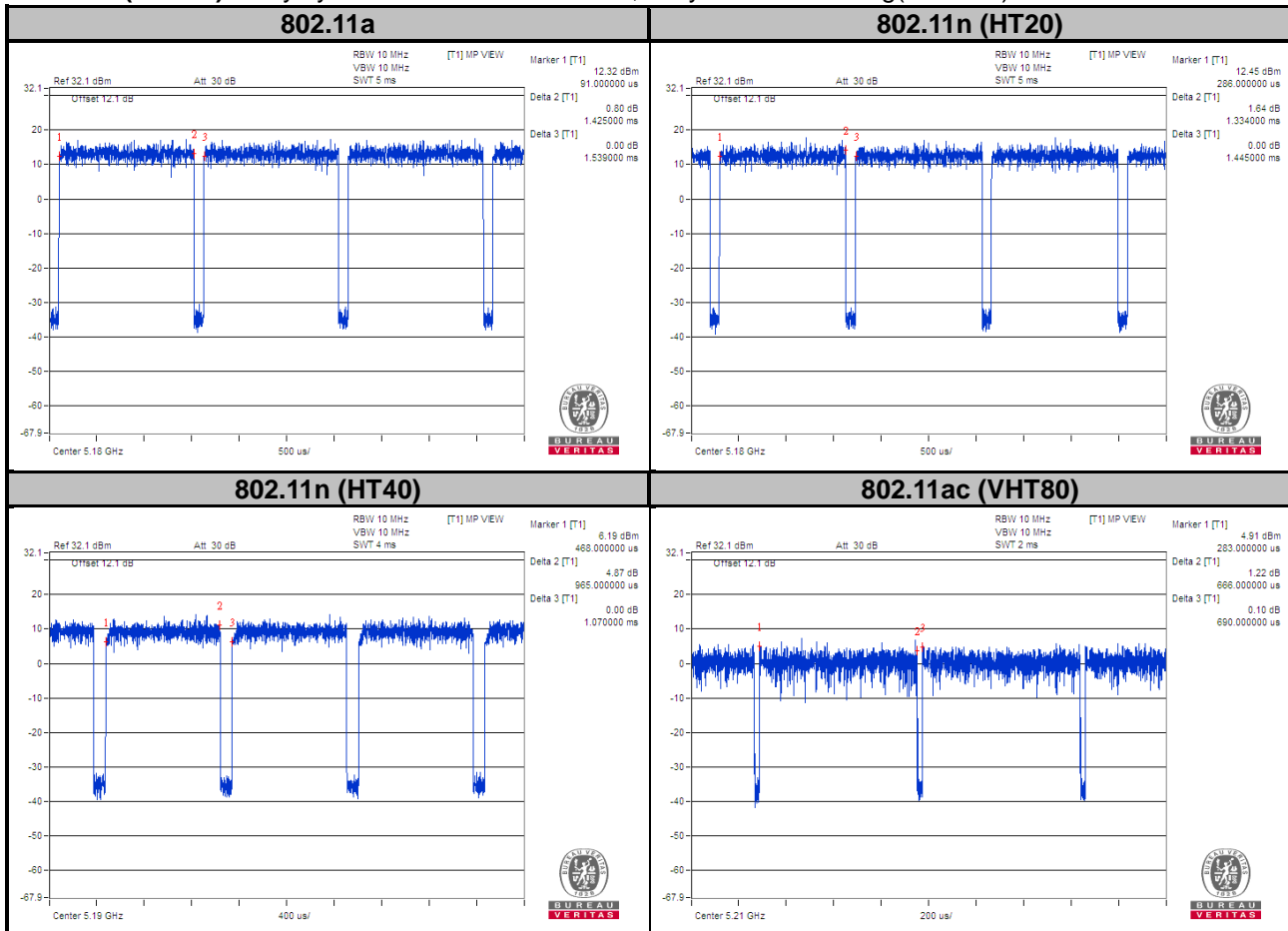

3.4 Description of Support Units

The EUT has been tested as an independent unit together with other necessary accessories or support units.

3.4.1 Configuration of System under Test

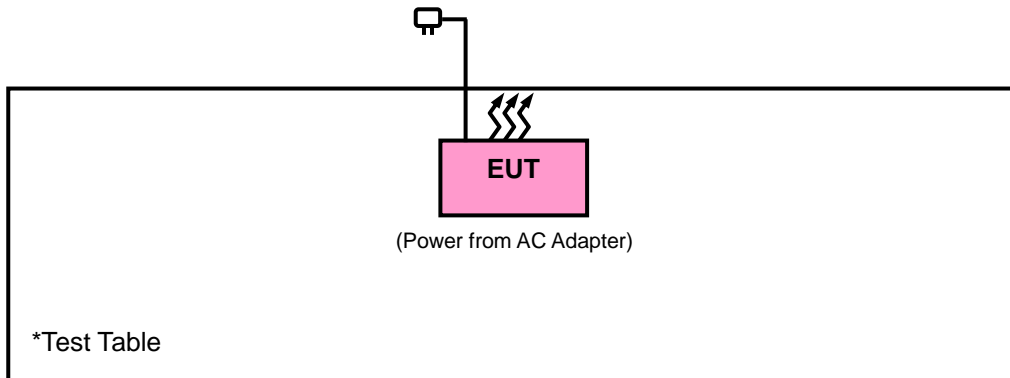

3.5 General Description of Applied Standards

The EUT is a RF Product. According to the specifications of the manufacturer, it must comply with the requirements of the following standards:

FCC Part 15, Subpart E (15.407)

KDB 789033 D02 General UNII Test Procedures New Rules v02r01

ANSI C63.10-2013

All test items have been performed and recorded as per the above standards.

4 Test Types and Results

4.1 Radiated Emission and Bandedge Measurement

4.1.1 Limits of Radiated Emission and Bandedge Measurement

Radiated emissions which fall in the restricted bands must comply with the radiated emission limits specified as below table.

Frequencies (MHz)	Field Strength (microvolts/meter)	Measurement Distance (meters)
0.009 ~ 0.490	2400/F (kHz)	300
0.490 ~ 1.705	24000/F (kHz)	30
1.705 ~ 30.0	30	30
30 ~ 88	100	3
88 ~ 216	150	3
216 ~ 960	200	3
Above 960	500	3

Note:

1. The lower limit shall apply at the transition frequencies.
2. Emission level (dBuV/m) = 20 log Emission level (uV/m).
3. For frequencies above 1000 MHz, the field strength limits are based on average detector, however, the peak field strength of any emission shall not exceed the maximum permitted average limits, specified above by more than 20 dB under any condition of modulation.

4.1.2 Limits of Unwanted Emission Out of the Restricted Bands

Applicable To		Limit	
789033 D02 General UNII Test Procedures New Rules v02r01		Field Strength at 3 m	
		PK: 74 (dBµV/m)	AV: 54 (dBµV/m)
Frequency Band	Applicable To	EIRP Limit	Equivalent Field Strength at 3 m
5150~5250 MHz	15.407(b)(1)	PK: -27 (dBm/MHz)	PK: 68.2 (dBµV/m)
5250~5350 MHz	15.407(b)(2)		
5470~5725 MHz	15.407(b)(3)		
5725~5850 MHz	<input checked="" type="checkbox"/> 15.407(b)(4)(i)	PK:-27 (dBm/MHz) ^{*1} PK:10 (dBm/MHz) ^{*2} PK:15.6 (dBm/MHz) ^{*3} PK:27 (dBm/MHz) ^{*4}	PK: 68.2 (dBµV/m) ^{*1} PK:105.2 (dBµV/m) ^{*2} PK: 110.8 (dBµV/m) ^{*3} PK:122.2 (dBµV/m) ^{*4}
	<input type="checkbox"/> 15.407(b)(4)(ii)	Emission limits in section 15.247(d)	

^{*1} beyond 75 MHz or more above of the band edge.

^{*2} below the band edge increasing linearly to 10 dBm/MHz at 25 MHz above.

^{*3} below the band edge increasing linearly to a level of 15.6 dBm/MHz at 5 MHz above.

^{*4} from 5 MHz above or below the band edge increasing linearly to a level of 27 dBm/MHz at the band edge.

Note:

The following formula is used to convert the equipment isotropic radiated power (eirp) to field strength:

$$E = \frac{1000000\sqrt{30P}}{3} \mu\text{V/m, where } P \text{ is the eirp (Watts).}$$

4.1.3 Test Instruments

Description & Manufacturer	Model No.	Serial No.	Date of Calibration	Due Date of Calibration
Test Receiver Agilent	N9038A	MY51210203	Mar. 18, 2019	Mar. 17, 2020
Spectrum Analyzer Agilent	N9010A	MY52220314	Dec. 13, 2018	Dec. 12, 2019
Spectrum Analyzer ROHDE & SCHWARZ	FSU43	101261	Apr. 15, 2019	Apr. 14, 2020
Broadband Horn Antenna SCHWARZBECK	BBHA 9170	148	Nov. 25, 2018	Nov. 24, 2019
HORN Antenna SCHWARZBECK	BBHA 9120D	9120D-969	Nov. 25, 2018	Nov. 24, 2019
BILOG Antenna SCHWARZBECK	VULB 9168	9168-472	Nov. 23, 2018	Nov. 22, 2019
Fixed Attenuator WORKEN	MDCS18N-10	MDCS18N-10-01	Apr. 15, 2019	Apr. 14, 2020
Loop Antenna	HLA 6121	45745	Jul. 01, 2019	Jun. 30, 2020
Preamplifier EMCI	EMC001340	980201	Oct. 12, 2018	Oct. 11, 2019
Preamplifier EMCI	EMC 012645	980115	Oct. 12, 2018	Oct. 11, 2019
Preamplifier EMCI	EMC 184045	980116	Oct. 12, 2018	Oct. 11, 2019
Preamplifier EMCI	EMC 330H	980112	Oct. 12, 2018	Oct. 11, 2019
Power Meter Anritsu	ML2495A	1012010	Sep. 05, 2018	Sep. 04, 2019
			Sep. 04, 2019	Sep. 03, 2020
Power Sensor Anritsu	MA2411B	1315050	Sep. 04, 2018	Sep. 03, 2019
			Sep. 04, 2019	Sep. 03, 2020
RF Coaxial Cable HUBER+SUHNNER	EMC104-SM-SM-8 000&3000	140811+170717	Oct. 12, 2018	Oct. 11, 2019
RF Coaxial Cable HUBER+SUHNNER	SUCOFLEX 104	EMC104-SM-SM-1 000(140807)	Oct. 12, 2018	Oct. 11, 2019
RF Coaxial Cable WOKEN	8D-FB	Cable-Ch10-01	Oct. 12, 2018	Oct. 11, 2019
Software BV ADT	E3 6.120103	NA	NA	NA
Antenna Tower MF	MFA-440H	NA	NA	NA
Turn Table MF	MFT-201SS	NA	NA	NA
Antenna Tower & Turn Table Controller MF	MF-7802	NA	NA	NA
Temperature & Humidity Chamber	GTH-120-40-CP-A R	MAA1306-019	Sep. 05, 2018	Sep. 04, 2019
			Sep. 06, 2019	Sep. 05, 2020
DC Power Supply Topward	33010D	807748	Oct. 24, 2018	Oct. 23, 2019
Digital Multimeter Fluke	87-III	70360742	Jun. 27, 2019	Jun. 26, 2020

- Note: 1. The calibration interval of the above test instruments is 12 months and the calibrations are traceable to NML/ROC and NIST/USA.
2. The test was performed in HwaYa Chamber 10.

4.1.4 Test Procedures

For Radiated Emission below 30 MHz

- a. The EUT was placed on the top of a rotating table 0.8 meters above the ground at a 3 meter chamber room. The table was rotated 360 degrees to determine the position of the highest radiation.
- b. The EUT was set 3 meters away from the interference-receiving antenna, which was mounted on the top of a variable-height antenna tower.
- c. Both Parallel, perpendicular, and ground-parallel orientations of the antenna are set to make the measurement.
- d. For each suspected emission, the EUT was arranged to its worst case and the rotatable table was turned from 0 degrees to 360 degrees to find the maximum reading.
- e. The test-receiver system was set to Quasi-Peak Detect Function and Specified Bandwidth with Maximum Hold Mode.

Note:

1. The resolution bandwidth and video bandwidth of test receiver/spectrum analyzer is 9 kHz at frequency below 30 MHz.

For Radiated Emission above 30 MHz

- a. The EUT was placed on the top of a rotating table 0.8 meters (for 30 MHz ~ 1 GHz) / 1.5 meters (for above 1 GHz) above the ground at 3 meter chamber room for test. The table was rotated 360 degrees to determine the position of the highest radiation.
- b. The EUT was set 3 meters away from the interference-receiving antenna, which was mounted on the top of a variable-height antenna tower.
- c. The height of antenna is varied from one meter to four meters above the ground to determine the maximum value of the field strength. Both horizontal and vertical polarizations of the antenna are set to make the measurement.
- d. For each suspected emission, the EUT was arranged to its worst case and then the antenna was tuned to heights from 1 meter to 4 meters and the rotatable table was turned from 0 degrees to 360 degrees to find the maximum reading.
- e. The test-receiver system was set to quasi-peak detect function and specified bandwidth with maximum hold mode when the test frequency is below 1 GHz.
- f. The test-receiver system was set to peak and average detected function and specified bandwidth with maximum hold mode when the test frequency is above 1 GHz. If the peak reading value also meets average limit, measurement with the average detector is unnecessary.

Note:

1. The resolution bandwidth and video bandwidth of test receiver/spectrum analyzer is 120 kHz for Quasi-peak detection (QP) or Peak detection (PK) at frequency below 1 GHz.
2. The resolution bandwidth of test receiver/spectrum analyzer is 1 MHz and the video bandwidth is 3 MHz for Peak detection (PK) at frequency above 1 GHz.
3. The resolution bandwidth of test receiver/spectrum analyzer is 1 MHz and the video bandwidth is $\geq 1/T$ (Duty cycle < 98 %) or 10 Hz (Duty cycle ≥ 98 %) for Average detection (AV) at frequency above 1 GHz.
(11a: RBW = 1 MHz, VBW = 1 kHz ; 11n (HT20): RBW = 1 MHz, VBW = 1 kHz ;
11n (HT40): RBW = 1 MHz, VBW = 3 kHz ; 11ac (VHT80): RBW = 1 MHz, VBW = 3 kHz)
4. All modes of operation were investigated and the worst-case emissions are reported.

4.1.5 Deviation from Test Standard

No deviation.

4.1.6 Test Setup

<Radiated Emission below 30 MHz>

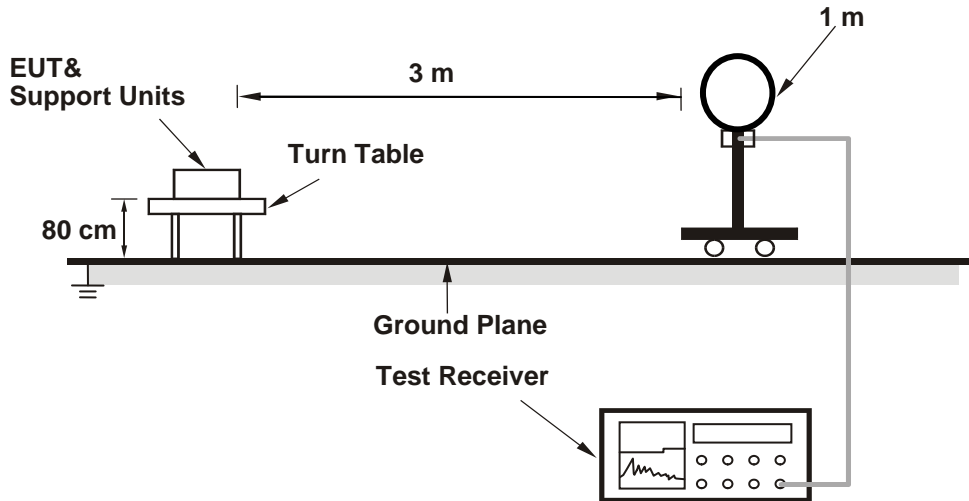

<Radiated Emission 30 MHz to 1 GHz>

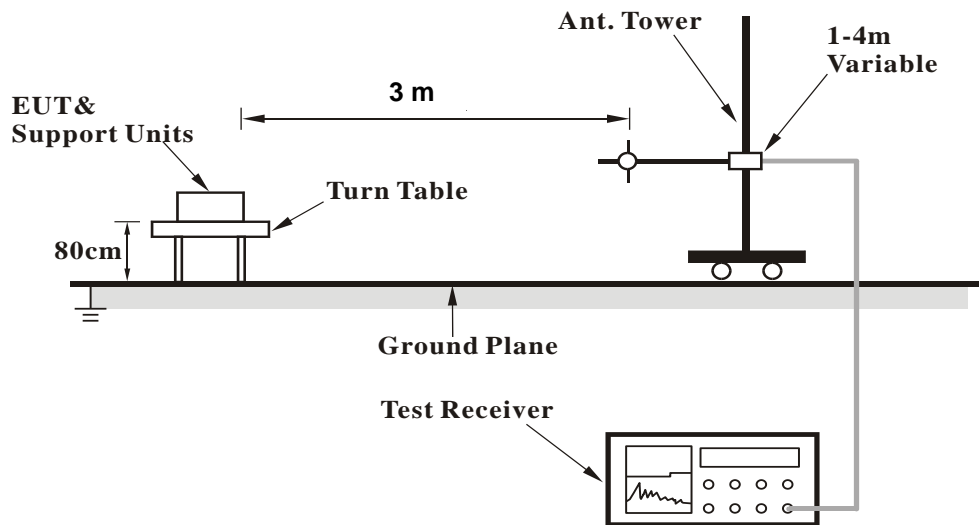

<Radiated Emission above 1 GHz>

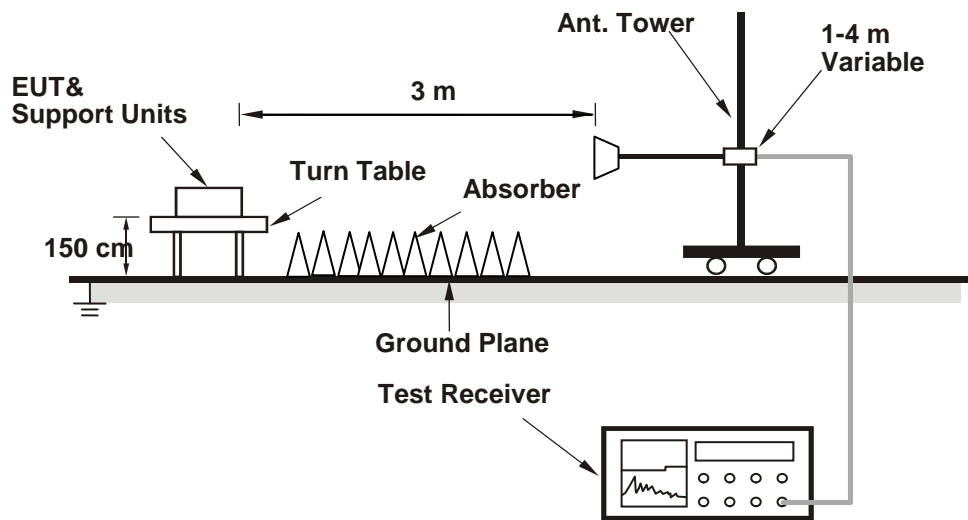

For the actual test configuration, please refer to the attached file (Test Setup Photo).

4.1.7 EUT Operating Conditions

- Placed the EUT on a testing table.
- Use the software to control the EUT under transmission condition continuously at specific channel frequency.

4.1.8 Test Results
Above 1 GHz Data :
802.11a

EUT Test Condition		Measurement Detail	
Channel	Channel 36	Frequency Range	1 GHz ~ 40 GHz
Input Power	120 Vac, 60 Hz	Detector Function	Peak (PK) Average (AV)
Environmental Conditions	25 deg. C, 65 % RH	Tested By	Tim Chen

Antenna Polarity & Test Distance: Horizontal at 3 m								
Frequency (MHz)	Emission Level (dBuV/m)	Read Level (dBuV)	Factor (dB/m)	Limit (dBuV/m)	Margin (dB)	Antenna Height (cm)	Table Angle (Degree)	Remark
5150	50.15	48.62	1.53	54	-3.85	109	111	Average
5150	64.79	63.26	1.53	74	-9.21	109	111	Peak
5180	101.38	99.85	1.53			109	111	Average
5180	107.59	106.06	1.53			109	111	Peak
*10360	54.98	57.82	-2.84	68.2	-13.22	158	241	Peak
Antenna Polarity & Test Distance: Vertical at 3 m								
Frequency (MHz)	Emission Level (dBuV/m)	Read Level (dBuV)	Factor (dB/m)	Limit (dBuV/m)	Margin (dB)	Antenna Height (cm)	Table Angle (Degree)	Remark
5150	51.53	50	1.53	54	-2.47	108	66	Average
5150	65.07	63.54	1.53	74	-8.93	108	66	Peak
5180	100.59	99.06	1.53			108	66	Average
5180	107.92	106.39	1.53			108	66	Peak
*10360	54.2	57.04	-2.84	68.2	-14	129	102	Peak

Remarks:

- Emission Level = Read Level + Factor
Margin value = Emission level – Limit value
- 5180 MHz: Fundamental Frequency
- *: Out of Restricted Band
- The emission levels of other frequencies were very low against the limit

EUT Test Condition		Measurement Detail	
Channel	Channel 40	Frequency Range	1 GHz ~ 40 GHz
Input Power	120 Vac, 60 Hz	Detector Function	Peak (PK) Average (AV)
Environmental Conditions	25 deg. C, 65 % RH	Tested By	Tim Chen

Antenna Polarity & Test Distance: Horizontal at 3 m								
Frequency (MHz)	Emission Level (dBuV/m)	Read Level (dBuV)	Factor (dB/m)	Limit (dBuV/m)	Margin (dB)	Antenna Height (cm)	Table Angle (Degree)	Remark
5150	45.28	43.75	1.53	54	-8.72	100	110	Average
5150	56.52	54.99	1.53	74	-17.48	100	110	Peak
5200	100.34	98.81	1.53			100	110	Average
5200	106.6	105.07	1.53			100	110	Peak
5350	41.58	40.12	1.46	54	-12.42	100	110	Average
5350	50.97	49.51	1.46	74	-23.03	100	110	Peak
*10400	54.57	57.46	-2.89	68.2	-13.63	204	139	Peak
Antenna Polarity & Test Distance: Vertical at 3 m								
Frequency (MHz)	Emission Level (dBuV/m)	Read Level (dBuV)	Factor (dB/m)	Limit (dBuV/m)	Margin (dB)	Antenna Height (cm)	Table Angle (Degree)	Remark
5150	44.88	43.35	1.53	54	-9.12	104	75	Average
5150	52.72	51.19	1.53	74	-21.28	104	75	Peak
5200	100.68	99.15	1.53			104	75	Average
5200	107.36	105.83	1.53			104	75	Peak
5350	42.09	40.63	1.46	54	-11.91	104	75	Average
5350	50.38	48.92	1.46	74	-23.62	104	75	Peak
*10400	54.29	57.18	-2.89	68.2	-13.91	113	219	Peak

Remarks:

- Emission Level = Read Level + Factor
Margin value = Emission level – Limit value
- 5200 MHz: Fundamental Frequency
- *: Out of Restricted Band
- The emission levels of other frequencies were very low against the limit

EUT Test Condition		Measurement Detail	
Channel	Channel 48	Frequency Range	1 GHz ~ 40 GHz
Input Power	120 Vac, 60 Hz	Detector Function	Peak (PK) Average (AV)
Environmental Conditions	25 deg. C, 65 % RH	Tested By	Tim Chen

Antenna Polarity & Test Distance: Horizontal at 3 m								
Frequency (MHz)	Emission Level (dBuV/m)	Read Level (dBuV)	Factor (dB/m)	Limit (dBuV/m)	Margin (dB)	Antenna Height (cm)	Table Angle (Degree)	Remark
5150	41.03	39.5	1.53	54	-12.97	108	109	Average
5150	50.93	49.4	1.53	74	-23.07	108	109	Peak
5240	99.3	97.92	1.38			108	109	Average
5240	105.81	104.43	1.38			108	109	Peak
5350	41.21	39.75	1.46	54	-12.79	108	109	Average
5350	50.53	49.07	1.46	74	-23.47	108	109	Peak
*10480	54.83	57.56	-2.73	68.2	-13.37	191	122	Peak
Antenna Polarity & Test Distance: Vertical at 3 m								
Frequency (MHz)	Emission Level (dBuV/m)	Read Level (dBuV)	Factor (dB/m)	Limit (dBuV/m)	Margin (dB)	Antenna Height (cm)	Table Angle (Degree)	Remark
5150	41.37	39.84	1.53	54	-12.63	100	73	Average
5150	50.06	48.53	1.53	74	-23.94	100	73	Peak
5240	100.24	98.86	1.38			100	73	Average
5240	106.52	105.14	1.38			100	73	Peak
5350	41.47	40.01	1.46	54	-12.53	100	73	Average
5350	51.11	49.65	1.46	74	-22.89	100	73	Peak
*10480	54.77	57.5	-2.73	68.2	-13.43	116	305	Peak

Remarks:

- Emission Level = Read Level + Factor
Margin value = Emission level – Limit value
- 5240 MHz: Fundamental Frequency
- *: Out of Restricted Band
- The emission levels of other frequencies were very low against the limit

EUT Test Condition		Measurement Detail	
Channel	Channel 52	Frequency Range	1 GHz ~ 40 GHz
Input Power	120 Vac, 60 Hz	Detector Function	Peak (PK) Average (AV)
Environmental Conditions	25 deg. C, 65 % RH	Tested By	Tim Chen

Antenna Polarity & Test Distance: Horizontal at 3 m								
Frequency (MHz)	Emission Level (dBuV/m)	Read Level (dBuV)	Factor (dB/m)	Limit (dBuV/m)	Margin (dB)	Antenna Height (cm)	Table Angle (Degree)	Remark
5143.46	41.02	39.47	1.55	54	-12.98	100	24	Average
5143.46	51.09	49.54	1.55	74	-22.91	100	24	Peak
5260	92.36	91.05	1.31			100	24	Average
5260	98.77	97.46	1.31			100	24	Peak
5445.48	40.88	39.1	1.78	54	-13.12	100	24	Average
5445.48	51.66	49.88	1.78	74	-22.34	100	24	Peak
*10520	55.03	57.75	-2.72	68.2	-13.17	189	331	Peak
Antenna Polarity & Test Distance: Vertical at 3 m								
Frequency (MHz)	Emission Level (dBuV/m)	Read Level (dBuV)	Factor (dB/m)	Limit (dBuV/m)	Margin (dB)	Antenna Height (cm)	Table Angle (Degree)	Remark
5143.64	41.19	39.64	1.55	54	-12.81	100	80	Average
5143.64	51.16	49.61	1.55	74	-22.84	100	80	Peak
5260	100.3	98.99	1.31			100	80	Average
5260	106.25	104.94	1.31			100	80	Peak
5447.9	41.44	39.62	1.82	54	-12.56	100	80	Average
5447.9	50.8	48.98	1.82	74	-23.2	100	80	Peak
*10520	55.8	58.52	-2.72	68.2	-12.4	103	157	Peak

Remarks:

- Emission Level = Read Level + Factor
Margin value = Emission level – Limit value
- 5260 MHz: Fundamental Frequency
- *: Out of Restricted Band
- The emission levels of other frequencies were very low against the limit

EUT Test Condition		Measurement Detail	
Channel	Channel 60	Frequency Range	1 GHz ~ 40 GHz
Input Power	120 Vac, 60 Hz	Detector Function	Peak (PK) Average (AV)
Environmental Conditions	25 deg. C, 65 % RH	Tested By	Tim Chen

Antenna Polarity & Test Distance: Horizontal at 3 m								
Frequency (MHz)	Emission Level (dBuV/m)	Read Level (dBuV)	Factor (dB/m)	Limit (dBuV/m)	Margin (dB)	Antenna Height (cm)	Table Angle (Degree)	Remark
5300	95.25	93.94	1.31			208	141	Average
5300	102.15	100.84	1.31			208	141	Peak
5350	41.58	40.12	1.46	54	-12.42	208	141	Average
5350	50.63	49.17	1.46	74	-23.37	208	141	Peak
10600	46.29	49.2	-2.91	54	-7.71	179	255	Average
10600	55.47	58.38	-2.91	74	-18.53	179	255	Peak
Antenna Polarity & Test Distance: Vertical at 3 m								
Frequency (MHz)	Emission Level (dBuV/m)	Read Level (dBuV)	Factor (dB/m)	Limit (dBuV/m)	Margin (dB)	Antenna Height (cm)	Table Angle (Degree)	Remark
5300	99.54	98.23	1.31			114	69	Average
5300	105.8	104.49	1.31			114	69	Peak
5350.88	43.17	41.71	1.46	54	-10.83	114	69	Average
5350.88	53.16	51.7	1.46	74	-20.84	114	69	Peak
10600	46.57	49.48	-2.91	54	-7.43	167	190	Average
10600	55.82	58.73	-2.91	74	-18.18	167	190	Peak

Remarks:

- Emission Level = Read Level + Factor
Margin value = Emission level – Limit value
- 5300 MHz: Fundamental Frequency
- *: Out of Restricted Band
- The emission levels of other frequencies were very low against the limit

EUT Test Condition		Measurement Detail	
Channel	Channel 64	Frequency Range	1 GHz ~ 40 GHz
Input Power	120 Vac, 60 Hz	Detector Function	Peak (PK) Average (AV)
Environmental Conditions	25 deg. C, 65 % RH	Tested By	Tim Chen

Antenna Polarity & Test Distance: Horizontal at 3 m								
Frequency (MHz)	Emission Level (dBuV/m)	Read Level (dBuV)	Factor (dB/m)	Limit (dBuV/m)	Margin (dB)	Antenna Height (cm)	Table Angle (Degree)	Remark
5320	91.22	89.86	1.36			140	85	Average
5320	97.09	95.73	1.36			140	85	Peak
5350	42.04	40.58	1.46	54	-11.96	140	85	Average
5350	55.42	53.96	1.46	74	-18.58	140	85	Peak
10640	46.42	49.31	-2.89	54	-7.58	150	267	Average
10640	55.61	58.5	-2.89	74	-18.39	150	267	Peak
Antenna Polarity & Test Distance: Vertical at 3 m								
Frequency (MHz)	Emission Level (dBuV/m)	Read Level (dBuV)	Factor (dB/m)	Limit (dBuV/m)	Margin (dB)	Antenna Height (cm)	Table Angle (Degree)	Remark
5320	99.44	98.08	1.36			100	73	Average
5320	105.43	104.07	1.36			100	73	Peak
5350	46.71	45.25	1.46	54	-7.29	100	73	Average
5350	59.36	57.9	1.46	74	-14.64	100	73	Peak
10640	46.67	49.56	-2.89	54	-7.33	178	281	Average
10640	56.17	59.06	-2.89	74	-17.83	178	281	Peak

Remarks:

- Emission Level = Read Level + Factor
Margin value = Emission level – Limit value
- 5320 MHz: Fundamental Frequency
- *: Out of Restricted Band
- The emission levels of other frequencies were very low against the limit

EUT Test Condition		Measurement Detail	
Channel	Channel 100	Frequency Range	1 GHz ~ 40 GHz
Input Power	120 Vac, 60 Hz	Detector Function	Peak (PK) Average (AV)
Environmental Conditions	25 deg. C, 65 % RH	Tested By	Tim Chen

Antenna Polarity & Test Distance: Horizontal at 3 m								
Frequency (MHz)	Emission Level (dBuV/m)	Read Level (dBuV)	Factor (dB/m)	Limit (dBuV/m)	Margin (dB)	Antenna Height (cm)	Table Angle (Degree)	Remark
5459.28	41.66	39.79	1.87	54	-12.34	120	168	Average
5459.28	50.63	48.76	1.87	74	-23.37	120	168	Peak
*5470	53.64	51.78	1.86	68.2	-14.56	120	168	Peak
5500	93.41	91.54	1.87			120	168	Average
5500	99.89	98.02	1.87			120	168	Peak
*5725	50.25	48.49	1.76	68.2	-17.95	120	168	Peak
11000	46.65	48.96	-2.31	54	-7.35	171	233	Average
11000	56.58	58.89	-2.31	74	-17.42	171	233	Peak
Antenna Polarity & Test Distance: Vertical at 3 m								
Frequency (MHz)	Emission Level (dBuV/m)	Read Level (dBuV)	Factor (dB/m)	Limit (dBuV/m)	Margin (dB)	Antenna Height (cm)	Table Angle (Degree)	Remark
5459.44	45.26	43.39	1.87	54	-8.74	115	84	Average
5459.44	56.77	54.9	1.87	74	-17.23	115	84	Peak
*5470	59.8	57.94	1.86	68.2	-8.4	115	84	Peak
5500	98.3	96.43	1.87			115	84	Average
5500	104.9	103.03	1.87			115	84	Peak
*5725	49.46	47.7	1.76	68.2	-18.74	115	84	Peak
11000	47.27	49.58	-2.31	54	-6.73	139	105	Average
11000	56.24	58.55	-2.31	74	-17.76	139	105	Peak

Remarks:

- Emission Level = Read Level + Factor
Margin value = Emission level – Limit value
- 5500 MHz: Fundamental Frequency
- *: Out of Restricted Band
- The emission levels of other frequencies were very low against the limit

EUT Test Condition		Measurement Detail	
Channel	Channel 116	Frequency Range	1 GHz ~ 40 GHz
Input Power	120 Vac, 60 Hz	Detector Function	Peak (PK) Average (AV)
Environmental Conditions	25 deg. C, 65 % RH	Tested By	Tim Chen

Antenna Polarity & Test Distance: Horizontal at 3 m								
Frequency (MHz)	Emission Level (dBuV/m)	Read Level (dBuV)	Factor (dB/m)	Limit (dBuV/m)	Margin (dB)	Antenna Height (cm)	Table Angle (Degree)	Remark
5350.48	40.43	38.97	1.46	54	-13.57	116	168	Average
5350.48	50.13	48.67	1.46	74	-23.87	116	168	Peak
*5470	48.63	46.77	1.86	68.2	-19.57	116	168	Peak
5580	92.44	90.62	1.82			116	168	Average
5580	98.23	96.41	1.82			116	168	Peak
*5725	49.42	47.66	1.76	68.2	-18.78	116	168	Peak
11160	44.68	47.23	-2.55	54	-9.32	213	177	Average
11160	55.55	58.1	-2.55	74	-18.45	213	177	Peak
Antenna Polarity & Test Distance: Vertical at 3 m								
Frequency (MHz)	Emission Level (dBuV/m)	Read Level (dBuV)	Factor (dB/m)	Limit (dBuV/m)	Margin (dB)	Antenna Height (cm)	Table Angle (Degree)	Remark
5384.24	40.91	39.31	1.6	54	-13.09	123	82	Average
5384.24	49.5	47.9	1.6	74	-24.5	123	82	Peak
*5470	49.22	47.36	1.86	68.2	-18.98	123	82	Peak
5580	98.71	96.89	1.82			123	82	Average
5580	104.75	102.93	1.82			123	82	Peak
*5725	49.47	47.71	1.76	68.2	-18.73	123	82	Peak
11160	45.66	48.21	-2.55	54	-8.34	134	120	Average
11160	56.49	59.04	-2.55	74	-17.51	134	120	Peak

Remarks:

- Emission Level = Read Level + Factor
Margin value = Emission level – Limit value
- 5580 MHz: Fundamental Frequency
- *: Out of Restricted Band
- The emission levels of other frequencies were very low against the limit

EUT Test Condition		Measurement Detail	
Channel	Channel 140	Frequency Range	1 GHz ~ 40 GHz
Input Power	120 Vac, 60 Hz	Detector Function	Peak (PK) Average (AV)
Environmental Conditions	25 deg. C, 65 % RH	Tested By	Tim Chen

Antenna Polarity & Test Distance: Horizontal at 3 m								
Frequency (MHz)	Emission Level (dBuV/m)	Read Level (dBuV)	Factor (dB/m)	Limit (dBuV/m)	Margin (dB)	Antenna Height (cm)	Table Angle (Degree)	Remark
5350.16	40.57	39.11	1.46	54	-13.43	233	99	Average
5350.16	50.29	48.83	1.46	74	-23.71	233	99	Peak
*5470	48.61	46.75	1.86	68.2	-19.59	233	99	Peak
5700	92.35	90.76	1.59			233	99	Average
5700	98.14	96.55	1.59			233	99	Peak
*5725	60.67	58.91	1.76	68.2	-7.53	233	99	Peak
11400	46.84	49.07	-2.23	54	-7.16	183	246	Average
11400	56.39	58.62	-2.23	74	-17.61	183	246	Peak
Antenna Polarity & Test Distance: Vertical at 3 m								
Frequency (MHz)	Emission Level (dBuV/m)	Read Level (dBuV)	Factor (dB/m)	Limit (dBuV/m)	Margin (dB)	Antenna Height (cm)	Table Angle (Degree)	Remark
5360.88	40.47	38.94	1.53	54	-13.53	113	242	Average
5360.88	49.62	48.09	1.53	74	-24.38	113	242	Peak
*5470	50.47	48.61	1.86	68.2	-17.73	113	242	Peak
5700	97.05	95.46	1.59			113	242	Average
5700	103.19	101.6	1.59			113	242	Peak
*5725	64.13	62.37	1.76	68.2	-4.07	113	242	Peak
11400	47.15	49.38	-2.23	54	-6.85	167	188	Average
11400	57.13	59.36	-2.23	74	-16.87	167	188	Peak

Remarks:

- Emission Level = Read Level + Factor
Margin value = Emission level – Limit value
- 5700 MHz: Fundamental Frequency
- *: Out of Restricted Band
- The emission levels of other frequencies were very low against the limit

EUT Test Condition		Measurement Detail	
Channel	Channel 149	Frequency Range	1 GHz ~ 40 GHz
Input Power	120 Vac, 60 Hz	Detector Function	Peak (PK) Average (AV)
Environmental Conditions	25 deg. C, 65 % RH	Tested By	Tim Chen

<Spurious Emission>

Antenna Polarity & Test Distance: Horizontal at 3 m								
Frequency (MHz)	Emission Level (dBuV/m)	Read Level (dBuV)	Factor (dB/m)	Limit (dBuV/m)	Margin (dB)	Antenna Height (cm)	Table Angle (Degree)	Remark
5745	89.84	88.02	1.82			126	164	Average
5745	96.3	94.48	1.82			126	164	Peak
11490	46.65	48.85	-2.2	54	-7.35	174	113	Average
11490	55.72	57.92	-2.2	74	-18.28	174	113	Peak
Antenna Polarity & Test Distance: Vertical at 3 m								
Frequency (MHz)	Emission Level (dBuV/m)	Read Level (dBuV)	Factor (dB/m)	Limit (dBuV/m)	Margin (dB)	Antenna Height (cm)	Table Angle (Degree)	Remark
5745	97.29	95.47	1.82			134	242	Average
5745	103.36	101.54	1.82			134	242	Peak
11490	47	49.2	-2.2	54	-7	166	281	Average
11490	56.81	59.01	-2.2	74	-17.19	166	281	Peak

<Out of Band Emission (OOBE)>

Antenna Polarity & Test Distance: Horizontal at 3 m								
Frequency (MHz)	Emission Level (dBuV/m)	Read Level (dBuV)	Factor (dB/m)	Limit (dBuV/m)	Margin (dB)	Antenna Height (cm)	Table Angle (Degree)	Remark
5609.85	50.96	49.09	1.87	68.2	-17.24	126	164	Peak
5657.825	50.16	48.31	1.85	74.01	-23.85	126	164	Peak
5920.975	49.18	46.87	2.31	71.17	-21.99	126	164	Peak
6000.3	51.47	49.11	2.36	68.2	-16.73	126	164	Peak
Antenna Polarity & Test Distance: Vertical at 3 m								
Frequency (MHz)	Emission Level (dBuV/m)	Read Level (dBuV)	Factor (dB/m)	Limit (dBuV/m)	Margin (dB)	Antenna Height (cm)	Table Angle (Degree)	Remark
5636.925	50.42	48.54	1.88	68.2	-17.78	134	242	Peak
5653.075	50.09	48.18	1.91	70.49	-20.4	134	242	Peak
5922.875	50.49	48.19	2.3	69.77	-19.28	134	242	Peak
5982.725	51.6	49.27	2.33	68.2	-16.6	134	242	Peak

Remarks:

- Emission Level = Read Level + Factor
Margin value = Emission level – Limit value
- 5745 MHz: Fundamental Frequency
- *: Out of Restricted Band
- The emission levels of other frequencies were very low against the limit

EUT Test Condition		Measurement Detail	
Channel	Channel 157	Frequency Range	1 GHz ~ 40 GHz
Input Power	120 Vac, 60 Hz	Detector Function	Peak (PK) Average (AV)
Environmental Conditions	25 deg. C, 65 % RH	Tested By	Tim Chen

<Spurious Emission>

Antenna Polarity & Test Distance: Horizontal at 3 m								
Frequency (MHz)	Emission Level (dBuV/m)	Read Level (dBuV)	Factor (dB/m)	Limit (dBuV/m)	Margin (dB)	Antenna Height (cm)	Table Angle (Degree)	Remark
5785	91.21	89.29	1.92			233	102	Average
5785	97.66	95.74	1.92			233	102	Peak
11570	41.97	44.17	-2.2	54	-12.03	113	227	Average
11570	52.49	54.69	-2.2	74	-21.51	113	227	Peak
Antenna Polarity & Test Distance: Vertical at 3 m								
Frequency (MHz)	Emission Level (dBuV/m)	Read Level (dBuV)	Factor (dB/m)	Limit (dBuV/m)	Margin (dB)	Antenna Height (cm)	Table Angle (Degree)	Remark
5785	96.86	94.94	1.92			118	242	Average
5785	103	101.08	1.92			118	242	Peak
11570	41.84	44.04	-2.2	54	-12.16	194	207	Average
11570	53.15	55.35	-2.2	74	-20.85	194	207	Peak

<Out of Band Emission (OOBE)>

Antenna Polarity & Test Distance: Horizontal at 3 m								
Frequency (MHz)	Emission Level (dBuV/m)	Read Level (dBuV)	Factor (dB/m)	Limit (dBuV/m)	Margin (dB)	Antenna Height (cm)	Table Angle (Degree)	Remark
5642.15	51.46	49.58	1.88	68.2	-16.74	233	102	Peak
5654.5	49.4	47.55	1.85	71.54	-22.14	233	102	Peak
5920.975	49.51	47.2	2.31	71.17	-21.66	233	102	Peak
6018.35	50.43	48.03	2.4	68.2	-17.77	233	102	Peak
Antenna Polarity & Test Distance: Vertical at 3 m								
Frequency (MHz)	Emission Level (dBuV/m)	Read Level (dBuV)	Factor (dB/m)	Limit (dBuV/m)	Margin (dB)	Antenna Height (cm)	Table Angle (Degree)	Remark
5559.5	50.12	48.32	1.8	68.2	-18.08	118	242	Peak
5654.975	48.9	47.05	1.85	71.9	-23	118	242	Peak
5921.45	49.52	47.21	2.31	70.82	-21.3	118	242	Peak
5996.975	51.42	49.06	2.36	68.2	-16.78	118	242	Peak

Remarks:

- Emission Level = Read Level + Factor
Margin value = Emission level – Limit value
- 5785 MHz: Fundamental Frequency
- *: Out of Restricted Band
- The emission levels of other frequencies were very low against the limit

EUT Test Condition		Measurement Detail	
Channel	Channel 165	Frequency Range	1 GHz ~ 40 GHz
Input Power	120 Vac, 60 Hz	Detector Function	Peak (PK) Average (AV)
Environmental Conditions	25 deg. C, 65 % RH	Tested By	Tim Chen

<Spurious Emission>

Antenna Polarity & Test Distance: Horizontal at 3 m								
Frequency (MHz)	Emission Level (dBuV/m)	Read Level (dBuV)	Factor (dB/m)	Limit (dBuV/m)	Margin (dB)	Antenna Height (cm)	Table Angle (Degree)	Remark
5825	91.61	89.53	2.08			235	99	Average
5825	97.83	95.75	2.08			235	99	Peak
11650	46.5	48.89	-2.39	54	-7.5	129	304	Average
11650	56.09	58.48	-2.39	74	-17.91	129	304	Peak
Antenna Polarity & Test Distance: Vertical at 3 m								
Frequency (MHz)	Emission Level (dBuV/m)	Read Level (dBuV)	Factor (dB/m)	Limit (dBuV/m)	Margin (dB)	Antenna Height (cm)	Table Angle (Degree)	Remark
5825	96.74	94.66	2.08			121	244	Average
5825	103.38	101.3	2.08			121	244	Peak
11650	46.99	49.38	-2.39	54	-7.01	187	100	Average
11650	56.47	58.86	-2.39	74	-17.53	187	100	Peak

<Out of Band Emission (OOBE)>

Antenna Polarity & Test Distance: Horizontal at 3 m								
Frequency (MHz)	Emission Level (dBuV/m)	Read Level (dBuV)	Factor (dB/m)	Limit (dBuV/m)	Margin (dB)	Antenna Height (cm)	Table Angle (Degree)	Remark
5591.8	50.23	48.36	1.87	68.2	-17.97	235	99	Peak
5659.725	49.69	47.84	1.85	75.42	-25.73	235	99	Peak
5917.175	49.73	47.42	2.31	73.97	-24.24	235	99	Peak
5935.225	51.2	48.9	2.3	68.2	-17	235	99	Peak
Antenna Polarity & Test Distance: Vertical at 3 m								
Frequency (MHz)	Emission Level (dBuV/m)	Read Level (dBuV)	Factor (dB/m)	Limit (dBuV/m)	Margin (dB)	Antenna Height (cm)	Table Angle (Degree)	Remark
5644.05	50.19	48.31	1.88	68.2	-18.01	121	244	Peak
5653.075	49.15	47.24	1.91	70.49	-21.34	121	244	Peak
5922.4	50	47.7	2.3	70.12	-20.12	121	244	Peak
5954.7	51.3	49.01	2.29	68.2	-16.9	121	244	Peak

Remarks:

- Emission Level = Read Level + Factor
Margin value = Emission level – Limit value
- 5825 MHz: Fundamental Frequency
- *: Out of Restricted Band
- The emission levels of other frequencies were very low against the limit

802.11n (HT20)

EUT Test Condition		Measurement Detail	
Channel	Channel 36	Frequency Range	1 GHz ~ 40 GHz
Input Power	120 Vac, 60 Hz	Detector Function	Peak (PK) Average (AV)
Environmental Conditions	25 deg. C, 65 % RH	Tested By	Tim Chen

Antenna Polarity & Test Distance: Horizontal at 3 m								
Frequency (MHz)	Emission Level (dBuV/m)	Read Level (dBuV)	Factor (dB/m)	Limit (dBuV/m)	Margin (dB)	Antenna Height (cm)	Table Angle (Degree)	Remark
5150	50.21	48.68	1.53	54	-3.79	122	106	Average
5150	65.49	63.96	1.53	74	-8.51	122	106	Peak
5180	99.61	98.08	1.53			122	106	Average
5180	106.7	105.17	1.53			122	106	Peak
*10360	53.99	56.83	-2.84	68.2	-14.21	170	208	Peak
Antenna Polarity & Test Distance: Vertical at 3 m								
Frequency (MHz)	Emission Level (dBuV/m)	Read Level (dBuV)	Factor (dB/m)	Limit (dBuV/m)	Margin (dB)	Antenna Height (cm)	Table Angle (Degree)	Remark
5150	49.12	47.59	1.53	54	-4.88	108	88	Average
5150	58.79	57.26	1.53	74	-15.21	108	88	Peak
5180	99.16	97.63	1.53			108	88	Average
5180	105.89	104.36	1.53			108	88	Peak
*10360	54.92	57.76	-2.84	68.2	-13.28	148	105	Peak

Remarks:

- Emission Level = Read Level + Factor
Margin value = Emission level – Limit value
- 5180 MHz: Fundamental Frequency
- *: Out of Restricted Band
- The emission levels of other frequencies were very low against the limit

EUT Test Condition		Measurement Detail	
Channel	Channel 40	Frequency Range	1 GHz ~ 40 GHz
Input Power	120 Vac, 60 Hz	Detector Function	Peak (PK) Average (AV)
Environmental Conditions	25 deg. C, 65 % RH	Tested By	Tim Chen

Antenna Polarity & Test Distance: Horizontal at 3 m								
Frequency (MHz)	Emission Level (dBuV/m)	Read Level (dBuV)	Factor (dB/m)	Limit (dBuV/m)	Margin (dB)	Antenna Height (cm)	Table Angle (Degree)	Remark
5149.76	41.8	40.27	1.53	54	-12.2	111	54	Average
5149.76	50.5	48.97	1.53	74	-23.5	111	54	Peak
5200	94.13	92.6	1.53			111	54	Average
5200	100.3	98.77	1.53			111	54	Peak
*10400	54.46	57.35	-2.89	68.2	-13.74	206	57	Peak

Antenna Polarity & Test Distance: Vertical at 3 m								
Frequency (MHz)	Emission Level (dBuV/m)	Read Level (dBuV)	Factor (dB/m)	Limit (dBuV/m)	Margin (dB)	Antenna Height (cm)	Table Angle (Degree)	Remark
5149.22	43.84	42.31	1.53	54	-10.16	100	72	Average
5149.22	55.32	53.79	1.53	74	-18.68	100	72	Peak
5200	99.33	97.8	1.53			100	72	Average
5200	105.05	103.52	1.53			100	72	Peak
*10400	54.6	57.49	-2.89	68.2	-13.6	138	161	Peak

Remarks:

- Emission Level = Read Level + Factor
Margin value = Emission level – Limit value
- 5200 MHz: Fundamental Frequency
- *: Out of Restricted Band
- The emission levels of other frequencies were very low against the limit

EUT Test Condition		Measurement Detail	
Channel	Channel 48	Frequency Range	1 GHz ~ 40 GHz
Input Power	120 Vac, 60 Hz	Detector Function	Peak (PK) Average (AV)
Environmental Conditions	25 deg. C, 65 % RH	Tested By	Tim Chen

Antenna Polarity & Test Distance: Horizontal at 3 m								
Frequency (MHz)	Emission Level (dBuV/m)	Read Level (dBuV)	Factor (dB/m)	Limit (dBuV/m)	Margin (dB)	Antenna Height (cm)	Table Angle (Degree)	Remark
5143.46	40.99	39.44	1.55	54	-13.01	115	203	Average
5143.46	51.43	49.88	1.55	74	-22.57	115	203	Peak
5240	93.21	91.83	1.38			115	203	Average
5240	100.36	98.98	1.38			115	203	Peak
5429.53	40.8	39.02	1.78	54	-13.2	115	203	Average
5429.53	50.81	49.03	1.78	74	-23.19	115	203	Peak
*10480	55.06	57.79	-2.73	68.2	-13.14	138	241	Peak
Antenna Polarity & Test Distance: Vertical at 3 m								
Frequency (MHz)	Emission Level (dBuV/m)	Read Level (dBuV)	Factor (dB/m)	Limit (dBuV/m)	Margin (dB)	Antenna Height (cm)	Table Angle (Degree)	Remark
5136.44	41.3	39.81	1.49	54	-12.7	100	78	Average
5136.44	50.68	49.19	1.49	74	-23.32	100	78	Peak
5240	99.54	98.16	1.38			100	78	Average
5240	105.46	104.08	1.38			100	78	Peak
5427.55	41.74	39.98	1.76	54	-12.26	100	78	Average
5427.55	50.93	49.17	1.76	74	-23.07	100	78	Peak
*10480	55.81	58.54	-2.73	68.2	-12.39	169	255	Peak

Remarks:

- Emission Level = Read Level + Factor
Margin value = Emission level – Limit value
- 5240 MHz: Fundamental Frequency
- *: Out of Restricted Band
- The emission levels of other frequencies were very low against the limit

EUT Test Condition		Measurement Detail	
Channel	Channel 52	Frequency Range	1 GHz ~ 40 GHz
Input Power	120 Vac, 60 Hz	Detector Function	Peak (PK) Average (AV)
Environmental Conditions	25 deg. C, 65 % RH	Tested By	Tim Chen

Antenna Polarity & Test Distance: Horizontal at 3 m								
Frequency (MHz)	Emission Level (dBuV/m)	Read Level (dBuV)	Factor (dB/m)	Limit (dBuV/m)	Margin (dB)	Antenna Height (cm)	Table Angle (Degree)	Remark
5136.62	40.83	39.34	1.49	54	-13.17	132	83	Average
5136.62	51	49.51	1.49	74	-23	132	83	Peak
5260	91.95	90.64	1.31			132	83	Average
5260	97.6	96.29	1.31			132	83	Peak
5422.93	40.92	39.21	1.71	54	-13.08	132	83	Average
5422.93	51.97	50.26	1.71	74	-22.03	132	83	Peak
*10520	55.03	57.75	-2.72	68.2	-13.17	138	223	Peak
Antenna Polarity & Test Distance: Vertical at 3 m								
Frequency (MHz)	Emission Level (dBuV/m)	Read Level (dBuV)	Factor (dB/m)	Limit (dBuV/m)	Margin (dB)	Antenna Height (cm)	Table Angle (Degree)	Remark
5142.38	41.08	39.53	1.55	54	-12.92	100	81	Average
5142.38	50.64	49.09	1.55	74	-23.36	100	81	Peak
5260	99.68	98.37	1.31			100	81	Average
5260	105.7	104.39	1.31			100	81	Peak
5446.91	41.69	39.87	1.82	54	-12.31	100	81	Average
5446.91	50.87	49.05	1.82	74	-23.13	100	81	Peak
*10520	55.47	58.19	-2.72	68.2	-12.73	156	237	Peak

Remarks:

- Emission Level = Read Level + Factor
Margin value = Emission level – Limit value
- 5260 MHz: Fundamental Frequency
- *: Out of Restricted Band
- The emission levels of other frequencies were very low against the limit

EUT Test Condition		Measurement Detail	
Channel	Channel 60	Frequency Range	1 GHz ~ 40 GHz
Input Power	120 Vac, 60 Hz	Detector Function	Peak (PK) Average (AV)
Environmental Conditions	25 deg. C, 65 % RH	Tested By	Tim Chen

Antenna Polarity & Test Distance: Horizontal at 3 m								
Frequency (MHz)	Emission Level (dBuV/m)	Read Level (dBuV)	Factor (dB/m)	Limit (dBuV/m)	Margin (dB)	Antenna Height (cm)	Table Angle (Degree)	Remark
5300	90.4	89.09	1.31			100	117	Average
5300	96.07	94.76	1.31			100	117	Peak
5444.6	40.99	39.21	1.78	54	-13.01	100	117	Average
5444.6	51.66	49.88	1.78	74	-22.34	100	117	Peak
10600	46.36	49.27	-2.91	54	-7.64	142	155	Average
10600	55.41	58.32	-2.91	74	-18.59	142	155	Peak
Antenna Polarity & Test Distance: Vertical at 3 m								
Frequency (MHz)	Emission Level (dBuV/m)	Read Level (dBuV)	Factor (dB/m)	Limit (dBuV/m)	Margin (dB)	Antenna Height (cm)	Table Angle (Degree)	Remark
5300	98.58	97.27	1.31			126	68	Average
5300	104.77	103.46	1.31			126	68	Peak
5350.44	42.58	41.12	1.46	54	-11.42	126	68	Average
5350.44	51.08	49.62	1.46	74	-22.92	126	68	Peak
10600	46.64	49.55	-2.91	54	-7.36	172	219	Average
10600	56.11	59.02	-2.91	74	-17.89	172	219	Peak

Remarks:

- Emission Level = Read Level + Factor
Margin value = Emission level – Limit value
- 5300 MHz: Fundamental Frequency
- *: Out of Restricted Band
- The emission levels of other frequencies were very low against the limit

EUT Test Condition		Measurement Detail	
Channel	Channel 64	Frequency Range	1 GHz ~ 40 GHz
Input Power	120 Vac, 60 Hz	Detector Function	Peak (PK) Average (AV)
Environmental Conditions	25 deg. C, 65 % RH	Tested By	Tim Chen

Antenna Polarity & Test Distance: Horizontal at 3 m								
Frequency (MHz)	Emission Level (dBuV/m)	Read Level (dBuV)	Factor (dB/m)	Limit (dBuV/m)	Margin (dB)	Antenna Height (cm)	Table Angle (Degree)	Remark
5320	98.66	97.3	1.36			131	107	Average
5320	105.19	103.83	1.36			131	107	Peak
5350	47.54	46.08	1.46	54	-6.46	131	107	Average
5350	59.73	58.27	1.46	74	-14.27	131	107	Peak
10640	46	48.89	-2.89	54	-8	171	125	Average
10640	56.19	59.08	-2.89	74	-17.81	171	125	Peak
Antenna Polarity & Test Distance: Vertical at 3 m								
Frequency (MHz)	Emission Level (dBuV/m)	Read Level (dBuV)	Factor (dB/m)	Limit (dBuV/m)	Margin (dB)	Antenna Height (cm)	Table Angle (Degree)	Remark
5320	99.58	98.22	1.36			119	83	Average
5320	106.41	105.05	1.36			119	83	Peak
5350	48.16	46.7	1.46	54	-5.84	119	83	Average
5350	60.33	58.87	1.46	74	-13.67	119	83	Peak
10640	46.5	49.39	-2.89	54	-7.5	146	255	Average
10640	55.97	58.86	-2.89	74	-18.03	146	255	Peak

Remarks:

- Emission Level = Read Level + Factor
Margin value = Emission level – Limit value
- 5320 MHz: Fundamental Frequency
- *: Out of Restricted Band
- The emission levels of other frequencies were very low against the limit

EUT Test Condition		Measurement Detail	
Channel	Channel 100	Frequency Range	1 GHz ~ 40 GHz
Input Power	120 Vac, 60 Hz	Detector Function	Peak (PK) Average (AV)
Environmental Conditions	25 deg. C, 65 % RH	Tested By	Tim Chen

Antenna Polarity & Test Distance: Horizontal at 3 m								
Frequency (MHz)	Emission Level (dBuV/m)	Read Level (dBuV)	Factor (dB/m)	Limit (dBuV/m)	Margin (dB)	Antenna Height (cm)	Table Angle (Degree)	Remark
5460	44.18	42.31	1.87	54	-9.82	125	109	Average
5460	53.04	51.17	1.87	74	-20.96	125	109	Peak
*5470	58.13	56.27	1.86	68.2	-10.07	125	109	Peak
5500	96.53	94.66	1.87			125	109	Average
5500	103.53	101.66	1.87			125	109	Peak
*5725	50.73	48.97	1.76	68.2	-17.47	125	109	Peak
11000	46.77	49.08	-2.31	54	-7.23	159	100	Average
11000	56.3	58.61	-2.31	74	-17.7	159	100	Peak
Antenna Polarity & Test Distance: Vertical at 3 m								
Frequency (MHz)	Emission Level (dBuV/m)	Read Level (dBuV)	Factor (dB/m)	Limit (dBuV/m)	Margin (dB)	Antenna Height (cm)	Table Angle (Degree)	Remark
5460	45.7	43.83	1.87	54	-8.3	123	85	Average
5460	57.14	55.27	1.87	74	-16.86	123	85	Peak
*5470	60.77	58.91	1.86	68.2	-7.43	123	85	Peak
5500	98.72	96.85	1.87			123	85	Average
5500	106.34	104.47	1.87			123	85	Peak
*5725	50.43	48.67	1.76	68.2	-17.77	123	85	Peak
11000	47.16	49.47	-2.31	54	-6.84	162	267	Average
11000	57.03	59.34	-2.31	74	-16.97	162	267	Peak

Remarks:

- Emission Level = Read Level + Factor
Margin value = Emission level – Limit value
- 5500 MHz: Fundamental Frequency
- *: Out of Restricted Band
- The emission levels of other frequencies were very low against the limit

EUT Test Condition		Measurement Detail	
Channel	Channel 116	Frequency Range	1 GHz ~ 40 GHz
Input Power	120 Vac, 60 Hz	Detector Function	Peak (PK) Average (AV)
Environmental Conditions	25 deg. C, 65 % RH	Tested By	Tim Chen

Antenna Polarity & Test Distance: Horizontal at 3 m								
Frequency (MHz)	Emission Level (dBuV/m)	Read Level (dBuV)	Factor (dB/m)	Limit (dBuV/m)	Margin (dB)	Antenna Height (cm)	Table Angle (Degree)	Remark
5362.96	40.44	38.91	1.53	54	-13.56	119	168	Average
5362.96	50.1	48.57	1.53	74	-23.9	119	168	Peak
*5470	48.78	46.92	1.86	68.2	-19.42	119	168	Peak
5580	92.32	90.5	1.82			119	168	Average
5580	98.34	96.52	1.82			119	168	Peak
*5725	50.39	48.63	1.76	68.2	-17.81	119	168	Peak
11160	46.32	48.87	-2.55	54	-7.68	176	67	Average
11160	56.42	58.97	-2.55	74	-17.58	176	67	Peak
Antenna Polarity & Test Distance: Vertical at 3 m								
Frequency (MHz)	Emission Level (dBuV/m)	Read Level (dBuV)	Factor (dB/m)	Limit (dBuV/m)	Margin (dB)	Antenna Height (cm)	Table Angle (Degree)	Remark
5382.16	40.66	39.06	1.6	54	-13.34	123	81	Average
5382.16	50.1	48.5	1.6	74	-23.9	123	81	Peak
*5470	48.77	46.91	1.86	68.2	-19.43	123	81	Peak
5580	97.88	96.06	1.82			123	81	Average
5580	104.47	102.65	1.82			123	81	Peak
*5725	49.82	48.06	1.76	68.2	-18.38	123	81	Peak
11160	46.74	49.29	-2.55	54	-7.26	152	233	Average
11160	56.47	59.02	-2.55	74	-17.53	152	233	Peak

Remarks:

- Emission Level = Read Level + Factor
Margin value = Emission level – Limit value
- 5580 MHz: Fundamental Frequency
- *: Out of Restricted Band
- The emission levels of other frequencies were very low against the limit

EUT Test Condition		Measurement Detail	
Channel	Channel 140	Frequency Range	1 GHz ~ 40 GHz
Input Power	120 Vac, 60 Hz	Detector Function	Peak (PK) Average (AV)
Environmental Conditions	25 deg. C, 65 % RH	Tested By	Tim Chen

Antenna Polarity & Test Distance: Horizontal at 3 m								
Frequency (MHz)	Emission Level (dBuV/m)	Read Level (dBuV)	Factor (dB/m)	Limit (dBuV/m)	Margin (dB)	Antenna Height (cm)	Table Angle (Degree)	Remark
5460	41.09	39.22	1.87	54	-12.91	116	105	Average
5460	51.17	49.3	1.87	74	-22.83	116	105	Peak
*5470	50.11	48.25	1.86	68.2	-18.09	116	105	Peak
5700	95.21	93.62	1.59			116	105	Average
5700	102.3	100.71	1.59			116	105	Peak
*5725	61.16	59.4	1.76	68.2	-7.04	116	105	Peak
11400	46.77	49	-2.23	54	-7.23	139	146	Average
11400	56.35	58.58	-2.23	74	-17.65	139	146	Peak

Antenna Polarity & Test Distance: Vertical at 3 m								
Frequency (MHz)	Emission Level (dBuV/m)	Read Level (dBuV)	Factor (dB/m)	Limit (dBuV/m)	Margin (dB)	Antenna Height (cm)	Table Angle (Degree)	Remark
5460	41.12	39.25	1.87	54	-12.88	116	93	Average
5460	50.78	48.91	1.87	74	-23.22	116	93	Peak
*5470	50.33	48.47	1.86	68.2	-17.87	116	93	Peak
5700	96.64	95.05	1.59			116	93	Average
5700	103.48	101.89	1.59			116	93	Peak
*5725	59.89	58.13	1.76	68.2	-8.31	116	93	Peak
11400	47.28	49.51	-2.23	54	-6.72	184	225	Average
11400	57.48	59.71	-2.23	74	-16.52	184	225	Peak

Remarks:

- Emission Level = Read Level + Factor
Margin value = Emission level – Limit value
- 5700 MHz: Fundamental Frequency
- *: Out of Restricted Band
- The emission levels of other frequencies were very low against the limit

EUT Test Condition		Measurement Detail	
Channel	Channel 149	Frequency Range	1 GHz ~ 40 GHz
Input Power	120 Vac, 60 Hz	Detector Function	Peak (PK) Average (AV)
Environmental Conditions	25 deg. C, 65 % RH	Tested By	Tim Chen

<Spurious Emission>

Antenna Polarity & Test Distance: Horizontal at 3 m								
Frequency (MHz)	Emission Level (dBuV/m)	Read Level (dBuV)	Factor (dB/m)	Limit (dBuV/m)	Margin (dB)	Antenna Height (cm)	Table Angle (Degree)	Remark
5745	95.05	93.23	1.82			116	100	Average
5745	101.92	100.1	1.82			116	100	Peak
11490	46.99	49.19	-2.2	54	-7.01	155	46	Average
11490	55.6	57.8	-2.2	74	-18.4	155	46	Peak
Antenna Polarity & Test Distance: Vertical at 3 m								
Frequency (MHz)	Emission Level (dBuV/m)	Read Level (dBuV)	Factor (dB/m)	Limit (dBuV/m)	Margin (dB)	Antenna Height (cm)	Table Angle (Degree)	Remark
5745	94.88	93.06	1.82			105	90	Average
5745	104.16	102.34	1.82			105	90	Peak
11490	47.05	49.25	-2.2	54	-6.95	170	133	Average
11490	56.84	59.04	-2.2	74	-17.16	170	133	Peak

<Out of Band Emission (OOBE)>

Antenna Polarity & Test Distance: Horizontal at 3 m								
Frequency (MHz)	Emission Level (dBuV/m)	Read Level (dBuV)	Factor (dB/m)	Limit (dBuV/m)	Margin (dB)	Antenna Height (cm)	Table Angle (Degree)	Remark
5635.975	51.08	49.2	1.88	68.2	-17.12	116	100	Peak
5651.175	51.02	49.11	1.91	69.07	-18.05	116	100	Peak
5915.75	51.36	49.05	2.31	75.02	-23.66	116	100	Peak
5930.95	51.13	48.83	2.3	68.2	-17.07	116	100	Peak
Antenna Polarity & Test Distance: Vertical at 3 m								
Frequency (MHz)	Emission Level (dBuV/m)	Read Level (dBuV)	Factor (dB/m)	Limit (dBuV/m)	Margin (dB)	Antenna Height (cm)	Table Angle (Degree)	Remark
5597.975	51.12	49.25	1.87	68.2	-17.08	105	90	Peak
5654.025	50.76	48.91	1.85	71.19	-20.43	105	90	Peak
5923.825	49.51	47.21	2.3	69.07	-19.56	105	90	Peak
5976.075	51.11	48.78	2.33	68.2	-17.09	105	90	Peak

Remarks:

- Emission Level = Read Level + Factor
Margin value = Emission level – Limit value
- 5745 MHz: Fundamental Frequency
- *: Out of Restricted Band
- The emission levels of other frequencies were very low against the limit

EUT Test Condition		Measurement Detail	
Channel	Channel 157	Frequency Range	1 GHz ~ 40 GHz
Input Power	120 Vac, 60 Hz	Detector Function	Peak (PK) Average (AV)
Environmental Conditions	25 deg. C, 65 % RH	Tested By	Tim Chen

<Spurious Emission>

Antenna Polarity & Test Distance: Horizontal at 3 m								
Frequency (MHz)	Emission Level (dBuV/m)	Read Level (dBuV)	Factor (dB/m)	Limit (dBuV/m)	Margin (dB)	Antenna Height (cm)	Table Angle (Degree)	Remark
5785	91.38	89.46	1.92			220	101	Average
5785	97.59	95.67	1.92			220	101	Peak
11570	46.62	48.82	-2.2	54	-7.38	144	69	Average
11570	55.76	57.96	-2.2	74	-18.24	144	69	Peak
Antenna Polarity & Test Distance: Vertical at 3 m								
Frequency (MHz)	Emission Level (dBuV/m)	Read Level (dBuV)	Factor (dB/m)	Limit (dBuV/m)	Margin (dB)	Antenna Height (cm)	Table Angle (Degree)	Remark
5785	96.52	94.6	1.92			122	242	Average
5785	102.91	100.99	1.92			122	242	Peak
11570	47.09	49.29	-2.2	54	-6.91	185	261	Average
11570	56.66	58.86	-2.2	74	-17.34	185	261	Peak

<Out of Band Emission (OOBE)>

Antenna Polarity & Test Distance: Horizontal at 3 m								
Frequency (MHz)	Emission Level (dBuV/m)	Read Level (dBuV)	Factor (dB/m)	Limit (dBuV/m)	Margin (dB)	Antenna Height (cm)	Table Angle (Degree)	Remark
5557.125	49.61	47.81	1.8	68.2	-18.59	220	101	Peak
5659.725	49.62	47.77	1.85	75.42	-25.8	220	101	Peak
5919.075	49.9	47.59	2.31	72.57	-22.67	220	101	Peak
5940.925	50.21	47.92	2.29	68.2	-17.99	220	101	Peak
Antenna Polarity & Test Distance: Vertical at 3 m								
Frequency (MHz)	Emission Level (dBuV/m)	Read Level (dBuV)	Factor (dB/m)	Limit (dBuV/m)	Margin (dB)	Antenna Height (cm)	Table Angle (Degree)	Remark
5598.925	50.46	48.53	1.93	68.2	-17.74	122	242	Peak
5653.55	49.49	47.58	1.91	70.84	-21.35	122	242	Peak
5918.6	49.92	47.61	2.31	72.92	-23	122	242	Peak
5979.4	51.55	49.22	2.33	68.2	-16.65	122	242	Peak

Remarks:

- Emission Level = Read Level + Factor
Margin value = Emission level – Limit value
- 5785 MHz: Fundamental Frequency
- *: Out of Restricted Band
- The emission levels of other frequencies were very low against the limit

EUT Test Condition		Measurement Detail	
Channel	Channel 165	Frequency Range	1 GHz ~ 40 GHz
Input Power	120 Vac, 60 Hz	Detector Function	Peak (PK) Average (AV)
Environmental Conditions	25 deg. C, 65 % RH	Tested By	Tim Chen

<Spurious Emission>

Antenna Polarity & Test Distance: Horizontal at 3 m								
Frequency (MHz)	Emission Level (dBuV/m)	Read Level (dBuV)	Factor (dB/m)	Limit (dBuV/m)	Margin (dB)	Antenna Height (cm)	Table Angle (Degree)	Remark
5825	93.94	91.86	2.08			119	100	Average
5825	100.32	98.24	2.08			119	100	Peak
11650	46.42	48.81	-2.39	54	-7.58	126	213	Average
11650	56.07	58.46	-2.39	74	-17.93	126	213	Peak
Antenna Polarity & Test Distance: Vertical at 3 m								
Frequency (MHz)	Emission Level (dBuV/m)	Read Level (dBuV)	Factor (dB/m)	Limit (dBuV/m)	Margin (dB)	Antenna Height (cm)	Table Angle (Degree)	Remark
5825	94.59	92.51	2.08			129	84	Average
5825	101.2	99.12	2.08			129	84	Peak
11650	46.89	49.28	-2.39	54	-7.11	175	136	Average
11650	56.11	58.5	-2.39	74	-17.89	175	136	Peak

<Out of Band Emission (OOBE)>

Antenna Polarity & Test Distance: Horizontal at 3 m								
Frequency (MHz)	Emission Level (dBuV/m)	Read Level (dBuV)	Factor (dB/m)	Limit (dBuV/m)	Margin (dB)	Antenna Height (cm)	Table Angle (Degree)	Remark
5595.6	51.24	49.37	1.87	68.2	-16.96	119	100	Peak
5651.65	49.64	47.73	1.91	69.43	-19.79	119	100	Peak
5922.4	51.32	49.02	2.3	70.12	-18.8	119	100	Peak
5964.675	51.62	49.32	2.3	68.2	-16.58	119	100	Peak
Antenna Polarity & Test Distance: Vertical at 3 m								
Frequency (MHz)	Emission Level (dBuV/m)	Read Level (dBuV)	Factor (dB/m)	Limit (dBuV/m)	Margin (dB)	Antenna Height (cm)	Table Angle (Degree)	Remark
5643.575	51.14	49.26	1.88	68.2	-17.06	129	84	Peak
5655.45	50.72	48.87	1.85	72.25	-21.53	129	84	Peak
5919.075	50.7	48.39	2.31	72.57	-21.87	129	84	Peak
5945.675	51.17	48.88	2.29	68.2	-17.03	129	84	Peak

Remarks:

- Emission Level = Read Level + Factor
Margin value = Emission level – Limit value
- 5825 MHz: Fundamental Frequency
- *: Out of Restricted Band
- The emission levels of other frequencies were very low against the limit

802.11n (HT40)

EUT Test Condition		Measurement Detail	
Channel	Channel 38	Frequency Range	1 GHz ~ 40 GHz
Input Power	120 Vac, 60 Hz	Detector Function	Peak (PK) Average (AV)
Environmental Conditions	25 deg. C, 65 % RH	Tested By	Tim Chen

Antenna Polarity & Test Distance: Horizontal at 3 m								
Frequency (MHz)	Emission Level (dBuV/m)	Read Level (dBuV)	Factor (dB/m)	Limit (dBuV/m)	Margin (dB)	Antenna Height (cm)	Table Angle (Degree)	Remark
5149.58	49.18	47.65	1.53	54	-4.82	131	202	Average
5149.58	57.72	56.19	1.53	74	-16.28	131	202	Peak
5190	90.24	88.71	1.53			131	202	Average
5190	97.11	95.58	1.53			131	202	Peak
5430.96	41.1	39.32	1.78	54	-12.9	131	202	Average
5430.96	50.41	48.63	1.78	74	-23.59	131	202	Peak
*10380	53.99	56.86	-2.87	68.2	-14.21	146	197	Peak

Antenna Polarity & Test Distance: Vertical at 3 m								
Frequency (MHz)	Emission Level (dBuV/m)	Read Level (dBuV)	Factor (dB/m)	Limit (dBuV/m)	Margin (dB)	Antenna Height (cm)	Table Angle (Degree)	Remark
5149.94	51.93	50.4	1.53	54	-2.07	105	81	Average
5149.94	61.61	60.08	1.53	74	-12.39	105	81	Peak
5190	93.82	92.29	1.53			105	81	Average
5190	99.82	98.29	1.53			105	81	Peak
5430.85	41.3	39.52	1.78	54	-12.7	105	81	Average
5430.85	51.02	49.24	1.78	74	-22.98	105	81	Peak
*10380	54.64	57.51	-2.87	68.2	-13.56	176	154	Peak

Remarks:

- Emission Level = Read Level + Factor
Margin value = Emission level – Limit value
- 5190 MHz: Fundamental Frequency
- *: Out of Restricted Band
- The emission levels of other frequencies were very low against the limit

EUT Test Condition		Measurement Detail	
Channel	Channel 46	Frequency Range	1 GHz ~ 40 GHz
Input Power	120 Vac, 60 Hz	Detector Function	Peak (PK) Average (AV)
Environmental Conditions	25 deg. C, 65 % RH	Tested By	Tim Chen

Antenna Polarity & Test Distance: Horizontal at 3 m								
Frequency (MHz)	Emission Level (dBuV/m)	Read Level (dBuV)	Factor (dB/m)	Limit (dBuV/m)	Margin (dB)	Antenna Height (cm)	Table Angle (Degree)	Remark
5147.96	42.72	41.19	1.53	54	-11.28	130	203	Average
5147.96	52.3	50.77	1.53	74	-21.7	130	203	Peak
5230	91.51	90.13	1.38			130	203	Average
5230	97.54	96.16	1.38			130	203	Peak
5429.42	41.49	39.71	1.78	54	-12.51	130	203	Average
5429.42	50.92	49.14	1.78	74	-23.08	130	203	Peak
*10460	54.25	57.04	-2.79	68.2	-13.95	164	278	Peak
Antenna Polarity & Test Distance: Vertical at 3 m								
Frequency (MHz)	Emission Level (dBuV/m)	Read Level (dBuV)	Factor (dB/m)	Limit (dBuV/m)	Margin (dB)	Antenna Height (cm)	Table Angle (Degree)	Remark
5148.68	44.2	42.67	1.53	54	-9.8	100	96	Average
5148.68	56.05	54.52	1.53	74	-17.95	100	96	Peak
5230	95.99	94.61	1.38			100	96	Average
5230	102.14	100.76	1.38			100	96	Peak
5358.91	42.36	40.9	1.46	54	-11.64	100	96	Average
5358.91	51.45	49.99	1.46	74	-22.55	100	96	Peak
*10460	54.8	57.59	-2.79	68.2	-13.4	155	132	Peak

Remarks:

- Emission Level = Read Level + Factor
Margin value = Emission level – Limit value
- 5230 MHz: Fundamental Frequency
- *: Out of Restricted Band
- The emission levels of other frequencies were very low against the limit

EUT Test Condition		Measurement Detail	
Channel	Channel 54	Frequency Range	1 GHz ~ 40 GHz
Input Power	120 Vac, 60 Hz	Detector Function	Peak (PK) Average (AV)
Environmental Conditions	25 deg. C, 65 % RH	Tested By	Tim Chen

Antenna Polarity & Test Distance: Horizontal at 3 m								
Frequency (MHz)	Emission Level (dBuV/m)	Read Level (dBuV)	Factor (dB/m)	Limit (dBuV/m)	Margin (dB)	Antenna Height (cm)	Table Angle (Degree)	Remark
5099.72	41.5	40.09	1.41	54	-12.5	136	34	Average
5099.72	51.64	50.23	1.41	74	-22.36	136	34	Peak
5270	93.83	92.52	1.31			136	34	Average
5270	100.08	98.77	1.31			136	34	Peak
5350.11	49.75	48.29	1.46	54	-4.25	136	34	Average
5350.11	62.8	61.34	1.46	74	-11.2	136	34	Peak
*10540	54.15	56.92	-2.77	68.2	-14.05	154	103	Peak
Antenna Polarity & Test Distance: Vertical at 3 m								
Frequency (MHz)	Emission Level (dBuV/m)	Read Level (dBuV)	Factor (dB/m)	Limit (dBuV/m)	Margin (dB)	Antenna Height (cm)	Table Angle (Degree)	Remark
5102.06	42.61	41.2	1.41	54	-11.39	159	356	Average
5102.06	52.75	51.34	1.41	74	-21.25	159	356	Peak
5270	96.14	94.83	1.31			159	356	Average
5270	102.88	101.57	1.31			159	356	Peak
5350.11	51.05	49.59	1.46	54	-2.95	159	356	Average
5350.11	63.72	62.26	1.46	74	-10.28	159	356	Peak
*10540	54.84	57.61	-2.77	68.2	-13.36	149	237	Peak

Remarks:

- Emission Level = Read Level + Factor
Margin value = Emission level – Limit value
- 5270 MHz: Fundamental Frequency
- *: Out of Restricted Band
- The emission levels of other frequencies were very low against the limit

EUT Test Condition		Measurement Detail	
Channel	Channel 62	Frequency Range	1 GHz ~ 40 GHz
Input Power	120 Vac, 60 Hz	Detector Function	Peak (PK) Average (AV)
Environmental Conditions	25 deg. C, 65 % RH	Tested By	Tim Chen

Antenna Polarity & Test Distance: Horizontal at 3 m								
Frequency (MHz)	Emission Level (dBuV/m)	Read Level (dBuV)	Factor (dB/m)	Limit (dBuV/m)	Margin (dB)	Antenna Height (cm)	Table Angle (Degree)	Remark
5051.66	41.28	39.74	1.54	54	-12.72	126	201	Average
5051.66	49.95	48.41	1.54	74	-24.05	126	201	Peak
5310	89.55	88.19	1.36			126	201	Average
5310	95.41	94.05	1.36			126	201	Peak
5351.32	46.89	45.43	1.46	54	-7.11	126	201	Average
5351.32	58.99	57.53	1.46	74	-15.01	126	201	Peak
10620	44.1	46.99	-2.89	54	-9.9	136	241	Average
10620	54.16	57.05	-2.89	74	-19.84	136	241	Peak

Antenna Polarity & Test Distance: Vertical at 3 m								
Frequency (MHz)	Emission Level (dBuV/m)	Read Level (dBuV)	Factor (dB/m)	Limit (dBuV/m)	Margin (dB)	Antenna Height (cm)	Table Angle (Degree)	Remark
5134.28	41.37	39.88	1.49	54	-12.63	108	77	Average
5134.28	50.74	49.25	1.49	74	-23.26	108	77	Peak
5310	95.05	93.69	1.36			108	77	Average
5310	101.18	99.82	1.36			108	77	Peak
5350	51.88	50.42	1.46	54	-2.12	108	77	Average
5350	64.85	63.39	1.46	74	-9.15	108	77	Peak
10620	44.37	47.26	-2.89	54	-9.63	113	254	Average
10620	56	58.89	-2.89	74	-18	113	254	Peak

Remarks:

- Emission Level = Read Level + Factor
Margin value = Emission level – Limit value
- 5310 MHz: Fundamental Frequency
- *: Out of Restricted Band
- The emission levels of other frequencies were very low against the limit

EUT Test Condition		Measurement Detail	
Channel	Channel 102	Frequency Range	1 GHz ~ 40 GHz
Input Power	120 Vac, 60 Hz	Detector Function	Peak (PK) Average (AV)
Environmental Conditions	25 deg. C, 65 % RH	Tested By	Tim Chen

Antenna Polarity & Test Distance: Horizontal at 3 m								
Frequency (MHz)	Emission Level (dBuV/m)	Read Level (dBuV)	Factor (dB/m)	Limit (dBuV/m)	Margin (dB)	Antenna Height (cm)	Table Angle (Degree)	Remark
5460	48.59	46.72	1.87	54	-5.41	100	103	Average
5460	56.9	55.03	1.87	74	-17.1	100	103	Peak
*5470	61.97	60.11	1.86	68.2	-6.23	100	103	Peak
5510	95.04	93.2	1.84			100	103	Average
5510	100.9	99.06	1.84			100	103	Peak
*5725	49.4	47.64	1.76	68.2	-18.8	100	103	Peak
11020	46.85	49.19	-2.34	54	-7.15	189	201	Average
11020	56.37	58.71	-2.34	74	-17.63	189	201	Peak
Antenna Polarity & Test Distance: Vertical at 3 m								
Frequency (MHz)	Emission Level (dBuV/m)	Read Level (dBuV)	Factor (dB/m)	Limit (dBuV/m)	Margin (dB)	Antenna Height (cm)	Table Angle (Degree)	Remark
5460	50.38	48.51	1.87	54	-3.62	105	85	Average
5460	60.12	58.25	1.87	74	-13.88	105	85	Peak
*5470	64.86	63	1.86	68.2	-3.34	105	85	Peak
5510	95.65	93.81	1.84			105	85	Average
5510	102.93	101.09	1.84			105	85	Peak
*5725	49.88	48.12	1.76	68.2	-18.32	105	85	Peak
11020	47.07	49.41	-2.34	54	-6.93	150	226	Average
11020	56.79	59.13	-2.34	74	-17.21	150	226	Peak

Remarks:

- Emission Level = Read Level + Factor
Margin value = Emission level – Limit value
- 5510 MHz: Fundamental Frequency
- *: Out of Restricted Band
- The emission levels of other frequencies were very low against the limit

EUT Test Condition		Measurement Detail	
Channel	Channel 110	Frequency Range	1 GHz ~ 40 GHz
Input Power	120 Vac, 60 Hz	Detector Function	Peak (PK) Average (AV)
Environmental Conditions	25 deg. C, 65 % RH	Tested By	Tim Chen

Antenna Polarity & Test Distance: Horizontal at 3 m								
Frequency (MHz)	Emission Level (dBuV/m)	Read Level (dBuV)	Factor (dB/m)	Limit (dBuV/m)	Margin (dB)	Antenna Height (cm)	Table Angle (Degree)	Remark
5411.92	41.31	39.6	1.71	54	-12.69	121	169	Average
5411.92	50.26	48.55	1.71	74	-23.74	121	169	Peak
*5470	50.12	48.26	1.86	68.2	-18.08	121	169	Peak
5550	89.75	87.92	1.83			121	169	Average
5550	95.97	94.14	1.83			121	169	Peak
*5725	50.11	48.35	1.76	68.2	-18.09	121	169	Peak
11100	46.73	49.19	-2.46	54	-7.27	129	166	Average
11100	56.26	58.72	-2.46	74	-17.74	129	166	Peak
Antenna Polarity & Test Distance: Vertical at 3 m								
Frequency (MHz)	Emission Level (dBuV/m)	Read Level (dBuV)	Factor (dB/m)	Limit (dBuV/m)	Margin (dB)	Antenna Height (cm)	Table Angle (Degree)	Remark
5460	43.41	41.54	1.87	54	-10.59	115	82	Average
5460	52.68	50.81	1.87	74	-21.32	115	82	Peak
*5470	57.74	55.88	1.86	68.2	-10.46	115	82	Peak
5550	95.54	93.71	1.83			115	82	Average
5550	101.61	99.78	1.83			115	82	Peak
*5725	50.08	48.32	1.76	68.2	-18.12	115	82	Peak
11100	47.09	49.55	-2.46	54	-6.91	166	257	Average
11100	57.01	59.47	-2.46	74	-16.99	166	257	Peak

Remarks:

- Emission Level = Read Level + Factor
Margin value = Emission level – Limit value
- 5550 MHz: Fundamental Frequency
- *: Out of Restricted Band
- The emission levels of other frequencies were very low against the limit

EUT Test Condition		Measurement Detail	
Channel	Channel 134	Frequency Range	1 GHz ~ 40 GHz
Input Power	120 Vac, 60 Hz	Detector Function	Peak (PK) Average (AV)
Environmental Conditions	25 deg. C, 65 % RH	Tested By	Tim Chen

Antenna Polarity & Test Distance: Horizontal at 3 m								
Frequency (MHz)	Emission Level (dBuV/m)	Read Level (dBuV)	Factor (dB/m)	Limit (dBuV/m)	Margin (dB)	Antenna Height (cm)	Table Angle (Degree)	Remark
5445.2	41.29	39.51	1.78	54	-12.71	129	245	Average
5445.2	50.34	48.56	1.78	74	-23.66	129	245	Peak
*5470	50.44	48.58	1.86	68.2	-17.76	129	245	Peak
5670	87.09	85.33	1.76			129	245	Average
5670	93.36	91.6	1.76			129	245	Peak
*5725	51.39	49.63	1.76	68.2	-16.81	129	245	Peak
11340	46.56	48.92	-2.36	54	-7.44	173	84	Average
11340	56.03	58.39	-2.36	74	-17.97	173	84	Peak
Antenna Polarity & Test Distance: Vertical at 3 m								
Frequency (MHz)	Emission Level (dBuV/m)	Read Level (dBuV)	Factor (dB/m)	Limit (dBuV/m)	Margin (dB)	Antenna Height (cm)	Table Angle (Degree)	Remark
5457.68	41.43	39.56	1.87	54	-12.57	117	202	Average
5457.68	50.52	48.65	1.87	74	-23.48	117	202	Peak
*5470	48.59	46.73	1.86	68.2	-19.61	117	202	Peak
5670	92.31	90.55	1.76			117	202	Average
5670	98.69	96.93	1.76			117	202	Peak
*5725	55.53	53.77	1.76	68.2	-12.67	117	202	Peak
11340	47.2	49.56	-2.36	54	-6.8	153	220	Average
11340	56.57	58.93	-2.36	74	-17.43	153	220	Peak

Remarks:

- Emission Level = Read Level + Factor
Margin value = Emission level – Limit value
- 5670 MHz: Fundamental Frequency
- *: Out of Restricted Band
- The emission levels of other frequencies were very low against the limit

EUT Test Condition		Measurement Detail	
Channel	Channel 151	Frequency Range	1 GHz ~ 40 GHz
Input Power	120 Vac, 60 Hz	Detector Function	Peak (PK) Average (AV)
Environmental Conditions	25 deg. C, 65 % RH	Tested By	Tim Chen

<Spurious Emission>

Antenna Polarity & Test Distance: Horizontal at 3 m								
Frequency (MHz)	Emission Level (dBuV/m)	Read Level (dBuV)	Factor (dB/m)	Limit (dBuV/m)	Margin (dB)	Antenna Height (cm)	Table Angle (Degree)	Remark
5755	87.12	85.22	1.9			125	244	Average
5755	93.04	91.14	1.9			125	244	Peak
11510	47.2	49.41	-2.21	54	-6.8	187	113	Average
11510	56.42	58.63	-2.21	74	-17.58	187	113	Peak
Antenna Polarity & Test Distance: Vertical at 3 m								
Frequency (MHz)	Emission Level (dBuV/m)	Read Level (dBuV)	Factor (dB/m)	Limit (dBuV/m)	Margin (dB)	Antenna Height (cm)	Table Angle (Degree)	Remark
5755	93.43	91.53	1.9			126	246	Average
5755	99.58	97.68	1.9			126	246	Peak
11510	47.2	49.41	-2.21	54	-6.8	187	113	Average
11510	56.42	58.63	-2.21	74	-17.58	187	113	Peak

<Out of Band Emission (OOBE)>

Antenna Polarity & Test Distance: Horizontal at 3 m								
Frequency (MHz)	Emission Level (dBuV/m)	Read Level (dBuV)	Factor (dB/m)	Limit (dBuV/m)	Margin (dB)	Antenna Height (cm)	Table Angle (Degree)	Remark
5632.65	50.55	48.67	1.88	68.2	-17.65	125	244	Peak
5657.825	50.41	48.56	1.85	74.01	-23.6	125	244	Peak
5915.275	51.05	48.74	2.31	75.37	-24.32	125	244	Peak
5934.75	51.22	48.92	2.3	68.2	-16.98	125	244	Peak
Antenna Polarity & Test Distance: Vertical at 3 m								
Frequency (MHz)	Emission Level (dBuV/m)	Read Level (dBuV)	Factor (dB/m)	Limit (dBuV/m)	Margin (dB)	Antenna Height (cm)	Table Angle (Degree)	Remark
5637.4	50.76	48.88	1.88	68.2	-17.44	126	246	Peak
5659.725	51.08	49.23	1.85	75.42	-24.34	126	246	Peak
5919.075	50.64	48.33	2.31	72.57	-21.93	126	246	Peak
5990.325	52.32	49.96	2.36	68.2	-15.88	126	246	Peak

Remarks:

- Emission Level = Read Level + Factor
Margin value = Emission level – Limit value
- 5755 MHz: Fundamental Frequency
- *: Out of Restricted Band
- The emission levels of other frequencies were very low against the limit

EUT Test Condition		Measurement Detail	
Channel	Channel 159	Frequency Range	1 GHz ~ 40 GHz
Input Power	120 Vac, 60 Hz	Detector Function	Peak (PK) Average (AV)
Environmental Conditions	25 deg. C, 65 % RH	Tested By	Tim Chen

<Spurious Emission>

Antenna Polarity & Test Distance: Horizontal at 3 m								
Frequency (MHz)	Emission Level (dBuV/m)	Read Level (dBuV)	Factor (dB/m)	Limit (dBuV/m)	Margin (dB)	Antenna Height (cm)	Table Angle (Degree)	Remark
5795	85.44	83.44	2			124	246	Average
5795	91.58	89.58	2			124	246	Peak
11590	46.39	48.58	-2.19	54	-7.61	165	304	Average
11590	56.59	58.78	-2.19	74	-17.41	165	304	Peak
Antenna Polarity & Test Distance: Vertical at 3 m								
Frequency (MHz)	Emission Level (dBuV/m)	Read Level (dBuV)	Factor (dB/m)	Limit (dBuV/m)	Margin (dB)	Antenna Height (cm)	Table Angle (Degree)	Remark
5795	91.84	89.84	2			127	198	Average
5795	97.94	95.94	2			127	198	Peak
11590	46.74	48.93	-2.19	54	-7.26	143	192	Average
11590	55.74	57.93	-2.19	74	-18.26	143	192	Peak

<Out of Band Emission (OOBE)>

Antenna Polarity & Test Distance: Horizontal at 3 m								
Frequency (MHz)	Emission Level (dBuV/m)	Read Level (dBuV)	Factor (dB/m)	Limit (dBuV/m)	Margin (dB)	Antenna Height (cm)	Table Angle (Degree)	Remark
5591.325	50.88	49.01	1.87	68.2	-17.32	124	246	Peak
5656.875	50.48	48.63	1.85	73.31	-22.83	124	246	Peak
5923.825	49.9	47.6	2.3	69.07	-19.17	124	246	Peak
5999.35	51.01	48.65	2.36	68.2	-17.19	124	246	Peak
Antenna Polarity & Test Distance: Vertical at 3 m								
Frequency (MHz)	Emission Level (dBuV/m)	Read Level (dBuV)	Factor (dB/m)	Limit (dBuV/m)	Margin (dB)	Antenna Height (cm)	Table Angle (Degree)	Remark
5641.2	51.95	50.07	1.88	68.2	-16.25	127	198	Peak
5658.775	50.42	48.57	1.85	74.72	-24.3	127	198	Peak
5918.125	51.75	49.44	2.31	73.27	-21.52	127	198	Peak
6011.225	52.38	49.98	2.4	68.2	-15.82	127	198	Peak

Remarks:

- Emission Level = Read Level + Factor
Margin value = Emission level – Limit value
- 5795 MHz: Fundamental Frequency
- *: Out of Restricted Band
- The emission levels of other frequencies were very low against the limit

802.11ac (VHT80)

EUT Test Condition		Measurement Detail	
Channel	Channel 42	Frequency Range	1 GHz ~ 40 GHz
Input Power	120 Vac, 60 Hz	Detector Function	Peak (PK) Average (AV)
Environmental Conditions	25 deg. C, 65 % RH	Tested By	Tim Chen

Antenna Polarity & Test Distance: Horizontal at 3 m								
Frequency (MHz)	Emission Level (dBuV/m)	Read Level (dBuV)	Factor (dB/m)	Limit (dBuV/m)	Margin (dB)	Antenna Height (cm)	Table Angle (Degree)	Remark
5150	51.61	50.08	1.53	54	-2.39	100	102	Average
5150	62.1	60.57	1.53	74	-11.9	100	102	Peak
5210	89.71	88.27	1.44			100	102	Average
5210	99.43	97.99	1.44			100	102	Peak
5350	41.72	40.26	1.46	54	-12.28	100	102	Average
5350	53.01	51.55	1.46	74	-20.99	100	102	Peak
*10420	55.84	58.69	-2.85	68.2	-12.36	203	166	Peak

Antenna Polarity & Test Distance: Vertical at 3 m								
Frequency (MHz)	Emission Level (dBuV/m)	Read Level (dBuV)	Factor (dB/m)	Limit (dBuV/m)	Margin (dB)	Antenna Height (cm)	Table Angle (Degree)	Remark
5150	51.5	49.97	1.53	54	-2.5	105	70	Average
5150	63.18	61.65	1.53	74	-10.82	105	70	Peak
5210	89.81	88.37	1.44			105	70	Average
5210	100.1	98.66	1.44			105	70	Peak
5350	42.54	41.08	1.46	54	-11.46	105	70	Average
5350	53.22	51.76	1.46	74	-20.78	105	70	Peak
*10420	56.46	59.31	-2.85	68.2	-11.74	108	133	Peak

Remarks:

- Emission Level = Read Level + Factor
Margin value = Emission level – Limit value
- 5210 MHz: Fundamental Frequency
- *: Out of Restricted Band
- The emission levels of other frequencies were very low against the limit

EUT Test Condition		Measurement Detail	
Channel	Channel 58	Frequency Range	1 GHz ~ 40 GHz
Input Power	120 Vac, 60 Hz	Detector Function	Peak (PK) Average (AV)
Environmental Conditions	25 deg. C, 65 % RH	Tested By	Tim Chen

Antenna Polarity & Test Distance: Horizontal at 3 m								
Frequency (MHz)	Emission Level (dBuV/m)	Read Level (dBuV)	Factor (dB/m)	Limit (dBuV/m)	Margin (dB)	Antenna Height (cm)	Table Angle (Degree)	Remark
5150	43.67	42.14	1.53	54	-10.33	114	108	Average
5150	50.96	49.43	1.53	74	-23.04	114	108	Peak
5290	91.41	90.1	1.31			114	108	Average
5290	97.85	96.54	1.31			114	108	Peak
5350	49.92	48.46	1.46	54	-4.08	114	108	Average
5350	56.43	54.97	1.46	74	-17.57	114	108	Peak
*10580	57.13	60.01	-2.88	68.2	-11.07	194	236	Peak
Antenna Polarity & Test Distance: Vertical at 3 m								
Frequency (MHz)	Emission Level (dBuV/m)	Read Level (dBuV)	Factor (dB/m)	Limit (dBuV/m)	Margin (dB)	Antenna Height (cm)	Table Angle (Degree)	Remark
5150	43.43	41.9	1.53	54	-10.57	100	87	Average
5150	51.65	50.12	1.53	74	-22.35	100	87	Peak
5290	92.14	90.83	1.31			100	87	Average
5290	98.59	97.28	1.31			100	87	Peak
5350	51.87	50.41	1.46	54	-2.13	100	87	Average
5350	61.56	60.1	1.46	74	-12.44	100	87	Peak
*10580	57.14	60.02	-2.88	68.2	-11.06	123	166	Peak

Remarks:

- Emission Level = Read Level + Factor
Margin value = Emission level – Limit value
- 5290 MHz: Fundamental Frequency
- *: Out of Restricted Band
- The emission levels of other frequencies were very low against the limit

EUT Test Condition		Measurement Detail	
Channel	Channel 106	Frequency Range	1 GHz ~ 40 GHz
Input Power	120 Vac, 60 Hz	Detector Function	Peak (PK) Average (AV)
Environmental Conditions	25 deg. C, 65 % RH	Tested By	Tim Chen

Antenna Polarity & Test Distance: Horizontal at 3 m								
Frequency (MHz)	Emission Level (dBuV/m)	Read Level (dBuV)	Factor (dB/m)	Limit (dBuV/m)	Margin (dB)	Antenna Height (cm)	Table Angle (Degree)	Remark
5460	50.75	48.88	1.87	54	-3.25	100	102	Average
5460	59.08	57.21	1.87	74	-14.92	100	102	Peak
*5470	60.61	58.75	1.86	68.2	-7.59	100	102	Peak
5530	89.48	87.67	1.81			100	102	Average
5530	96.1	94.29	1.81			100	102	Peak
*5725	49.94	48.18	1.76	68.2	-18.26	100	102	Peak
11060	46.22	48.64	-2.42	54	-7.78	173	231	Average
11060	56.78	59.2	-2.42	74	-17.22	173	231	Peak

Antenna Polarity & Test Distance: Vertical at 3 m								
Frequency (MHz)	Emission Level (dBuV/m)	Read Level (dBuV)	Factor (dB/m)	Limit (dBuV/m)	Margin (dB)	Antenna Height (cm)	Table Angle (Degree)	Remark
5460	51.95	50.08	1.87	54	-2.05	100	78	Average
5460	60.8	58.93	1.87	74	-13.2	100	78	Peak
*5470	62	60.14	1.86	68.2	-6.2	100	78	Peak
5530	90.52	88.71	1.81			100	78	Average
5530	97.44	95.63	1.81			100	78	Peak
*5725	49.19	47.43	1.76	68.2	-19.01	100	78	Peak
11060	46.26	48.68	-2.42	54	-7.74	103	158	Average
11060	56.89	59.31	-2.42	74	-17.11	103	158	Peak

Remarks:

- Emission Level = Read Level + Factor
Margin value = Emission level – Limit value
- 5530 MHz: Fundamental Frequency
- *: Out of Restricted Band
- The emission levels of other frequencies were very low against the limit

EUT Test Condition		Measurement Detail	
Channel	Channel 122	Frequency Range	1 GHz ~ 40 GHz
Input Power	120 Vac, 60 Hz	Detector Function	Peak (PK) Average (AV)
Environmental Conditions	25 deg. C, 65 % RH	Tested By	Tim Chen

Antenna Polarity & Test Distance: Horizontal at 3 m								
Frequency (MHz)	Emission Level (dBuV/m)	Read Level (dBuV)	Factor (dB/m)	Limit (dBuV/m)	Margin (dB)	Antenna Height (cm)	Table Angle (Degree)	Remark
5460	43.21	41.34	1.87	54	-10.79	105	102	Average
5460	54.27	52.4	1.87	74	-19.73	105	102	Peak
*5470	54.89	53.03	1.86	68.2	-13.31	105	102	Peak
5610	90.4	88.53	1.87			105	102	Average
5610	99.68	97.81	1.87			105	102	Peak
*5725	53.74	51.98	1.76	68.2	-14.46	105	102	Peak
11220	45.46	47.98	-2.52	54	-8.54	188	168	Average
11220	56.93	59.45	-2.52	74	-17.07	188	168	Peak

Antenna Polarity & Test Distance: Vertical at 3 m								
Frequency (MHz)	Emission Level (dBuV/m)	Read Level (dBuV)	Factor (dB/m)	Limit (dBuV/m)	Margin (dB)	Antenna Height (cm)	Table Angle (Degree)	Remark
5460	44.3	42.43	1.87	54	-9.7	100	88	Average
5460	57.3	55.43	1.87	74	-16.7	100	88	Peak
*5470	55.76	53.9	1.86	68.2	-12.44	100	88	Peak
5610	92.98	91.11	1.87			100	88	Average
5610	102.57	100.7	1.87			100	88	Peak
*5725	53.23	51.47	1.76	68.2	-14.97	100	88	Peak
11220	45.55	48.07	-2.52	54	-8.45	113	261	Average
11220	57.4	59.92	-2.52	74	-16.6	113	261	Peak

Remarks:

- Emission Level = Read Level + Factor
Margin value = Emission level – Limit value
- 5610 MHz: Fundamental Frequency
- *: Out of Restricted Band
- The emission levels of other frequencies were very low against the limit

EUT Test Condition		Measurement Detail	
Channel	Channel 155	Frequency Range	1 GHz ~ 40 GHz
Input Power	120 Vac, 60 Hz	Detector Function	Peak (PK) Average (AV)
Environmental Conditions	25 deg. C, 65 % RH	Tested By	Tim Chen

<Spurious Emission>

Antenna Polarity & Test Distance: Horizontal at 3 m								
Frequency (MHz)	Emission Level (dBuV/m)	Read Level (dBuV)	Factor (dB/m)	Limit (dBuV/m)	Margin (dB)	Antenna Height (cm)	Table Angle (Degree)	Remark
5775	89.5	87.54	1.96			122	107	Average
5775	95.89	93.93	1.96			122	107	Peak
11550	46.93	49.13	-2.2	54	-7.07	147	227	Average
11550	56.18	58.38	-2.2	74	-17.82	147	227	Peak
Antenna Polarity & Test Distance: Vertical at 3 m								
Frequency (MHz)	Emission Level (dBuV/m)	Read Level (dBuV)	Factor (dB/m)	Limit (dBuV/m)	Margin (dB)	Antenna Height (cm)	Table Angle (Degree)	Remark
5775	91.36	89.4	1.96			121	85	Average
5775	96.09	94.13	1.96			121	85	Peak
11550	47.26	49.46	-2.2	54	-6.74	158	122	Average
11550	56.29	58.49	-2.2	74	-17.71	158	122	Peak

<Out of Band Emission (OOBE)>

Antenna Polarity & Test Distance: Horizontal at 3 m								
Frequency (MHz)	Emission Level (dBuV/m)	Read Level (dBuV)	Factor (dB/m)	Limit (dBuV/m)	Margin (dB)	Antenna Height (cm)	Table Angle (Degree)	Remark
5635.5	52.83	50.95	1.88	68.2	-15.37	122	107	Peak
5659.725	55.28	53.43	1.85	75.42	-20.14	122	107	Peak
5923.825	50.93	48.63	2.3	69.07	-18.14	122	107	Peak
5937.6	50.95	48.65	2.3	68.2	-17.25	122	107	Peak
Antenna Polarity & Test Distance: Vertical at 3 m								
Frequency (MHz)	Emission Level (dBuV/m)	Read Level (dBuV)	Factor (dB/m)	Limit (dBuV/m)	Margin (dB)	Antenna Height (cm)	Table Angle (Degree)	Remark
5624.575	55.08	53.18	1.9	68.2	-13.12	121	85	Peak
5657.825	54.87	53.02	1.85	74.01	-19.14	121	85	Peak
5917.65	50.99	48.68	2.31	73.62	-22.63	121	85	Peak
5999.825	51.91	49.55	2.36	68.2	-16.29	121	85	Peak

Remarks:

- Emission Level = Read Level + Factor
Margin value = Emission level – Limit value
- 5775 MHz: Fundamental Frequency
- *: Out of Restricted Band
- The emission levels of other frequencies were very low against the limit

9 kHz ~ 30 MHz Data:

The amplitude of spurious emissions attenuated more than 20 dB below the permissible value is not required to be report.

30 MHz ~ 1 GHz Worst-Case Data:

802.11ac (VHT80)

EUT Test Condition		Measurement Detail	
Channel	Channel 106	Frequency Range	30 MHz ~ 1 GHz
Input Power	120 Vac, 60 Hz	Detector Function	Peak (PK) Quasi-peak (QP)
Environmental Conditions	25 deg. C, 65 % RH	Tested By	Tim Chen

Horizontal

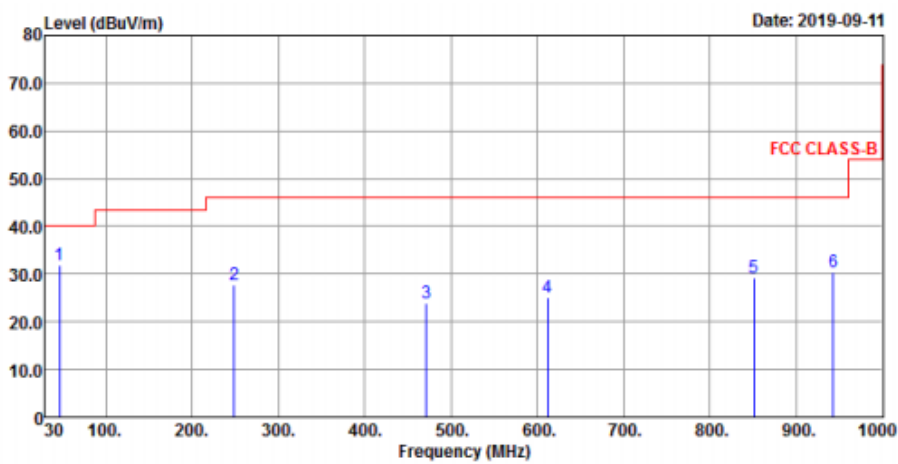

Vertical

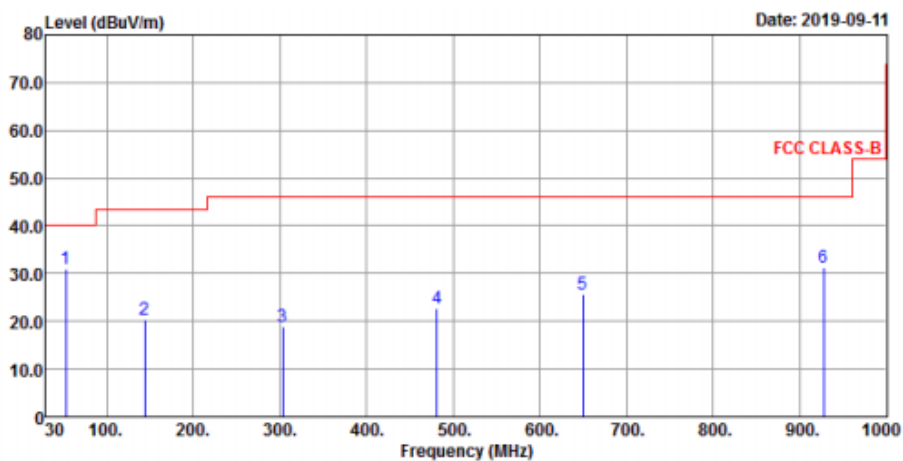

Antenna Polarity & Test Distance: Horizontal at 3 m

Frequency (MHz)	Emission Level (dBuV/m)	Read Level (dBuV)	Factor (dB/m)	Limit (dBuV/m)	Margin (dB)	Antenna Height (cm)	Table Angle (Degree)	Remark
46.254	31.96	49.09	-17.13	40	-8.04	137	155	Peak
249.167	27.7	45.35	-17.65	46	-18.3	168	176	Peak
471.165	23.85	36.04	-12.19	46	-22.15	198	203	Peak
612.356	25.16	33.49	-8.33	46	-20.84	235	247	Peak
851.197	29.18	33.33	-4.15	46	-16.82	269	288	Peak
943.139	30.27	33.01	-2.74	46	-15.73	298	332	Peak

Antenna Polarity & Test Distance: Vertical at 3 m

Frequency (MHz)	Emission Level (dBuV/m)	Read Level (dBuV)	Factor (dB/m)	Limit (dBuV/m)	Margin (dB)	Antenna Height (cm)	Table Angle (Degree)	Remark
53.369	30.89	48.5	-17.61	40	-9.11	122	141	Peak
144.36	20.26	37.79	-17.53	43.5	-23.24	155	164	Peak
303.171	18.94	35.49	-16.55	46	-27.06	181	203	Peak
481.19	22.68	34.5	-11.82	46	-23.32	235	261	Peak
649.238	25.78	34.02	-8.24	46	-20.22	268	274	Peak
927.138	31.21	34.2	-2.99	46	-14.79	306	321	Peak

Remarks:

- Emission Level = Read Level + Factor
Margin value = Emission level – Limit value
- The emission levels of other frequencies were very low against the limit

4.2 Conducted Emission Measurement

4.2.1 Limits of Conducted Emission Measurement

Frequency (MHz)	Conducted Limit (dBuV)	
	Quasi-Peak	Average
0.15 - 0.5	66 - 56	56 - 46
0.50 - 5.0	56	46
5.0 - 30.0	60	50

- Note: 1. The lower limit shall apply at the transition frequencies.
 2. The limit decreases in line with the logarithm of the frequency in the range of 0.15 to 0.50 MHz.

4.2.2 Test Instruments

Description & Manufacturer	Model No.	Serial No.	Date of Calibration	Due Date of Calibration
Test Receiver ROHDE & SCHWARZ	ESCI	100613	Dec. 10, 2018	Dec. 09, 2019
RF signal cable Woken	5D-FB	Cable-cond1-01	Sep. 05, 2019	Sep. 04, 2020
LISN ROHDE & SCHWARZ (EUT)	ENV216	101826	Feb. 21, 2019	Feb. 20, 2020
LISN ROHDE & SCHWARZ (Peripheral)	ESH3-Z5	100311	Aug. 22, 2019	Aug. 21, 2020
Software ADT	BV ADT_Cond_ V7.3.7.4	NA	NA	NA

- Note: 1. The calibration interval of the above test instruments is 12 months and the calibrations are traceable to NML/ROC and NIST/USA.
 2. The test was performed in HwaYa Shielded Room 1.
 3. The VCCI Site Registration No. is C-12040.

4.2.3 Test Procedures

- a. The EUT was placed 0.4 meters from the conducting wall of the shielded room with EUT being connected to the power mains through a line impedance stabilization network (LISN). Other support units were connected to the power mains through another LISN. The two LISNs provide 50 ohm/ 50uH of coupling impedance for the measuring instrument.
- b. Both lines of the power mains connected to the EUT were checked for maximum conducted interference.
- c. The frequency range from 150 kHz to 30 MHz was searched. Emission levels under (Limit -20 dB) was not recorded.

Note: All modes of operation were investigated and the worst-case emissions are reported.

4.2.4 Deviation from Test Standard

No deviation.

4.2.5 Test Setup

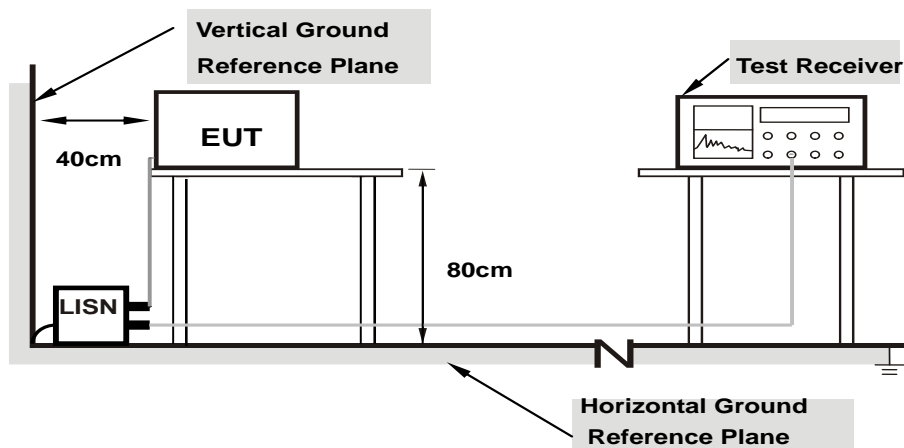

- Note:**
1. Support units were connected to second LISN.
 2. Both of LISNs (AMN) are 80 cm from EUT and at least 80 from other units and other metal planes

For the actual test configuration, please refer to the attached file (Test Setup Photo).

4.2.6 EUT Operating Conditions

- a. Placed the EUT on a testing table.
- b. Use the software to control the EUT under transmission condition continuously at specific channel frequency.

4.2.7 Test Results

Frequency Range	150kHz ~ 30MHz	Detector Function & Resolution Bandwidth	Quasi-Peak (QP) / Average (AV), 9kHz
Input Power	120Vac, 60Hz	Environmental Conditions	25°C, 65%RH
Tested by	Thomas Wei	Test Date	2019/9/11

Phase Of Power : Line (L)										
No	Frequency (MHz)	Correction Factor (dB)	Reading Value (dBuV)		Emission Level (dBuV)		Limit (dBuV)		Margin (dB)	
			Q.P.	AV.	Q.P.	AV.	Q.P.	AV.	Q.P.	AV.
1	0.16569	9.73	18.80	9.32	28.53	19.05	65.17	55.17	-36.64	-36.12
2	0.22038	9.79	18.38	7.59	28.17	17.38	62.80	52.80	-34.63	-35.42
3	0.30640	9.84	17.76	8.69	27.60	18.53	60.07	50.07	-32.47	-31.54
4	0.52927	9.93	15.62	6.19	25.55	16.12	56.00	46.00	-30.45	-29.88
5	0.67003	9.95	18.27	6.25	28.22	16.20	56.00	46.00	-27.78	-29.80
6	11.23485	10.33	17.42	7.10	27.75	17.43	60.00	50.00	-32.25	-32.57

Remarks:

1. Q.P. and AV. are abbreviations of quasi-peak and average individually.
2. The emission levels of other frequencies were very low against the limit.
3. Margin value = Emission level – Limit value
4. Correction factor = Insertion loss + Cable loss
5. Emission Level = Correction Factor + Reading Value

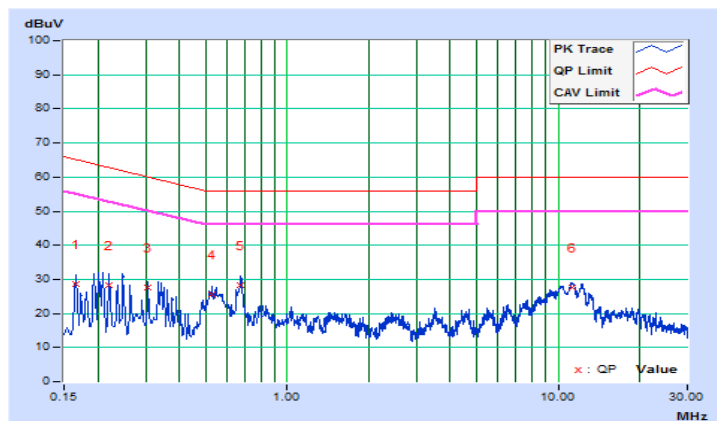

Frequency Range	150kHz ~ 30MHz	Detector Function & Resolution Bandwidth	Quasi-Peak (QP) / Average (AV), 9kHz
Input Power	120Vac, 60Hz	Environmental Conditions	25°C, 65%RH
Tested by	Thomas Wei	Test Date	2019/9/11

Phase Of Power : Neutral (N)										
No	Frequency (MHz)	Correction Factor (dB)	Reading Value (dBuV)		Emission Level (dBuV)		Limit (dBuV)		Margin (dB)	
			Q.P.	AV.	Q.P.	AV.	Q.P.	AV.	Q.P.	AV.
1	0.16564	9.72	21.46	12.35	31.18	22.07	65.18	55.18	-34.00	-33.11
2	0.21256	9.80	21.30	11.27	31.10	21.07	63.10	53.10	-32.00	-32.03
3	0.30640	9.83	19.11	10.37	28.94	20.20	60.07	50.07	-31.13	-29.87
4	0.54882	9.88	17.26	7.11	27.14	16.99	56.00	46.00	-28.86	-29.01
5	0.66221	9.90	17.08	7.72	26.98	17.62	56.00	46.00	-29.02	-28.38
6	12.32574	10.31	17.04	5.62	27.35	15.93	60.00	50.00	-32.65	-34.07

Remarks:

1. Q.P. and AV. are abbreviations of quasi-peak and average individually.
2. The emission levels of other frequencies were very low against the limit.
3. Margin value = Emission level – Limit value
4. Correction factor = Insertion loss + Cable loss
5. Emission Level = Correction Factor + Reading Value

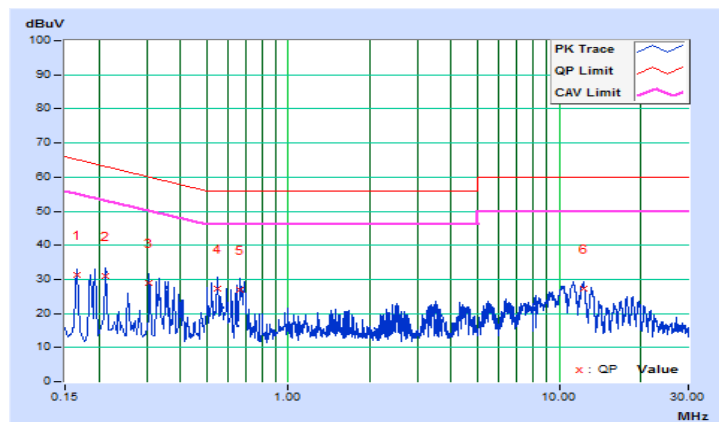

4.3 Transmit Power Measurement

4.3.1 Limits of Transmit Power Measurement

Operation Band	EUT Category	Limit
U-NII-1	Outdoor Access Point	1 Watt (30 dBm) (Max. e.i.r.p \leq 125 mW (21 dBm) at any elevation angle above 30 degrees as measured from the horizon)
	Fixed point-to-point Access Point	1 Watt (30 dBm)
	Indoor Access Point	1 Watt (30 dBm)
	√ Mobile and Portable client device	250 mW (24 dBm)
U-NII-2A	√	250 mW (24 dBm) or 11 dBm + 10 log B*
U-NII-2C	√	250 mW (24 dBm) or 11 dBm + 10 log B*
U-NII-3	√	1 Watt (30 dBm)

*B is the 26 dB emission bandwidth in megahertz

Per KDB 662911 Method of conducted output power measurement on IEEE 802.11 devices,

Array Gain = 0 dB (i.e., no array gain) for $N_{ANT} \leq 4$;

Array Gain = 0 dB (i.e., no array gain) for channel widths ≥ 40 MHz for any N_{ANT} ;

Array Gain = $5 \log(N_{ANT}/N_{SS})$ dB or 3 dB, whichever is less for 20 MHz channel widths with $N_{ANT} \geq 5$.

For power measurements on all other devices: Array Gain = $10 \log(N_{ANT}/N_{SS})$ dB.

4.3.2 Test Setup

<Power Output Measurement>

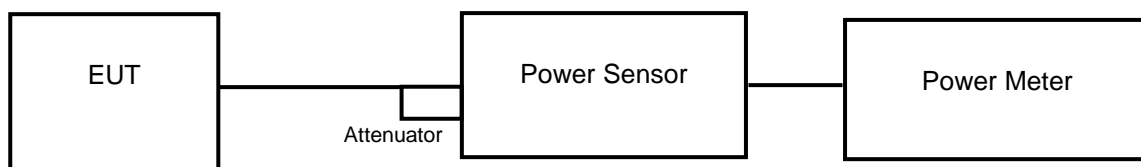

or

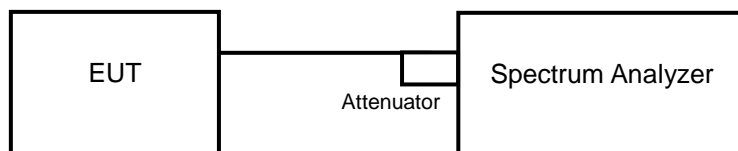

<26 dB Bandwidth>

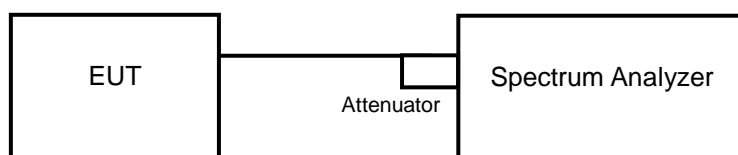

4.3.3 Test Instruments

Refer to section 4.1.2 to get information of above instrument.

4.3.4 Test Procedure

Average Power Measurement

<802.11a, 802.11n (HT20), 802.11n (HT40)>

Method PM is used to perform output power measurement, trigger and gating function of wide band power meter is enabled to measure max output power of TX on burst. Duty factor is not added to measured value.

<802.11ac (VHT80)>

- a. Set span to encompass the entire 26 dB EBW (or, alternatively, the entire 99 % occupied bandwidth) of the signal.
- b. Set sweep trigger to "free run".
- c. Set RBW = 1 MHz.
- d. Set VBW \geq 3 MHz
- e. Number of points in sweep \geq 2 Span / RBW.
- f. Sweep time \leq (number of points in sweep) * T
- g. Using emission bandwidth to determine the frequency span for integration the channel bandwidth.
- h. Detector = RMS.
- i. Trace mode = max hold.
- j. Allow max hold to run for at least 60 seconds, or longer as needed to allow the trace to stabilize.

26 dB Bandwidth

- a. Set RBW = approximately 1 % of the emission bandwidth.
- b. Set the VBW > RBW.
- c. Detector = Peak.
- d. Trace mode = max hold.
- e. Measure the maximum width of the emission that is 26 dB down from the peak of the emission. Compare this with the RBW setting of the analyzer. Readjust RBW and repeat measurement as needed until the RBW/EBW ratio is approximately 1 %.

4.3.5 Deviation from Test Standard

No deviation.

4.3.6 EUT Operating Conditions

The software provided by client to enable the EUT under transmission condition continuously at lowest, middle and highest channel frequencies individually.

4.3.7 Test Results

Power Output:

802.11a

Channel	Frequency (MHz)	Maximum Conducted Power (mW)	Maximum Conducted Power (dBm)	Power Limit (dBm)	Pass / Fail
36	5180	19.724	12.95	24	Pass
40	5200	17.579	12.45	24	Pass
48	5240	16.406	12.15	24	Pass
52	5260	17.742	12.49	24	Pass
60	5300	17.62	12.46	24	Pass
64	5320	17.1	12.33	24	Pass
100	5500	17.989	12.55	24	Pass
116	5580	19.543	12.91	24	Pass
140	5700	20.37	13.09	24	Pass
149	5745	19.409	12.88	30	Pass
157	5785	20.184	13.05	30	Pass
165	5825	19.231	12.84	30	Pass

Note:

For U-NII-2A, U-NII-2C Band:

1. $11 \text{ dBm} + 10\log(21.69) = 24.36 \text{ dBm} > 24 \text{ dBm}$.
2. $11 \text{ dBm} + 10\log(21.64) = 24.35 \text{ dBm} > 24 \text{ dBm}$.
3. $11 \text{ dBm} + 10\log(21.67) = 24.35 \text{ dBm} > 24 \text{ dBm}$.
4. $11 \text{ dBm} + 10\log(21.62) = 24.34 \text{ dBm} > 24 \text{ dBm}$.
5. $11 \text{ dBm} + 10\log(21.59) = 24.34 \text{ dBm} > 24 \text{ dBm}$.
6. $11 \text{ dBm} + 10\log(21.62) = 24.34 \text{ dBm} > 24 \text{ dBm}$.

802.11n (HT20)

Channel	Frequency (MHz)	Maximum Conducted Power (mW)	Maximum Conducted Power (dBm)	Power Limit (dBm)	Pass / Fail
36	5180	16.181	12.09	24	Pass
40	5200	15.74	11.97	24	Pass
48	5240	15.849	12.00	24	Pass
52	5260	15.996	12.04	24	Pass
60	5300	16.482	12.17	24	Pass
64	5320	15.922	12.02	24	Pass
100	5500	16.866	12.27	24	Pass
116	5580	17.298	12.38	24	Pass
140	5700	17.418	12.41	24	Pass
149	5745	17.1	12.33	30	Pass
157	5785	18.239	12.61	30	Pass
165	5825	18.113	12.58	30	Pass

Note:

For U-NII-2A, U-NII-2C Band:

1. $11 \text{ dBm} + 10\log(21.77) = 24.37 \text{ dBm} > 24 \text{ dBm}$.
2. $11 \text{ dBm} + 10\log(21.73) = 24.37 \text{ dBm} > 24 \text{ dBm}$.
3. $11 \text{ dBm} + 10\log(22.05) = 24.43 \text{ dBm} > 24 \text{ dBm}$.
4. $11 \text{ dBm} + 10\log(21.91) = 24.40 \text{ dBm} > 24 \text{ dBm}$.
5. $11 \text{ dBm} + 10\log(21.78) = 24.38 \text{ dBm} > 24 \text{ dBm}$.
6. $11 \text{ dBm} + 10\log(21.84) = 24.39 \text{ dBm} > 24 \text{ dBm}$.

802.11n (HT40)

Channel	Frequency (MHz)	Maximum Conducted Power (mW)	Maximum Conducted Power (dBm)	Power Limit (dBm)	Pass / Fail
38	5190	7.516	8.76	24	Pass
46	5230	15.524	11.91	24	Pass
54	5270	15.849	12.00	24	Pass
62	5310	16.482	12.17	24	Pass
102	5510	9.572	9.81	24	Pass
110	5550	14.997	11.76	24	Pass
134	5670	18.072	12.57	24	Pass
151	5755	17.783	12.50	30	Pass
159	5795	19.679	12.94	30	Pass

Note:

For U-NII-2A, U-NII-2C Band:

1. $11 \text{ dBm} + 10\log (41.24) = 27.15 \text{ dBm} > 24 \text{ dBm}$.
2. $11 \text{ dBm} + 10\log (41.09) = 27.13 \text{ dBm} > 24 \text{ dBm}$.
3. $11 \text{ dBm} + 10\log (41.14) = 27.14 \text{ dBm} > 24 \text{ dBm}$.
4. $11 \text{ dBm} + 10\log (41.44) = 27.17 \text{ dBm} > 24 \text{ dBm}$.
5. $11 \text{ dBm} + 10\log (41.12) = 27.14 \text{ dBm} > 24 \text{ dBm}$.

802.11ac (VHT80)

Channel	Frequency (MHz)	Maximum Conducted Power (mW)	Maximum Conducted Power (dBm)	Power Limit (dBm)	Pass / Fail
42	5210	4.842	6.85	24	Pass
58	5290	7.925	8.99	24	Pass
106	5530	7.178	8.56	24	Pass
122	5610	16.032	12.05	24	Pass
155	5775	17.824	12.51	30	Pass

Note:

For U-NII-2A, U-NII-2C Band:

1. $11 \text{ dBm} + 10\log (81.99) = 30.13 \text{ dBm} > 24 \text{ dBm}$.
2. $11 \text{ dBm} + 10\log (82.23) = 30.15 \text{ dBm} > 24 \text{ dBm}$.
3. $11 \text{ dBm} + 10\log (82.15) = 30.14 \text{ dBm} > 24 \text{ dBm}$.

26 dB Bandwidth:
802.11a

Channel	Frequency (MHz)	26 dBc Bandwidth (MHz)
36	5180	21.60
40	5200	21.65
48	5240	21.68
52	5260	21.69
60	5300	21.64
64	5320	21.67
100	5500	21.62
116	5580	21.59
140	5700	21.62

802.11n (HT20)

Channel	Frequency (MHz)	26 dBc Bandwidth (MHz)
36	5180	21.92
40	5200	21.74
48	5240	21.84
52	5260	21.77
60	5300	21.73
64	5320	22.05
100	5500	21.91
116	5580	21.78
140	5700	21.84

802.11n (HT40)

Channel	Frequency (MHz)	26 dBc Bandwidth (MHz)
38	5190	41.15
46	5230	41.27
54	5270	41.24
62	5310	41.09
102	5510	41.14
110	5550	41.44
134	5670	41.12

802.11ac (VHT80)

Channel	Frequency (MHz)	26 dBc Bandwidth (MHz)
42	5210	81.88
58	5290	81.99
106	5530	82.23
122	5610	82.15

Spectrum Plot of Worst Value

802.11a

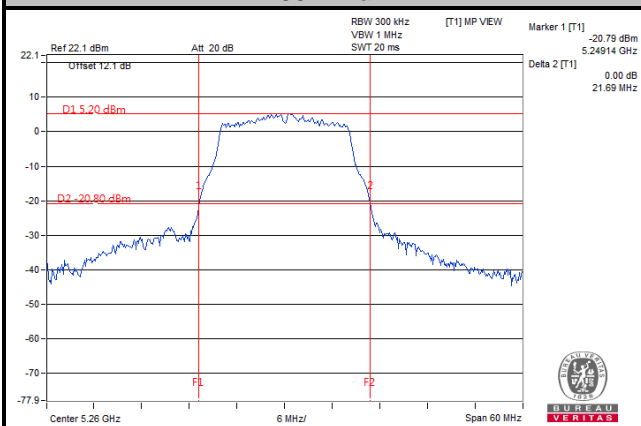

802.11n (HT20)

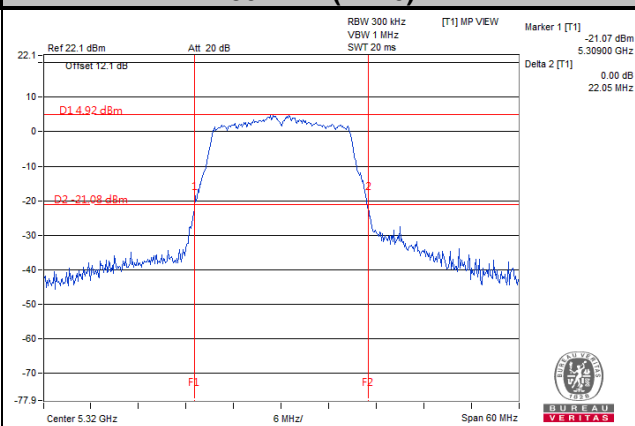

802.11n (HT40)

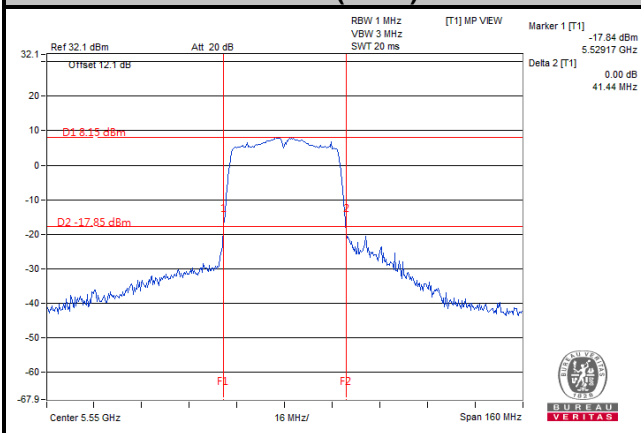

802.11ac (VHT80)

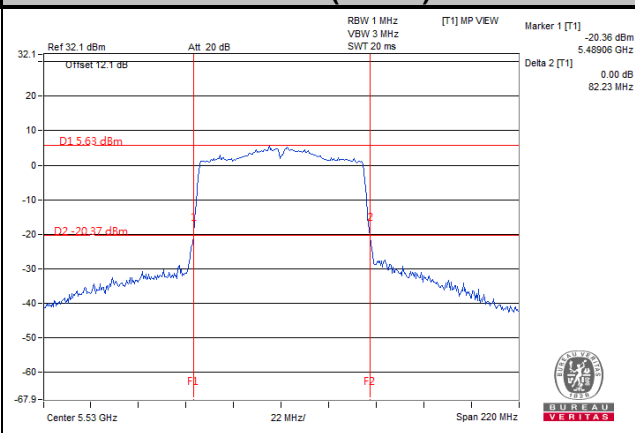

4.4 Occupied Bandwidth Measurement

4.4.1 Test Setup



4.4.2 Test Instruments

Refer to section 4.1.2 to get information of above instrument.

4.4.3 Test Procedure

The transmitter output was connected to the spectrum analyzer through an attenuator. The bandwidth of the fundamental frequency was measured by spectrum analyzer with resolution bandwidth in the range of 1 % to 5 % of the anticipated emission bandwidth, and a video bandwidth at least 3x the resolution bandwidth and set the detector to SAMPLE. The width of a frequency band such that, below the lower and above the upper frequency limits, the mean powers emitted are each equal to a specified percentage 0.5 % of the total mean power of a given emission.

4.4.4 Test Results

802.11a

Channel	Channel Frequency (MHz)	Occupied Bandwidth (MHz)
36	5180	17.04
40	5200	16.92
48	5240	16.92
52	5260	16.92
60	5300	16.92
64	5320	16.92
100	5500	16.92
116	5580	16.92
140	5700	16.92
149	5745	16.98
157	5785	16.92
165	5825	16.92

802.11n (HT20)

Channel	Channel Frequency (MHz)	Occupied Bandwidth (MHz)
36	5180	18.12
40	5200	18.12
48	5240	18.00
52	5260	18.12
60	5300	18.00
64	5320	18.00
100	5500	18.00
116	5580	18.12
140	5700	18.00
149	5745	18.00
157	5785	17.94
165	5825	17.94

802.11n (HT40)

Channel	Channel Frequency (MHz)	Occupied Bandwidth (MHz)
38	5190	36.60
46	5230	36.72
54	5270	36.60
62	5310	36.60
102	5510	36.60
110	5550	36.60
134	5670	36.60
151	5755	36.54
159	5795	36.48

802.11ac (VHT80)

Channel	Channel Frequency (MHz)	Occupied Bandwidth (MHz)
42	5210	75.60
58	5290	74.64
106	5530	75.60
122	5610	75.60
155	5775	75.60

Spectrum Plot of Worst Value

802.11a

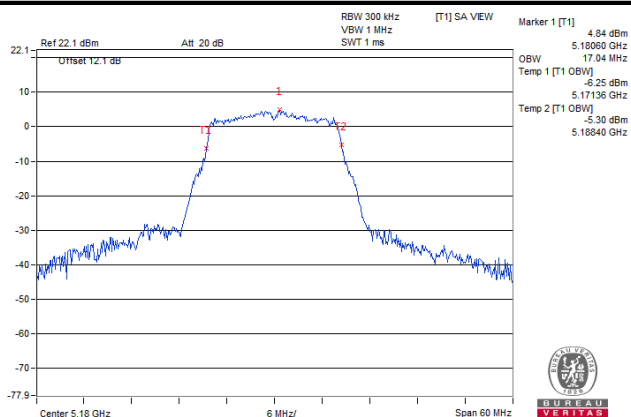

802.11n (HT20)

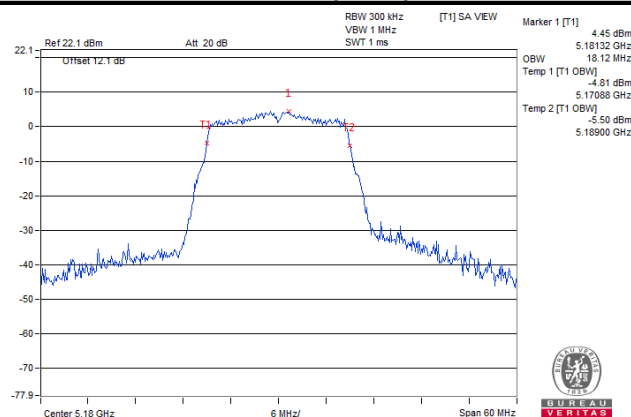

802.11n (HT40)

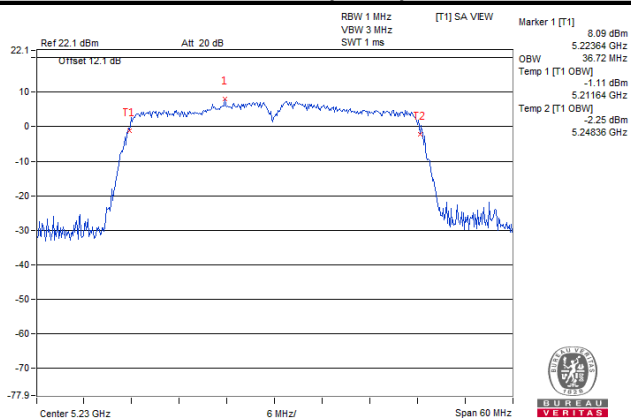

802.11ac (VHT80)

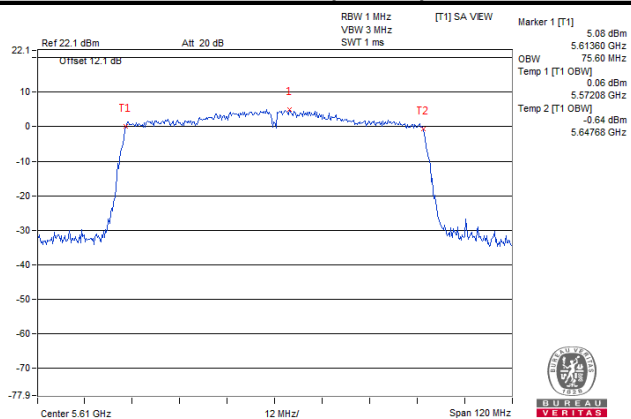

4.5 Peak Power Spectral Density Measurement

4.5.1 Limits of Peak Power Spectral Density Measurement

Operation Band	EUT Category		Limit
U-NII-1		Outdoor Access Point	17 dBm/MHz
		Fixed point-to-point Access Point	
		Indoor Access Point	
	√	Mobile and Portable client device	11 dBm/MHz
U-NII-2A		√	11 dBm/MHz
U-NII-2C		√	11 dBm/MHz
U-NII-3		√	30 dBm/500 kHz

4.5.2 Test Setup

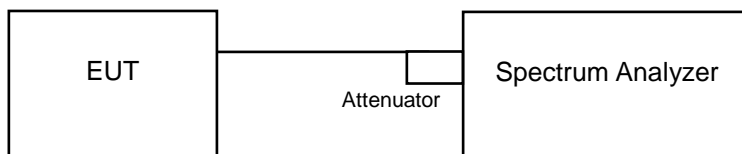

4.5.3 Test Instruments

Refer to section 4.1.3 to get information of above instrument.

4.5.4 Test Procedures

For U-NII-1, U-NII-2A, U-NII-2C band:

Using method SA-2

1. Set span to encompass the entire emission bandwidth (EBW) of the signal.
2. Set RBW = 1 MHz, Set VBW \geq 3 RBW, Detector = RMS
3. Sweep time = auto, trigger set to "free run".
4. Trace average at least 100 traces in power averaging mode.
5. Record the max value and add 10 log (1/duty cycle)

※For U-NII-3:

1. Set span to encompass the entire emission bandwidth (EBW) of the signal.
2. Set RBW = 300 kHz, Set VBW \geq 1 RBW, Detector = RMS
3. Use the peak marker function to determine the maximum power level in any 300 kHz band segment within the fundamental EBW.
4. Scale the observed power level to an equivalent value in 500 kHz by adjusting (reducing) the measured power by a bandwidth correction factor (BWCF) where $BWCF = 10\log(500 \text{ kHz} / 300 \text{ kHz})$.
5. Sweep time = auto, trigger set to "free run".
6. Trace average at least 100 traces in power averaging mode.
7. Record the max value and add 10 log (1/duty cycle)

4.5.5 Deviation from Test Standard

No deviation.

4.5.6 EUT Operating Conditions

The software provided by client to enable the EUT under transmission condition continuously at lowest, middle and highest channel frequencies individually.

4.5.7 Test Results

For U-NII-1, U-NII-2A, U-NII-2C Band

802.11a

Channel	Frequency (MHz)	PSD w/o Duty Factor (dBm/MHz)	Duty Factor (dB)	PSD with Duty Factor (dBm/MHz)	Maximum Limit (dBm/MHz)	Pass / Fail
36	5180	2.69	0.33	3.02	11	Pass
40	5200	2.42	0.33	2.75	11	Pass
48	5240	2.65	0.33	2.98	11	Pass
52	5260	2.47	0.33	2.80	11	Pass
60	5300	2.22	0.33	2.55	11	Pass
64	5320	2.09	0.33	2.42	11	Pass
100	5500	2.72	0.33	3.05	11	Pass
116	5580	2.95	0.33	3.28	11	Pass
140	5700	3.07	0.33	3.40	11	Pass

Note: Refer to section 3.3 for duty cycle spectrum plot.

802.11n (HT20)

Channel	Frequency (MHz)	PSD w/o Duty Factor (dBm/MHz)	Duty Factor (dB)	PSD with Duty Factor (dBm/MHz)	Maximum Limit (dBm/MHz)	Pass / Fail
36	5180	1.92	0.35	2.27	11	Pass
40	5200	1.60	0.35	1.95	11	Pass
48	5240	1.80	0.35	2.15	11	Pass
52	5260	1.62	0.35	1.97	11	Pass
60	5300	1.63	0.35	1.98	11	Pass
64	5320	1.57	0.35	1.92	11	Pass
100	5500	1.98	0.35	2.33	11	Pass
116	5580	1.87	0.35	2.22	11	Pass
140	5700	1.74	0.35	2.09	11	Pass

Note: Refer to section 3.3 for duty cycle spectrum plot.

802.11n (HT40)

Channel	Frequency (MHz)	PSD w/o Duty Factor (dBm/MHz)	Duty Factor (dB)	PSD with Duty Factor (dBm/MHz)	Maximum Limit (dBm/MHz)	Pass / Fail
38	5190	-3.44	0.45	-2.99	11	Pass
46	5230	-1.44	0.45	-0.99	11	Pass
54	5270	-1.57	0.45	-1.12	11	Pass
62	5310	-1.64	0.45	-1.19	11	Pass
102	5510	-1.14	0.45	-0.69	11	Pass
110	5550	-0.92	0.45	-0.47	11	Pass
134	5670	-1.03	0.45	-0.58	11	Pass

Note: Refer to section 3.3 for duty cycle spectrum plot.

802.11ac (VHT80)

Channel	Frequency (MHz)	PSD w/o Duty Factor (dBm/MHz)	Duty Factor (dB)	PSD with Duty Factor (dBm/MHz)	Maximum Limit (dBm/MHz)	Pass / Fail
42	5210	-3.99	0.15	-3.84	11	Pass
58	5290	-5.22	0.15	-5.07	11	Pass
106	5530	-3.80	0.15	-3.65	11	Pass
122	5610	-3.47	0.15	-3.32	11	Pass

Note: Refer to section 3.3 for duty cycle spectrum plot.

Spectrum Plot of Worst Value

802.11a

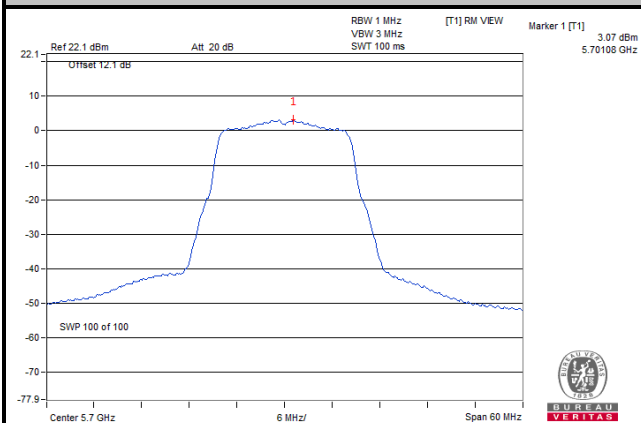

802.11n (HT20)

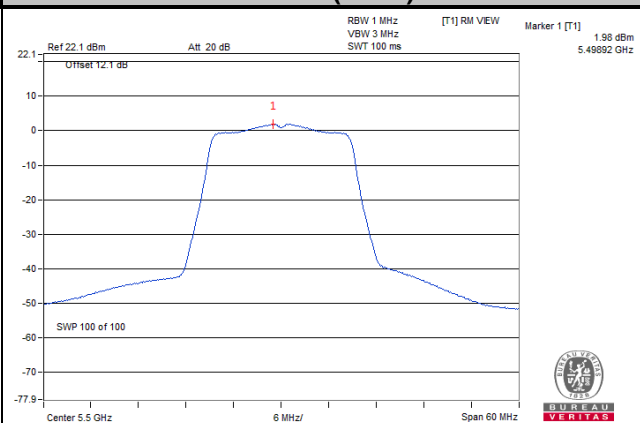

802.11n (HT40)

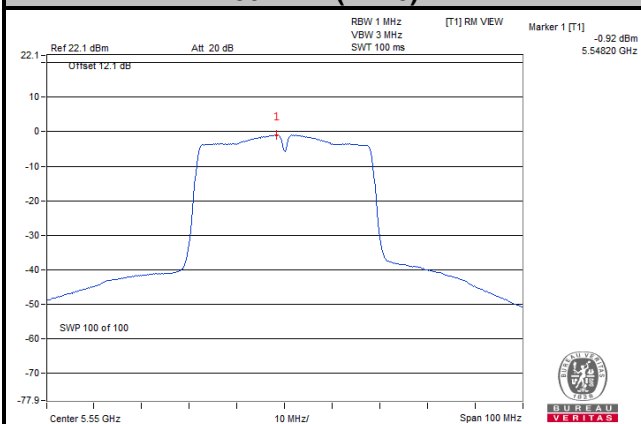

802.11ac (VHT80)

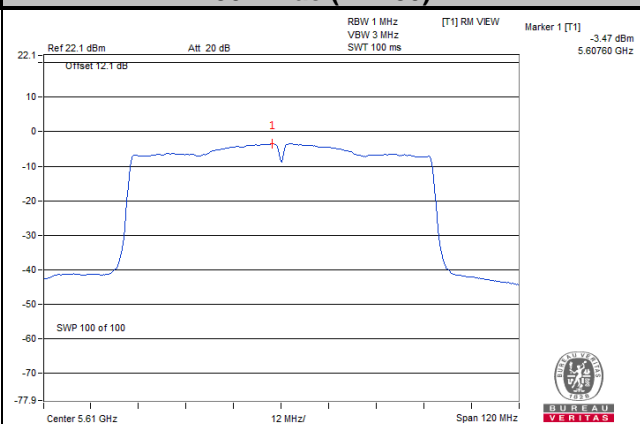

For U-NII-3 Band

802.11a

Channel	Frequency (MHz)	PSD w/o Duty Factor		Duty Factor (dB)	PSD with Duty Factor (dBm/500 kHz)	Limit (dBm/500 kHz)	Pass / Fail
		(dBm/300 kHz)	(dBm/500 kHz)				
149	5745	-1.76	0.46	0.33	0.79	30	Pass
157	5785	-1.72	0.50	0.33	0.83	30	Pass
165	5825	-2.49	-0.27	0.33	0.06	30	Pass

Note: Refer to section 3.3 for duty cycle spectrum plot.

802.11n (HT20)

Channel	Frequency (MHz)	PSD w/o Duty Factor		Duty Factor (dB)	PSD with Duty Factor (dBm/500 kHz)	Limit (dBm/500 kHz)	Pass / Fail
		(dBm/300 kHz)	(dBm/500 kHz)				
149	5745	-3.10	-0.88	0.35	-0.53	30	Pass
157	5785	-2.99	-0.77	0.35	-0.42	30	Pass
165	5825	-3.13	-0.91	0.35	-0.56	30	Pass

802.11n (HT40)

Channel	Frequency (MHz)	PSD w/o Duty Factor		Duty Factor (dB)	PSD with Duty Factor (dBm/500 kHz)	Limit (dBm/500 kHz)	Pass / Fail
		(dBm/300 kHz)	(dBm/500 kHz)				
151	5755	-6.01	-3.79	0.45	-3.34	30	Pass
159	5795	-5.84	-3.62	0.45	-3.17	30	Pass

Note: Refer to section 3.3 for duty cycle spectrum plot.

802.11ac (VHT80)

Channel	Frequency (MHz)	PSD w/o Duty Factor		Duty Factor (dB)	PSD with Duty Factor (dBm/500 kHz)	Limit (dBm/500 kHz)	Pass / Fail
		(dBm/300 kHz)	(dBm/500 kHz)				
155	5775	-8.80	-6.58	0.15	-6.43	30	Pass

Note: Refer to section 3.3 for duty cycle spectrum plot.

Spectrum Plot of Worst Value

802.11a

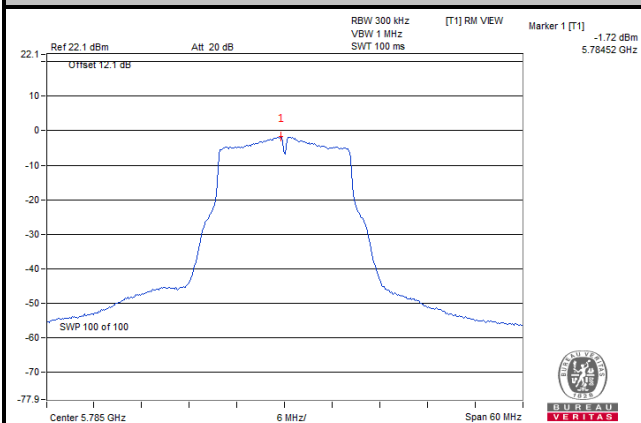

802.11n (HT20)

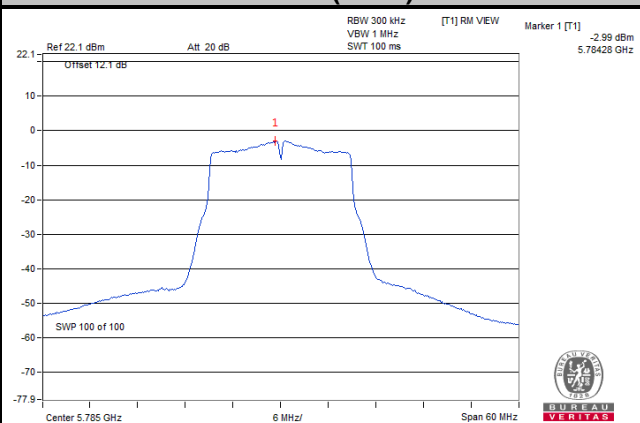

802.11n (HT40)

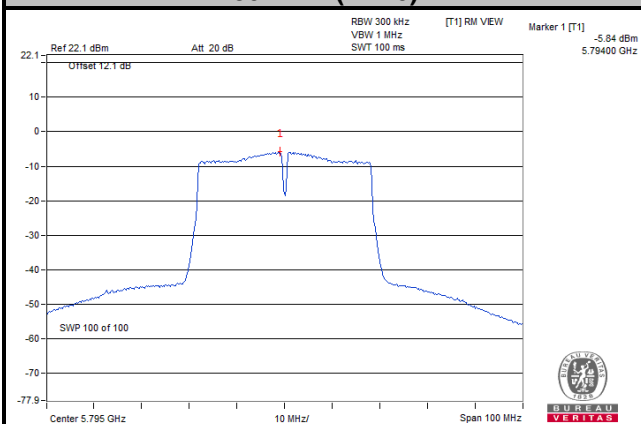

802.11ac (VHT80)

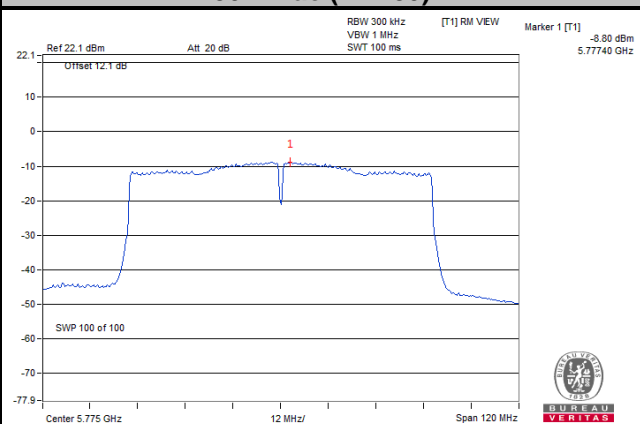

4.6 Frequency Stability

4.6.1 Limit of Frequency Stability Measurement

The frequency of the carrier signal shall be maintained within band of operation.

4.6.2 Test Setup

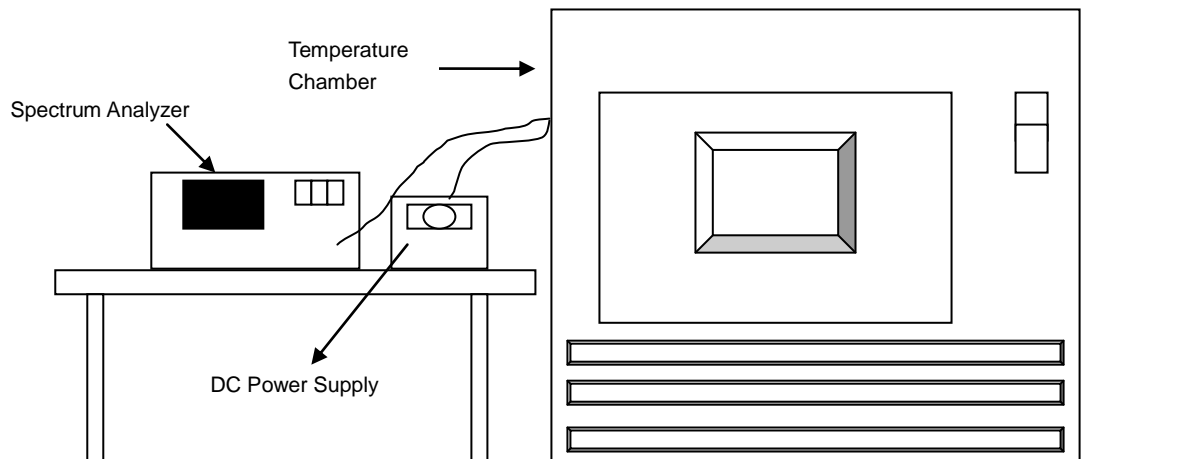

4.6.3 Test Instruments

Refer to section 4.1.3 to get information of above instrument.

4.6.4 Test Procedure

- The EUT was placed inside the environmental test chamber and powered by nominal DC voltage.
- Turn the EUT on and couple its output to a spectrum analyzer.
- Turn the EUT off and set the chamber to the highest temperature specified.
- Allow sufficient time (approximately 30 min) for the temperature of the chamber to stabilize, turn the EUT on and measure the operating frequency after 2, 5, and 10 Minutes.
- Repeat step c and d with every 10 degrees reduction until the lowest temperature achieved.
- The test chamber was allowed to stabilize at +20 degree C for a minimum of 30 Minutes. The supply voltage was then adjusted on the EUT from 85% to 115% and the frequency record.

4.6.5 Deviation from Test Standard

No deviation.

4.6.6 EUT Operating Condition

Set the EUT transmit at un-modulation mode to test frequency stability.

4.6.7 Test Results

Frequency Stability Versus Temp.									
Operating Frequency: 5180 MHz									
Temp. (°C)	Power Supply (Vdc)	0 Minute		2 Minute		5 Minute		10 Minute	
		Measured Frequency (MHz)	Result	Measured Frequency (MHz)	Result	Measured Frequency (MHz)	Result	Measured Frequency (MHz)	Result
50	3.8	5179.9893	PASS	5179.9911	PASS	5179.9899	PASS	5179.99	PASS
40	3.8	5179.9915	PASS	5179.9876	PASS	5179.9913	PASS	5179.988	PASS
30	3.8	5180.0224	PASS	5180.0236	PASS	5180.0237	PASS	5180.0237	PASS
20	3.8	5180.0214	PASS	5180.0224	PASS	5180.0253	PASS	5180.0218	PASS
10	3.8	5180.0148	PASS	5180.0101	PASS	5180.0105	PASS	5180.0128	PASS
0	3.8	5179.9821	PASS	5179.9789	PASS	5179.9776	PASS	5179.9778	PASS

Frequency Stability Versus Voltage									
Operating Frequency: 5180 MHz									
Temp. (°C)	Power Supply (Vdc)	0 Minute		2 Minute		5 Minute		10 Minute	
		Measured Frequency (MHz)	Result	Measured Frequency (MHz)	Result	Measured Frequency (MHz)	Result	Measured Frequency (MHz)	Result
20	4.2	5180.0213	PASS	5180.0234	PASS	5180.0257	PASS	5180.0219	PASS
	3.8	5180.0214	PASS	5180.0224	PASS	5180.0253	PASS	5180.0218	PASS
	3.3	5180.0204	PASS	5180.0233	PASS	5180.0256	PASS	5180.0211	PASS

4.7 6 dB Bandwidth Measurement

4.7.1 Limits of 6 dB Bandwidth Measurement

The minimum of 6 dB Bandwidth Measurement is 0.5 MHz.

4.7.2 Test Setup

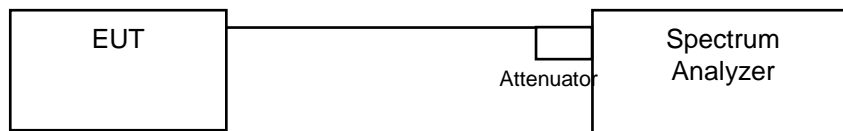

4.7.3 Test Instruments

Refer to section 4.1.3 to get information of above instrument.

4.7.4 Test Procedure

MEASUREMENT PROCEDURE REF

- Set resolution bandwidth (RBW) = 100 kHz
- Set the video bandwidth (VBW) $\geq 3 \times$ RBW, Detector = Peak.
- Trace mode = max hold.
- Sweep = auto couple.
- Measure the maximum width of the emission that is constrained by the frequencies associated with the two amplitude points (upper and lower) that are attenuated by 6 dB relative to the maximum level measured in the fundamental emission

4.7.5 Deviation from Test Standard

No deviation.

4.7.6 EUT Operating Condition

The software provided by client to enable the EUT under transmission condition continuously at lowest, middle and highest channel frequencies individually.

4.7.7 Test Results

802.11a

Channel	Frequency (MHz)	6 dB Bandwidth (MHz)	Minimum Limit (MHz)	Pass / Fail
149	5745	16.34	0.5	Pass
157	5785	16.33	0.5	Pass
165	5825	16.34	0.5	Pass

802.11n (HT20)

Channel	Frequency (MHz)	6 dB Bandwidth (MHz)	Minimum Limit (MHz)	Pass / Fail
149	5745	17.06	0.5	Pass
157	5785	17.07	0.5	Pass
165	5825	17.29	0.5	Pass

802.11n (HT40)

Channel	Frequency (MHz)	6 dB Bandwidth (MHz)	Minimum Limit (MHz)	Pass / Fail
151	5755	36.06	0.5	Pass
159	5795	35.90	0.5	Pass

802.11ac (VHT80)

Channel	Frequency (MHz)	6 dB Bandwidth (MHz)	Minimum Limit (MHz)	Pass / Fail
155	5775	75.38	0.5	Pass

Spectrum Plot of Worst Value

802.11a

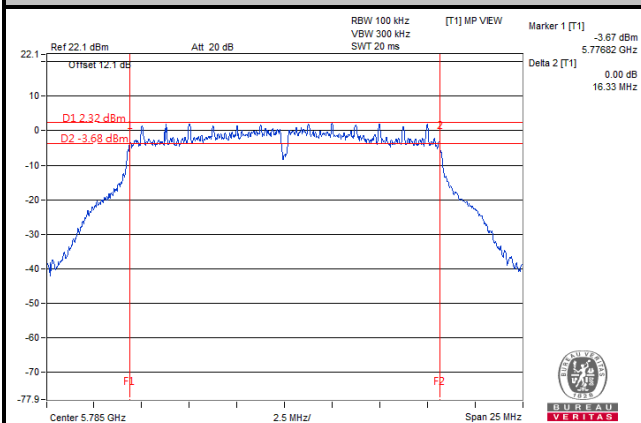

802.11n (HT20)

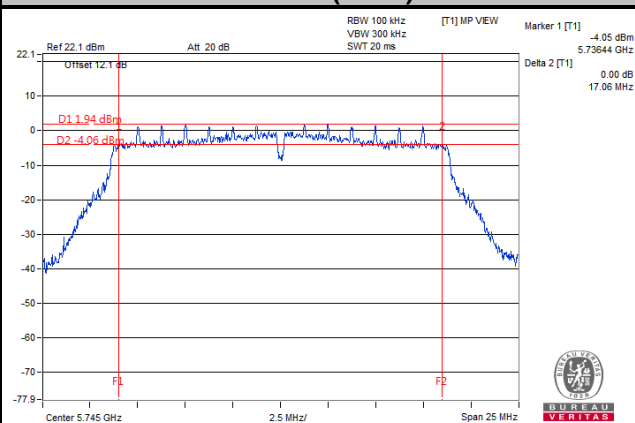

802.11n (HT40)

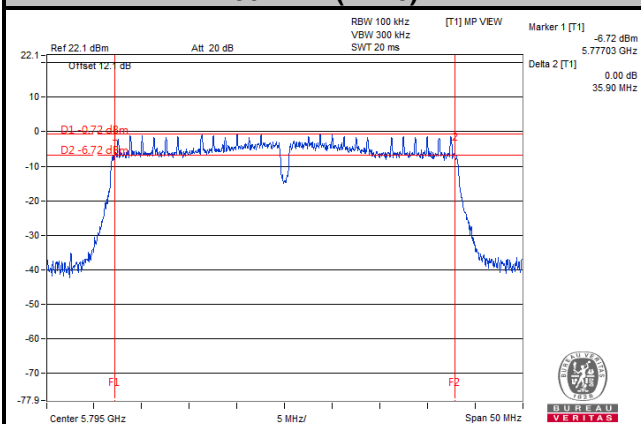

802.11ac (VHT80)

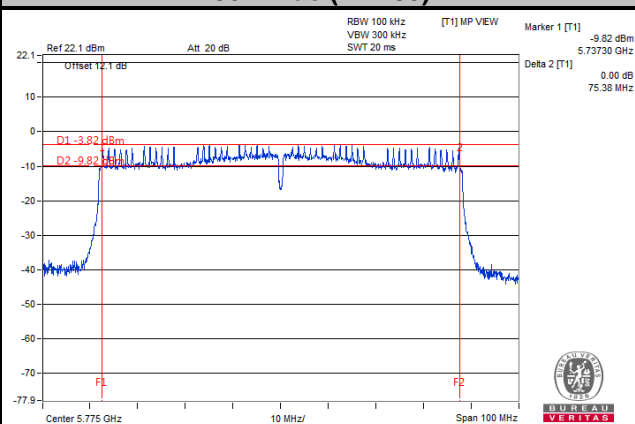

5 Pictures of Test Arrangements

Please refer to the attached file (Test Setup Photo).

Annex A- Radiated Out of Band Emission (OOBE) Measurement (For U-NII-3 band)

802.11a

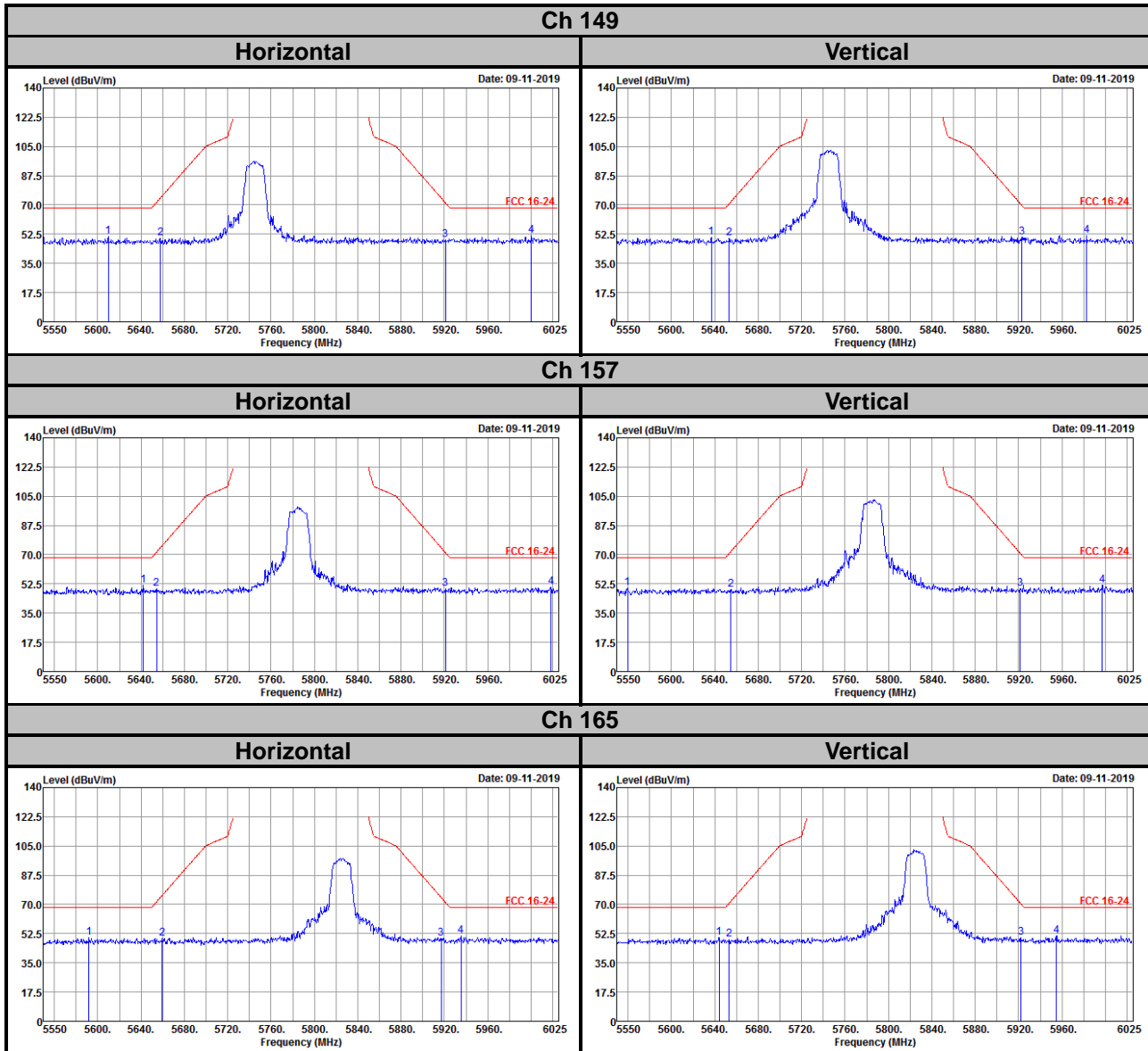

802.11n (HT20)

Ch 149

Horizontal

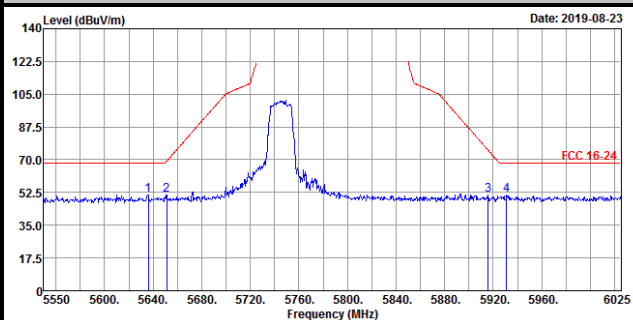

Vertical

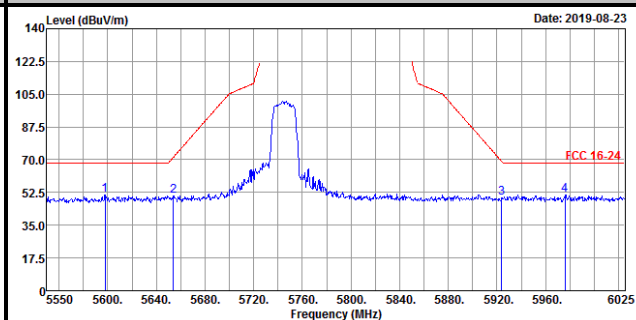

Ch 157

Horizontal

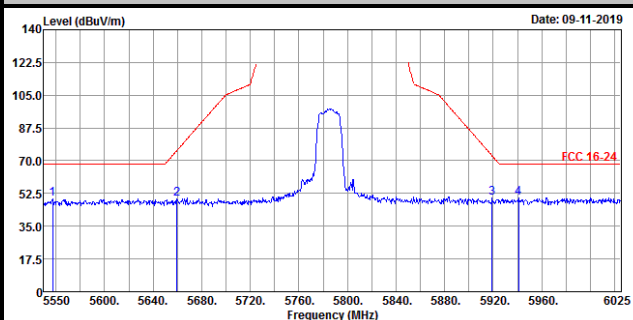

Vertical

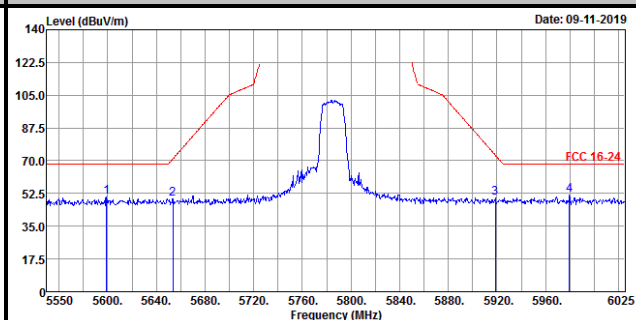

Ch 165

Horizontal

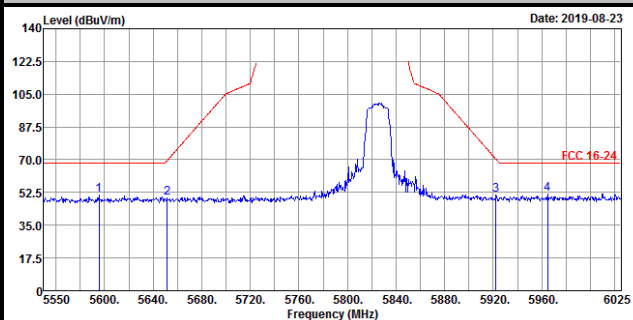

Vertical

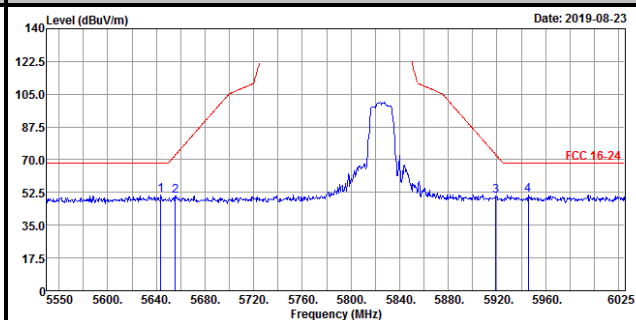

802.11n (HT40)

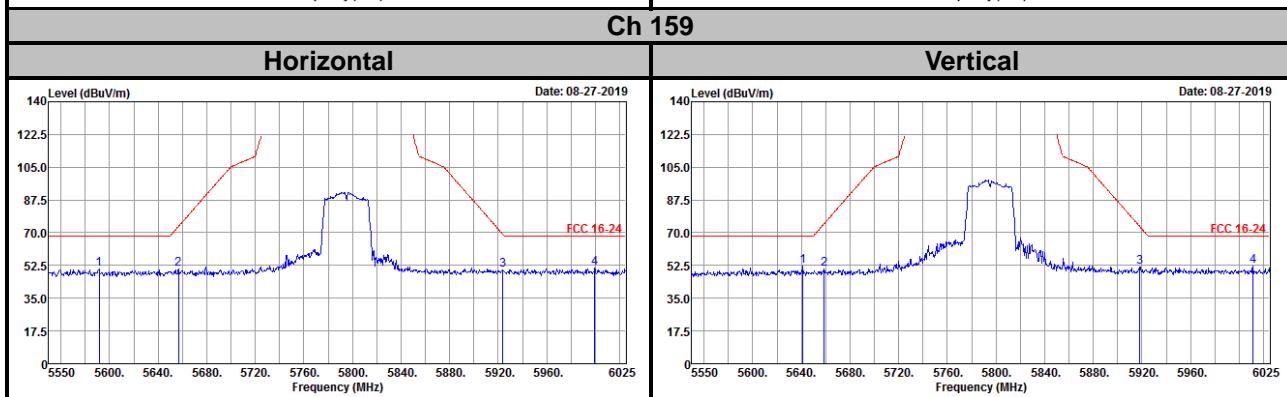
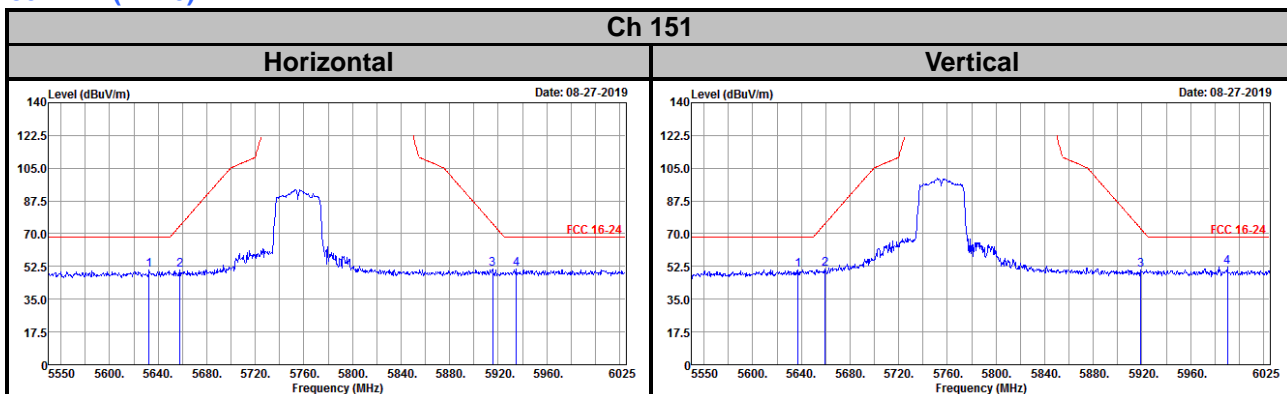

802.11ac (VHT80)

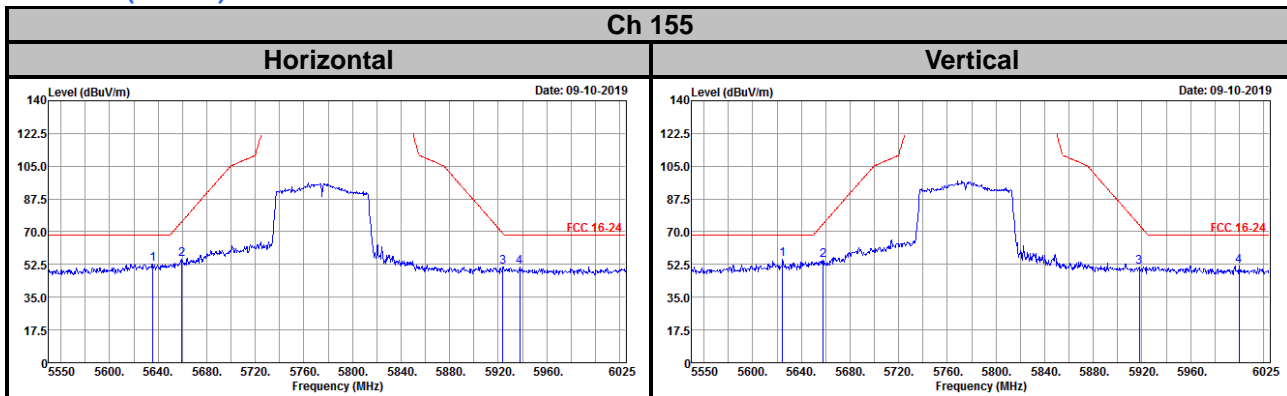

Appendix – Information of the Testing Laboratories

We, Bureau Veritas Consumer Products Services (H.K.) Ltd., Taoyuan Branch, were founded in 1988 to provide our best service in EMC, Radio, Telecom and Safety consultation. Our laboratories are FCC recognized accredited test firms and accredited according to ISO/IEC 17025.

If you have any comments, please feel free to contact us at the following:

Lin Kou EMC/RF Lab

Tel: 886-2-26052180

Fax: 886-2-26051924

Hsin Chu EMC/RF/Telecom Lab

Tel: 886-3-6668565

Fax: 886-3-6668323

Hwa Ya EMC/RF/Safety Lab

Tel: 886-3-3183232

Fax: 886-3-3270892

Email: service.adt@tw.bureauveritas.com

Web Site: www.bureauveritas-adt.com

The address and road map of all our labs can be found in our web site also.

--- END ---