

FCC Test Report

(Part 24 – GPRS, EDGE, WCDMA, LTE Band 2 / 25)

Report No.: RFBFMG-WTW-P22010752-1

FCC ID: B32E2351

Test Model: e235-4G-1

Received Date: Jan. 24, 2022

Test Date: Mar. 20 ~ Mar. 25, 2022

Issued Date: Jul. 22, 2022

Applicant: Verifone, Inc.

Address: 1400 West Stanford Ranch Road Suite 150 Rocklin CA 95765 USA

Issued By: Bureau Veritas Consumer Products Services (H.K.) Ltd., Taoyuan Branch
Lin Kou Laboratories

Lab Address: No. 47-2, 14th Ling, Chia Pau Vil., Lin Kou Dist., New Taipei City, Taiwan

Test Location(1): No. 19, Hwa Ya 2nd Rd., Wen Hwa Vil., Kwei Shan Dist., Taoyuan City
33383, Taiwan

**FCC Registration /
Designation Number(1):** 788550 / TW0003

Test Location(2): B2F., No.215, Sec. 3, Beixin Rd., Xindian Dist., New Taipei City 231, Taiwan

**FCC Registration /
Designation Number(2):** 427177 / TW0011



This report is governed by, and incorporates by reference, the Conditions of Testing as posted at the date of issuance of this report at <http://www.bureauveritas.com/home/about-us/our-business/cps/about-us/terms-conditions/> and is intended for your exclusive use. Any copying or replication of this report to or for any other person or entity, or use of our name or trademark, is permitted only with our prior written permission. This report sets forth our findings solely with respect to the test samples identified herein. The results set forth in this report are not indicative or representative of the quality or characteristics of the lot from which a test sample was taken or any similar or identical product unless specifically and expressly noted. Our report includes all of the tests requested by you and the results thereof based upon the information that you provided to us. Measurement uncertainty is only provided upon request for accredited tests. Statements of conformity are based on simple acceptance criteria without taking measurement uncertainty into account, unless otherwise requested in writing. You have 60 days from date of issuance of this report to notify us of any material error or omission caused by our negligence or if you require measurement uncertainty; provided, however, that such notice shall be in writing and shall specifically address the issue you wish to raise. A failure to raise such issue within the prescribed time shall constitute your unqualified acceptance of the completeness of this report, the tests conducted and the correctness of the report contents.

Table of Contents

Release Control Record	4
1 Certificate of Conformity	5
2 Summary of Test Results	6
2.1 Measurement Uncertainty.....	6
2.2 Test Site and Instruments.....	7
3 General Information	8
3.1 General Description of EUT.....	8
3.2 Configuration of System under Test.....	10
3.2.1 Description of Support Units.....	10
3.3 Test Mode Applicability and Tested Channel Detail.....	11
3.4 EUT Operating Conditions.....	19
3.5 General Description of Applied Standards and References.....	19
4 Test Types and Results	20
4.1 Output Power Measurement.....	20
4.1.1 Limits of Output Power Measurement.....	20
4.1.2 Test Procedures.....	20
4.1.3 Test Setup.....	20
4.1.4 Test Results.....	21
4.2 Modulation Characteristics Measurement.....	35
4.2.1 Limits of Modulation Characteristics.....	35
4.2.2 Test Procedure.....	35
4.2.3 Test Setup.....	35
4.2.4 Test Results.....	36
4.3 Frequency Stability Measurement.....	38
4.3.1 Limits of Frequency Stability Measurement.....	38
4.3.2 Test Procedure.....	38
4.3.3 Conducted Setup.....	38
4.3.4 Test Results.....	39
4.4 Occupied Bandwidth Measurement.....	54
4.4.1 Limits of Occupied Bandwidth Measurement.....	54
4.4.2 Test Procedure.....	54
4.4.3 Test Setup.....	54
4.4.4 Test Result.....	55
4.5 Band Edge Measurement.....	69
4.5.1 Limits of Band Edge Measurement.....	69
4.5.2 Test Setup.....	69
4.5.3 Test Procedures.....	69
4.5.4 Test Results.....	70
4.6 Peak to Average Ratio.....	84
4.6.1 Limits of Peak to Average Ratio Measurement.....	84
4.6.2 Test Setup.....	84
4.6.3 Test Procedures.....	84
4.6.4 Test Results.....	85
4.7 Conducted Spurious Emissions.....	99
4.7.1 Limits of Conducted Spurious Emissions Measurement.....	99
4.7.2 Test Setup.....	99
4.7.3 Test Procedure.....	99
4.7.4 Test Results.....	100
4.8 Radiated Emission Measurement.....	120
4.8.1 Limits of Radiated Emission Measurement.....	120
4.8.2 Test Procedure.....	120
4.8.3 Deviation from Test Standard.....	120
4.8.4 Test Setup.....	121

4.8.5 Test Results	122
5 Pictures of Test Arrangements.....	158
Appendix – Information of the Testing Laboratories	159

Release Control Record

Issue No.	Description	Date Issued
RFBFMG-WTW-P22010752-1	Original release	Jul. 22, 2022

1 Certificate of Conformity

Product: Point of Sale Terminal

Brand: Verifone

Test Model: e235-4G-1

Sample Status: Engineering sample

Applicant: Verifone, Inc.

Test Date: Mar. 20 ~ Mar. 25, 2022

Standards: FCC Part 24, Subpart E

The above equipment has been tested by **Bureau Veritas Consumer Products Services (H.K.) Ltd., Taoyuan Branch**, and found compliance with the requirement of the above standards. The test record, data evaluation & Equipment Under Test (EUT) configurations represented herein are true and accurate accounts of the measurements of the sample's RF characteristics under the conditions specified in this report.

Prepared by : Pettie Chen, **Date:** Jul. 22, 2022
Pettie Chen / Senior Specialist

Approved by : Jeremy Lin, **Date:** Jul. 22, 2022
Jeremy Lin / Project Engineer

2 Summary of Test Results

Applied Standard: FCC Part 24 & Part 2			
FCC Clause	Test Item	Result	Remarks
2.1046 24.232	Equivalent Isotropically Radiated Power	Pass	Meet the requirement of limit.
2.1046 24.232 (d)	Peak To Average Ratio	Pass	Meet the requirement of limit.
2.1047	Modulation Characteristics	Pass	Meet the requirement
2.1055 24.235	Frequency Stability	Pass	Meet the requirement of limit.
2.1049	Occupied Bandwidth	Pass	Meet the requirement of limit.
24.238	Band Edge Measurements	Pass	Meet the requirement of limit.
2.1051 24.238	Conducted Spurious Emissions	Pass	Meet the requirement of limit.
2.1053 24.238	Radiated Spurious Emissions	Pass	Meet the requirement of limit. Minimum passing margin is -18.47dB at 7600.0MHz.

Note: Determining compliance based on the results of the compliance measurement, not taking into account measurement instrumentation uncertainty.

2.1 Measurement Uncertainty

Where relevant, the following measurement uncertainty levels have been estimated for tests performed on the EUT as specified in CISPR 16-4-2:

Measurement	Frequency	Expanded Uncertainty (k=2) (\pm)
Radiated Emissions up to 1 GHz	9kHz ~ 30MHz	3.04 dB
	30MHz ~ 200MHz	2.0153 dB
	200MHz ~ 1000MHz	2.0224 dB
Radiated Emissions above 1 GHz	1GHz ~ 18GHz	1.0121 dB
	18GHz ~ 40GHz	1.1508 dB

2.2 Test Site and Instruments

Description & Manufacturer	Model No.	Serial No.	Cal. Date	Cal. Due
Test Receiver Agilent Technologies	N9038A	MY52260177	Sep. 01, 2021	Aug. 31, 2022
Spectrum Analyzer ROHDE & SCHWARZ	FSU43	101261	Apr. 12, 2021	Apr. 11, 2022
Loop Antenna TESEQ	HLA 6121	45745	Jul. 21, 2021	Jul. 20, 2022
HORN Antenna ETS-Lindgren	3117	00143293	Nov. 14, 2021	Nov. 13, 2022
BILOG Antenna SCHWARZBECK	VULB 9168	9168-616	Oct. 27, 2021	Oct. 26, 2022
HORN Antenna SCHWARZBECK	BBHA 9170	9170-480	Nov. 14, 2021	Nov. 13, 2022
Fixed Attenuator Mini-Circuits	MDCS18N-10	MDCS18N-10-01	Apr. 13, 2021	Apr. 12, 2022
MXG Vector signal generator Agilent	N5182B	MY53050430	Nov. 25, 2021	Nov. 24, 2022
Preamplifier Agilent	310N	187226	Jun. 17, 2021	Jun. 16, 2022
Preamplifier Agilent	83017A	MY39501357	Jun. 17, 2021	Jun. 16, 2022
Preamplifier EMCI	EMC 184045	980116	Oct. 05, 2021	Oct. 04, 2022
RF signal cable ETS-LINDGREN	5D-FB	Cable-CH1-01(RFC-SMS-100-SMS-120+RFC-SMS-100-SMS-400)	Jun. 17, 2021	Jun. 16, 2022
RF signal cable ETS-LINDGREN	8D-FB	Cable-CH1-02(RFC-SMS-100-SMS-24)	Jun. 17, 2021	Jun. 16, 2022
Boresight Antenna Fixture	FBA-01	FBA-SIP01	NA	NA
Software BV ADT	ADT_Radiated_V7.6.1 5.9.5	NA	NA	NA
Antenna Tower MF	NA	NA	NA	NA
Turn Table MF	NA	NA	NA	NA
Antenna Tower & Turn Table Controller MF	MF-7802	NA	NA	NA
DC power supply KEYSIGHT	U8002A	MY56330015	NA	NA
Digital Multimeter Fluke	87-III	70360755	Jul. 08, 2021	Jul. 07, 2022
Radio Communication Analyzer Anritsu	MT8820C	6201300640	Aug. 26, 2021	Aug. 25, 2022
Radio Communication Analyzer Anritsu	MT8821C	6201462755	Mar. 03, 2022	Mar. 02, 2023
Temperature & Humidity Chamber TERCHY	HRM-120RF	931022	Jan. 03, 2022	Jan. 02, 2023
Spectrum Analyzer KEYSIGHT	N9030B	MY57140953	Jul. 06, 2021	Jul. 05, 2022

Note: 1. The calibration interval of the above test instruments is 12 months and the calibrations are traceable to NML/ROC and NIST/USA.
2. The test was performed in Xindian Chamber 6.

3 General Information

3.1 General Description of EUT

Product	Point of Sale Terminal	
Brand	Verifone	
Test Model	e235-4G-1	
Sample Status	Engineering sample	
Power Supply Rating	5Vdc (From adapter)	
Modulation Type	GPRS: GMSK EDGE: 8PSK WCDMA: BPSK, QPSK HSDPA: BPSK HSUPA: QPSK LTE: QPSK, 16QAM	
Operating Frequency	GPRS, EDGE	1850.2MHz ~ 1909.8MHz
	WCDMA Band 2	1852.4MHz ~ 1907.6MHz
	LTE Band 2 (Channel Bandwidth 1.4MHz)	1850.7MHz ~ 1909.3MHz
	LTE Band 2 (Channel Bandwidth 3MHz)	1851.5MHz ~ 1908.5MHz
	LTE Band 2 (Channel Bandwidth 5MHz)	1852.5MHz ~ 1907.5MHz
	LTE Band 2 (Channel Bandwidth 10MHz)	1855.0MHz ~ 1905.0MHz
	LTE Band 2 (Channel Bandwidth 15MHz)	1857.5MHz ~ 1902.5MHz
	LTE Band 2 (Channel Bandwidth 20MHz)	1860.0MHz ~ 1900.0MHz
	LTE Band 25 (Channel Bandwidth 1.4MHz)	1850.7MHz ~ 1914.3MHz
	LTE Band 25 (Channel Bandwidth 3MHz)	1851.5MHz ~ 1913.5MHz
	LTE Band 25 (Channel Bandwidth 5MHz)	1852.5MHz ~ 1912.5MHz
	LTE Band 25 (Channel Bandwidth 10MHz)	1855.0MHz ~ 1910.0MHz
	LTE Band 25 (Channel Bandwidth 15MHz)	1857.5MHz ~ 1907.5MHz
	LTE Band 25 (Channel Bandwidth 20MHz)	1860.0MHz ~ 1905.0MHz

Max. EIRP Power	GPRS	916.220mW (29.62dBm)	
	EDGE	772.681mW (28.88dBm)	
	WCDMA Band 2	370.681mW (25.69dBm)	
		QPSK	16QAM
	LTE Band 2 (Channel Bandwidth 1.4MHz)	301.301mW (24.79dBm)	258.821mW (24.13dBm)
	LTE Band 2 (Channel Bandwidth 3MHz)	304.089mW (24.83dBm)	254.097mW (24.05dBm)
	LTE Band 2 (Channel Bandwidth 5MHz)	306.902mW (24.87dBm)	255.270mW (24.07dBm)
	LTE Band 2 (Channel Bandwidth 10MHz)	312.608mW (24.95dBm)	260.615mW (24.16dBm)
	LTE Band 2 (Channel Bandwidth 15MHz)	312.608mW (24.95dBm)	258.821mW (24.13dBm)
	LTE Band 2 (Channel Bandwidth 20MHz)	318.420mW (25.03dBm)	260.016mW (24.15dBm)
	LTE Band 25 (Channel Bandwidth 1.4MHz)	365.595mW (25.63dBm)	284.446mW (24.54dBm)
	LTE Band 25 (Channel Bandwidth 3MHz)	366.438mW (25.64dBm)	289.734mW (24.62dBm)
	LTE Band 25 (Channel Bandwidth 5MHz)	364.754mW (25.62dBm)	291.072mW (24.64dBm)
	LTE Band 25 (Channel Bandwidth 10MHz)	359.749mW (25.56dBm)	287.078mW (24.58dBm)
	LTE Band 25 (Channel Bandwidth 15MHz)	361.410mW (25.58dBm)	285.759mW (24.56dBm)
	LTE Band 25 (Channel Bandwidth 20MHz)	367.282mW (25.65dBm)	291.072mW (24.64dBm)
Emission Designator	GPRS	248KGXW	
	EDGE	249KG7W	
	WCDMA Band 2	4M14F9W	
		QPSK	16QAM
	LTE Band 2 (Channel Bandwidth 1.4MHz)	1M09G7D	1M09D7W
	LTE Band 2 (Channel Bandwidth 3MHz)	2M70G7D	2M70D7W
	LTE Band 2 (Channel Bandwidth 5MHz)	4M50G7D	4M49D7W
	LTE Band 2 (Channel Bandwidth 10MHz)	8M95G7D	4M57D7W
	LTE Band 2 (Channel Bandwidth 15MHz)	13M4G7D	4M67D7W
	LTE Band 2 (Channel Bandwidth 20MHz)	17M9G7D	4M82D7W
	LTE Band 25 (Channel Bandwidth 1.4MHz)	1M09G7D	1M09D7W
	LTE Band 25 (Channel Bandwidth 3MHz)	2M70G7D	2M70D7W
	LTE Band 25 (Channel Bandwidth 5MHz)	4M49G7D	4M49D7W
	LTE Band 25 (Channel Bandwidth 10MHz)	8M95G7D	4M56D7W
LTE Band 25 (Channel Bandwidth 15MHz)	13M4G7D	4M67D7W	
LTE Band 25 (Channel Bandwidth 20MHz)	17M9G7D	4M81D7W	
Antenna Type	Refer to note		
Accessory Device	NA		
Cable Supplied	0.93m non-shielded USB cable		

Note:

1. The antenna information is listed as below.

Type	Gain (dBi)														
	GSM 850	GSM 1900	WCDMA B2	WCDMA B4	WCDMA B5	LTE B2	LTE B4	LTE B5	LTE B7	LTE B12	LTE B13	LTE B25	LTE B26	LTE B38	LTE B41
monopole	1.1	2.2	2.2	2.0	1.1	2.2	2.0	1.1	2.5	-0.5	0.6	2.2	1.1	2.7	3.3

* The above Antenna information refers to the manufacturer's antenna specifications, the laboratory shall not be held responsible.

2. EUT WWAN equipment specification, 16QAM modulation with bandwidth exceeding 10MHz only supports 25RB.

3.2 Configuration of System under Test

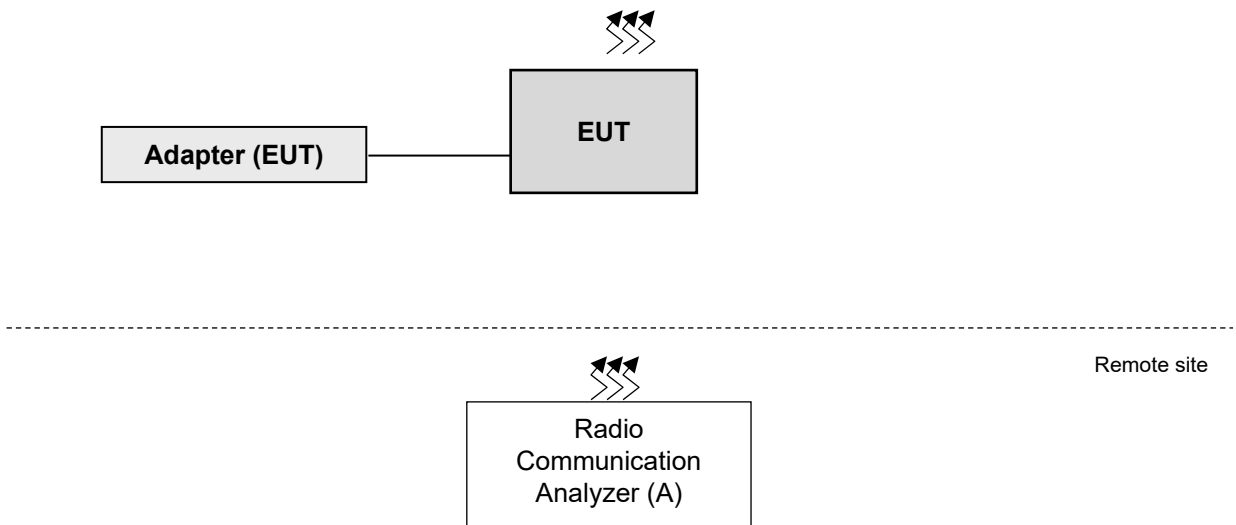

3.2.1 Description of Support Units

The EUT has been tested as an independent unit together with other necessary accessories or support units. The following support units or accessories were used to form a representative test configuration during the tests.

ID	Product	Brand	Model No.	Serial No.	FCC ID	Remarks
A.	Radio Communication Analyzer	Anritsu	MT8820C	6201240432	NA	For LTE
		R&S	CMU200	101095	NA	For GPRS, EDGE, WCDMA

Note:

1. All power cords of the above support units are non-shielded (1.8m).
2. Item A acted as a communication partner to transfer data.

3.3 Test Mode Applicability and Tested Channel Detail

Pre-Scan has been conducted to determine the worst-case mode from all possible combinations between available modulations, data rates, XYZ axis and antenna ports. The worst case was found when positioned as the table below. Following channel(s) was (were) selected for the final test as listed below:

Band	Radiated Emission
GPRS, EDGE	Z-plane
WCDMA Band 2	Z-plane
LTE Band 2	Z-plane
LTE Band 25	Z-plane

GPRS, EDGE Mode

EUT Configure Mode	Test Item	Available Channel	Tested Channel	Modulation
-	EIRP	512 to 810	512 (1850.2MHz), 661 (1880.0MHz), 810 (1909.8MHz)	GPRS, EDGE
-	Modulation Characteristics	512 to 810	661 (1880.0MHz)	GPRS, EDGE
-	Frequency Stability	512 to 810	512 (1850.2MHz), 810 (1909.8MHz)	GPRS, EDGE
-	Occupied Bandwidth	512 to 810	512 (1850.2MHz), 661 (1880.0MHz), 810 (1909.8MHz)	GPRS, EDGE
-	Band Edge	512 to 810	512(1850.2MHz), 810(1909.8MHz)	GPRS, EDGE
-	Peak To Average Ratio	512 to 810	512 (1850.2MHz), 661 (1880.0MHz), 810 (1909.8MHz)	GPRS, EDGE
-	Conducted Emission	512 to 810	512 (1850.2MHz), 661 (1880.0MHz), 810 (1909.8MHz)	GPRS, EDGE
-	Radiated Emission Below 1GHz	512 to 810	512 (1850.2MHz)	GPRS
-			810 (1909.8MHz)	EDGE
-	Radiated Emission Above 1GHz	512 to 810	512 (1850.2MHz), 661 (1880.0MHz), 810 (1909.8MHz)	GPRS, EDGE

Note: For radiated emission below 1GHz, select the worst radiated emission channel (above 1GHz) for final testing.

WCDMA Band 2

EUT Configure Mode	Test Item	Available Channel	Tested Channel	Mode
-	EIRP	9262 to 9538	9262 (1852.4MHz), 9400 (1880.0MHz), 9538 (1907.6MHz)	WCDMA, HSDPA, HSUPA
-	Modulation Characteristics	9262 to 9538	9400 (1880.0MHz)	WCDMA, HSDPA, HSUPA
-	Frequency Stability	9262 to 9538	9262 (1852.4MHz), 9538 (1907.6MHz)	WCDMA
-	Occupied Bandwidth	9262 to 9538	9262 (1852.4MHz), 9400 (1880.0MHz), 9538 (1907.6MHz)	WCDMA, HSDPA, HSUPA
-	Band Edge	9262 to 9538	9262 (1852.4MHz), 9538 (1907.6MHz)	WCDMA, HSDPA, HSUPA
-	Peak To Average Ratio	9262 to 9538	9262 (1852.4MHz), 9400 (1880.0MHz), 9538 (1907.6MHz)	WCDMA, HSDPA, HSUPA
-	Conducted Emission	9262 to 9538	9262 (1852.4MHz), 9400 (1880.0MHz), 9538 (1907.6MHz)	WCDMA, HSDPA, HSUPA
-	Radiated Emission Below 1GHz	9262 to 9538	9538 (1907.6MHz)	WCDMA
-	Radiated Emission Above 1GHz	9262 to 9538	9262 (1852.4MHz), 9400 (1880.0MHz), 9538 (1907.6MHz)	WCDMA

Note: For radiated emission below 1GHz, select the worst radiated emission channel (above 1GHz) for final testing.

LTE Band 2

EUT Configure Mode	Test item	Available channel	Tested Channel	Channel Bandwidth	Modulation	RB #
-	EIRP	18607 to 19193	18607 (1850.7MHz), 18900 (1880.0MHz), 19193 (1909.3MHz)	1.4MHz	QPSK / 16QAM	1 Half Full
		18615 to 19185	18615 (1851.5MHz), 18900 (1880.0MHz), 19185 (1908.5MHz)	3MHz	QPSK / 16QAM	1 Half Full
		18625 to 19175	18625 (1852.5MHz), 18900 (1880.0MHz), 19175 (1907.5MHz)	5MHz	QPSK / 16QAM	1 Half Full
		18650 to 19150	18650 (1855.0MHz), 18900 (1880.0MHz), 19150 (1905.0MHz)	10MHz	QPSK / 16QAM	1 Half Full
		18675 to 19125	18675 (1857.5MHz), 18900 (1880.0MHz), 19125 (1902.5MHz)	15MHz	QPSK / 16QAM	1 Half Full
		18700 to 19100	18700 (1860.0MHz), 18900 (1880.0MHz), 19100 (1900.0MHz)	20MHz	QPSK / 16QAM	1 Half Full
-	Modulation Characteristics	18700 to 19100	18900 (1880.0MHz)	20MHz	QPSK / 16QAM	Full
-	Frequency Stability	18607 to 19193	18607 (1850.7MHz), 19193 (1909.3MHz)	1.4MHz	QPSK	Full
		18615 to 19185	18615 (1851.5MHz), 19185 (1908.5MHz)	3MHz	QPSK	Full
		18625 to 19175	18625 (1852.5MHz), 19175 (1907.5MHz)	5MHz	QPSK	Full
		18650 to 19150	18650 (1855.0MHz), 19150 (1905.0MHz)	10MHz	QPSK	Full
		18675 to 19125	18675 (1857.5MHz), 19125 (1902.5MHz)	15MHz	QPSK	Full
		18700 to 19100	18700 (1860.0MHz), 19100 (1900.0MHz)	20MHz	QPSK	Full
-	Occupied Bandwidth	18607 to 19193	18607 (1850.7MHz), 18900 (1880.0MHz), 19193 (1909.3MHz)	1.4MHz	QPSK / 16QAM	Full
		18615 to 19185	18615 (1851.5MHz), 18900 (1880.0MHz), 19185 (1908.5MHz)	3MHz	QPSK / 16QAM	Full
		18625 to 19175	18625 (1852.5MHz), 18900 (1880.0MHz), 19175 (1907.5MHz)	5MHz	QPSK / 16QAM	Full
		18650 to 19150	18650 (1855.0MHz), 18900 (1880.0MHz), 19150 (1905.0MHz)	10MHz	QPSK / 16QAM	Full
		18675 to 19125	18675 (1857.5MHz), 18900 (1880.0MHz), 19125 (1902.5MHz)	15MHz	QPSK / 16QAM	Full
		18700 to 19100	18700 (1860.0MHz), 18900 (1880.0MHz), 19100 (1900.0MHz)	20MHz	QPSK / 16QAM	Full

EUT Configure Mode	Test item	Available channel	Tested Channel	Channel Bandwidth	Modulation	RB #
-	Band Edge	18607 to 19193	18607 (1850.7MHz), 19193 (1909.3MHz)	1.4MHz	QPSK	1 Half Full
		18615 to 19185	18615 (1851.5MHz), 19185 (1908.5MHz)	3MHz	QPSK	1 Half Full
		18625 to 19175	18625 (1852.5MHz), 19175 (1907.5MHz)	5MHz	QPSK	1 Half Full
		18650 to 19150	18650 (1855.0MHz), 19150 (1905.0MHz)	10MHz	QPSK	1 Half Full
		18675 to 19125	18675 (1857.5MHz), 19125 (1902.5MHz)	15MHz	QPSK	1 Half Full
		18700 to 19100	18700 (1860.0MHz), 19100 (1900.0MHz)	20MHz	QPSK	1 Half Full
-	Peak to Average Ratio	18607 to 19193	18607 (1850.7MHz), 18900 (1880.0MHz), 19193 (1909.3MHz)	1.4MHz	QPSK / 16QAM	1
		18615 to 19185	18615 (1851.5MHz), 18900 (1880.0MHz), 19185 (1908.5MHz)	3MHz	QPSK / 16QAM	1
		18625 to 19175	18625 (1852.5MHz), 18900 (1880.0MHz), 19175 (1907.5MHz)	5MHz	QPSK / 16QAM	1
		18650 to 19150	18650 (1855.0MHz), 18900 (1880.0MHz), 19150 (1905.0MHz)	10MHz	QPSK / 16QAM	1
		18675 to 19125	18675 (1857.5MHz), 18900 (1880.0MHz), 19125 (1902.5MHz)	15MHz	QPSK / 16QAM	1
		18700 to 19100	18700 (1860.0MHz), 18900 (1880.0MHz), 19100 (1900.0MHz)	20MHz	QPSK / 16QAM	1

EUT Configure Mode	Test item	Available channel	Tested Channel	Channel Bandwidth	Modulation	RB #
-	Conducted Emission	18607 to 19193	18607 (1850.7MHz), 18900 (1880.0MHz), 19193 (1909.3MHz)	1.4MHz	QPSK	1
		18615 to 19185	18615 (1851.5MHz), 18900 (1880.0MHz), 19185 (1908.5MHz)	3MHz	QPSK	1
		18625 to 19175	18625 (1852.5MHz), 18900 (1880.0MHz), 19175 (1907.5MHz)	5MHz	QPSK	1
		18650 to 19150	18650 (1855.0MHz), 18900 (1880.0MHz), 19150 (1905.0MHz)	10MHz	QPSK	1
		18675 to 19125	18675 (1857.5MHz), 18900 (1880.0MHz), 19125 (1902.5MHz)	15MHz	QPSK	1
		18700 to 19100	18700 (1860.0MHz), 18900 (1880.0MHz), 19100 (1900.0MHz)	20MHz	QPSK	1
-	Radiated Emission Below 1GHz	18700 to 19100	19100 (1900.0MHz)	20MHz	QPSK	1
-	Radiated Emission Above 1GHz	18607 to 19193	18607 (1850.7MHz), 18900 (1880.0MHz), 19193 (1909.3MHz)	1.4MHz	QPSK	1
		18625 to 19175	18625 (1852.5MHz), 18900 (1880.0MHz), 19175 (1907.5MHz)	5MHz	QPSK	1
		18700 to 19100	18700 (1860.0MHz), 18900 (1880.0MHz), 19100 (1900.0MHz)	20MHz	QPSK	1

Note:

1. For radiated emission below 1GHz, select the worst radiated emission channel (above 1GHz) for final testing.
2. For radiated emission above 1GHz, according to 3GPP 36.521-1 Section 6.6.3.1.4.1, choose the lowest, 5MHz & highest channel bandwidth for final test.
3. The output power for QPSK and 16QAM, measured value of QPSK is higher than 16QAM mode. Therefore, only Modulation characteristics, occupied bandwidth and Peak to average ratio items had been tested under QPSK and 16QAM modes, the other test items were performed under worse mode according to the maximum output power.

LTE Band 25

EUT Configure Mode	Test item	Available channel	Tested Channel	Channel Bandwidth	Modulation	RB #
-	EIRP	26047 to 26683	26047 (1850.7MHz), 26365 (1882.5MHz), 26683 (1914.3MHz)	1.4MHz	QPSK / 16QAM	1 Half Full
		26055 to 26675	26055 (1851.5MHz), 26365 (1882.5MHz), 26675 (1913.5MHz)	3MHz	QPSK / 16QAM	1 Half Full
		26065 to 26665	26065 (1852.5MHz), 26365 (1882.5MHz), 26665 (1912.5MHz)	5MHz	QPSK / 16QAM	1 Half Full
		26090 to 26640	26090 (1855.0MHz), 26365 (1882.5MHz), 26640 (1910.0MHz)	10MHz	QPSK / 16QAM	1 Half Full
		26115 to 26615	26115 (1857.5MHz), 26365 (1882.5MHz), 26615 (1907.5MHz)	15MHz	QPSK / 16QAM	1 Half Full
		26140 to 26590	26140 (1860.0MHz), 26365 (1882.5MHz), 26590 (1905.0MHz)	20MHz	QPSK / 16QAM	1 Half Full
-	Modulation Characteristics	26140 to 26590	26365 (1882.5MHz)	20MHz	QPSK / 16QAM	Full
-	Frequency Stability	26047 to 26683	26047 (1850.7MHz), 26683 (1914.3MHz)	1.4MHz	QPSK	Full
		26055 to 26675	26055 (1851.5MHz), 26675 (1913.5MHz)	3MHz	QPSK	Full
		26065 to 26665	26065 (1852.5MHz), 26665 (1912.5MHz)	5MHz	QPSK	Full
		26090 to 26640	26090 (1855.0MHz), 26640 (1910.0MHz)	10MHz	QPSK	Full
		26115 to 26615	26115 (1857.5MHz), 26615 (1907.5MHz)	15MHz	QPSK	Full
		26140 to 26590	26140 (1860.0MHz), 26590 (1905.0MHz)	20MHz	QPSK	Full
-	Occupied Bandwidth	26047 to 26683	26047 (1850.7MHz), 26365 (1882.5MHz), 26683 (1914.3MHz)	1.4MHz	QPSK / 16QAM	Full
		26055 to 26675	26055 (1851.5MHz), 26365 (1882.5MHz), 26675 (1913.5MHz)	3MHz	QPSK / 16QAM	Full
		26065 to 26665	26065 (1852.5MHz), 26365 (1882.5MHz), 26665 (1912.5MHz)	5MHz	QPSK / 16QAM	Full
		26090 to 26640	26090 (1855.0MHz), 26365 (1882.5MHz), 26640 (1910.0MHz)	10MHz	QPSK / 16QAM	Full
		26115 to 26615	26115 (1857.5MHz), 26365 (1882.5MHz), 26615 (1907.5MHz)	15MHz	QPSK / 16QAM	Full
		26140 to 26590	26140 (1860.0MHz), 26365 (1882.5MHz), 26590 (1905.0MHz)	20MHz	QPSK / 16QAM	Full

EUT Configure Mode	Test item	Available channel	Tested Channel	Channel Bandwidth	Modulation	RB #
-	Band Edge	26047 to 26683	26047 (1850.7MHz), 26683 (1914.3MHz)	1.4MHz	QPSK	1 Half Full
		26055 to 26675	26055 (1851.5MHz), 26675 (1913.5MHz)	3MHz	QPSK	1 Half Full
		26065 to 26665	26065 (1852.5MHz), 26665 (1912.5MHz)	5MHz	QPSK	1 Half Full
		26090 to 26640	26090 (1855.0MHz), 26640 (1910.0MHz)	10MHz	QPSK	1 Half Full
		26115 to 26615	26115 (1857.5MHz), 26615 (1907.5MHz)	15MHz	QPSK	1 Half Full
		26140 to 26590	26140 (1860.0MHz), 26590 (1905.0MHz)	20MHz	QPSK	1 Half Full
-	Peak to Average Ratio	26047 to 26683	26047 (1850.7MHz), 26365 (1882.5MHz), 26683 (1914.3MHz)	1.4MHz	QPSK / 16QAM	1
		26055 to 26675	26055 (1851.5MHz), 26365 (1882.5MHz), 26675 (1913.5MHz)	3MHz	QPSK / 16QAM	1
		26065 to 26665	26065 (1852.5MHz), 26365 (1882.5MHz), 26665 (1912.5MHz)	5MHz	QPSK / 16QAM	1
		26090 to 26640	26090 (1855.0MHz), 26365 (1882.5MHz), 26640 (1910.0MHz)	10MHz	QPSK / 16QAM	1
		26115 to 26615	26115 (1857.5MHz), 26365 (1882.5MHz), 26615 (1907.5MHz)	15MHz	QPSK / 16QAM	1
		26140 to 26590	26140 (1860.0MHz), 26365 (1882.5MHz), 26590 (1905.0MHz)	20MHz	QPSK / 16QAM	1

EUT Configure Mode	Test item	Available channel	Tested Channel	Channel Bandwidth	Modulation	RB #
-	Conducted Emission	26047 to 26683	26047 (1850.7MHz), 26365 (1882.5MHz), 26683 (1914.3MHz)	1.4MHz	QPSK	1
		26055 to 26675	26055 (1851.5MHz), 26365 (1882.5MHz), 26675 (1913.5MHz)	3MHz	QPSK	1
		26065 to 26665	26065 (1852.5MHz), 26365 (1882.5MHz), 26665 (1912.5MHz)	5MHz	QPSK	1
		26090 to 26640	26090 (1855.0MHz), 26365 (1882.5MHz), 26640 (1910.0MHz)	10MHz	QPSK	1
		26115 to 26615	26115 (1857.5MHz), 26365 (1882.5MHz), 26615 (1907.5MHz)	15MHz	QPSK	1
		26140 to 26590	26140 (1860.0MHz), 26365 (1882.5MHz), 26590 (1905.0MHz)	20MHz	QPSK	1
-	Radiated Emission Below 1GHz	26140 to 26590	26365 (1882.5MHz)	20MHz	QPSK	1
-	Radiated Emission Above 1GHz	26047 to 26683	26047 (1850.7MHz), 26365 (1882.5MHz), 26683 (1914.3MHz)	1.4MHz	QPSK	1
		26065 to 26665	26065 (1852.5MHz), 26365 (1882.5MHz), 26665 (1912.5MHz)	5MHz	QPSK	1
		26140 to 26590	26140 (1860.0MHz), 26365 (1882.5MHz), 26590 (1905.0MHz)	20MHz	QPSK	1

Note:

1. For radiated emission below 1GHz, select the worst radiated emission channel (above 1GHz) for final testing.
2. For radiated emission above 1GHz, according to 3GPP 36.521-1 Section 6.6.3.1.4.1, choose the lowest, 5MHz & highest channel bandwidth for final test.
3. The output power for QPSK and 16QAM, measured value of QPSK is higher than 16QAM mode. Therefore, only Modulation characteristics, occupied bandwidth and Peak to average ratio items had been tested under QPSK and 16QAM modes, the other test items were performed under worse mode according to the maximum output power.

Test Condition:

Test Item	Environmental Conditions	Input Power	Tested By
EIRP	25deg. C, 60%RH	120Vac, 60Hz	Willy Cheng
Modulation Characteristics	25deg. C, 60%RH	120Vac, 60Hz	Willy Cheng
Frequency Stability	25deg. C, 60%RH	3.7Vdc	Willy Cheng
Occupied Bandwidth	25deg. C, 60%RH	120Vac, 60Hz	Willy Cheng
Band Edge	25deg. C, 60%RH	120Vac, 60Hz	Willy Cheng
Peak To Average Ratio	25deg. C, 60%RH	120Vac, 60Hz	Willy Cheng
Conducted Emission	25deg. C, 60%RH	120Vac, 60Hz	Willy Cheng
Radiated Emission	25deg. C, 60%RH	120Vac, 60Hz	Charles Hsiao Karl Lee

3.4 EUT Operating Conditions

The EUT makes a call to the communication simulator. The communication simulator station system controlled a EUT to export maximum output power under transmission mode and specific channel frequency

3.5 General Description of Applied Standards and References

The EUT is a RF Product. According to the specifications of the manufacturer, it must comply with the requirements of the following standards:

Test Standard:

FCC 47 CFR Part 2

FCC 47 CFR Part 24

ANSI/TIA/EIA-603-E 2016

ANSI 63.26-2015

References Test Guidance:

KDB 971168 D01 Power Meas License Digital Systems v03r01

All test items have been performed and recorded as per the above standards.

4 Test Types and Results

4.1 Output Power Measurement

4.1.1 Limits of Output Power Measurement

Mobile / Portable station are limited to 2 watts e.i.r.p.

4.1.2 Test Procedures

Conducted Power Measurement:

The EUT was set up for the maximum power with GPRS, EDGE, WCDMA, LTE link data modulation and link up with simulator. Set the EUT to transmit under low, middle and high channel and record the power level shown on simulator.

Maximum EIRP / ERP

The relevant equation for determining the maximum ERP or EIRP from the measured RF output power is given in Equation as follows:

$$\text{EIRP} = P_{\text{Meas}} + G_{\text{T}}$$

$$\text{ERP} = P_{\text{Meas}} + G_{\text{T}} - 2.15$$

where

ERP or EIRP effective radiated power or equivalent isotropically radiated power, respectively
(expressed in the same units as P_{Meas} , e.g., dBm or dBW)

P_{Meas} measured transmitter output power or PSD, in dBm or dBW

G_{T} gain of the transmitting antenna, in dBd (ERP) or dBi (EIRP)

4.1.3 Test Setup

Conducted Power Measurement:



4.1.4 Test Results

Conducted Output Power (dBm)

Band	GPRS, EDGE 1900		
Channel	512	661	810
Frequency (MHz)	1850.2	1880	1909.8
GPRS 1Tx Slot	27.16	27.42	27.06
GPRS 2Tx Slot	25.84	26.31	25.95
GPRS 3Tx Slot	25.51	25.98	25.62
GPRS 4Tx Slot	25.24	25.71	25.35
EDGE 1Tx Slot (MCS9)	26.21	26.68	26.32
EDGE 2Tx Slot (MCS9)	25.64	26.11	25.75
EDGE 3Tx Slot (MCS9)	24.25	24.72	24.36
EDGE 4Tx Slot (MCS9)	22.91	23.38	23.02

Band	WCDMA II		
TX Channel	9262	9400	9538
Frequency (MHz)	1852.4	1880	1907.6
RMC 12.2K	23.49	23.48	23.44
HSDPA Subtest-1	22.48	22.45	22.43
HSDPA Subtest-2	22.46	22.41	22.45
HSDPA Subtest-3	21.99	21.96	21.91
HSDPA Subtest-4	21.96	21.93	21.90
DC-HSDPA Subtest-1	22.40	22.38	22.35
DC-HSDPA Subtest-2	22.38	22.34	22.37
DC-HSDPA Subtest-3	21.91	21.89	21.83
DC-HSDPA Subtest-4	21.88	21.86	21.82
HSUPA Subtest-1	22.47	22.44	22.40
HSUPA Subtest-2	20.48	20.44	20.41
HSUPA Subtest-3	21.48	21.47	21.43
HSUPA Subtest-4	20.46	20.45	20.41
HSUPA Subtest-5	22.44	22.45	22.41

LTE Band 2						
BW	MCS Index	RB Size	RB Offset	Low	Mid	High
		Channel		18700	18900	19100
		Frequency (MHz)		1860	1880	1900
20M	QPSK	1	0	22.83	22.23	22.61
		1	50	22.82	22.22	22.60
		1	99	22.53	22.04	22.31
		50	0	21.96	21.36	21.74
		50	25	21.93	21.33	21.71
		50	50	21.92	21.32	21.70
		100	0	21.90	21.30	21.68
20M	16QAM	1	0	21.95	21.35	21.73
		1	50	21.91	21.31	21.69
		1	99	21.88	21.28	21.66
		50	0	-	-	-
		50	25	-	-	-
		50	50	-	-	-
		100	0	-	-	-

LTE Band 2						
BW	MCS Index	RB Size	RB Offset	Low	Mid	High
		Channel		18675	18900	19125
		Frequency (MHz)		1857.5	1880	1902.5
15M	QPSK	1	0	22.74	22.15	22.59
		1	37	22.75	22.19	22.50
		1	74	22.50	22.06	22.23
		36	0	21.87	21.28	21.67
		36	19	21.88	21.24	21.67
		36	39	21.86	21.24	21.60
		75	0	21.86	21.24	21.59
15M	16QAM	1	0	21.93	21.27	21.69
		1	37	21.84	21.27	21.68
		1	74	21.78	21.27	21.58
		36	0	-	-	-
		36	19	-	-	-
		36	39	-	-	-
		75	0	-	-	-

LTE Band 2						
BW	MCS Index	RB Size	RB Offset	Low	Mid	High
		Channel		18650	18900	19150
		Frequency (MHz)		1855	1880	1905
10M	QPSK	1	0	22.69	22.08	22.39
		1	24	22.75	22.11	22.51
		1	49	22.40	22.01	22.25
		25	0	21.87	21.33	21.70
		25	12	21.91	21.28	21.58
		25	25	21.78	21.22	21.55
		50	0	21.82	21.27	21.50
10M	16QAM	1	0	21.90	21.20	21.62
		1	24	21.84	21.14	21.56
		1	49	21.96	21.26	21.68
		25	0	20.93	20.33	20.75
		25	12	20.85	20.31	20.73
		25	25	20.98	20.28	20.70
		50	0	-	-	-

LTE Band 2						
BW	MCS Index	RB Size	RB Offset	Low	Mid	High
		Channel		18625	18900	19175
		Frequency (MHz)		1852.5	1880	1907.5
5M	QPSK	1	0	22.60	22.01	22.37
		1	12	22.67	22.10	22.42
		1	24	22.38	22.00	22.07
		12	0	21.77	21.25	21.57
		12	6	21.91	21.30	21.53
		12	13	21.78	21.08	21.43
		25	0	21.73	21.14	21.46
5M	16QAM	1	0	21.87	21.28	21.55
		1	12	21.81	21.19	21.54
		1	24	21.86	21.27	21.60
		12	0	20.83	20.29	20.56
		12	6	20.83	20.17	20.51
		12	13	20.89	20.29	20.66
		25	0	20.85	20.18	20.48

LTE Band 2						
BW	MCS Index	RB Size	RB Offset	Low	Mid	High
		Channel		18615	18900	19185
		Frequency (MHz)		1851.5	1880	1908.5
3M	QPSK	1	0	22.46	22.08	22.35
		1	7	22.63	22.03	22.30
		1	14	22.28	22.02	22.05
		8	0	21.82	21.13	21.45
		8	3	21.88	21.11	21.49
		8	7	21.74	21.14	21.27
		15	0	21.73	21.05	21.38
3M	16QAM	1	0	21.77	21.16	21.40
		1	7	21.70	21.13	21.38
		1	14	21.85	21.20	21.54
		8	0	20.89	20.09	20.59
		8	3	20.72	20.14	20.39
		8	7	20.84	20.24	20.55
		15	0	20.79	20.16	20.41

LTE Band 2						
BW	MCS Index	RB Size	RB Offset	Low	Mid	High
		Channel		18607	18900	19193
		Frequency (MHz)		1850.7	1880	1909.3
1.4M	QPSK	1	0	22.59	22.05	22.24
		1	2	22.58	22.03	22.36
		1	5	22.22	22.04	22.01
		3	0	21.89	21.56	21.74
		3	1	21.87	21.52	21.66
		3	3	21.78	21.51	21.53
		6	0	21.74	21.19	21.35
1.4M	16QAM	1	0	21.75	21.15	21.48
		1	2	21.70	21.11	21.48
		1	5	21.93	21.29	21.54
		3	0	20.84	20.57	20.67
		3	1	20.69	20.51	20.62
		3	3	20.91	20.53	20.66
		6	0	20.79	20.15	20.54

LTE Band 25						
BW	MCS Index	RB Size	RB Offset	Low	Mid	High
		Channel		26140	26365	26590
		Frequency (MHz)		1860	1882.5	1905
20M	QPSK	1	0	23.45	23.37	22.33
		1	50	23.41	23.33	22.39
		1	99	23.28	23.20	23.16
		50	0	22.46	21.38	21.84
		50	25	22.37	21.29	21.75
		50	50	22.29	21.21	21.67
		100	0	22.32	21.24	21.70
20M	16QAM	1	0	22.44	21.36	21.82
		1	50	22.38	21.30	21.76
		1	99	22.33	21.25	21.71
		50	0	-	-	-
		50	25	-	-	-
		50	50	-	-	-
		100	0	-	-	-

LTE Band 25						
BW	MCS Index	RB Size	RB Offset	Low	Mid	High
		Channel		26115	26365	26615
		Frequency (MHz)		1857.5	1882.5	1907.5
15M	QPSK	1	0	23.38	23.27	23.23
		1	37	23.34	23.27	23.22
		1	74	23.27	23.17	23.21
		36	0	22.36	21.34	21.75
		36	19	22.27	21.23	21.74
		36	39	22.28	21.15	21.58
		75	0	22.31	21.24	21.63
15M	16QAM	1	0	22.36	21.35	21.75
		1	37	22.30	21.21	21.68
		1	74	22.23	21.22	21.62
		36	0	-	-	-
		36	19	-	-	-
		36	39	-	-	-
		75	0	-	-	-

LTE Band 25						
BW	MCS Index	RB Size	RB Offset	Low	Mid	High
		Channel		26090	26365	26640
		Frequency (MHz)		1855	1882.5	1910
10M	QPSK	1	0	23.35	23.36	23.20
		1	24	23.33	23.30	23.27
		1	49	23.18	23.17	23.16
		25	0	22.40	21.31	21.79
		25	12	22.28	21.21	21.72
		25	25	22.28	21.19	21.58
		50	0	22.22	21.20	21.63
10M	16QAM	1	0	22.38	21.28	21.75
		1	24	22.36	21.20	21.74
		1	49	22.32	21.22	21.67
		25	0	21.44	20.36	20.82
		25	12	21.32	20.24	20.70
		25	25	21.28	20.20	20.66
		50	0	-	-	-

LTE Band 25						
BW	MCS Index	RB Size	RB Offset	Low	Mid	High
		Channel		26065	26365	26665
		Frequency (MHz)		1852.5	1882.5	1912.5
5M	QPSK	1	0	23.42	23.28	23.28
		1	12	23.40	23.27	23.25
		1	24	23.27	23.17	23.10
		12	0	22.43	21.29	21.74
		12	6	22.34	21.21	21.66
		12	13	22.20	21.12	21.59
		25	0	22.32	21.19	21.67
5M	16QAM	1	0	22.44	21.28	21.82
		1	12	22.33	21.26	21.71
		1	24	22.29	21.15	21.61
		12	0	21.38	20.33	20.79
		12	6	21.22	20.24	20.69
		12	13	21.26	20.13	20.65
		25	0	21.26	20.18	20.64

LTE Band 25						
BW	MCS Index	RB Size	RB Offset	Low	Mid	High
		Channel		26055	26365	26675
		Frequency (MHz)		1851.5	1882.5	1913.5
3M	QPSK	1	0	23.44	23.29	23.26
		1	7	23.33	23.25	23.24
		1	14	23.20	23.17	23.11
		8	0	22.38	21.38	21.74
		8	3	22.33	21.21	21.75
		8	7	22.27	21.20	21.65
		15	0	22.22	21.14	21.62
3M	16QAM	1	0	22.42	21.29	21.76
		1	7	22.36	21.23	21.72
		1	14	22.31	21.17	21.68
		8	0	21.35	20.31	20.72
		8	3	21.28	20.24	20.62
		8	7	21.25	20.13	20.66
		15	0	21.24	20.11	20.57

LTE Band 25						
BW	MCS Index	RB Size	RB Offset	Low	Mid	High
		Channel		26047	26365	26683
		Frequency (MHz)		1850.7	1882.5	1914.3
1.4M	QPSK	1	0	23.23	23.21	23.23
		1	2	23.20	23.24	23.25
		1	5	23.24	23.02	22.94
		3	0	23.43	23.23	23.26
		3	1	23.34	23.16	23.21
		3	3	23.16	23.15	22.95
		6	0	22.28	21.19	21.56
1.4M	16QAM	1	0	22.34	21.27	21.71
		1	2	22.29	21.09	21.70
		1	5	22.21	21.05	21.49
		3	0	22.26	21.21	21.73
		3	1	22.15	21.12	21.59
		3	3	22.08	21.01	21.42
		6	0	21.23	20.12	20.49

EIRP Power (dBm)

Band	GPRS, EDGE 1900		
Channel	512	661	810
Frequency (MHz)	1850.2	1880	1909.8
GPRS 1Tx Slot	29.36	29.62	29.26
GPRS 2Tx Slot	28.04	28.51	28.15
GPRS 3Tx Slot	27.71	28.18	27.82
GPRS 4Tx Slot	27.44	27.91	27.55
EDGE 1Tx Slot (MCS9)	28.41	28.88	28.52
EDGE 2Tx Slot (MCS9)	27.84	28.31	27.95
EDGE 3Tx Slot (MCS9)	26.45	26.92	26.56
EDGE 4Tx Slot (MCS9)	25.11	25.58	25.22

*EIRP = Conducted + antenna gain (2.2dBi)

Band	WCDMA II		
TX Channel	9262	9400	9538
Frequency (MHz)	1852.4	1880	1907.6
RMC 12.2K	25.69	25.68	25.64
HSDPA Subtest-1	24.68	24.65	24.63
HSDPA Subtest-2	24.66	24.61	24.65
HSDPA Subtest-3	24.19	24.16	24.11
HSDPA Subtest-4	24.16	24.13	24.10
DC-HSDPA Subtest-1	24.60	24.58	24.55
DC-HSDPA Subtest-2	24.58	24.54	24.57
DC-HSDPA Subtest-3	24.11	24.09	24.03
DC-HSDPA Subtest-4	24.08	24.06	24.02
HSUPA Subtest-1	24.67	24.64	24.60
HSUPA Subtest-2	22.68	22.64	22.61
HSUPA Subtest-3	23.68	23.67	23.63
HSUPA Subtest-4	22.66	22.65	22.61
HSUPA Subtest-5	24.64	24.65	24.61

*EIRP = Conducted + antenna gain (2.2dBi)

LTE Band 2						
BW	MCS Index	RB Size	RB Offset	Low	Mid	High
		Channel		18700	18900	19100
		Frequency (MHz)		1860	1880	1900
20M	QPSK	1	0	25.03	24.43	24.81
		1	50	25.02	24.42	24.80
		1	99	24.73	24.24	24.51
		50	0	24.16	23.56	23.94
		50	25	24.13	23.53	23.91
		50	50	24.12	23.52	23.90
		100	0	24.10	23.50	23.88
20M	16QAM	1	0	24.15	23.55	23.93
		1	50	24.11	23.51	23.89
		1	99	24.08	23.48	23.86
		50	0	-	-	-
		50	25	-	-	-
		50	50	-	-	-
		100	0	-	-	-

*EIRP = Conducted + antenna gain (2.2dBi)

LTE Band 2						
BW	MCS Index	RB Size	RB Offset	Low	Mid	High
		Channel		18675	18900	19125
		Frequency (MHz)		1857.5	1880	1902.5
15M	QPSK	1	0	24.94	24.35	24.79
		1	37	24.95	24.39	24.70
		1	74	24.70	24.26	24.43
		36	0	24.07	23.48	23.87
		36	19	24.08	23.44	23.87
		36	39	24.06	23.44	23.80
		75	0	24.06	23.44	23.79
15M	16QAM	1	0	24.13	23.47	23.89
		1	37	24.04	23.47	23.88
		1	74	23.98	23.47	23.78
		36	0	-	-	-
		36	19	-	-	-
		36	39	-	-	-
		75	0	-	-	-

*EIRP = Conducted + antenna gain (2.2dBi)

LTE Band 2						
BW	MCS Index	RB Size	RB Offset	Low	Mid	High
		Channel		18650	18900	19150
		Frequency (MHz)		1855	1880	1905
10M	QPSK	1	0	24.89	24.28	24.59
		1	24	24.95	24.31	24.71
		1	49	24.60	24.21	24.45
		25	0	24.07	23.53	23.90
		25	12	24.11	23.48	23.78
		25	25	23.98	23.42	23.75
		50	0	24.02	23.47	23.70
10M	16QAM	1	0	24.10	23.40	23.82
		1	24	24.04	23.34	23.76
		1	49	24.16	23.46	23.88
		25	0	23.13	22.53	22.95
		25	12	23.05	22.51	22.93
		25	25	23.18	22.48	22.90
		50	0	-	-	-

*EIRP = Conducted + antenna gain (2.2dBi)

LTE Band 2						
BW	MCS Index	RB Size	RB Offset	Low	Mid	High
		Channel		18625	18900	19175
		Frequency (MHz)		1852.5	1880	1907.5
5M	QPSK	1	0	24.80	24.21	24.57
		1	12	24.87	24.30	24.62
		1	24	24.58	24.20	24.27
		12	0	23.97	23.45	23.77
		12	6	24.11	23.50	23.73
		12	13	23.98	23.28	23.63
		25	0	23.93	23.34	23.66
5M	16QAM	1	0	24.07	23.48	23.75
		1	12	24.01	23.39	23.74
		1	24	24.06	23.47	23.80
		12	0	23.03	22.49	22.76
		12	6	23.03	22.37	22.71
		12	13	23.09	22.49	22.86
		25	0	23.05	22.38	22.68

*EIRP = Conducted + antenna gain (2.2dBi)

LTE Band 2						
BW	MCS Index	RB Size	RB Offset	Low	Mid	High
		Channel		18615	18900	19185
		Frequency (MHz)		1851.5	1880	1908.5
3M	QPSK	1	0	24.66	24.28	24.55
		1	7	24.83	24.23	24.50
		1	14	24.48	24.22	24.25
		8	0	24.02	23.33	23.65
		8	3	24.08	23.31	23.69
		8	7	23.94	23.34	23.47
		15	0	23.93	23.25	23.58
3M	16QAM	1	0	23.97	23.36	23.60
		1	7	23.90	23.33	23.58
		1	14	24.05	23.40	23.74
		8	0	23.09	22.29	22.79
		8	3	22.92	22.34	22.59
		8	7	23.04	22.44	22.75
		15	0	22.99	22.36	22.61

*EIRP = Conducted + antenna gain (2.2dBi)

LTE Band 2						
BW	MCS Index	RB Size	RB Offset	Low	Mid	High
		Channel		18607	18900	19193
		Frequency (MHz)		1850.7	1880	1909.3
1.4M	QPSK	1	0	24.79	24.25	24.44
		1	2	24.78	24.23	24.56
		1	5	24.42	24.24	24.21
		3	0	24.09	23.76	23.94
		3	1	24.07	23.72	23.86
		3	3	23.98	23.71	23.73
		6	0	23.94	23.39	23.55
1.4M	16QAM	1	0	23.95	23.35	23.68
		1	2	23.90	23.31	23.68
		1	5	24.13	23.49	23.74
		3	0	23.04	22.77	22.87
		3	1	22.89	22.71	22.82
		3	3	23.11	22.73	22.86
		6	0	22.99	22.35	22.74

*EIRP = Conducted + antenna gain (2.2dBi)

LTE Band 25						
BW	MCS Index	RB Size	RB Offset	Low	Mid	High
		Channel		26140	26365	26590
		Frequency (MHz)		1860	1882.5	1905
20M	QPSK	1	0	25.65	25.57	24.53
		1	50	25.61	25.53	24.59
		1	99	25.48	25.40	25.36
		50	0	24.66	23.58	24.04
		50	25	24.57	23.49	23.95
		50	50	24.49	23.41	23.87
		100	0	24.52	23.44	23.90
20M	16QAM	1	0	24.64	23.56	24.02
		1	50	24.58	23.50	23.96
		1	99	24.53	23.45	23.91
		50	0	-	-	-
		50	25	-	-	-
		50	50	-	-	-
		100	0	-	-	-

*EIRP = Conducted + antenna gain (2.2dBi)

LTE Band 25						
BW	MCS Index	RB Size	RB Offset	Low	Mid	High
		Channel		26115	26365	26615
		Frequency (MHz)		1857.5	1882.5	1907.5
15M	QPSK	1	0	25.58	25.47	25.43
		1	37	25.54	25.47	25.42
		1	74	25.47	25.37	25.41
		36	0	24.56	23.54	23.95
		36	19	24.47	23.43	23.94
		36	39	24.48	23.35	23.78
		75	0	24.51	23.44	23.83
15M	16QAM	1	0	24.56	23.55	23.95
		1	37	24.50	23.41	23.88
		1	74	24.43	23.42	23.82
		36	0	-	-	-
		36	19	-	-	-
		36	39	-	-	-
		75	0	-	-	-

*EIRP = Conducted + antenna gain (2.2dBi)

LTE Band 25						
BW	MCS Index	RB Size	RB Offset	Low	Mid	High
		Channel		26090	26365	26640
		Frequency (MHz)		1855	1882.5	1910
10M	QPSK	1	0	25.55	25.56	25.40
		1	24	25.53	25.50	25.47
		1	49	25.38	25.37	25.36
		25	0	24.60	23.51	23.99
		25	12	24.48	23.41	23.92
		25	25	24.48	23.39	23.78
		50	0	24.42	23.40	23.83
10M	16QAM	1	0	24.58	23.48	23.95
		1	24	24.56	23.40	23.94
		1	49	24.52	23.42	23.87
		25	0	23.64	22.56	23.02
		25	12	23.52	22.44	22.90
		25	25	23.48	22.40	22.86
		50	0	-	-	-

*EIRP = Conducted + antenna gain (2.2dBi)

LTE Band 25						
BW	MCS Index	RB Size	RB Offset	Low	Mid	High
		Channel		26065	26365	26665
		Frequency (MHz)		1852.5	1882.5	1912.5
5M	QPSK	1	0	25.62	25.48	25.48
		1	12	25.60	25.47	25.45
		1	24	25.47	25.37	25.30
		12	0	24.63	23.49	23.94
		12	6	24.54	23.41	23.86
		12	13	24.40	23.32	23.79
		25	0	24.52	23.39	23.87
5M	16QAM	1	0	24.64	23.48	24.02
		1	12	24.53	23.46	23.91
		1	24	24.49	23.35	23.81
		12	0	23.58	22.53	22.99
		12	6	23.42	22.44	22.89
		12	13	23.46	22.33	22.85
		25	0	23.46	22.38	22.84

*EIRP = Conducted + antenna gain (2.2dBi)

LTE Band 25						
BW	MCS Index	RB Size	RB Offset	Low	Mid	High
		Channel		26055	26365	26675
		Frequency (MHz)		1851.5	1882.5	1913.5
3M	QPSK	1	0	25.64	25.49	25.46
		1	7	25.53	25.45	25.44
		1	14	25.40	25.37	25.31
		8	0	24.58	23.58	23.94
		8	3	24.53	23.41	23.95
		8	7	24.47	23.40	23.85
		15	0	24.42	23.34	23.82
3M	16QAM	1	0	24.62	23.49	23.96
		1	7	24.56	23.43	23.92
		1	14	24.51	23.37	23.88
		8	0	23.55	22.51	22.92
		8	3	23.48	22.44	22.82
		8	7	23.45	22.33	22.86
		15	0	23.44	22.31	22.77

*EIRP = Conducted + antenna gain (2.2dBi)

LTE Band 25						
BW	MCS Index	RB Size	RB Offset	Low	Mid	High
		Channel		26047	26365	26683
		Frequency (MHz)		1850.7	1882.5	1914.3
1.4M	QPSK	1	0	25.43	25.41	25.43
		1	2	25.40	25.44	25.45
		1	5	25.44	25.22	25.14
		3	0	25.63	25.43	25.46
		3	1	25.54	25.36	25.41
		3	3	25.36	25.35	25.15
		6	0	24.48	23.39	23.76
1.4M	16QAM	1	0	24.54	23.47	23.91
		1	2	24.49	23.29	23.90
		1	5	24.41	23.25	23.69
		3	0	24.46	23.41	23.93
		3	1	24.35	23.32	23.79
		3	3	24.28	23.21	23.62
		6	0	23.43	22.32	22.69

*EIRP = Conducted + antenna gain (2.2dBi)

4.2 Modulation Characteristics Measurement

4.2.1 Limits of Modulation Characteristics

N/A

4.2.2 Test Procedure

Connect the EUT to Communication Simulator via the antenna connector, The frequency band is set as EUT supported Modulation and Channels, the EUT output is matched with 50 ohm load, the waveform quality and constellation of the EUT was tested.

4.2.3 Test Setup



4.2.4 Test Results

GPRS, EDGE

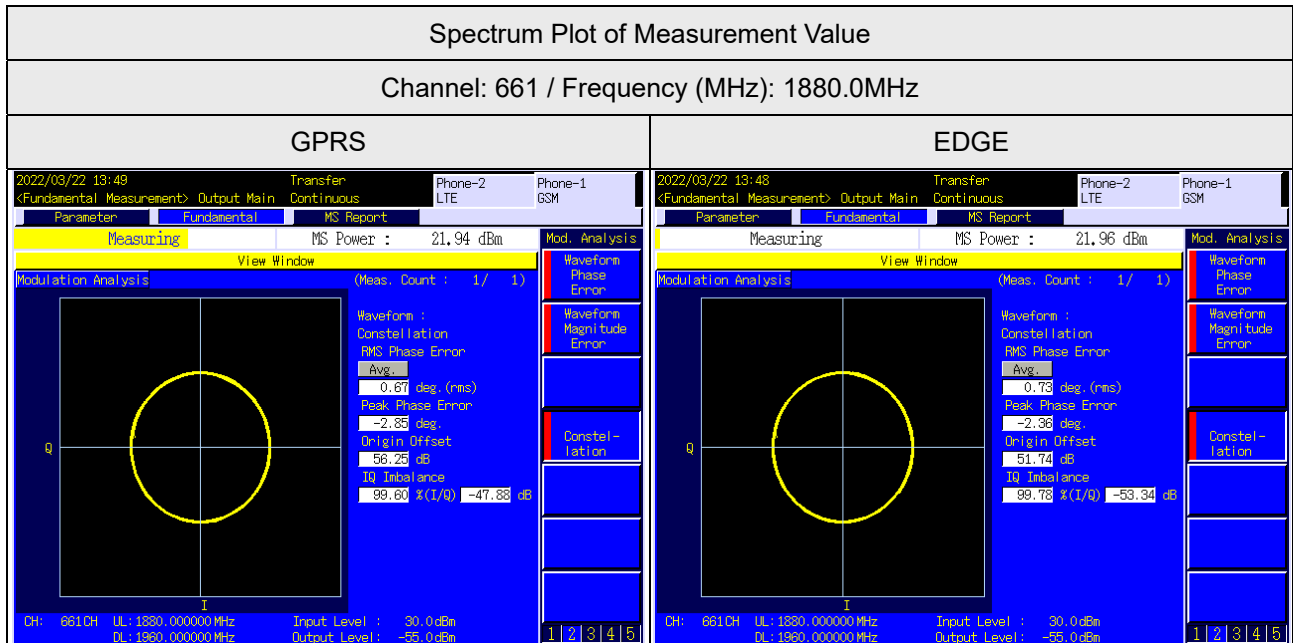

WCDMA Band 2

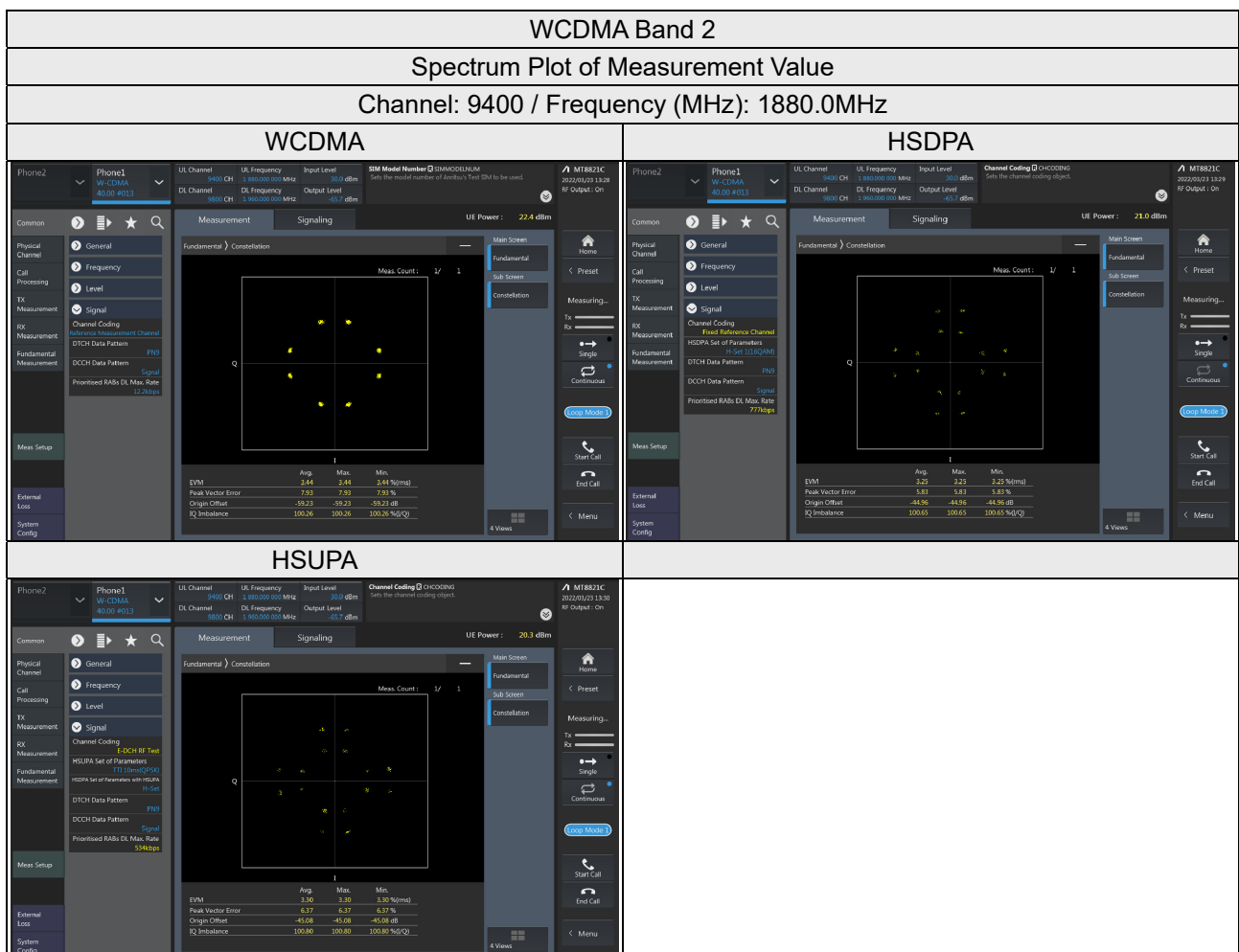

LTE Band 2

Spectrum Plot of Measurement Value

Channel: 18900 / Frequency (MHz): 1880.0MHz

QPSK

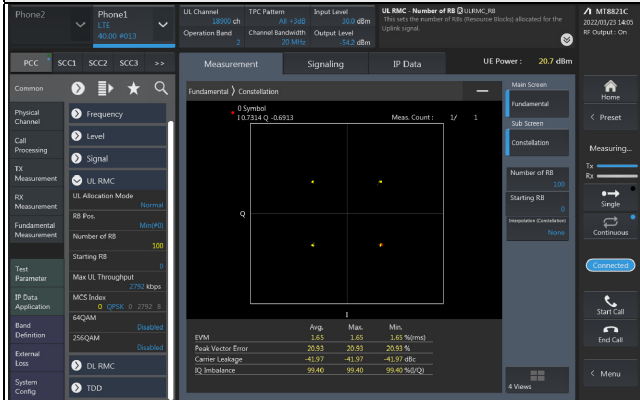

16QAM

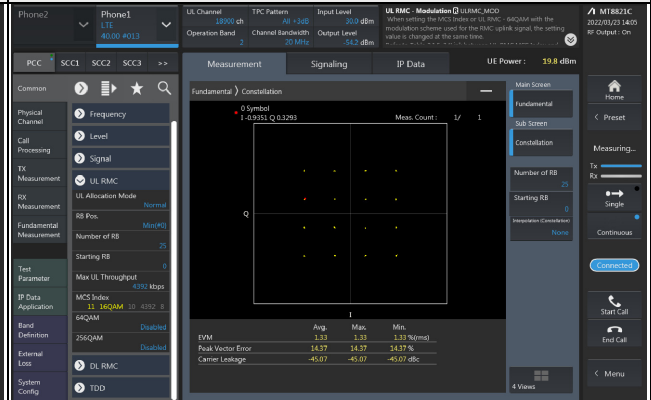

LTE Band 25

Spectrum Plot of Measurement Value

Channel: 26365 / Frequency (MHz): 1882.5MHz

QPSK

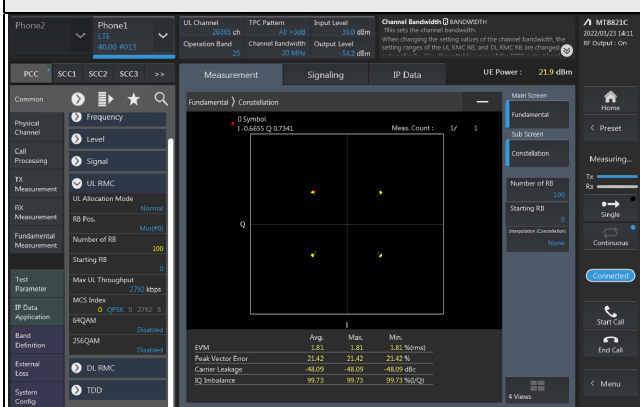

16QAM

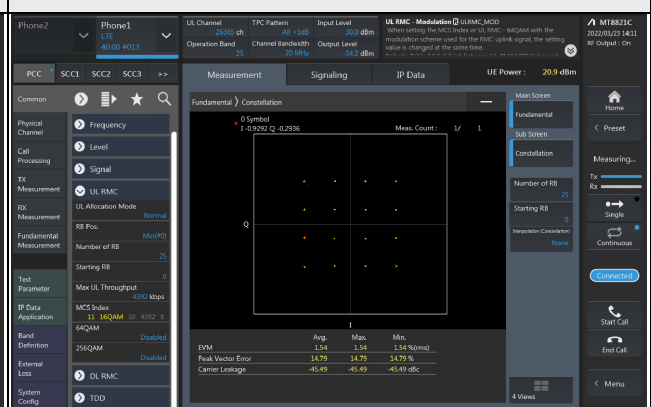

4.3 Frequency Stability Measurement

4.3.1 Limits of Frequency Stability Measurement

The frequency stability shall be sufficient to ensure that the fundamental emission stays within the authorized frequency block.

4.3.2 Test Procedure

- a. Device is placed at the oven room. The oven room could control the temperatures and humidity. Power warm up is at least 15 min and power applied should perform before recording frequency error.
- b. EUT is connected the external power supply to control the DC input power. The test voltage range is from minimum to maximum working voltage. Each step shall be record the frequency error rate.
- c. The temperature range step is 10 degrees in this test items. All temperature levels shall be hold the ± 0.5 °C during the measurement testing. The each temperature step shall be at least 0.5 hours, consider the EUT could be test under the stability condition.

Note: The frequency error was recorded frequency error from the communication simulator.

4.3.3 Conducted Setup

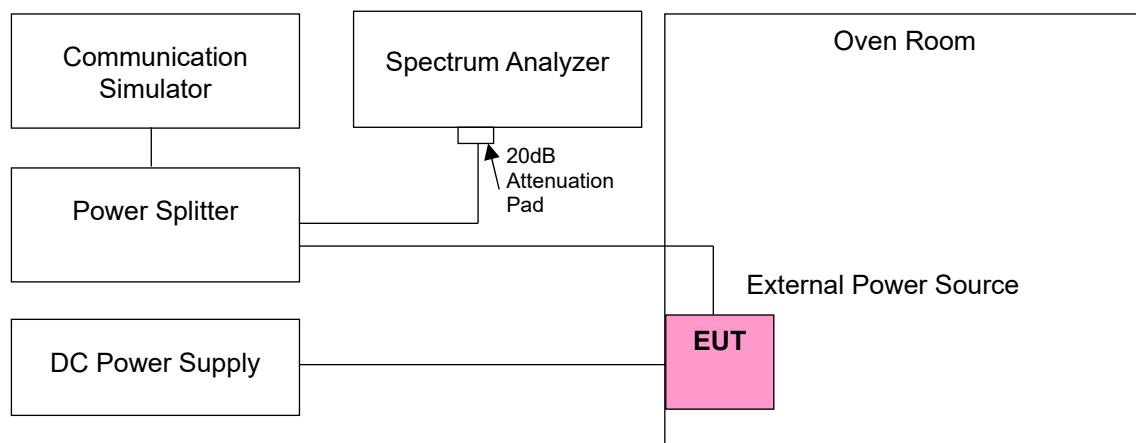

4.3.4 Test Results

Frequency Error vs. Voltage

Voltage (Vdc)	GPRS			
	Low Channel		High Channel	
	Frequency (MHz)	Frequency Error (ppm)	Frequency (MHz)	Frequency Error (ppm)
3.145	1850.200002	0.001	1909.800003	0.002
3.7	1850.200002	0.001	1909.800001	0.001
4.255	1850.200001	0.001	1909.800002	0.001

Note: The applicant defined the normal working voltage is from 3.145Vdc to 4.255Vdc.

Frequency Error vs. Temperature

Temp. (°C)	GPRS			
	Low Channel		High Channel	
	Frequency (MHz)	Frequency Error (ppm)	Frequency (MHz)	Frequency Error (ppm)
-30	1850.200004	0.002	1909.800004	0.002
-20	1850.200003	0.002	1909.800001	0.001
-10	1850.200003	0.002	1909.800001	0.001
0	1850.200002	0.001	1909.800002	0.001
10	1850.199998	-0.001	1909.799997	-0.002
20	1850.199996	-0.002	1909.799999	-0.001
30	1850.199998	-0.001	1909.799996	-0.002
40	1850.199998	-0.001	1909.799996	-0.002
50	1850.199996	-0.002	1909.799998	-0.001

Frequency Error vs. Voltage

Voltage (Vdc)	EDGE			
	Low Channel		High Channel	
	Frequency (MHz)	Frequency Error (ppm)	Frequency (MHz)	Frequency Error (ppm)
3.145	1850.200003	0.002	1909.800002	0.001
3.7	1850.200002	0.001	1909.800001	0.001
4.255	1850.200003	0.002	1909.800003	0.002

Note: The applicant defined the normal working voltage is from 3.145Vdc to 4.255Vdc.

Frequency Error vs. Temperature

Temp. (°C)	EDGE			
	Low Channel		High Channel	
	Frequency (MHz)	Frequency Error (ppm)	Frequency (MHz)	Frequency Error (ppm)
-30	1850.200001	0.001	1909.800002	0.001
-20	1850.200004	0.002	1909.800004	0.002
-10	1850.200002	0.001	1909.800002	0.001
0	1850.200003	0.002	1909.800002	0.001
10	1850.199996	-0.002	1909.799999	-0.001
20	1850.199998	-0.001	1909.799999	-0.001
30	1850.199997	-0.002	1909.799999	-0.001
40	1850.199997	-0.002	1909.799998	-0.001
50	1850.199996	-0.002	1909.799997	-0.002

Frequency Error vs. Voltage

Voltage (Vdc)	WCDMA			
	Low Channel		High Channel	
	Frequency (MHz)	Frequency Error (ppm)	Frequency (MHz)	Frequency Error (ppm)
3.145	1852.400004	0.002	1907.600002	0.001
3.7	1852.400002	0.001	1907.600003	0.002
4.255	1852.400004	0.002	1907.600004	0.002

Note: The applicant defined the normal working voltage is from 3.145Vdc to 4.255Vdc.

Frequency Error vs. Temperature

Temp. (°C)	WCDMA			
	Low Channel		High Channel	
	Frequency (MHz)	Frequency Error (ppm)	Frequency (MHz)	Frequency Error (ppm)
-30	1852.400001	0.001	1907.600003	0.002
-20	1852.400001	0.001	1907.600003	0.002
-10	1852.400001	0.001	1907.600001	0.001
0	1852.400001	0.001	1907.600001	0.001
10	1852.399998	-0.001	1907.599997	-0.002
20	1852.399997	-0.002	1907.599996	-0.002
30	1852.399998	-0.001	1907.599998	-0.001
40	1852.399998	-0.001	1907.599998	-0.001
50	1852.399996	-0.002	1907.599996	-0.002

Frequency Error vs. Voltage

Voltage (Vdc)	LTE Band 2			
	Channel Bandwidth 1.4 MHz			
	Low Channel		High Channel	
	Frequency (MHz)	Frequency Error (ppm)	Frequency (MHz)	Frequency Error (ppm)
3.145	1850.700002	0.001	1909.300000	0.002
3.7	1850.700001	0.001	1909.300002	0.001
4.255	1850.700003	0.002	1909.300002	0.001

Note: The applicant defined the normal working voltage is from 3.145Vdc to 4.255Vdc.

Frequency Error vs. Temperature

Temp. (°C)	LTE Band 2			
	Channel Bandwidth 1.4 MHz			
	Low Channel		High Channel	
	Frequency (MHz)	Frequency Error (ppm)	Frequency (MHz)	Frequency Error (ppm)
-30	1850.700002	0.001	1909.300001	0.001
-20	1850.700001	0.001	1909.300004	0.002
-10	1850.700003	0.002	1909.300001	0.001
0	1850.700004	0.002	1909.300004	0.002
10	1850.699996	-0.002	1909.299998	-0.001
20	1850.699996	-0.002	1909.299999	-0.001
30	1850.699997	-0.002	1909.299997	-0.002
40	1850.699998	-0.001	1909.299999	-0.001
50	1850.699996	-0.002	1909.299999	-0.001

Frequency Error vs. Voltage

Voltage (Vdc)	LTE Band 2			
	Channel Bandwidth 3MHz			
	Low Channel		High Channel	
	Frequency (MHz)	Frequency Error (ppm)	Frequency (MHz)	Frequency Error (ppm)
3.145	1851.500004	0.002	1908.500004	0.002
3.7	1851.500001	0.001	1908.500001	0.001
4.255	1851.500002	0.001	1908.500003	0.002

Note: The applicant defined the normal working voltage is from 3.145Vdc to 4.255Vdc.

Frequency Error vs. Temperature

Temp. (°C)	LTE Band 2			
	Channel Bandwidth 3MHz			
	Low Channel		High Channel	
	Frequency (MHz)	Frequency Error (ppm)	Frequency (MHz)	Frequency Error (ppm)
-30	1851.500004	0.002	1908.500002	0.001
-20	1851.500002	0.001	1908.500001	0.001
-10	1851.500002	0.001	1908.500003	0.002
0	1851.500002	0.001	1908.500004	0.002
10	1851.499998	-0.001	1908.499998	-0.001
20	1851.499997	-0.002	1908.499997	-0.002
30	1851.499996	-0.002	1908.499996	-0.002
40	1851.499996	-0.002	1908.499996	-0.002
50	1851.499996	-0.002	1908.499999	-0.001

Frequency Error vs. Voltage

Voltage (Vdc)	LTE Band 2			
	Channel Bandwidth 5 MHz			
	Low Channel		High Channel	
	Frequency (MHz)	Frequency Error (ppm)	Frequency (MHz)	Frequency Error (ppm)
3.145	1852.500003	0.002	1907.500002	0.001
3.7	1852.500003	0.002	1907.500004	0.002
4.255	1852.500001	0.001	1907.500003	0.002

Note: The applicant defined the normal working voltage is from 3.145Vdc to 4.255Vdc.

Frequency Error vs. Temperature

Temp. (°C)	LTE Band 2			
	Channel Bandwidth 5 MHz			
	Low Channel		High Channel	
	Frequency (MHz)	Frequency Error (ppm)	Frequency (MHz)	Frequency Error (ppm)
-30	1852.500002	0.001	1907.500003	0.002
-20	1852.500004	0.002	1907.500001	0.001
-10	1852.500003	0.002	1907.500003	0.002
0	1852.500003	0.002	1907.500002	0.001
10	1852.499997	-0.002	1907.499997	-0.002
20	1852.499999	-0.001	1907.499997	-0.002
30	1852.499996	-0.002	1907.499996	-0.002
40	1852.499996	-0.002	1907.499997	-0.002
50	1852.499996	-0.002	1907.499997	-0.002

Frequency Error vs. Voltage

Voltage (Vdc)	LTE Band 2			
	Channel Bandwidth 10 MHz			
	Low Channel		High Channel	
	Frequency (MHz)	Frequency Error (ppm)	Frequency (MHz)	Frequency Error (ppm)
3.145	1855.000004	0.002	1905.000003	0.002
3.7	1855.000001	0.001	1905.000002	0.001
4.255	1855.000004	0.002	1905.000003	0.002

Note: The applicant defined the normal working voltage is from 3.145Vdc to 4.255Vdc.

Frequency Error vs. Temperature

Temp. (°C)	LTE Band 2			
	Channel Bandwidth 10 MHz			
	Low Channel		High Channel	
	Frequency (MHz)	Frequency Error (ppm)	Frequency (MHz)	Frequency Error (ppm)
-30	1855.000001	0.001	1905.000004	0.002
-20	1855.000003	0.002	1905.000002	0.001
-10	1855.000002	0.001	1905.000003	0.002
0	1855.000003	0.002	1905.000004	0.002
10	1854.999996	-0.002	1904.999997	-0.002
20	1854.999996	-0.002	1904.999999	-0.001
30	1854.999999	-0.001	1904.999997	-0.002
40	1854.999996	-0.002	1904.999998	-0.001
50	1854.999996	-0.002	1904.999996	-0.002

Frequency Error vs. Voltage

Voltage (Vdc)	LTE Band 2			
	Channel Bandwidth 15 MHz			
	Low Channel		High Channel	
	Frequency (MHz)	Frequency Error (ppm)	Frequency (MHz)	Frequency Error (ppm)
3.145	1857.500003	0.002	1902.500003	0.002
3.7	1857.500003	0.002	1902.500001	0.001
4.255	1857.500002	0.001	1902.500004	0.002

Note: The applicant defined the normal working voltage is from 3.145Vdc to 4.255Vdc.

Frequency Error vs. Temperature

Temp. (°C)	LTE Band 2			
	Channel Bandwidth 15 MHz			
	Low Channel		High Channel	
	Frequency (MHz)	Frequency Error (ppm)	Frequency (MHz)	Frequency Error (ppm)
-30	1857.500004	0.002	1902.500002	0.001
-20	1857.500002	0.001	1902.500002	0.001
-10	1857.500003	0.002	1902.500003	0.002
0	1857.500004	0.002	1902.500003	0.002
10	1857.499997	-0.002	1902.499998	-0.001
20	1857.499996	-0.002	1902.499999	-0.001
30	1857.499996	-0.002	1902.499998	-0.001
40	1857.499999	-0.001	1902.499996	-0.002
50	1857.499996	-0.002	1902.499996	-0.002

Frequency Error vs. Voltage

Voltage (Vdc)	LTE Band 2			
	Channel Bandwidth 20 MHz			
	Low Channel		High Channel	
	Frequency (MHz)	Frequency Error (ppm)	Frequency (MHz)	Frequency Error (ppm)
3.145	1860.000001	0.001	1900.000003	0.002
3.7	1860.000004	0.002	1900.000002	0.001
4.255	1860.000003	0.002	1900.000003	0.002

Note: The applicant defined the normal working voltage is from 3.145Vdc to 4.255Vdc.

Frequency Error vs. Temperature

Temp. (°C)	LTE Band 2			
	Channel Bandwidth 20 MHz			
	Low Channel		High Channel	
	Frequency (MHz)	Frequency Error (ppm)	Frequency (MHz)	Frequency Error (ppm)
-30	1860.000002	0.001	1900.000003	0.002
-20	1860.000001	0.001	1900.000004	0.002
-10	1860.000004	0.002	1900.000003	0.002
0	1860.000002	0.001	1900.000003	0.002
10	1859.999996	-0.002	1899.999999	-0.001
20	1859.999999	-0.001	1899.999999	-0.001
30	1859.999999	-0.001	1899.999996	-0.002
40	1859.999997	-0.002	1899.999999	-0.001
50	1859.999996	-0.002	1899.999999	-0.001

Frequency Error vs. Voltage

Voltage (Vdc)	LTE Band 25			
	Channel Bandwidth 1.4 MHz			
	Low Channel		High Channel	
	Frequency (MHz)	Frequency Error (ppm)	Frequency (MHz)	Frequency Error (ppm)
3.145	1850.700002	0.001	1914.300002	0.001
3.7	1850.700003	0.002	1914.300002	0.001
4.255	1850.700001	0.001	1914.300003	0.002

Note: The applicant defined the normal working voltage is from 3.145Vdc to 4.255Vdc.

Frequency Error vs. Temperature

Temp. (°C)	LTE Band 25			
	Channel Bandwidth 1.4 MHz			
	Low Channel		High Channel	
	Frequency (MHz)	Frequency Error (ppm)	Frequency (MHz)	Frequency Error (ppm)
-30	1850.700004	0.002	1914.300002	0.001
-20	1850.700002	0.001	1914.300001	0.001
-10	1850.700003	0.002	1914.300001	0.001
0	1850.700002	0.001	1914.300002	0.001
10	1850.699998	-0.001	1914.299998	-0.001
20	1850.699999	-0.001	1914.299999	-0.001
30	1850.699997	-0.002	1914.299996	-0.002
40	1850.699999	-0.001	1914.299998	-0.001
50	1850.699999	-0.001	1914.299998	-0.001

Frequency Error vs. Voltage

Voltage (Vdc)	LTE Band 25			
	Channel Bandwidth 3MHz			
	Low Channel		High Channel	
	Frequency (MHz)	Frequency Error (ppm)	Frequency (MHz)	Frequency Error (ppm)
3.145	1851.500002	0.001	1913.500002	0.001
3.7	1851.500001	0.001	1913.500002	0.001
4.255	1851.500002	0.001	1913.500002	0.001

Note: The applicant defined the normal working voltage is from 3.145Vdc to 4.255Vdc.

Frequency Error vs. Temperature

Temp. (°C)	LTE Band 25			
	Channel Bandwidth 3MHz			
	Low Channel		High Channel	
	Frequency (MHz)	Frequency Error (ppm)	Frequency (MHz)	Frequency Error (ppm)
-30	1851.500003	0.002	1913.500001	0.001
-20	1851.500001	0.001	1913.500001	0.001
-10	1851.500002	0.001	1913.500003	0.002
0	1851.500001	0.001	1913.500001	0.001
10	1851.499998	-0.001	1913.499999	-0.001
20	1851.499999	-0.001	1913.499996	-0.002
30	1851.499997	-0.002	1913.499998	-0.001
40	1851.499996	-0.002	1913.499999	-0.001
50	1851.499998	-0.001	1913.499996	-0.002

Frequency Error vs. Voltage

Voltage (Vdc)	LTE Band 25			
	Channel Bandwidth 5 MHz			
	Low Channel		High Channel	
	Frequency (MHz)	Frequency Error (ppm)	Frequency (MHz)	Frequency Error (ppm)
3.145	1852.500003	0.002	1912.500004	0.002
3.7	1852.500002	0.001	1912.500003	0.002
4.255	1852.500001	0.001	1912.500001	0.001

Note: The applicant defined the normal working voltage is from 3.145Vdc to 4.255Vdc.

Frequency Error vs. Temperature

Temp. (°C)	LTE Band 25			
	Channel Bandwidth 5 MHz			
	Low Channel		High Channel	
	Frequency (MHz)	Frequency Error (ppm)	Frequency (MHz)	Frequency Error (ppm)
-30	1852.500001	0.001	1912.500002	0.001
-20	1852.500001	0.001	1912.500002	0.001
-10	1852.500003	0.002	1912.500002	0.001
0	1852.500001	0.001	1912.500001	0.001
10	1852.499997	-0.002	1912.499997	-0.002
20	1852.499999	-0.001	1912.499996	-0.002
30	1852.499998	-0.001	1912.499999	-0.001
40	1852.499997	-0.002	1912.499996	-0.002
50	1852.499997	-0.002	1912.499999	-0.001

Frequency Error vs. Voltage

Voltage (Vdc)	LTE Band 25			
	Channel Bandwidth 10 MHz			
	Low Channel		High Channel	
	Frequency (MHz)	Frequency Error (ppm)	Frequency (MHz)	Frequency Error (ppm)
3.145	1855.000003	0.002	1910.000004	0.002
3.7	1855.000003	0.002	1910.000004	0.002
4.255	1855.000003	0.002	1910.000003	0.002

Note: The applicant defined the normal working voltage is from 3.145Vdc to 4.255Vdc.

Frequency Error vs. Temperature

Temp. (°C)	LTE Band 25			
	Channel Bandwidth 10 MHz			
	Low Channel		High Channel	
	Frequency (MHz)	Frequency Error (ppm)	Frequency (MHz)	Frequency Error (ppm)
-30	1855.000003	0.002	1910.000002	0.001
-20	1855.000002	0.001	1910.000002	0.001
-10	1855.000003	0.002	1910.000001	0.001
0	1855.000001	0.001	1910.000002	0.001
10	1854.999996	-0.002	1909.999997	-0.002
20	1854.999999	-0.001	1909.999997	-0.002
30	1854.999999	-0.001	1909.999998	-0.001
40	1854.999997	-0.002	1909.999999	-0.001
50	1854.999998	-0.001	1909.999996	-0.002

Frequency Error vs. Voltage

Voltage (Vdc)	LTE Band 25			
	Channel Bandwidth 15 MHz			
	Low Channel		High Channel	
	Frequency (MHz)	Frequency Error (ppm)	Frequency (MHz)	Frequency Error (ppm)
3.145	1857.500001	0.001	1907.500004	0.002
3.7	1857.500003	0.002	1907.500001	0.001
4.255	1857.500004	0.002	1907.500003	0.002

Note: The applicant defined the normal working voltage is from 3.145Vdc to 4.255Vdc.

Frequency Error vs. Temperature

Temp. (°C)	LTE Band 25			
	Channel Bandwidth 15 MHz			
	Low Channel		High Channel	
	Frequency (MHz)	Frequency Error (ppm)	Frequency (MHz)	Frequency Error (ppm)
-30	1857.500002	0.001	1907.500004	0.002
-20	1857.500001	0.001	1907.500001	0.001
-10	1857.500001	0.001	1907.500001	0.001
0	1857.500002	0.001	1907.500004	0.002
10	1857.499997	-0.002	1907.499996	-0.002
20	1857.499996	-0.002	1907.499996	-0.002
30	1857.499997	-0.002	1907.499997	-0.002
40	1857.499999	-0.001	1907.499996	-0.002
50	1857.499999	-0.001	1907.499997	-0.002

Frequency Error vs. Voltage

Voltage (Vdc)	LTE Band 25			
	Channel Bandwidth 20 MHz			
	Low Channel		High Channel	
	Frequency (MHz)	Frequency Error (ppm)	Frequency (MHz)	Frequency Error (ppm)
3.145	1860.000003	0.002	1905.000002	0.001
3.7	1860.000001	0.001	1905.000002	0.001
4.255	1860.000004	0.002	1905.000001	0.001

Note: The applicant defined the normal working voltage is from 3.145Vdc to 4.255Vdc.

Frequency Error vs. Temperature

Temp. (°C)	LTE Band 25			
	Channel Bandwidth 20 MHz			
	Low Channel		High Channel	
	Frequency (MHz)	Frequency Error (ppm)	Frequency (MHz)	Frequency Error (ppm)
-30	1860.000002	0.001	1905.000002	0.001
-20	1860.000001	0.001	1905.000003	0.002
-10	1860.000002	0.001	1905.000003	0.002
0	1860.000004	0.002	1905.000002	0.001
10	1859.999998	-0.001	1904.999996	-0.002
20	1859.999996	-0.002	1904.999997	-0.002
30	1859.999996	-0.002	1904.999999	-0.001
40	1859.999997	-0.002	1904.999998	-0.001
50	1859.999996	-0.002	1904.999999	-0.001

4.4 Occupied Bandwidth Measurement

4.4.1 Limits of Occupied Bandwidth Measurement

The occupied bandwidth (OBW), that is the frequency bandwidth such that, below its lower and above its upper frequency limits, the mean powers radiated are each equal to 0.5 % of the total mean power radiated by a given emission.

4.4.2 Test Procedure

For the 26dBc bandwidth measurement method, please refer to section 5.4.3 of ANSI C63.26.

- a) The spectrum analyzer center frequency is set to the nominal EUT channel center frequency. The span range for the spectrum analyzer shall be wide enough to see sufficient roll off of the signal to make the measurement.
- b) The nominal RBW shall be in the range of 1% to 5% of the anticipated OBW, and the VBW shall be set $\geq 3 \times$ RBW.
- c) Set the reference level of the instrument as required to prevent the signal amplitude from exceeding the maximum spectrum analyzer input mixer level for linear operation. See guidance provided in 4.2.3.
- d) The dynamic range of the spectrum analyzer at the selected RBW shall be more than 10 dB below the target “-X dB” requirement, i.e., if the requirement calls for measuring the -26 dB OBW, the spectrum analyzer noise floor at the selected RBW shall be at least 36 dB below the reference level.
- e) Set spectrum analyzer detection mode to peak, and the trace mode to max hold.
- f) Determine the following reference values: Set the EUT to transmit a modulated signal. Allow the trace to stabilize. Set the spectrum analyzer marker to the highest level of the displayed trace (this is the reference value).
- g) Determine the “-X dB amplitude” as equal to (Reference Value - X). Alternatively, this calculation can be performed on the spectrum analyzer using the delta-marker measurement function.
- h) Place two markers, one at the lowest and the other at the highest frequency of the envelope of the spectral display such that each marker is at or slightly below the “-X dB amplitude” determined in step f). If a marker is below this “-X dB amplitude” value it should be as close as possible to this value. The OBW is the positive frequency difference between the two markers.
- i) The OBW shall be reported by providing plot(s) of the measuring instrument display, to include markers depicting the relevant frequency and amplitude information (e.g., marker table). The frequency and amplitude axis and scale shall be clearly labeled. Tabular data may be reported in addition to the plot(s).

For the occupied bandwidth measurement method, please refer to section 5.4.4 of ANSI C63.26.

4.4.3 Test Setup

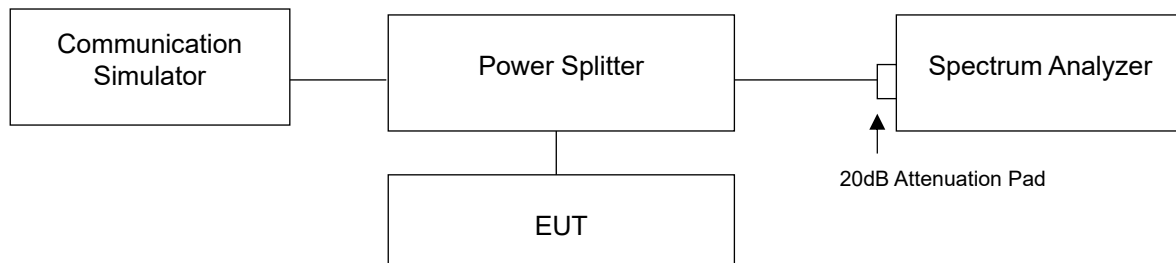

4.4.4 Test Result

GPRS, EDGE

Test Condition	Channel	Frequency (MHz)	Occupied bandwidth (kHz)	26dB Bandwidth (kHz)
GPRS	512	1850.2	247.75	319.60
GPRS	661	1880	245.56	318.80
GPRS	810	1909.8	246.68	313.70
EDGE	512	1850.2	244.57	315.40
EDGE	661	1880	249.07	311.40
EDGE	810	1909.8	246.89	323.60

Spectrum Plot of Worst Value

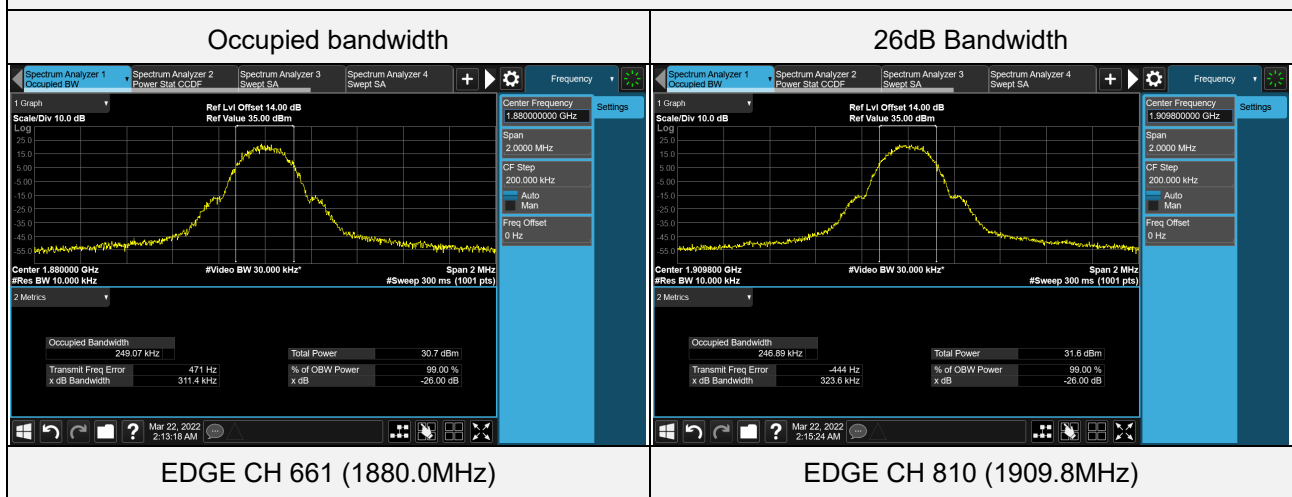

WCDMA Band 2

Test Condition	Channel	Frequency (MHz)	Occupied bandwidth (MHz)	26dB Bandwidth (MHz)
WCDMA	9262	1852.4	4.1358	4.712
WCDMA	9400	1880.0	4.1289	4.701
WCDMA	9538	1907.6	4.1257	4.703
HSDPA	9262	1852.4	4.1404	4.713
HSDPA	9400	1880.0	4.1311	4.709
HSDPA	9538	1907.6	4.1278	4.711
HSUPA	9262	1852.4	4.1354	4.711
HSUPA	9400	1880.0	4.1279	4.716
HSUPA	9538	1907.6	4.1303	4.706

Spectrum Plot of Worst Value

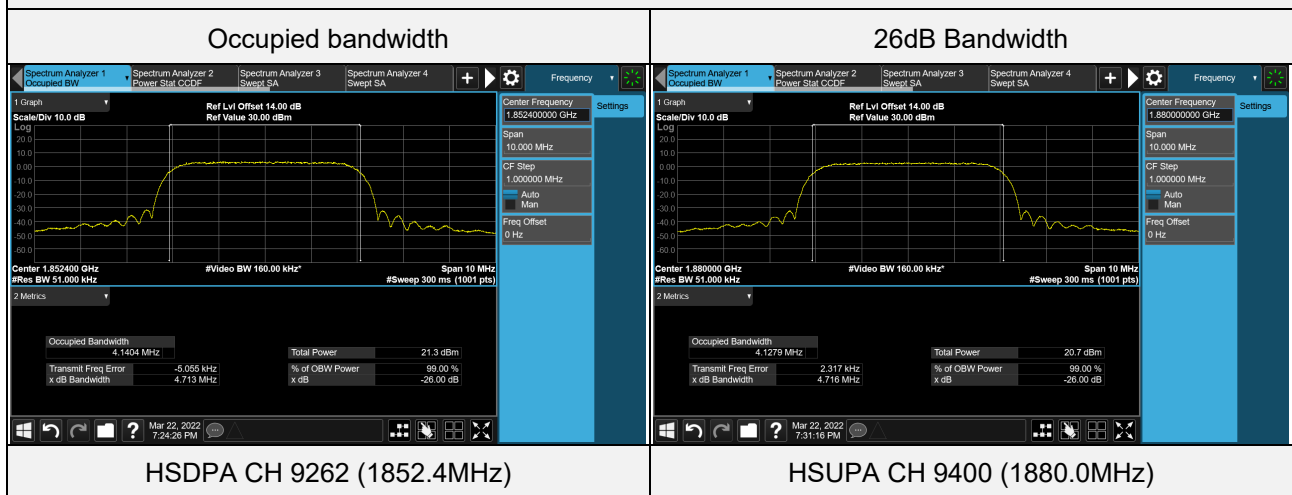

LTE Band 2 (Channel Bandwidth 1.4MHz)

Test Condition	Channel	Frequency (MHz)	Occupied bandwidth (MHz)	26dB Bandwidth (MHz)
QPSK	18607	1850.7	1.0910	1.260
QPSK	18900	1880	1.0915	1.260
QPSK	19193	1909.3	1.0914	1.260
16QAM	18607	1850.7	1.0882	1.251
16QAM	18900	1880	1.0864	1.248
16QAM	19193	1909.3	1.0874	1.242

Spectrum Plot of Worst Value

Occupied bandwidth

26dB Bandwidth

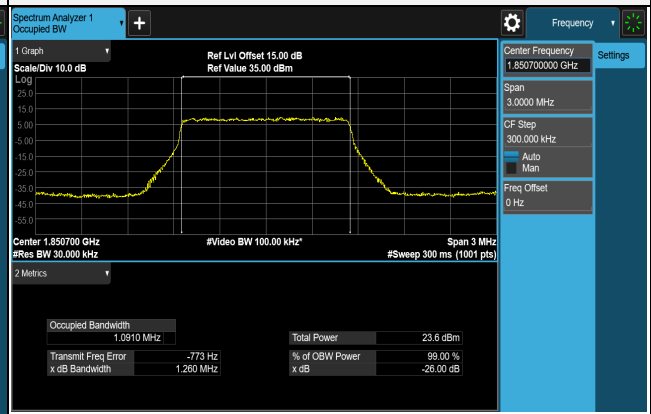
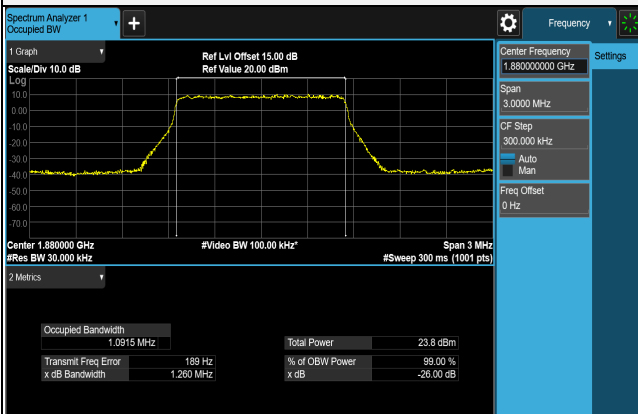

QPSK CH 18900 (1880MHz)

QPSK CH 18607 (1850.7MHz)

LTE Band 2 (Channel Bandwidth 3MHz)

Test Condition	Channel	Frequency (MHz)	Occupied bandwidth (MHz)	26dB Bandwidth (MHz)
QPSK	18615	1851.5	2.6970	2.913
QPSK	18900	1880	2.6978	2.915
QPSK	19185	1908.5	2.6961	2.921
16QAM	18615	1851.5	2.6978	2.923
16QAM	18900	1880	2.6967	2.926
16QAM	19185	1908.5	2.6973	2.924

Spectrum Plot of Worst Value

Occupied bandwidth

26dB Bandwidth

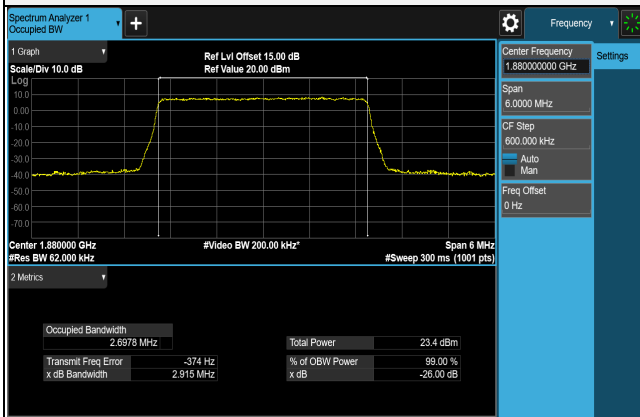

QPSK CH 18900 (1880MHz)

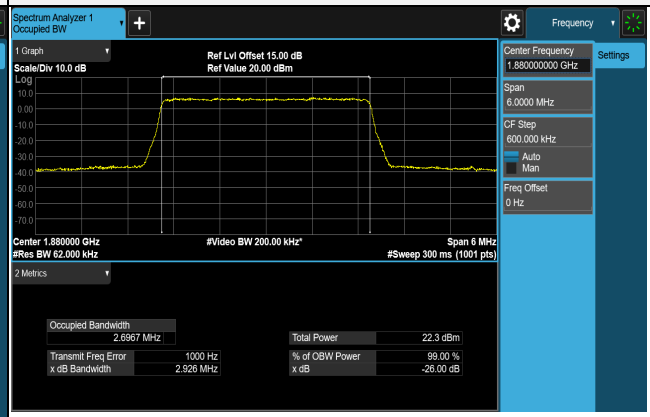

16QAM CH 18900 (1880MHz)

LTE Band 2 (Channel Bandwidth 5MHz)

Test Condition	Channel	Frequency (MHz)	Occupied bandwidth (MHz)	26dB Bandwidth (MHz)
QPSK	18625	1852.5	4.4973	4.833
QPSK	18900	1880	4.4917	4.817
QPSK	19175	1907.5	4.4928	4.817
16QAM	18625	1852.5	4.4886	4.810
16QAM	18900	1880	4.4886	4.806
16QAM	19175	1907.5	4.4867	4.811

Spectrum Plot of Worst Value

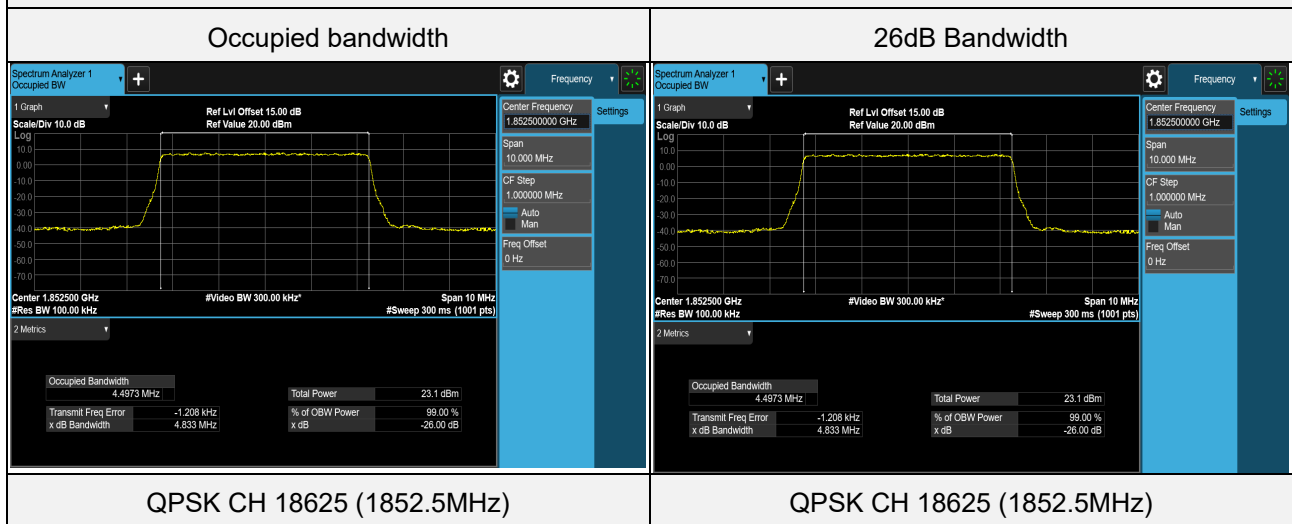

LTE Band 2 (Channel Bandwidth 10MHz)

Test Condition	Channel	Frequency (MHz)	Occupied bandwidth (MHz)	26dB Bandwidth (MHz)
QPSK	18650	1855	8.9498	9.508
QPSK	18900	1880	8.9503	9.499
QPSK	19150	1905	8.9510	9.518
16QAM	18650	1855	4.5624	5.069
16QAM	18900	1880	4.5673	5.083
16QAM	19150	1905	4.5681	5.117

Spectrum Plot of Worst Value

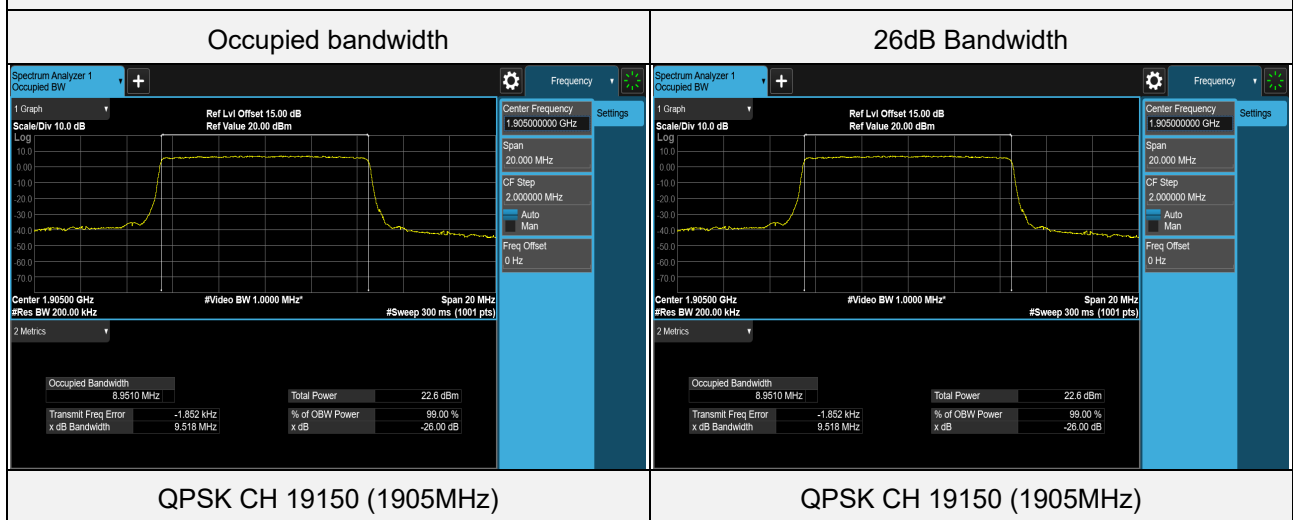

LTE Band 2 (Channel Bandwidth 15MHz)

Test Condition	Channel	Frequency (MHz)	Occupied bandwidth (MHz)	26dB Bandwidth (MHz)
QPSK	18675	1857.5	13.4322	14.212
QPSK	18900	1880	13.4098	14.212
QPSK	19125	1902.5	13.4206	14.214
16QAM	18675	1857.5	4.6686	5.319
16QAM	18900	1880	4.6650	5.348
16QAM	19125	1902.5	4.6673	5.360

Spectrum Plot of Worst Value

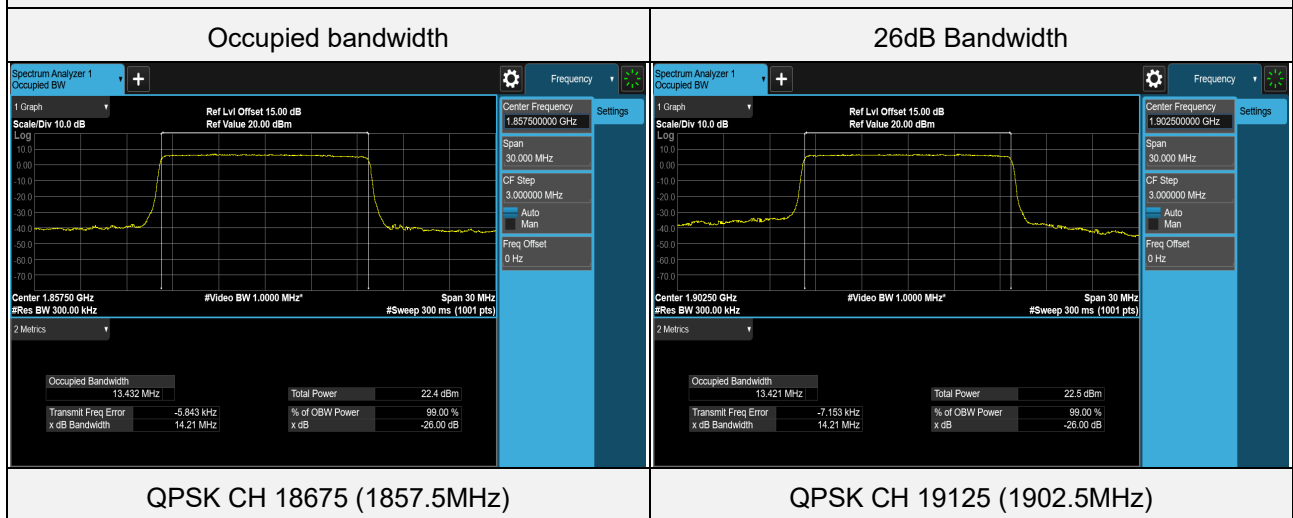

LTE Band 2 (Channel Bandwidth 20MHz)

Test Condition	Channel	Frequency (MHz)	Occupied bandwidth (MHz)	26dB Bandwidth (MHz)
QPSK	18700	1860	17.8829	19.002
QPSK	18900	1880	17.8525	18.996
QPSK	19100	1900	17.9101	18.995
16QAM	18700	1860	4.8045	5.579
16QAM	18900	1880	4.8053	5.579
16QAM	19100	1900	4.8203	5.607

Spectrum Plot of Worst Value

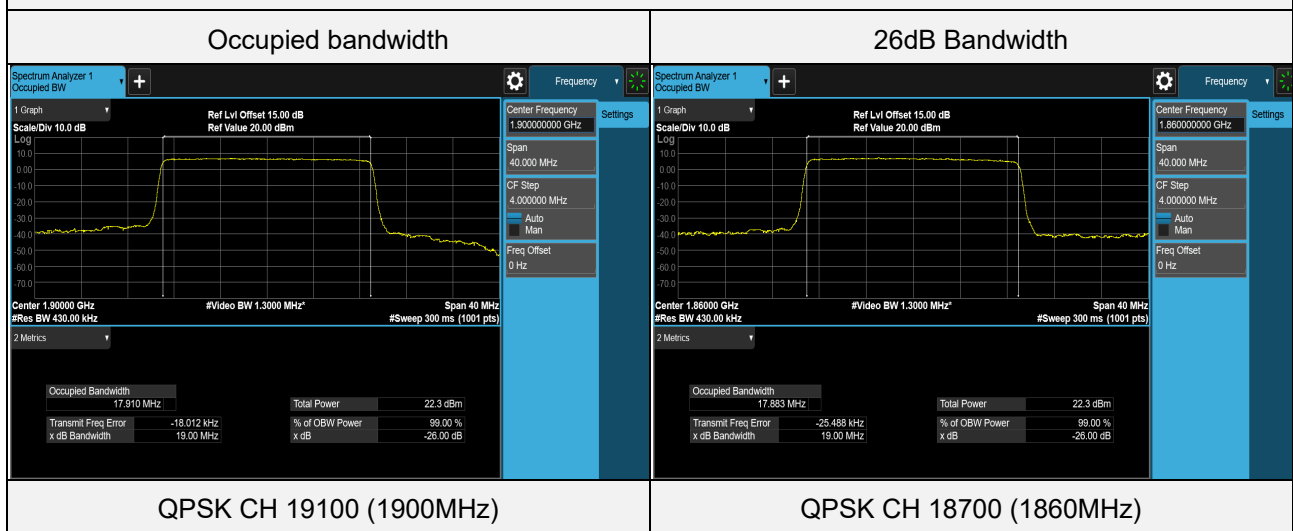

LTE Band 25 (Channel Bandwidth 1.4MHz)

Test Condition	Channel	Frequency (MHz)	Occupied bandwidth (MHz)	26dB Bandwidth (MHz)
QPSK	26047	1850.7	1.0893	1.255
QPSK	26365	1882.5	1.0925	1.259
QPSK	26683	1914.3	1.0903	1.258
16QAM	26047	1850.7	1.0882	1.250
16QAM	26365	1882.5	1.0880	1.243
16QAM	26683	1914.3	1.0884	1.244

Spectrum Plot of Worst Value

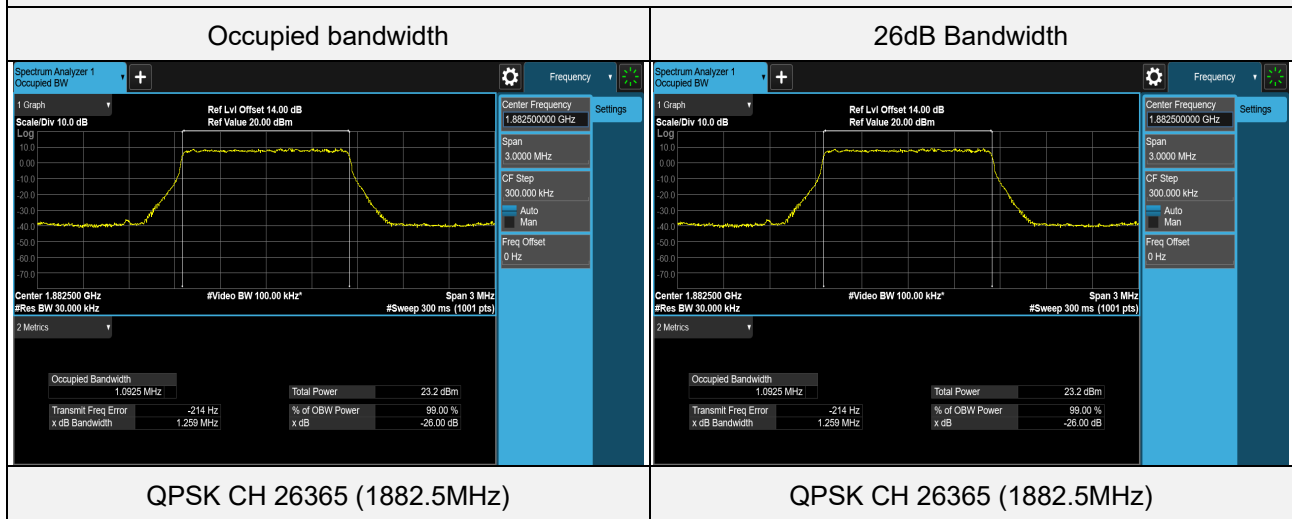

LTE Band 25 (Channel Bandwidth 3MHz)

Test Condition	Channel	Frequency (MHz)	Occupied bandwidth (MHz)	26dB Bandwidth (MHz)
QPSK	26055	1851.5	2.6983	2.918
QPSK	26365	1882.5	2.6984	2.911
QPSK	26675	1913.5	2.6959	2.915
16QAM	26055	1851.5	2.6977	2.918
16QAM	26365	1882.5	2.6984	2.924
16QAM	26675	1913.5	2.6969	2.914

Spectrum Plot of Worst Value

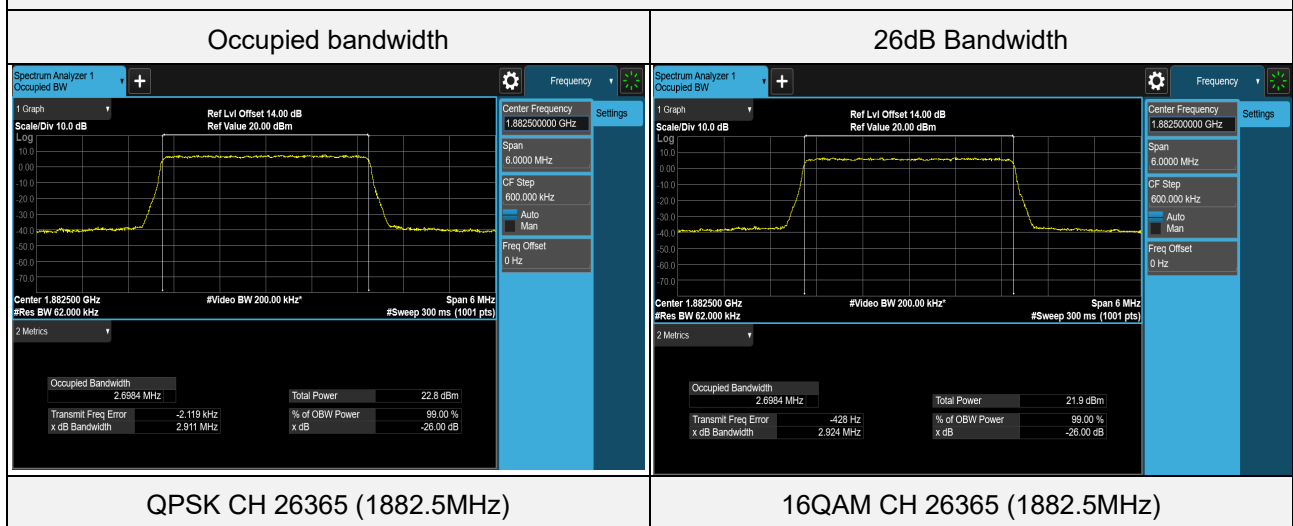

LTE Band 25 (Channel Bandwidth 5MHz)

Test Condition	Channel	Frequency (MHz)	Occupied bandwidth (MHz)	26dB Bandwidth (MHz)
QPSK	26065	1852.5	4.4940	4.823
QPSK	26365	1882.5	4.4948	4.826
QPSK	26665	1912.5	4.4916	4.802
16QAM	26065	1852.5	4.4906	4.819
16QAM	26365	1882.5	4.4892	4.812
16QAM	26665	1912.5	4.4865	4.803

Spectrum Plot of Worst Value

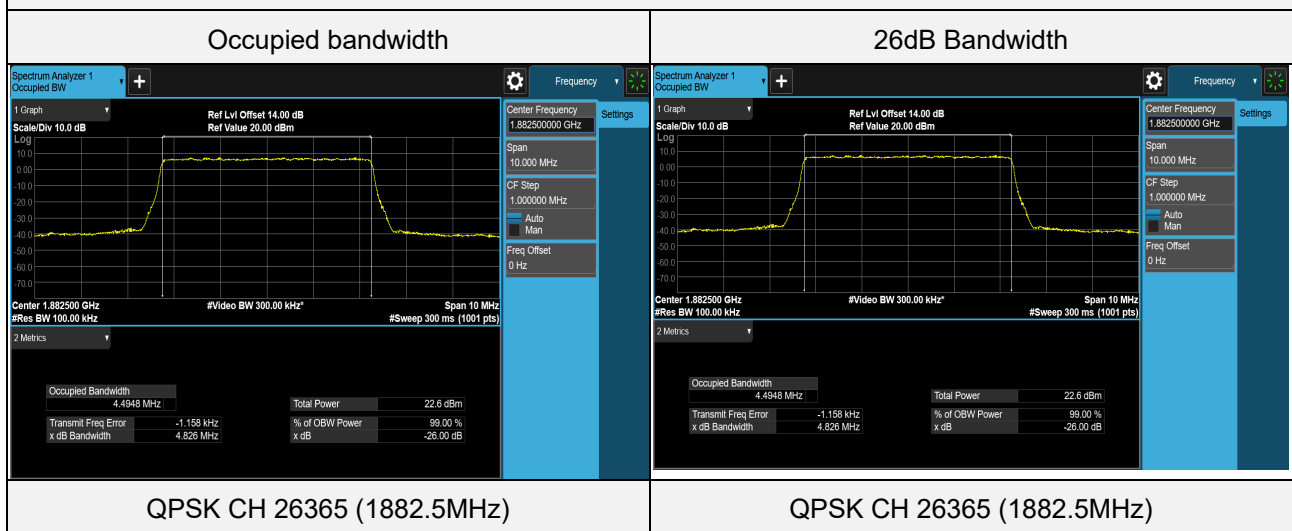

LTE Band 25 (Channel Bandwidth 10MHz)

Test Condition	Channel	Frequency (MHz)	Occupied bandwidth (MHz)	26dB Bandwidth (MHz)
QPSK	26090	1855	8.9534	9.516
QPSK	26365	1882.5	8.9498	9.487
QPSK	26615	1907.5	8.9311	9.488
16QAM	26090	1855	4.5648	5.107
16QAM	26365	1882.5	4.5649	5.070
16QAM	26615	1907.5	4.5636	5.054

Spectrum Plot of Worst Value

Occupied bandwidth

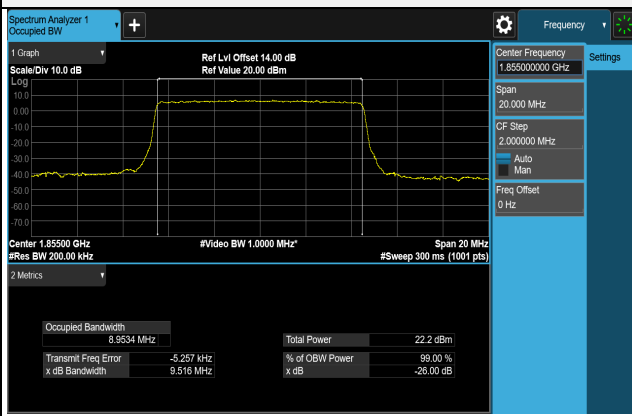

QPSK CH 26090 (1855MHz)

26dB Bandwidth

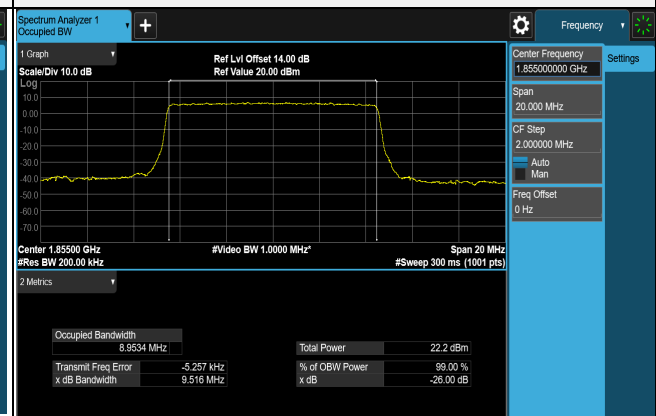

QPSK CH 26090 (1855MHz)

LTE Band 25 (Channel Bandwidth 15MHz)

Test Condition	Channel	Frequency (MHz)	Occupied bandwidth (MHz)	26dB Bandwidth (MHz)
QPSK	26115	1857.5	13.4090	14.216
QPSK	26365	1882.5	13.4184	14.206
QPSK	26615	1907.5	13.3719	14.185
16QAM	26115	1857.5	4.6670	5.360
16QAM	26365	1882.5	4.6728	5.322
16QAM	26615	1907.5	4.6658	5.334

Spectrum Plot of Worst Value

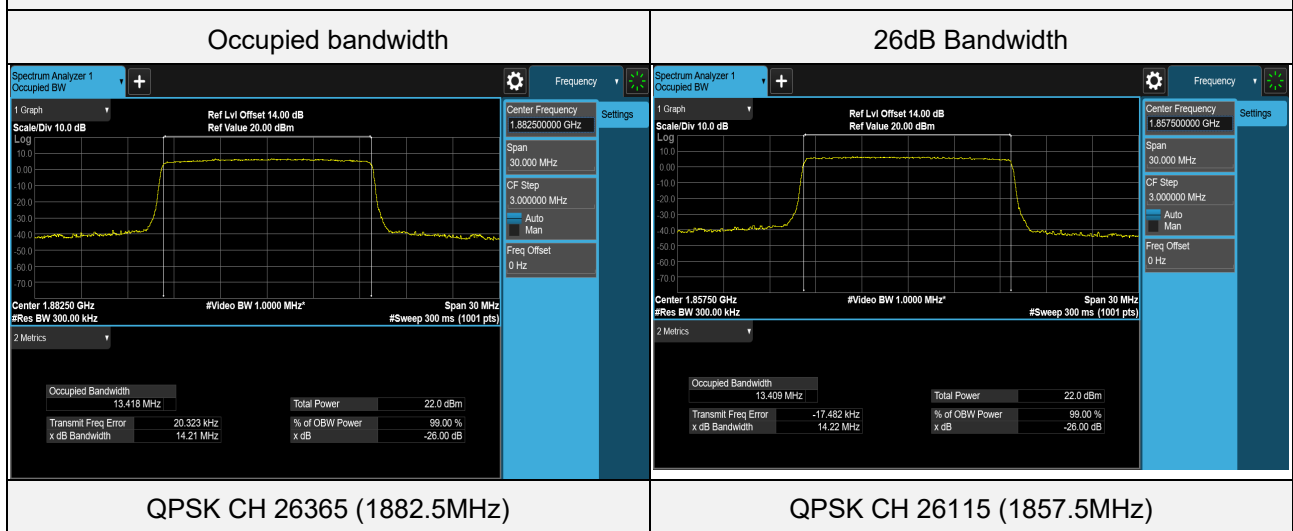

LTE Band 25 (Channel Bandwidth 20MHz)

Test Condition	Channel	Frequency (MHz)	Occupied bandwidth (MHz)	26dB Bandwidth (MHz)
QPSK	26140	1860	17.8878	19.007
QPSK	26365	1882.5	17.8461	18.976
QPSK	26590	1905	17.8237	18.970
16QAM	26140	1860	4.8090	5.579
16QAM	26365	1882.5	4.8111	5.598
16QAM	26590	1905	4.8146	5.566

Spectrum Plot of Worst Value

Occupied bandwidth

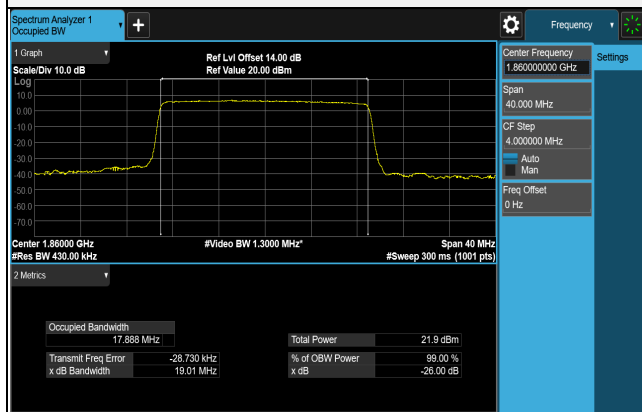

QPSK CH 26140 (1860MHz)

26dB Bandwidth

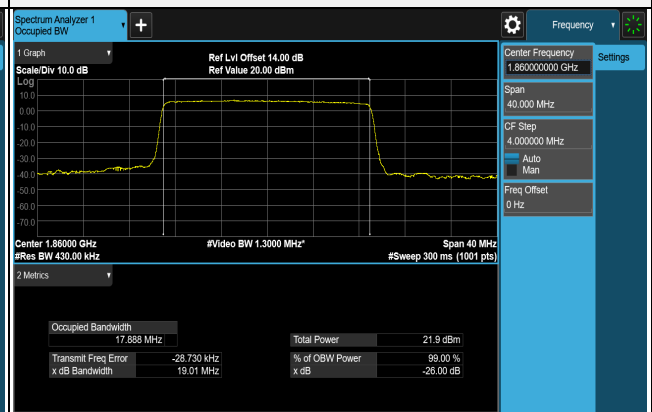

QPSK CH 26140 (1860MHz)

4.5 Band Edge Measurement

4.5.1 Limits of Band Edge Measurement

Power of any emission outside of the authorized operating frequency ranges must be attenuated below the transmitting power (P) by a factor of at least $43 + 10 \log(P)$ dB. In the 1 MHz bands immediately outside and adjacent to the frequency block a resolution bandwidth of at least one percent of the emission bandwidth of the fundamental emission of the transmitter may be employed.

4.5.2 Test Setup

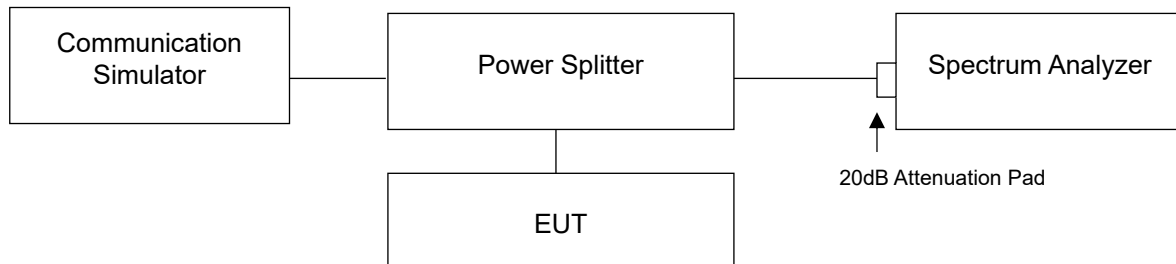

4.5.3 Test Procedures

- a. All measurements were done at low and high operational frequency range.
- b. The center frequency of spectrum is the band edge frequency and span is 2MHz. RB of the spectrum is 10kHz and VB of the spectrum is 30kHz (GPRS / EDGE).
- c. The center frequency of spectrum is the band edge frequency and span is 2MHz. RB of the spectrum is 51kHz and VB of the spectrum is 160kHz (WCDMA / HSDPA / HSUPA).
- d. The center frequency of spectrum is the band edge frequency and span is 1MHz. RB of the spectrum is 15kHz and VB of the spectrum is 51kHz (LTE Channel Bandwidth 1.4MHz).
- e. The center frequency of spectrum is the band edge frequency and span is 1MHz. RB of the spectrum is 30kHz and VB of the spectrum is 100kHz (LTE Channel Bandwidth 3MHz).
- f. The center frequency of spectrum is the band edge frequency and span is 1MHz. RB of the spectrum is 51kHz and VB of the spectrum is 160kHz (LTE Channel Bandwidth 5MHz).
- g. The center frequency of spectrum is the band edge frequency and span is 1MHz. RB of the spectrum is 100kHz and VB of the spectrum is 300kHz (LTE Channel Bandwidth 10MHz).
- h. The center frequency of spectrum is the band edge frequency and span is 1MHz. RB of the spectrum is 150kHz and VB of the spectrum is 470kHz (LTE Channel Bandwidth 15MHz).
- i. The center frequency of spectrum is the band edge frequency and span is 1MHz. RB of the spectrum is 200kHz and VB of the spectrum is 1MHz (LTE Channel Bandwidth 20MHz).
- j. Record the max trace plot into the test report.

4.5.4 Test Results

GPRS



EDGE

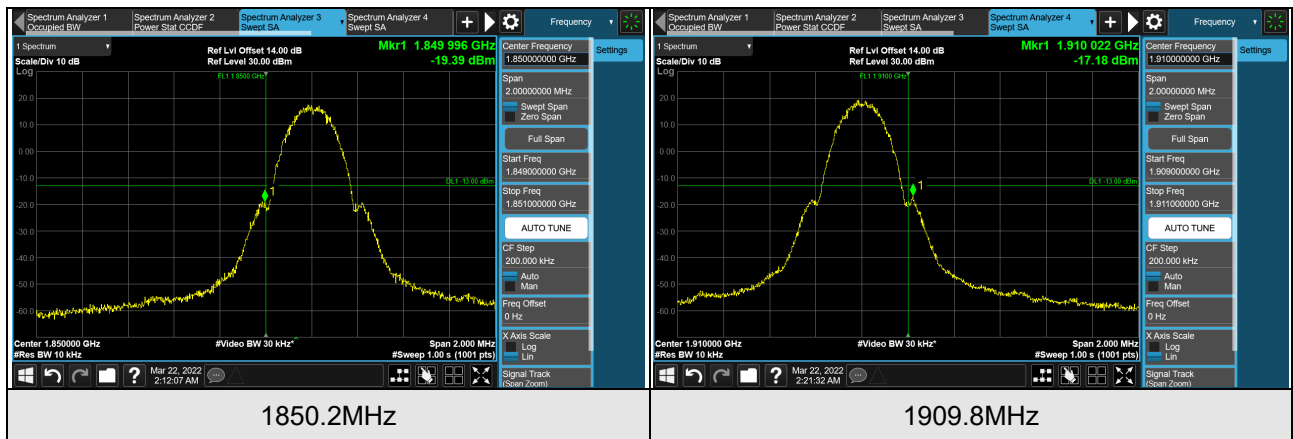

WCDMA Band 2

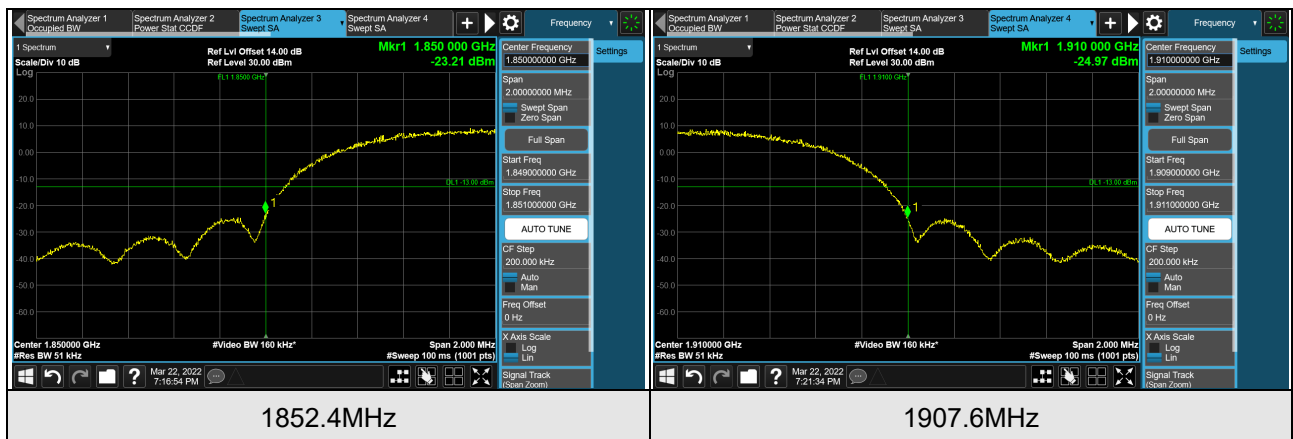

HSDPA



HSUPA

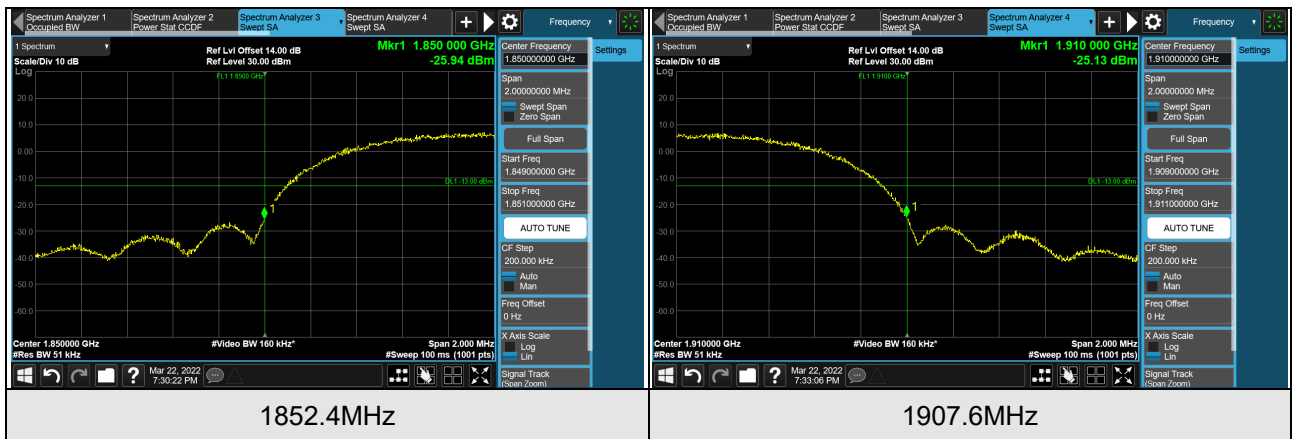

LTE Band 2 (Channel Bandwidth 1.4MHz)

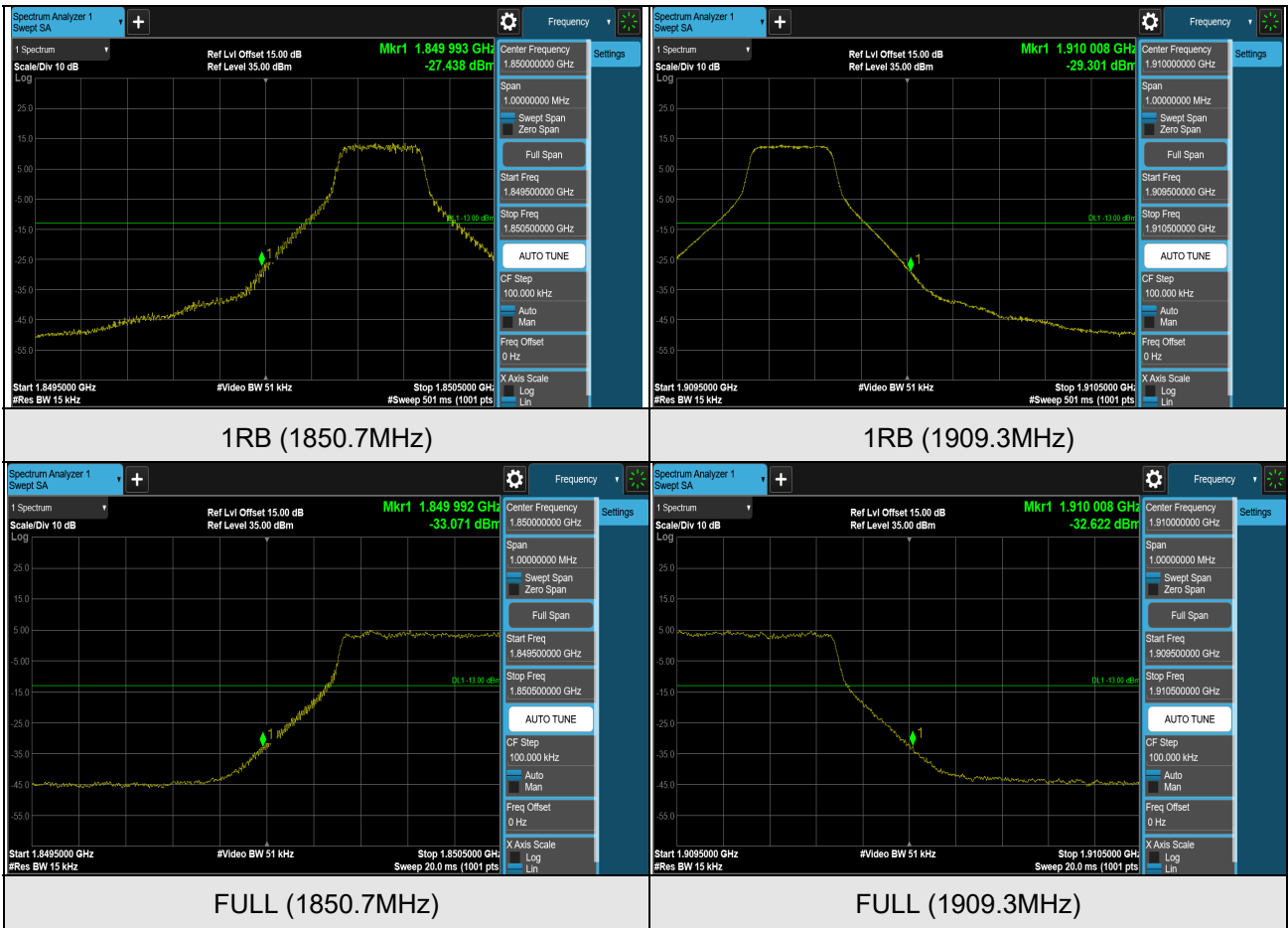

LTE Band 2 (Channel Bandwidth 3MHz)

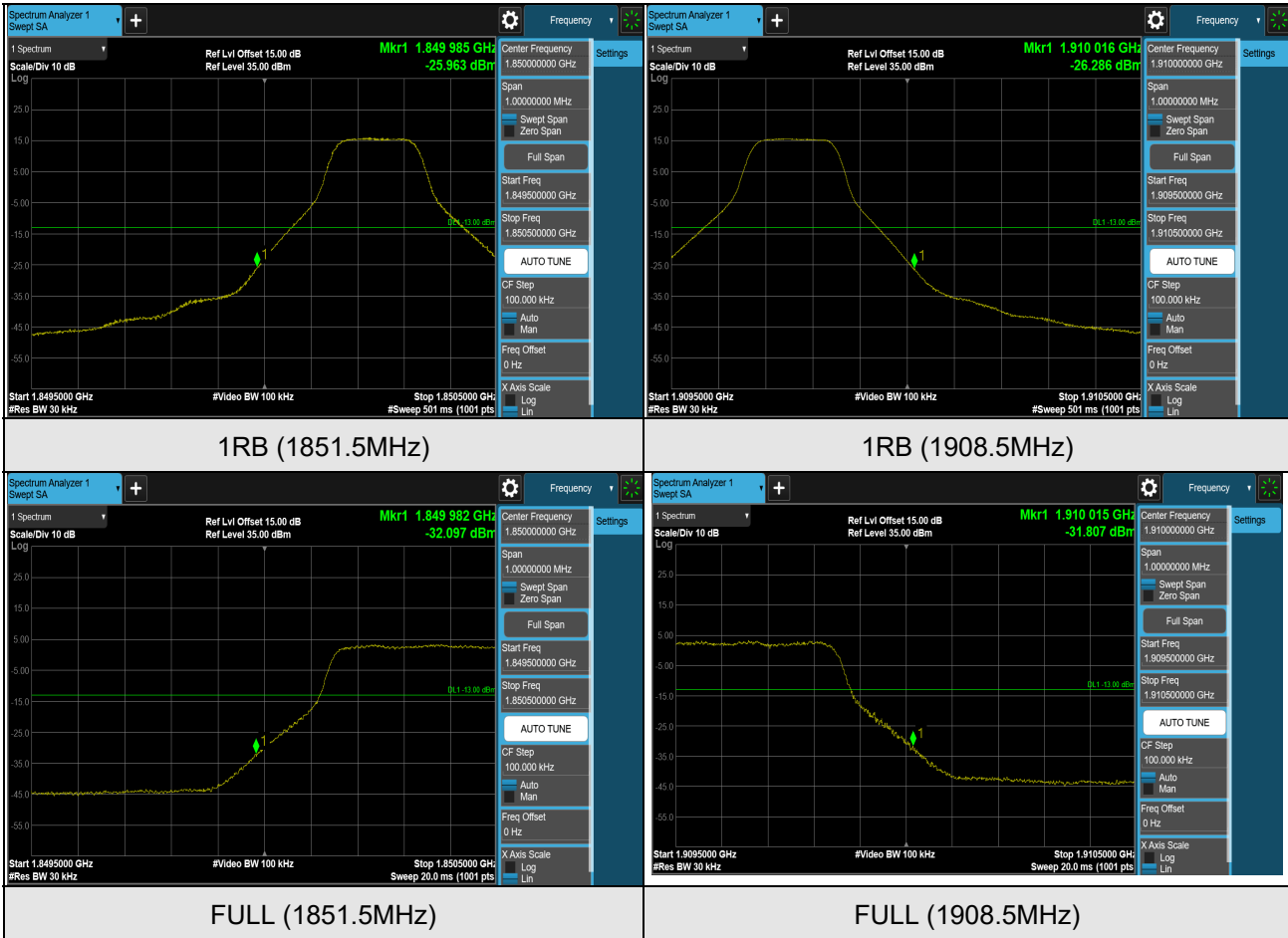

LTE Band 2 (Channel Bandwidth 5MHz)

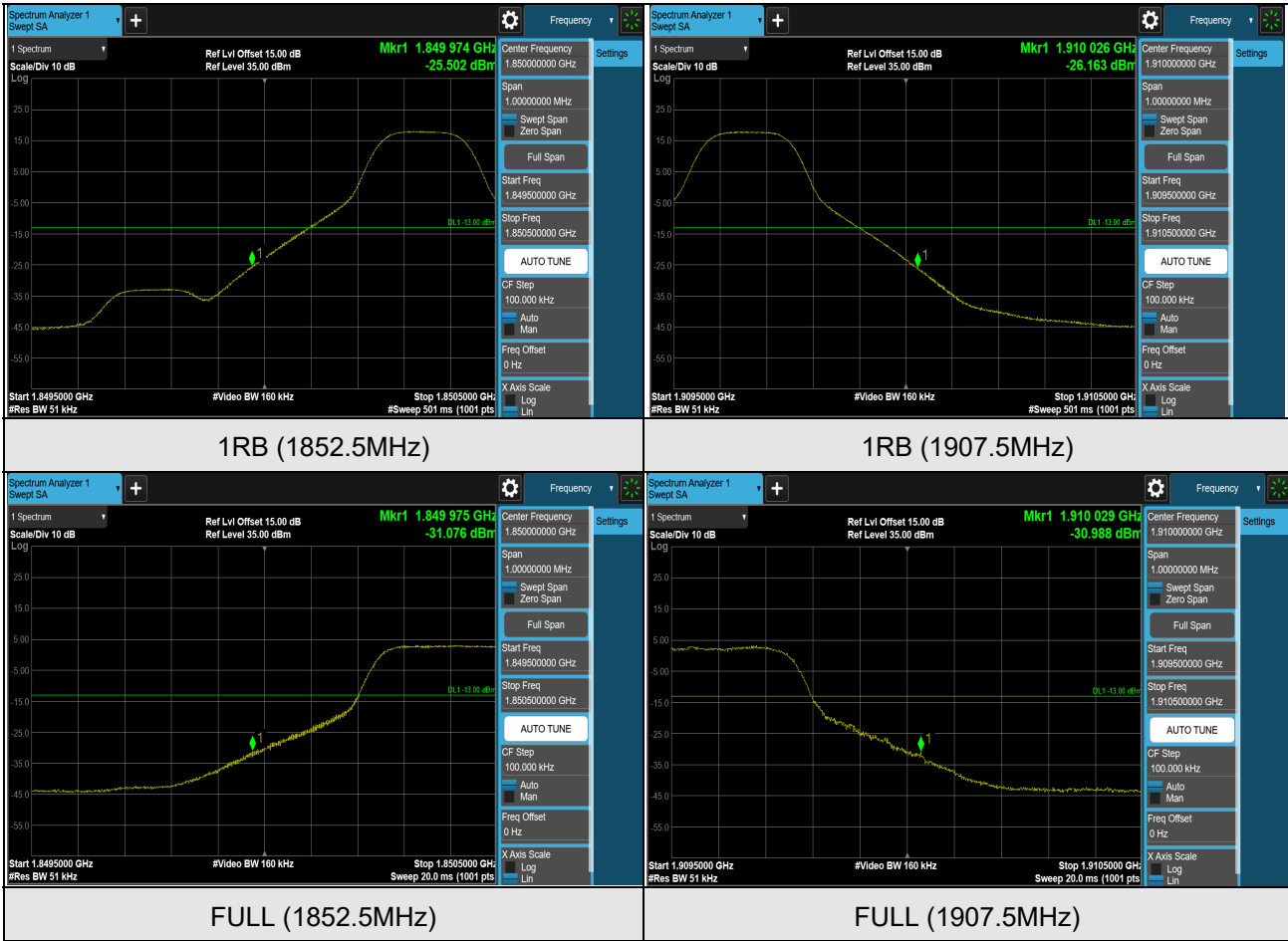

LTE Band 2 (Channel Bandwidth 10MHz)

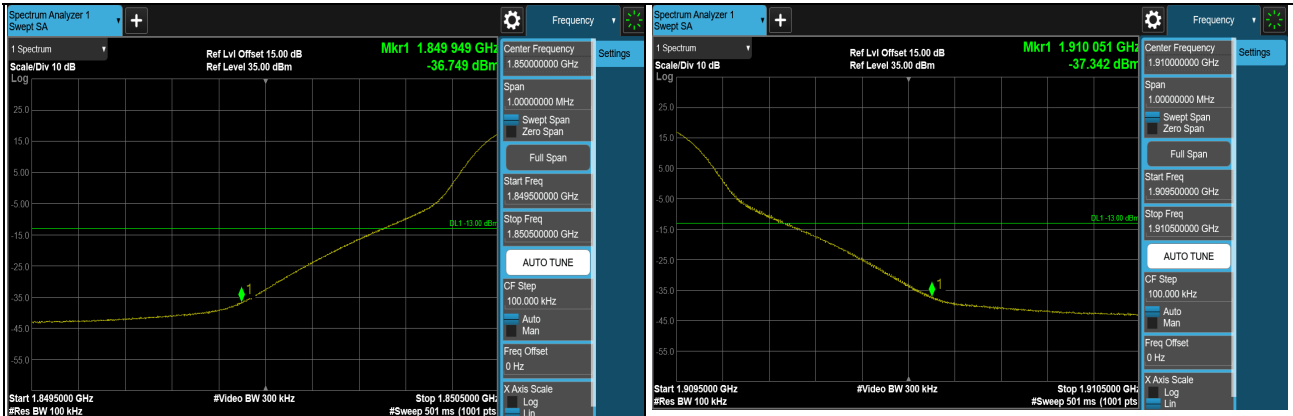

1RB (1855MHz)

1RB (1905MHz)

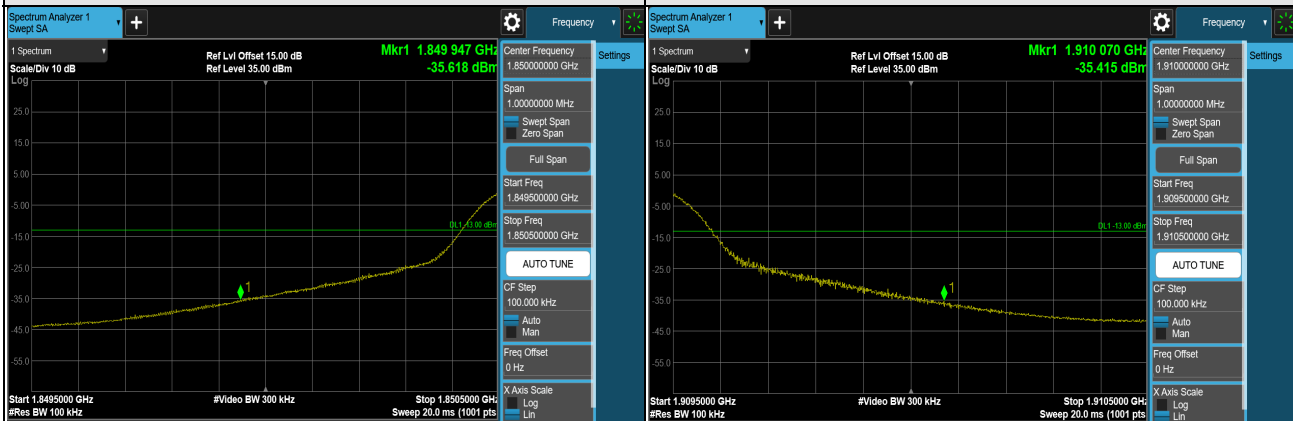

FULL (1855MHz)

FULL (1905MHz)

LTE Band 2 (Channel Bandwidth 15MHz)

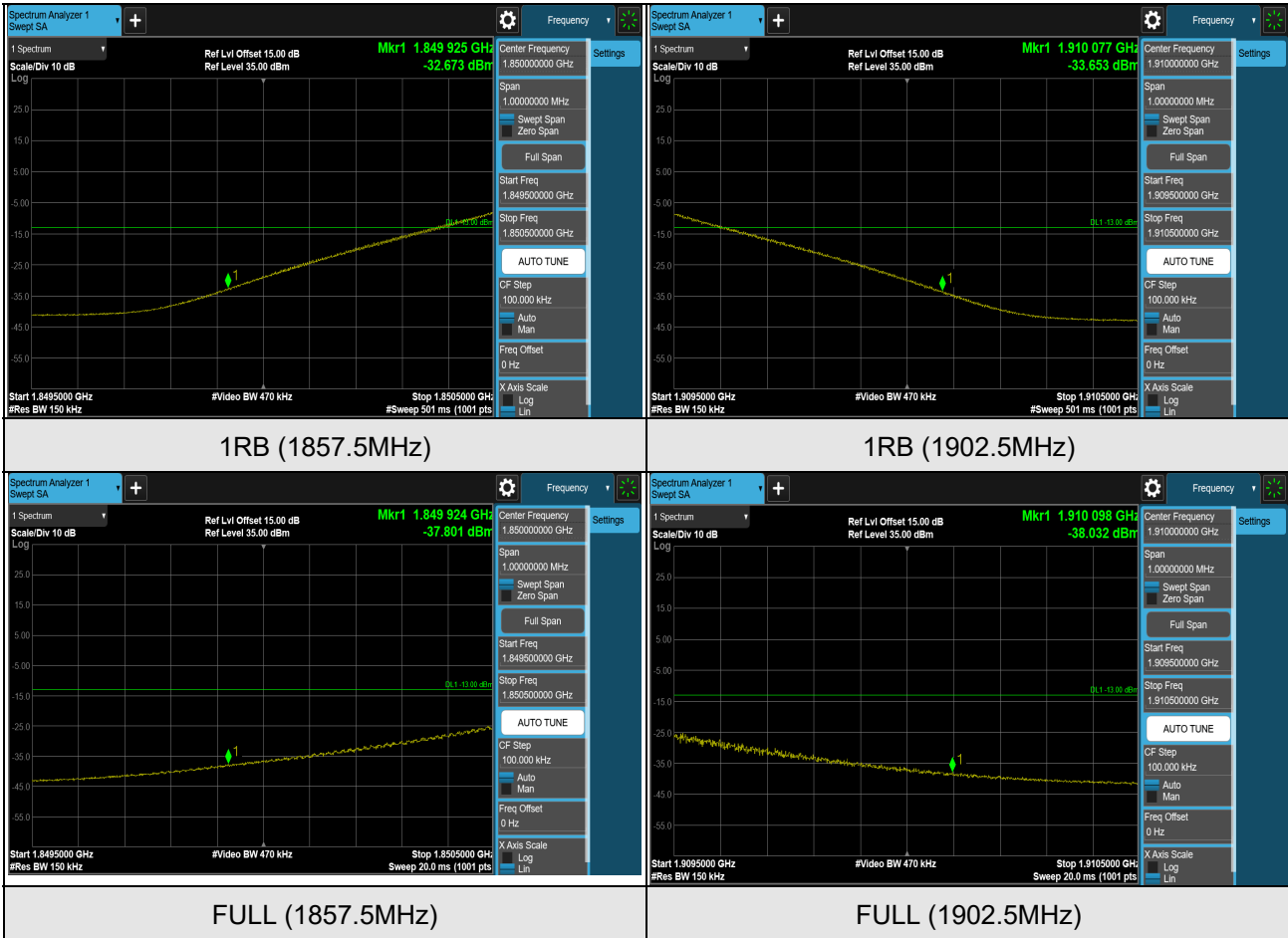

LTE Band 2 (Channel Bandwidth 20MHz)

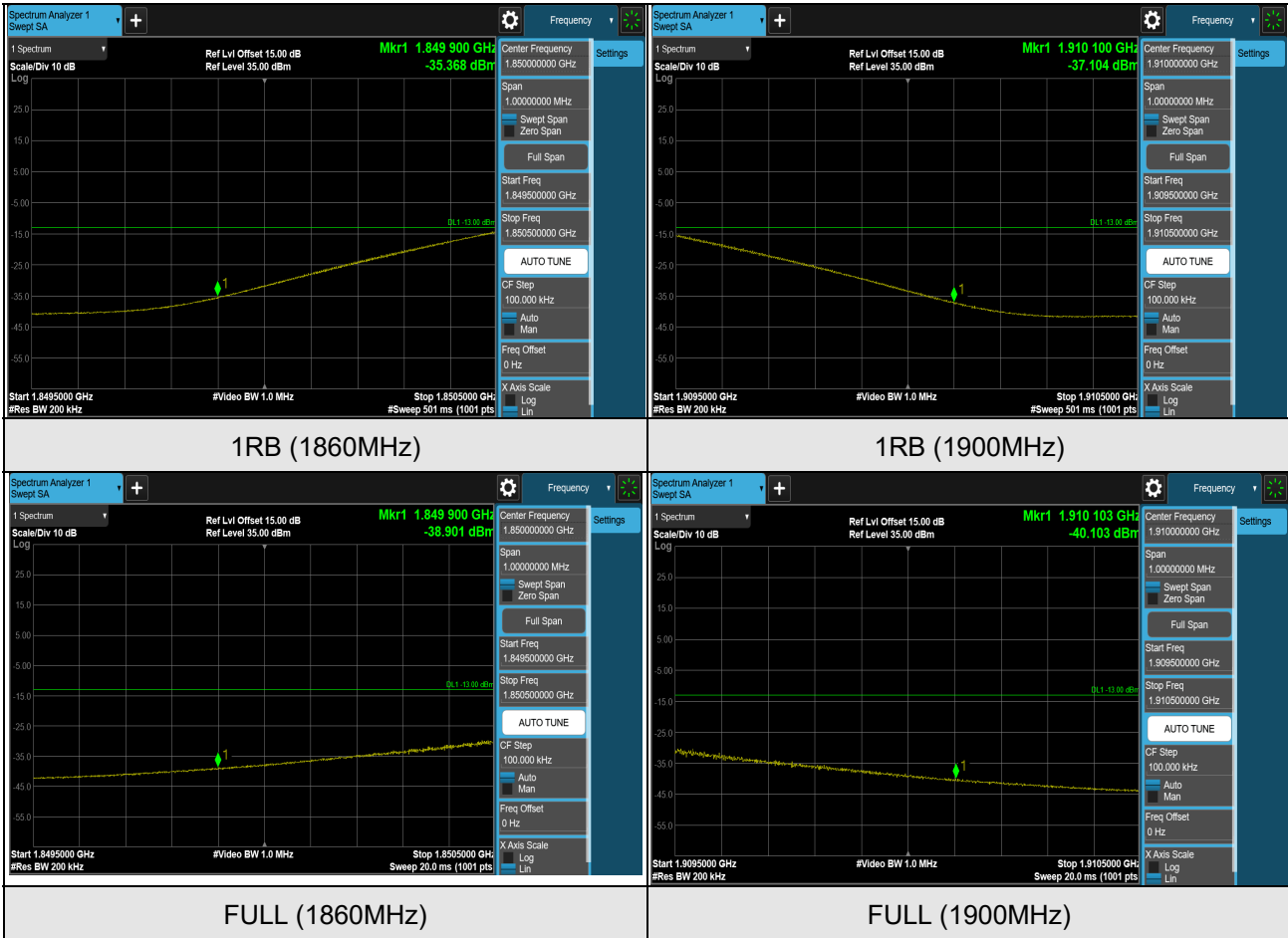

LTE Band 25 (Channel Bandwidth 1.4MHz)

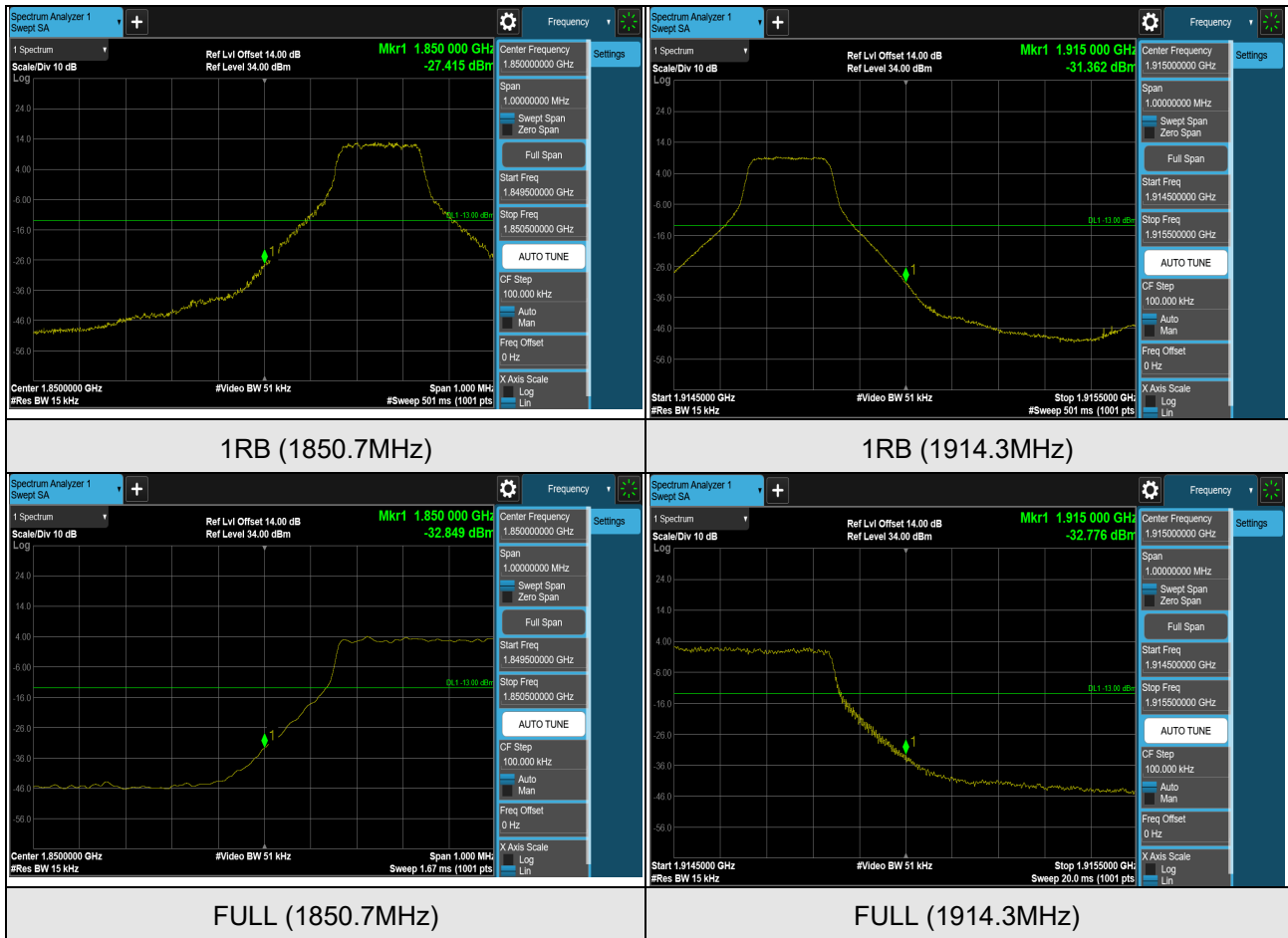

LTE Band 25 (Channel Bandwidth 3MHz)

