

FCC Test Report

Report No.: RF190604C03-4

FCC ID: B32CM5PW

Test Model: CM5PW

Received Date: Jun. 04, 2019

Test Date: Jun. 20 ~ Jun. 25, 2019

Issued Date: Jul. 09, 2019

Applicant: Verifone, Inc.

Address: 1400 West Stanford Ranch Road Suite 200 Rocklin CA 95765 USA

Issued By: Bureau Veritas Consumer Products Services (H.K.) Ltd., Taoyuan Branch

Lab Address: No. 47-2, 14th Ling, Chia Pau Vil., Lin Kou Dist., New Taipei City, Taiwan (R.O.C)

Test Location (1): No. 19, Hwa Ya 2nd Rd, Wen Hwa Tsuen, Kwei Shan Hsiang, Taoyuan Hsien 333, Taiwan, R.O.C.

Test Location (2): B2F., No.215, Sec. 3, Beixin Rd., Xindian Dist., New Taipei City 231, Taiwan, R.O.C

**FCC Registration /
Designation Number:** 427177 / TW0011



This report is for your exclusive use. Any copying or replication of this report to or for any other person or entity, or use of our name or trademark, is permitted only with our prior written permission. This report sets forth our findings solely with respect to the test samples identified herein. The results set forth in this report are not indicative or representative of the quality or characteristics of the lot from which a test sample was taken or any similar or identical product unless specifically and expressly noted. Our report includes all of the tests requested by you and the results thereof based upon the information that you provided to us. You have 60 days from date of issuance of this report to notify us of any material error or omission caused by our negligence, provided, however, that such notice shall be in writing and shall specifically address the issue you wish to raise. A failure to raise such issue within the prescribed time shall constitute your unqualified acceptance of the completeness of this report, the tests conducted and the correctness of the report contents. Unless specific mention, the uncertainty of measurement has been explicitly taken into account to declare the compliance or non-compliance to the specification. The report must not be used by the client to claim product certification, approval, or endorsement by TAF or any government agencies.

Table of Contents

Release Control Record	4
1 Certificate of Conformity	5
2 Summary of Test Results	6
2.1 Measurement Uncertainty.....	6
2.2 Modification Record	6
3 General Information	7
3.1 General Description of EUT	7
3.2 Description of Test Modes.....	8
3.2.1 Test Mode Applicability and Tested Channel Detail.....	10
3.3 Duty Cycle of Test Signal	12
3.4 Description of Support Units	13
3.4.1 Configuration of System under Test	13
3.5 General Description of Applied Standards.....	13
4 Test Types and Results	14
4.1 Radiated Emission and Bandedge Measurement	14
4.1.1 Limits of Radiated Emission and Bandedge Measurement	14
4.1.2 Limits of Unwanted Emission Out of the Restricted Bands	15
4.1.3 Test Instruments	16
4.1.4 Test Procedures.....	17
4.1.5 Deviation from Test Standard	18
4.1.6 Test Setup.....	18
4.1.7 EUT Operating Conditions.....	19
4.1.8 Test Results	20
4.2 Conducted Emission Measurement.....	55
4.2.1 Limits of Conducted Emission Measurement	55
4.2.2 Test Instruments	55
4.2.3 Test Procedures.....	56
4.2.4 Deviation from Test Standard	56
4.2.5 Test Setup.....	56
4.2.6 EUT Operating Conditions.....	56
4.2.7 Test Results	57
4.3 Transmit Power Measurement.....	59
4.3.1 Limits of Transmit Power Measurement	59
4.3.2 Test Setup.....	59
4.3.3 Test Instruments	60
4.3.4 Test Procedure	60
4.3.5 Deviation from Test Standard	60
4.3.6 EUT Operating Conditions.....	60
4.3.7 Test Results	61
4.4 Occupied Bandwidth Measurement.....	66
4.4.1 Test Setup.....	66
4.4.2 Test Instruments	66
4.4.3 Test Procedure	66
4.4.4 Test Results	67
4.5 Peak Power Spectral Density Measurement	69
4.5.1 Limits of Peak Power Spectral Density Measurement	69
4.5.2 Test Setup.....	69
4.5.3 Test Instruments	69
4.5.4 Test Procedures.....	70
4.5.5 Deviation from Test Standard	70
4.5.6 EUT Operating Conditions.....	70
4.5.7 Test Results	71
4.6 Frequency Stability	75

4.6.1	Limit of Frequency Stability Measurement	75
4.6.2	Test Setup	75
4.6.3	Test Instruments	75
4.6.4	Test Procedure	75
4.6.5	Deviation from Test Standard	75
4.6.6	EUT Operating Condition	75
4.6.7	Test Results	76
4.7	6 dB Bandwidth Measurement.....	77
4.7.1	Limits of 6 dB Bandwidth Measurement.....	77
4.7.2	Test Setup.....	77
4.7.3	Test Instruments	77
4.7.4	Test Procedure	77
4.7.5	Deviation from Test Standard	77
4.7.6	EUT Operating Condition	77
4.7.7	Test Results	78
5	Pictures of Test Arrangements.....	80
	Annex A- Radiated Out of Band Emission (OOBE) Measurement (For U-NII-3 band)	81
	Appendix – Information of the Testing Laboratories	84

Release Control Record

Issue No.	Description	Date Issued
RF190604C03-4	Original Release	Jul. 09, 2019

1 Certificate of Conformity

Product: Point of Sale Terminal

Brand: Verifone

Test Model: CM5PW

Sample Status: Identical Prototype

Applicant: Verifone, Inc.

Test Date: Jun. 20 ~ Jun. 25, 2019

Standards: 47 CFR FCC Part 15, Subpart E (Section 15.407)
ANSI C63.10:2013

The above equipment has been tested by **Bureau Veritas Consumer Products Services (H.K.) Ltd., Taoyuan Branch**, and found compliance with the requirement of the above standards. The test record, data evaluation & Equipment Under Test (EUT) configurations represented herein are true and accurate accounts of the measurements of the sample's RF characteristics under the conditions specified in this report.

Prepared by :  , **Date:** Jul. 09, 2019
Ivonne Wu / Supervisor

Approved by :  , **Date:** Jul. 09, 2019
Dylan Chiou / Project Engineer

2 Summary of Test Results

47 CFR FCC Part 15, Subpart E (Section 15.407)			
FCC Clause	Test Item	Result	Remarks
15.407(b)(6)	AC Power Conducted Emissions	Pass	Meet the requirement of limit. Minimum passing margin is -9.69 dB at 2.18711 MHz.
15.407(b) (1/2/3/4(i/ii)/6)	Radiated Emissions & Band Edge Measurement	Pass	Meet the requirement of limit. Minimum passing margin is -3.11 dB at 5148.95 MHz.
15.407(a)(1/2/3)	Max Average Transmit Power	Pass	Meet the requirement of limit.
---	Occupied Bandwidth Measurement	-	Reference only
15.407(a)(1/2/3)	Peak Power Spectral Density	Pass	Meet the requirement of limit.
15.407(e)	6 dB Bandwidth	Pass	Meet the requirement of limit. (U-NII-3 Band only)
15.407(g)	Frequency Stability	Pass	Meet the requirement of limit.
15.203	Antenna Requirement	Pass	No antenna connector is used.

Note:

- For U-NII-3 band compliance with rule part 15.407(b)(4)(i), the OOB test plots were recorded in Annex A.
- Determining compliance based on the results of the compliance measurement, not taking into account measurement instrumentation uncertainty.

2.1 Measurement Uncertainty

Where relevant, the following measurement uncertainty levels have been estimated for tests performed on the EUT as specified in CISPR 16-4-2:

Measurement	Frequency	Expanded Uncertainty (k=2) (±)
Conducted Emissions at mains ports	150 kHz ~ 30 MHz	2.44 dB
Radiated Emissions up to 1 GHz	9 kHz ~ 30 MHz	3.04 dB
	30 MHz ~ 200 MHz	2.0153 dB
	200 MHz ~ 1000 MHz	2.0224 dB
Radiated Emissions above 1 GHz	1 GHz ~ 18 GHz	1.0121 dB
	18 GHz ~ 40 GHz	1.1508 dB

2.2 Modification Record

There were no modifications required for compliance.

3 General Information

3.1 General Description of EUT

Product	Point of Sale Terminal
Brand	Verifone
Test Model	CM5PW
Status of EUT	Identical Prototype
Power Supply Rating	5.0 Vdc (adapter or host equipment) 3.7 Vdc (battery)
Modulation Type	64QAM, 16QAM, QPSK, BPSK
Modulation Technology	OFDM
Transfer Rate	802.11a: 54.0/ 48.0/ 36.0/ 24.0/ 18.0/ 12.0/ 9.0/ 6.0 Mbps 802.11n: up to 150.0 Mbps
Operating Frequency	5180 ~ 5240 MHz, 5260 ~ 5320 MHz, 5500 ~ 5700 MHz, 5745 ~ 5825 MHz
Number of Channel	5180 ~ 5240 MHz: 4 for 802.11a, 802.11n (HT20) 2 for 802.11n (HT40) 5260 ~ 5320 MHz: 4 for 802.11a, 802.11n (HT20) 2 for 802.11n (HT40) 5500 ~ 5700 MHz: 11 for 802.11a, 802.11n (HT20) 5 for 802.11n (HT40) 5745 ~ 5825 MHz: 5 for 802.11a, 802.11n (HT20) 2 for 802.11n (HT40)
Output Power	14.689 mW for 5180 ~ 5240 MHz 15.524 mW for 5260 ~ 5320 MHz 14.223 mW for 5500 ~ 5700 MHz 12.618 mW for 5745 ~ 5825 MHz
Antenna Type	Fixed Internal antenna with 2.6 dBi gain
Antenna Connector	N/A
Accessory Device	Refer to Note as below
Data Cable Supplied	Refer to Note as below

Note:

1. The EUT provides one transmitter and receiver.

Modulation Mode	Tx Function
802.11a	1TX
802.11n (HT20)	1TX
802.11n (HT40)	1TX

2. The EUT's accessories list refers to Ext. Pho.
3. The above EUT information is declared by manufacturer and for more detailed features description, please refers to the manufacturer's specifications or user's manual.

3.2 Description of Test Modes

For 5180 ~ 5240 MHz

4 channels are provided for 802.11a, 802.11n (HT20):

Channel	Frequency (MHz)	Channel	Frequency (MHz)
36	5180	44	5220
40	5200	48	5240

2 channels are provided for 802.11n (HT40):

Channel	Frequency (MHz)	Channel	Frequency (MHz)
38	5190	46	5230

For 5260 ~ 5320 MHz

4 channels are provided for 802.11a, 802.11n (HT20):

Channel	Frequency (MHz)	Channel	Frequency (MHz)
52	5260	60	5300
56	5280	64	5320

2 channels are provided for 802.11n (HT40):

Channel	Frequency (MHz)	Channel	Frequency (MHz)
54	5270	62	5310

For 5500 ~ 5700 MHz

11 channels are provided for 802.11a, 802.11n (HT20):

Channel	Frequency (MHz)	Channel	Frequency (MHz)
100	5500	124	5620
104	5520	128	5640
108	5540	132	5660
112	5560	136	5680
116	5580	140	5700
120	5600		

5 channels are provided for 802.11n (HT40):

Channel	Frequency (MHz)	Channel	Frequency (MHz)
102	5510	126	5630
110	5550	134	5670
118	5590		

For 5745 ~ 5825 MHz:

5 channels are provided for 802.11a, 802.11n (HT20):

Channel	Frequency (MHz)	Channel	Frequency (MHz)
149	5745	161	5805
153	5765	165	5825
157	5785		

2 channels are provided for 802.11n (HT40):

Channel	Frequency (MHz)	Channel	Frequency (MHz)
151	5755	159	5795

3.2.1 Test Mode Applicability and Tested Channel Detail

EUT Configure Mode	Applicable To				Description
	RE \geq 1G	RE $<$ 1G	PLC	APCM	
-	√	√	√	√	-

Where **RE \geq 1G**: Radiated Emission above 1 GHz **RE $<$ 1G**: Radiated Emission below 1 GHz
PLC: Power Line Conducted Emission **APCM**: Antenna Port Conducted Measurement

Note:

- The EUT had been pre-tested on the positioned of each 3 axis. The worst case was found when positioned on **Y-plane** for 5180-5240 MHz & 5260-5320 MHz and **X-plane** for 5500-5700 MHz & 5745-5825 MHz.
- "-" means no effect.

Radiated Emission Test (Above 1 GHz):

- Pre-Scan has been conducted to determine the worst-case mode from all possible combinations between available modulations, data rates and antenna ports (if EUT with antenna diversity architecture).
- Following channel(s) was (were) selected for the final test as listed below.

EUT Configure Mode	Frequency Band (MHz)	Mode	Available Channel	Tested Channel	Modulation Technology	Modulation Type	Data Rate (Mbps)	
-	5180-5240	802.11a	36 to 48	36, 40, 48	OFDM	BPSK	6.0	
-		802.11n (HT20)	36 to 48	36, 40, 48	OFDM	BPSK	6.5	
-		802.11n (HT40)	38 to 46	38, 46	38, 46	OFDM	BPSK	13.5
-	5260-5320	802.11a	52 to 64	52, 60, 64	OFDM	BPSK	6.0	
-		802.11n (HT20)	52 to 64	52, 60, 64	OFDM	BPSK	6.5	
-		802.11n (HT40)	54 to 62	54, 62	54, 62	OFDM	BPSK	13.5
-	5500-5700	802.11a	100 to 140	100, 116, 140	OFDM	BPSK	6.0	
-		802.11n (HT20)	100 to 140	100, 116, 140	OFDM	BPSK	6.5	
-		802.11n (HT40)	102 to 134	102, 110, 134	102, 110, 134	OFDM	BPSK	13.5
-	5745-5825	802.11a	149 to 165	149, 157, 165	OFDM	BPSK	6.0	
-		802.11n (HT20)	149 to 165	149, 157, 165	149, 157, 165	OFDM	BPSK	6.5
-		802.11n (HT40)	151 to 159	151, 159	151, 159	OFDM	BPSK	13.5

Radiated Emission Test (Below 1 GHz):

- Pre-Scan has been conducted to determine the worst-case mode from all possible combinations between available modulations, data rates and antenna ports (if EUT with antenna diversity architecture).
- Following channel(s) was (were) selected for the final test as listed below.

EUT Configure Mode	Frequency Band (MHz)	Mode	Available Channel	Tested Channel	Modulation Technology	Modulation Type	Data Rate (Mbps)
-	5180-5240	802.11n (HT40)	38 to 46	38	OFDM	BPSK	13.5

Power Line Conducted Emission Test:

- Pre-Scan has been conducted to determine the worst-case mode from all possible combinations between available modulations, data rates and antenna ports (if EUT with antenna diversity architecture).
- Following channel(s) was (were) selected for the final test as listed below.

EUT Configure Mode	Frequency Band (MHz)	Mode	Available Channel	Tested Channel	Modulation Technology	Modulation Type	Data Rate (Mbps)
-	5180-5240	802.11n (HT40)	38 to 46	38	OFDM	BPSK	13.5

Antenna Port Conducted Measurement:

- This item includes all test value of each mode, but only includes spectrum plot of worst value of each mode.
- Pre-Scan has been conducted to determine the worst-case mode from all possible combinations between available modulations, data rates and antenna ports (if EUT with antenna diversity architecture).
- Following channel(s) was (were) selected for the final test as listed below.

EUT Configure Mode	Frequency Band (MHz)	Mode	Available Channel	Tested Channel	Modulation Technology	Modulation Type	Data Rate (Mbps)
-	5180-5240	802.11a	36 to 48	36, 40, 48	OFDM	BPSK	6.0
-		802.11n (HT20)	36 to 48	36, 40, 48	OFDM	BPSK	6.5
-		802.11n (HT40)	38 to 46	38, 46	OFDM	BPSK	13.5
-	5260-5320	802.11a	52 to 64	52, 60, 64	OFDM	BPSK	6.0
-		802.11n (HT20)	52 to 64	52, 60, 64	OFDM	BPSK	6.5
-		802.11n (HT40)	54 to 62	54, 62	OFDM	BPSK	13.5
-	5500-5700	802.11a	100 to 140	100, 116, 140	OFDM	BPSK	6.0
-		802.11n (HT20)	100 to 140	100, 116, 140	OFDM	BPSK	6.5
-		802.11n (HT40)	102 to 134	102, 110, 134	OFDM	BPSK	13.5
-	5745-5825	802.11a	149 to 165	149, 157, 165	OFDM	BPSK	6.0
-		802.11n (HT20)	149 to 165	149, 157, 165	OFDM	BPSK	6.5
-		802.11n (HT40)	151 to 159	151, 159	OFDM	BPSK	13.5

Test Condition:

Applicable To	Environmental Conditions	Input Power	Tested by
RE \geq 1G	25 deg. C, 65 % RH	120 Vac, 60 Hz	Karl Lee
RE<1G	25 deg. C, 65 % RH	120 Vac, 60 Hz	Karl Lee
PLC	25 deg. C, 65 % RH	120 Vac, 60 Hz	Thomas Wei
APCM	25 deg. C, 65 % RH	3.7 Vdc	Wayne Lin

3.3 Duty Cycle of Test Signal

MODULATION TYPE: BPSK

Duty cycle of test signal is < 98 %, duty factor is required.

802.11a: Duty cycle = $1.362/1.596 = 0.853$, Duty factor = $10 * \log(1/0.853) = 0.69$

802.11n (HT20): Duty cycle = $1.263/1.485 = 0.851$, Duty factor = $10 * \log(1/0.851) = 0.70$

802.11n (HT40): Duty cycle = $0.63/0.84 = 0.750$, Duty factor = $10 * \log(1/0.750) = 1.25$



3.4 Description of Support Units

The EUT has been tested as an independent unit together with other necessary accessories or support units.

3.4.1 Configuration of System under Test

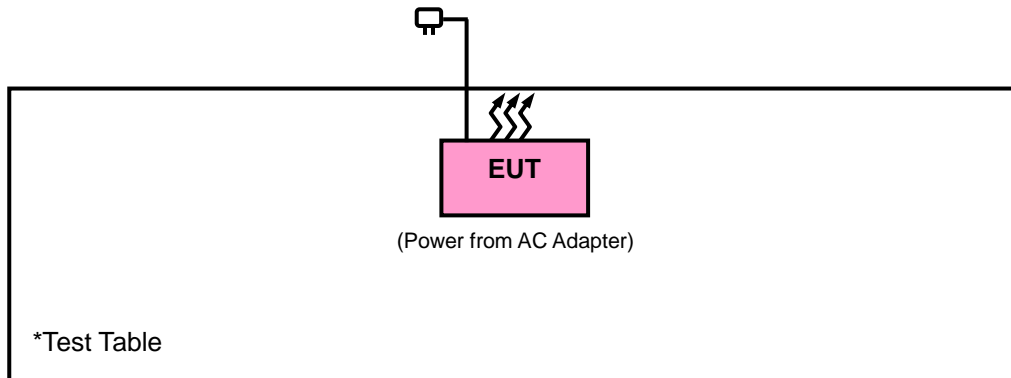

3.5 General Description of Applied Standards

The EUT is a RF Product. According to the specifications of the manufacturer, it must comply with the requirements of the following standards:

FCC Part 15, Subpart E (15.407)

KDB 789033 D02 General UNII Test Procedures New Rules v02r01

ANSI C63.10-2013

All test items have been performed and recorded as per the above standards.

4 Test Types and Results

4.1 Radiated Emission and Bandedge Measurement

4.1.1 Limits of Radiated Emission and Bandedge Measurement

Radiated emissions which fall in the restricted bands must comply with the radiated emission limits specified as below table.

Frequencies (MHz)	Field Strength (microvolts/meter)	Measurement Distance (meters)
0.009 ~ 0.490	2400/F (kHz)	300
0.490 ~ 1.705	24000/F (kHz)	30
1.705 ~ 30.0	30	30
30 ~ 88	100	3
88 ~ 216	150	3
216 ~ 960	200	3
Above 960	500	3

Note:

1. The lower limit shall apply at the transition frequencies.
2. Emission level (dBuV/m) = 20 log Emission level (uV/m).
3. For frequencies above 1000 MHz, the field strength limits are based on average detector, however, the peak field strength of any emission shall not exceed the maximum permitted average limits, specified above by more than 20 dB under any condition of modulation.

4.1.2 Limits of Unwanted Emission Out of the Restricted Bands

Applicable To		Limit	
789033 D02 General UNII Test Procedures New Rules v02r01		Field Strength at 3 m	
		PK: 74 (dBµV/m)	AV: 54 (dBµV/m)
Frequency Band	Applicable To	EIRP Limit	Equivalent Field Strength at 3 m
5150~5250 MHz	15.407(b)(1)	PK: -27 (dBm/MHz)	PK: 68.2 (dBµV/m)
5250~5350 MHz	15.407(b)(2)		
5470~5725 MHz	15.407(b)(3)		
5725~5850 MHz	15.407(b)(4)(i)	PK:-27 (dBm/MHz) ^{*1} PK:10 (dBm/MHz) ^{*2} PK:15.6 (dBm/MHz) ^{*3} PK:27 (dBm/MHz) ^{*4}	PK: 68.2 (dBµV/m) ^{*1} PK:105.2 (dBµV/m) ^{*2} PK: 110.8 (dBµV/m) ^{*3} PK:122.2 (dBµV/m) ^{*4}
	15.407(b)(4)(ii)	Emission limits in section 15.247(d)	
^{*1} beyond 75 MHz or more above of the band edge. ^{*2} below the band edge increasing linearly to 10 dBm/MHz at 25 MHz above. ^{*3} below the band edge increasing linearly to a level of 15.6 dBm/MHz at 5 MHz above. ^{*4} from 5 MHz above or below the band edge increasing linearly to a level of 27 dBm/MHz at the band edge.			

Note:

The following formula is used to convert the equipment isotropic radiated power (eirp) to field strength:

$$E = \frac{1000000\sqrt{30P}}{3} \mu\text{V/m, where } P \text{ is the eirp (Watts).}$$

4.1.3 Test Instruments

Description & Manufacturer	Model No.	Serial No.	Date of Calibration	Due Date of Calibration
Test Receiver Agilent Technologies	N9038A	MY52260177	Aug. 20, 2018	Aug. 19, 2019
Spectrum Analyzer ROHDE & SCHWARZ	FSU43	101261	Apr. 15, 2019	Apr. 14, 2020
HORN Antenna ETS-Lindgren	3117	00143293	Nov. 25, 2018	Nov. 24, 2019
BILOG Antenna SCHWARZBECK	VULB 9168	9168-616	Nov. 27, 2018	Nov. 26, 2019
HORN Antenna SCHWARZBECK	BBHA 9170	9170-480	Nov. 25, 2018	Nov. 24, 2019
Fixed Attenuator Mini-Circuits	MDCS18N-10	MDCS18N-10-01	Apr. 15, 2019	Apr. 14, 2020
Loop Antenna	EM-6879	269	Sep. 07, 2018	Sep. 06, 2019
Preamplifier Agilent	310N	187226	Jun. 18, 2019	Jun. 17, 2020
Preamplifier Agilent	83017A	MY39501357	Jun. 18, 2019	Jun. 17, 2020
Preamplifier EMCI	EMC 184045	980116	Oct. 12, 2018	Oct. 11, 2019
RF signal cable ETS-LINDGREN	5D-FB	Cable-CH1-01(RFC -SMS-100-SMS-12 0+RFC-SMS-100-S MS-400)	Jun. 18, 2019	Jun. 17, 2020
RF signal cable ETS-LINDGREN	8D-FB	Cable-CH1-02(RFC -SMS-100-SMS-24)	Jun. 18, 2019	Jun. 17, 2020
Boresight Antenna Fixture	FBA-01	FBA-SIP01	NA	NA
Software BV ADT	E3 8.130425b	NA	NA	NA
Antenna Tower MF	NA	NA	NA	NA
Turn Table MF	NA	NA	NA	NA
Antenna Tower & Turn Table Controller MF	MF-7802	NA	NA	NA
Turn Table MF	NA	NA	NA	NA
Antenna Tower & Turn Table Controller MF	MF-7802	NA	NA	NA
Temperature & Humidity Chamber	GTH-120-40-CP-A R	MAA1306-019	Sep. 05, 2018	Sep. 04, 2019
DC Power Supply Topward	33010D	807748	NA	NA
Digital Multimeter Fluke	87-III	70360742	Jun. 29, 2018	Jun. 28, 2019

- Note: 1. The calibration interval of the above test instruments is 12 / 24 months and the calibrations are traceable to NML/ROC and NIST/USA.
2. The test was performed in HsinTien Chamber 1.

4.1.4 Test Procedures

For Radiated Emission below 30 MHz

- a. The EUT was placed on the top of a rotating table 0.8 meters above the ground at a 3 meter chamber room. The table was rotated 360 degrees to determine the position of the highest radiation.
- b. The EUT was set 3 meters away from the interference-receiving antenna, which was mounted on the top of a variable-height antenna tower.
- c. Both Parallel, perpendicular, and ground-parallel orientations of the antenna are set to make the measurement.
- d. For each suspected emission, the EUT was arranged to its worst case and the rotatable table was turned from 0 degrees to 360 degrees to find the maximum reading.
- e. The test-receiver system was set to Quasi-Peak Detect Function and Specified Bandwidth with Maximum Hold Mode.

Note:

1. The resolution bandwidth and video bandwidth of test receiver/spectrum analyzer is 9 kHz at frequency below 30 MHz.

For Radiated Emission above 30 MHz

- a. The EUT was placed on the top of a rotating table 0.8 meters (for 30 MHz ~ 1 GHz) / 1.5 meters (for above 1 GHz) above the ground at 3 meter chamber room for test. The table was rotated 360 degrees to determine the position of the highest radiation.
- b. The EUT was set 3 meters away from the interference-receiving antenna, which was mounted on the top of a variable-height antenna tower.
- c. The height of antenna is varied from one meter to four meters above the ground to determine the maximum value of the field strength. Both horizontal and vertical polarizations of the antenna are set to make the measurement.
- d. For each suspected emission, the EUT was arranged to its worst case and then the antenna was tuned to heights from 1 meter to 4 meters and the rotatable table was turned from 0 degrees to 360 degrees to find the maximum reading.
- e. The test-receiver system was set to quasi-peak detect function and specified bandwidth with maximum hold mode when the test frequency is below 1 GHz.
- f. The test-receiver system was set to peak and average detected function and specified bandwidth with maximum hold mode when the test frequency is above 1 GHz. If the peak reading value also meets average limit, measurement with the average detector is unnecessary.

Note:

1. The resolution bandwidth and video bandwidth of test receiver/spectrum analyzer is 120 kHz for Quasi-peak detection (QP) or Peak detection (PK) at frequency below 1 GHz.
2. The resolution bandwidth of test receiver/spectrum analyzer is 1 MHz and the video bandwidth is 3 MHz for Peak detection (PK) at frequency above 1 GHz.
3. The resolution bandwidth of test receiver/spectrum analyzer is 1 MHz and the video bandwidth is $\geq 1/T$ (Duty cycle < 98 %) or 10 Hz (Duty cycle ≥ 98 %) for Average detection (AV) at frequency above 1 GHz.
(11a: RBW = 1 MHz, VBW = 1 kHz ; 11n (HT20): RBW = 1 MHz, VBW = 1 kHz ;
11n (HT40): RBW = 1 MHz, VBW = 3 kHz)
4. All modes of operation were investigated and the worst-case emissions are reported.

4.1.5 Deviation from Test Standard

No deviation.

4.1.6 Test Setup

<Radiated Emission below 30 MHz>

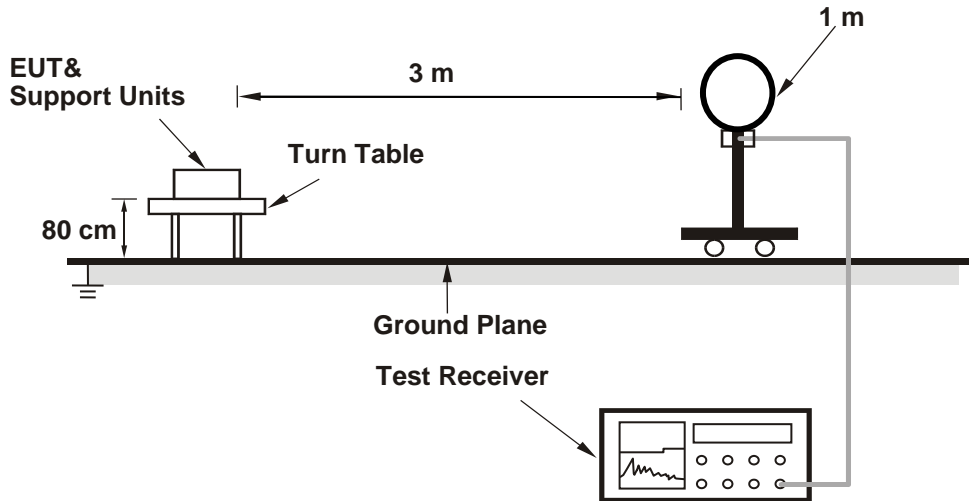

<Radiated Emission 30 MHz to 1 GHz>

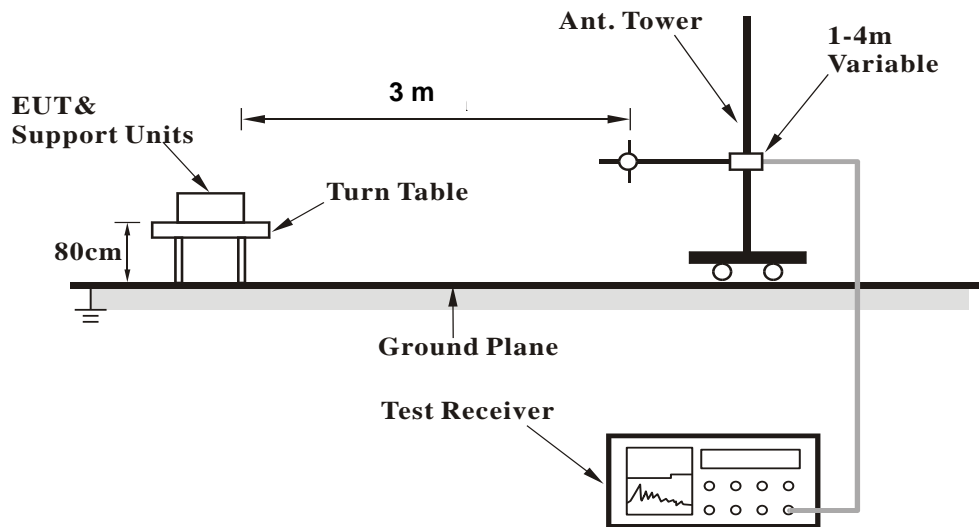

<Radiated Emission above 1 GHz>

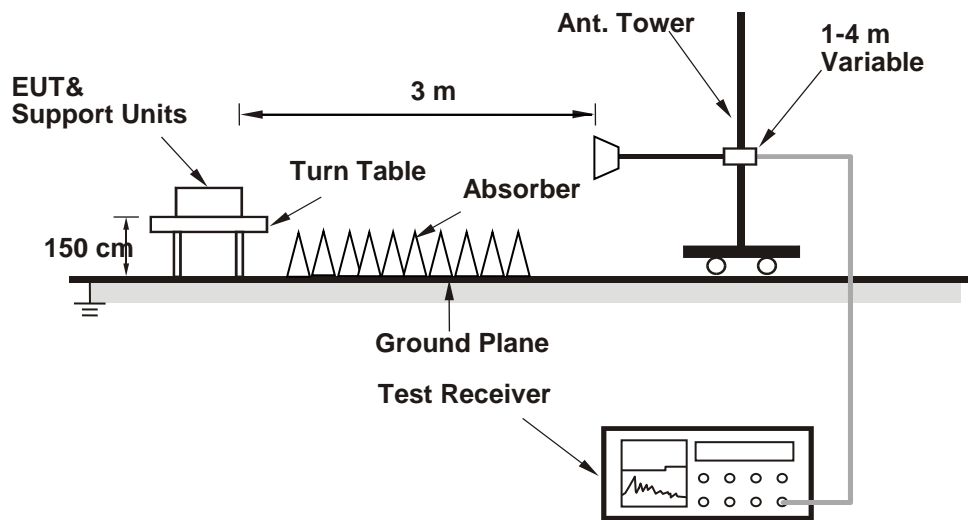

For the actual test configuration, please refer to the attached file (Test Setup Photo).

4.1.7 EUT Operating Conditions

- a. Placed the EUT on a testing table.
- b. Use the software to control the EUT under transmission condition continuously at specific channel frequency.

4.1.8 Test Results
 Above 1 GHz Data :
 802.11a

EUT Test Condition		Measurement Detail	
Channel	Channel 36	Frequency Range	1 GHz ~ 40 GHz
Input Power	120 Vac, 60 Hz	Detector Function	Peak (PK) Average (AV)
Environmental Conditions	25 deg. C, 65 % RH	Tested By	Karl Lee

Antenna Polarity & Test Distance: Horizontal at 3 m								
Frequency (MHz)	Emission Level (dBuV/m)	Read Level (dBuV)	Factor (dB/m)	Limit (dBuV/m)	Margin (dB)	Antenna Height (cm)	Table Angle (Degree)	Remark
5149.85	44.24	35.99	8.25	54	-9.76	205	295	Average
5149.85	55.97	47.72	8.25	74	-18.03	205	295	Peak
5180	92.21	83.9	8.31			205	295	Average
5180	99.74	91.43	8.31			205	295	Peak
*10360	54.29	39.99	14.3	68.2	-13.91	112	302	Peak

Antenna Polarity & Test Distance: Vertical at 3 m								
Frequency (MHz)	Emission Level (dBuV/m)	Read Level (dBuV)	Factor (dB/m)	Limit (dBuV/m)	Margin (dB)	Antenna Height (cm)	Table Angle (Degree)	Remark
5149.85	44.54	36.29	8.25	54	-9.46	169	53	Average
5149.85	54.19	45.94	8.25	74	-19.81	169	53	Peak
5180	92.28	83.97	8.31			169	53	Average
5180	100.37	92.06	8.31			169	53	Peak
*10360	53.6	39.3	14.3	68.2	-14.6	182	164	Peak

Remarks:

- Emission Level = Read Level + Factor
Margin value = Emission level – Limit value
- 5180 MHz: Fundamental Frequency
- *: Out of Restricted Band
- The emission levels of other frequencies were very low against the limit

EUT Test Condition		Measurement Detail	
Channel	Channel 40	Frequency Range	1 GHz ~ 40 GHz
Input Power	120 Vac, 60 Hz	Detector Function	Peak (PK) Average (AV)
Environmental Conditions	25 deg. C, 65 % RH	Tested By	Karl Lee

Antenna Polarity & Test Distance: Horizontal at 3 m								
Frequency (MHz)	Emission Level (dBuV/m)	Read Level (dBuV)	Factor (dB/m)	Limit (dBuV/m)	Margin (dB)	Antenna Height (cm)	Table Angle (Degree)	Remark
5147.9	43.73	35.48	8.25	54	-10.27	205	295	Average
5147.9	53.06	44.81	8.25	74	-20.94	205	295	Peak
5200	92.44	84.09	8.35			205	295	Average
5200	99.77	91.42	8.35			205	295	Peak
5423.26	42.6	33.83	8.77	54	-11.4	205	295	Average
5423.26	53.43	44.66	8.77	74	-20.57	205	295	Peak
*10400	54.73	40.39	14.34	68.2	-13.47	182	25	Peak
Antenna Polarity & Test Distance: Vertical at 3 m								
Frequency (MHz)	Emission Level (dBuV/m)	Read Level (dBuV)	Factor (dB/m)	Limit (dBuV/m)	Margin (dB)	Antenna Height (cm)	Table Angle (Degree)	Remark
5147.3	43.52	35.27	8.25	54	-10.48	169	53	Average
5147.3	53.51	45.26	8.25	74	-20.49	169	53	Peak
5200	91.39	83.04	8.35			169	53	Average
5200	99.43	91.08	8.35			169	53	Peak
5431.73	42.68	33.89	8.79	54	-11.32	169	53	Average
5431.73	53.15	44.36	8.79	74	-20.85	169	53	Peak
*10400	53.78	39.44	14.34	68.2	-14.42	161	145	Peak

Remarks:

- Emission Level = Read Level + Factor
Margin value = Emission level – Limit value
- 5200 MHz: Fundamental Frequency
- *: Out of Restricted Band
- The emission levels of other frequencies were very low against the limit

EUT Test Condition		Measurement Detail	
Channel	Channel 48	Frequency Range	1 GHz ~ 40 GHz
Input Power	120 Vac, 60 Hz	Detector Function	Peak (PK) Average (AV)
Environmental Conditions	25 deg. C, 65 % RH	Tested By	Karl Lee

Antenna Polarity & Test Distance: Horizontal at 3 m								
Frequency (MHz)	Emission Level (dBuV/m)	Read Level (dBuV)	Factor (dB/m)	Limit (dBuV/m)	Margin (dB)	Antenna Height (cm)	Table Angle (Degree)	Remark
5240	92.06	83.62	8.44			205	295	Average
5240	99.61	91.17	8.44			205	295	Peak
5444.38	42.62	33.83	8.79	54	-11.38	205	295	Average
5444.38	53.07	44.28	8.79	74	-20.93	205	295	Peak
*10480	54.36	39.85	14.51	68.2	-13.84	119	214	Peak
Antenna Polarity & Test Distance: Vertical at 3 m								
Frequency (MHz)	Emission Level (dBuV/m)	Read Level (dBuV)	Factor (dB/m)	Limit (dBuV/m)	Margin (dB)	Antenna Height (cm)	Table Angle (Degree)	Remark
5240	91.56	83.12	8.44			169	53	Average
5240	100.18	91.74	8.44			169	53	Peak
5450.76	42.65	33.83	8.82	54	-11.35	169	53	Average
5450.76	53.71	44.89	8.82	74	-20.29	169	53	Peak
*10480	54.98	40.47	14.51	68.2	-13.22	154	178	Peak

Remarks:

- Emission Level = Read Level + Factor
Margin value = Emission level – Limit value
- 5240 MHz: Fundamental Frequency
- *: Out of Restricted Band
- The emission levels of other frequencies were very low against the limit

EUT Test Condition		Measurement Detail	
Channel	Channel 52	Frequency Range	1 GHz ~ 40 GHz
Input Power	120 Vac, 60 Hz	Detector Function	Peak (PK) Average (AV)
Environmental Conditions	25 deg. C, 65 % RH	Tested By	Karl Lee

Antenna Polarity & Test Distance: Horizontal at 3 m								
Frequency (MHz)	Emission Level (dBuV/m)	Read Level (dBuV)	Factor (dB/m)	Limit (dBuV/m)	Margin (dB)	Antenna Height (cm)	Table Angle (Degree)	Remark
5132.3	42.79	34.57	8.22	54	-11.21	200	295	Average
5132.3	53.42	45.2	8.22	74	-20.58	200	295	Peak
5260	95.57	87.11	8.46			200	295	Average
5260	102.39	93.93	8.46			200	295	Peak
*10520	54.97	40.38	14.59	68.2	-13.23	189	57	Peak

Antenna Polarity & Test Distance: Vertical at 3 m								
Frequency (MHz)	Emission Level (dBuV/m)	Read Level (dBuV)	Factor (dB/m)	Limit (dBuV/m)	Margin (dB)	Antenna Height (cm)	Table Angle (Degree)	Remark
5114.6	42.72	34.52	8.2	54	-11.28	187	50	Average
5114.6	53.17	44.97	8.2	74	-20.83	187	50	Peak
5260	94.57	86.11	8.46			187	50	Average
5260	101.34	92.88	8.46			187	50	Peak
*10520	54.49	39.9	14.59	68.2	-13.71	165	213	Peak

Remarks:

- Emission Level = Read Level + Factor
Margin value = Emission level – Limit value
- 5260 MHz: Fundamental Frequency
- *: Out of Restricted Band
- The emission levels of other frequencies were very low against the limit

EUT Test Condition		Measurement Detail	
Channel	Channel 60	Frequency Range	1 GHz ~ 40 GHz
Input Power	120 Vac, 60 Hz	Detector Function	Peak (PK) Average (AV)
Environmental Conditions	25 deg. C, 65 % RH	Tested By	Karl Lee

Antenna Polarity & Test Distance: Horizontal at 3 m								
Frequency (MHz)	Emission Level (dBuV/m)	Read Level (dBuV)	Factor (dB/m)	Limit (dBuV/m)	Margin (dB)	Antenna Height (cm)	Table Angle (Degree)	Remark
5131.25	42.57	34.35	8.22	54	-11.43	200	295	Average
5131.25	53.79	45.57	8.22	74	-20.21	200	295	Peak
5300	95.52	86.98	8.54			200	295	Average
5300	102.15	93.61	8.54			200	295	Peak
5352.53	43.71	35.08	8.63	54	-10.29	200	295	Average
5352.53	53.95	45.32	8.63	74	-20.05	200	295	Peak
10600	46.13	31.45	14.68	54	-7.87	144	274	Average
10600	55.64	40.96	14.68	74	-18.36	144	274	Peak

Antenna Polarity & Test Distance: Vertical at 3 m								
Frequency (MHz)	Emission Level (dBuV/m)	Read Level (dBuV)	Factor (dB/m)	Limit (dBuV/m)	Margin (dB)	Antenna Height (cm)	Table Angle (Degree)	Remark
5104.85	42.56	34.4	8.16	54	-11.44	187	50	Average
5104.85	53.13	44.97	8.16	74	-20.87	187	50	Peak
5300	94.74	86.2	8.54			187	50	Average
5300	101.3	92.76	8.54			187	50	Peak
5352.42	43.95	35.32	8.63	54	-10.05	187	50	Average
5352.42	53.92	45.29	8.63	74	-20.08	187	50	Peak
10600	45.94	31.26	14.68	54	-8.06	140	49	Average
10600	55.63	40.95	14.68	74	-18.37	140	49	Peak

Remarks:

- Emission Level = Read Level + Factor
Margin value = Emission level – Limit value
- 5300 MHz: Fundamental Frequency
- The emission levels of other frequencies were very low against the limit

EUT Test Condition		Measurement Detail	
Channel	Channel 64	Frequency Range	1 GHz ~ 40 GHz
Input Power	120 Vac, 60 Hz	Detector Function	Peak (PK) Average (AV)
Environmental Conditions	25 deg. C, 65 % RH	Tested By	Karl Lee

Antenna Polarity & Test Distance: Horizontal at 3 m								
Frequency (MHz)	Emission Level (dBuV/m)	Read Level (dBuV)	Factor (dB/m)	Limit (dBuV/m)	Margin (dB)	Antenna Height (cm)	Table Angle (Degree)	Remark
5320	95.25	86.67	8.58			200	295	Average
5320	102.55	93.97	8.58			200	295	Peak
5351.65	45.01	36.38	8.63	54	-8.99	200	295	Average
5351.65	55.75	47.12	8.63	74	-18.25	200	295	Peak
10640	46.18	31.45	14.73	54	-7.82	155	214	Average
10640	55.55	40.82	14.73	74	-18.45	155	214	Peak

Antenna Polarity & Test Distance: Vertical at 3 m								
Frequency (MHz)	Emission Level (dBuV/m)	Read Level (dBuV)	Factor (dB/m)	Limit (dBuV/m)	Margin (dB)	Antenna Height (cm)	Table Angle (Degree)	Remark
5320	94.57	85.99	8.58			187	50	Average
5320	101.65	93.07	8.58			187	50	Peak
5350.11	46.17	37.54	8.63	54	-7.83	187	50	Average
5350.11	57.01	48.38	8.63	74	-16.99	187	50	Peak
10640	45.97	31.24	14.73	54	-8.03	194	178	Average
10640	55.65	40.92	14.73	74	-18.35	194	178	Peak

Remarks:

- Emission Level = Read Level + Factor
Margin value = Emission level – Limit value
- 5320 MHz: Fundamental Frequency
- The emission levels of other frequencies were very low against the limit

EUT Test Condition		Measurement Detail	
Channel	Channel 100	Frequency Range	1 GHz ~ 40 GHz
Input Power	120 Vac, 60 Hz	Detector Function	Peak (PK) Average (AV)
Environmental Conditions	25 deg. C, 65 % RH	Tested By	Karl Lee

Antenna Polarity & Test Distance: Horizontal at 3 m								
Frequency (MHz)	Emission Level (dBuV/m)	Read Level (dBuV)	Factor (dB/m)	Limit (dBuV/m)	Margin (dB)	Antenna Height (cm)	Table Angle (Degree)	Remark
5447.76	43.94	35.11	8.83	54	-10.06	200	317	Average
5447.76	53.64	44.81	8.83	74	-20.36	200	317	Peak
*5470	54.98	46.15	8.83	68.2	-13.22	200	317	Peak
5500	94.57	85.65	8.92			200	317	Average
5500	101.5	92.58	8.92			200	317	Peak
11000	46.39	31.31	15.08	54	-7.61	138	124	Average
11000	55.99	40.91	15.08	74	-18.01	138	124	Peak
Antenna Polarity & Test Distance: Vertical at 3 m								
Frequency (MHz)	Emission Level (dBuV/m)	Read Level (dBuV)	Factor (dB/m)	Limit (dBuV/m)	Margin (dB)	Antenna Height (cm)	Table Angle (Degree)	Remark
5447.92	43.81	34.98	8.83	54	-10.19	200	24	Average
5447.92	53.82	44.99	8.83	74	-20.18	200	24	Peak
*5469.84	54.74	45.91	8.83	68.2	-13.46	200	24	Peak
5500	94.59	85.67	8.92			200	24	Average
5500	101.15	92.23	8.92			200	24	Peak
11000	45.87	30.79	15.08	54	-8.13	143	138	Average
11000	55.27	40.19	15.08	74	-18.73	143	138	Peak

Remarks:

- Emission Level = Read Level + Factor
Margin value = Emission level – Limit value
- 5500 MHz: Fundamental Frequency
- *: Out of Restricted Band
- The emission levels of other frequencies were very low against the limit

EUT Test Condition		Measurement Detail	
Channel	Channel 116	Frequency Range	1 GHz ~ 40 GHz
Input Power	120 Vac, 60 Hz	Detector Function	Peak (PK) Average (AV)
Environmental Conditions	25 deg. C, 65 % RH	Tested By	Karl Lee

Antenna Polarity & Test Distance: Horizontal at 3 m								
Frequency (MHz)	Emission Level (dBuV/m)	Read Level (dBuV)	Factor (dB/m)	Limit (dBuV/m)	Margin (dB)	Antenna Height (cm)	Table Angle (Degree)	Remark
5443.12	42.76	33.97	8.79	54	-11.24	200	317	Average
5443.12	53.19	44.4	8.79	74	-20.81	200	317	Peak
*5469.84	52.11	43.28	8.83	68.2	-16.09	200	317	Peak
5580	94.7	85.71	8.99			200	317	Average
5580	101.57	92.58	8.99			200	317	Peak
*5725.96	52.52	43.36	9.16	68.2	-15.68	200	317	Peak
11600	45.71	30.28	15.43	54	-8.29	195	264	Average
11600	55.35	39.92	15.43	74	-18.65	195	264	Peak

Antenna Polarity & Test Distance: Vertical at 3 m								
Frequency (MHz)	Emission Level (dBuV/m)	Read Level (dBuV)	Factor (dB/m)	Limit (dBuV/m)	Margin (dB)	Antenna Height (cm)	Table Angle (Degree)	Remark
5459.76	42.6	33.78	8.82	54	-11.4	200	24	Average
5459.76	54.11	45.29	8.82	74	-19.89	200	24	Peak
*5469.52	52.4	43.57	8.83	68.2	-15.8	200	24	Peak
5580	94.59	85.6	8.99			200	24	Average
5580	101.33	92.34	8.99			200	24	Peak
*5725.48	52.29	43.13	9.16	68.2	-15.91	200	24	Peak
11600	47.23	31.8	15.43	54	-6.77	167	106	Average
11600	56.54	41.11	15.43	74	-17.46	167	106	Peak

Remarks:

- Emission Level = Read Level + Factor
Margin value = Emission level – Limit value
- 5580 MHz: Fundamental Frequency
- *: Out of Restricted Band
- The emission levels of other frequencies were very low against the limit

EUT Test Condition		Measurement Detail	
Channel	Channel 140	Frequency Range	1 GHz ~ 40 GHz
Input Power	120 Vac, 60 Hz	Detector Function	Peak (PK) Average (AV)
Environmental Conditions	25 deg. C, 65 % RH	Tested By	Karl Lee

Antenna Polarity & Test Distance: Horizontal at 3 m								
Frequency (MHz)	Emission Level (dBuV/m)	Read Level (dBuV)	Factor (dB/m)	Limit (dBuV/m)	Margin (dB)	Antenna Height (cm)	Table Angle (Degree)	Remark
5700	93.47	84.34	9.13			200	317	Average
5700	100.69	91.56	9.13			200	317	Peak
*5725.16	55.86	46.7	9.16	68.2	-12.34	200	317	Peak
11400	45.81	30.71	15.1	54	-8.19	160	341	Average
11400	55.39	40.29	15.1	74	-18.61	160	341	Peak
Antenna Polarity & Test Distance: Vertical at 3 m								
Frequency (MHz)	Emission Level (dBuV/m)	Read Level (dBuV)	Factor (dB/m)	Limit (dBuV/m)	Margin (dB)	Antenna Height (cm)	Table Angle (Degree)	Remark
5700	93.46	84.33	9.13			200	24	Average
5700	100.72	91.59	9.13			200	24	Peak
*5725.94	57.53	48.37	9.16	68.2	-10.67	200	24	Peak
11400	45.27	30.17	15.1	54	-8.73	129	164	Average
11400	54.76	39.66	15.1	74	-19.24	129	164	Peak

Remarks:

- Emission Level = Read Level + Factor
Margin value = Emission level – Limit value
- 5700 MHz: Fundamental Frequency
- *: Out of Restricted Band
- The emission levels of other frequencies were very low against the limit

EUT Test Condition		Measurement Detail	
Channel	Channel 149	Frequency Range	1 GHz ~ 40 GHz
Input Power	120 Vac, 60 Hz	Detector Function	Peak (PK) Average (AV)
Environmental Conditions	25 deg. C, 65 % RH	Tested By	Karl Lee

<Spurious Emission>

Antenna Polarity & Test Distance: Horizontal at 3 m								
Frequency (MHz)	Emission Level (dBuV/m)	Read Level (dBuV)	Factor (dB/m)	Limit (dBuV/m)	Margin (dB)	Antenna Height (cm)	Table Angle (Degree)	Remark
5745	93.61	84.42	9.19			202	326	Average
5745	101.79	92.6	9.19			202	326	Peak
11490	46.23	31.11	15.12	54	-7.77	138	121	Average
11490	55.97	40.85	15.12	74	-18.03	138	121	Peak

Antenna Polarity & Test Distance: Vertical at 3 m								
Frequency (MHz)	Emission Level (dBuV/m)	Read Level (dBuV)	Factor (dB/m)	Limit (dBuV/m)	Margin (dB)	Antenna Height (cm)	Table Angle (Degree)	Remark
5745	90.82	81.63	9.19			103	25	Average
5745	102.09	92.9	9.19			103	25	Peak
11490	45.69	30.57	15.12	54	-8.31	162	187	Average
11490	55.36	40.24	15.12	74	-18.64	162	187	Peak

<Out of Band Emission (OOBE)>

Antenna Polarity & Test Distance: Horizontal at 3 m								
Frequency (MHz)	Emission Level (dBuV/m)	Read Level (dBuV)	Factor (dB/m)	Limit (dBuV/m)	Margin (dB)	Antenna Height (cm)	Table Angle (Degree)	Remark
*5586.1	53.47	44.46	9.01	68.2	-14.73	202	326	Peak
5652.25	52.43	43.34	9.09	69.86	-17.43	202	326	Peak
5920.525	52.43	43.05	9.38	71.51	-19.08	202	326	Peak
*5932.075	53.13	43.73	9.4	68.2	-15.07	202	326	Peak

Antenna Polarity & Test Distance: Vertical at 3 m								
Frequency (MHz)	Emission Level (dBuV/m)	Read Level (dBuV)	Factor (dB/m)	Limit (dBuV/m)	Margin (dB)	Antenna Height (cm)	Table Angle (Degree)	Remark
*5542	54.07	45.13	8.94	68.2	-14.13	103	25	Peak
5654.35	51.67	42.58	9.09	71.42	-19.75	103	25	Peak
5920.525	52.64	43.26	9.38	71.51	-18.87	103	25	Peak
*6017.125	53.55	44.04	9.51	68.2	-14.65	103	25	Peak

Remarks:

- Emission Level = Read Level + Factor
Margin value = Emission level – Limit value
- 5745 MHz: Fundamental Frequency
- *: Out of Restricted Band
- The emission levels of other frequencies were very low against the limit

EUT Test Condition		Measurement Detail	
Channel	Channel 157	Frequency Range	1 GHz ~ 40 GHz
Input Power	120 Vac, 60 Hz	Detector Function	Peak (PK) Average (AV)
Environmental Conditions	25 deg. C, 65 % RH	Tested By	Karl Lee

<Spurious Emission>

Antenna Polarity & Test Distance: Horizontal at 3 m								
Frequency (MHz)	Emission Level (dBuV/m)	Read Level (dBuV)	Factor (dB/m)	Limit (dBuV/m)	Margin (dB)	Antenna Height (cm)	Table Angle (Degree)	Remark
5785	94.4	85.17	9.23			202	326	Average
5785	102.04	92.81	9.23			202	326	Peak
11570	46.28	30.97	15.31	54	-7.72	165	224	Average
11570	55.82	40.51	15.31	74	-18.18	165	224	Peak
Antenna Polarity & Test Distance: Vertical at 3 m								
Frequency (MHz)	Emission Level (dBuV/m)	Read Level (dBuV)	Factor (dB/m)	Limit (dBuV/m)	Margin (dB)	Antenna Height (cm)	Table Angle (Degree)	Remark
5785	94.43	85.2	9.23			103	25	Average
5785	101.9	92.67	9.23			103	25	Peak
11570	45.66	30.35	15.31	54	-8.34	130	164	Average
11570	55.33	40.02	15.31	74	-18.67	130	164	Peak

<Out of Band Emission (OOBE)>

Antenna Polarity & Test Distance: Horizontal at 3 m								
Frequency (MHz)	Emission Level (dBuV/m)	Read Level (dBuV)	Factor (dB/m)	Limit (dBuV/m)	Margin (dB)	Antenna Height (cm)	Table Angle (Degree)	Remark
*5612.875	53.5	44.47	9.03	68.2	-14.7	202	326	Peak
5656.45	52.47	43.38	9.09	72.97	-20.5	202	326	Peak
5922.1	52.18	42.78	9.4	70.35	-18.17	202	326	Peak
*5946.775	54.67	45.24	9.43	68.2	-13.53	202	326	Peak
Antenna Polarity & Test Distance: Vertical at 3 m								
Frequency (MHz)	Emission Level (dBuV/m)	Read Level (dBuV)	Factor (dB/m)	Limit (dBuV/m)	Margin (dB)	Antenna Height (cm)	Table Angle (Degree)	Remark
*5537.8	54.14	45.2	8.94	68.2	-14.06	103	25	Peak
5655.4	52.46	43.37	9.09	72.2	-19.74	103	25	Peak
5921.575	53.83	44.43	9.4	70.73	-16.9	103	25	Peak
*5956.75	53.75	44.3	9.45	68.2	-14.45	103	25	Peak

Remarks:

- Emission Level = Read Level + Factor
Margin value = Emission level – Limit value
- 5785 MHz: Fundamental Frequency
- *: Out of Restricted Band
- The emission levels of other frequencies were very low against the limit

EUT Test Condition		Measurement Detail	
Channel	Channel 165	Frequency Range	1 GHz ~ 40 GHz
Input Power	120 Vac, 60 Hz	Detector Function	Peak (PK) Average (AV)
Environmental Conditions	25 deg. C, 65 % RH	Tested By	Karl Lee

<Spurious Emission>

Antenna Polarity & Test Distance: Horizontal at 3 m								
Frequency (MHz)	Emission Level (dBuV/m)	Read Level (dBuV)	Factor (dB/m)	Limit (dBuV/m)	Margin (dB)	Antenna Height (cm)	Table Angle (Degree)	Remark
5825	95.12	85.83	9.29			202	327	Average
5825	102.38	93.09	9.29			202	327	Peak
11650	46.11	30.58	15.53	54	-7.89	123	61	Average
11650	55.65	40.12	15.53	74	-18.35	123	61	Peak
Antenna Polarity & Test Distance: Vertical at 3 m								
Frequency (MHz)	Emission Level (dBuV/m)	Read Level (dBuV)	Factor (dB/m)	Limit (dBuV/m)	Margin (dB)	Antenna Height (cm)	Table Angle (Degree)	Remark
5825	94.76	85.47	9.29			103	25	Average
5825	102.44	93.15	9.29			103	25	Peak
11650	45.63	30.1	15.53	54	-8.37	120	74	Average
11650	55.2	39.67	15.53	74	-18.8	120	74	Peak

<Out of Band Emission (OOBE)>

Antenna Polarity & Test Distance: Horizontal at 3 m								
Frequency (MHz)	Emission Level (dBuV/m)	Read Level (dBuV)	Factor (dB/m)	Limit (dBuV/m)	Margin (dB)	Antenna Height (cm)	Table Angle (Degree)	Remark
*5571.925	53.08	44.09	8.99	68.2	-15.12	202	327	Peak
5654.35	52.24	43.15	9.09	71.42	-19.18	202	327	Peak
5921.575	51.96	42.56	9.4	70.73	-18.77	202	327	Peak
*6020.275	54.22	44.71	9.51	68.2	-13.98	202	327	Peak
Antenna Polarity & Test Distance: Vertical at 3 m								
Frequency (MHz)	Emission Level (dBuV/m)	Read Level (dBuV)	Factor (dB/m)	Limit (dBuV/m)	Margin (dB)	Antenna Height (cm)	Table Angle (Degree)	Remark
*5627.05	53.75	44.69	9.06	68.2	-14.45	103	25	Peak
5652.25	53.26	44.17	9.09	69.86	-16.6	103	25	Peak
5922.1	51.95	42.55	9.4	70.35	-18.4	103	25	Peak
*6011.35	53.07	43.57	9.5	68.2	-15.13	103	25	Peak

Remarks:

- Emission Level = Read Level + Factor
Margin value = Emission level – Limit value
- 5825 MHz: Fundamental Frequency
- *: Out of Restricted Band
- The emission levels of other frequencies were very low against the limit

802.11n (HT20)

EUT Test Condition		Measurement Detail	
Channel	Channel 36	Frequency Range	1 GHz ~ 40 GHz
Input Power	120 Vac, 60 Hz	Detector Function	Peak (PK) Average (AV)
Environmental Conditions	25 deg. C, 65 % RH	Tested By	Karl Lee

Antenna Polarity & Test Distance: Horizontal at 3 m								
Frequency (MHz)	Emission Level (dBuV/m)	Read Level (dBuV)	Factor (dB/m)	Limit (dBuV/m)	Margin (dB)	Antenna Height (cm)	Table Angle (Degree)	Remark
5148.5	46.4	38.15	8.25	54	-7.6	205	295	Average
5148.5	56.51	48.26	8.25	74	-17.49	205	295	Peak
5180	93.25	84.94	8.31			205	295	Average
5180	101	92.69	8.31			205	295	Peak
*10360	55.21	40.91	14.3	68.2	-12.99	112	245	Peak
Antenna Polarity & Test Distance: Vertical at 3 m								
Frequency (MHz)	Emission Level (dBuV/m)	Read Level (dBuV)	Factor (dB/m)	Limit (dBuV/m)	Margin (dB)	Antenna Height (cm)	Table Angle (Degree)	Remark
5149.4	46.05	37.8	8.25	54	-7.95	169	53	Average
5149.4	56.69	48.44	8.25	74	-17.31	169	53	Peak
5180	93.03	84.72	8.31			169	53	Average
5180	100.45	92.14	8.31			169	53	Peak
*10360	53.79	39.49	14.3	68.2	-14.41	179	95	Peak

Remarks:

- Emission Level = Read Level + Factor
Margin value = Emission level – Limit value
- 5180 MHz: Fundamental Frequency
- *: Out of Restricted Band
- The emission levels of other frequencies were very low against the limit

EUT Test Condition		Measurement Detail	
Channel	Channel 40	Frequency Range	1 GHz ~ 40 GHz
Input Power	120 Vac, 60 Hz	Detector Function	Peak (PK) Average (AV)
Environmental Conditions	25 deg. C, 65 % RH	Tested By	Karl Lee

Antenna Polarity & Test Distance: Horizontal at 3 m								
Frequency (MHz)	Emission Level (dBuV/m)	Read Level (dBuV)	Factor (dB/m)	Limit (dBuV/m)	Margin (dB)	Antenna Height (cm)	Table Angle (Degree)	Remark
5149.25	44.08	35.83	8.25	54	-9.92	205	295	Average
5149.25	53.43	45.18	8.25	74	-20.57	205	295	Peak
5200	93.55	85.2	8.35			205	295	Average
5200	100.89	92.54	8.35			205	295	Peak
5452.63	42.85	34.03	8.82	54	-11.15	205	295	Average
5452.63	53.55	44.73	8.82	74	-20.45	205	295	Peak
*10400	53.91	39.57	14.34	68.2	-14.29	133	285	Peak
Antenna Polarity & Test Distance: Vertical at 3 m								
Frequency (MHz)	Emission Level (dBuV/m)	Read Level (dBuV)	Factor (dB/m)	Limit (dBuV/m)	Margin (dB)	Antenna Height (cm)	Table Angle (Degree)	Remark
5147.75	44	35.75	8.25	54	-10	169	53	Average
5147.75	53.5	45.25	8.25	74	-20.5	169	53	Peak
5200	92.49	84.14	8.35			169	53	Average
5200	100.19	91.84	8.35			169	53	Peak
5429.53	42.6	33.81	8.79	54	-11.4	169	53	Average
5429.53	53.37	44.58	8.79	74	-20.63	169	53	Peak
*10400	55.27	40.93	14.34	68.2	-12.93	113	245	Peak

Remarks:

- Emission Level = Read Level + Factor
Margin value = Emission level – Limit value
- 5200 MHz: Fundamental Frequency
- *: Out of Restricted Band
- The emission levels of other frequencies were very low against the limit

EUT Test Condition		Measurement Detail	
Channel	Channel 48	Frequency Range	1 GHz ~ 40 GHz
Input Power	120 Vac, 60 Hz	Detector Function	Peak (PK) Average (AV)
Environmental Conditions	25 deg. C, 65 % RH	Tested By	Karl Lee

Antenna Polarity & Test Distance: Horizontal at 3 m								
Frequency (MHz)	Emission Level (dBuV/m)	Read Level (dBuV)	Factor (dB/m)	Limit (dBuV/m)	Margin (dB)	Antenna Height (cm)	Table Angle (Degree)	Remark
5240	93.18	84.74	8.44			205	295	Average
5240	100.87	92.43	8.44			205	295	Peak
5440.2	42.7	33.91	8.79	54	-11.3	205	295	Average
5440.2	53.59	44.8	8.79	74	-20.41	205	295	Peak
*10480	53.49	38.98	14.51	68.2	-14.71	156	360	Peak

Antenna Polarity & Test Distance: Vertical at 3 m								
Frequency (MHz)	Emission Level (dBuV/m)	Read Level (dBuV)	Factor (dB/m)	Limit (dBuV/m)	Margin (dB)	Antenna Height (cm)	Table Angle (Degree)	Remark
5240	92.58	84.14	8.44			169	53	Average
5240	100.45	92.01	8.44			169	53	Peak
5427.33	42.69	33.92	8.77	54	-11.31	169	53	Average
5427.33	54.14	45.37	8.77	74	-19.86	169	53	Peak
*10480	54.72	40.21	14.51	68.2	-13.48	119	24	Peak

Remarks:

- Emission Level = Read Level + Factor
Margin value = Emission level – Limit value
- 5240 MHz: Fundamental Frequency
- *: Out of Restricted Band
- The emission levels of other frequencies were very low against the limit

EUT Test Condition		Measurement Detail	
Channel	Channel 52	Frequency Range	1 GHz ~ 40 GHz
Input Power	120 Vac, 60 Hz	Detector Function	Peak (PK) Average (AV)
Environmental Conditions	25 deg. C, 65 % RH	Tested By	Karl Lee

Antenna Polarity & Test Distance: Horizontal at 3 m								
Frequency (MHz)	Emission Level (dBuV/m)	Read Level (dBuV)	Factor (dB/m)	Limit (dBuV/m)	Margin (dB)	Antenna Height (cm)	Table Angle (Degree)	Remark
5138.45	42.62	34.37	8.25	54	-11.38	200	297	Average
5138.45	53.26	45.01	8.25	74	-20.74	200	297	Peak
5260	96.36	87.9	8.46			200	297	Average
5260	103.42	94.96	8.46			200	297	Peak
*10520	54.13	39.54	14.59	68.2	-14.07	128	48	Peak

Antenna Polarity & Test Distance: Vertical at 3 m								
Frequency (MHz)	Emission Level (dBuV/m)	Read Level (dBuV)	Factor (dB/m)	Limit (dBuV/m)	Margin (dB)	Antenna Height (cm)	Table Angle (Degree)	Remark
5098.85	42.54	34.38	8.16	54	-11.46	187	50	Average
5098.85	52.9	44.74	8.16	74	-21.1	187	50	Peak
5260	95.16	86.7	8.46			187	50	Average
5260	102.78	94.32	8.46			187	50	Peak
*10520	54.28	39.69	14.59	68.2	-13.92	132	208	Peak

Remarks:

- Emission Level = Read Level + Factor
Margin value = Emission level – Limit value
- 5260 MHz: Fundamental Frequency
- *: Out of Restricted Band
- The emission levels of other frequencies were very low against the limit

EUT Test Condition		Measurement Detail	
Channel	Channel 60	Frequency Range	1 GHz ~ 40 GHz
Input Power	120 Vac, 60 Hz	Detector Function	Peak (PK) Average (AV)
Environmental Conditions	25 deg. C, 65 % RH	Tested By	Karl Lee

Antenna Polarity & Test Distance: Horizontal at 3 m								
Frequency (MHz)	Emission Level (dBuV/m)	Read Level (dBuV)	Factor (dB/m)	Limit (dBuV/m)	Margin (dB)	Antenna Height (cm)	Table Angle (Degree)	Remark
5109.35	42.68	34.48	8.2	54	-11.32	200	297	Average
5109.35	53.68	45.48	8.2	74	-20.32	200	297	Peak
5300	96.52	87.98	8.54			200	297	Average
5300	103.26	94.72	8.54			200	297	Peak
5352.09	44.48	35.85	8.63	54	-9.52	200	297	Average
5352.09	54.43	45.8	8.63	74	-19.57	200	297	Peak
10600	46.04	31.36	14.68	54	-7.96	146	209	Average
10600	54.6	39.92	14.68	74	-19.4	146	209	Peak

Antenna Polarity & Test Distance: Vertical at 3 m								
Frequency (MHz)	Emission Level (dBuV/m)	Read Level (dBuV)	Factor (dB/m)	Limit (dBuV/m)	Margin (dB)	Antenna Height (cm)	Table Angle (Degree)	Remark
5122.1	42.77	34.57	8.2	54	-11.23	187	50	Average
5122.1	53.66	45.46	8.2	74	-20.34	187	50	Peak
5300	95.76	87.22	8.54			187	50	Average
5300	102.22	93.68	8.54			187	50	Peak
5351.65	44.86	36.23	8.63	54	-9.14	187	50	Average
5351.65	54.09	45.46	8.63	74	-19.91	187	50	Peak
10600	45.9	31.22	14.68	54	-8.1	174	244	Average
10600	54.78	40.1	14.68	74	-19.22	174	244	Peak

Remarks:

- Emission Level = Read Level + Factor
Margin value = Emission level – Limit value
- 5300 MHz: Fundamental Frequency
- The emission levels of other frequencies were very low against the limit

EUT Test Condition		Measurement Detail	
Channel	Channel 64	Frequency Range	1 GHz ~ 40 GHz
Input Power	120 Vac, 60 Hz	Detector Function	Peak (PK) Average (AV)
Environmental Conditions	25 deg. C, 65 % RH	Tested By	Karl Lee

Antenna Polarity & Test Distance: Horizontal at 3 m								
Frequency (MHz)	Emission Level (dBuV/m)	Read Level (dBuV)	Factor (dB/m)	Limit (dBuV/m)	Margin (dB)	Antenna Height (cm)	Table Angle (Degree)	Remark
5320	96.57	87.99	8.58			200	297	Average
5320	103.33	94.75	8.58			200	297	Peak
5350	47.68	39.05	8.63	54	-6.32	200	297	Average
5350	59.3	50.67	8.63	74	-14.7	200	297	Peak
10640	46.24	31.51	14.73	54	-7.76	135	355	Average
10640	54.3	39.57	14.73	74	-19.7	135	355	Peak
Antenna Polarity & Test Distance: Vertical at 3 m								
Frequency (MHz)	Emission Level (dBuV/m)	Read Level (dBuV)	Factor (dB/m)	Limit (dBuV/m)	Margin (dB)	Antenna Height (cm)	Table Angle (Degree)	Remark
5320	94.49	85.91	8.58			187	50	Average
5320	101.17	92.59	8.58			187	50	Peak
5350.77	48.29	39.66	8.63	54	-5.71	187	50	Average
5350.77	59.48	50.85	8.63	74	-14.52	187	50	Peak
10640	46.17	31.44	14.73	54	-7.83	125	55	Average
10640	54.57	39.84	14.73	74	-19.43	125	55	Peak

Remarks:

- Emission Level = Read Level + Factor
Margin value = Emission level – Limit value
- 5320 MHz: Fundamental Frequency
- The emission levels of other frequencies were very low against the limit

EUT Test Condition		Measurement Detail	
Channel	Channel 100	Frequency Range	1 GHz ~ 40 GHz
Input Power	120 Vac, 60 Hz	Detector Function	Peak (PK) Average (AV)
Environmental Conditions	25 deg. C, 65 % RH	Tested By	Karl Lee

Antenna Polarity & Test Distance: Horizontal at 3 m								
Frequency (MHz)	Emission Level (dBuV/m)	Read Level (dBuV)	Factor (dB/m)	Limit (dBuV/m)	Margin (dB)	Antenna Height (cm)	Table Angle (Degree)	Remark
5458.64	44.67	35.85	8.82	54	-9.33	199	324	Average
5458.64	53.85	45.03	8.82	74	-20.15	199	324	Peak
*5469.36	59.73	50.9	8.83	68.2	-8.47	199	324	Peak
5500	94.25	85.33	8.92			199	324	Average
5500	101.66	92.74	8.92			199	324	Peak
11000	45.04	29.96	15.08	54	-8.96	136	216	Average
11000	54.59	39.51	15.08	74	-19.41	136	216	Peak
Antenna Polarity & Test Distance: Vertical at 3 m								
Frequency (MHz)	Emission Level (dBuV/m)	Read Level (dBuV)	Factor (dB/m)	Limit (dBuV/m)	Margin (dB)	Antenna Height (cm)	Table Angle (Degree)	Remark
5448.56	44.26	35.43	8.83	54	-9.74	114	26	Average
5448.56	54.2	45.37	8.83	74	-19.8	114	26	Peak
*5469.52	58.07	49.24	8.83	68.2	-10.13	114	26	Peak
5500	94.39	85.47	8.92			114	26	Average
5500	101.56	92.64	8.92			114	26	Peak
11000	44.91	29.83	15.08	54	-9.09	190	134	Average
11000	54.45	39.37	15.08	74	-19.55	190	134	Peak

Remarks:

- Emission Level = Read Level + Factor
Margin value = Emission level – Limit value
- 5500 MHz: Fundamental Frequency
- *: Out of Restricted Band
- The emission levels of other frequencies were very low against the limit

EUT Test Condition		Measurement Detail	
Channel	Channel 116	Frequency Range	1 GHz ~ 40 GHz
Input Power	120 Vac, 60 Hz	Detector Function	Peak (PK) Average (AV)
Environmental Conditions	25 deg. C, 65 % RH	Tested By	Karl Lee

Antenna Polarity & Test Distance: Horizontal at 3 m								
Frequency (MHz)	Emission Level (dBuV/m)	Read Level (dBuV)	Factor (dB/m)	Limit (dBuV/m)	Margin (dB)	Antenna Height (cm)	Table Angle (Degree)	Remark
5444.88	42.67	33.85	8.82	54	-11.33	199	324	Average
5444.88	53.96	45.14	8.82	74	-20.04	199	324	Peak
*5469.68	52.49	43.66	8.83	68.2	-15.71	199	324	Peak
5580	94.51	85.52	8.99			199	324	Average
5580	102.84	93.85	8.99			199	324	Peak
*5725.56	51.41	42.25	9.16	68.2	-16.79	199	324	Peak
11600	46.11	30.68	15.43	54	-7.89	195	121	Average
11600	55.71	40.28	15.43	74	-18.29	195	121	Peak

Antenna Polarity & Test Distance: Vertical at 3 m								
Frequency (MHz)	Emission Level (dBuV/m)	Read Level (dBuV)	Factor (dB/m)	Limit (dBuV/m)	Margin (dB)	Antenna Height (cm)	Table Angle (Degree)	Remark
5448.24	42.59	33.76	8.83	54	-11.41	114	26	Average
5448.24	53.88	45.05	8.83	74	-20.12	114	26	Peak
*5469.2	53.08	44.25	8.83	68.2	-15.12	114	26	Peak
5580	94.92	85.93	8.99			114	26	Average
5580	102.67	93.68	8.99			114	26	Peak
*5725.32	53.19	44.03	9.16	68.2	-15.01	114	26	Peak
11600	45.63	30.2	15.43	54	-8.37	184	127	Average
11600	55.08	39.65	15.43	74	-18.92	184	127	Peak

Remarks:

- Emission Level = Read Level + Factor
Margin value = Emission level – Limit value
- 5580 MHz: Fundamental Frequency
- *: Out of Restricted Band
- The emission levels of other frequencies were very low against the limit

EUT Test Condition		Measurement Detail	
Channel	Channel 140	Frequency Range	1 GHz ~ 40 GHz
Input Power	120 Vac, 60 Hz	Detector Function	Peak (PK) Average (AV)
Environmental Conditions	25 deg. C, 65 % RH	Tested By	Karl Lee

Antenna Polarity & Test Distance: Horizontal at 3 m								
Frequency (MHz)	Emission Level (dBuV/m)	Read Level (dBuV)	Factor (dB/m)	Limit (dBuV/m)	Margin (dB)	Antenna Height (cm)	Table Angle (Degree)	Remark
5700	93.2	84.07	9.13			202	324	Average
5700	102.29	93.16	9.13			202	324	Peak
*5725.08	64.49	55.33	9.16	68.2	-3.71	202	324	Peak
11400	46.86	31.76	15.1	54	-7.14	195	168	Average
11400	56.56	41.46	15.1	74	-17.44	195	168	Peak

Antenna Polarity & Test Distance: Vertical at 3 m								
Frequency (MHz)	Emission Level (dBuV/m)	Read Level (dBuV)	Factor (dB/m)	Limit (dBuV/m)	Margin (dB)	Antenna Height (cm)	Table Angle (Degree)	Remark
5700	93.82	84.69	9.13			114	26	Average
5700	102.11	92.98	9.13			114	26	Peak
*5725.08	63.56	54.4	9.16	68.2	-4.64	114	26	Peak
11400	45.32	30.22	15.1	54	-8.68	160	57	Average
11400	54.92	39.82	15.1	74	-19.08	160	57	Peak

Remarks:

- Emission Level = Read Level + Factor
Margin value = Emission level – Limit value
- 5700 MHz: Fundamental Frequency
- *: Out of Restricted Band
- The emission levels of other frequencies were very low against the limit

EUT Test Condition		Measurement Detail	
Channel	Channel 149	Frequency Range	1 GHz ~ 40 GHz
Input Power	120 Vac, 60 Hz	Detector Function	Peak (PK) Average (AV)
Environmental Conditions	25 deg. C, 65 % RH	Tested By	Karl Lee

<Spurious Emission>

Antenna Polarity & Test Distance: Horizontal at 3 m								
Frequency (MHz)	Emission Level (dBuV/m)	Read Level (dBuV)	Factor (dB/m)	Limit (dBuV/m)	Margin (dB)	Antenna Height (cm)	Table Angle (Degree)	Remark
5745	93.39	84.2	9.19			202	327	Average
5745	101.64	92.45	9.19			202	327	Peak
11490	46.13	31.01	15.12	54	-7.87	182	137	Average
11490	55.73	40.61	15.12	74	-18.27	182	137	Peak
Antenna Polarity & Test Distance: Vertical at 3 m								
Frequency (MHz)	Emission Level (dBuV/m)	Read Level (dBuV)	Factor (dB/m)	Limit (dBuV/m)	Margin (dB)	Antenna Height (cm)	Table Angle (Degree)	Remark
5745	93.38	84.19	9.19			103	25	Average
5745	101.25	92.06	9.19			103	25	Peak
11490	45.37	30.25	15.12	54	-8.63	161	124	Average
11490	55.07	39.95	15.12	74	-18.93	161	124	Peak

<Out of Band Emission (OOBE)>

Antenna Polarity & Test Distance: Horizontal at 3 m								
Frequency (MHz)	Emission Level (dBuV/m)	Read Level (dBuV)	Factor (dB/m)	Limit (dBuV/m)	Margin (dB)	Antenna Height (cm)	Table Angle (Degree)	Remark
*5643.325	54.44	45.37	9.07	68.2	-13.76	202	327	Peak
5654.35	52.86	43.77	9.09	71.42	-18.56	202	327	Peak
5920	52.91	43.53	9.38	71.9	-18.99	202	327	Peak
*5948.35	53.69	44.26	9.43	68.2	-14.51	202	327	Peak
Antenna Polarity & Test Distance: Vertical at 3 m								
Frequency (MHz)	Emission Level (dBuV/m)	Read Level (dBuV)	Factor (dB/m)	Limit (dBuV/m)	Margin (dB)	Antenna Height (cm)	Table Angle (Degree)	Remark
*5602.375	53.04	44.01	9.03	68.2	-15.16	103	25	Peak
5653.825	51.56	42.47	9.09	71.03	-19.47	103	25	Peak
5922.1	50.94	41.54	9.4	70.35	-19.41	103	25	Peak
*5974.6	53.13	43.67	9.46	68.2	-15.07	103	25	Peak

Remarks:

- Emission Level = Read Level + Factor
Margin value = Emission level – Limit value
- 5745 MHz: Fundamental Frequency
- *: Out of Restricted Band
- The emission levels of other frequencies were very low against the limit

EUT Test Condition		Measurement Detail	
Channel	Channel 157	Frequency Range	1 GHz ~ 40 GHz
Input Power	120 Vac, 60 Hz	Detector Function	Peak (PK) Average (AV)
Environmental Conditions	25 deg. C, 65 % RH	Tested By	Karl Lee

<Spurious Emission>

Antenna Polarity & Test Distance: Horizontal at 3 m								
Frequency (MHz)	Emission Level (dBuV/m)	Read Level (dBuV)	Factor (dB/m)	Limit (dBuV/m)	Margin (dB)	Antenna Height (cm)	Table Angle (Degree)	Remark
5785	94.21	84.98	9.23			202	327	Average
5785	101.41	92.18	9.23			202	327	Peak
11570	45.82	30.51	15.31	54	-8.18	130	162	Average
11570	55.43	40.12	15.31	74	-18.57	130	162	Peak
Antenna Polarity & Test Distance: Vertical at 3 m								
Frequency (MHz)	Emission Level (dBuV/m)	Read Level (dBuV)	Factor (dB/m)	Limit (dBuV/m)	Margin (dB)	Antenna Height (cm)	Table Angle (Degree)	Remark
5785	94.18	84.95	9.23			103	25	Average
5785	101.38	92.15	9.23			103	25	Peak
11570	45.85	30.54	15.31	54	-8.15	187	12	Average
11570	55.51	40.2	15.31	74	-18.49	187	12	Peak

<Out of Band Emission (OOBE)>

Antenna Polarity & Test Distance: Horizontal at 3 m								
Frequency (MHz)	Emission Level (dBuV/m)	Read Level (dBuV)	Factor (dB/m)	Limit (dBuV/m)	Margin (dB)	Antenna Height (cm)	Table Angle (Degree)	Remark
*5603.425	52.91	43.88	9.03	68.2	-15.29	202	327	Peak
5653.3	52.19	43.09	9.1	70.64	-18.45	202	327	Peak
5920	51.85	42.47	9.38	71.9	-20.05	202	327	Peak
*5947.3	53.42	43.99	9.43	68.2	-14.78	202	327	Peak
Antenna Polarity & Test Distance: Vertical at 3 m								
Frequency (MHz)	Emission Level (dBuV/m)	Read Level (dBuV)	Factor (dB/m)	Limit (dBuV/m)	Margin (dB)	Antenna Height (cm)	Table Angle (Degree)	Remark
*5573.5	53.56	44.57	8.99	68.2	-14.64	103	25	Peak
5653.825	52.45	43.36	9.09	71.03	-18.58	103	25	Peak
5919.475	51.63	42.25	9.38	72.29	-20.66	103	25	Peak
*5960.95	53.58	44.14	9.44	68.2	-14.62	103	25	Peak

Remarks:

- Emission Level = Read Level + Factor
Margin value = Emission level – Limit value
- 5785 MHz: Fundamental Frequency
- *: Out of Restricted Band
- The emission levels of other frequencies were very low against the limit

EUT Test Condition		Measurement Detail	
Channel	Channel 165	Frequency Range	1 GHz ~ 40 GHz
Input Power	120 Vac, 60 Hz	Detector Function	Peak (PK) Average (AV)
Environmental Conditions	25 deg. C, 65 % RH	Tested By	Karl Lee

<Spurious Emission>

Antenna Polarity & Test Distance: Horizontal at 3 m								
Frequency (MHz)	Emission Level (dBuV/m)	Read Level (dBuV)	Factor (dB/m)	Limit (dBuV/m)	Margin (dB)	Antenna Height (cm)	Table Angle (Degree)	Remark
5825	93.84	84.55	9.29			202	327	Average
5825	101.22	91.93	9.29			202	327	Peak
11650	45.32	29.79	15.53	54	-8.68	165	203	Average
11650	54.6	39.07	15.53	74	-19.4	165	203	Peak
Antenna Polarity & Test Distance: Vertical at 3 m								
Frequency (MHz)	Emission Level (dBuV/m)	Read Level (dBuV)	Factor (dB/m)	Limit (dBuV/m)	Margin (dB)	Antenna Height (cm)	Table Angle (Degree)	Remark
5825	93.39	84.1	9.29			103	25	Average
5825	100.78	91.49	9.29			103	25	Peak
11650	46.23	30.7	15.53	54	-7.77	115	88	Average
11650	55.69	40.16	15.53	74	-18.31	115	88	Peak

<Out of Band Emission (OOBE)>

Antenna Polarity & Test Distance: Horizontal at 3 m								
Frequency (MHz)	Emission Level (dBuV/m)	Read Level (dBuV)	Factor (dB/m)	Limit (dBuV/m)	Margin (dB)	Antenna Height (cm)	Table Angle (Degree)	Remark
*5573.5	53.1	44.11	8.99	68.2	-15.1	202	327	Peak
5655.4	52.17	43.08	9.09	72.2	-20.03	202	327	Peak
5921.575	51.33	41.93	9.4	70.73	-19.4	202	327	Peak
*6019.225	53.8	44.29	9.51	68.2	-14.4	202	327	Peak
Antenna Polarity & Test Distance: Vertical at 3 m								
Frequency (MHz)	Emission Level (dBuV/m)	Read Level (dBuV)	Factor (dB/m)	Limit (dBuV/m)	Margin (dB)	Antenna Height (cm)	Table Angle (Degree)	Remark
*5599.75	54.05	45.03	9.02	68.2	-14.15	103	25	Peak
5651.725	53.5	44.41	9.09	69.48	-15.98	103	25	Peak
5920	52.16	42.78	9.38	71.9	-19.74	103	25	Peak
*5960.425	54.05	44.61	9.44	68.2	-14.15	103	25	Peak

Remarks:

- Emission Level = Read Level + Factor
Margin value = Emission level – Limit value
- 5825 MHz: Fundamental Frequency
- *: Out of Restricted Band
- The emission levels of other frequencies were very low against the limit

802.11n (HT40)

EUT Test Condition		Measurement Detail	
Channel	Channel 38	Frequency Range	1 GHz ~ 40 GHz
Input Power	120 Vac, 60 Hz	Detector Function	Peak (PK) Average (AV)
Environmental Conditions	25 deg. C, 65 % RH	Tested By	Karl Lee

Antenna Polarity & Test Distance: Horizontal at 3 m								
Frequency (MHz)	Emission Level (dBuV/m)	Read Level (dBuV)	Factor (dB/m)	Limit (dBuV/m)	Margin (dB)	Antenna Height (cm)	Table Angle (Degree)	Remark
5148.95	50.89	42.64	8.25	54	-3.11	205	295	Average
5148.95	63.1	54.85	8.25	74	-10.9	205	295	Peak
5190	86.59	78.25	8.34			205	295	Average
5190	93.39	85.05	8.34			205	295	Peak
5370.35	43.22	34.55	8.67	54	-10.78	205	295	Average
5370.35	53.42	44.75	8.67	74	-20.58	205	295	Peak
*10380	53.53	39.18	14.35	68.2	-14.67	195	9	Peak

Antenna Polarity & Test Distance: Vertical at 3 m								
Frequency (MHz)	Emission Level (dBuV/m)	Read Level (dBuV)	Factor (dB/m)	Limit (dBuV/m)	Margin (dB)	Antenna Height (cm)	Table Angle (Degree)	Remark
5148.8	50.22	41.97	8.25	54	-3.78	169	53	Average
5148.8	62.44	54.19	8.25	74	-11.56	169	53	Peak
5190	87.48	79.14	8.34			169	53	Average
5190	94.41	86.07	8.34			169	53	Peak
5417.54	42.98	34.25	8.73	54	-11.02	169	53	Average
5417.54	53.69	44.96	8.73	74	-20.31	169	53	Peak
*10380	54.64	40.29	14.35	68.2	-13.56	154	156	Peak

Remarks:

- Emission Level = Read Level + Factor
Margin value = Emission level – Limit value
- 5190 MHz: Fundamental Frequency
- *: Out of Restricted Band
- The emission levels of other frequencies were very low against the limit

EUT Test Condition		Measurement Detail	
Channel	Channel 46	Frequency Range	1 GHz ~ 40 GHz
Input Power	120 Vac, 60 Hz	Detector Function	Peak (PK) Average (AV)
Environmental Conditions	25 deg. C, 65 % RH	Tested By	Karl Lee

Antenna Polarity & Test Distance: Horizontal at 3 m								
Frequency (MHz)	Emission Level (dBuV/m)	Read Level (dBuV)	Factor (dB/m)	Limit (dBuV/m)	Margin (dB)	Antenna Height (cm)	Table Angle (Degree)	Remark
5146.85	42.93	34.68	8.25	54	-11.07	205	295	Average
5146.85	53.26	45.01	8.25	74	-20.74	205	295	Peak
5230	89.21	80.81	8.4			205	295	Average
5230	96.85	88.45	8.4			205	295	Peak
5362.76	42.66	34.02	8.64	54	-11.34	205	295	Average
5362.76	53.25	44.61	8.64	74	-20.75	205	295	Peak
*10460	53.79	39.28	14.51	68.2	-14.41	132	6	Peak
Antenna Polarity & Test Distance: Vertical at 3 m								
Frequency (MHz)	Emission Level (dBuV/m)	Read Level (dBuV)	Factor (dB/m)	Limit (dBuV/m)	Margin (dB)	Antenna Height (cm)	Table Angle (Degree)	Remark
5144.75	42.97	34.72	8.25	54	-11.03	169	53	Average
5144.75	53.44	45.19	8.25	74	-20.56	169	53	Peak
5230	89.51	81.11	8.4			169	53	Average
5230	97.38	88.98	8.4			169	53	Peak
5408.52	42.63	33.91	8.72	54	-11.37	169	53	Average
5408.52	53.66	44.94	8.72	74	-20.34	169	53	Peak
*10460	53.6	39.09	14.51	68.2	-14.6	118	145	Peak

Remarks:

- Emission Level = Read Level + Factor
Margin value = Emission level – Limit value
- 5230 MHz: Fundamental Frequency
- *: Out of Restricted Band
- The emission levels of other frequencies were very low against the limit

EUT Test Condition		Measurement Detail	
Channel	Channel 54	Frequency Range	1 GHz ~ 40 GHz
Input Power	120 Vac, 60 Hz	Detector Function	Peak (PK) Average (AV)
Environmental Conditions	25 deg. C, 65 % RH	Tested By	Karl Lee

Antenna Polarity & Test Distance: Horizontal at 3 m								
Frequency (MHz)	Emission Level (dBuV/m)	Read Level (dBuV)	Factor (dB/m)	Limit (dBuV/m)	Margin (dB)	Antenna Height (cm)	Table Angle (Degree)	Remark
5139.95	43	34.74	8.26	54	-11	200	297	Average
5139.95	53.05	44.79	8.26	74	-20.95	200	297	Peak
5270	93.59	85.1	8.49			200	297	Average
5270	100.72	92.23	8.49			200	297	Peak
5350	44.07	35.44	8.63	54	-9.93	200	297	Average
5350	53.72	45.09	8.63	74	-20.28	200	297	Peak
*10540	54.69	40.07	14.62	68.2	-13.51	165	55	Peak
Antenna Polarity & Test Distance: Vertical at 3 m								
Frequency (MHz)	Emission Level (dBuV/m)	Read Level (dBuV)	Factor (dB/m)	Limit (dBuV/m)	Margin (dB)	Antenna Height (cm)	Table Angle (Degree)	Remark
5081.45	43.01	34.85	8.16	54	-10.99	187	50	Average
5081.45	52.89	44.73	8.16	74	-21.11	187	50	Peak
5270	92.46	83.97	8.49			187	50	Average
5270	99.1	90.61	8.49			187	50	Peak
5351.21	44.07	35.44	8.63	54	-9.93	187	50	Average
5351.21	53.62	44.99	8.63	74	-20.38	187	50	Peak
*10540	53.39	38.77	14.62	68.2	-14.81	153	289	Peak

Remarks:

- Emission Level = Read Level + Factor
Margin value = Emission level – Limit value
- 5270 MHz: Fundamental Frequency
- *: Out of Restricted Band
- The emission levels of other frequencies were very low against the limit

EUT Test Condition		Measurement Detail	
Channel	Channel 62	Frequency Range	1 GHz ~ 40 GHz
Input Power	120 Vac, 60 Hz	Detector Function	Peak (PK) Average (AV)
Environmental Conditions	25 deg. C, 65 % RH	Tested By	Karl Lee

Antenna Polarity & Test Distance: Horizontal at 3 m								
Frequency (MHz)	Emission Level (dBuV/m)	Read Level (dBuV)	Factor (dB/m)	Limit (dBuV/m)	Margin (dB)	Antenna Height (cm)	Table Angle (Degree)	Remark
5146.85	42.92	34.67	8.25	54	-11.08	204	298	Average
5146.85	53.77	45.52	8.25	74	-20.23	204	298	Peak
5310	90.54	81.99	8.55			204	298	Average
5310	97.11	88.56	8.55			204	298	Peak
5350.11	50.57	41.94	8.63	54	-3.43	204	298	Average
5350.11	62.21	53.58	8.63	74	-11.79	204	298	Peak
10620	46.6	31.89	14.71	54	-7.4	155	286	Average
10620	55.07	40.36	14.71	74	-18.93	155	286	Peak

Antenna Polarity & Test Distance: Vertical at 3 m								
Frequency (MHz)	Emission Level (dBuV/m)	Read Level (dBuV)	Factor (dB/m)	Limit (dBuV/m)	Margin (dB)	Antenna Height (cm)	Table Angle (Degree)	Remark
5138.9	43	34.75	8.25	54	-11	187	50	Average
5138.9	53.36	45.11	8.25	74	-20.64	187	50	Peak
5310	89.56	81.01	8.55			187	50	Average
5310	96.34	87.79	8.55			187	50	Peak
5350	50.2	41.57	8.63	54	-3.8	187	50	Average
5350	62.42	53.79	8.63	74	-11.58	187	50	Peak
10620	46.48	31.77	14.71	54	-7.52	138	296	Average
10620	53.91	39.2	14.71	74	-20.09	138	296	Peak

Remarks:

1. Emission Level = Read Level + Factor
Margin value = Emission level – Limit value
2. 5310 MHz: Fundamental Frequency
3. The emission levels of other frequencies were very low against the limit

EUT Test Condition		Measurement Detail	
Channel	Channel 102	Frequency Range	1 GHz ~ 40 GHz
Input Power	120 Vac, 60 Hz	Detector Function	Peak (PK) Average (AV)
Environmental Conditions	25 deg. C, 65 % RH	Tested By	Karl Lee

Antenna Polarity & Test Distance: Horizontal at 3 m								
Frequency (MHz)	Emission Level (dBuV/m)	Read Level (dBuV)	Factor (dB/m)	Limit (dBuV/m)	Margin (dB)	Antenna Height (cm)	Table Angle (Degree)	Remark
5459.92	46.3	37.48	8.82	54	-7.7	199	324	Average
5459.92	59.21	16.34	42.87	74	-14.79	199	324	Peak
*5470	64.97	22.09	42.88	68.2	-3.23	199	324	Peak
5510	89.82	80.91	8.91			199	324	Average
5510	97.04	88.13	8.91			199	324	Peak
*5725.16	51.95	42.79	9.16	68.2	-16.25	199	324	Peak
11020	45.17	30.1	15.07	54	-8.83	126	93	Average
11020	54.86	39.79	15.07	74	-19.14	126	93	Peak

Antenna Polarity & Test Distance: Vertical at 3 m								
Frequency (MHz)	Emission Level (dBuV/m)	Read Level (dBuV)	Factor (dB/m)	Limit (dBuV/m)	Margin (dB)	Antenna Height (cm)	Table Angle (Degree)	Remark
5460	46.59	37.77	8.82	54	-7.41	114	28	Average
5460	56.38	47.56	8.82	74	-17.62	114	28	Peak
*5470	64.98	56.15	8.83	68.2	-3.22	114	28	Peak
5510	89.89	80.98	8.91			114	28	Average
5510	97.43	88.52	8.91			114	28	Peak
*5725.4	52.71	43.55	9.16	68.2	-15.49	114	28	Peak
11020	44.67	29.6	15.07	54	-9.33	131	168	Average
11020	54.32	39.25	15.07	74	-19.68	131	168	Peak

Remarks:

- Emission Level = Read Level + Factor
Margin value = Emission level – Limit value
- 5510 MHz: Fundamental Frequency
- *: Out of Restricted Band
- The emission levels of other frequencies were very low against the limit

EUT Test Condition		Measurement Detail	
Channel	Channel 110	Frequency Range	1 GHz ~ 40 GHz
Input Power	120 Vac, 60 Hz	Detector Function	Peak (PK) Average (AV)
Environmental Conditions	25 deg. C, 65 % RH	Tested By	Karl Lee

Antenna Polarity & Test Distance: Horizontal at 3 m								
Frequency (MHz)	Emission Level (dBuV/m)	Read Level (dBuV)	Factor (dB/m)	Limit (dBuV/m)	Margin (dB)	Antenna Height (cm)	Table Angle (Degree)	Remark
5446.48	43.15	34.32	8.83	54	-10.85	202	324	Average
5446.48	53.83	45	8.83	74	-20.17	202	324	Peak
*5469.36	53.16	44.33	8.83	68.2	-15.04	202	324	Peak
5550	91.33	82.36	8.97			202	324	Average
5550	98.96	89.99	8.97			202	324	Peak
*5725.96	51.75	42.59	9.16	68.2	-16.45	202	324	Peak
11100	44.96	29.87	15.09	54	-9.04	190	31	Average
11100	54.42	39.33	15.09	74	-19.58	190	31	Peak

Antenna Polarity & Test Distance: Vertical at 3 m								
Frequency (MHz)	Emission Level (dBuV/m)	Read Level (dBuV)	Factor (dB/m)	Limit (dBuV/m)	Margin (dB)	Antenna Height (cm)	Table Angle (Degree)	Remark
5447.44	43.18	34.35	8.83	54	-10.82	114	28	Average
5447.44	53.64	44.81	8.83	74	-20.36	114	28	Peak
*5469.84	52.78	43.95	8.83	68.2	-15.42	114	28	Peak
5550	91.86	82.89	8.97			114	28	Average
5550	99.04	90.07	8.97			114	28	Peak
*5725.32	52.04	42.88	9.16	68.2	-16.16	114	28	Peak
11100	45.81	30.72	15.09	54	-8.19	164	125	Average
11100	55.27	40.18	15.09	74	-18.73	164	125	Peak

Remarks:

- Emission Level = Read Level + Factor
Margin value = Emission level – Limit value
- 5550 MHz: Fundamental Frequency
- *: Out of Restricted Band
- The emission levels of other frequencies were very low against the limit

EUT Test Condition		Measurement Detail	
Channel	Channel 134	Frequency Range	1 GHz ~ 40 GHz
Input Power	120 Vac, 60 Hz	Detector Function	Peak (PK) Average (AV)
Environmental Conditions	25 deg. C, 65 % RH	Tested By	Karl Lee

Antenna Polarity & Test Distance: Horizontal at 3 m								
Frequency (MHz)	Emission Level (dBuV/m)	Read Level (dBuV)	Factor (dB/m)	Limit (dBuV/m)	Margin (dB)	Antenna Height (cm)	Table Angle (Degree)	Remark
5444.08	42.64	33.85	8.79	54	-11.36	192	324	Average
5444.08	52.93	44.14	8.79	74	-21.07	192	324	Peak
*5469.2	51.94	43.11	8.83	68.2	-16.26	192	324	Peak
5670	91.08	81.98	9.1			192	324	Average
5670	98.72	89.62	9.1			192	324	Peak
*5724.92	58.97	49.81	9.16	68.2	-9.23	192	324	Peak
11340	45.74	30.65	15.09	54	-8.26	169	216	Average
11340	55.15	40.06	15.09	74	-18.85	169	216	Peak

Antenna Polarity & Test Distance: Vertical at 3 m								
Frequency (MHz)	Emission Level (dBuV/m)	Read Level (dBuV)	Factor (dB/m)	Limit (dBuV/m)	Margin (dB)	Antenna Height (cm)	Table Angle (Degree)	Remark
5458.32	42.57	33.75	8.82	54	-11.43	110	26	Average
5458.32	53.39	44.57	8.82	74	-20.61	110	26	Peak
*5469.04	52.04	43.21	8.83	68.2	-16.16	110	26	Peak
5670	90.73	81.63	9.1			110	26	Average
5670	98.8	89.7	9.1			110	26	Peak
*5726.04	55.66	46.5	9.16	68.2	-12.54	110	26	Peak
11340	45.71	30.62	15.09	54	-8.29	128	167	Average
11340	55.14	40.05	15.09	74	-18.86	128	167	Peak

Remarks:

- Emission Level = Read Level + Factor
Margin value = Emission level – Limit value
- 5670 MHz: Fundamental Frequency
- *: Out of Restricted Band
- The emission levels of other frequencies were very low against the limit

EUT Test Condition		Measurement Detail	
Channel	Channel 151	Frequency Range	1 GHz ~ 40 GHz
Input Power	120 Vac, 60 Hz	Detector Function	Peak (PK) Average (AV)
Environmental Conditions	25 deg. C, 65 % RH	Tested By	Karl Lee

<Spurious Emission>

Antenna Polarity & Test Distance: Horizontal at 3 m								
Frequency (MHz)	Emission Level (dBuV/m)	Read Level (dBuV)	Factor (dB/m)	Limit (dBuV/m)	Margin (dB)	Antenna Height (cm)	Table Angle (Degree)	Remark
5755	90.27	81.06	9.21			202	327	Average
5755	98.26	89.05	9.21			202	327	Peak
11510	46.38	31.27	15.11	54	-7.62	182	239	Average
11510	55.67	40.56	15.11	74	-18.33	182	239	Peak
Antenna Polarity & Test Distance: Vertical at 3 m								
Frequency (MHz)	Emission Level (dBuV/m)	Read Level (dBuV)	Factor (dB/m)	Limit (dBuV/m)	Margin (dB)	Antenna Height (cm)	Table Angle (Degree)	Remark
5755	90.27	81.06	9.21			103	25	Average
5755	98.15	88.94	9.21			103	25	Peak
11510	45.71	30.6	15.11	54	-8.29	150	256	Average
11510	55.31	40.2	15.11	74	-18.69	150	256	Peak

<Out of Band Emission (OOBE)>

Antenna Polarity & Test Distance: Horizontal at 3 m								
Frequency (MHz)	Emission Level (dBuV/m)	Read Level (dBuV)	Factor (dB/m)	Limit (dBuV/m)	Margin (dB)	Antenna Height (cm)	Table Angle (Degree)	Remark
*5620.75	53.47	44.42	9.05	68.2	-14.73	202	327	Peak
5653.3	51.71	42.61	9.1	70.64	-18.93	202	327	Peak
5920	52.16	42.78	9.38	71.9	-19.74	202	327	Peak
*5931.025	52.99	43.59	9.4	68.2	-15.21	202	327	Peak
Antenna Polarity & Test Distance: Vertical at 3 m								
Frequency (MHz)	Emission Level (dBuV/m)	Read Level (dBuV)	Factor (dB/m)	Limit (dBuV/m)	Margin (dB)	Antenna Height (cm)	Table Angle (Degree)	Remark
*5590.825	52.69	43.68	9.01	68.2	-15.51	103	25	Peak
5653.3	51.97	42.87	9.1	70.64	-18.67	103	25	Peak
5923.675	53.5	44.1	9.4	69.18	-15.68	103	25	Peak
*5961.475	53.8	44.36	9.44	68.2	-14.4	103	25	Peak

Remarks:

- Emission Level = Read Level + Factor
Margin value = Emission level – Limit value
- 5755 MHz: Fundamental Frequency
- *: Out of Restricted Band
- The emission levels of other frequencies were very low against the limit

EUT Test Condition		Measurement Detail	
Channel	Channel 159	Frequency Range	1 GHz ~ 40 GHz
Input Power	120 Vac, 60 Hz	Detector Function	Peak (PK) Average (AV)
Environmental Conditions	25 deg. C, 65 % RH	Tested By	Karl Lee

<Spurious Emission>

Antenna Polarity & Test Distance: Horizontal at 3 m								
Frequency (MHz)	Emission Level (dBuV/m)	Read Level (dBuV)	Factor (dB/m)	Limit (dBuV/m)	Margin (dB)	Antenna Height (cm)	Table Angle (Degree)	Remark
5795	90.43	81.19	9.24			202	327	Average
5795	97.89	88.65	9.24			202	327	Peak
11590	45.92	30.55	15.37	54	-8.08	185	127	Average
11590	55.52	40.15	15.37	74	-18.48	185	127	Peak
Antenna Polarity & Test Distance: Vertical at 3 m								
Frequency (MHz)	Emission Level (dBuV/m)	Read Level (dBuV)	Factor (dB/m)	Limit (dBuV/m)	Margin (dB)	Antenna Height (cm)	Table Angle (Degree)	Remark
5795	90.59	81.35	9.24			103	25	Average
5795	98.11	88.87	9.24			103	25	Peak
11590	45.28	29.91	15.37	54	-8.72	160	261	Average
11590	55.04	39.67	15.37	74	-18.96	160	261	Peak

<Out of Band Emission (OOBE)>

Antenna Polarity & Test Distance: Horizontal at 3 m								
Frequency (MHz)	Emission Level (dBuV/m)	Read Level (dBuV)	Factor (dB/m)	Limit (dBuV/m)	Margin (dB)	Antenna Height (cm)	Table Angle (Degree)	Remark
*5556.175	53.93	44.96	8.97	68.2	-14.27	202	327	Peak
5654.35	52.33	43.24	9.09	71.42	-19.09	202	327	Peak
5920	53.71	44.33	9.38	71.9	-18.19	202	327	Peak
*5991.925	53.36	43.87	9.49	68.2	-14.84	202	327	Peak
Antenna Polarity & Test Distance: Vertical at 3 m								
Frequency (MHz)	Emission Level (dBuV/m)	Read Level (dBuV)	Factor (dB/m)	Limit (dBuV/m)	Margin (dB)	Antenna Height (cm)	Table Angle (Degree)	Remark
*5526.775	53.38	44.45	8.93	68.2	-14.82	103	25	Peak
5653.3	51.16	42.06	9.1	70.64	-19.48	103	25	Peak
5920	51.45	42.07	9.38	71.9	-20.45	103	25	Peak
*5971.45	54.48	45.03	9.45	68.2	-13.72	103	25	Peak

Remarks:

- Emission Level = Read Level + Factor
Margin value = Emission level – Limit value
- 5795 MHz: Fundamental Frequency
- *: Out of Restricted Band
- The emission levels of other frequencies were very low against the limit

9 kHz ~ 30 MHz Data:

The amplitude of spurious emissions attenuated more than 20 dB below the permissible value is not required to be report.

30 MHz ~ 1 GHz Worst-Case Data:

802.11n (HT40)

EUT Test Condition		Measurement Detail	
Channel	Channel 38	Frequency Range	30 MHz ~ 1 GHz
Input Power	120 Vac, 60 Hz	Detector Function	Peak (PK) Quasi-peak (QP)
Environmental Conditions	25 deg. C, 65 % RH	Tested By	Karl Lee

Horizontal

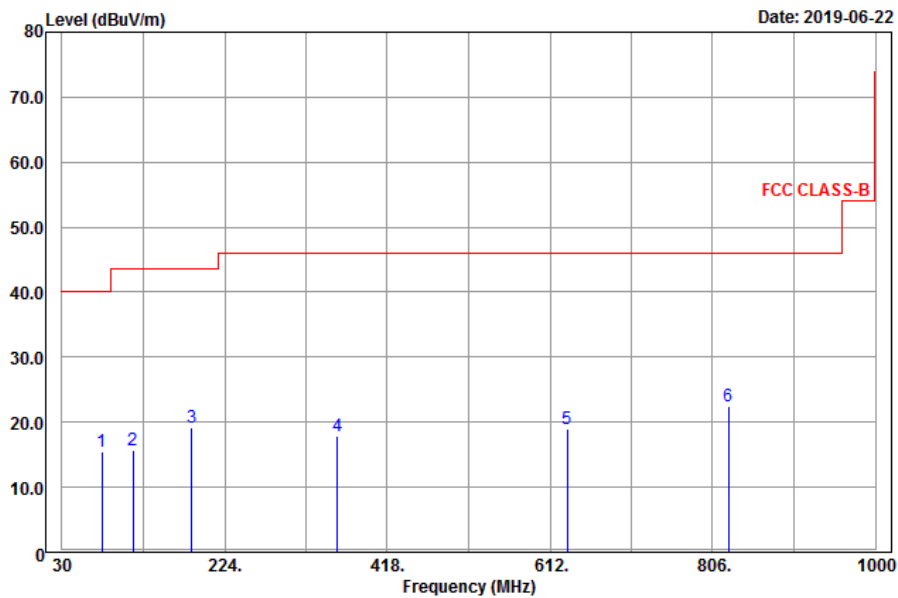

Vertical

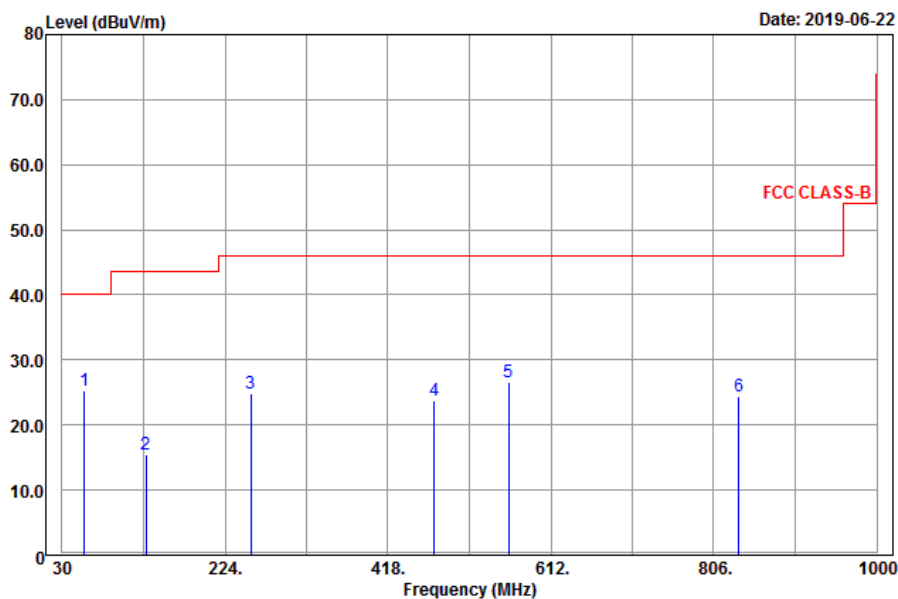

Antenna Polarity & Test Distance: Horizontal at 3 m

Frequency (MHz)	Emission Level (dBuV/m)	Read Level (dBuV)	Factor (dB/m)	Limit (dBuV/m)	Margin (dB)	Antenna Height (cm)	Table Angle (Degree)	Remark
77.79	15.4	38.18	-22.78	40	-24.6	130	205	Peak
115.05	15.73	35.4	-19.67	43.5	-27.77	190	165	Peak
184.44	19.24	39.76	-20.52	43.5	-24.26	135	168	Peak
358.8	17.8	33.29	-15.49	46	-28.2	178	164	Peak
632.5	18.88	29.88	-11	46	-27.12	136	222	Peak
825	22.39	30.22	-7.83	46	-23.61	159	235	Peak

Antenna Polarity & Test Distance: Vertical at 3 m

Frequency (MHz)	Emission Level (dBuV/m)	Read Level (dBuV)	Factor (dB/m)	Limit (dBuV/m)	Margin (dB)	Antenna Height (cm)	Table Angle (Degree)	Remark
56.73	25.2	42.7	-17.5	40	-14.8	160	121	Peak
130.17	15.46	37.35	-21.89	43.5	-28.04	197	164	Peak
254.64	24.83	42.59	-17.76	46	-21.17	136	227	Peak
473.6	23.77	37.38	-13.61	46	-22.23	146	187	Peak
561.8	26.52	38.65	-12.13	46	-19.48	190	223	Peak
836.2	24.48	32.13	-7.65	46	-21.52	120	134	Peak

Remarks:

- Emission Level = Read Level + Factor
Margin value = Emission level – Limit value
- The emission levels of other frequencies were very low against the limit

4.2 Conducted Emission Measurement

4.2.1 Limits of Conducted Emission Measurement

Frequency (MHz)	Conducted Limit (dBuV)	
	Quasi-Peak	Average
0.15 - 0.5	66 - 56	56 - 46
0.50 - 5.0	56	46
5.0 - 30.0	60	50

- Note: 1. The lower limit shall apply at the transition frequencies.
 2. The limit decreases in line with the logarithm of the frequency in the range of 0.15 to 0.50 MHz.

4.2.2 Test Instruments

Description & Manufacturer	Model No.	Serial No.	Date of Calibration	Due Date of Calibration
Test Receiver ROHDE & SCHWARZ	ESCI	100613	Dec. 10, 2018	Dec. 09, 2019
RF signal cable Woken	5D-FB	Cable-cond1-01	Sep. 05, 2018	Sep. 04, 2019
LISN/AMN ROHDE & SCHWARZ (EUT)	ENV216	101826	Feb. 21, 2019	Feb. 20, 2020
LISN/AMN ROHDE & SCHWARZ (Peripheral)	ESH3-Z5	100311	Aug. 19, 2018	Aug. 18, 2019
Software ADT	BV ADT_Cond_ V7.3.7.4	NA	NA	NA

- Note: 1. The calibration interval of the above test instruments is 12 months and the calibrations are traceable to NML/ROC and NIST/USA.
 2. The test was performed in HwaYa Shielded Room 1.
 3. The VCCI Site Registration No. is C-12040.

4.2.3 Test Procedures

- a. The EUT was placed 0.4 meters from the conducting wall of the shielded room with EUT being connected to the power mains through a line impedance stabilization network (LISN). Other support units were connected to the power mains through another LISN. The two LISNs provide 50 ohm/ 50uH of coupling impedance for the measuring instrument.
- b. Both lines of the power mains connected to the EUT were checked for maximum conducted interference.
- c. The frequency range from 150 kHz to 30 MHz was searched. Emission levels under (Limit -20 dB) was not recorded.

Note: All modes of operation were investigated and the worst-case emissions are reported.

4.2.4 Deviation from Test Standard

No deviation.

4.2.5 Test Setup

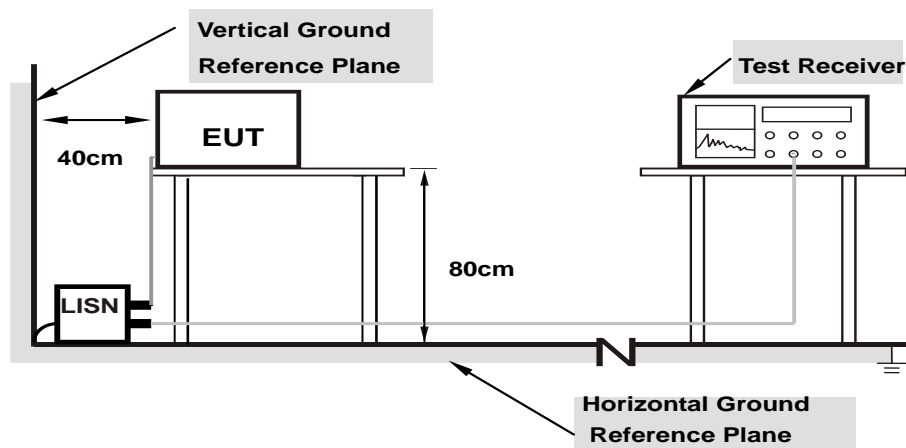

- Note:**
- 1.Support units were connected to second LISN.
 - 2.Both of LISNs (AMN) are 80 cm from EUT and at least 80 from other units and other metal planes

For the actual test configuration, please refer to the attached file (Test Setup Photo).

4.2.6 EUT Operating Conditions

- a. Placed the EUT on a testing table.
- b. Use the software to control the EUT under transmission condition continuously at specific channel frequency.

4.2.7 Test Results

Frequency Range	150kHz ~ 30MHz	Detector Function & Resolution Bandwidth	Quasi-Peak (QP) / Average (AV), 9kHz
Input Power	120Vac, 60Hz	Environmental Conditions	25°C, 65%RH
Tested by	Thomas Wei	Test Date	2019/6/25

Phase Of Power : Line (L)										
No	Frequency (MHz)	Correction Factor (dB)	Reading Value (dBuV)		Emission Level (dBuV)		Limit (dBuV)		Margin (dB)	
			Q.P.	AV.	Q.P.	AV.	Q.P.	AV.	Q.P.	AV.
1	0.18122	9.85	31.02	20.13	40.87	29.98	64.43	54.43	-23.56	-24.45
2	0.30696	9.87	29.59	16.96	39.46	26.83	60.05	50.05	-20.59	-23.22
3	0.59158	9.89	30.35	16.80	40.24	26.69	56.00	46.00	-15.76	-19.31
4	0.75984	9.90	32.99	17.30	42.89	27.20	56.00	46.00	-13.11	-18.80
5	2.18711	9.96	36.35	22.22	46.31	32.18	56.00	46.00	-9.69	-13.82
6	4.84982	10.04	27.54	7.46	37.58	17.50	56.00	46.00	-18.42	-28.50

Remarks:

1. Q.P. and AV. are abbreviations of quasi-peak and average individually.
2. The emission levels of other frequencies were very low against the limit.
3. Margin value = Emission level – Limit value
4. Correction factor = Insertion loss + Cable loss
5. Emission Level = Correction Factor + Reading Value

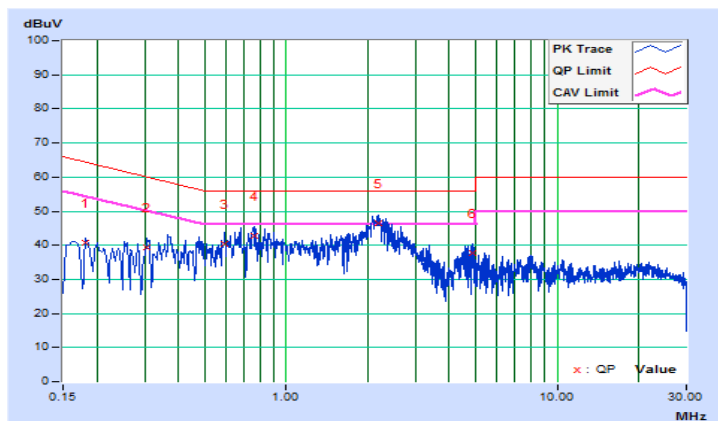

Frequency Range	150kHz ~ 30MHz	Detector Function & Resolution Bandwidth	Quasi-Peak (QP) / Average (AV), 9kHz
Input Power	120Vac, 60Hz	Environmental Conditions	25°C, 65%RH
Tested by	Thomas Wei	Test Date	2019/6/25

Phase Of Power : Neutral (N)										
No	Frequency (MHz)	Correction Factor (dB)	Reading Value (dBuV)		Emission Level (dBuV)		Limit (dBuV)		Margin (dB)	
			Q.P.	AV.	Q.P.	AV.	Q.P.	AV.	Q.P.	AV.
1	0.17744	9.83	29.89	15.57	39.72	25.40	64.60	54.60	-24.88	-29.20
2	0.26207	9.85	29.07	13.75	38.92	23.60	61.37	51.37	-22.45	-27.77
3	0.36505	9.86	29.85	18.64	39.71	28.50	58.61	48.61	-18.90	-20.11
4	0.79465	9.88	30.84	19.76	40.72	29.64	56.00	46.00	-15.28	-16.36
5	2.22230	9.94	36.20	22.21	46.14	32.15	56.00	46.00	-9.86	-13.85
6	4.68951	10.02	26.11	12.34	36.13	22.36	56.00	46.00	-19.87	-23.64

Remarks:

1. Q.P. and AV. are abbreviations of quasi-peak and average individually.
2. The emission levels of other frequencies were very low against the limit.
3. Margin value = Emission level – Limit value
4. Correction factor = Insertion loss + Cable loss
5. Emission Level = Correction Factor + Reading Value

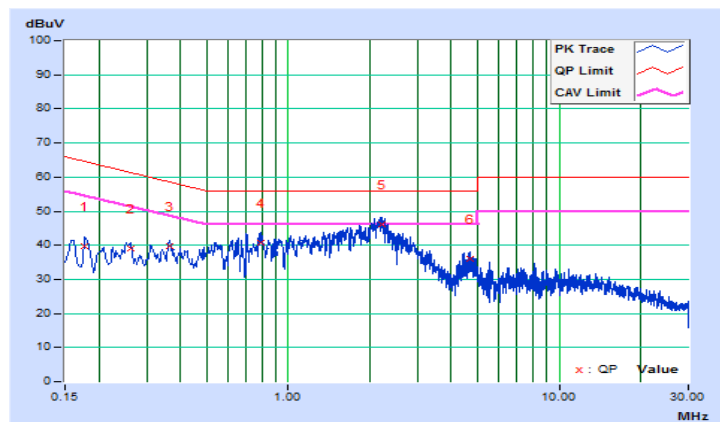

4.3 Transmit Power Measurement

4.3.1 Limits of Transmit Power Measurement

Operation Band	EUT Category		Limit
U-NII-1		Outdoor Access Point	1 Watt (30 dBm) (Max. e.i.r.p \leq 125 mW (21 dBm) at any elevation angle above 30 degrees as measured from the horizon)
		Fixed point-to-point Access Point	1 Watt (30 dBm)
		Indoor Access Point	1 Watt (30 dBm)
	√	Mobile and Portable client device	250 mW (24 dBm)
U-NII-2A		√	250 mW (24 dBm) or 11 dBm + 10 log B*
U-NII-2C		√	250 mW (24 dBm) or 11 dBm + 10 log B*
U-NII-3		√	1 Watt (30 dBm)

*B is the 26 dB emission bandwidth in megahertz

4.3.2 Test Setup

<Power Output Measurement>

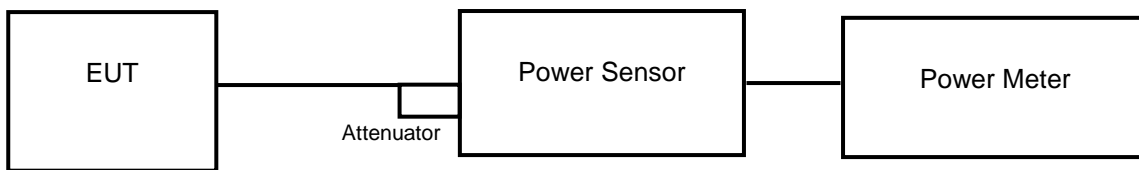

<26 dB Bandwidth>

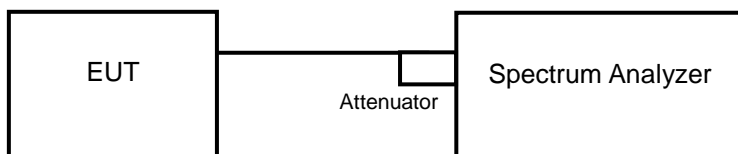

4.3.3 Test Instruments

Refer to section 4.1.2 to get information of above instrument.

4.3.4 Test Procedure

Average Power Measurement

<802.11a, 802.11n (HT20), 802.11n (HT40)>

Method PM is used to perform output power measurement, trigger and gating function of wide band power meter is enabled to measure max output power of TX on burst. Duty factor is not added to measured value.

26 dB Bandwidth

- a. Set RBW = approximately 1 % of the emission bandwidth.
- b. Set the VBW > RBW.
- c. Detector = Peak.
- d. Trace mode = max hold.
- e. Measure the maximum width of the emission that is 26 dB down from the peak of the emission. Compare this with the RBW setting of the analyzer. Readjust RBW and repeat measurement as needed until the RBW/EBW ratio is approximately 1 %.

4.3.5 Deviation from Test Standard

No deviation.

4.3.6 EUT Operating Conditions

The software provided by client to enable the EUT under transmission condition continuously at lowest, middle and highest channel frequencies individually.

4.3.7 Test Results

Power Output:

802.11a

Channel	Frequency (MHz)	Maximum Conducted Power (mW)	Maximum Conducted Power (dBm)	Power Limit (dBm)	Pass / Fail
36	5180	10.593	10.25	24	Pass
40	5200	10.544	10.23	24	Pass
48	5240	10.351	10.15	24	Pass
52	5260	11.169	10.48	24	Pass
60	5300	9.484	9.77	24	Pass
64	5320	9.036	9.56	24	Pass
100	5500	9.162	9.62	24	Pass
116	5580	10.304	10.13	24	Pass
140	5700	7.980	9.02	24	Pass
149	5745	12.618	11.01	30	Pass
157	5785	10.940	10.39	30	Pass
165	5825	9.750	9.89	30	Pass

Note:

For U-NII-2A, U-NII-2C Band:

1. $11 \text{ dBm} + 10\log(37.66) = 26.75 \text{ dBm} > 24 \text{ dBm}$.
2. $11 \text{ dBm} + 10\log(31.86) = 26.03 \text{ dBm} > 24 \text{ dBm}$.
3. $11 \text{ dBm} + 10\log(33.80) = 26.28 \text{ dBm} > 24 \text{ dBm}$.
4. $11 \text{ dBm} + 10\log(28.74) = 25.58 \text{ dBm} > 24 \text{ dBm}$.
5. $11 \text{ dBm} + 10\log(32.20) = 26.07 \text{ dBm} > 24 \text{ dBm}$.
6. $11 \text{ dBm} + 10\log(29.20) = 25.65 \text{ dBm} > 24 \text{ dBm}$.

802.11n (HT20)

Channel	Frequency (MHz)	Maximum Conducted Power (mW)	Maximum Conducted Power (dBm)	Power Limit (dBm)	Pass / Fail
36	5180	10.789	10.33	24	Pass
40	5200	14.689	11.67	24	Pass
48	5240	13.996	11.46	24	Pass
52	5260	15.524	11.91	24	Pass
60	5300	13.305	11.24	24	Pass
64	5320	12.912	11.11	24	Pass
100	5500	12.972	11.13	24	Pass
116	5580	14.223	11.53	24	Pass
140	5700	10.940	10.39	24	Pass
149	5745	12.218	10.87	30	Pass
157	5785	11.272	10.52	30	Pass
165	5825	9.840	9.93	30	Pass

Note:

For U-NII-2A, U-NII-2C Band:

1. $11 \text{ dBm} + 10\log(44.72) = 27.50 \text{ dBm} > 24 \text{ dBm}$.
2. $11 \text{ dBm} + 10\log(42.67) = 27.30 \text{ dBm} > 24 \text{ dBm}$.
3. $11 \text{ dBm} + 10\log(42.41) = 27.27 \text{ dBm} > 24 \text{ dBm}$.
4. $11 \text{ dBm} + 10\log(42.88) = 27.32 \text{ dBm} > 24 \text{ dBm}$.
5. $11 \text{ dBm} + 10\log(45.49) = 27.57 \text{ dBm} > 24 \text{ dBm}$.
6. $11 \text{ dBm} + 10\log(39.47) = 26.96 \text{ dBm} > 24 \text{ dBm}$.

802.11n (HT40)

Channel	Frequency (MHz)	Maximum Conducted Power (mW)	Maximum Conducted Power (dBm)	Power Limit (dBm)	Pass / Fail
38	5190	6.871	8.37	24	Pass
46	5230	12.589	11.00	24	Pass
54	5270	13.552	11.32	24	Pass
62	5310	5.821	7.65	24	Pass
102	5510	7.295	8.63	24	Pass
110	5550	12.706	11.04	24	Pass
134	5670	11.272	10.52	24	Pass
151	5755	11.272	10.52	30	Pass
159	5795	10.940	10.39	30	Pass

Note:

For U-NII-2A, U-NII-2C Band:

1. $11 \text{ dBm} + 10\log(71.16) = 29.52 \text{ dBm} > 24 \text{ dBm}$.
2. $11 \text{ dBm} + 10\log(44.28) = 27.46 \text{ dBm} > 24 \text{ dBm}$.
3. $11 \text{ dBm} + 10\log(50.45) = 28.02 \text{ dBm} > 24 \text{ dBm}$.
4. $11 \text{ dBm} + 10\log(74.49) = 29.72 \text{ dBm} > 24 \text{ dBm}$.
5. $11 \text{ dBm} + 10\log(72.13) = 29.58 \text{ dBm} > 24 \text{ dBm}$.

26 dB Bandwidth:
802.11a

Channel	Frequency (MHz)	26 dBc Bandwidth (MHz)
36	5180	32.06
40	5200	35.67
48	5240	29.37
52	5260	37.66
60	5300	31.86
64	5320	33.80
100	5500	28.74
116	5580	32.20
140	5700	29.20

802.11n (HT20)

Channel	Frequency (MHz)	26 dBc Bandwidth (MHz)
36	5180	41.80
40	5200	43.02
48	5240	44.01
52	5260	44.72
60	5300	42.67
64	5320	42.41
100	5500	42.88
116	5580	45.49
140	5700	39.47

802.11n (HT40)

Channel	Frequency (MHz)	26 dBc Bandwidth (MHz)
38	5190	43.26
46	5230	71.89
54	5270	71.16
62	5310	44.28
102	5510	50.45
110	5550	74.49
134	5670	72.13

Spectrum Plot of Worst Value

802.11a

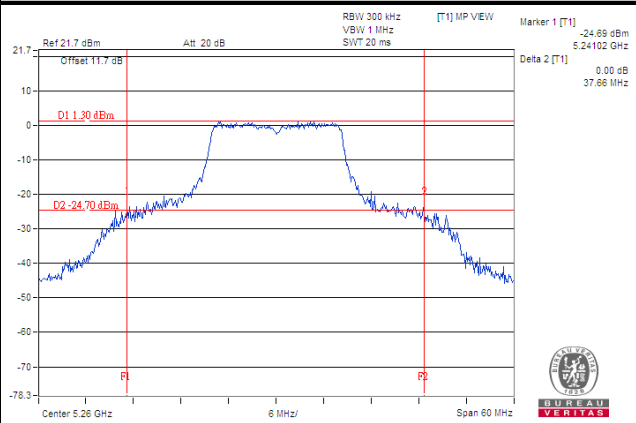

802.11n (HT20)

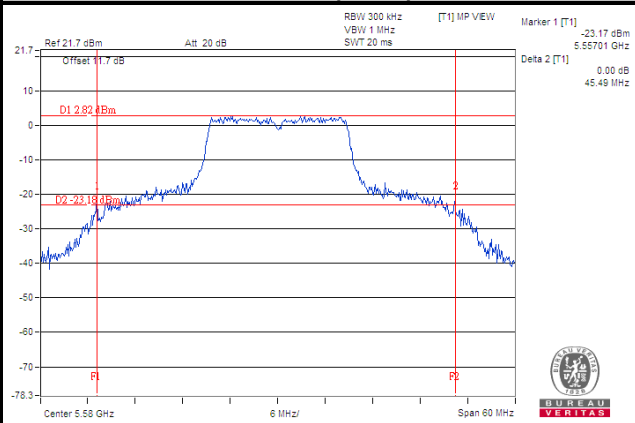

802.11n (HT40)

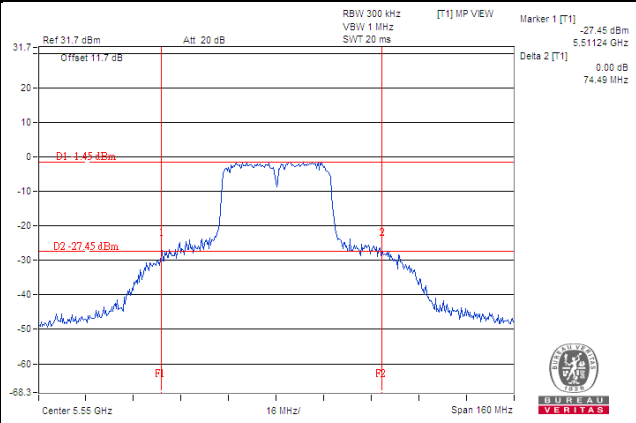

4.4 Occupied Bandwidth Measurement

4.4.1 Test Setup

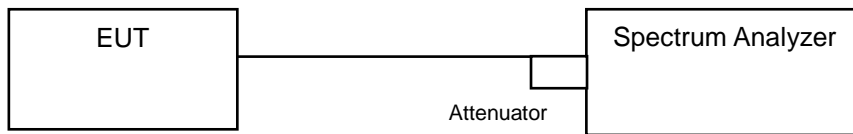

4.4.2 Test Instruments

Refer to section 4.1.2 to get information of above instrument.

4.4.3 Test Procedure

The transmitter output was connected to the spectrum analyzer through an attenuator. The bandwidth of the fundamental frequency was measured by spectrum analyzer with resolution bandwidth in the range of 1 % to 5 % of the anticipated emission bandwidth, and a video bandwidth at least 3x the resolution bandwidth and set the detector to SAMPLE. The width of a frequency band such that, below the lower and above the upper frequency limits, the mean powers emitted are each equal to a specified percentage 0.5 % of the total mean power of a given emission.

4.4.4 Test Results

802.11a

Channel	Channel Frequency (MHz)	Occupied Bandwidth (MHz)
36	5180	17.16
40	5200	17.52
48	5240	17.28
52	5260	17.28
60	5300	17.40
64	5320	17.40
100	5500	16.92
116	5580	17.16
140	5700	17.28
149	5745	18.00
157	5785	17.76
165	5825	17.40

802.11n (HT20)

Channel	Channel Frequency (MHz)	Occupied Bandwidth (MHz)
36	5180	18.60
40	5200	19.32
48	5240	19.56
52	5260	20.04
60	5300	19.08
64	5320	19.56
100	5500	18.60
116	5580	19.20
140	5700	18.48
149	5745	18.72
157	5785	18.48
165	5825	18.36

802.11n (HT40)

Channel	Channel Frequency (MHz)	Occupied Bandwidth (MHz)
38	5190	36.60
46	5230	36.96
54	5270	36.96
62	5310	36.60
102	5510	36.60
110	5550	36.84
134	5670	36.72
151	5755	36.84
159	5795	36.84

Spectrum Plot of Worst Value

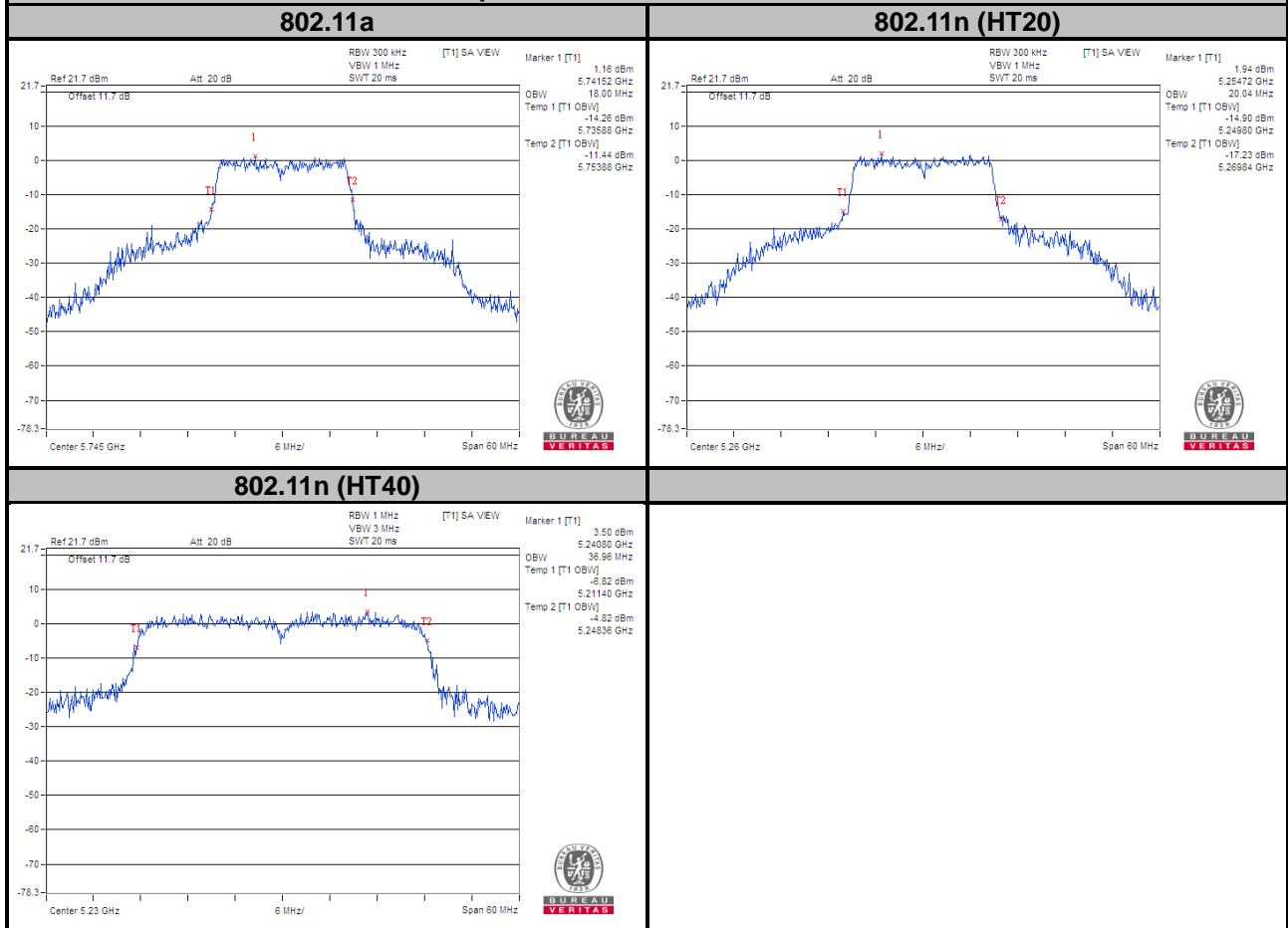

4.5 Peak Power Spectral Density Measurement

4.5.1 Limits of Peak Power Spectral Density Measurement

Operation Band	EUT Category		Limit
U-NII-1		Outdoor Access Point	17 dBm/MHz
		Fixed point-to-point Access Point	
		Indoor Access Point	
	√	Mobile and Portable client device	11 dBm/MHz
U-NII-2A		√	11 dBm/MHz
U-NII-2C		√	11 dBm/MHz
U-NII-3		√	30 dBm/500 kHz

4.5.2 Test Setup

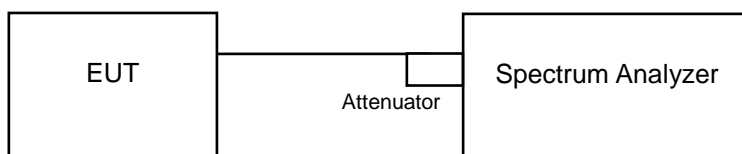

4.5.3 Test Instruments

Refer to section 4.1.3 to get information of above instrument.

4.5.4 Test Procedures

For U-NII-1, U-NII-2A, U-NII-2C band:

Using method SA-2

1. Set span to encompass the entire emission bandwidth (EBW) of the signal.
2. Set RBW = 1 MHz, Set VBW \geq 3 RBW, Detector = RMS
3. Sweep time = auto, trigger set to "free run".
4. Trace average at least 100 traces in power averaging mode.
5. Record the max value and add $10 \log (1/\text{duty cycle})$

※For U-NII-3:

1. Set span to encompass the entire emission bandwidth (EBW) of the signal.
2. Set RBW = 300 kHz, Set VBW \geq 1 RBW, Detector = RMS
3. Use the peak marker function to determine the maximum power level in any 300 kHz band segment within the fundamental EBW.
4. Scale the observed power level to an equivalent value in 500 kHz by adjusting (reducing) the measured power by a bandwidth correction factor (BWCF) where $\text{BWCF} = 10\log(500 \text{ kHz} / 300 \text{ kHz})$.
5. Sweep time = auto, trigger set to "free run".
6. Trace average at least 100 traces in power averaging mode.
7. Record the max value and add $10 \log (1/\text{duty cycle})$

4.5.5 Deviation from Test Standard

No deviation.

4.5.6 EUT Operating Conditions

The software provided by client to enable the EUT under transmission condition continuously at lowest, middle and highest channel frequencies individually.

4.5.7 Test Results

802.11a

Channel	Frequency (MHz)	PSD w/o Duty Factor (dBm/MHz)	Duty Factor (dB)	PSD with Duty Factor (dBm/MHz)	Maximum Limit (dBm/MHz)	Pass / Fail
36	5180	-4.42	0.69	-3.73	11	Pass
40	5200	-4.61	0.69	-3.92	11	Pass
48	5240	-4.89	0.69	-4.20	11	Pass
52	5260	-4.67	0.69	-3.98	11	Pass
60	5300	-5.02	0.69	-4.33	11	Pass
64	5320	-5.19	0.69	-4.50	11	Pass
100	5500	-5.17	0.69	-4.48	11	Pass
116	5580	-4.71	0.69	-4.02	11	Pass
140	5700	-5.53	0.69	-4.84	11	Pass

Note: Refer to section 3.3 for duty cycle spectrum plot.

802.11n (HT20)

Channel	Frequency (MHz)	PSD w/o Duty Factor (dBm/MHz)	Duty Factor (dB)	PSD with Duty Factor (dBm/MHz)	Maximum Limit (dBm/MHz)	Pass / Fail
36	5180	-3.83	0.70	-3.13	11	Pass
40	5200	-3.10	0.70	-2.40	11	Pass
48	5240	-3.56	0.70	-2.86	11	Pass
52	5260	-3.10	0.70	-2.40	11	Pass
60	5300	-3.55	0.70	-2.85	11	Pass
64	5320	-3.69	0.70	-2.99	11	Pass
100	5500	-3.69	0.70	-2.99	11	Pass
116	5580	-3.21	0.70	-2.51	11	Pass
140	5700	-4.33	0.70	-3.63	11	Pass

Note: Refer to section 3.3 for duty cycle spectrum plot.

802.11n (HT40)

Channel	Frequency (MHz)	PSD w/o Duty Factor (dBm/MHz)	Duty Factor (dB)	PSD with Duty Factor (dBm/MHz)	Maximum Limit (dBm/MHz)	Pass / Fail
38	5190	-7.72	1.25	-6.47	11	Pass
46	5230	-8.08	1.25	-6.83	11	Pass
54	5270	-7.80	1.25	-6.55	11	Pass
62	5310	-8.06	1.25	-6.81	11	Pass
102	5510	-7.36	1.25	-6.11	11	Pass
110	5550	-7.41	1.25	-6.16	11	Pass
134	5670	-8.14	1.25	-6.89	11	Pass

Note: Refer to section 3.3 for duty cycle spectrum plot.

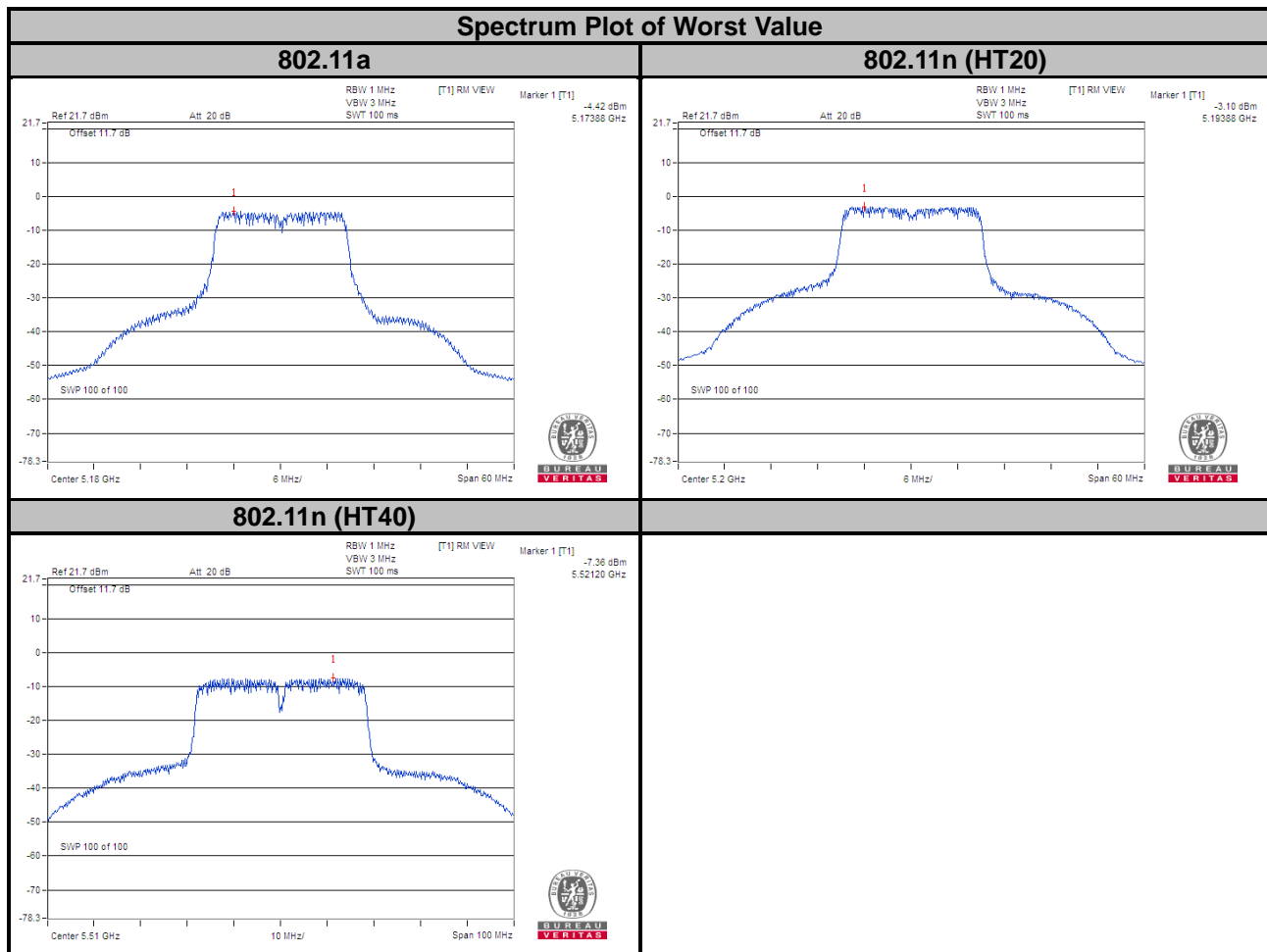

For U-NII-3 Band

802.11a

Channel	Frequency (MHz)	PSD w/o Duty Factor		Duty Factor (dB)	PSD with Duty Factor (dBm/500 kHz)	Limit (dBm/500 kHz)	Pass / Fail
		(dBm/300 kHz)	(dBm/500 kHz)				
149	5745	-11.05	-8.83	0.69	-8.14	30	Pass
157	5785	-11.66	-9.44	0.69	-8.75	30	Pass
165	5825	-12.15	-9.93	0.69	-9.24	30	Pass

Note: Refer to section 3.3 for duty cycle spectrum plot.

802.11n (HT20)

Channel	Frequency (MHz)	PSD w/o Duty Factor		Duty Factor (dB)	PSD with Duty Factor (dBm/500 kHz)	Limit (dBm/500 kHz)	Pass / Fail
		(dBm/300 kHz)	(dBm/500 kHz)				
149	5745	-12.14	-9.92	0.70	-9.22	30	Pass
157	5785	-12.82	-10.60	0.70	-9.90	30	Pass
165	5825	-13.40	-11.18	0.70	-10.48	30	Pass

Note: Refer to section 3.3 for duty cycle spectrum plot.

802.11n (HT40)

Channel	Frequency (MHz)	PSD w/o Duty Factor		Duty Factor (dB)	PSD with Duty Factor (dBm/500 kHz)	Limit (dBm/500 kHz)	Pass / Fail
		(dBm/300 kHz)	(dBm/500 kHz)				
151	5755	-16.72	-14.50	1.25	-13.25	30	Pass
159	5795	-16.70	-14.48	1.25	-13.23	30	Pass

Note: Refer to section 3.3 for duty cycle spectrum plot.

Spectrum Plot of Worst Value

802.11a

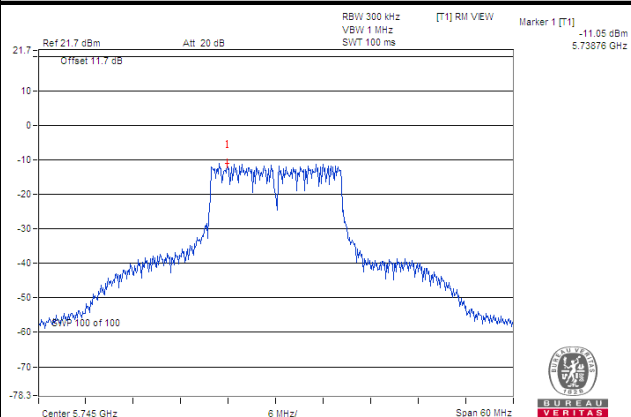

802.11n (HT20)

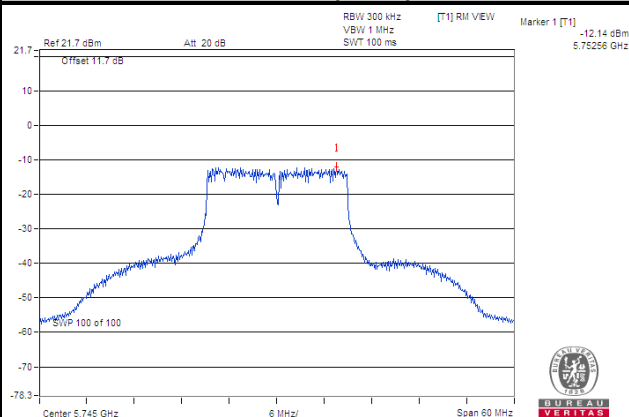

802.11n (HT40)

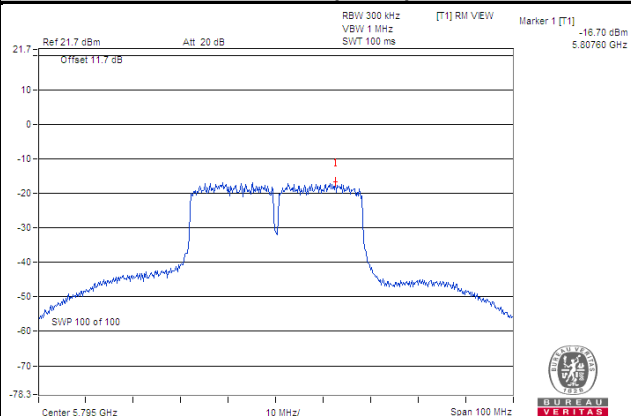

4.6 Frequency Stability

4.6.1 Limit of Frequency Stability Measurement

The frequency of the carrier signal shall be maintained within band of operation.

4.6.2 Test Setup

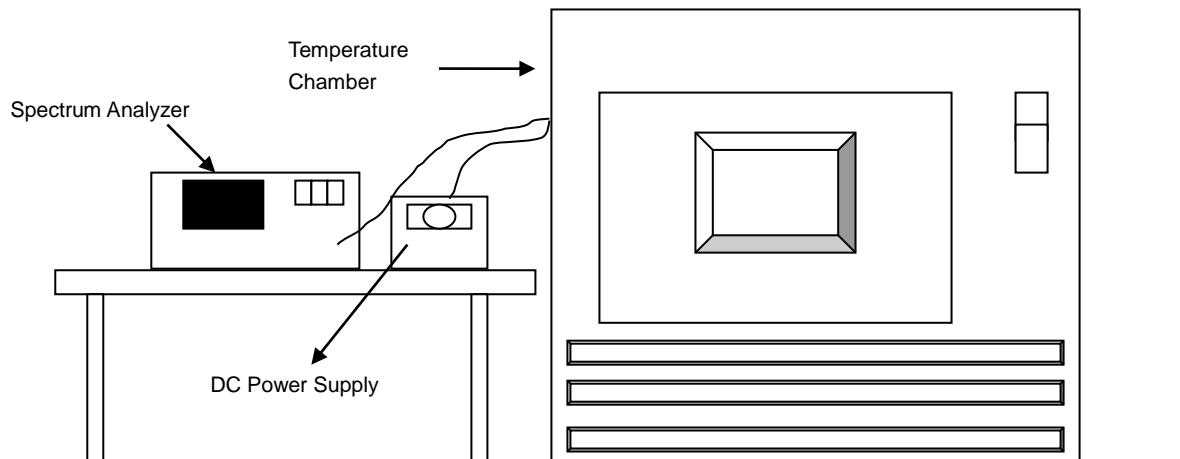

4.6.3 Test Instruments

Refer to section 4.1.3 to get information of above instrument.

4.6.4 Test Procedure

- The EUT was placed inside the environmental test chamber and powered by nominal DC voltage.
- Turn the EUT on and couple its output to a spectrum analyzer.
- Turn the EUT off and set the chamber to the highest temperature specified.
- Allow sufficient time (approximately 30 min) for the temperature of the chamber to stabilize, turn the EUT on and measure the operating frequency after 2, 5, and 10 Minutes.
- Repeat step c and d with every 10 degrees reduction until the lowest temperature achieved.
- The test chamber was allowed to stabilize at +20 degree C for a minimum of 30 Minutes. The supply voltage was then adjusted on the EUT from 85% to 115% and the frequency record.

4.6.5 Deviation from Test Standard

No deviation.

4.6.6 EUT Operating Condition

Set the EUT transmit at un-modulation mode to test frequency stability.

4.6.7 Test Results

Frequency Stability Versus Temp.									
Operating Frequency: 5180 MHz									
Temp. (°C)	Power Supply (Vdc)	0 Minute		2 Minute		5 Minute		10 Minute	
		Measured Frequency (MHz)	Result	Measured Frequency (MHz)	Result	Measured Frequency (MHz)	Result	Measured Frequency (MHz)	Result
50	3.7	5179.9918	PASS	5179.9911	PASS	5179.9894	PASS	5179.9936	PASS
40	3.7	5180.0266	PASS	5180.0243	PASS	5180.026	PASS	5180.0258	PASS
30	3.7	5180.025	PASS	5180.0242	PASS	5180.0225	PASS	5180.0253	PASS
20	3.7	5179.9755	PASS	5179.9731	PASS	5179.9732	PASS	5179.9758	PASS
10	3.7	5179.9946	PASS	5179.9976	PASS	5179.9931	PASS	5179.997	PASS
0	3.7	5180.021	PASS	5180.0208	PASS	5180.0235	PASS	5180.0195	PASS
-10	3.7	5179.9826	PASS	5179.983	PASS	5179.9851	PASS	5179.9855	PASS

Frequency Stability Versus Voltage									
Operating Frequency: 5180 MHz									
Temp. (°C)	Power Supply (Vdc)	0 Minute		2 Minute		5 Minute		10 Minute	
		Measured Frequency (MHz)	Result	Measured Frequency (MHz)	Result	Measured Frequency (MHz)	Result	Measured Frequency (MHz)	Result
20	4.255	5179.9762	PASS	5179.9739	PASS	5179.9729	PASS	5179.9756	PASS
	3.7	5179.9755	PASS	5179.9731	PASS	5179.9732	PASS	5179.9758	PASS
	3.145	5179.9747	PASS	5179.9739	PASS	5179.9724	PASS	5179.9751	PASS

4.7 6 dB Bandwidth Measurement

4.7.1 Limits of 6 dB Bandwidth Measurement

The minimum of 6 dB Bandwidth Measurement is 0.5 MHz.

4.7.2 Test Setup



4.7.3 Test Instruments

Refer to section 4.1.3 to get information of above instrument.

4.7.4 Test Procedure

MEASUREMENT PROCEDURE REF

- Set resolution bandwidth (RBW) = 100 kHz
- Set the video bandwidth (VBW) $\geq 3 \times$ RBW, Detector = Peak.
- Trace mode = max hold.
- Sweep = auto couple.
- Measure the maximum width of the emission that is constrained by the frequencies associated with the two amplitude points (upper and lower) that are attenuated by 6 dB relative to the maximum level measured in the fundamental emission

4.7.5 Deviation from Test Standard

No deviation.

4.7.6 EUT Operating Condition

The software provided by client to enable the EUT under transmission condition continuously at lowest, middle and highest channel frequencies individually.

4.7.7 Test Results

802.11a

Channel	Frequency (MHz)	6 dB Bandwidth (MHz)	Minimum Limit (MHz)	Pass / Fail
149	5745	16.44	0.5	Pass
157	5785	16.41	0.5	Pass
165	5825	16.43	0.5	Pass

802.11n (HT20)

Channel	Frequency (MHz)	6 dB Bandwidth (MHz)	Minimum Limit (MHz)	Pass / Fail
149	5745	17.66	0.5	Pass
157	5785	17.67	0.5	Pass
165	5825	17.62	0.5	Pass

802.11n (HT40)

Channel	Frequency (MHz)	6 dB Bandwidth (MHz)	Minimum Limit (MHz)	Pass / Fail
151	5755	35.50	0.5	Pass
159	5795	35.27	0.5	Pass

Spectrum Plot of Worst Value

802.11a

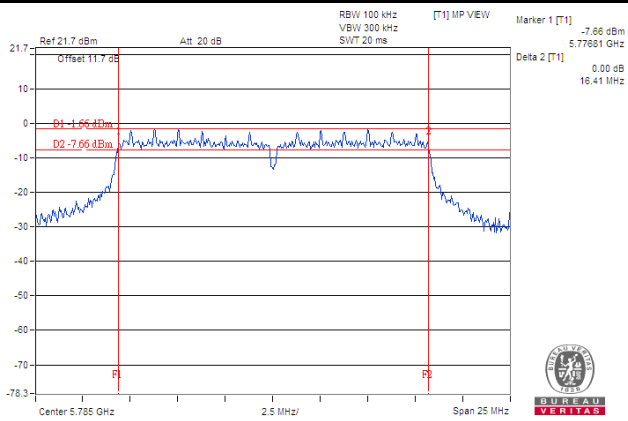

802.11n (HT20)

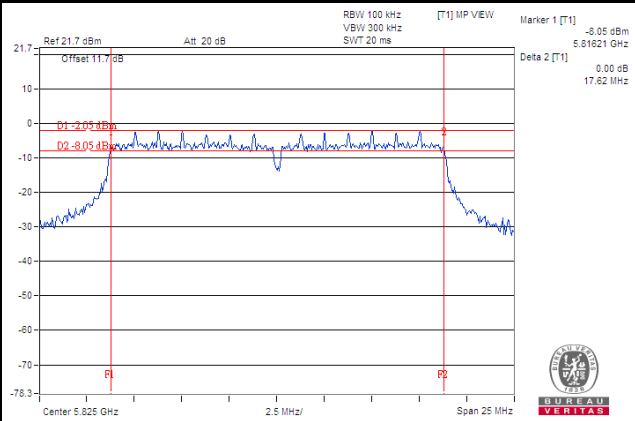

802.11n (HT40)

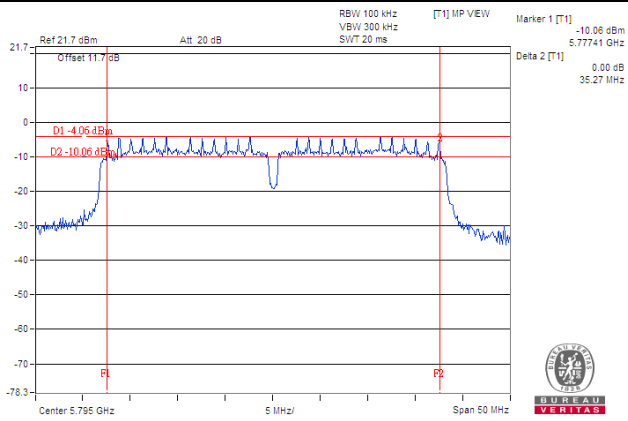

5 Pictures of Test Arrangements

Please refer to the attached file (Test Setup Photo).

Annex A- Radiated Out of Band Emission (OOBE) Measurement (For U-NII-3 band)

802.11a

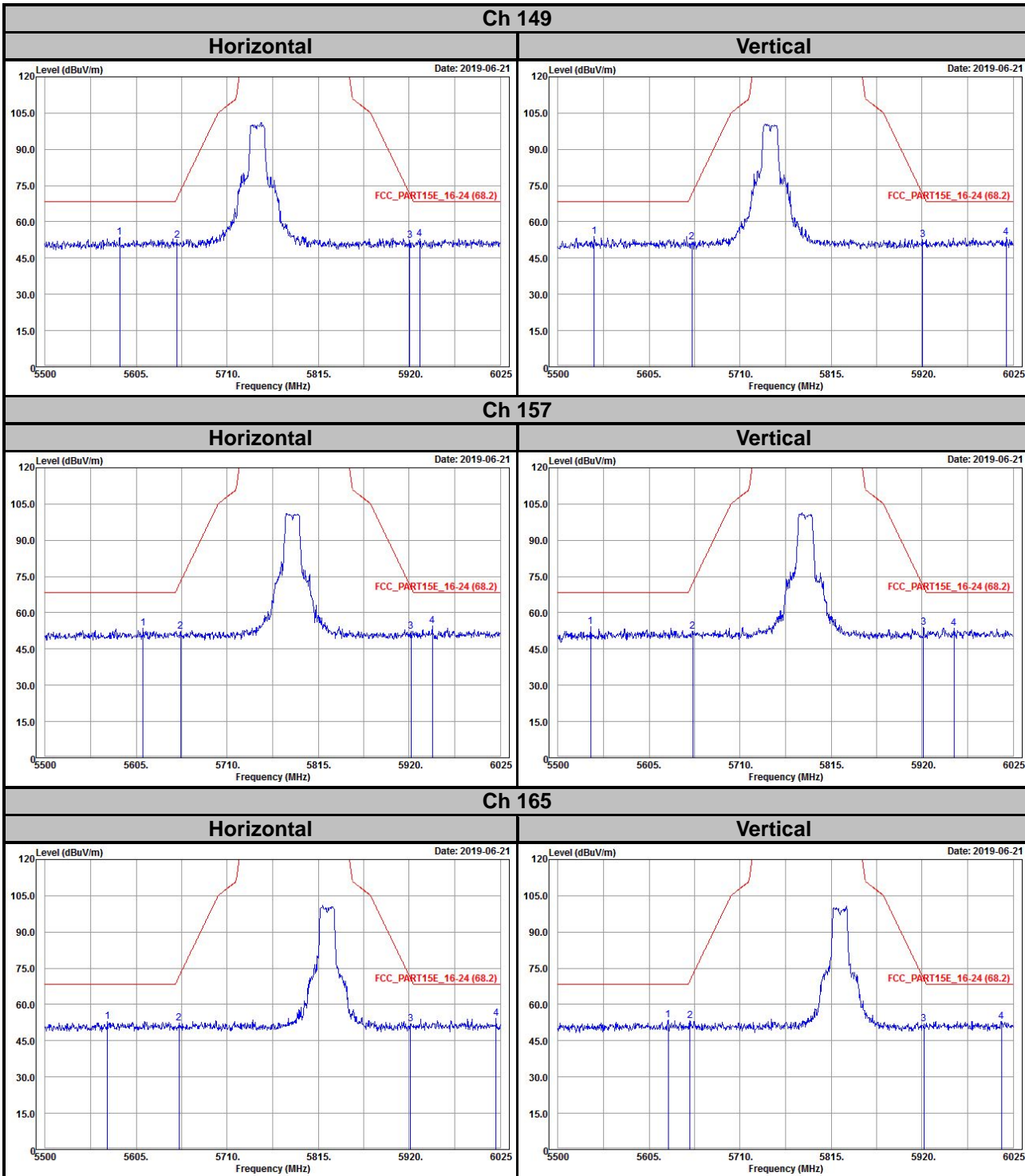

802.11n (HT20)

Ch 149

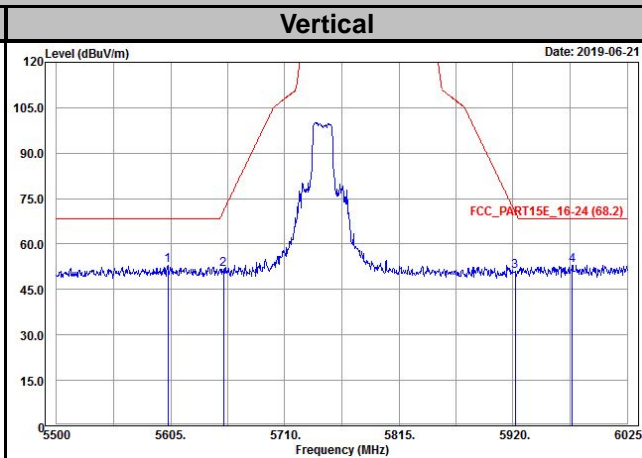
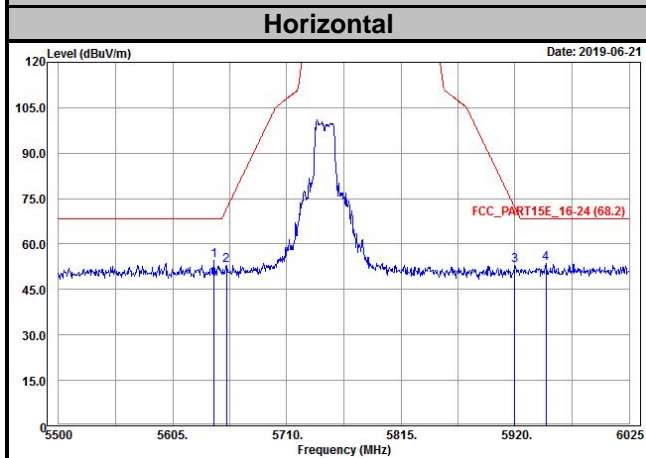

Ch 157

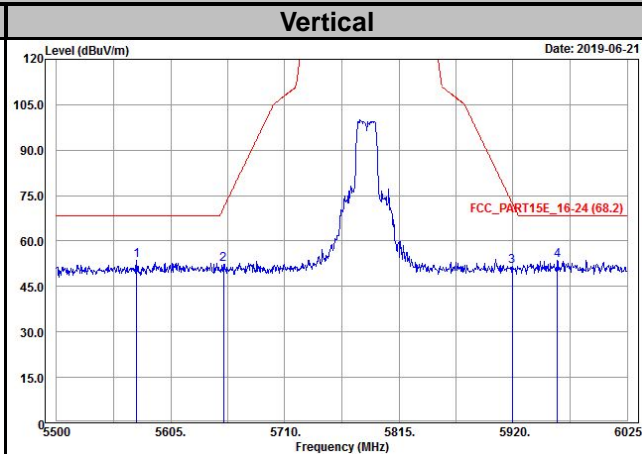
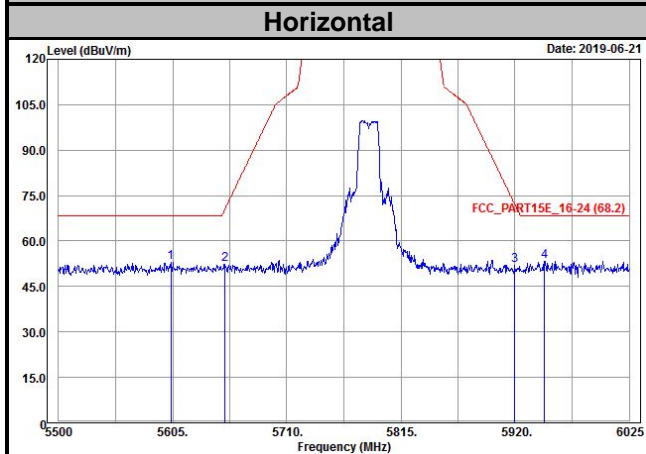

Ch 165

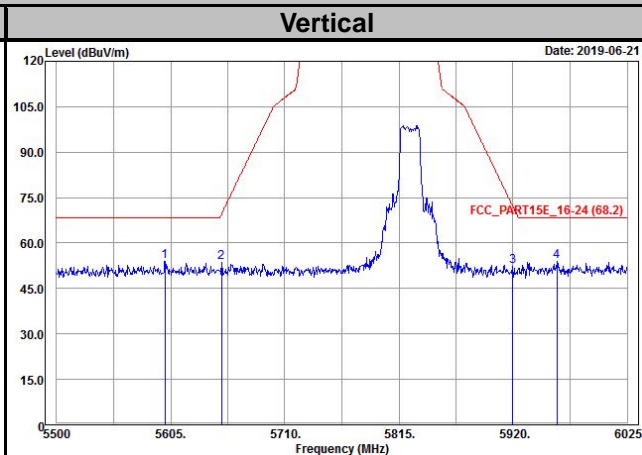
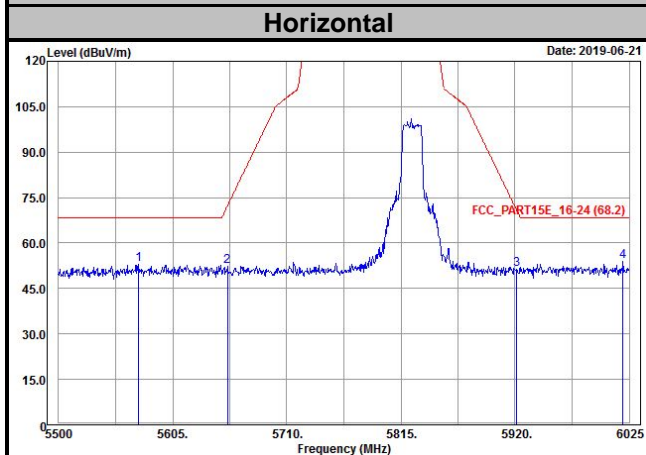

802.11n (HT40)

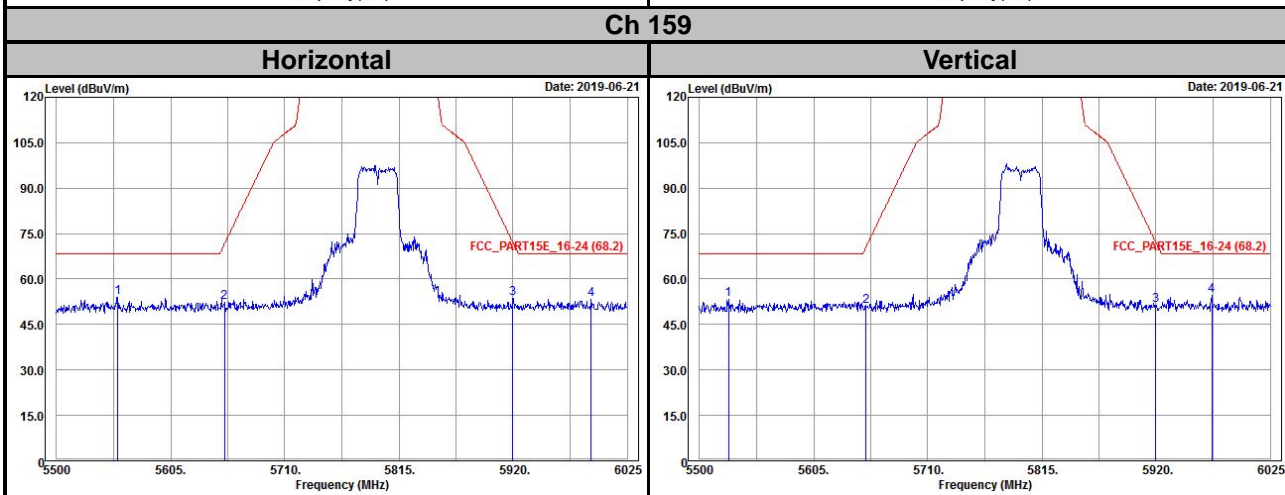
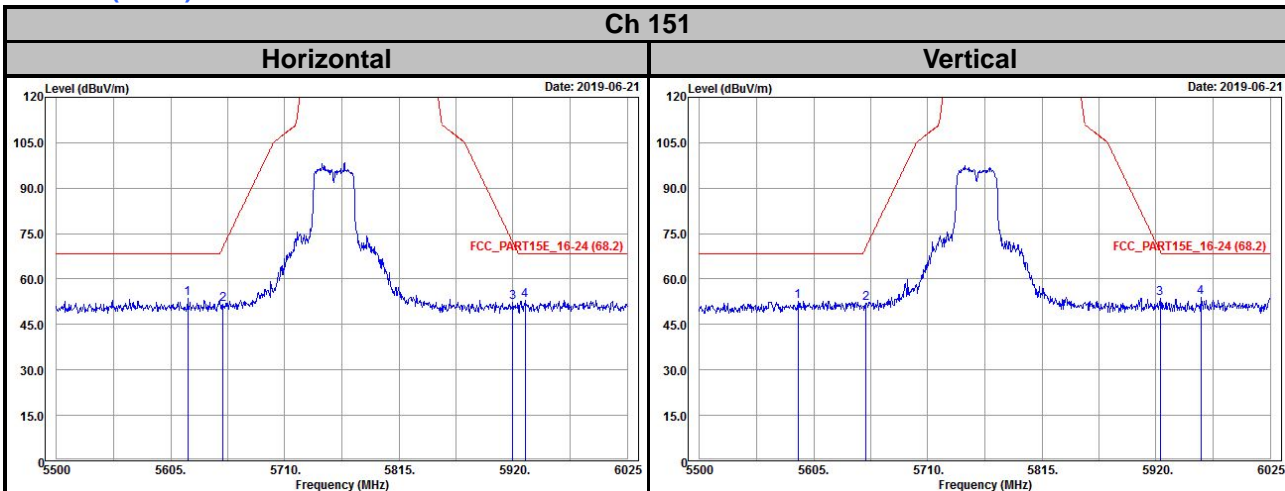

Appendix – Information of the Testing Laboratories

We, Bureau Veritas Consumer Products Services (H.K.) Ltd., Taoyuan Branch, were founded in 1988 to provide our best service in EMC, Radio, Telecom and Safety consultation. Our laboratories are FCC recognized accredited test firms and accredited according to ISO/IEC 17025.

If you have any comments, please feel free to contact us at the following:

Lin Kou EMC/RF Lab

Tel: 886-2-26052180

Fax: 886-2-26051924

Hsin Chu EMC/RF/Telecom Lab

Tel: 886-3-6668565

Fax: 886-3-6668323

Hwa Ya EMC/RF/Safety Lab

Tel: 886-3-3183232

Fax: 886-3-3270892

Email: service.adt@tw.bureauveritas.com

Web Site: www.bureauveritas-adt.com

The address and road map of all our labs can be found in our web site also.

--- END ---