

## FCC Test Report

### (PART 22)

**Report No.:** RF190614C23-6

**FCC ID:** B32CM5PA

**Test Model:** CM5P

**Received Date:** Jun. 14, 2019

**Test Date:** Jul. 02 ~ Jul. 13, 2019

**Issued Date:** Jul. 17, 2019

**Applicant:** Verifone, Inc.

**Address:** 1400 West Stanford Ranch Road Suite 200 Rocklin CA 95765 USA

**Issued By:** Bureau Veritas Consumer Products Services (H.K.) Ltd., Taoyuan Branch

**Lab Address:** No. 47-2, 14th Ling, Chia Pau Vil., Lin Kou Dist., New Taipei City, Taiwan ( R.O.C )

**Test Location (1):** No. 19, Hwa Ya 2nd Rd, Wen Hwa Vil, Kwei Shan Dist., Taoyuan City 33383, Taiwan (R.O.C)

**Test Location (2):** B2F., No.215, Sec. 3, Beixin Rd., Xindian Dist., New Taipei City 231, Taiwan, R.O.C

**FCC Registration /  
Designation Number:** 427177 / TW0011



This report is for your exclusive use. Any copying or replication of this report to or for any other person or entity, or use of our name or trademark, is permitted only with our prior written permission. This report sets forth our findings solely with respect to the test samples identified herein. The results set forth in this report are not indicative or representative of the quality or characteristics of the lot from which a test sample was taken or any similar or identical product unless specifically and expressly noted. Our report includes all of the tests requested by you and the results thereof based upon the information that you provided to us. You have 60 days from date of issuance of this report to notify us of any material error or omission caused by our negligence, provided, however, that such notice shall be in writing and shall specifically address the issue you wish to raise. A failure to raise such issue within the prescribed time shall constitute your unqualified acceptance of the completeness of this report, the tests conducted and the correctness of the report contents. Unless specific mention, the uncertainty of measurement has been explicitly taken into account to declare the compliance or non-compliance to the specification. The report must not be used by the client to claim product certification, approval, or endorsement by TAF or any government agencies

## Table of Contents

<b>Release Control Record</b> .....	<b>4</b>
<b>1 Certificate of Conformity</b> .....	<b>5</b>
<b>2 Summary of Test Results</b> .....	<b>6</b>
2.1 Measurement Uncertainty .....	6
2.2 Test Site and Instruments .....	7
<b>3 General Information</b> .....	<b>8</b>
3.1 General Description of EUT .....	8
3.2 Configuration of System under Test .....	10
3.2.1 Description of Support Units .....	10
3.3 Test Mode Applicability and Tested Channel Detail .....	11
3.4 EUT Operating Conditions .....	14
3.5 General Description of Applied Standards .....	14
<b>4 Test Types and Results</b> .....	<b>15</b>
4.1 Output Power Measurement .....	15
4.1.1 Limits of Output Power Measurement .....	15
4.1.2 Test Procedures .....	15
4.1.3 Test Setup .....	16
4.1.4 Test Results .....	17
4.2 Modulation Characteristics Measurement .....	26
4.2.1 Limits of Modulation Characteristics .....	26
4.2.2 Test Setup .....	26
4.2.3 Test Procedure .....	26
4.2.4 Test Results .....	27
4.3 Frequency Stability Measurement .....	29
4.3.1 Limits of Frequency Stability Measurement .....	29
4.3.2 Test Procedure .....	29
4.3.3 Test Setup .....	29
4.3.4 Test Results .....	30
4.4 Occupied Bandwidth Measurement .....	42
4.4.1 Test Procedure .....	42
4.4.2 Test Setup .....	42
4.4.3 Test Result .....	43
4.5 Band Edge Measurement .....	50
4.5.1 Limits of Band Edge Measurement .....	50
4.5.2 Test Setup .....	50
4.5.3 Test Procedures .....	50
4.5.4 Test Results .....	51
4.6 Peak to Average Ratio .....	61
4.6.1 Limits of Peak to Average Ratio Measurement .....	61
4.6.2 Test Setup .....	61
4.6.3 Test Procedures .....	61
4.6.4 Test Results .....	62
4.7 Conducted Spurious Emissions .....	68
4.7.1 Limits of Conducted Spurious Emissions Measurement .....	68
4.7.2 Test Setup .....	68
4.7.3 Test Procedure .....	68
4.7.4 Test Results .....	69
4.8 Radiated Emission Measurement .....	81
4.8.1 Limits of Radiated Emission Measurement .....	81
4.8.2 Test Procedure .....	81
4.8.3 Deviation from Test Standard .....	81
4.8.4 Test Setup .....	82
4.8.5 Test Results .....	83

<b>5 Pictures of Test Arrangements.....</b>	<b>137</b>
<b>Appendix – Information of the Testing Laboratories .....</b>	<b>138</b>

### Release Control Record

Issue No.	Description	Date Issued
RF190614C23-6	Original Release	Jul. 17, 2019

## 1 Certificate of Conformity

**Product:** Point of Sale Terminal

**Brand:** Verifone

**Test Model:** CM5P

**Sample Status:** Identical Prototype

**Applicant:** Verifone, Inc.

**Test Date:** Jul. 02 ~ Jul. 13, 2019

**Standards:** FCC Part 22, Subpart H

The above equipment has been tested by **Bureau Veritas Consumer Products Services (H.K.) Ltd., Taoyuan Branch**, and found compliance with the requirement of the above standards. The test record, data evaluation & Equipment Under Test (EUT) configurations represented herein are true and accurate accounts of the measurements of the sample's RF characteristics under the conditions specified in this report.

**Prepared by :** , **Date:** Jul. 17, 2019  
Ivonne Wu / Supervisor

**Approved by :** , **Date:** Jul. 17, 2019  
Dylan Chiou / Project Engineer

## 2 Summary of Test Results

Applied Standard: FCC Part 22 & Part 2			
FCC Clause	Test Item	Result	Remarks
2.1046 22.913 (a)	Effective Radiated Power	Pass	Meet the requirement of limit.
2.1047	Modulation Characteristics	Pass	Meet the requirement.
2.1046 22.913 (d)	Peak to Average Ratio	Pass	Meet the requirement of limit.
2.1055 22.355	Frequency Stability	Pass	Meet the requirement of limit.
2.1049	Occupied Bandwidth	Pass	Meet the requirement of limit.
22.917	Band Edge Measurements	Pass	Meet the requirement of limit.
2.1051 22.917	Conducted Spurious Emissions	Pass	Meet the requirement of limit.
2.1053 22.917	Radiated Spurious Emissions	Pass	Meet the requirement of limit. Minimum passing margin is -35.89 dB at 241.68 MHz.

Note: Determining compliance based on the results of the compliance measurement, not taking into account measurement instrumentation uncertainty.

### 2.1 Measurement Uncertainty

Where relevant, the following measurement uncertainty levels have been estimated for tests performed on the EUT as specified in CISPR 16-4-2:

Measurement	Frequency	Expanded Uncertainty (k=2) (±)
Radiated Emissions up to 1 GHz	9 kHz ~ 30 MHz	3.0400 dB
	30 MHz ~ 200 MHz	2.0153 dB
	200 MHz ~ 1000 MHz	2.0224 dB
Radiated Emissions above 1 GHz	1 GHz ~ 18 GHz	1.0121 dB
	18 GHz ~ 40 GHz	1.1508 dB

## 2.2 Test Site and Instruments

Description & Manufacturer	Model No.	Serial No.	Date of Calibration	Due Date of Calibration
Test Receiver Agilent Technologies	N9038A	MY52260177	Aug. 20, 2018	Aug. 19, 2019
Spectrum Analyzer ROHDE & SCHWARZ	FSU43	101261	Apr. 15, 2019	Apr. 14, 2020
Spectrum Analyzer ROHDE & SCHWARZ	FSW26	102023	Oct. 11, 2018	Oct. 10, 2019
HORN Antenna ETS-Lindgren	3117	00143293	Nov. 25, 2018	Nov. 24, 2019
BILOG Antenna SCHWARZBECK	VULB 9168	9168-616	Nov. 27, 2018	Nov. 26, 2019
BILOG Antenna SCHWARZBECK	VULB 9168	9168-631	Nov. 26, 2018	Nov. 25, 2019
HORN Antenna SCHWARZBECK	BBHA 9120D	9120D-969	Nov. 25, 2018	Nov. 24, 2019
Fixed Attenuator Mini-Circuits	MDCS18N-10	MDCS18N-10-01	Apr. 15, 2019	Apr. 14, 2020
MXG Vector signal generator Agilent	N5182B	MY53050430	Nov. 19, 2018	Nov. 18, 2019
Preamplifier Agilent	310N	187226	Jun. 18, 2019	Jun. 17, 2020
Preamplifier Agilent	83017A	MY39501357	Jun. 18, 2019	Jun. 17, 2020
RF signal cable ETS-LINDGREN	5D-FB	Cable-CH1-01(RFC -SMS-100-SMS-12 0+RFC-SMS-100-S MS-400)	Jun. 18, 2019	Jun. 17, 2020
RF signal cable ETS-LINDGREN	8D-FB	Cable-CH1-02(RFC -SMS-100-SMS-24)	Jun. 18, 2019	Jun. 17, 2020
Boresight Antenna Fixture	FBA-01	FBA-SIP01	NA	NA
Software BV ADT	E3 8.130425b	NA	NA	NA
Antenna Tower MF	NA	NA	NA	NA
Turn Table MF	NA	NA	NA	NA
Antenna Tower & Turn Table Controller MF	MF-7802	NA	NA	NA
Radio Communication Analyzer Anritsu	MT8821C	6201462755	Jan 16, 2019	Jan 15, 2020
Radio Communication Analyzer Anritsu	MT8820C	6201300640	Aug. 16, 2017	Aug. 15, 2019
Temperature & Humidity Chamber	GTH-120-40-CP-AR	MAA1306-019	Sep. 05, 2018	Sep. 04, 2019
DC Power Supply Topward	33010D	807748	NA	NA

Note: 1. The calibration interval of the above test instruments is 12 / 24 months and the calibrations are traceable to NML/ROC and NIST/USA.

2. The test was performed in HsinTien Chamber 1.

### 3 General Information

#### 3.1 General Description of EUT

<b>Product</b>	Point of Sale Terminal	
<b>Brand</b>	Verifone	
<b>Test Model</b>	CM5P	
<b>Status of EUT</b>	Identical Prototype	
<b>Power Supply Rating</b>	5.0 Vdc (adapter or host equipment) 3.7 Vdc (Li-ion battery)	
<b>Modulation Type</b>	GPRS	GMSK
	EDGE	GMSK, 8PSK
	WCDMA	QPSK
	LTE	QPSK, 16QAM
<b>Frequency Range</b>	GPRS/EDGE	824.2 ~ 848.8 MHz
	WCDMA	826.4 ~ 846.6 MHz
	LTE 5 (Channel Bandwidth: 1.4 MHz)	824.7 ~ 848.3 MHz
	LTE 5 (Channel Bandwidth: 3 MHz)	825.5 ~ 847.5 MHz
	LTE 5 (Channel Bandwidth: 5 MHz)	826.5 ~ 846.5 MHz
	LTE 5 (Channel Bandwidth: 10 MHz)	829 ~ 844 MHz
	LTE 26 (Channel Bandwidth: 1.4 MHz)	824.7 ~ 848.3 MHz
	LTE 26 (Channel Bandwidth: 3 MHz)	825.5 ~ 847.5 MHz
	LTE 26 (Channel Bandwidth: 5 MHz)	826.5 ~ 846.5 MHz
	LTE 26 (Channel Bandwidth: 10 MHz)	829 ~ 844 MHz
<b>Max. ERP Power</b>	GPRS	723.10 mW
	EDGE	180.72 mW
	WCDMA	90.16 mW
	LTE 5 (Channel Bandwidth: 1.4 MHz)	71.09 mW
	LTE 5 (Channel Bandwidth: 3 MHz)	71.75 mW
	LTE 5 (Channel Bandwidth: 5 MHz)	72.58 mW
	LTE 5 (Channel Bandwidth: 10 MHz)	73.25 mW
	LTE 26 (Channel Bandwidth: 1.4 MHz)	73.45 mW
	LTE 26 (Channel Bandwidth: 3 MHz)	74.13 mW
	LTE 26 (Channel Bandwidth: 5 MHz)	74.82 mW
	LTE 26 (Channel Bandwidth: 10 MHz)	75.34 mW
LTE 26 (Channel Bandwidth: 15 MHz)	76.03 mW	



<b>Emission Designator</b>	GPRS	244KGXW
	EDGE	246KG7W
	WCDMA	4M16F9W
	LTE 5 (Channel Bandwidth: 1.4 MHz)	1M09D7W
	LTE 5 (Channel Bandwidth: 3 MHz)	2M70G7D
	LTE 5 (Channel Bandwidth: 5 MHz)	4M50D7W
	LTE 5 (Channel Bandwidth: 10 MHz)	8M98D7W
	LTE 26 (Channel Bandwidth: 1.4 MHz)	1M09D7W
	LTE 26 (Channel Bandwidth: 3 MHz)	2M70G7D
	LTE 26 (Channel Bandwidth: 5 MHz)	4M50D7W
	LTE 26 (Channel Bandwidth: 10 MHz)	8M97D7W
	LTE 26 (Channel Bandwidth: 15 MHz)	13M5G7D
<b>Antenna Type</b>	Fixed Internal Antenna with -1.8 dBi gain	
<b>Accessory Device</b>	Refer to Note as below	
<b>Data Cable Supplied</b>	Refer to Note as below	

Note:

1. The EUT's accessories list refers to Ext. Pho.
2. The above EUT information is declared by manufacturer and for more detailed features description, please refers to the manufacturer's specifications or user's manual.

### 3.2 Configuration of System under Test

#### <Radiated Emission Test>

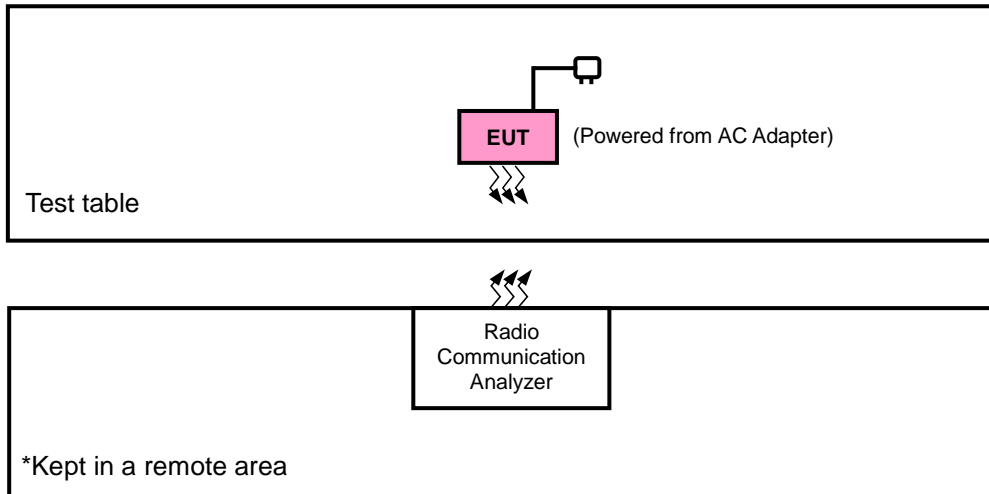

#### <E.R.P. Test>

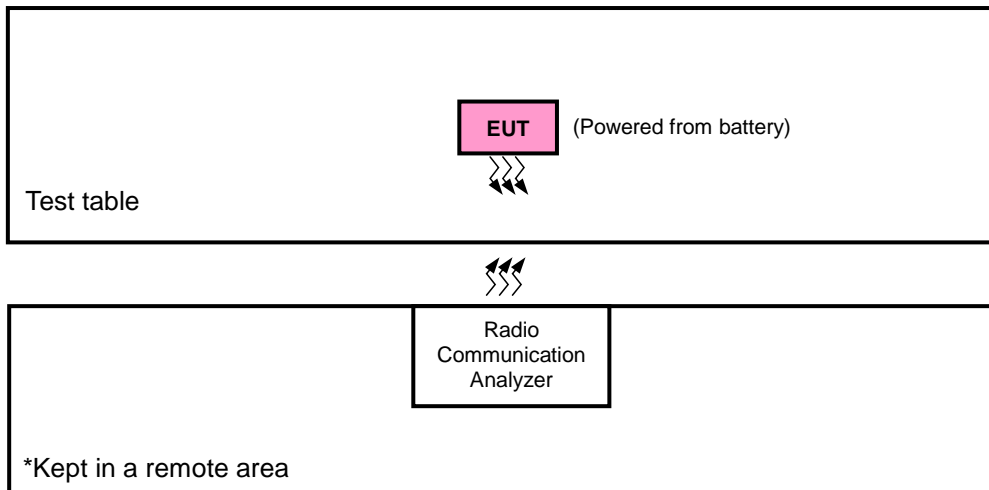

#### 3.2.1 Description of Support Units

The EUT has been tested as an independent unit together with other necessary accessories or support units.

### 3.3 Test Mode Applicability and Tested Channel Detail

Pre-Scan has been conducted to determine the worst-case mode from all possible combinations between available modulations, data rates, XYZ axis, and antenna ports.

The worst case was found when positioned as the table below. Following channel(s) was (were) selected for the final test as listed below:

Band	ERP	Radiated Emission
GPRS	X-plane	Z-axis
EDGE	X-plane	Z-axis
WCDMA	X-plane	Z-axis
LTE Band 5	X-plane	Y-axis
LTE Band 26	X-plane	X-axis

#### GPRS

EUT Configure Mode	Test Item	Available Channel	Tested Channel	Mode
-	ERP	128 to 251	128, 189, 251	GPRS, EDGE
-	Modulation Characteristics	128 to 251	189	GPRS, EDGE
-	Frequency Stability	128 to 251	128, 251	GPRS, EDGE
-	Occupied Bandwidth	128 to 251	128, 189, 251	GPRS, EDGE
-	Band Edge	128 to 251	128, 251	GPRS, EDGE
-	Peak to Average Ratio	128 to 251	128, 189, 251	GPRS, EDGE
-	Conducted Emission	128 to 251	128, 189, 251	GPRS, EDGE
-	Radiated Emission	128 to 251	128, 189, 251	GPRS, EDGE

#### WCDMA

EUT Configure Mode	Test Item	Available Channel	Tested Channel	Mode
-	ERP	4132 to 4233	4132, 4182, 4233	WCDMA
-	Modulation Characteristics	4132 to 4233	4182	WCDMA
-	Frequency Stability	4132 to 4233	4132, 4233	WCDMA
-	Occupied Bandwidth	4132 to 4233	4132, 4182, 4233	WCDMA
-	Band Edge	4132 to 4233	4132, 4233	WCDMA
-	Peak to Average Ratio	4132 to 4233	4132, 4182, 4233	WCDMA
-	Conducted Emission	4132 to 4233	4132, 4182, 4233	WCDMA
-	Radiated Emission	4132 to 4233	4132, 4182, 4233	WCDMA

## LTE Band 5

EUT Configure Mode	Test Item	Available Channel	Tested Channel	Channel Bandwidth	Modulation	Mode		
-	ERP	20407 to 20643	20407, 20525, 20643	1.4 MHz	QPSK, 16QAM	3 RB / 0 RB Offset		
		20415 to 20635	20415, 20525, 20635	3 MHz	QPSK, 16QAM	1 RB / 0 RB Offset		
		20425 to 20625	20425, 20525, 20625	5 MHz	QPSK, 16QAM	1 RB / 0 RB Offset		
		20450 to 20600	20450, 20525, 20600	10 MHz	QPSK, 16QAM	1 RB / 0 RB Offset		
-	Modulation Characteristics	20450 to 20600	20525	10 MHz	QPSK, 16QAM	50 RB / 0 RB Offset		
-	Frequency Stability	20407 to 20643	20407, 20643	1.4 MHz	QPSK	1 RB / 0 RB Offset		
		20415 to 20635	20415, 20635	3 MHz	QPSK	1 RB / 0 RB Offset		
		20425 to 20625	20425, 20625	5 MHz	QPSK	1 RB / 0 RB Offset		
		20450 to 20600	20450, 20600	10 MHz	QPSK	1 RB / 0 RB Offset		
-	Occupied Bandwidth	20407 to 20643	20407, 20525, 20643	1.4 MHz	QPSK, 16QAM	6 RB / 0 RB Offset		
		20415 to 20635	20415, 20525, 20635	3 MHz	QPSK, 16QAM	15 RB / 0 RB Offset		
		20425 to 20625	20425, 20525, 20625	5 MHz	QPSK, 16QAM	25 RB / 0 RB Offset		
		20450 to 20600	20450, 20525, 20600	10 MHz	QPSK, 16QAM	50 RB / 0 RB Offset		
-	Band Edge	20407 to 20643	20407	1.4MHz	QPSK	1 RB / 0 RB Offset 6 RB / 0 RB Offset		
			20643	1.4MHz	QPSK	1 RB / 5 RB Offset 6 RB / 0 RB Offset		
		20415 to 20635	20415	3 MHz	QPSK	1 RB / 0 RB Offset 15 RB / 0 RB Offset		
			20635	3 MHz	QPSK	1 RB / 14 RB Offset 15 RB / 0 RB Offset		
		20425 to 20625	20425	5 MHz	QPSK	1 RB / 0 RB Offset 25 RB / 0 RB Offset		
			20625	5 MHz	QPSK	1 RB / 24 RB Offset 25 RB / 0 RB Offset		
		20450 to 20600	20450	10 MHz	QPSK	1 RB / 0 RB Offset 50 RB / 0 RB Offset		
			20600	10 MHz	QPSK	1 RB / 49 RB Offset 50 RB / 0 RB Offset		
		-	Peak to Average Ratio	20407 to 20643	20407, 20525, 20643	1.4 MHz	QPSK, 16QAM	3 RB / 0 RB Offset
				20415 to 20635	20415, 20525, 20635	3 MHz	QPSK, 16QAM	1 RB / 0 RB Offset
				20425 to 20625	20425, 20525, 20625	5 MHz	QPSK, 16QAM	1 RB / 0 RB Offset
				20450 to 20600	20450, 20525, 20600	10 MHz	QPSK, 16QAM	1 RB / 0 RB Offset
-	Conducted Emission	20407 to 20643	20407, 20525, 20643	1.4 MHz	QPSK	3 RB / 0 RB Offset		
		20415 to 20635	20415, 20525, 20635	3 MHz	QPSK	1 RB / 0 RB Offset		
		20425 to 20625	20425, 20525, 20625	5 MHz	QPSK	1 RB / 0 RB Offset		
		20450 to 20600	20450, 20525, 20600	10 MHz	QPSK	1 RB / 0 RB Offset		
-	Radiated Emission	20407 to 20643	20407, 20525, 20643	1.4 MHz	QPSK	3 RB / 0 RB Offset		
		20425 to 20625	20425, 20525, 20625	5 MHz	QPSK	1 RB / 0 RB Offset		
		20450 to 20600	20450, 20525, 20600	10 MHz	QPSK	1 RB / 0 RB Offset		

### Note:

1. This device was tested under all bandwidths, RB configurations and modulations. The worst case was found in QPSK modulation.
2. For radiated emission above 1 GHz, according to 3GPP 36.521 Section 6.6.3.1.4, choose the lowest, 5 MHz & highest channel bandwidth for final test.

### LTE Band 26

EUT Configure Mode	Test Item	Available Channel	Tested Channel	Channel Bandwidth	Modulation	Mode		
-	ERP	26797 to 27033	26797, 26915, 27033	1.4 MHz	QPSK, 16QAM	1 RB / 0 RB Offset		
		26805 to 27025	26805, 26915, 27025	3 MHz	QPSK, 16QAM	1 RB / 0 RB Offset		
		26815 to 27015	26815, 26915, 27015	5 MHz	QPSK, 16QAM	1 RB / 0 RB Offset		
		26840 to 26990	26840, 26915, 26990	10 MHz	QPSK, 16QAM	1 RB / 0 RB Offset		
		26865 to 26965	26865, 26915, 26965	15 MHz	QPSK, 16QAM	1 RB / 0 RB Offset		
-	Modulation Characteristics	26865 to 26965	26915	15 MHz	QPSK, 16QAM	75 RB / 0 RB Offset		
-	Frequency Stability	26797 to 27033	26797, 27033	1.4 MHz	QPSK	1 RB / 0 RB Offset		
		26805 to 27025	26805, 27025	3 MHz	QPSK	1 RB / 0 RB Offset		
		26815 to 27015	26815, 27015	5 MHz	QPSK	1 RB / 0 RB Offset		
		26840 to 26990	26840, 26990	10 MHz	QPSK	1 RB / 0 RB Offset		
		26865 to 26965	26865, 26965	15 MHz	QPSK	1 RB / 0 RB Offset		
-	Occupied Bandwidth	26797 to 27033	26797, 26915, 27033	1.4 MHz	QPSK, 16QAM	6 RB / 0 RB Offset		
		26805 to 27025	26805, 26915, 27025	3 MHz	QPSK, 16QAM	15 RB / 0 RB Offset		
		26815 to 27015	26815, 26915, 27015	5 MHz	QPSK, 16QAM	25 RB / 0 RB Offset		
		26840 to 26990	26840, 26915, 26990	10 MHz	QPSK, 16QAM	50 RB / 0 RB Offset		
		26865 to 26965	26865, 26915, 26965	15 MHz	QPSK, 16QAM	75 RB / 0 RB Offset		
-	Band Edge	26797 to 27033	26797	1.4 MHz	QPSK	1 RB / 0 RB Offset 6 RB / 0 RB Offset		
			27033	1.4 MHz	QPSK	1 RB / 5 RB Offset 6 RB / 0 RB Offset		
		26805 to 27025	26805	3 MHz	QPSK	1 RB / 0 RB Offset 15 RB / 0 RB Offset		
			27025	3 MHz	QPSK	1 RB / 14 RB Offset 15 RB / 0 RB Offset		
		26815 to 27015	26815	5 MHz	QPSK	1 RB / 0 RB Offset 25 RB / 0 RB Offset		
			27015	5 MHz	QPSK	1 RB / 24 RB Offset 25 RB / 0 RB Offset		
		26840 to 26990	26840	10 MHz	QPSK	1 RB / 0 RB Offset 50 RB / 0 RB Offset		
			26990	10 MHz	QPSK	1 RB / 49 RB Offset 50 RB / 0 RB Offset		
		26865 to 26965	26865	15 MHz	QPSK	1 RB / 0 RB Offset 75 RB / 0 RB Offset		
			26965	15 MHz	QPSK	1 RB / 74 RB Offset 75 RB / 0 RB Offset		
		-	Peak to Average Ratio	26797 to 27033	26797, 26915, 27033	1.4 MHz	QPSK, 16QAM	1 RB / 0 RB Offset
				26805 to 27025	26805, 26915, 27025	3 MHz	QPSK, 16QAM	1 RB / 0 RB Offset
26815 to 27015	26815, 26915, 27015			5 MHz	QPSK, 16QAM	1 RB / 0 RB Offset		
26840 to 26990	26840, 26915, 26990			10 MHz	QPSK, 16QAM	1 RB / 0 RB Offset		
26865 to 26965	26865, 26915, 26965			15 MHz	QPSK, 16QAM	1 RB / 0 RB Offset		
-	Conducted Emission	26797 to 27033	26797, 26915, 27033	1.4 MHz	QPSK	1 RB / 0 RB Offset		
		26805 to 27025	26805, 26915, 27025	3 MHz	QPSK	1 RB / 0 RB Offset		
		26815 to 27015	26815, 26915, 27015	5 MHz	QPSK	1 RB / 0 RB Offset		
		26840 to 26990	26840, 26915, 26990	10 MHz	QPSK	1 RB / 0 RB Offset		
		26865 to 26965	26865, 26915, 26965	15 MHz	QPSK	1 RB / 0 RB Offset		
-	Radiated Emission	26797 to 27033	26797, 26915, 27033	1.4 MHz	QPSK	1 RB / 0 RB Offset		
		26815 to 27015	26815, 26915, 27015	5 MHz	QPSK	1 RB / 0 RB Offset		
		26865 to 26965	26865, 26915, 26965	15 MHz	QPSK	1 RB / 0 RB Offset		

**Note:**

1. This device was tested under all bandwidths, RB configurations and modulations. The worst case was found in QPSK modulation.
2. For radiated emission above 1 GHz, according to 3GPP 36.521 Section 6.6.3.1.4, choose the lowest, 5 MHz & highest channel bandwidth for final test.

**Test Condition:**

Test Item	Environmental Conditions	Input Power	Tested By
ERP	25 deg. C, 65 % RH	3.7 Vdc	Charles Hsiao
Modulation Characteristics	25 deg. C, 65 % RH	3.7 Vdc	Gavin Wu
Frequency Stability	25 deg. C, 65 % RH	3.7 Vdc	Gavin Wu
Occupied Bandwidth	25 deg. C, 65 % RH	3.7 Vdc	Gavin Wu
Band Edge	25 deg. C, 65 % RH	3.7 Vdc	Gavin Wu
Peak to Average Ratio	25 deg. C, 65 % RH	3.7 Vdc	Gavin Wu
Conducted Emission	25 deg. C, 65 % RH	3.7 Vdc	Gavin Wu
Radiated Emission	25 deg. C, 65 % RH	120 Vac, 60 Hz	Charles Hsiao

**3.4 EUT Operating Conditions**

The EUT makes a call to the communication simulator. The communication simulator station system controlled a EUT to export maximum output power under transmission mode and specific channel frequency.

**3.5 General Description of Applied Standards**

The EUT is a RF Product. According to the specifications of the manufacturer, it must comply with the requirements of the following standards:

**FCC 47 CFR Part 2**

**FCC 47 CFR Part 22**

**KDB 971168 D01 Power Meas License Digital Systems v03r01**

**ANSI/TIA/EIA-603-E 2016**

**ANSI 63.26-2015**

**Note:** All test items have been performed and recorded as per the above standards.

## 4 Test Types and Results

### 4.1 Output Power Measurement

#### 4.1.1 Limits of Output Power Measurement

Mobile / Portable station are limited to 7 watts e.r.p.

#### 4.1.2 Test Procedures

##### **EIRP / ERP Measurement:**

- a. All measurements were done at low, middle and high operational frequency range. RBW and VBW is 1 MHz for GPRS & EDGE, and 5 MHz for WCDMA, and 10 MHz for LTE mode.
- b. Substitution method is used for E.I.R.P measurement. In the semi-anechoic chamber, EUT placed on the 0.8 m (below or equal 1 GHz) and/or 1.5 m (above 1 GHz) height of Turn Table, rotated the table around 360 degrees to search the maximum radiation power and receiver antenna shall be rotated vertical and horizontal polarization and moved height from 1 m to 4 m to find the maximum polar radiated power. The "Read Value" is the spectrum reading the maximum power value.
- c. The substitution horn antenna is substituted for EUT at the same position and signals generator export the CW signal to the substitution antenna via a tx cable. Rotated the Turn Table and moved receiving antenna to find the maximum radiation power. Adjust output power level of S.G to get a Value of spectrum reading equal to "Read Value" of step b. Record the power level of S.G.
- d.  $EIRP = \text{Output power level of S.G} - \text{TX cable loss} + \text{Antenna gain of substitution horn}$ . E.R.P power can be calculated form E.I.R.P power by subtracting the gain of dipole,  $E.R.P \text{ power} = E.I.R.P \text{ power} - 2.15 \text{ dB}$ .

##### **Conducted Power Measurement:**

The EUT was set up for the maximum power with GPRS, EDGE, WCDMA, and LTE link data modulation and link up with simulator. Set the EUT to transmit under low, middle and high channel and record the power level shown on simulator.

4.1.3 Test Setup

**EIRP / ERP Measurement:**

**<Radiated Emission below or equal 1 GHz>**

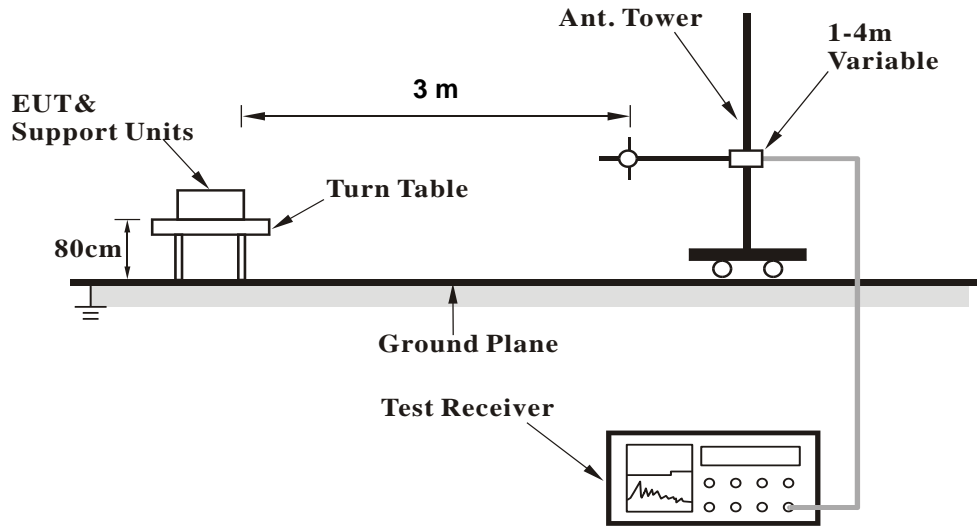

**<Radiated Emission above 1 GHz>**

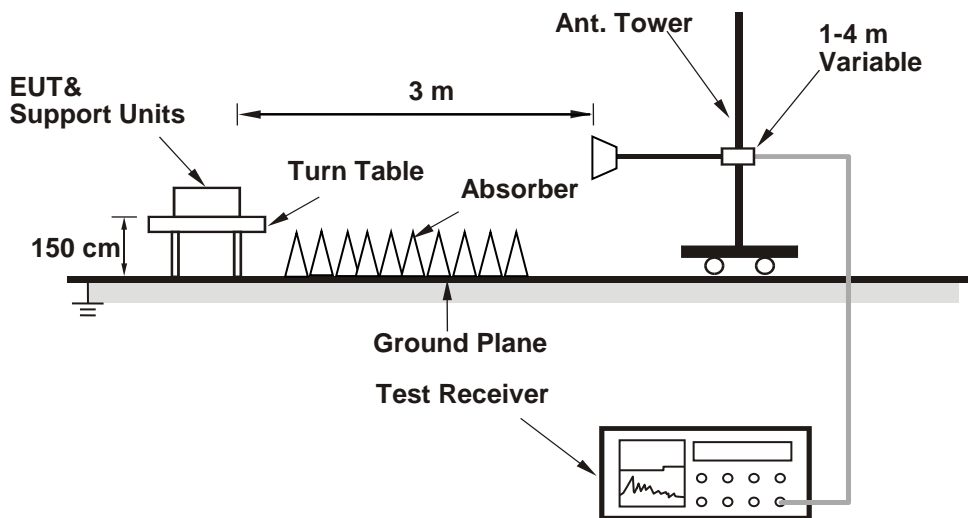

For the actual test configuration, please refer to the attached file (Test Setup Photo).

**Conducted Power Measurement:**

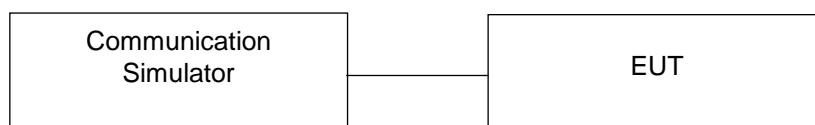



#### 4.1.4 Test Results

##### Conducted Output Power (dBm)

Band	GPRS850		
	128	189	251
Channel	824.2	836.4	848.8
Frequency (MHz)	824.2	836.4	848.8
GPRS (GMSK, 1Tx-slot)	32.43	32.38	32.50
GPRS (GMSK, 2Tx-slot)	31.74	31.72	31.79
GPRS (GMSK, 3Tx-slot)	29.60	29.64	29.66
GPRS (GMSK, 4Tx-slot)	28.15	28.40	28.32
EDGE (8PSK, 1Tx-slot)	26.41	26.53	26.36
EDGE (8PSK, 2Tx-slot)	26.23	26.31	26.25
EDGE (8PSK, 3Tx-slot)	26.07	26.19	26.12
EDGE (8PSK, 4Tx-slot)	25.90	25.98	25.93

Band	WCDMA V		
	4132	4182	4233
Channel	826.4	836.4	846.6
Frequency (MHz)	826.4	836.4	846.6
RMC 12.2K	23.18	23.42	23.24
HSDPA Subtest-1	22.84	23.08	22.90
HSDPA Subtest-2	22.85	23.09	22.91
HSDPA Subtest-3	22.36	22.60	22.42
HSDPA Subtest-4	22.35	22.59	22.41
DC-HSDPA Subtest-1	22.79	23.03	22.85
DC-HSDPA Subtest-2	22.80	23.04	22.86
DC-HSDPA Subtest-3	22.31	22.55	22.37
DC-HSDPA Subtest-4	22.30	22.54	22.36
HSUPA Subtest-1	22.26	22.48	22.32
HSUPA Subtest-2	20.86	21.10	20.92
HSUPA Subtest-3	21.82	22.06	21.88
HSUPA Subtest-4	21.03	21.27	21.09
HSUPA Subtest-5	22.86	23.10	22.92

LTE Band 5															
BW	MCS Index	RB Size	RB Offset	Low	Mid	High	3GPP MPR (dB)	BW	MCS Index	RB Size	RB Offset	Low	Mid	High	3GPP MPR (dB)
				20450	20525	20600						20425	20525	20625	
				Channel	Channel	Channel						Channel	Channel	Channel	
				829.0	836.5	844.0						826.5	836.5	846.5	
10M	QPSK	1	0	23.23	23.09	23.25	0	5M	QPSK	1	0	23.15	22.96	23.10	0
		1	24	22.98	22.93	23.07	0			1	12	22.92	22.76	22.77	0
		1	49	22.88	23.13	22.97	0			1	24	22.71	23.07	22.83	0
		25	0	22.26	22.21	22.35	1			12	0	22.10	22.18	22.11	1
		25	12	22.05	22.00	22.14	1			12	6	21.92	21.85	21.99	1
		25	25	22.02	21.97	22.11	1			12	13	21.83	21.89	21.96	1
		50	0	22.12	22.07	22.21	1			25	0	22.05	21.94	21.98	1
	16QAM	1	0	22.16	22.09	22.21	1		16QAM	1	0	22.21	21.96	22.01	1
		1	24	21.98	21.86	22.00	1			1	12	21.75	21.79	21.93	1
		1	49	21.79	22.04	21.87	1			1	24	21.73	22.00	21.91	1
		25	0	21.21	21.17	21.29	2			12	0	21.03	21.07	21.22	2
		25	12	21.02	20.92	21.05	2			12	6	20.84	20.83	21.01	2
		25	25	20.99	20.89	21.07	2			12	13	20.78	20.82	20.87	2
		50	0	21.09	20.99	21.17	2			25	0	20.94	20.92	21.03	2
BW	MCS Index	RB Size	RB Offset	Low	Mid	High	3GPP MPR (dB)	BW	MCS Index	RB Size	RB Offset	Low	Mid	High	3GPP MPR (dB)
				20415	20525	20635						20407	20525	20643	
				Channel	Channel	Channel						Channel	Channel	Channel	
				825.5	836.5	847.5						824.7	836.5	848.3	
3M	QPSK	1	0	23.17	23.02	23.07	0	1.4M	QPSK	1	0	23.02	22.84	23.17	0
		1	7	22.91	22.74	22.95	0			1	2	22.89	22.83	22.87	0
		1	14	22.86	22.97	22.87	0			1	5	22.75	22.94	22.89	0
		8	0	22.11	22.11	22.17	1			3	0	23.10	23.00	23.18	0
		8	3	21.95	21.84	22.00	1			3	1	22.81	22.98	22.97	0
		8	7	21.82	21.79	22.02	1			3	3	22.91	22.74	22.97	0
		15	0	22.03	21.94	22.08	1			6	0	21.90	21.96	22.02	1
	16QAM	1	0	22.03	21.80	21.98	1		16QAM	1	0	22.07	21.90	22.17	1
		1	7	21.83	21.78	21.96	1			1	2	21.90	21.84	22.02	1
		1	14	21.81	21.94	21.75	1			1	5	21.75	21.82	21.82	1
		8	0	21.22	21.10	21.22	2			3	0	22.13	22.01	22.19	1
		8	3	20.89	20.72	21.02	2			3	1	21.92	21.83	22.00	1
		8	7	20.73	20.77	20.97	2			3	3	21.84	21.83	21.98	1
		15	0	20.85	21.01	20.99	2			6	0	20.93	20.79	20.92	2

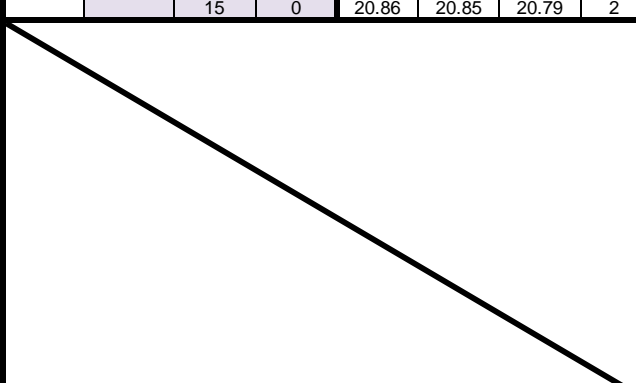
LTE Band 26																	
BW	MCS Index	RB Size	RB Offset	Low	Mid	High	3GPP MPR (dB)	BW	MCS Index	RB Size	RB Offset	Low	Mid	High	3GPP MPR (dB)		
				Channel	26865	26915						26965	Channel	26840		26915	26990
				Frequency (MHz)	831.5	836.5						841.5	Frequency (MHz)	829.0		836.5	844.0
15M	QPSK	1	0	23.23	23.14	23.17	0	10M	QPSK	1	0	23.10	23.07	23.06	0		
		1	37	23.04	23.01	22.98	0			1	24	23.02	23.00	22.80	0		
		1	74	23.03	22.94	22.97	0			1	49	23.03	22.84	22.80	0		
		36	0	22.18	22.09	22.12	1			25	0	22.09	22.01	21.91	1		
		36	19	21.94	21.86	21.88	1			25	12	21.85	21.84	21.79	1		
		36	39	22.01	21.93	21.95	1			25	25	21.99	21.90	21.86	1		
		75	0	22.11	22.08	22.05	1			50	0	22.00	21.98	21.95	1		
	16QAM	1	0	22.16	22.12	22.14	1		16QAM	1	0	22.14	21.97	22.02	1		
		1	37	21.94	21.84	21.96	1			1	24	21.80	21.82	21.75	1		
		1	74	22.00	21.91	21.90	1			1	49	21.89	21.87	21.78	1		
		36	0	21.15	21.05	21.11	2			25	0	21.06	20.92	20.97	2		
		36	19	20.88	20.83	20.87	2			25	12	20.83	20.79	20.75	2		
		36	39	20.94	20.89	20.85	2			25	25	20.79	20.82	20.82	2		
		75	0	21.06	21.06	21.04	2			50	0	20.96	20.93	20.89	2		
BW	MCS Index	RB Size	RB Offset	Low	Mid	High	3GPP MPR (dB)	BW	MCS Index	RB Size	RB Offset	Low	Mid	High	3GPP MPR (dB)		
				Channel	26815	26915						27015	Channel	26805		26915	27025
				Frequency (MHz)	826.5	836.5						846.5	Frequency (MHz)	825.5		836.5	847.5
5M	QPSK	1	0	23.09	22.93	22.96	0	3M	QPSK	1	0	23.06	22.96	23.05	1		
		1	12	22.99	22.85	22.74	0			1	7	22.90	22.65	22.80	1		
		1	24	22.95	22.75	22.74	0			1	14	22.83	22.71	22.85	1		
		12	0	22.00	22.00	21.92	1			8	0	22.00	21.82	22.03	3		
		12	6	21.82	21.74	21.78	1			8	3	21.73	21.72	21.86	3		
		12	13	21.96	21.79	21.72	1			8	7	21.78	21.81	21.90	3		
		25	0	21.88	21.98	21.86	1			15	0	21.88	21.92	21.88	6		
	16QAM	1	0	22.09	21.86	21.89	1		16QAM	1	0	21.93	21.87	21.97	1		
		1	12	21.73	21.72	21.74	1			1	7	21.73	21.65	21.90	1		
		1	24	21.87	21.87	21.88	1			1	14	21.79	21.77	21.86	1		
		12	0	21.02	20.86	20.99	2			8	0	20.80	20.86	21.02	2		
		12	6	20.80	20.70	20.81	2			8	3	20.67	20.75	20.82	2		
		12	13	20.66	20.67	20.73	2			8	7	20.68	20.72	20.76	2		
		25	0	20.92	20.83	20.83	2			15	0	20.86	20.85	20.79	2		
BW	MCS Index	RB Size	RB Offset	Low	Mid	High	3GPP MPR (dB)										
				Channel	26797	26915										27033	
				Frequency (MHz)	824.7	836.5										848.3	
1.4M	QPSK	1	0	23.00	23.05	23.14	0										
		1	2	22.96	22.77	22.85	0										
		1	5	22.74	22.71	22.91	0										
		3	0	22.87	22.90	23.04	0										
		3	1	22.77	22.70	22.79	0										
		3	3	22.81	22.78	22.84	0										
		6	0	21.97	21.84	21.87	1										
	16QAM	1	0	21.91	21.97	21.84	1										
		1	2	21.78	21.62	21.89	1										
		1	5	21.78	21.73	21.81	1										
		3	0	21.78	21.94	21.91	1										
		3	1	21.77	21.62	21.77	1										
		3	3	21.77	21.69	21.75	1										
		6	0	20.89	20.83	20.77	2										

**ERP Power (dBm)**

GPRS							
Plane	Channel	Frequency (MHz)	Reading (dBm)	Correction Factor (dB)	ERP (dBm)	ERP (mW)	Polarization (H/V)
X	128	824.2	-0.52	31.208	28.54	714.17	H
	189	836.4	-0.70	31.3	28.45	699.84	
	251	848.8	-0.48	31.222	28.59	723.10	
	128	824.2	-5.79	31.504	23.56	227.20	V
	189	836.4	-5.50	31.117	23.47	222.18	
	251	848.8	-6.16	31.922	23.61	229.72	

Note: ERP (dBm) = Reading (dBm) + Correction Factor (dB) – 2.15

EDGE							
Plane	Channel	Frequency (MHz)	Reading (dBm)	Correction Factor (dB)	ERP (dBm)	ERP (mW)	Polarization (H/V)
X	128	824.2	-6.55	31.208	22.51	178.16	H
	189	836.4	-6.58	31.3	22.57	180.72	
	251	848.8	-6.62	31.222	22.45	175.87	
	128	824.2	-11.86	31.504	17.49	56.16	V
	189	836.4	-11.40	31.117	17.57	57.11	
	251	848.8	-12.32	31.922	17.45	55.62	

Note: ERP (dBm) = Reading (dBm) + Correction Factor (dB) – 2.15

WCDMA							
Plane	Channel	Frequency (MHz)	Reading (dBm)	Correction Factor (dB)	ERP (dBm)	ERP (mW)	Polarization (H/V)
X	4132	826.4	-9.70	31.208	19.36	86.26	H
	4182	836.4	-9.60	31.3	19.55	90.16	
	4233	846.6	-9.64	31.222	19.43	87.74	
	4132	826.4	-15.00	31.504	14.35	27.25	V
	4182	836.4	-14.44	31.117	14.53	28.36	
	4233	846.6	-15.36	31.922	14.41	27.62	

Note: ERP (dBm) = Reading (dBm) + Correction Factor (dB) – 2.15

LTE Band 5							
Channel Bandwidth: 1.4 MHz / QPSK							
Plane	Channel	Frequency (MHz)	Reading (dBm)	Correction Factor (dB)	ERP (dBm)	ERP (mW)	Polarization (H/V)
X	20407	824.7	-10.54	31.208	18.52	71.09	H
	20525	836.5	-10.68	31.3	18.47	70.31	
	20643	848.3	-10.63	31.222	18.44	69.86	
	20407	824.7	-15.84	31.504	13.51	22.46	V
	20525	836.5	-15.48	31.117	13.49	22.32	
	20643	848.3	-16.37	31.922	13.40	21.89	
Channel Bandwidth: 1.4 MHz / 16QAM							
X	20407	824.7	-11.54	31.208	17.52	56.47	H
	20525	836.5	-11.69	31.3	17.46	55.72	
	20643	848.3	-11.63	31.222	17.44	55.49	
	20407	824.7	-16.84	31.504	12.51	17.84	V
	20525	836.5	-16.49	31.117	12.48	17.69	
	20643	848.3	-17.38	31.922	12.39	17.35	

Note: ERP (dBm) = Reading (dBm) + Correction Factor (dB) – 2.15

LTE Band 5							
Channel Bandwidth: 3 MHz / QPSK							
Plane	Channel	Frequency (MHz)	Reading (dBm)	Correction Factor (dB)	ERP (dBm)	ERP (mW)	Polarization (H/V)
X	20415	825.5	-10.50	31.208	18.56	71.75	H
	20525	836.5	-10.64	31.3	18.51	70.96	
	20635	847.5	-10.59	31.222	18.48	70.50	
	20415	825.5	-15.81	31.504	13.54	22.62	V
	20525	836.5	-15.44	31.117	13.53	22.53	
	20635	847.5	-16.34	31.922	13.43	22.04	
Channel Bandwidth: 3 MHz / 16QAM							
X	20415	825.5	-11.51	31.208	17.55	56.86	H
	20525	836.5	-11.65	31.3	17.50	56.23	
	20635	847.5	-11.60	31.222	17.47	55.87	
	20415	825.5	-16.81	31.504	12.54	17.96	V
	20525	836.5	-16.45	31.117	12.52	17.85	
	20635	847.5	-17.35	31.922	12.42	17.47	

Note: ERP (dBm) = Reading (dBm) + Correction Factor (dB) – 2.15

LTE Band 5							
Channel Bandwidth: 5 MHz / QPSK							
Plane	Channel	Frequency (MHz)	Reading (dBm)	Correction Factor (dB)	ERP (dBm)	ERP (mW)	Polarization (H/V)
X	20425	826.5	-10.45	31.208	18.61	72.58	H
	20525	836.5	-10.60	31.3	18.55	71.61	
	20625	846.5	-10.56	31.222	18.51	70.99	
	20425	826.5	-15.77	31.504	13.58	22.82	V
	20525	836.5	-15.44	31.117	13.53	22.53	
	20625	846.5	-16.30	31.922	13.47	22.24	
Channel Bandwidth: 5 MHz / 16QAM							
X	20425	826.5	-11.46	31.208	17.60	57.52	H
	20525	836.5	-11.61	31.3	17.54	56.75	
	20625	846.5	-11.57	31.222	17.50	56.26	
	20425	826.5	-16.77	31.504	12.58	18.13	V
	20525	836.5	-16.45	31.117	12.52	17.85	
	20625	846.5	-17.31	31.922	12.46	17.63	

Note: ERP (dBm) = Reading (dBm) + Correction Factor (dB) – 2.15

LTE Band 5							
Channel Bandwidth: 10 MHz / QPSK							
Plane	Channel	Frequency (MHz)	Reading (dBm)	Correction Factor (dB)	ERP (dBm)	ERP (mW)	Polarization (H/V)
X	20450	829.0	-10.41	31.208	18.65	73.25	H
	20525	836.5	-10.56	31.3	18.59	72.28	
	20600	844.0	-10.52	31.222	18.55	71.65	
	20450	829.0	-15.73	31.504	13.62	23.04	V
	20525	836.5	-15.40	31.117	13.57	22.74	
	20600	844.0	-16.25	31.922	13.52	22.50	
Channel Bandwidth: 10 MHz / 16QAM							
X	20425	826.5	-11.41	31.208	17.65	58.18	H
	20525	836.5	-11.56	31.3	17.59	57.41	
	20625	846.5	-11.52	31.222	17.55	56.91	
	20425	826.5	-16.74	31.504	12.61	18.26	V
	20525	836.5	-16.41	31.117	12.56	18.02	
	20625	846.5	-17.25	31.922	12.52	17.87	

Note: ERP (dBm) = Reading (dBm) + Correction Factor (dB) – 2.15

LTE Band 26							
Channel Bandwidth: 1.4 MHz / QPSK							
Plane	Channel	Frequency (MHz)	Reading (dBm)	Correction Factor (dB)	ERP (dBm)	ERP (mW)	Polarization (H/V)
X	26797	824.7	-10.57	31.208	18.49	70.60	H
	26915	836.5	-10.49	31.3	18.66	73.45	
	27033	848.3	-10.50	31.222	18.57	71.98	
	26797	824.7	-14.88	31.504	14.47	28.02	V
	26915	836.5	-14.29	31.117	14.68	29.36	
	27033	848.3	-15.20	31.922	14.57	28.65	
Channel Bandwidth: 1.4 MHz / 16QAM							
X	26797	824.7	-11.58	31.208	17.48	55.95	H
	26915	836.5	-11.50	31.3	17.65	58.21	
	27033	848.3	-11.50	31.222	17.57	57.17	
	26797	824.7	-15.89	31.504	13.46	22.20	V
	26915	836.5	-15.30	31.117	13.67	23.26	
	27033	848.3	-16.21	31.922	13.56	22.71	

Note: ERP (dBm) = Reading (dBm) + Correction Factor (dB) – 2.15

LTE Band 26							
Channel Bandwidth: 3 MHz / QPSK							
Plane	Channel	Frequency (MHz)	Reading (dBm)	Correction Factor (dB)	ERP (dBm)	ERP (mW)	Polarization (H/V)
X	26805	825.5	-10.53	31.208	18.53	71.25	H
	26915	836.5	-10.45	31.3	18.70	74.13	
	27025	847.5	-10.46	31.222	18.61	72.64	
	26805	825.5	-14.84	31.504	14.51	28.27	V
	26915	836.5	-14.25	31.117	14.72	29.63	
	27025	847.5	-15.14	31.922	14.63	29.05	
Channel Bandwidth: 3 MHz / 16QAM							
X	26805	825.5	-11.54	31.208	17.52	56.47	H
	26915	836.5	-11.45	31.3	17.70	58.88	
	27025	847.5	-11.47	31.222	17.60	57.57	
	26805	825.5	-15.85	31.504	13.50	22.41	V
	26915	836.5	-15.25	31.117	13.72	23.53	
	27025	847.5	-16.14	31.922	13.63	23.08	

Note: ERP (dBm) = Reading (dBm) + Correction Factor (dB) – 2.15

LTE Band 26							
Channel Bandwidth: 5 MHz / QPSK							
Plane	Channel	Frequency (MHz)	Reading (dBm)	Correction Factor (dB)	ERP (dBm)	ERP (mW)	Polarization (H/V)
X	26815	826.5	-10.50	31.208	18.56	71.75	H
	26915	836.5	-10.41	31.3	18.74	74.82	
	27015	846.5	-10.42	31.222	18.65	73.32	
	26815	826.5	-14.80	31.504	14.55	28.54	V
	26919	836.5	-14.22	31.117	14.75	29.83	
	27015	846.5	-15.10	31.922	14.67	29.32	
Channel Bandwidth: 5 MHz / 16QAM							
X	26815	826.5	-11.50	31.208	17.56	56.99	H
	26915	836.5	-11.42	31.3	17.73	59.29	
	27015	846.5	-11.43	31.222	17.64	58.10	
	26815	826.5	-15.81	31.504	13.54	22.62	V
	26919	836.5	-15.23	31.117	13.74	23.64	
	27015	846.5	-16.11	31.922	13.66	23.24	

Note: ERP (dBm) = Reading (dBm) + Correction Factor (dB) – 2.15

LTE Band 26							
Channel Bandwidth: 10 MHz / QPSK							
Plane	Channel	Frequency (MHz)	Reading (dBm)	Correction Factor (dB)	ERP (dBm)	ERP (mW)	Polarization (H/V)
X	26840	829.0	-10.46	31.208	18.60	72.41	H
	26915	836.5	-10.38	31.3	18.77	75.34	
	26990	844.0	-10.38	31.222	18.69	73.99	
	26840	829.0	-14.76	31.504	14.59	28.80	V
	26919	836.5	-14.18	31.117	14.79	30.11	
	26990	844.0	-15.07	31.922	14.70	29.53	
Channel Bandwidth: 10 MHz / 16QAM							
X	26840	829.0	-11.47	31.208	17.59	57.39	H
	26915	836.5	-11.38	31.3	17.77	59.84	
	26990	844.0	-11.39	31.222	17.68	58.64	
	26840	829.0	-15.77	31.504	13.58	22.82	V
	26919	836.5	-15.18	31.117	13.79	23.92	
	26990	844.0	-16.07	31.922	13.70	23.45	

Note: ERP (dBm) = Reading (dBm) + Correction Factor (dB) – 2.15



LTE Band 26							
Channel Bandwidth: 15 MHz / QPSK							
Plane	Channel	Frequency (MHz)	Reading (dBm)	Correction Factor (dB)	ERP (dBm)	ERP (mW)	Polarization (H/V)
X	26865	831.5	-10.42	31.208	18.64	73.08	H
	26915	836.5	-10.34	31.3	18.81	76.03	
	26965	841.5	-10.35	31.222	18.72	74.51	
	26865	831.5	-14.72	31.504	14.63	29.07	V
	26915	836.5	-14.14	31.117	14.83	30.39	
	26965	841.5	-15.03	31.922	14.74	29.80	
Channel Bandwidth: 15 MHz / 16QAM							
X	26865	831.5	-11.42	31.208	17.64	58.05	H
	26915	836.5	-11.35	31.3	17.80	60.26	
	26965	841.5	-11.35	31.222	17.72	59.18	
	26865	831.5	-15.73	31.504	13.62	23.04	V
	26915	836.5	-15.15	31.117	13.82	24.08	
	26965	841.5	-16.03	31.922	13.74	23.67	

Note: ERP (dBm) = Reading (dBm) + Correction Factor (dB) – 2.15

## 4.2 Modulation Characteristics Measurement

### 4.2.1 Limits of Modulation Characteristics

N/A

### 4.2.2 Test Setup



### 4.2.3 Test Procedure

Connect the EUT to Communication Simulator via the antenna connector. The frequency band is set as EUT supported Modulation and Channels, the EUT output is matched with 50 ohm load, the waveform quality and constellation of the EUT was tested.

## 4.2.4 Test Results

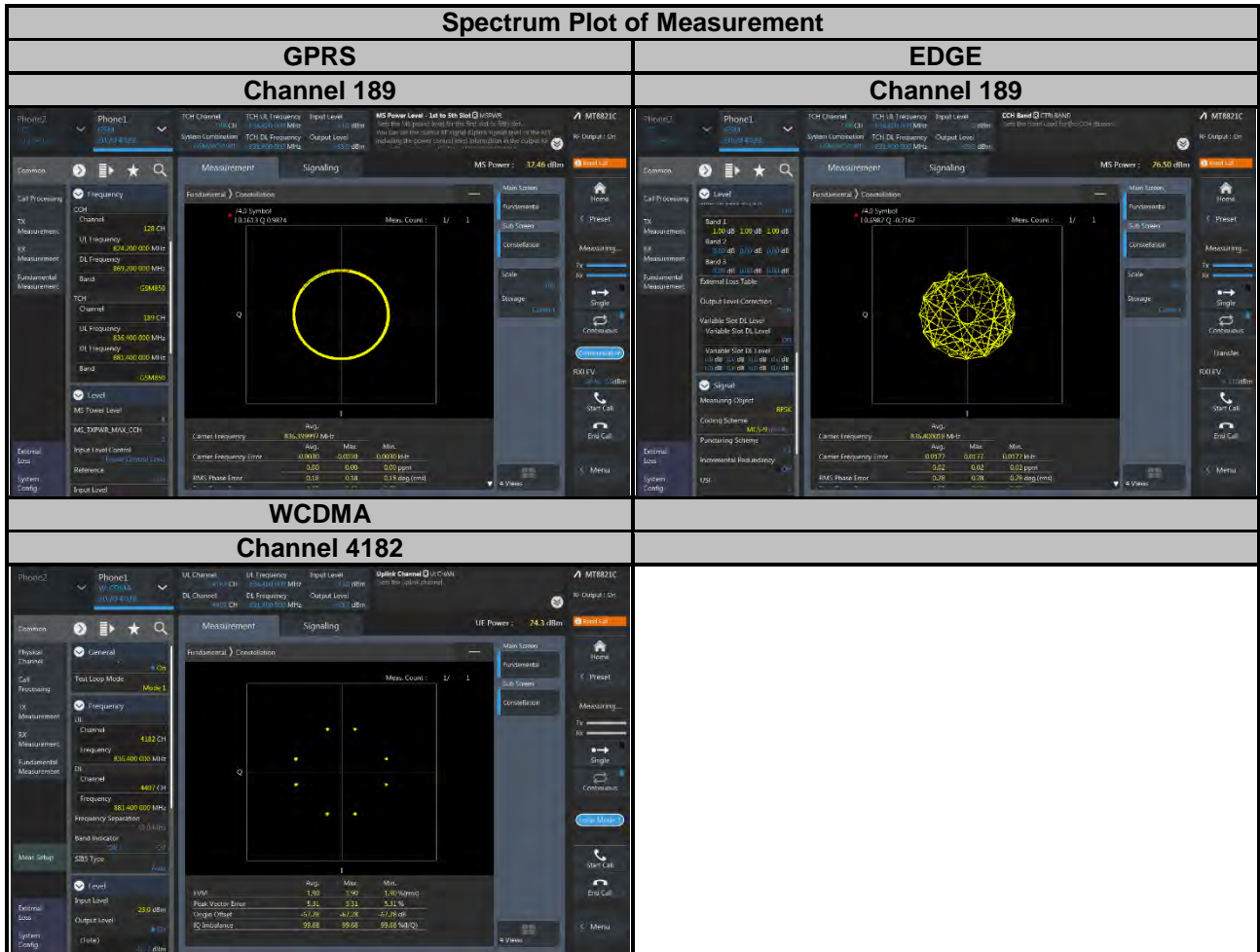

### Spectrum Plot of Measurement

#### LTE Band 5

#### Channel 20525

#### QPSK

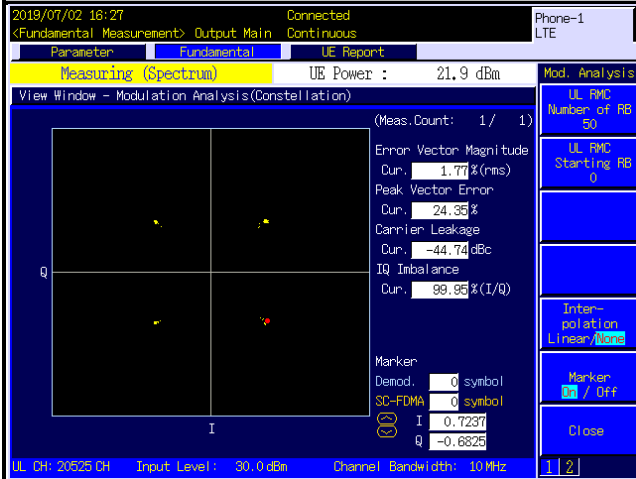

#### 16QAM

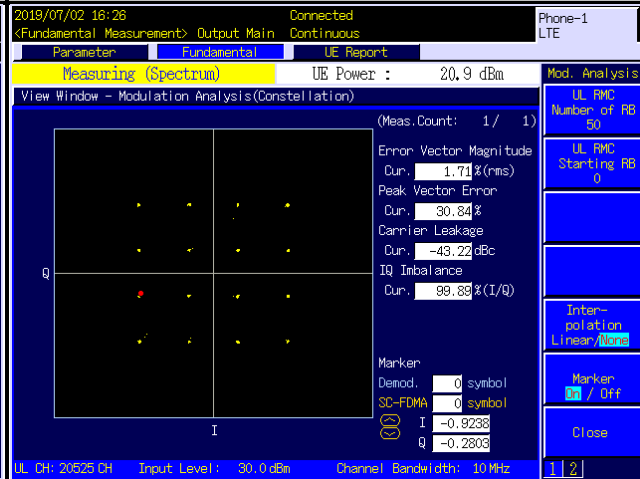

#### LTE Band 26

#### Channel 26915

#### QPSK

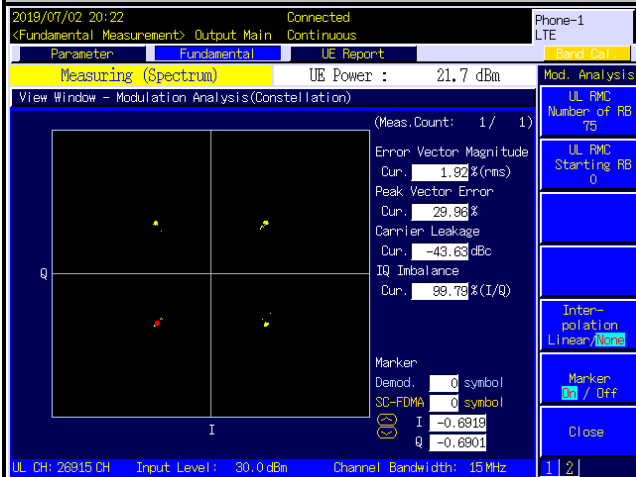

#### 16QAM

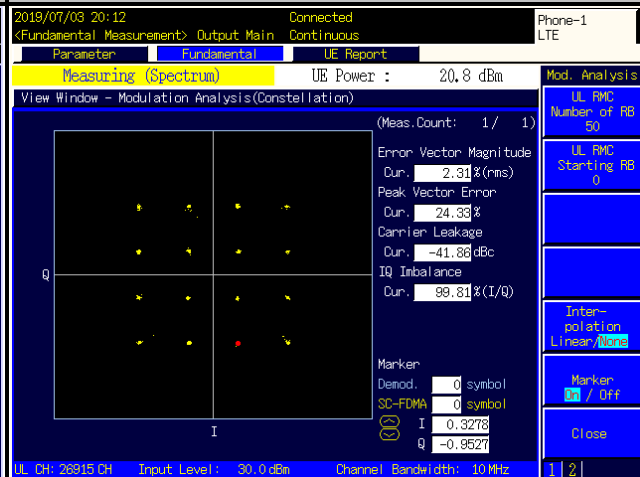

### 4.3 Frequency Stability Measurement

#### 4.3.1 Limits of Frequency Stability Measurement

1.5 ppm is for base and fixed station. 2.5 ppm is for mobile station.

#### 4.3.2 Test Procedure

- a. Device is placed at the oven room. The oven room could control the temperatures and humidity. Power warm up is at least 15 min and power applied should perform before recording frequency error.
- b. EUT is connected the external power supply to control the DC input power. The test voltage range is from minimum to maximum working voltage. Each step shall be record the frequency error rate.
- c. The temperature range step is 10 degrees in this test items. All temperature levels shall be hold the  $\pm 0.5$  °C during the measurement testing. The each temperature step shall be at least 0.5 hours, consider the EUT could be test under the stability condition.

**NOTE:** The frequency error was recorded frequency error from the communication simulator.

#### 4.3.3 Test Setup

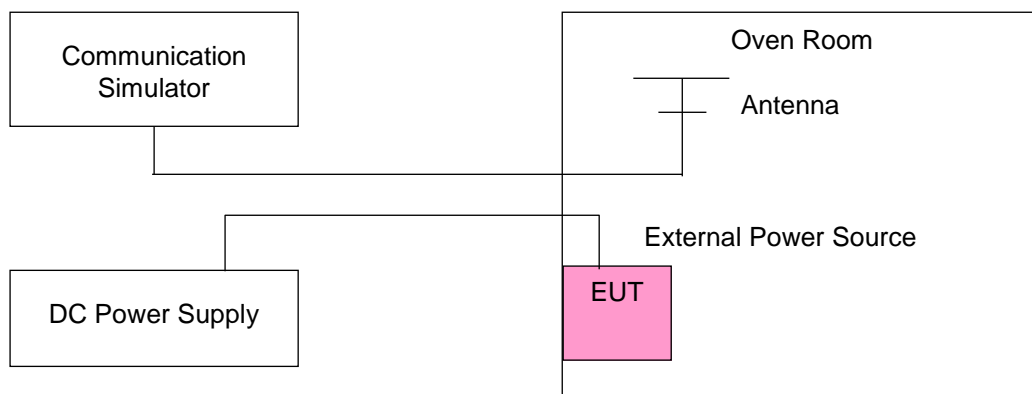

#### 4.3.4 Test Results

##### Frequency Error vs. Voltage

Voltage (Volts)	GPRS				Limit (ppm)
	Low Channel		High Channel		
	Frequency (MHz)	Frequency Error (ppm)	Frequency (MHz)	Frequency Error (ppm)	
3.7	824.200003	0.004	848.800003	0.003	2.5
3.145	824.200002	0.002	848.800004	0.004	2.5
4.255	824.200003	0.004	848.800002	0.002	2.5

**Note:** The applicant defined the normal working voltage of the battery is from 3.145 Vdc to 4.255 Vdc.

##### Frequency Error vs. Temperature

Temp. (°C)	GPRS				Limit (ppm)
	Low Channel		High Channel		
	Frequency (MHz)	Frequency Error (ppm)	Frequency (MHz)	Frequency Error (ppm)	
-30	824.200002	0.003	848.800003	0.003	2.5
-20	824.200001	0.001	848.800002	0.002	2.5
-10	824.200001	0.002	848.800004	0.004	2.5
0	824.200002	0.002	848.800004	0.004	2.5
10	824.200003	0.003	848.800002	0.002	2.5
20	824.199997	-0.004	848.799998	-0.002	2.5
30	824.199996	-0.004	848.799999	-0.002	2.5
40	824.199997	-0.004	848.799999	-0.001	2.5
50	824.199998	-0.002	848.799998	-0.003	2.5

Frequency Error vs. Voltage

Voltage (Volts)	EDGE				Limit (ppm)
	Low Channel		High Channel		
	Frequency (MHz)	Frequency Error (ppm)	Frequency (MHz)	Frequency Error (ppm)	
3.7	824.200004	0.005	848.800003	0.003	2.5
3.145	824.200002	0.003	848.800002	0.002	2.5
4.255	824.200001	0.001	848.800001	0.001	2.5

**Note:** The applicant defined the normal working voltage of the battery is from 3.145 Vdc to 4.255 Vdc.

Frequency Error vs. Temperature

Temp. (°C)	EDGE				Limit (ppm)
	Low Channel		High Channel		
	Frequency (MHz)	Frequency Error (ppm)	Frequency (MHz)	Frequency Error (ppm)	
-30	824.200002	0.003	848.800002	0.003	2.5
-20	824.200002	0.003	848.800003	0.004	2.5
-10	824.200002	0.003	848.800003	0.003	2.5
0	824.200002	0.002	848.800003	0.003	2.5
10	824.200003	0.003	848.800003	0.003	2.5
20	824.199999	-0.002	848.799998	-0.002	2.5
30	824.199996	-0.005	848.799998	-0.003	2.5
40	824.199997	-0.003	848.799996	-0.004	2.5
50	824.199998	-0.003	848.799999	-0.001	2.5

Frequency Error vs. Voltage

Voltage (Volts)	WCDMA				Limit (ppm)
	Low Channel		High Channel		
	Frequency (MHz)	Frequency Error (ppm)	Frequency (MHz)	Frequency Error (ppm)	
3.7	826.400002	0.002	846.600002	0.002	2.5
3.145	826.400004	0.004	846.600002	0.002	2.5
4.255	826.400002	0.003	846.600001	0.002	2.5

**Note:** The applicant defined the normal working voltage of the battery is from 3.145 Vdc to 4.255 Vdc.

Frequency Error vs. Temperature

Temp. (°C)	WCDMA				Limit (ppm)
	Low Channel		High Channel		
	Frequency (MHz)	Frequency Error (ppm)	Frequency (MHz)	Frequency Error (ppm)	
-30	826.400003	0.003	846.600002	0.002	2.5
-20	826.400003	0.004	846.600003	0.004	2.5
-10	826.400003	0.003	846.600002	0.002	2.5
0	826.400003	0.004	846.600004	0.005	2.5
10	826.400004	0.005	846.600003	0.004	2.5
20	826.399997	-0.004	846.599998	-0.002	2.5
30	826.399998	-0.002	846.599996	-0.004	2.5
40	826.399998	-0.003	846.599998	-0.003	2.5
50	826.399996	-0.004	846.599999	-0.002	2.5



Frequency Error vs. Voltage

Voltage (Volts)	LTE Band 5				Limit (ppm)
	Channel Bandwidth: 1.4 MHz				
	Low Channel		High Channel		
	Frequency (MHz)	Frequency Error (ppm)	Frequency (MHz)	Frequency Error (ppm)	
3.7	824.700003	0.003	848.300002	0.002	2.5
3.145	824.700003	0.004	848.300003	0.003	2.5
4.255	824.700001	0.002	848.300004	0.005	2.5

**Note:** The applicant defined the normal working voltage of the battery is from 3.145 Vdc to 4.255 Vdc.

Frequency Error vs. Temperature

Temp. (°C)	LTE Band 5				Limit (ppm)
	Channel Bandwidth: 1.4 MHz				
	Low Channel		High Channel		
	Frequency (MHz)	Frequency Error (ppm)	Frequency (MHz)	Frequency Error (ppm)	
-30	824.700002	0.002	848.300003	0.004	2.5
-20	824.700003	0.004	848.300002	0.002	2.5
-10	824.700003	0.003	848.300002	0.003	2.5
0	824.700003	0.004	848.300002	0.002	2.5
10	824.700003	0.003	848.300002	0.002	2.5
20	824.699997	-0.004	848.299996	-0.005	2.5
30	824.699998	-0.003	848.299998	-0.003	2.5
40	824.699997	-0.004	848.299999	-0.002	2.5
50	824.699997	-0.004	848.299998	-0.002	2.5

Frequency Error vs. Voltage

Voltage (Volts)	LTE Band 5				Limit (ppm)
	Channel Bandwidth: 3 MHz				
	Low Channel		High Channel		
	Frequency (MHz)	Frequency Error (ppm)	Frequency (MHz)	Frequency Error (ppm)	
3.7	825.500003	0.004	847.500002	0.003	2.5
3.145	825.500004	0.004	847.500003	0.003	2.5
4.255	825.500003	0.004	847.500002	0.002	2.5

**Note:** The applicant defined the normal working voltage of the battery is from 3.145 Vdc to 4.255 Vdc.

Frequency Error vs. Temperature

Temp. (°C)	LTE Band 5				Limit (ppm)
	Channel Bandwidth: 3 MHz				
	Low Channel		High Channel		
	Frequency (MHz)	Frequency Error (ppm)	Frequency (MHz)	Frequency Error (ppm)	
-30	825.500002	0.003	847.500002	0.002	2.5
-20	825.500002	0.003	847.500003	0.004	2.5
-10	825.500002	0.003	847.500003	0.003	2.5
0	825.500003	0.004	847.500001	0.002	2.5
10	825.500004	0.004	847.500004	0.004	2.5
20	825.499999	-0.001	847.499997	-0.003	2.5
30	825.499996	-0.004	847.499998	-0.002	2.5
40	825.499997	-0.004	847.499999	-0.001	2.5
50	825.499997	-0.004	847.499997	-0.003	2.5

Frequency Error vs. Voltage

Voltage (Volts)	LTE Band 5				Limit (ppm)
	Channel Bandwidth: 5 MHz				
	Low Channel		High Channel		
	Frequency (MHz)	Frequency Error (ppm)	Frequency (MHz)	Frequency Error (ppm)	
3.7	826.500002	0.002	846.500001	0.001	2.5
3.145	826.500001	0.001	846.500004	0.004	2.5
4.255	826.500001	0.001	846.500002	0.003	2.5

**Note:** The applicant defined the normal working voltage of the battery is from 3.145 Vdc to 4.255 Vdc.

Frequency Error vs. Temperature

Temp. (°C)	LTE Band 5				Limit (ppm)
	Channel Bandwidth: 5 MHz				
	Low Channel		High Channel		
	Frequency (MHz)	Frequency Error (ppm)	Frequency (MHz)	Frequency Error (ppm)	
-30	826.500002	0.003	846.500003	0.003	2.5
-20	826.500001	0.002	846.500003	0.003	2.5
-10	826.500004	0.004	846.500001	0.001	2.5
0	826.500002	0.002	846.500002	0.002	2.5
10	826.500003	0.003	846.500004	0.005	2.5
20	826.499997	-0.003	846.499999	-0.002	2.5
30	826.499998	-0.002	846.499998	-0.002	2.5
40	826.499998	-0.003	846.499996	-0.004	2.5
50	826.499999	-0.001	846.499997	-0.004	2.5

Frequency Error vs. Voltage

Voltage (Volts)	LTE Band 5				Limit (ppm)
	Channel Bandwidth: 10 MHz				
	Low Channel		High Channel		
	Frequency (MHz)	Frequency Error (ppm)	Frequency (MHz)	Frequency Error (ppm)	
3.7	829.000002	0.002	844.000004	0.005	2.5
3.145	829.000001	0.001	844.000003	0.004	2.5
4.255	829.000004	0.004	844.000003	0.003	2.5

**Note:** The applicant defined the normal working voltage of the battery is from 3.145 Vdc to 4.255 Vdc.

Frequency Error vs. Temperature

Temp. (°C)	LTE Band 5				Limit (ppm)
	Channel Bandwidth: 10 MHz				
	Low Channel		High Channel		
	Frequency (MHz)	Frequency Error (ppm)	Frequency (MHz)	Frequency Error (ppm)	
-30	829.000002	0.002	844.000003	0.003	2.5
-20	829.000002	0.002	844.000002	0.003	2.5
-10	829.000001	0.001	844.000003	0.003	2.5
0	829.000003	0.004	844.000004	0.004	2.5
10	829.000003	0.004	844.000001	0.002	2.5
20	828.999996	-0.004	843.999999	-0.001	2.5
30	828.999998	-0.003	843.999998	-0.002	2.5
40	828.999997	-0.003	843.999999	-0.002	2.5
50	828.999997	-0.004	843.999997	-0.003	2.5

Frequency Error vs. Voltage

Voltage (Volts)	LTE Band 26				Limit (ppm)
	Channel Bandwidth: 1.4 MHz				
	Low Channel		High Channel		
	Frequency (MHz)	Frequency Error (ppm)	Frequency (MHz)	Frequency Error (ppm)	
3.7	824.700003	0.004	848.300000	0.002	2.5
3.145	824.700003	0.004	848.300000	0.004	2.5
4.255	824.700002	0.002	848.300000	0.003	2.5

**Note:** The applicant defined the normal working voltage of the battery is from 3.145 Vdc to 4.255 Vdc.

Frequency Error vs. Temperature

Temp. (°C)	LTE Band 26				Limit (ppm)
	Channel Bandwidth: 1.4 MHz				
	Low Channel		High Channel		
	Frequency (MHz)	Frequency Error (ppm)	Frequency (MHz)	Frequency Error (ppm)	
-30	824.700003	0.004	848.300000	0.003	2.5
-20	824.700003	0.003	848.300000	0.004	2.5
-10	824.700002	0.002	848.300000	0.001	2.5
0	824.700003	0.004	848.300000	0.002	2.5
10	824.700004	0.004	848.300000	0.002	2.5
20	824.699996	-0.005	848.300000	-0.002	2.5
30	824.699998	-0.002	848.300000	-0.003	2.5
40	824.699996	-0.004	848.300000	-0.003	2.5
50	824.699997	-0.004	848.300000	-0.003	2.5

Frequency Error vs. Voltage

Voltage (Volts)	LTE Band 26				Limit (ppm)
	Channel Bandwidth: 3 MHz				
	Low Channel		High Channel		
	Frequency (MHz)	Frequency Error (ppm)	Frequency (MHz)	Frequency Error (ppm)	
3.7	825.500002	0.002	847.500000	0.004	2.5
3.145	825.500004	0.005	847.500000	0.004	2.5
4.255	825.500002	0.002	847.500000	0.004	2.5

**Note:** The applicant defined the normal working voltage of the battery is from 3.145 Vdc to 4.255 Vdc.

Frequency Error vs. Temperature

Temp. (°C)	LTE Band 26				Limit (ppm)
	Channel Bandwidth: 3 MHz				
	Low Channel		High Channel		
	Frequency (MHz)	Frequency Error (ppm)	Frequency (MHz)	Frequency Error (ppm)	
-30	825.500002	0.003	847.500000	0.003	2.5
-20	825.500002	0.003	847.500000	0.003	2.5
-10	825.500003	0.004	847.500000	0.004	2.5
0	825.500003	0.004	847.500000	0.002	2.5
10	825.500001	0.001	847.500000	0.003	2.5
20	825.499998	-0.002	847.500000	-0.004	2.5
30	825.499997	-0.003	847.500000	-0.003	2.5
40	825.499999	-0.002	847.500000	-0.004	2.5
50	825.499999	-0.001	847.500000	-0.002	2.5

Frequency Error vs. Voltage

Voltage (Volts)	LTE Band 26				Limit (ppm)
	Channel Bandwidth: 5 MHz				
	Low Channel		High Channel		
	Frequency (MHz)	Frequency Error (ppm)	Frequency (MHz)	Frequency Error (ppm)	
3.7	826.500002	0.003	846.500002	0.002	2.5
3.145	826.500002	0.002	846.500003	0.004	2.5
4.255	826.500002	0.003	846.500001	0.002	2.5

**Note:** The applicant defined the normal working voltage of the battery is from 3.145 Vdc to 4.255 Vdc.

Frequency Error vs. Temperature

Temp. (°C)	LTE Band 26				Limit (ppm)
	Channel Bandwidth: 5 MHz				
	Low Channel		High Channel		
	Frequency (MHz)	Frequency Error (ppm)	Frequency (MHz)	Frequency Error (ppm)	
-30	826.500003	0.003	846.500003	0.003	2.5
-20	826.500002	0.003	846.500003	0.003	2.5
-10	826.500003	0.003	846.500003	0.004	2.5
0	826.500003	0.004	846.500001	0.002	2.5
10	826.500002	0.002	846.500004	0.004	2.5
20	826.499997	-0.003	846.499999	-0.002	2.5
30	826.499997	-0.004	846.499997	-0.003	2.5
40	826.499997	-0.003	846.499998	-0.002	2.5
50	826.499997	-0.004	846.499997	-0.004	2.5

Frequency Error vs. Voltage

Voltage (Volts)	LTE Band 26				Limit (ppm)
	Channel Bandwidth: 10 MHz				
	Low Channel		High Channel		
	Frequency (MHz)	Frequency Error (ppm)	Frequency (MHz)	Frequency Error (ppm)	
3.7	829.000001	0.002	844.000001	0.001	2.5
3.145	829.000002	0.003	844.000002	0.003	2.5
4.255	829.000004	0.004	844.000003	0.004	2.5

**Note:** The applicant defined the normal working voltage of the battery is from 3.145 Vdc to 4.255 Vdc.

Frequency Error vs. Temperature

Temp. (°C)	LTE Band 26				Limit (ppm)
	Channel Bandwidth: 10 MHz				
	Low Channel		High Channel		
	Frequency (MHz)	Frequency Error (ppm)	Frequency (MHz)	Frequency Error (ppm)	
-30	829.000002	0.002	844.000002	0.003	2.5
-20	829.000002	0.003	844.000003	0.003	2.5
-10	829.000004	0.004	844.000003	0.003	2.5
0	829.000002	0.002	844.000003	0.003	2.5
10	829.000004	0.004	844.000004	0.005	2.5
20	828.999996	-0.004	843.999997	-0.004	2.5
30	828.999996	-0.005	843.999997	-0.003	2.5
40	828.999996	-0.005	843.999997	-0.004	2.5
50	828.999997	-0.004	843.999999	-0.002	2.5



Frequency Error vs. Voltage

Voltage (Volts)	LTE Band 26				Limit (ppm)
	Channel Bandwidth: 15 MHz				
	Low Channel		High Channel		
	Frequency (MHz)	Frequency Error (ppm)	Frequency (MHz)	Frequency Error (ppm)	
3.7	831.500001	0.002	841.500001	0.002	2.5
3.145	831.500003	0.003	841.500002	0.002	2.5
4.255	831.500002	0.003	841.500001	0.001	2.5

**Note:** The applicant defined the normal working voltage of the battery is from 3.145 Vdc to 4.255 Vdc.

Frequency Error vs. Temperature

Temp. (°C)	LTE Band 26				Limit (ppm)
	Channel Bandwidth: 15 MHz				
	Low Channel		High Channel		
	Frequency (MHz)	Frequency Error (ppm)	Frequency (MHz)	Frequency Error (ppm)	
-30	831.500002	0.003	841.500002	0.003	2.5
-20	831.500002	0.003	841.500003	0.003	2.5
-10	831.500002	0.002	841.500002	0.002	2.5
0	831.500003	0.004	841.500001	0.001	2.5
10	831.500003	0.004	841.500004	0.004	2.5
20	831.499997	-0.004	841.499998	-0.002	2.5
30	831.499997	-0.004	841.499997	-0.004	2.5
40	831.499997	-0.003	841.499998	-0.002	2.5
50	831.499998	-0.002	841.499997	-0.003	2.5

## 4.4 Occupied Bandwidth Measurement

### 4.4.1 Test Procedure

The EUT makes a call to the communication simulator. All measurements were done at low, middle and high operational frequency range. The communication simulator station system controlled a EUT to export maximum output power under transmission mode and specific channel frequency. Use OBW measurement function of Spectrum analyzer to measure 99 % occupied bandwidth.

### 4.4.2 Test Setup

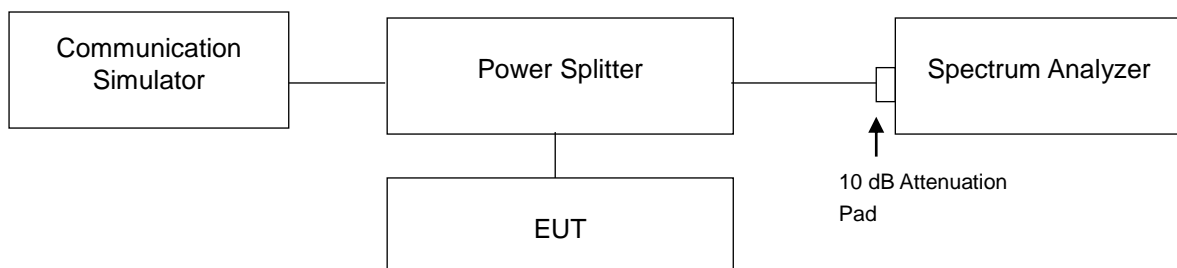

### 4.4.3 Test Result

GPRS				EDGE			
Channel	Frequency (MHz)	99 % Occupied Bandwidth (kHz)	26 dB Bandwidth (kHz)	Channel	Frequency (MHz)	99 % Occupied Bandwidth (kHz)	26 dB Bandwidth (kHz)
128	824.2	242.91	310.90	128	824.2	246.46	302.90
189	836.4	242.48	309.70	189	836.4	244.75	309.40
251	848.8	244.21	311.20	251	848.8	242.23	314.00

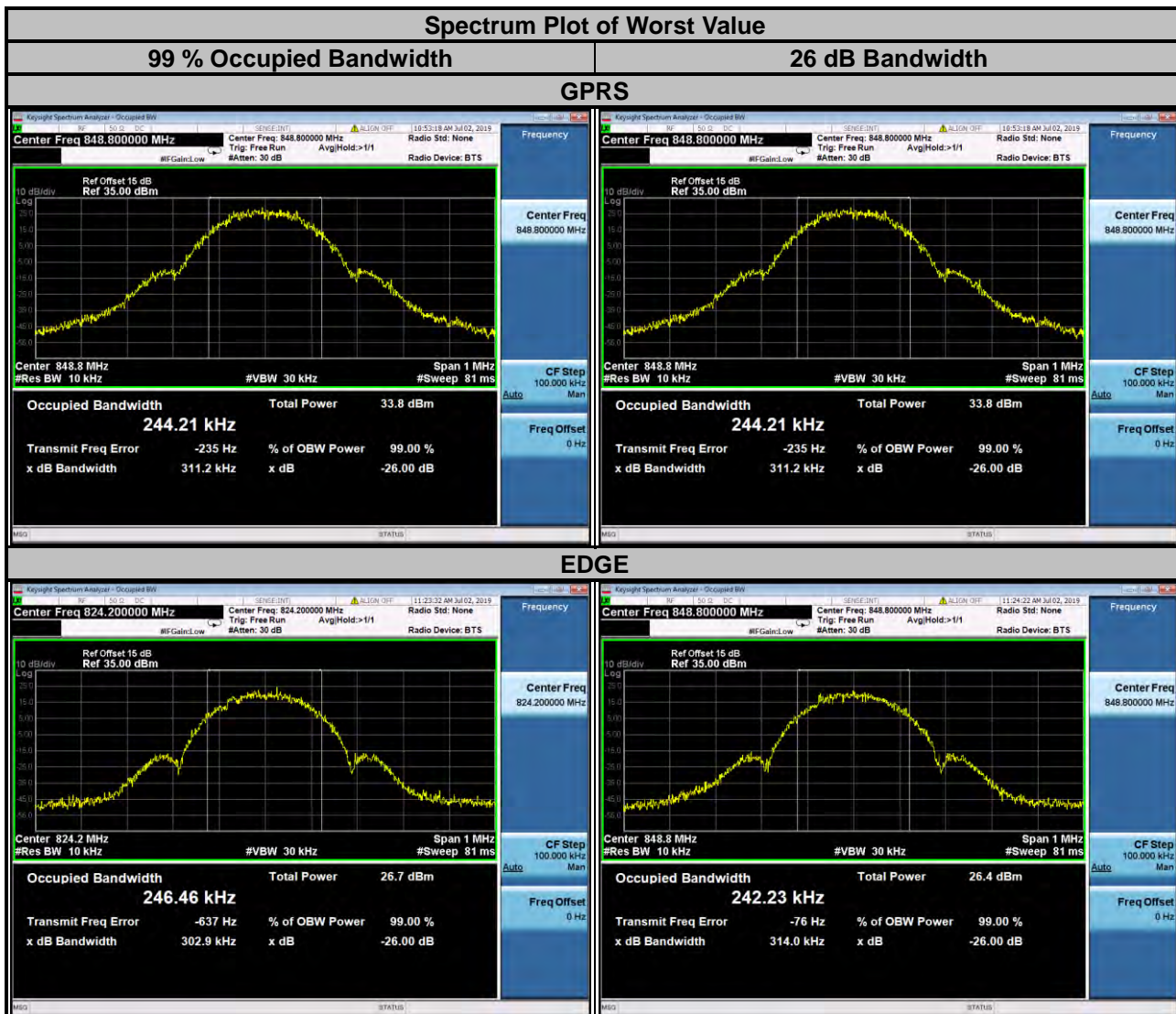

WCDMA			
Channel	Frequency (MHz)	99 % Occupied Bandwidth (MHz)	26 dB Bandwidth (MHz)
4132	826.4	4.1619	4.734
4182	836.4	4.1571	4.748
4233	846.6	4.1458	4.737

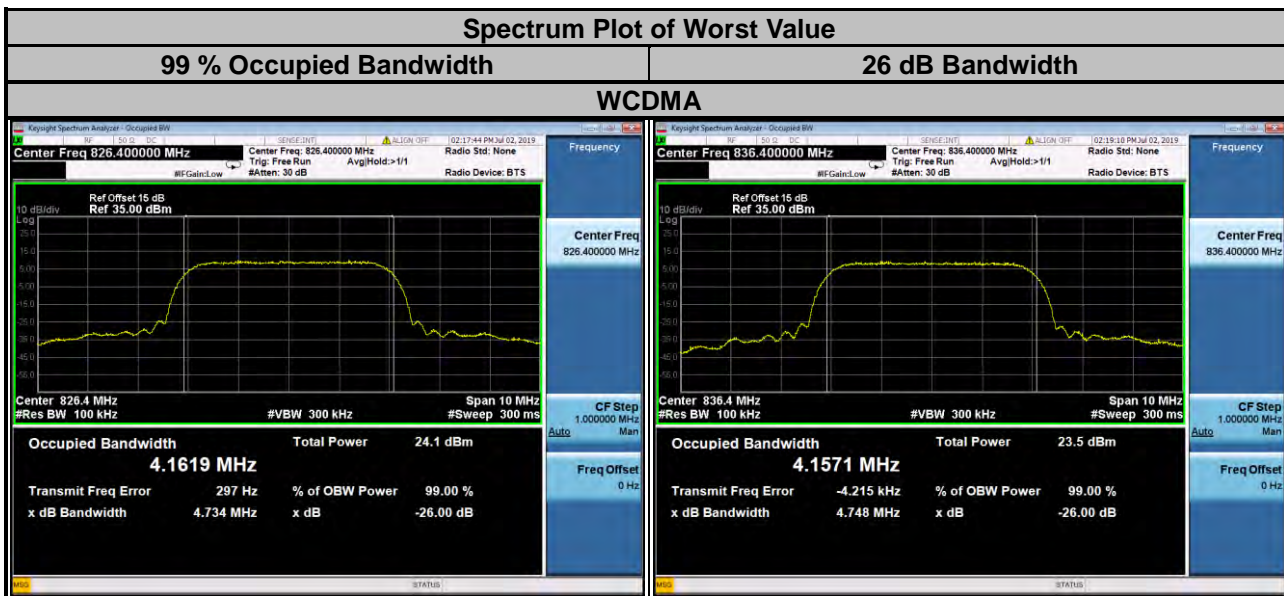

LTE Band 5					
Channel Bandwidth: 1.4 MHz					
Channel	Frequency (MHz)	99 % Occupied Bandwidth (MHz)		26 dB Bandwidth (MHz)	
		QPSK	16QAM	QPSK	16QAM
20407	824.7	1.0861	1.0895	1.244	1.245
20525	836.5	1.0875	1.0887	1.240	1.257
20643	848.3	1.0881	1.0891	1.257	1.254

Channel Bandwidth: 3 MHz					
Channel	Frequency (MHz)	99 % Occupied Bandwidth (MHz)		26 dB Bandwidth (MHz)	
		QPSK	16QAM	QPSK	16QAM
20415	825.5	2.7027	2.6981	2.926	2.927
20525	836.5	2.7026	2.6976	2.921	2.921
20635	847.5	2.7009	2.6972	2.909	2.922

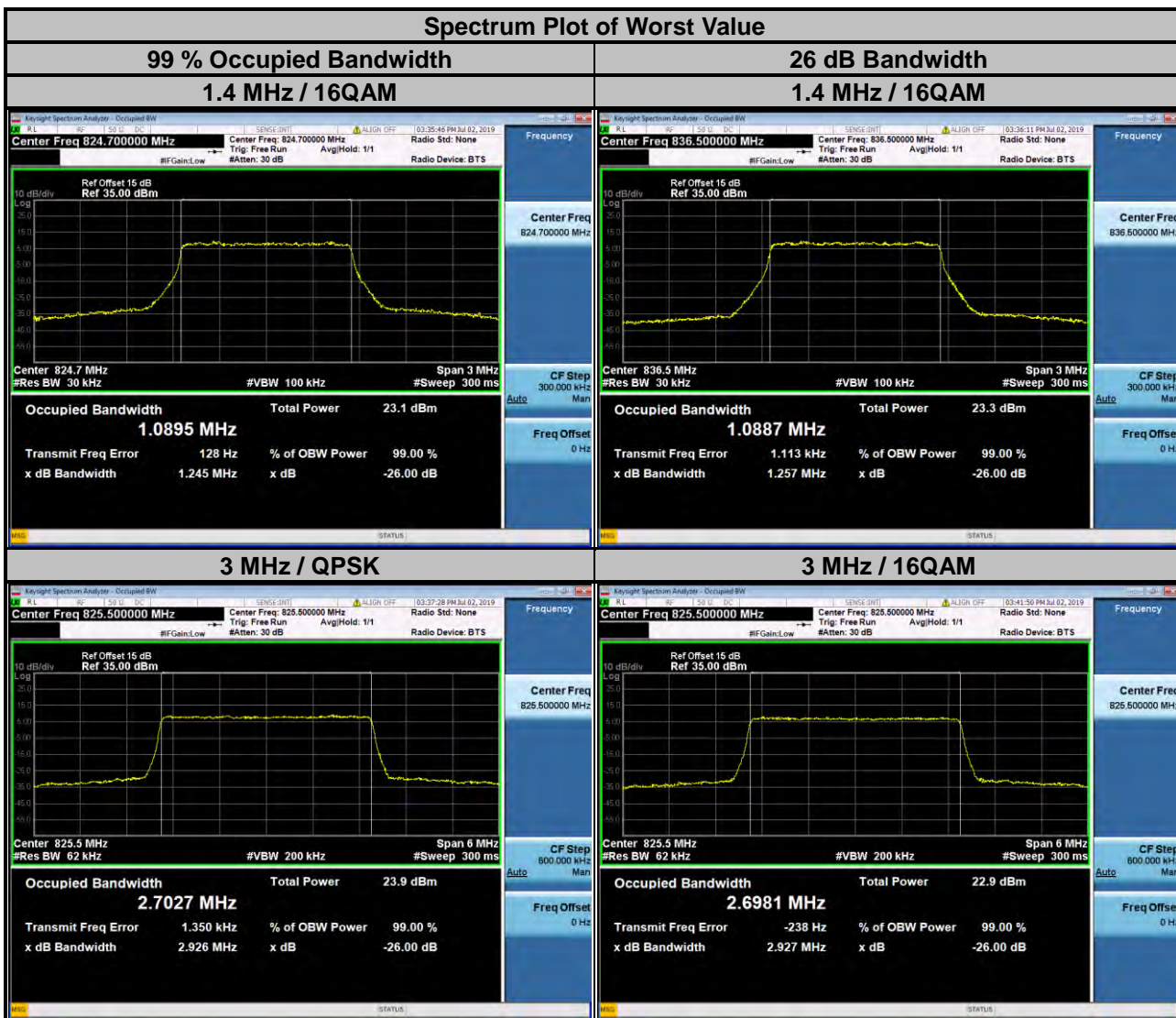

LTE Band 5					
Channel Bandwidth: 5 MHz					
Channel	Frequency (MHz)	99 % Occupied Bandwidth (MHz)		26 dB Bandwidth (MHz)	
		QPSK	16QAM	QPSK	16QAM
20425	826.5	4.4938	4.4947	4.820	4.830
20525	836.5	4.4953	4.4963	4.827	4.824
20625	846.5	4.4890	4.4878	4.810	4.815

Channel Bandwidth: 10 MHz					
Channel	Frequency (MHz)	99 % Occupied Bandwidth (MHz)		26 dB Bandwidth (MHz)	
		QPSK	16QAM	QPSK	16QAM
20450	829.0	8.9653	8.9772	9.531	9.526
20525	836.5	8.9564	8.9558	9.506	9.516
20600	844.0	8.9463	8.9444	9.505	9.506



LTE Band 26					
Channel Bandwidth: 1.4 MHz					
Channel	Frequency (MHz)	99 % Occupied Bandwidth (MHz)		26 dB Bandwidth (MHz)	
		QPSK	16QAM	QPSK	16QAM
26797	824.7	1.0887	1.0892	1.251	1.250
26915	836.5	1.0888	1.0899	1.268	1.264
27033	848.3	1.0880	1.0905	1.255	1.258

Channel Bandwidth: 3 MHz					
Channel	Frequency (MHz)	99 % Occupied Bandwidth (MHz)		26 dB Bandwidth (MHz)	
		QPSK	16QAM	QPSK	16QAM
26805	825.5	2.7019	2.6999	2.923	2.935
26915	836.5	2.7034	2.6986	2.922	2.933
27025	847.5	2.7006	2.6973	2.915	2.925



LTE Band 26					
Channel Bandwidth: 5 MHz					
Channel	Frequency (MHz)	99 % Occupied Bandwidth (MHz)		26 dB Bandwidth (MHz)	
		QPSK	16QAM	QPSK	16QAM
26815	826.5	4.4960	4.4962	4.822	4.826
26915	836.5	4.4936	4.4965	4.837	4.842
27015	846.5	4.4906	4.4931	4.812	4.817

  

Channel Bandwidth: 10 MHz					
Channel	Frequency (MHz)	99 % Occupied Bandwidth (MHz)		26 dB Bandwidth (MHz)	
		QPSK	16QAM	QPSK	16QAM
26840	829.0	8.9674	8.9694	9.536	9.521
26915	836.5	8.9633	8.9596	9.522	9.519
26990	844.0	8.9450	8.9486	9.509	9.509





LTE Band 26					
Channel Bandwidth: 15 MHz					
Channel	Frequency (MHz)	99 % Occupied Bandwidth (MHz)		26 dB Bandwidth (MHz)	
		QPSK	16QAM	QPSK	16QAM
26865	831.5	13.459	13.445	14.26	14.27
26915	836.5	13.460	13.451	14.26	14.25
26965	841.5	13.455	13.440	14.25	14.26

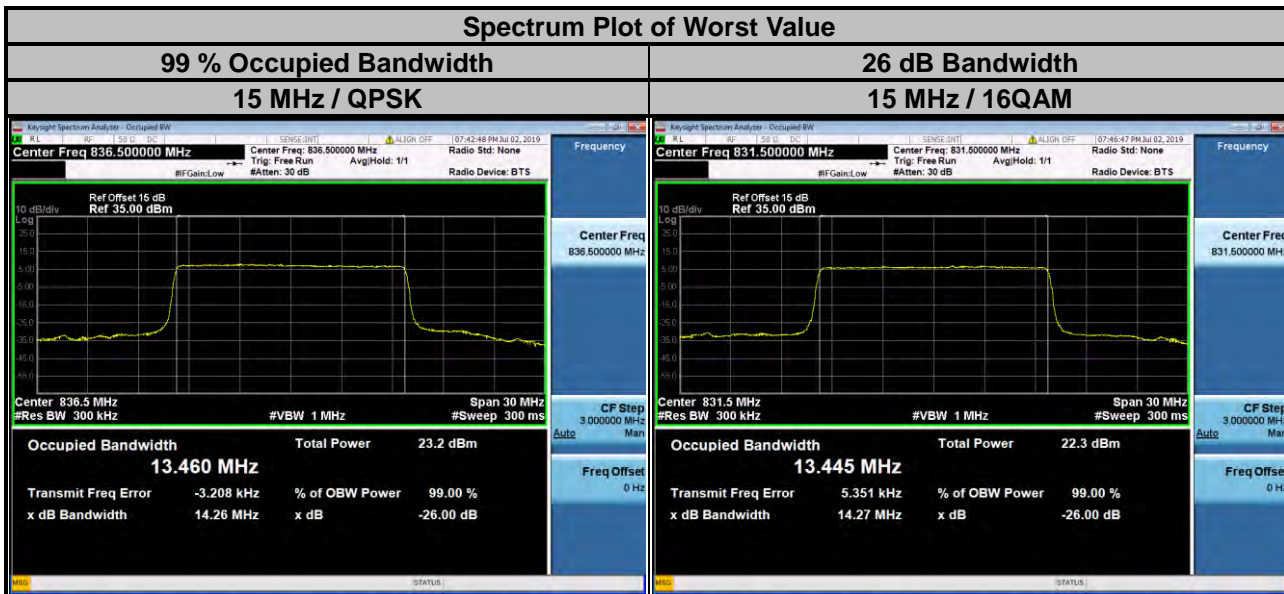

## 4.5 Band Edge Measurement

### 4.5.1 Limits of Band Edge Measurement

Power of any emission outside of the authorized operating frequency ranges must be attenuated below the transmitting power (P) by a factor of at least  $43 + 10 \log(P)$  dB. In the 1 MHz bands immediately outside and adjacent to the frequency block a resolution bandwidth of at least one percent of the emission bandwidth of the fundamental emission of the transmitter may be employed.

### 4.5.2 Test Setup

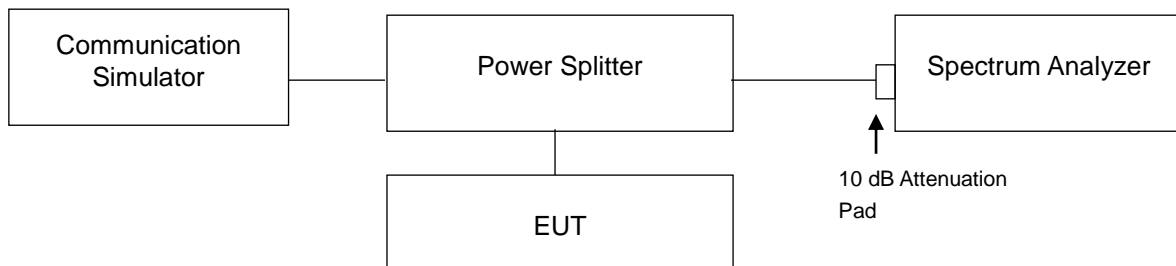

### 4.5.3 Test Procedures

- All measurements were done at low and high operational frequency range.
- The center frequency of spectrum is the band edge frequency and span is 1 MHz. RB of the spectrum is 3.6 kHz and VB of the spectrum is 11 kHz (GPRS/EDGE).
- The center frequency of spectrum is the band edge frequency and span is 5 MHz. RB of the spectrum is 100 kHz and VB of the spectrum is 300 kHz (WCDMA).
- The center frequency of spectrum is the band edge frequency and span is 1 MHz. RB of the spectrum is 15 kHz and VB of the spectrum is 51 kHz (LTE Bandwidth 1.4 MHz).
- The center frequency of spectrum is the band edge frequency and span is 1 MHz. RB of the spectrum is 30 kHz and VB of the spectrum is 100 kHz (LTE Bandwidth 3 MHz).
- The center frequency of spectrum is the band edge frequency and span is 1 MHz. RB of the spectrum is 51 kHz and VB of the spectrum is 160 kHz (LTE Bandwidth 5 MHz).
- The center frequency of spectrum is the band edge frequency and span is 1 MHz. RB of the spectrum is 100 kHz and VB of the spectrum is 300 kHz (LTE Bandwidth 10 MHz).
- The center frequency of spectrum is the band edge frequency and span is 1 MHz. RB of the spectrum is 150 kHz and VB of the spectrum is 470 kHz (LTE Bandwidth 15 MHz).
- Record the max trace plot into the test report.

### 4.5.4 Test Results

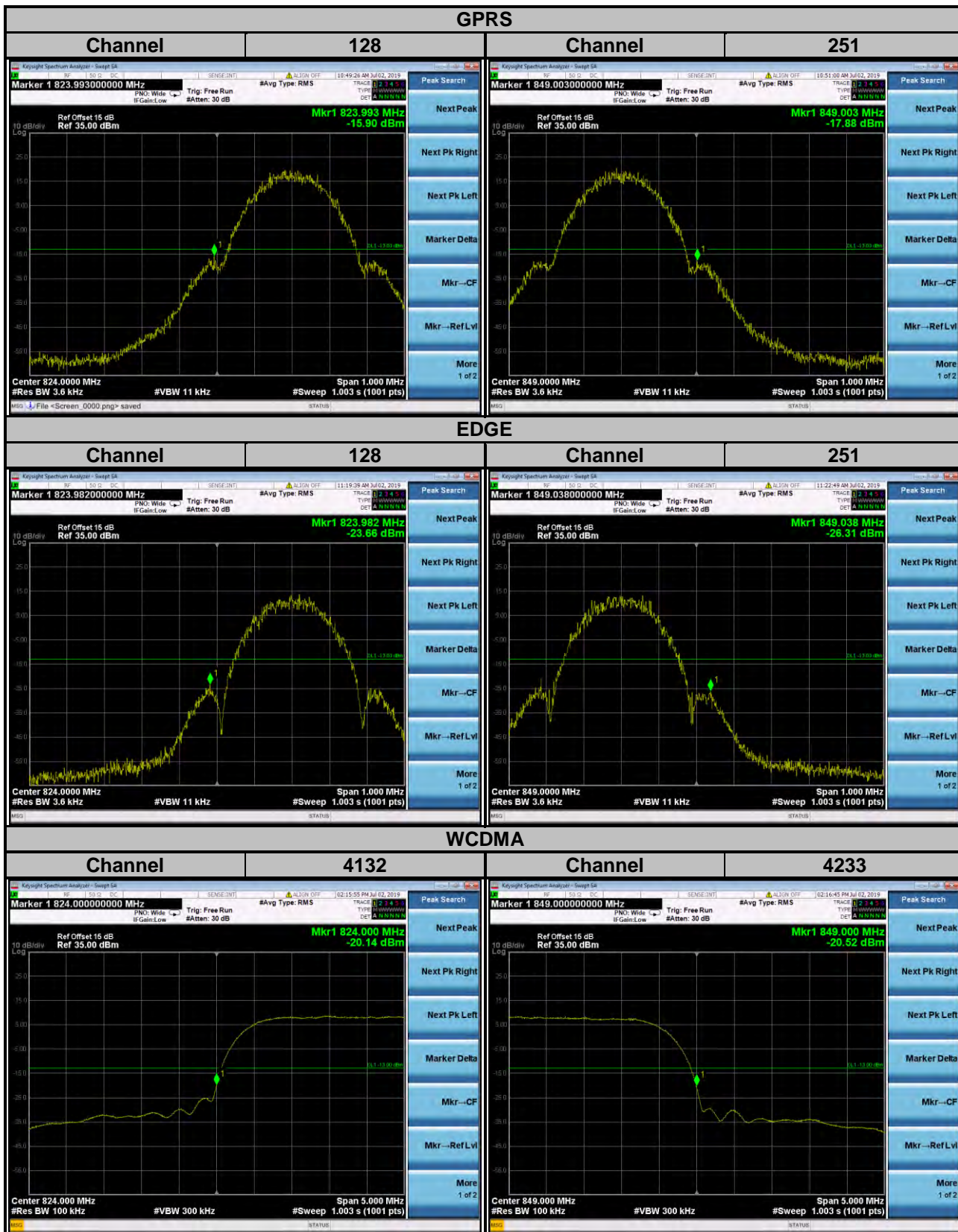

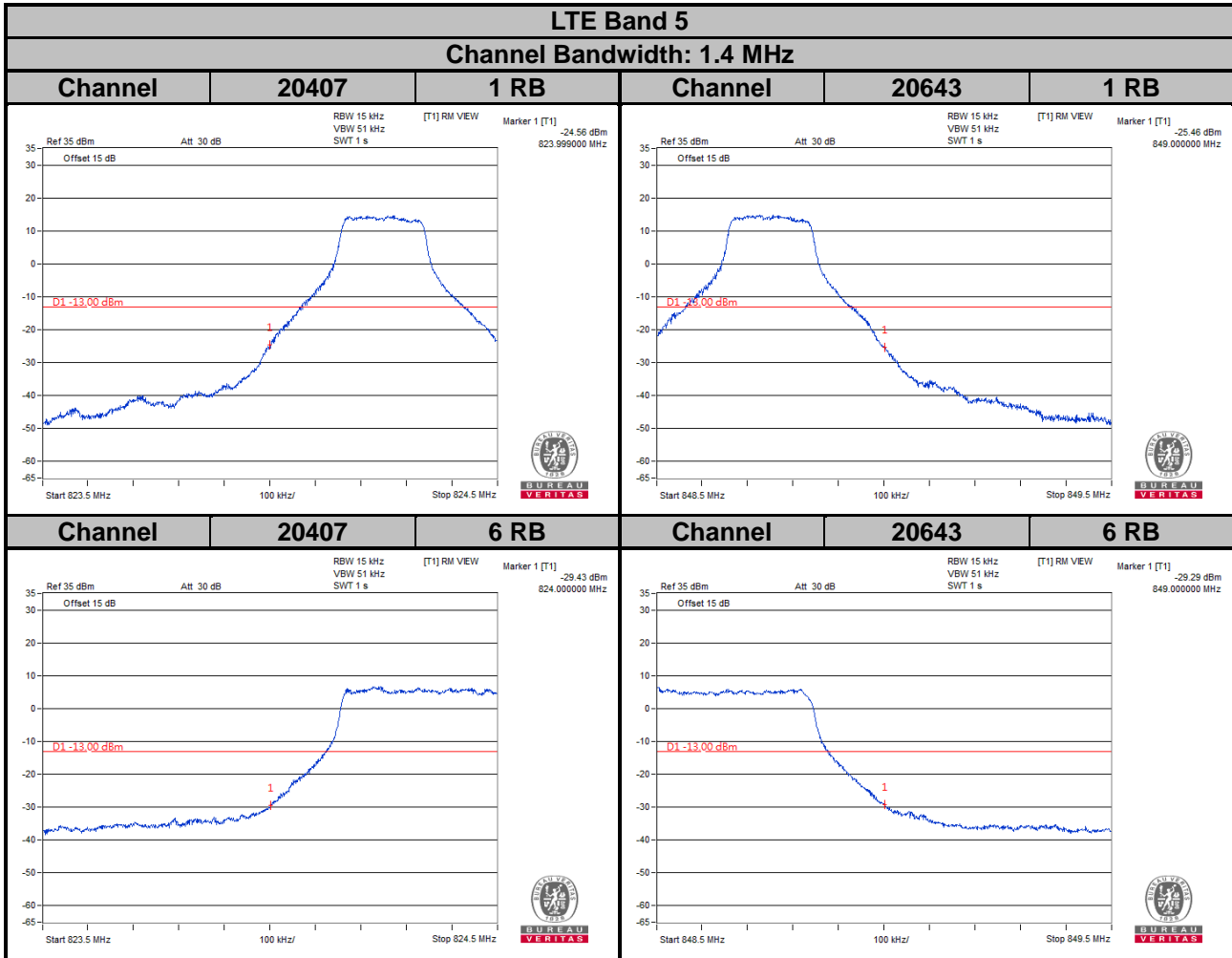

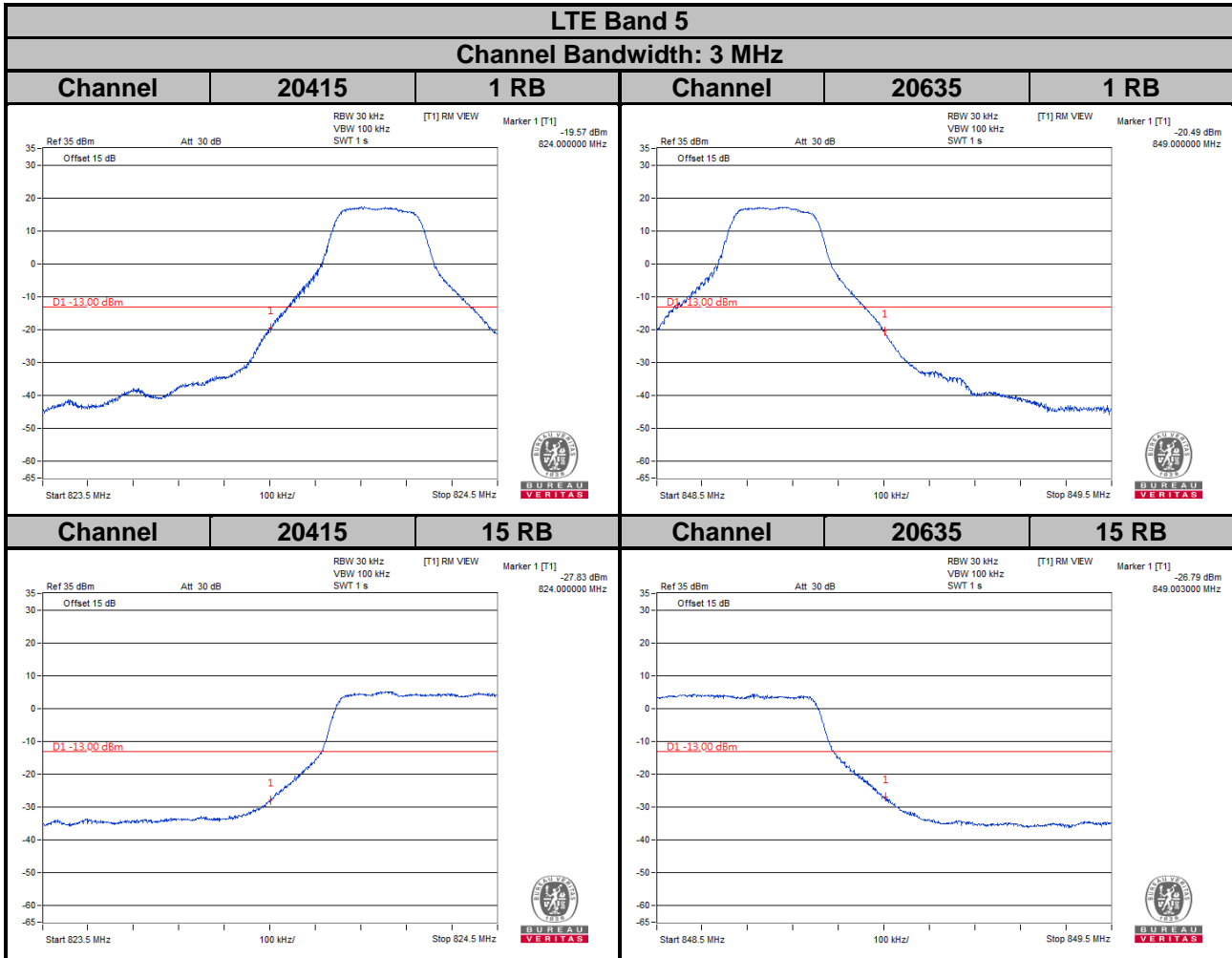

**LTE Band 5**  
**Channel Bandwidth: 5 MHz**

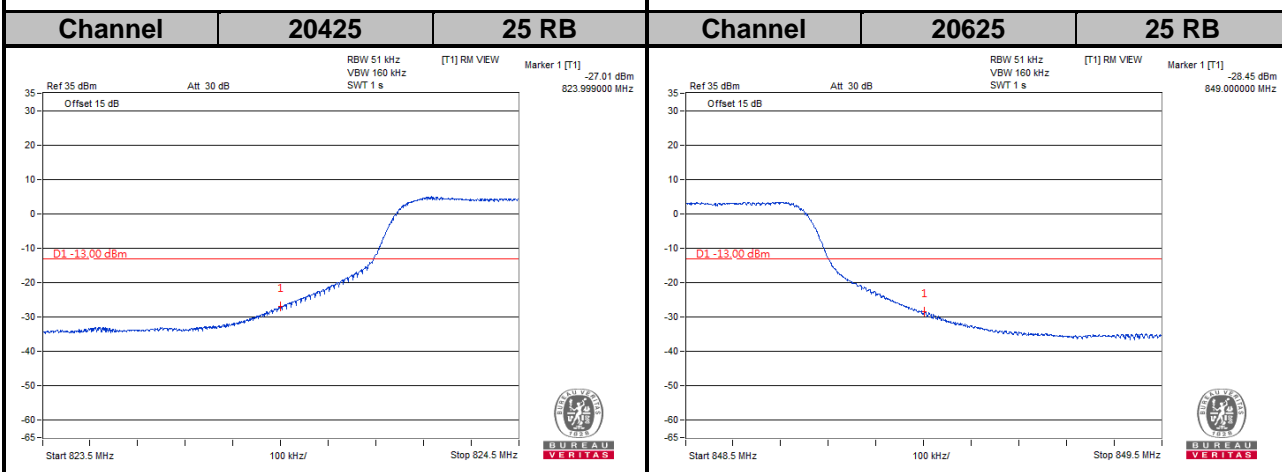
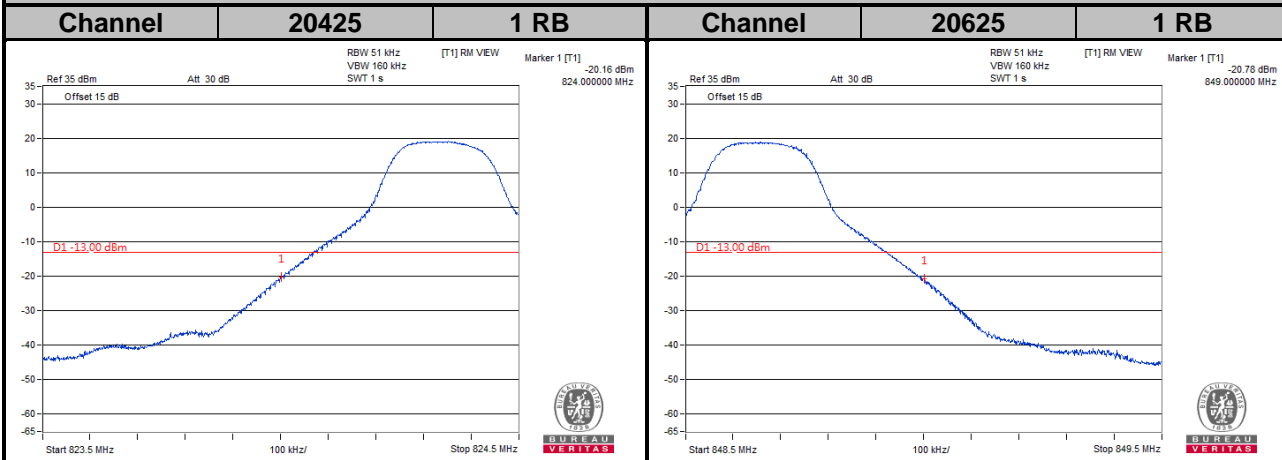

**LTE Band 5**  
**Channel Bandwidth: 10 MHz**

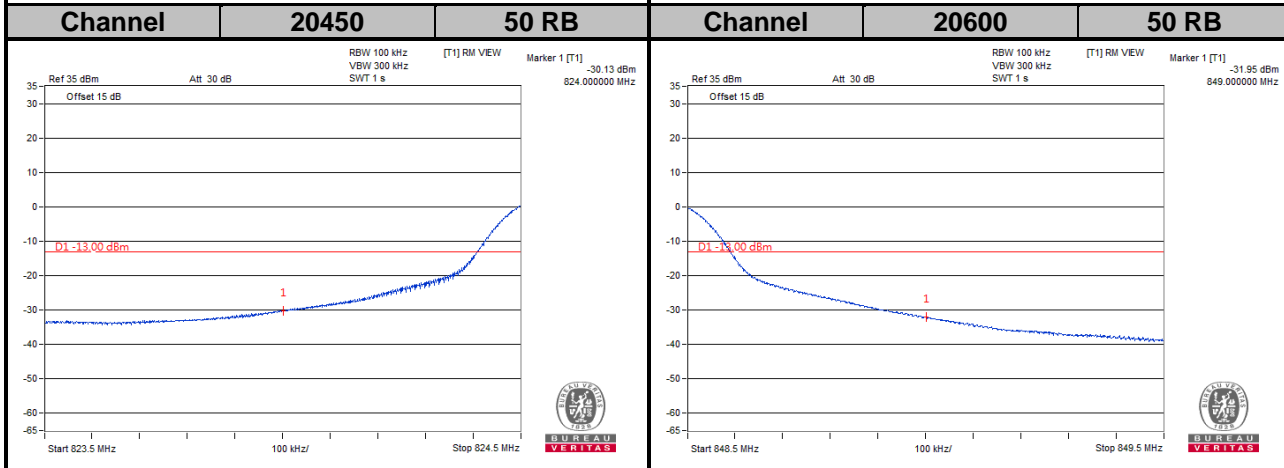
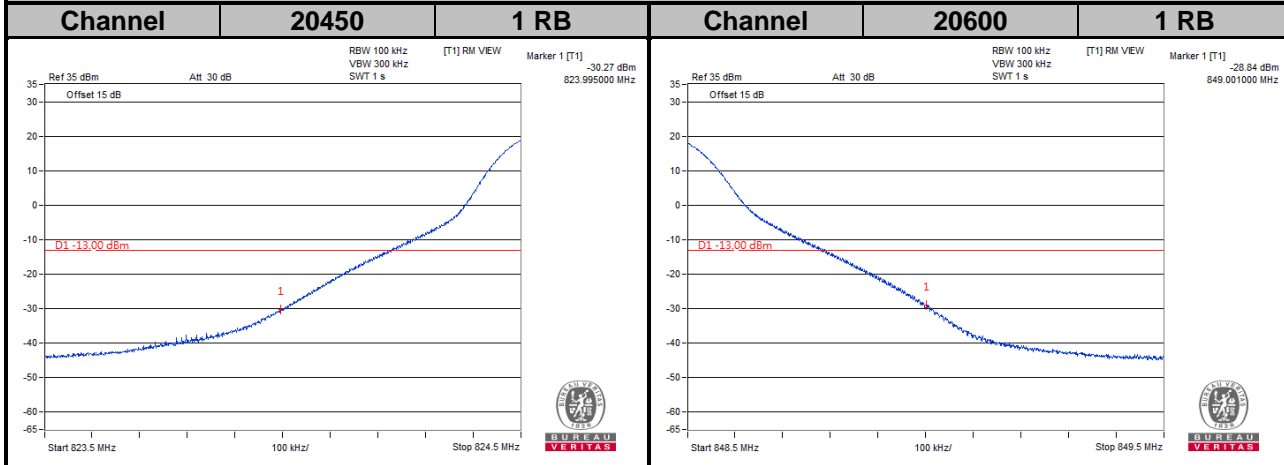

### LTE Band 26

#### Channel Bandwidth: 1.4 MHz

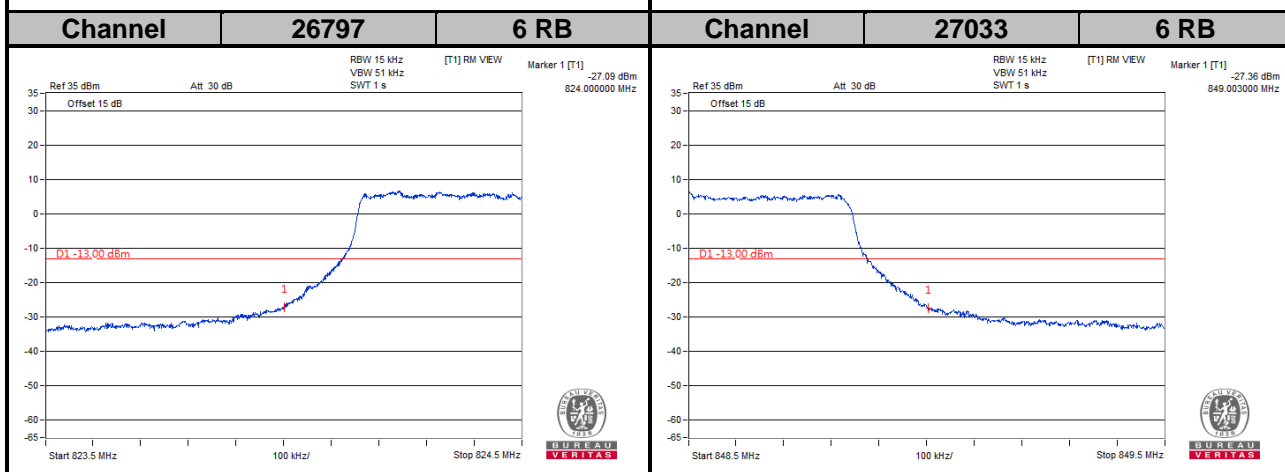
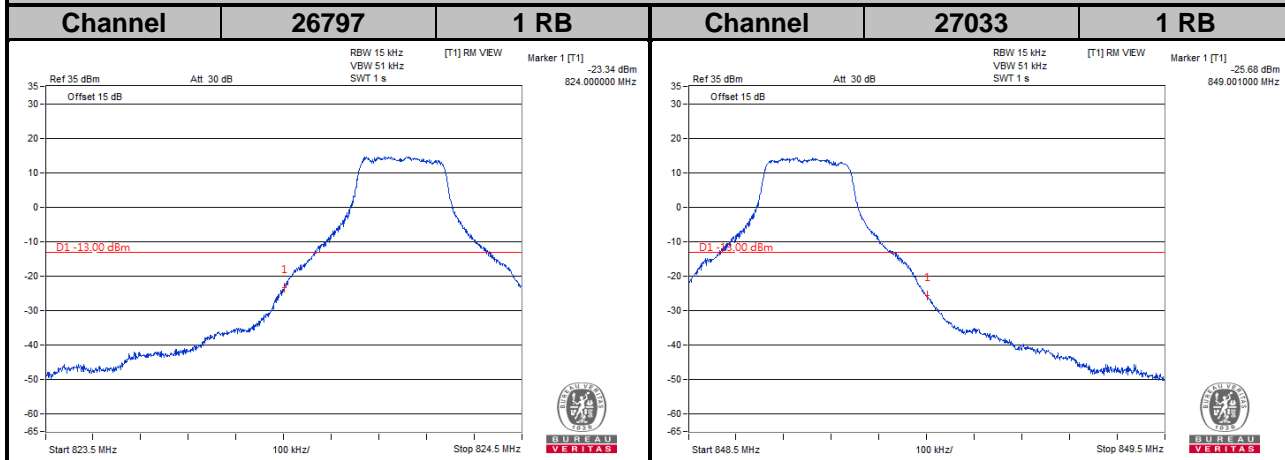



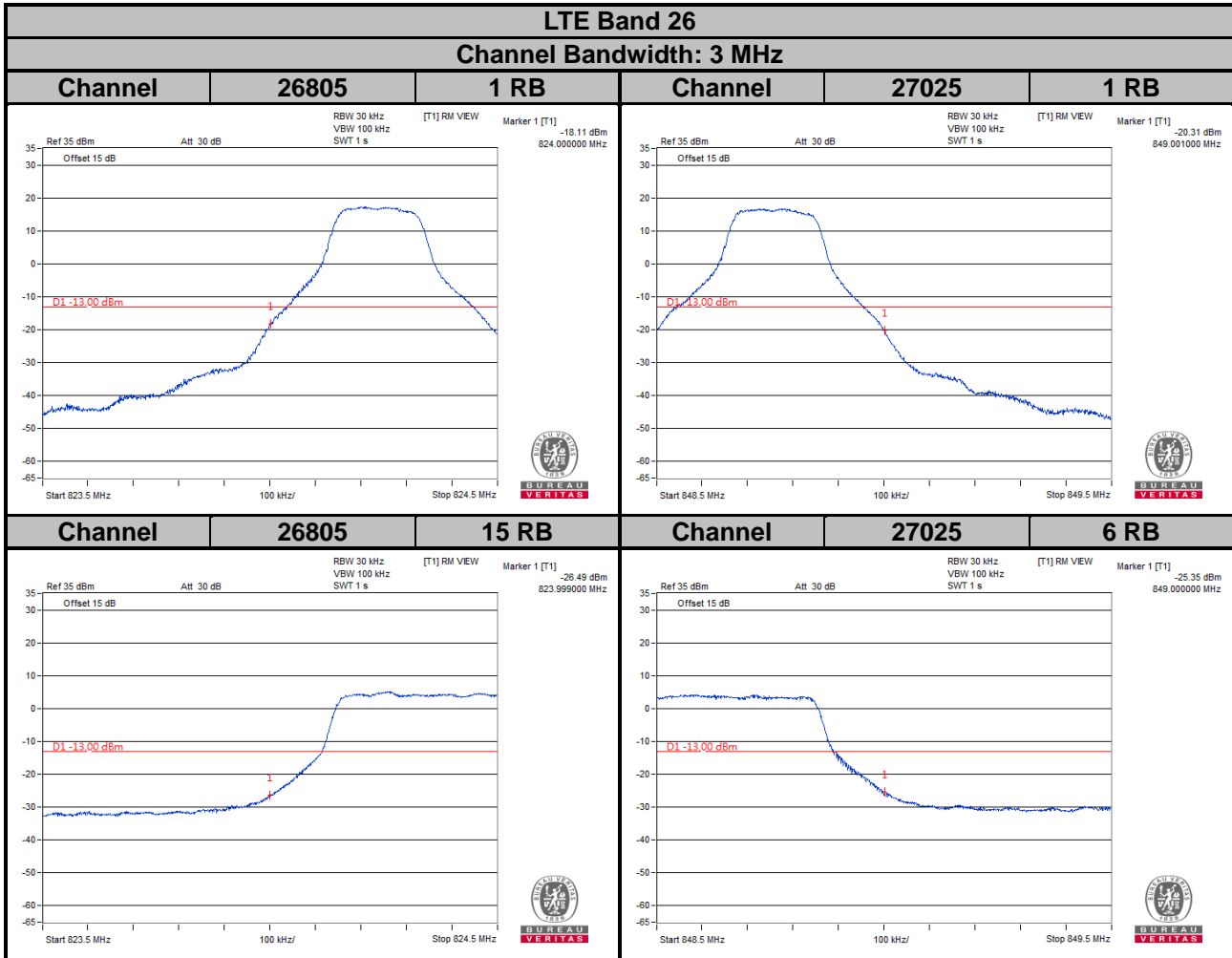

**LTE Band 26**  
**Channel Bandwidth: 5 MHz**

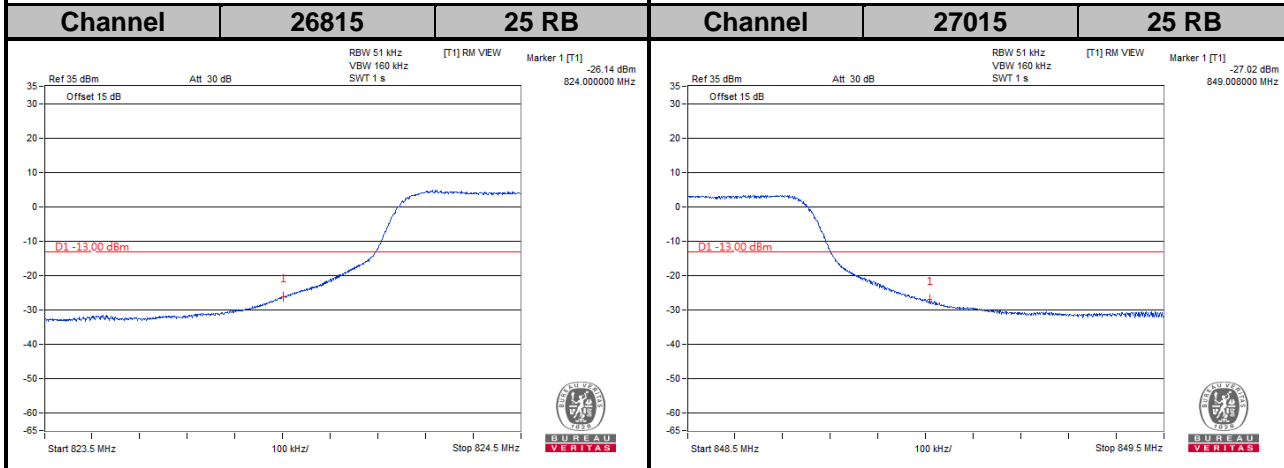
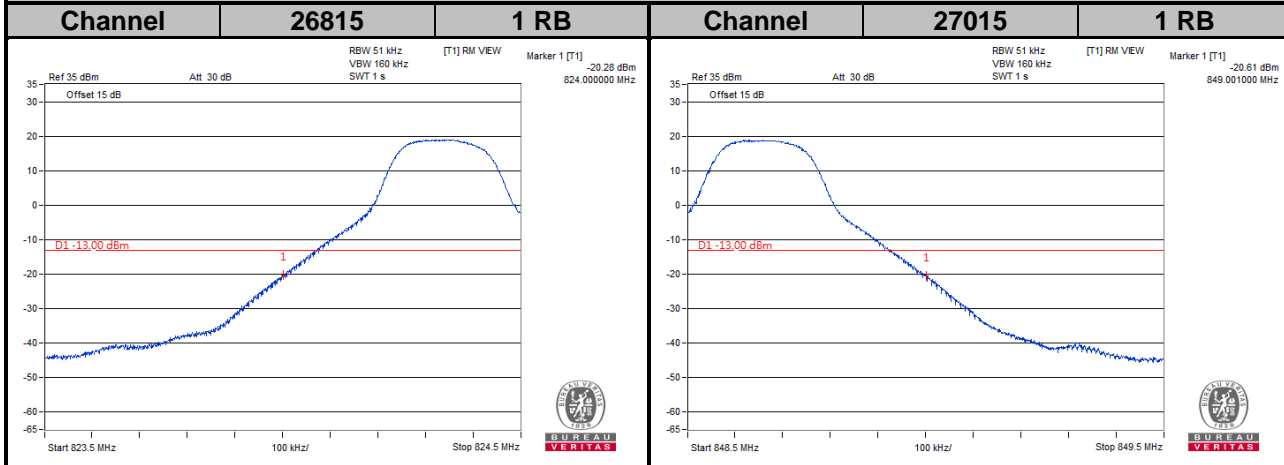

**LTE Band 26**  
**Channel Bandwidth: 10 MHz**

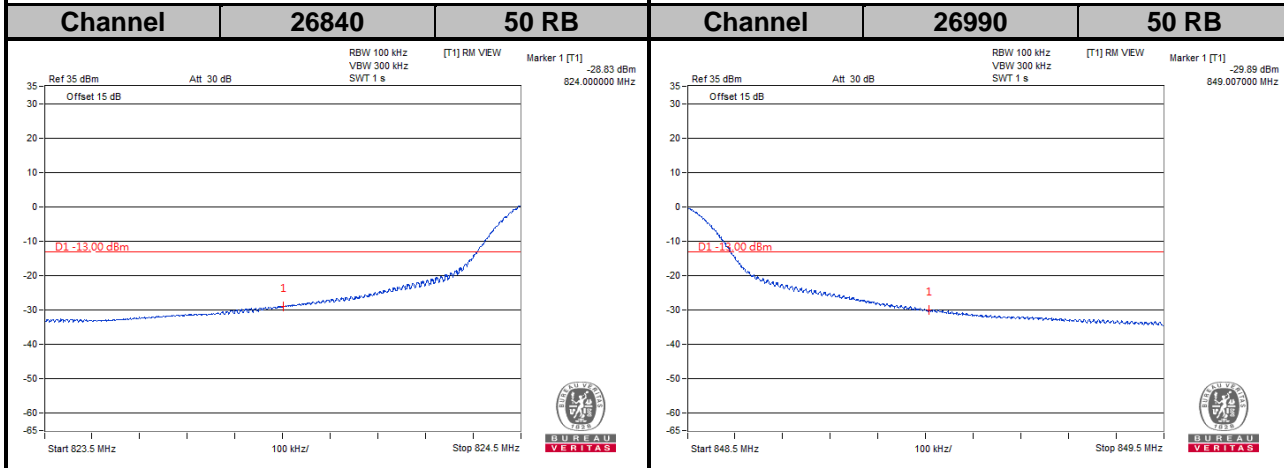
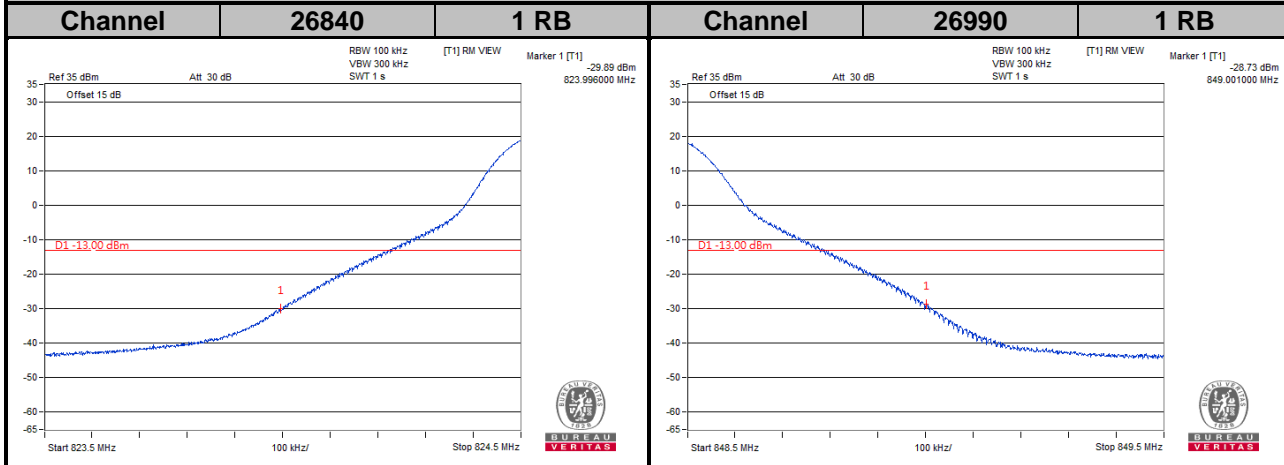

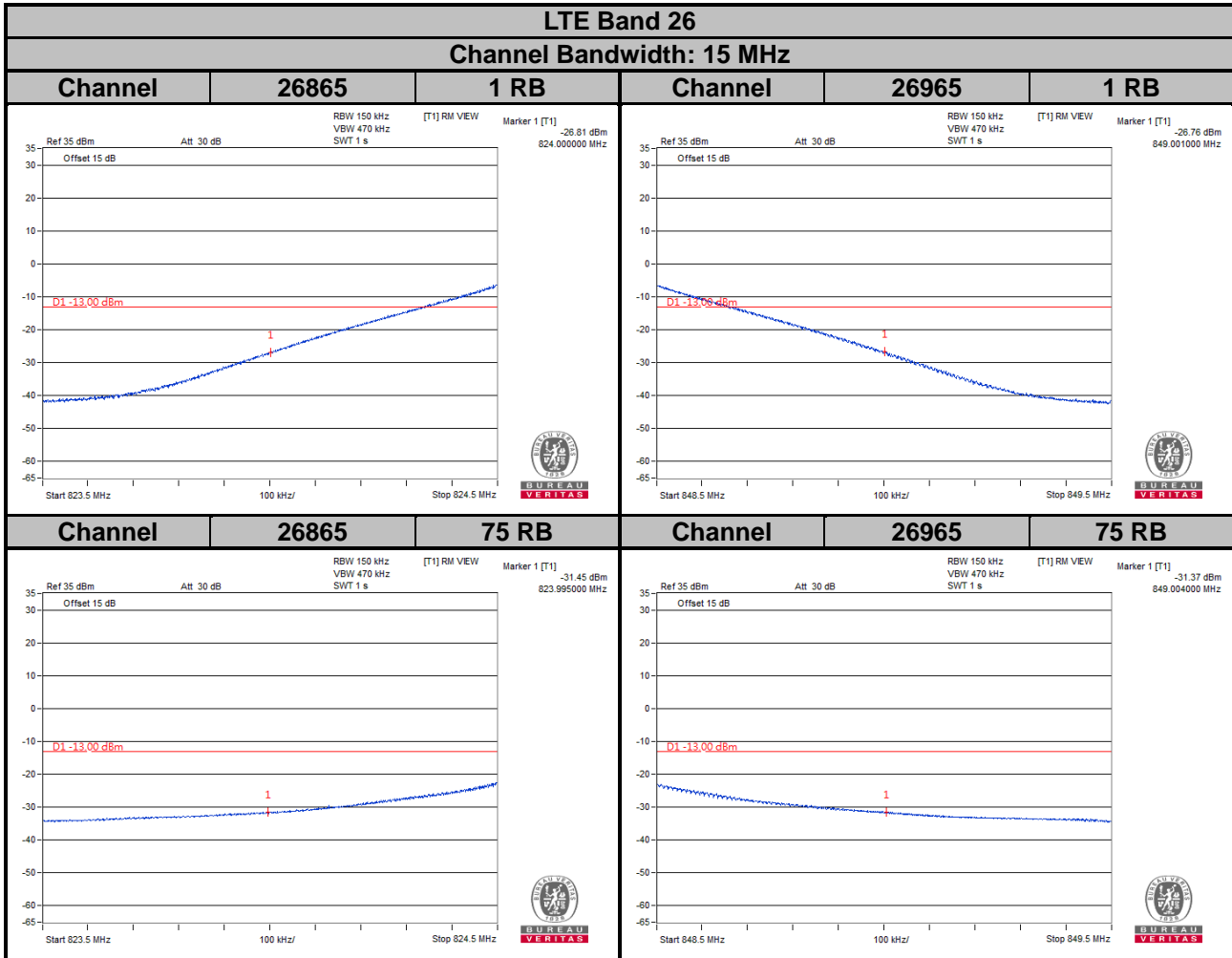

## 4.6 Peak to Average Ratio

### 4.6.1 Limits of Peak to Average Ratio Measurement

In measuring transmissions in this band using an average power technique, the peak to-average ratio (PAR) of the transmission may not exceed 13 dB.

### 4.6.2 Test Setup

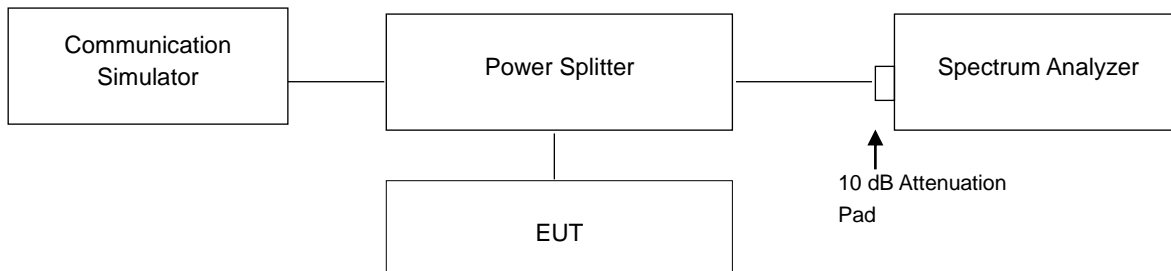

### 4.6.3 Test Procedures

1. Set resolution/measurement bandwidth  $\geq$  signal's occupied bandwidth;
2. Set the number of counts to a value that stabilizes the measured CCDF curve;
3. Record the maximum PAPR level associated with a probability of 0.1 %.

4.6.4 Test Results

Channel	Frequency (MHz)	Peak to Average Ratio (dB)		Channel	Frequency (MHz)	Peak to Average Ratio (dB)
		GPRS	EDGE			WCDMA
128	824.2	0.45	3.34	4132	826.4	3.09
189	836.4	0.48	3.30	4182	836.4	3.05
251	848.8	0.48	3.33	4233	846.6	3.01



LTE Band 5							
Channel Bandwidth: 1.4 MHz				Channel Bandwidth: 3 MHz			
Channel	Frequency (MHz)	Peak to Average Ratio (dB)		Channel	Frequency (MHz)	Peak to Average Ratio (dB)	
		QPSK	16QAM			QPSK	16QAM
20407	824.7	4.86	5.58	20415	825.5	4.81	5.55
20525	836.5	4.65	5.37	20525	836.5	4.62	5.27
20643	848.3	4.06	4.87	20635	847.5	4.12	4.60

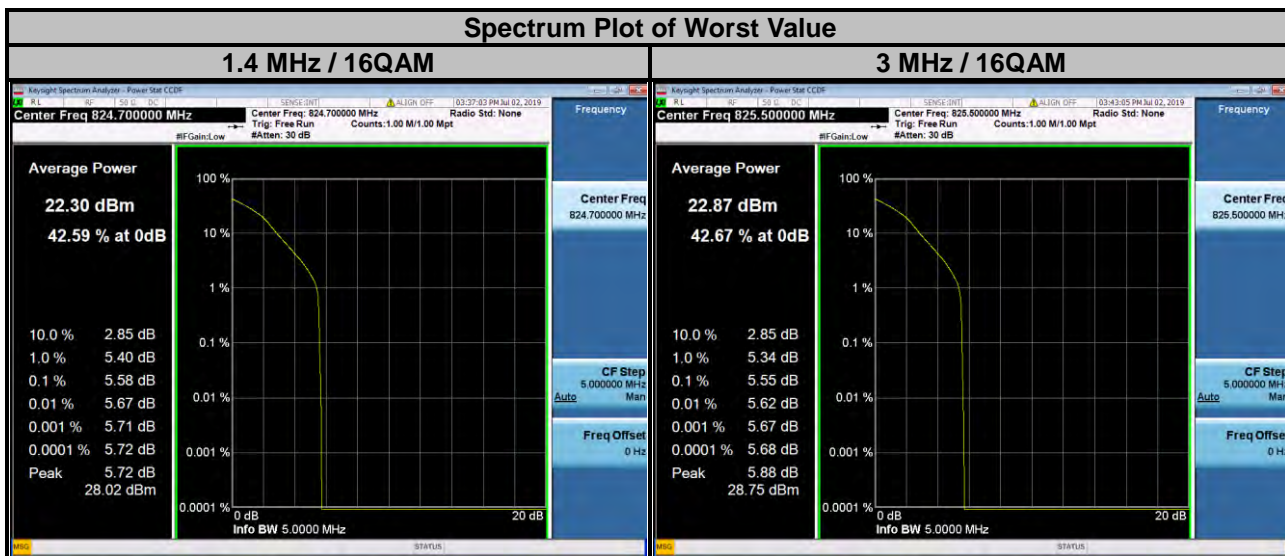

LTE Band 5							
Channel Bandwidth: 5 MHz				Channel Bandwidth: 10 MHz			
Channel	Frequency (MHz)	Peak to Average Ratio (dB)		Channel	Frequency (MHz)	Peak to Average Ratio (dB)	
		QPSK	16QAM			QPSK	16QAM
20425	826.5	4.74	5.43	20450	829.0	4.72	5.42
20525	836.5	4.59	5.33	20525	836.5	4.65	5.42
20625	846.5	4.48	5.23	20600	844.0	4.62	5.35

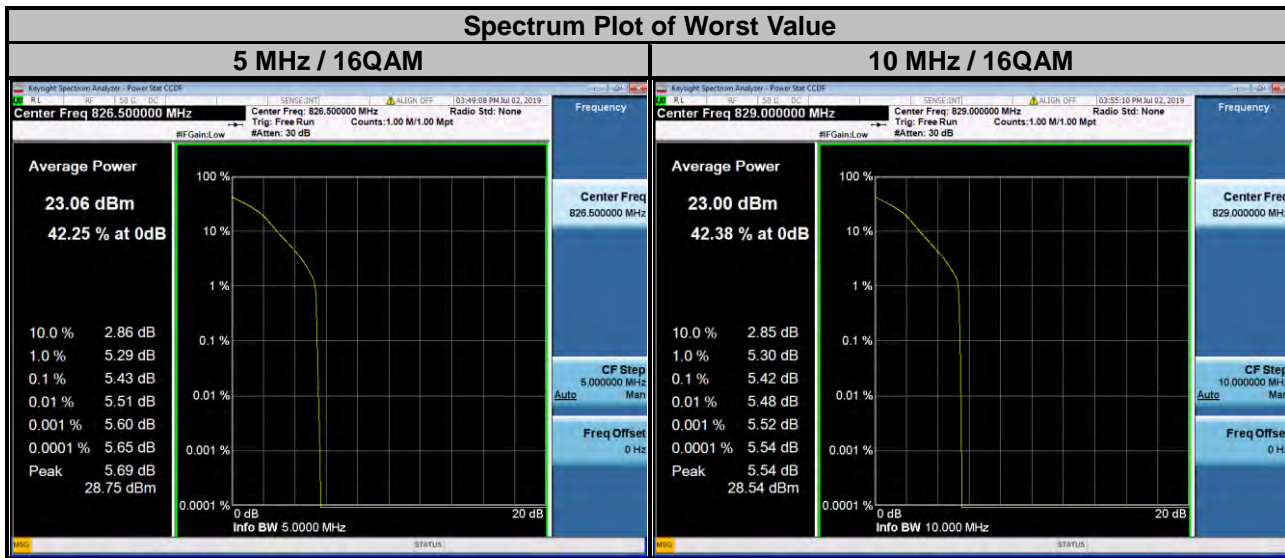



LTE Band 26							
Channel Bandwidth: 1.4 MHz				Channel Bandwidth: 3 MHz			
Channel	Frequency (MHz)	Peak to Average Ratio (dB)		Channel	Frequency (MHz)	Peak to Average Ratio (dB)	
		QPSK	16QAM			QPSK	16QAM
26797	824.7	4.37	5.10	26805	825.5	4.44	5.18
26915	836.5	4.32	5.05	26915	836.5	4.33	5.05
27033	848.3	3.84	4.68	27025	847.5	3.90	4.78

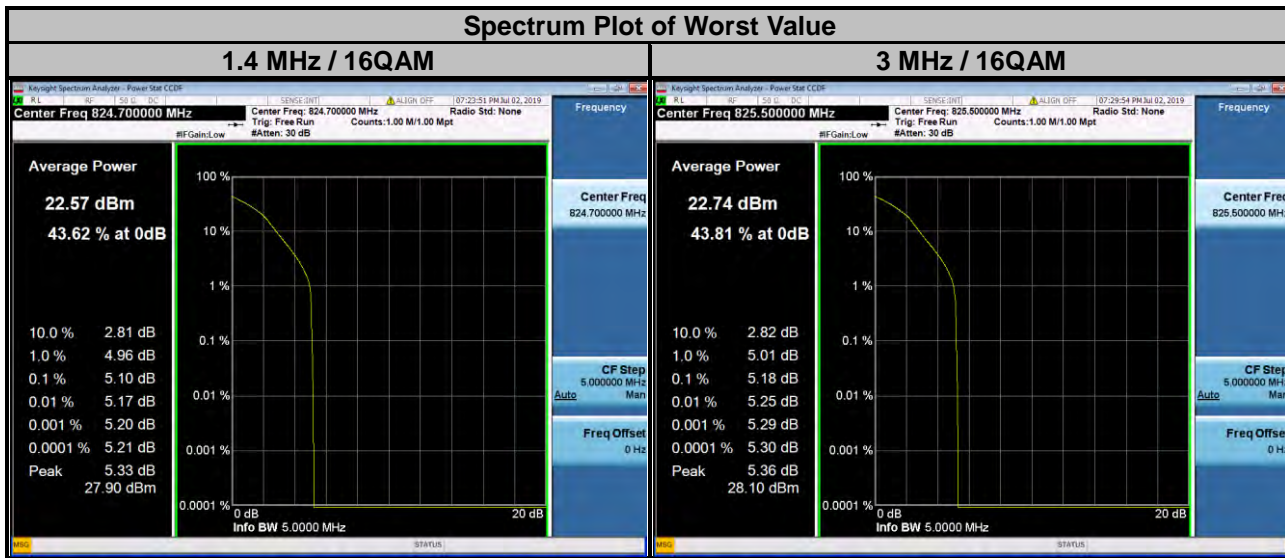

LTE Band 26							
Channel Bandwidth: 5 MHz				Channel Bandwidth: 10 MHz			
Channel	Frequency (MHz)	Peak to Average Ratio (dB)		Channel	Frequency (MHz)	Peak to Average Ratio (dB)	
		QPSK	16QAM			QPSK	16QAM
26815	826.5	4.39	5.06	26840	829.0	4.33	5.07
26915	836.5	4.32	5.09	26915	836.5	4.32	5.04
27015	846.5	4.20	4.88	26990	844.0	4.23	4.99

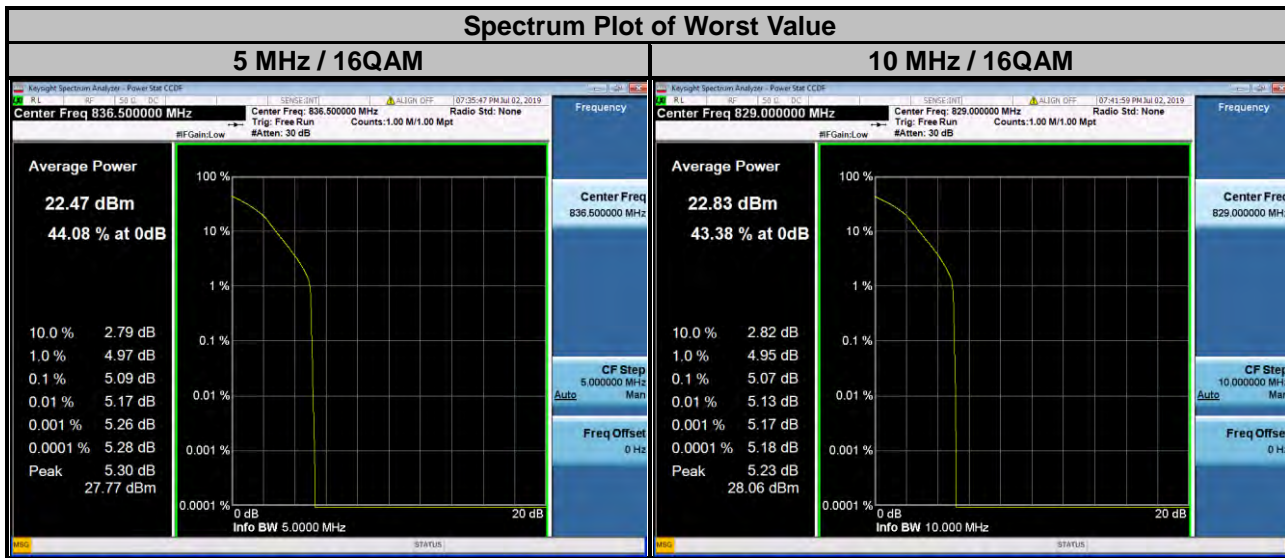

LTE Band 26			
Channel Bandwidth: 15 MHz			
Channel	Frequency (MHz)	Peak to Average Ratio (dB)	
		QPSK	16QAM
26865	831.5	4.31	5.04
26915	836.5	4.31	5.04
26965	841.5	4.19	4.77

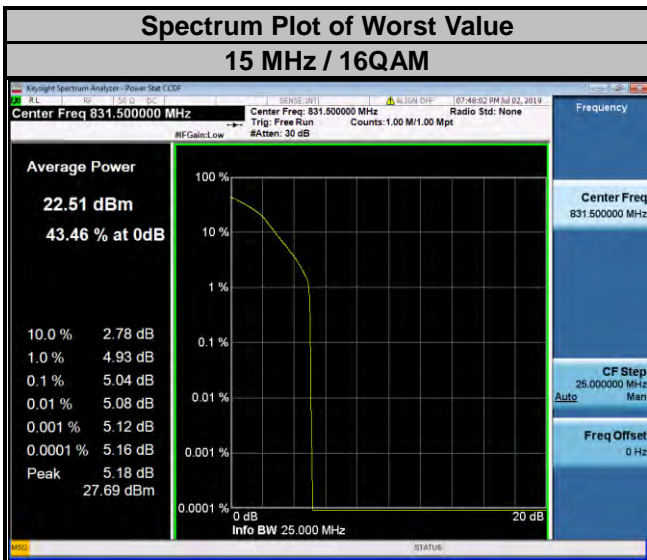

## 4.7 Conducted Spurious Emissions

### 4.7.1 Limits of Conducted Spurious Emissions Measurement

The power of any emission outside of the authorized operating frequency ranges must be attenuated below the transmitting power (P) by a factor of at least  $43 + 10 \log(P)$  dB. The emission limit equal to -13 dBm.

### 4.7.2 Test Setup

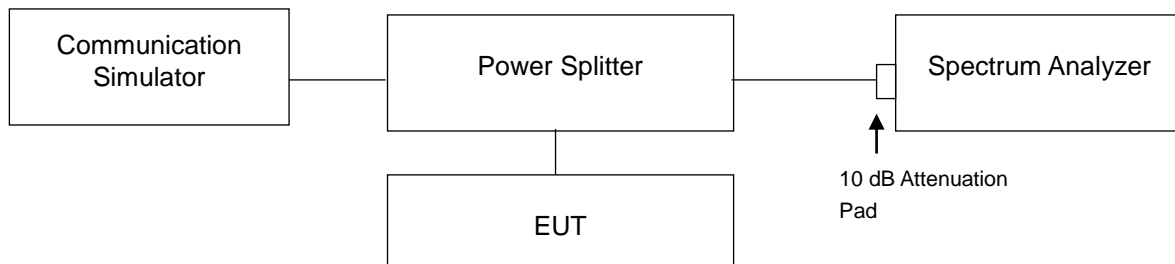

### 4.7.3 Test Procedure

- The EUT makes a phone call to the communication simulator. All measurements were done at low, middle and high operational frequency range.
- Measuring frequency range is from 9 kHz to 1 GHz. 10 dB attenuation pad is connected with spectrum. RBW = 100 kHz and VBW = 300 kHz is used for conducted emission measurement.
- Measuring frequency range is from 1 GHz to 9 GHz. 10 dB attenuation pad is connected with spectrum. RBW = 1 MHz and VBW = 3 MHz is used for conducted emission measurement.

### 4.7.4 Test Results



Note: The signal over the limit in 9 kHz is from spectrum analyzer.



Note: The signal over the limit in 9 kHz is from spectrum analyzer.

### WCDMA Channel 4132

Frequency Range: 9 kHz ~ 1 GHz

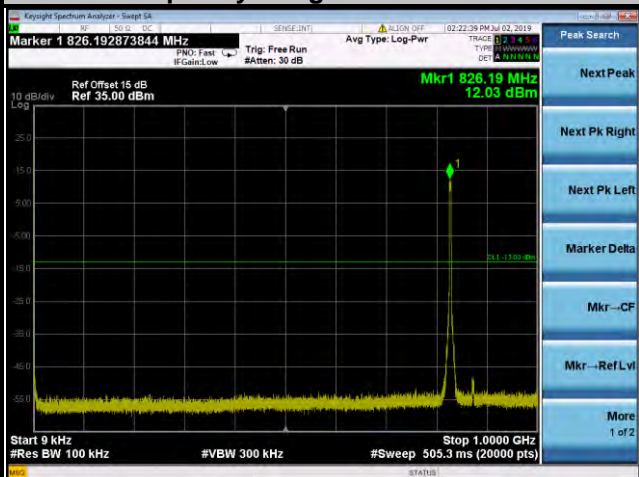

Frequency Range: 1 GHz ~ 9 GHz

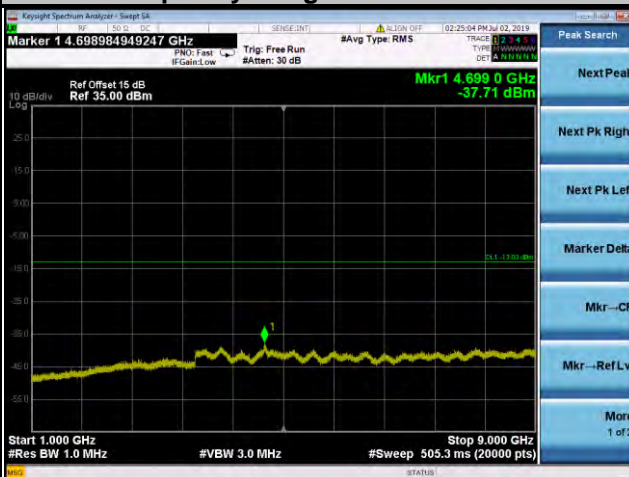

### Channel 4182

Frequency Range: 9 kHz ~ 1 GHz

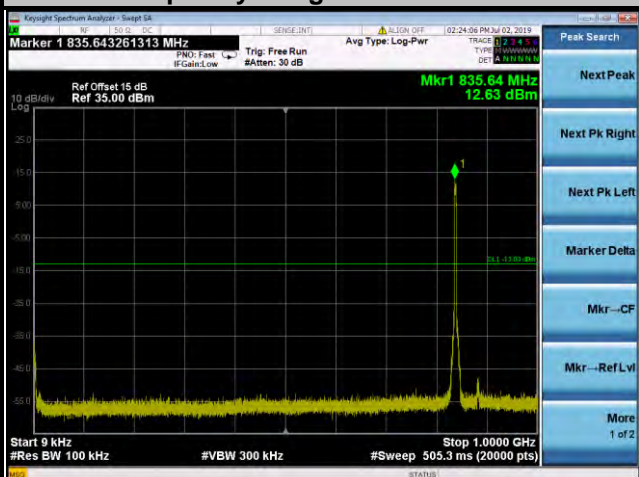

Frequency Range: 1 GHz ~ 9 GHz

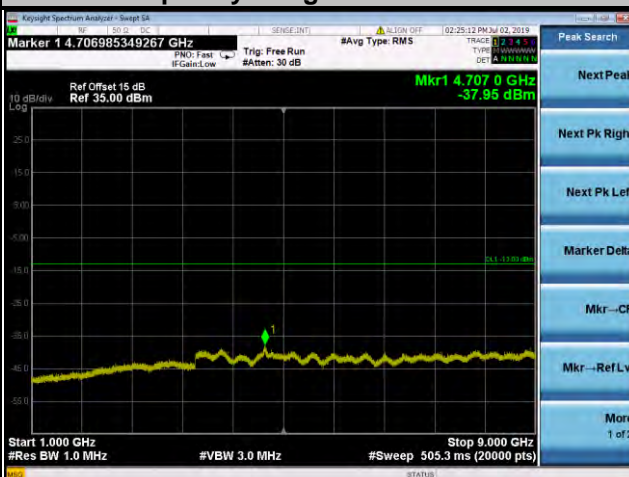

### Channel 4233

Frequency Range: 9 kHz ~ 1 GHz

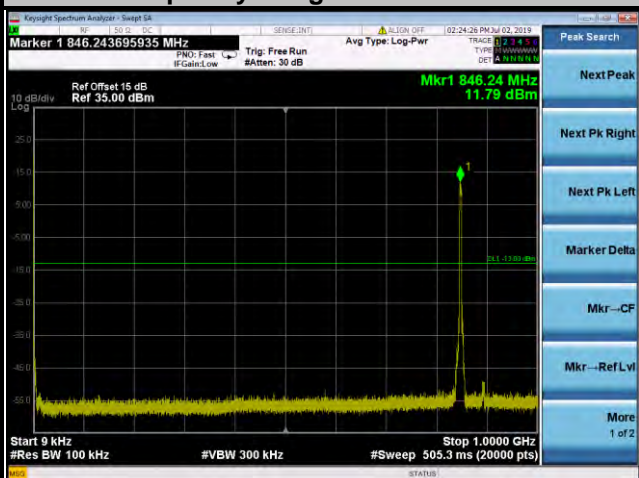

Frequency Range: 1 GHz ~ 9 GHz

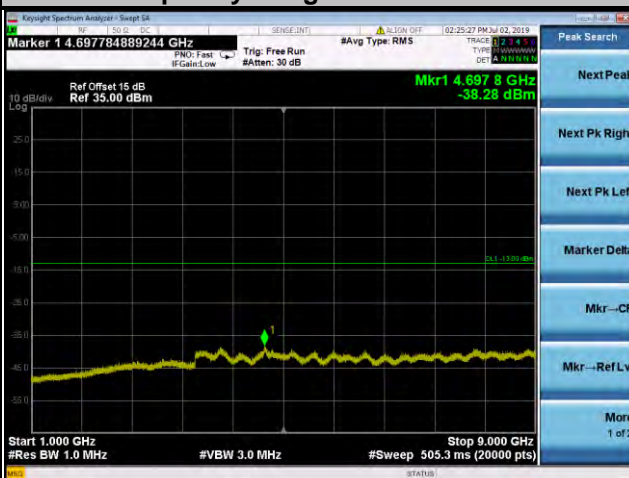

Note: The signal over the limit in 9 kHz is from spectrum analyzer.

**LTE Band 5**  
**Channel Bandwidth: 1.4 MHz**  
**Channel 20407**

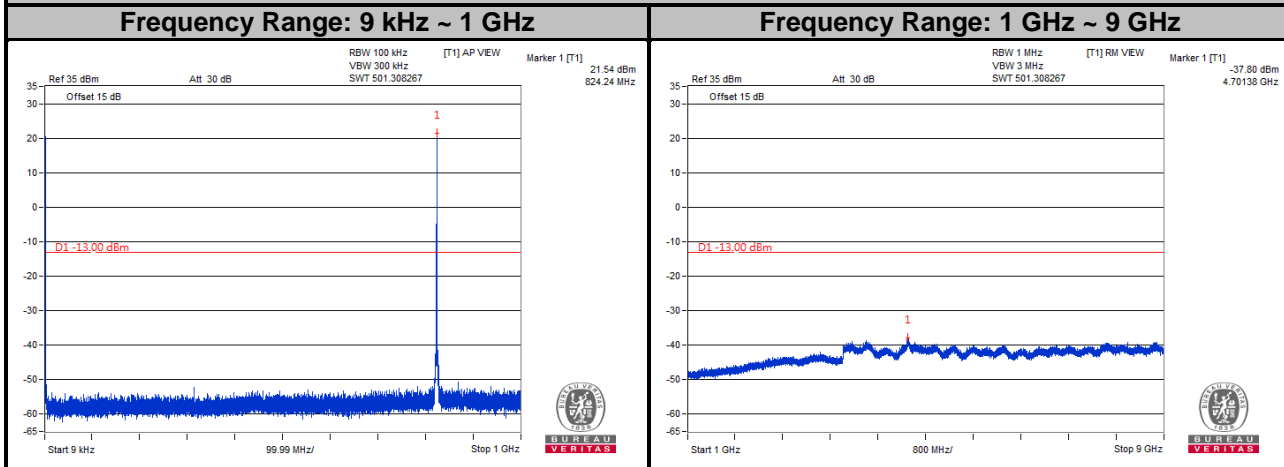

**Channel 20525**

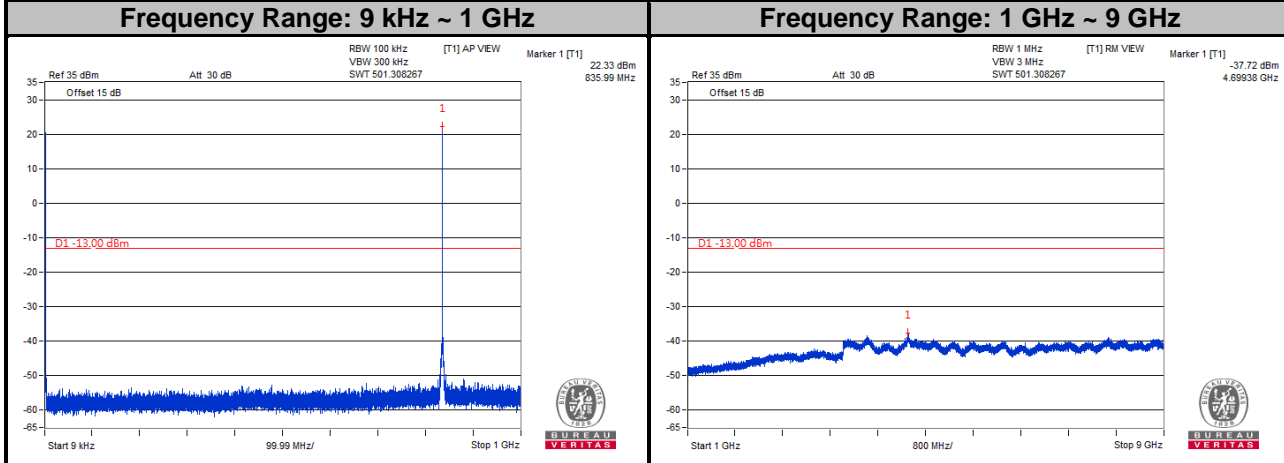

**Channel 20643**

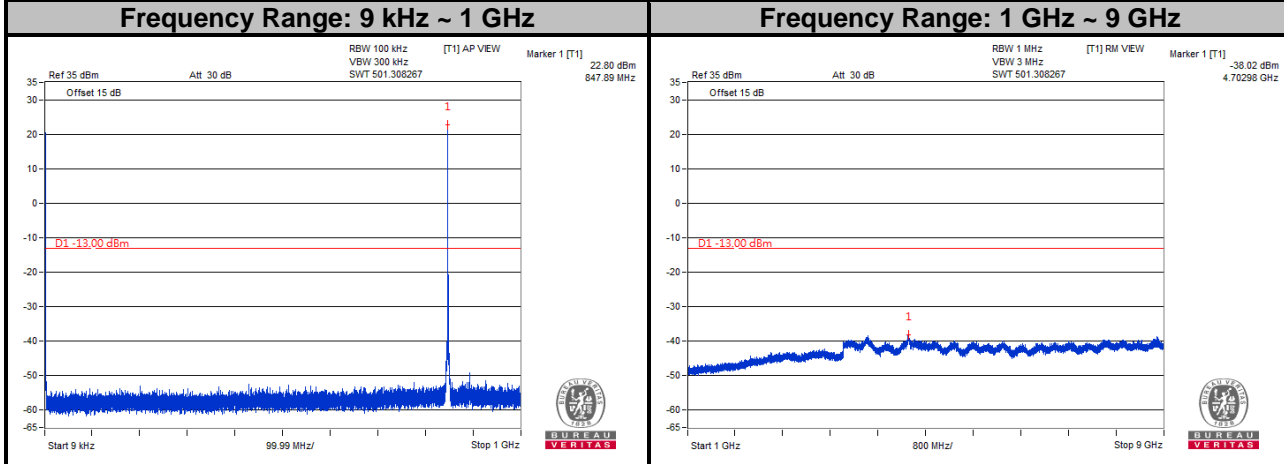

Note: The signal over the limit in 9 kHz is from spectrum analyzer.



**LTE Band 5**  
**Channel Bandwidth: 3 MHz**  
**Channel 20415**

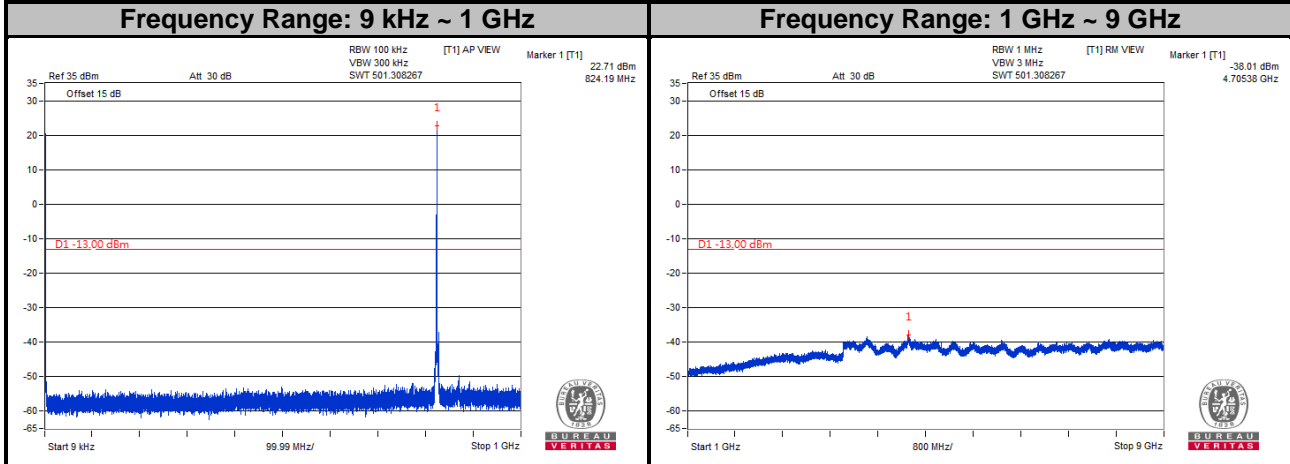

**Channel 20525**

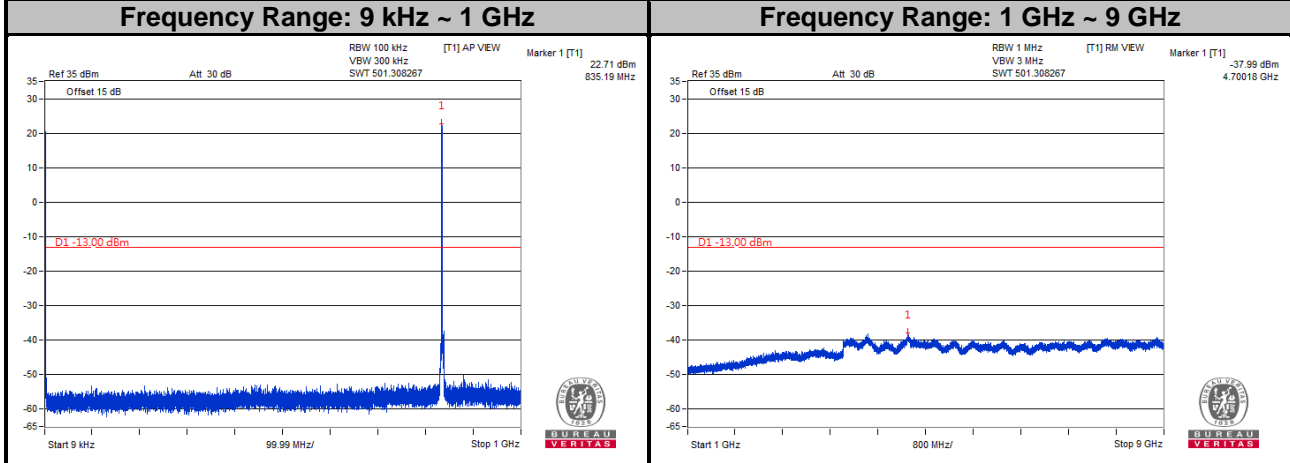

**Channel 20635**

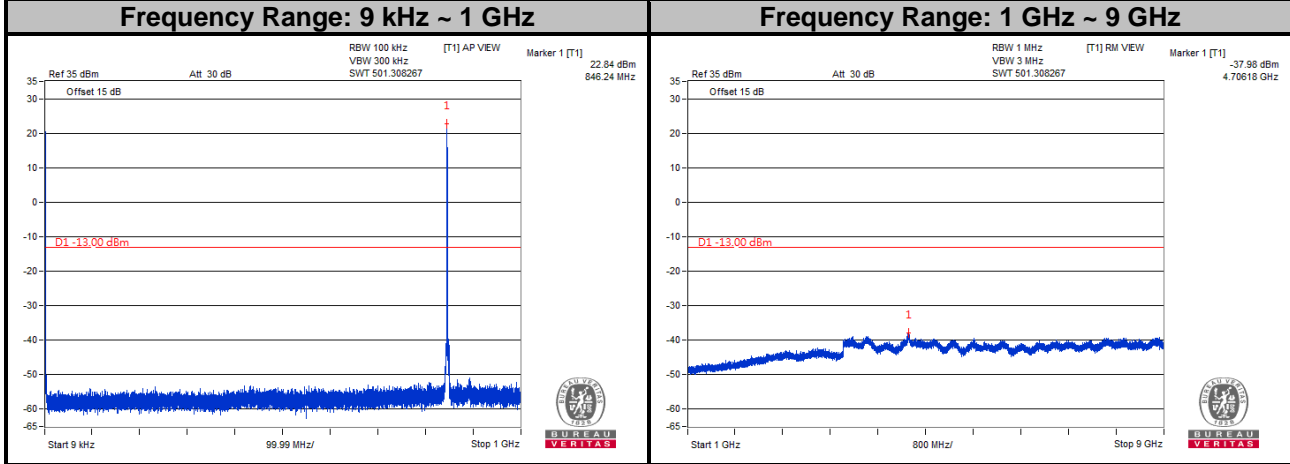

Note: The signal over the limit in 9 kHz is from spectrum analyzer.

**LTE Band 5**  
**Channel Bandwidth: 5 MHz**  
**Channel 20425**

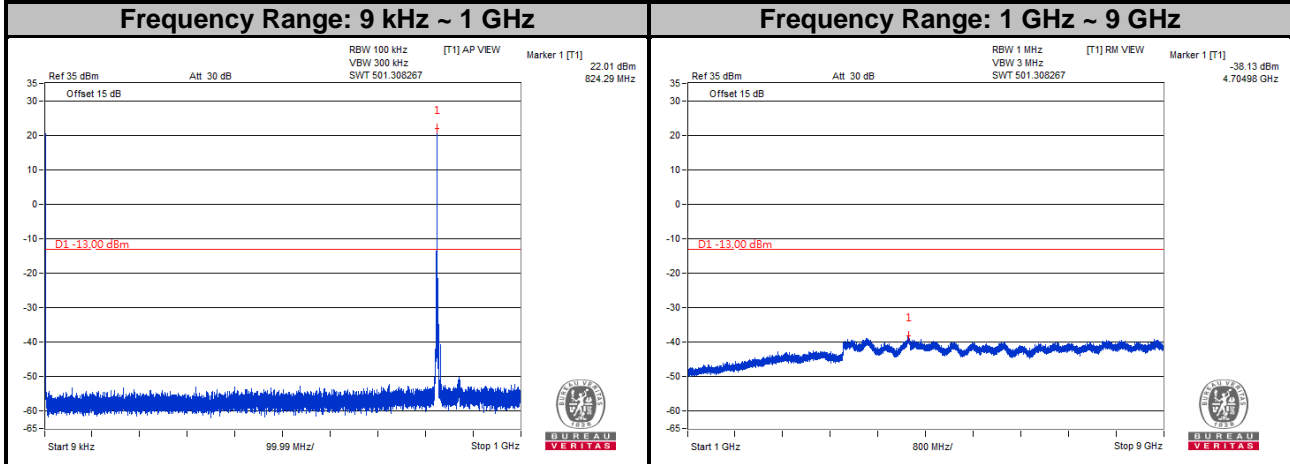

**Channel 20525**

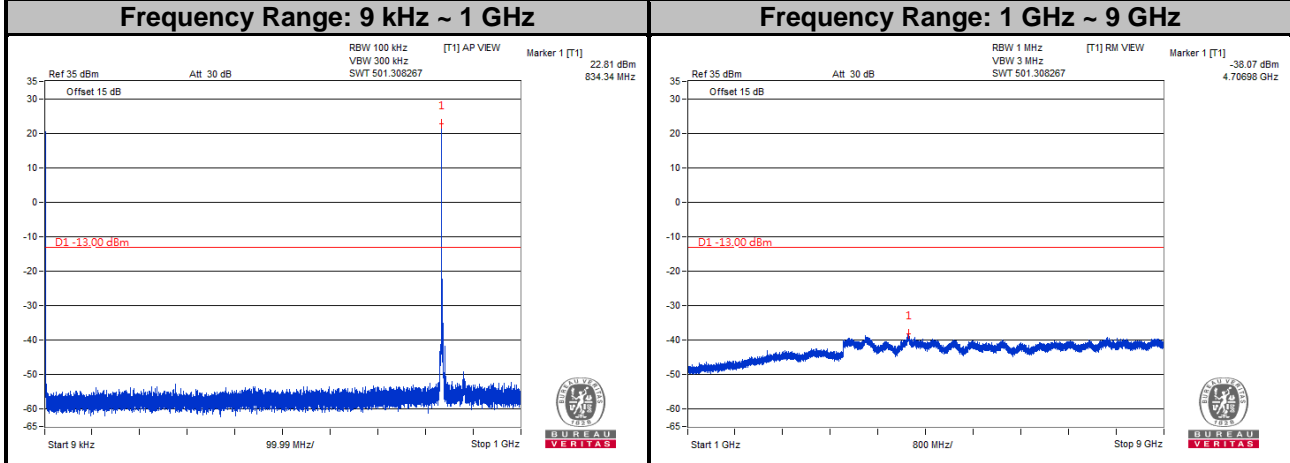

**Channel 20625**

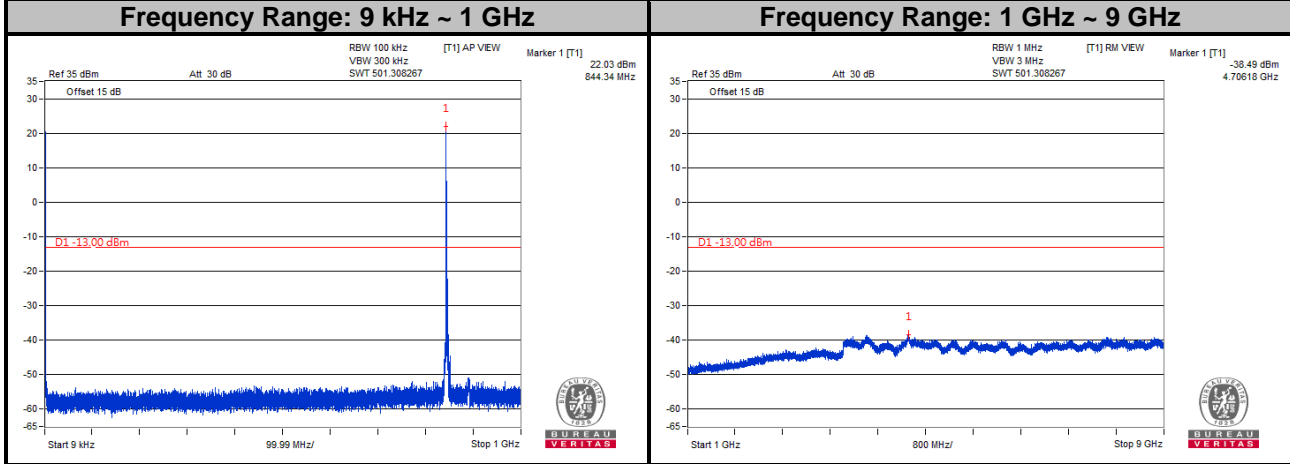

Note: The signal over the limit in 9 kHz is from spectrum analyzer.

**LTE Band 5**  
**Channel Bandwidth: 10 MHz**  
**Channel 20450**

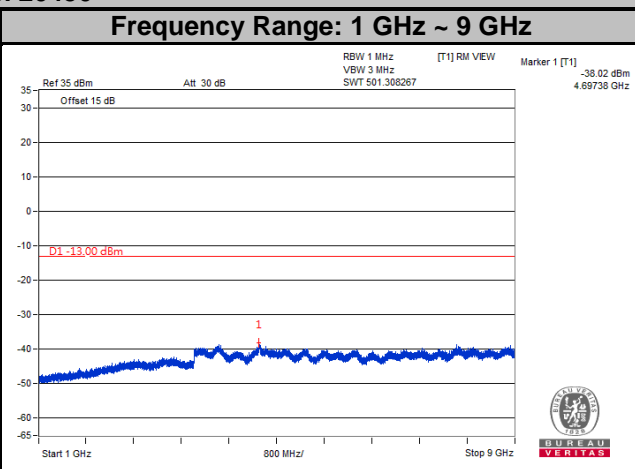
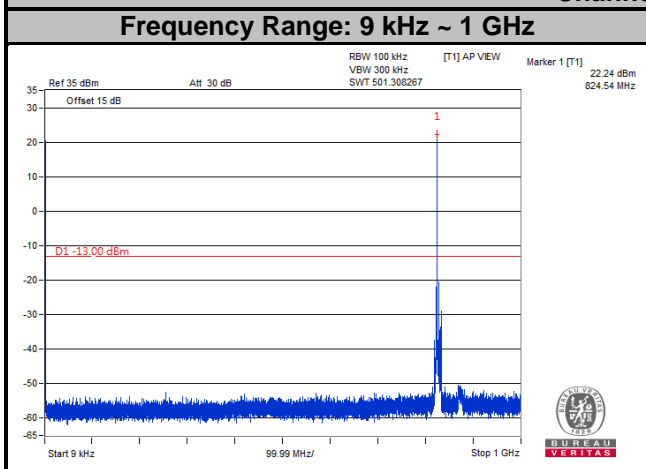

**Channel 20525**

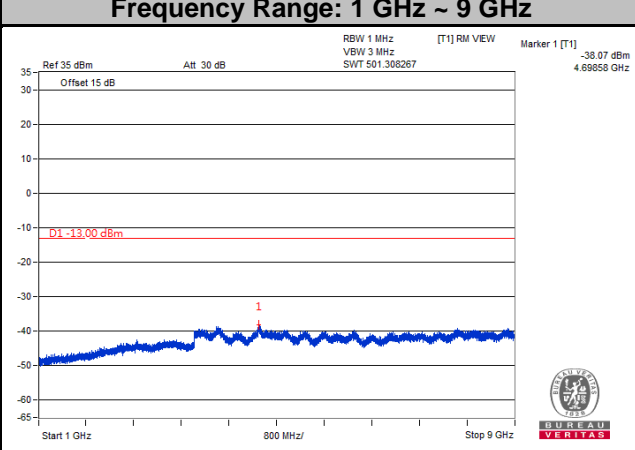
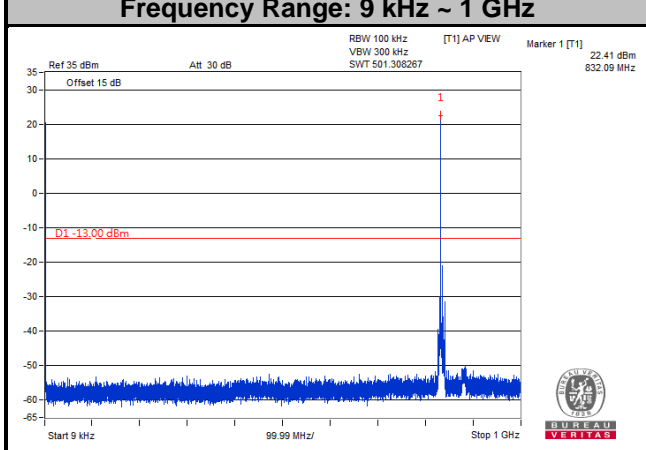

**Channel 20600**

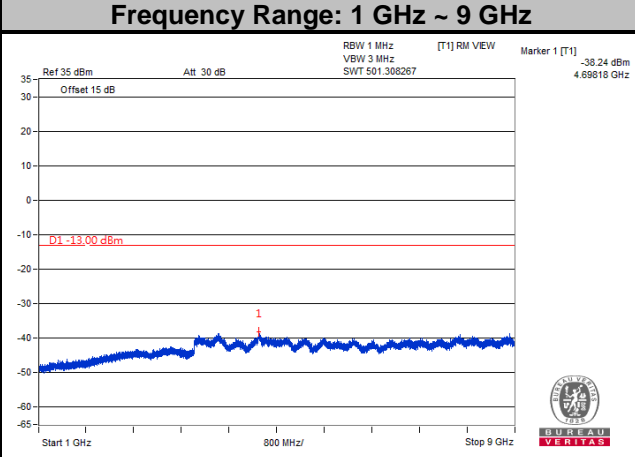
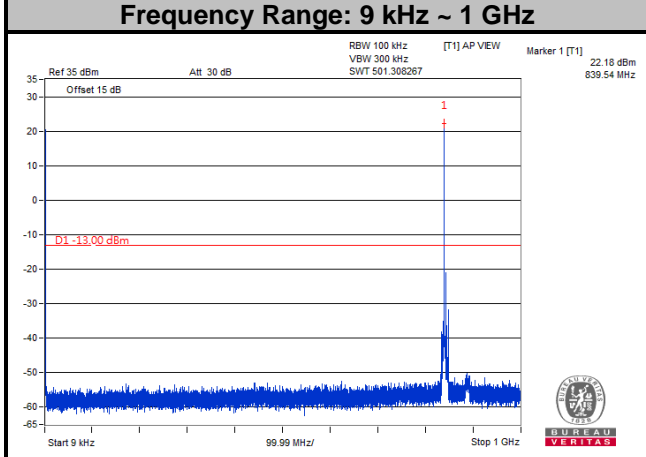

Note: The signal over the limit in 9 kHz is from spectrum analyzer.

**LTE Band 26**  
**Channel Bandwidth: 1.4 MHz**  
**Channel 26797**

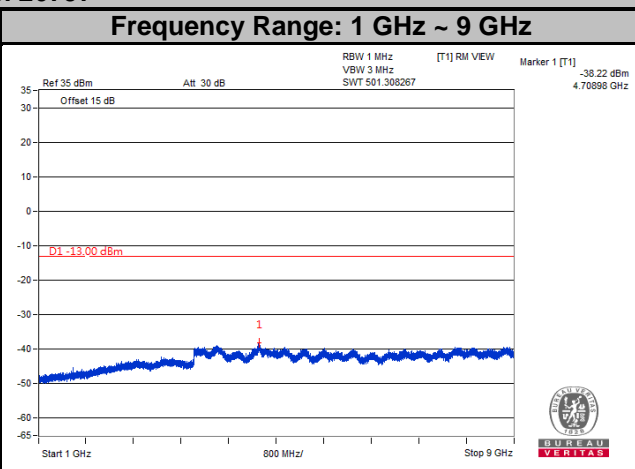
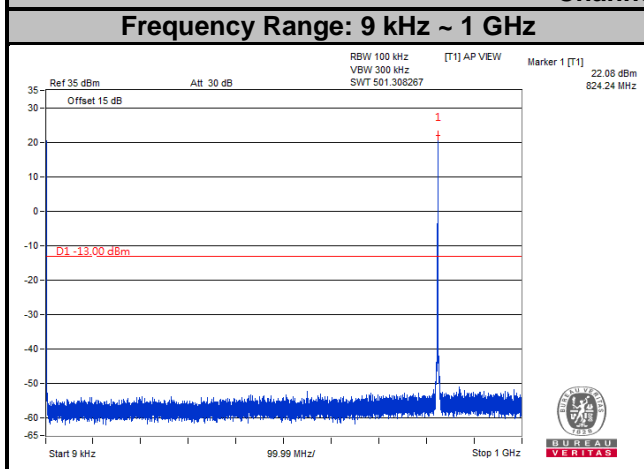

**Channel 26915**

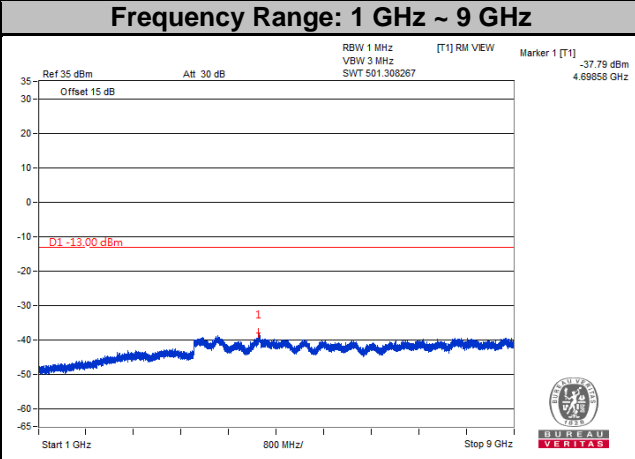
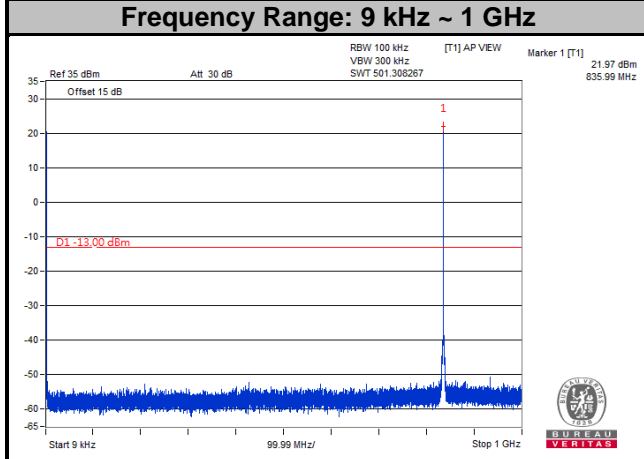

**Channel 27033**

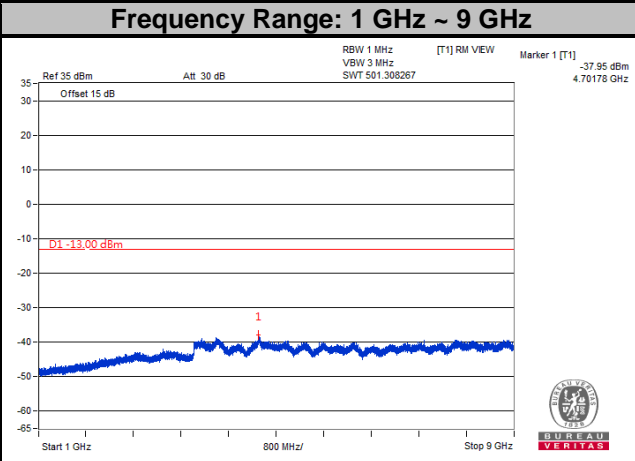
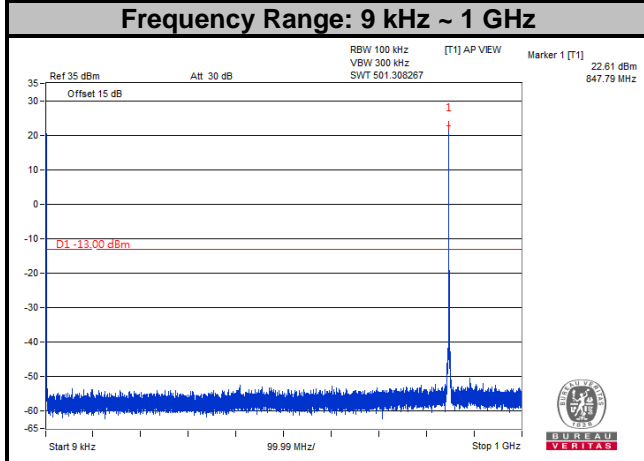

Note: The signal over the limit in 9 kHz is from spectrum analyzer.

**LTE Band 26**  
**Channel Bandwidth: 3 MHz**  
**Channel 26805**

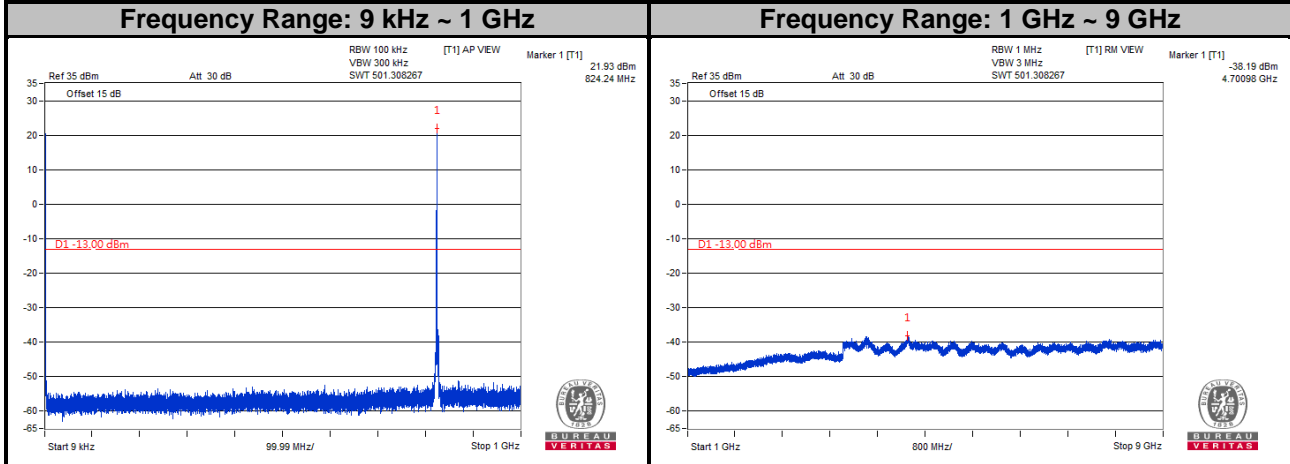

**Channel 26915**

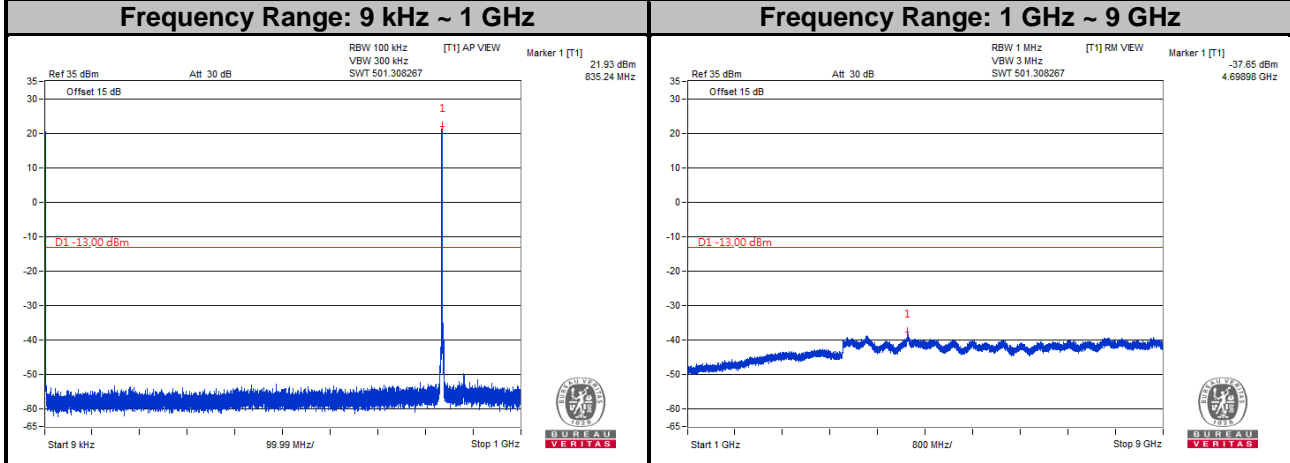

**Channel 27025**

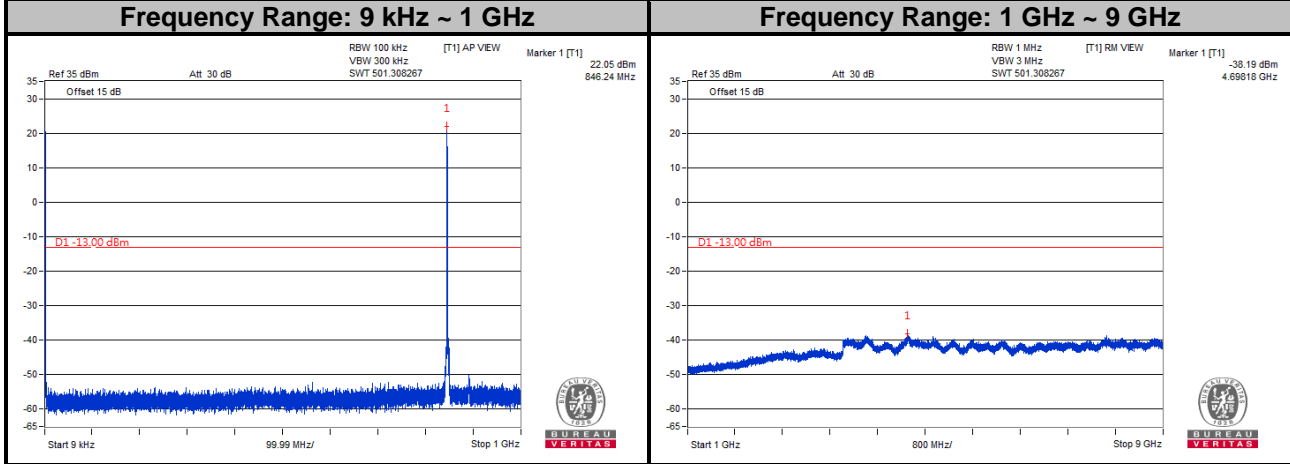

Note: The signal over the limit in 9 kHz is from spectrum analyzer.

**LTE Band 26**  
**Channel Bandwidth: 5 MHz**  
**Channel 26815**

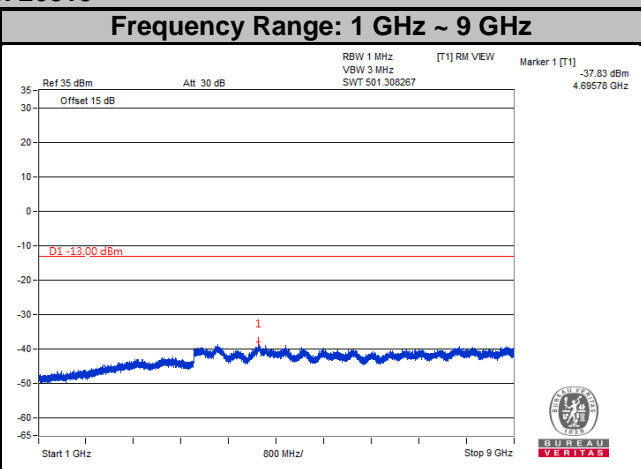
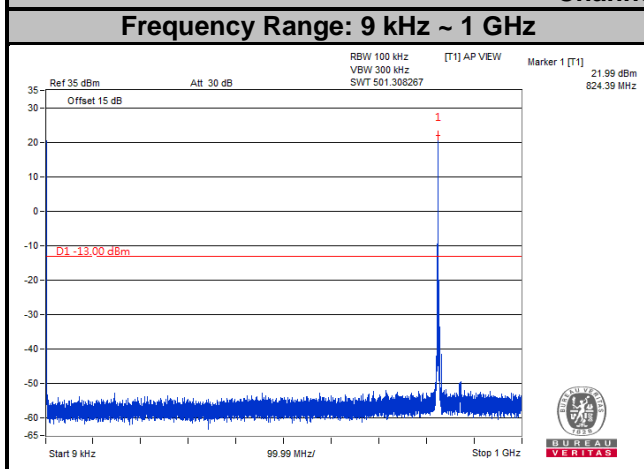

**Channel 26915**

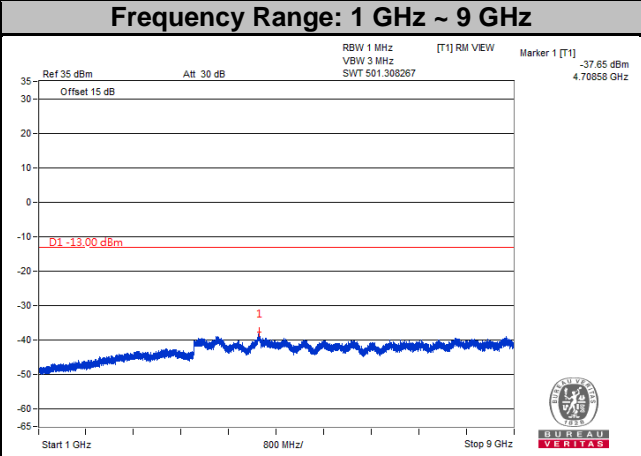
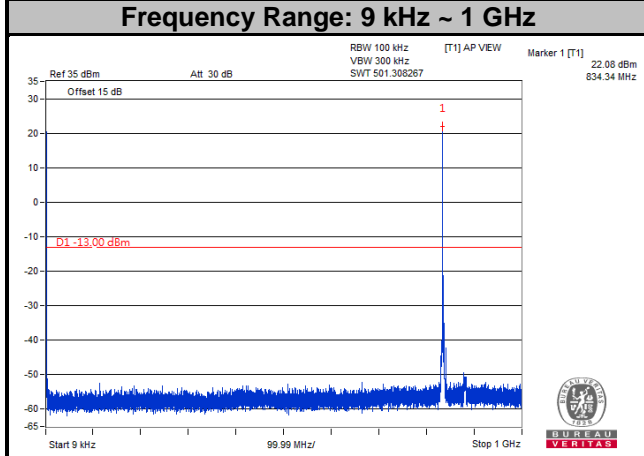

**Channel 27015**

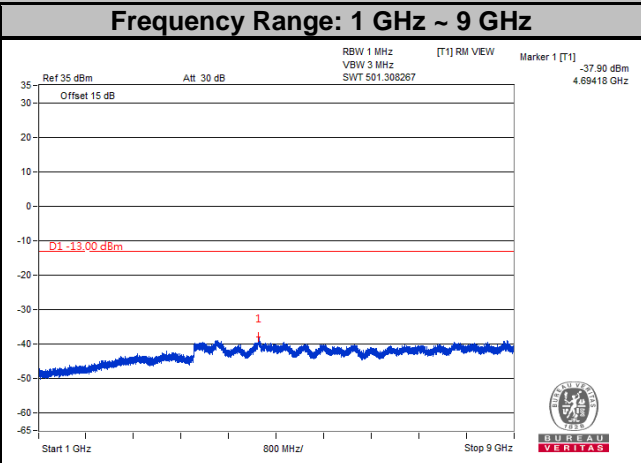
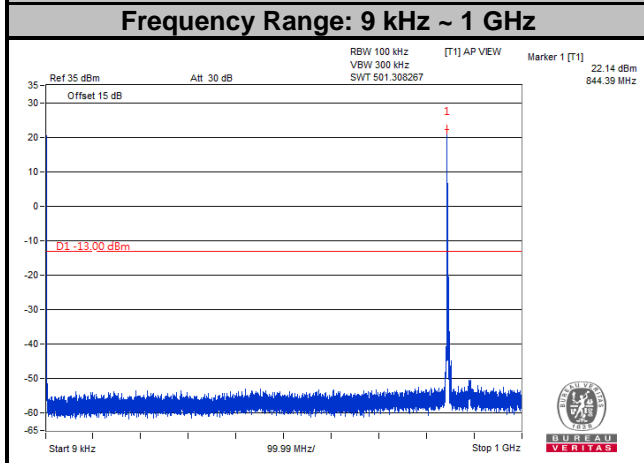

Note: The signal over the limit in 9 kHz is from spectrum analyzer.

**LTE Band 26**  
**Channel Bandwidth: 10 MHz**  
**Channel 26840**

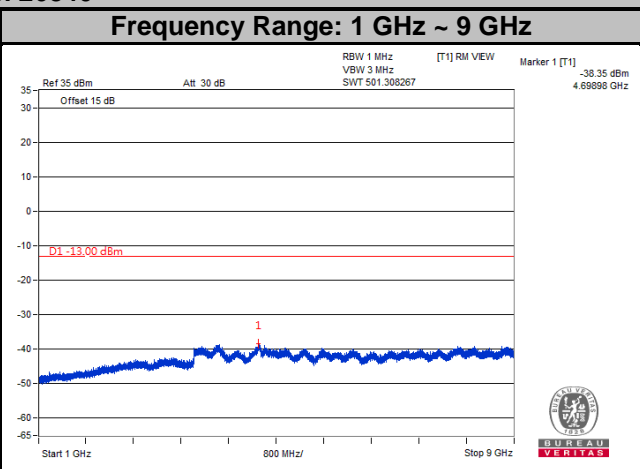
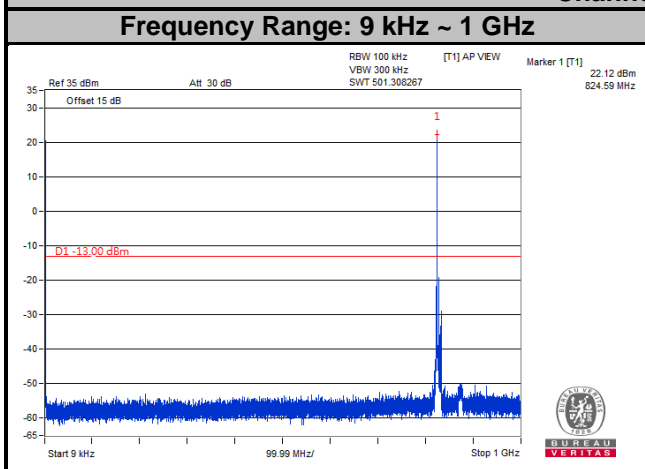

**Channel 26915**

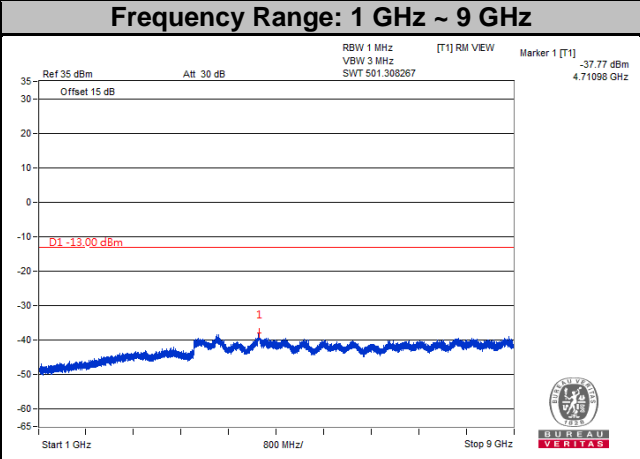
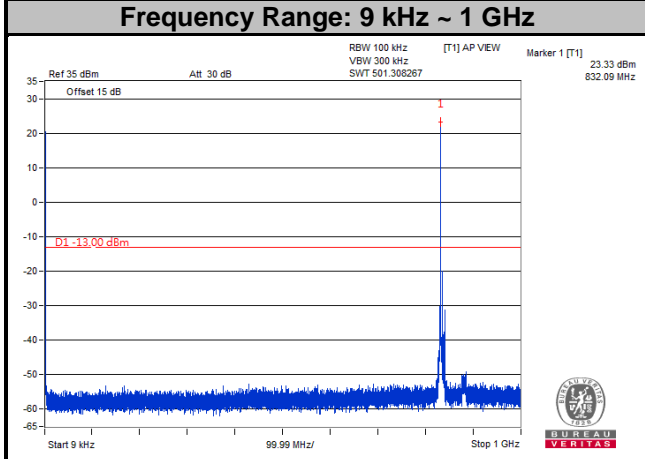

**Channel 26990**

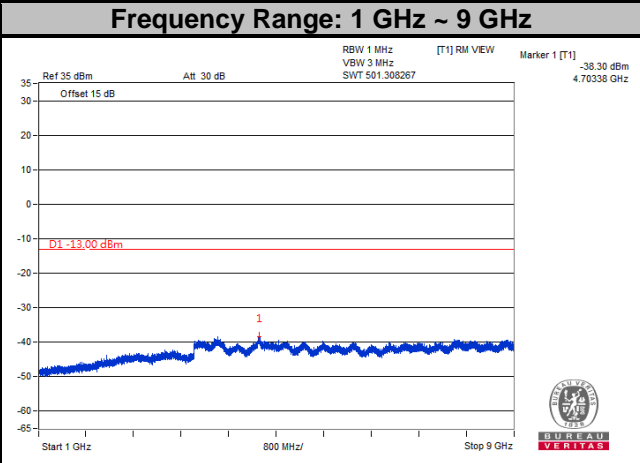
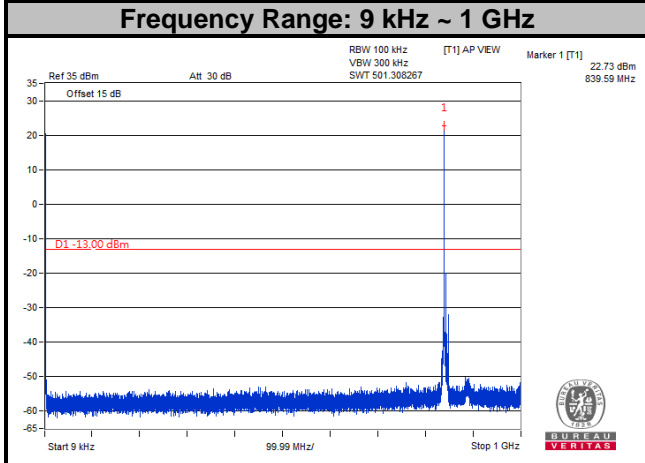

Note: The signal over the limit in 9 kHz is from spectrum analyzer.

**LTE Band 26**  
**Channel Bandwidth: 15 MHz**  
**Channel 26865**

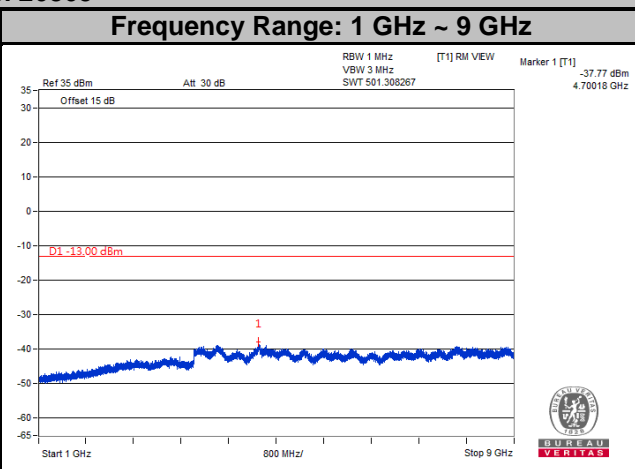
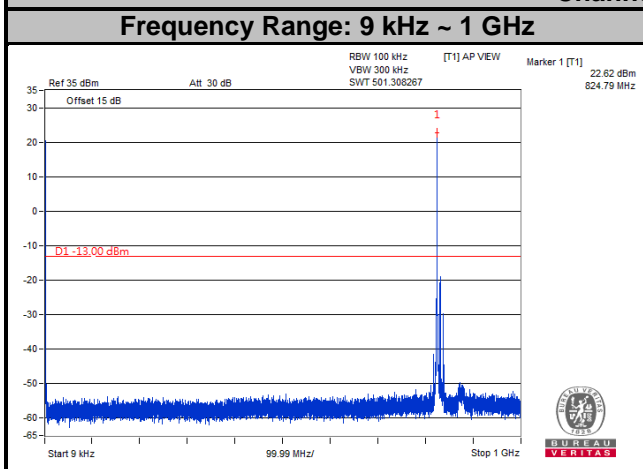

**Channel 26915**

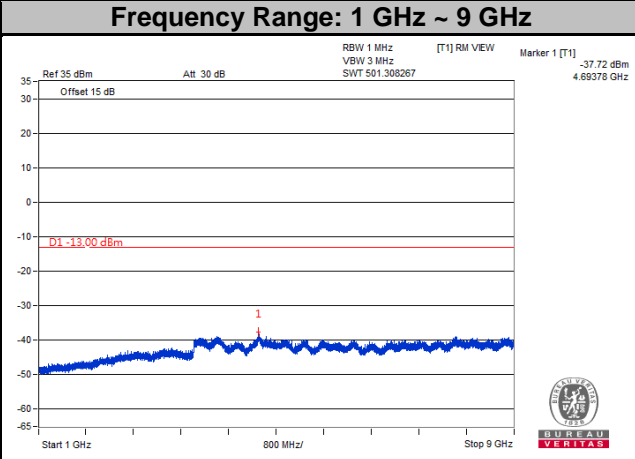
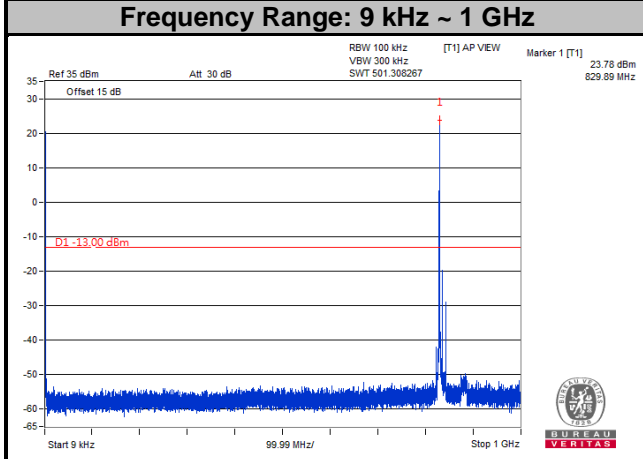

**Channel 26965**

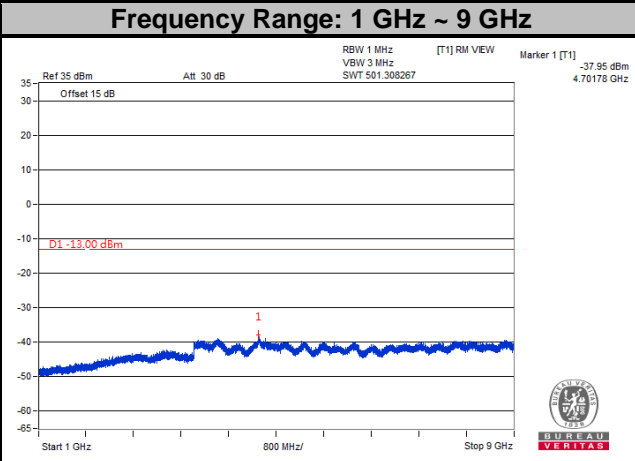
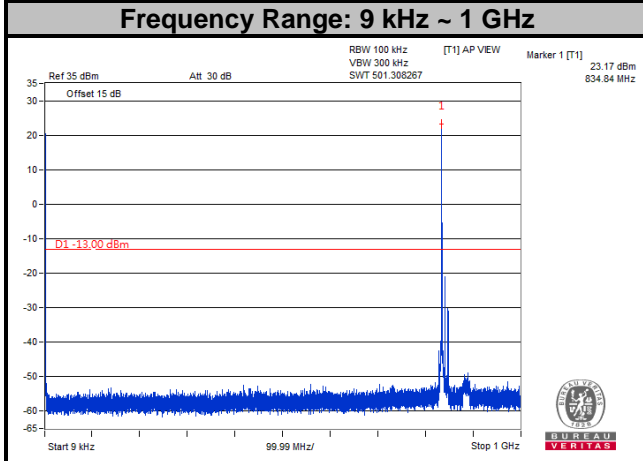

Note: The signal over the limit in 9 kHz is from spectrum analyzer.



## 4.8 Radiated Emission Measurement

### 4.8.1 Limits of Radiated Emission Measurement

The power of any emission outside of the authorized operating frequency ranges must be attenuated below the transmitting power (P) by a factor of at least  $43 + 10 \log(P)$  dB. The emission limit is equal to -13 dBm.

### 4.8.2 Test Procedure

- a. Substitution method is used for E.I.R.P measurement. In the semi-anechoic chamber, EUT placed on the 0.8 m (below or equal 1 GHz) and/or 1.5 m (above 1 GHz) height of Turn Table, rotated the table around 360 degrees to search the maximum radiation power and receiver antenna shall be rotated vertical and horizontal polarization and moved height from 1 m to 4 m to find the maximum polar radiated power. The "Read Value" is the spectrum reading the maximum power value.
- b. The substitution horn antenna is substituted for EUT at the same position and signals generator export the CW signal to the substitution antenna via a TX cable. Rotated the Turn Table and moved receiving antenna to find the maximum radiation power. Adjust output power level of S.G to get a Value of spectrum reading equal to "Read Value" of step a. Record the power level of S.G
- c. EIRP = Output power level of S.G – TX cable loss + Antenna gain of substitution horn.
- d. E.R.P power can be calculated form E.I.R.P power by subtracting the gain of dipole, E.R.P power = E.I.R.P power - 2.15 dB.

**NOTE:** The resolution bandwidth and video bandwidth of test receiver/spectrum analyzer is 1 MHz/3 MHz.

### 4.8.3 Deviation from Test Standard

No deviation.

4.8.4 Test Setup

<Radiated Emission below or equal 1 GHz>

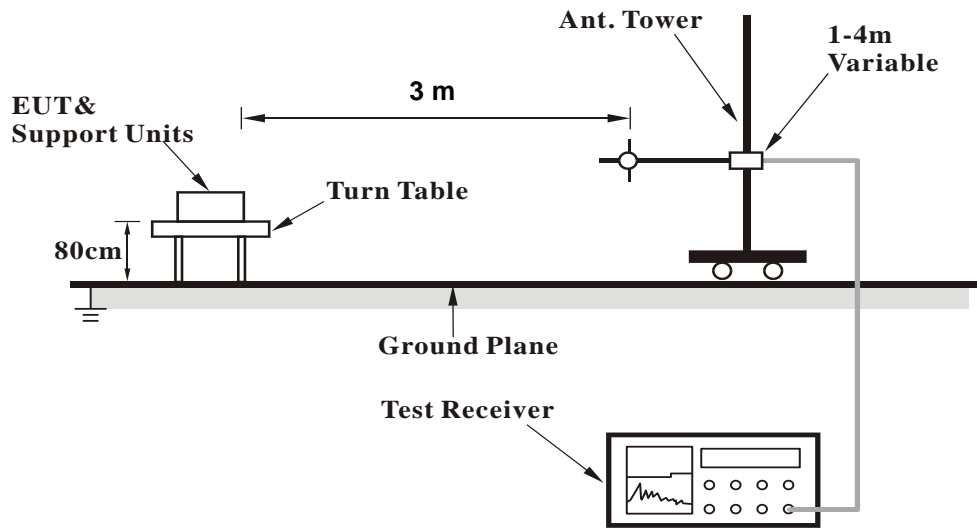

<Radiated Emission above 1 GHz>

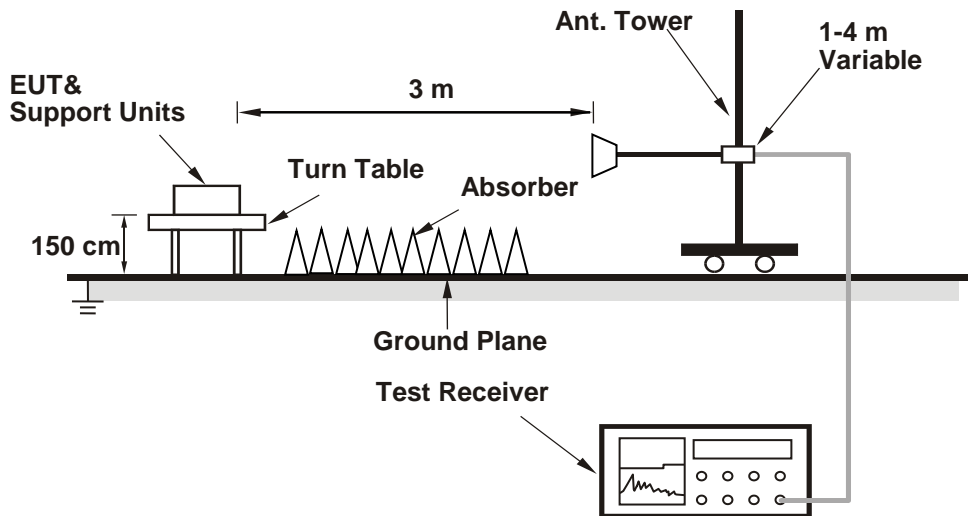

For the actual test configuration, please refer to the attached file (Test Setup Photo).

4.8.5 Test Results

GPRS:  
Low Channel



Bureau Veritas Consumer Products Services Ltd., Taoyuan Branch

A D T

Data: 5

Date: 2019-07-08

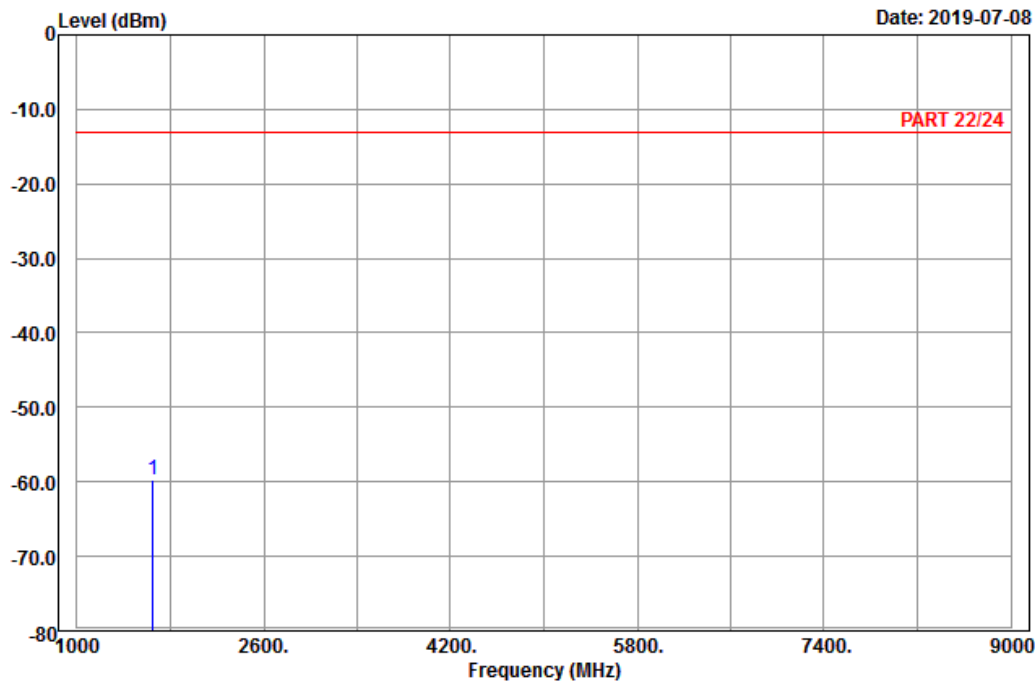

Site : 966 chamber 1  
Condition: PART 22/24 Horizontal  
Remark : GPRS 850\_Link\_CH128  
Tested by: Karl Lee

	Read	Limit	Over	
Freq	Level	Level	Factor	Line
MHz	dBm	dBm	dB	dBm
1 pp 1648.40	-59.78	-67.51	7.73	-13.00
				-46.78
				Peak



Bureau Veritas Consumer Products Services Ltd., Taoyuan Branch

A D T

Data: 6

Date: 2019-07-08

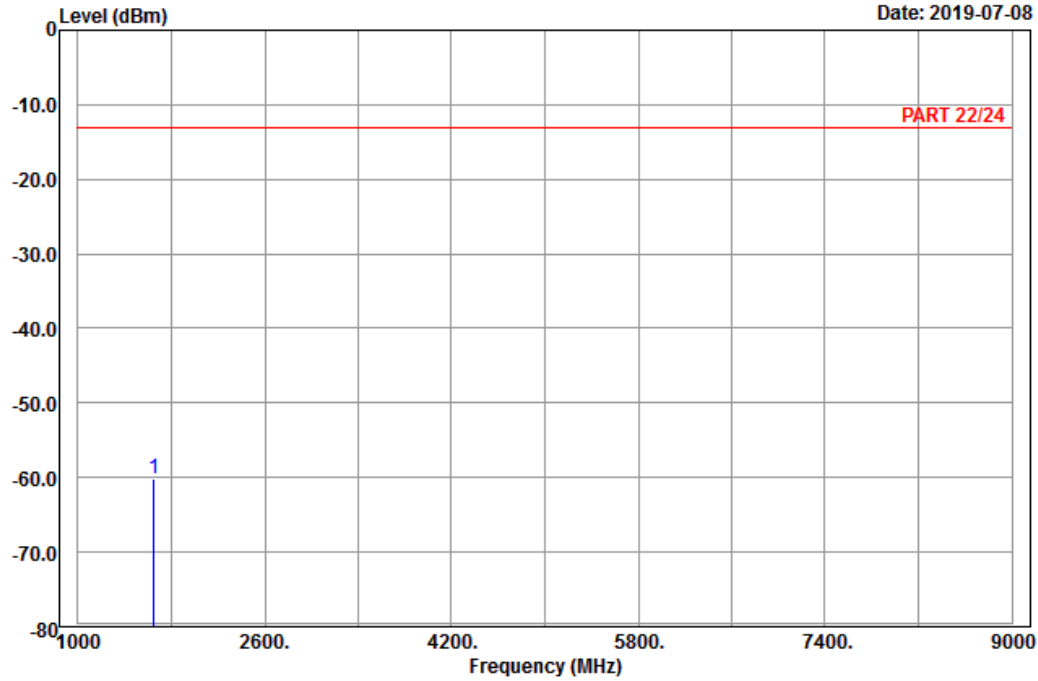

Site : 966 chamber 1  
 Condition: PART 22/24 Vertical  
 Remark : GPRS 850\_Link\_CH128  
 Tested by: Karl Lee

	Freq	Level	Read Level	Factor	Limit Line	Over Limit	Remark
	MHz	dBm	dBm	dB	dBm	dB	
1 pp	1648.40	-60.10	-67.83	7.73	-13.00	-47.10	Peak

Middle Channel



Bureau Veritas Consumer Products Services Ltd., Taoyuan Branch

A D T

Data: 9

Date: 2019-07-08

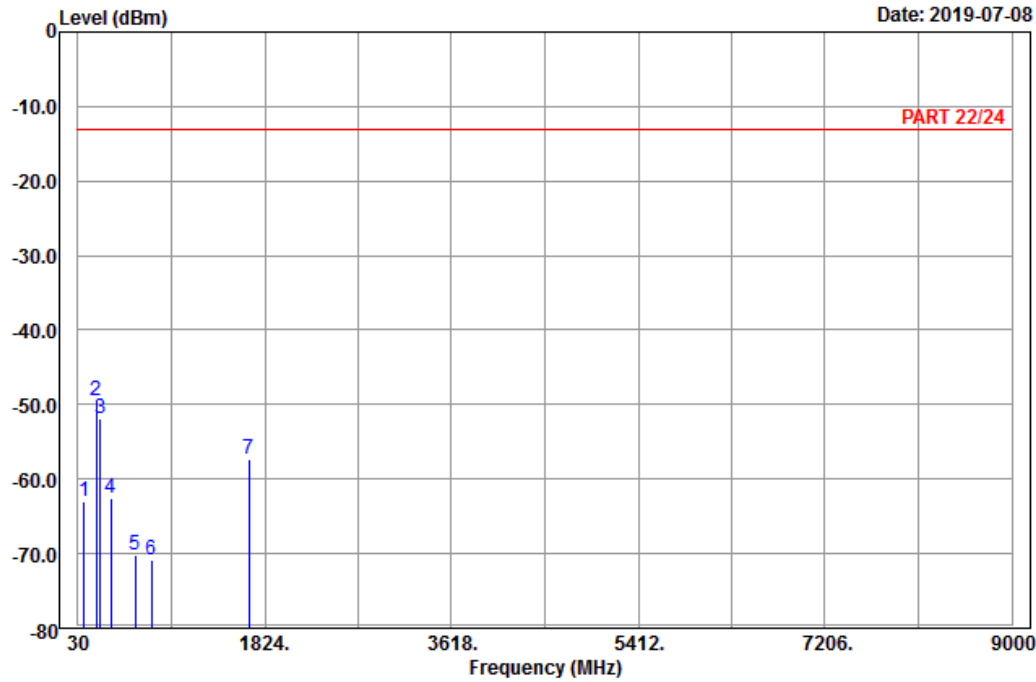

Site : 966 chamber 1  
 Condition: PART 22/24 Horizontal  
 Remark : GPRS 850\_Link\_CH189  
 Tested by: Karl Lee

	Freq	Level	Read Level	Factor	Limit Line	Over Limit	Remark
	MHz	dBm	dBm	dB	dBm	dB	
1	92.10	-62.97	-52.41	-10.56	-13.00	-49.97	Peak
2 pp	207.12	-49.41	-43.33	-6.08	-13.00	-36.41	Peak
3	247.62	-51.90	-46.35	-5.55	-13.00	-38.90	Peak
4	347.60	-62.57	-57.16	-5.41	-13.00	-49.57	Peak
5	576.50	-70.25	-69.67	-0.58	-13.00	-57.25	Peak
6	734.70	-70.86	-69.84	-1.02	-13.00	-57.86	Peak
7	1672.80	-57.23	-65.14	7.91	-13.00	-44.23	Peak



Bureau Veritas Consumer Products Services Ltd., Taoyuan Branch

A D T

Data: 10

Date: 2019-07-08

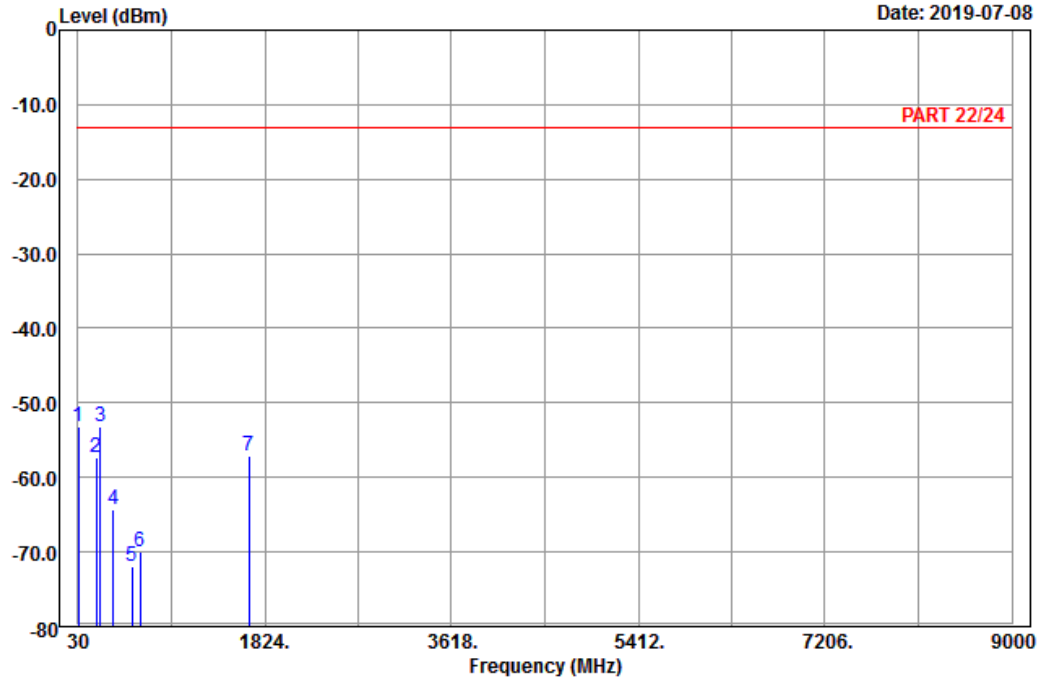

Site : 966 chamber 1  
 Condition: PART 22/24 Vertical  
 Remark : GPRS 850\_Link\_CH189  
 Tested by: Karl Lee

	Freq	Level	Read Level	Factor	Limit Line	Over Limit	Remark
	MHz	dBm	dBm	dB	dBm	dB	
1	32.97	-53.27	-42.40	-10.87	-13.00	-40.27	Peak
2	204.96	-57.34	-51.22	-6.12	-13.00	-44.34	Peak
3	243.30	-53.14	-47.54	-5.60	-13.00	-40.14	Peak
4	367.20	-64.33	-59.88	-4.45	-13.00	-51.33	Peak
5	547.80	-72.00	-70.20	-1.80	-13.00	-59.00	Peak
6	627.60	-70.06	-70.18	0.12	-13.00	-57.06	Peak
7	1672.80	-57.15	-65.06	7.91	-13.00	-44.15	Peak

# High Channel



Bureau Veritas Consumer Products Services Ltd., Taoyuan Branch

A D T

Data: 5

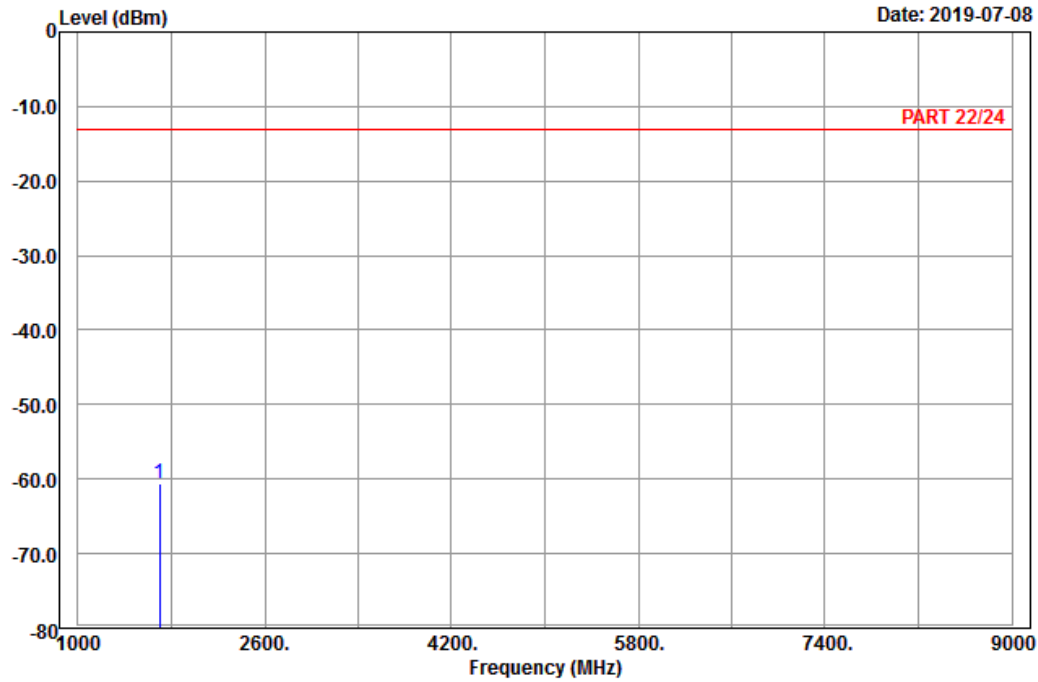

Site : 966 chamber 1  
 Condition: PART 22/24 Horizontal  
 Remark : GPRS 850\_Link\_CH251  
 Tested by: Karl Lee

	Freq	Level	Read Level	Factor	Limit Line	Over Limit	Remark
	MHz	dBm	dBm	dB	dBm	dB	
1	pp 1697.60	-60.62	-68.76	8.14	-13.00	-47.62	Peak



Bureau Veritas Consumer Products Services Ltd., Taoyuan Branch

A D T

Data: 6

Date: 2019-07-08

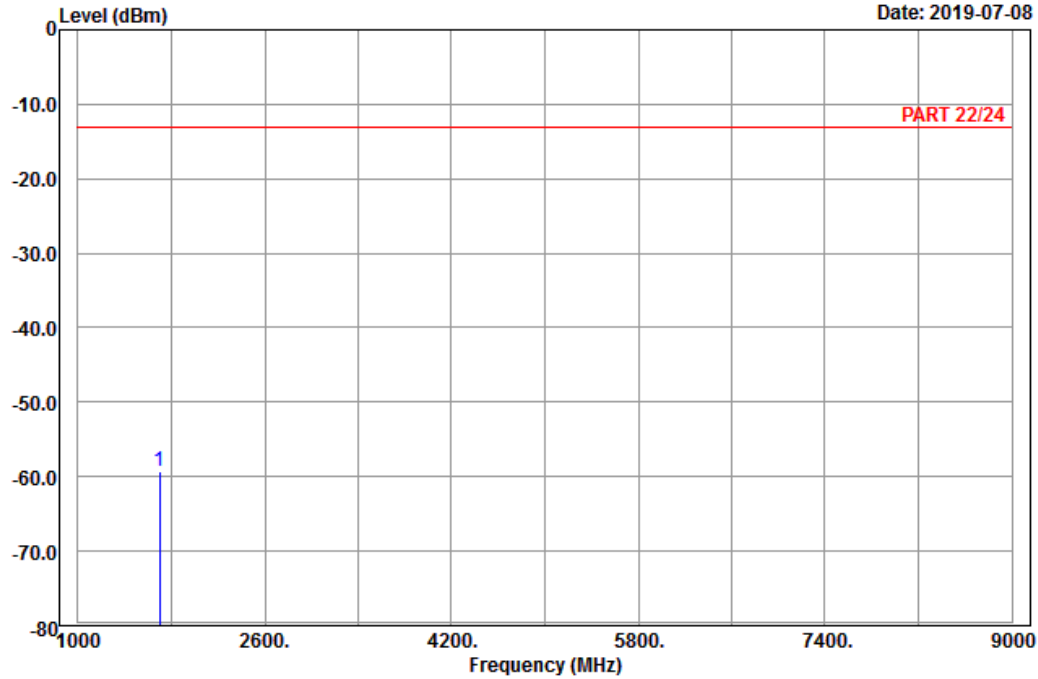

Site : 966 chamber 1  
 Condition: PART 22/24 Vertical  
 Remark : GPRS 850\_Link\_CH251  
 Tested by: Karl Lee

	Freq	Level	Read Level	Factor	Limit Line	Over Limit	Remark
	MHz	dBm	dBm	dB	dBm	dB	
1 pp	1697.60	-59.19	-67.33	8.14	-13.00	-46.19	Peak



EDGE:  
Low Channel



Bureau Veritas Consumer Products Services Ltd., Taoyuan Branch

A D T

Data: 3

Date: 2019-07-13

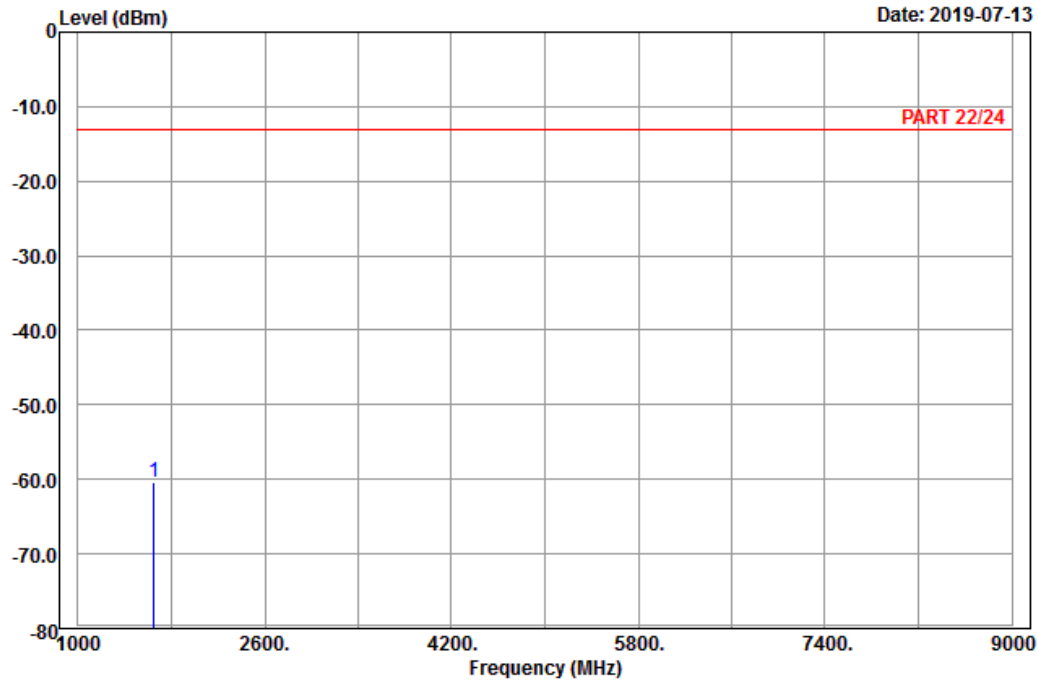

Site : 966 chamber 1  
Condition: PART 22/24 Horizontal  
Remark : EDGE 850\_Link\_CH128  
Tested by: Charles Hsiao

	Freq	Level	Read Level	Factor	Limit Line	Over Limit	Remark
	MHz	dBm	dBm	dB	dBm	dB	
1	pp 1648.40	-60.40	-68.13	7.73	-13.00	-47.40	Peak



Bureau Veritas Consumer Products Services Ltd., Taoyuan Branch

A D T

Data: 4

Date: 2019-07-13

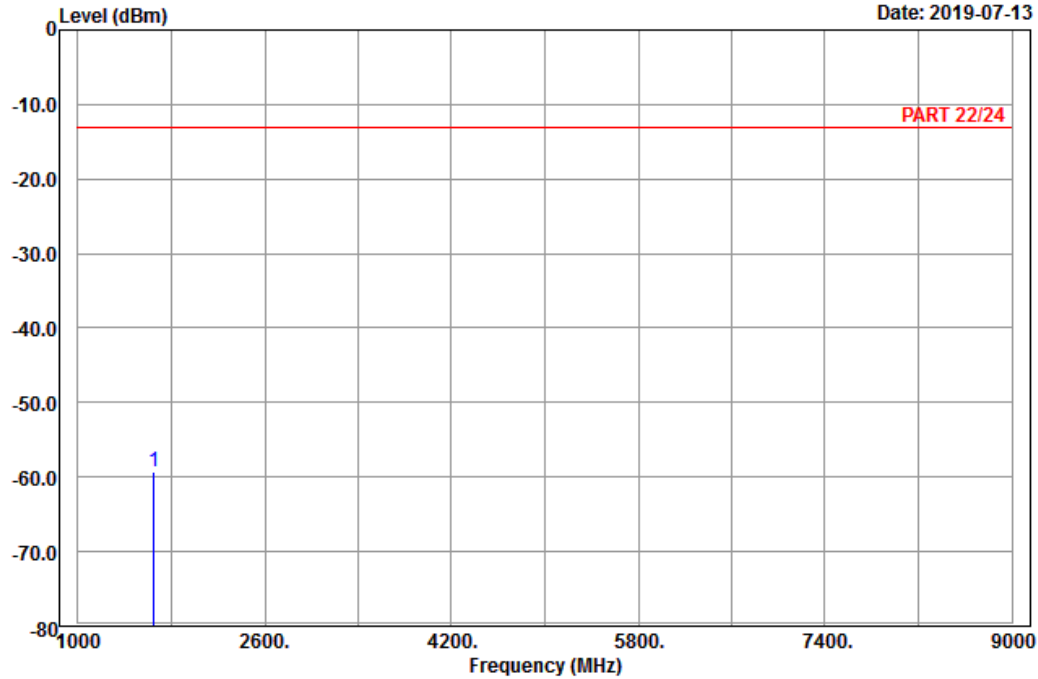

Site : 966 chamber 1  
 Condition: PART 22/24 Vertical  
 Remark : EDGE 850\_Link\_CH128  
 Tested by: Charles Hsiao

	Read	Limit	Over				
Freq	Level	Level	Factor	Line	Limit	Remark	
MHz	dBm	dBm	dB	dBm	dB		
1 pp 1648.40	-59.24	-66.97	7.73	-13.00	-46.24	Peak	

Middle Channel



Bureau Veritas Consumer Products Services Ltd., Taoyuan Branch

A D T

Data: 5

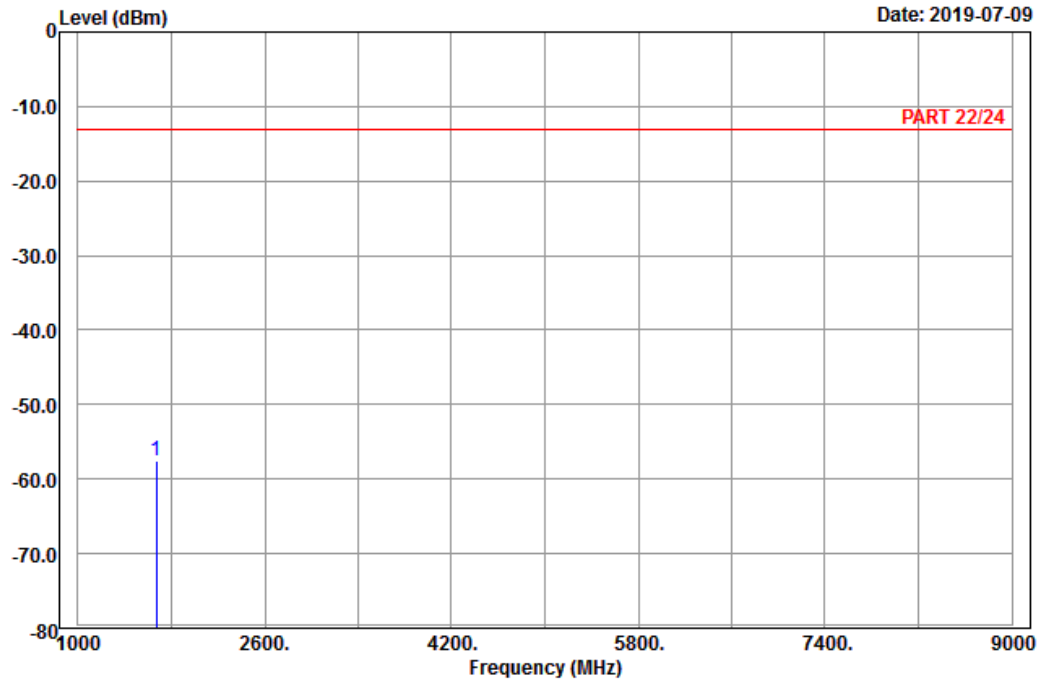

Site : 966 chamber 1  
 Condition: PART 22/24 Horizontal  
 Remark : EDGE 850\_Link\_CH189  
 Tested by: Charles Hsiao

	Freq	Level	Read Level	Factor	Limit Line	Over Limit	Remark
	MHz	dBm	dBm	dB	dBm	dB	
1	pp 1672.80	-57.47	-65.38	7.91	-13.00	-44.47	Peak



Bureau Veritas Consumer Products Services Ltd., Taoyuan Branch

A D T

Data: 6

Date: 2019-07-09

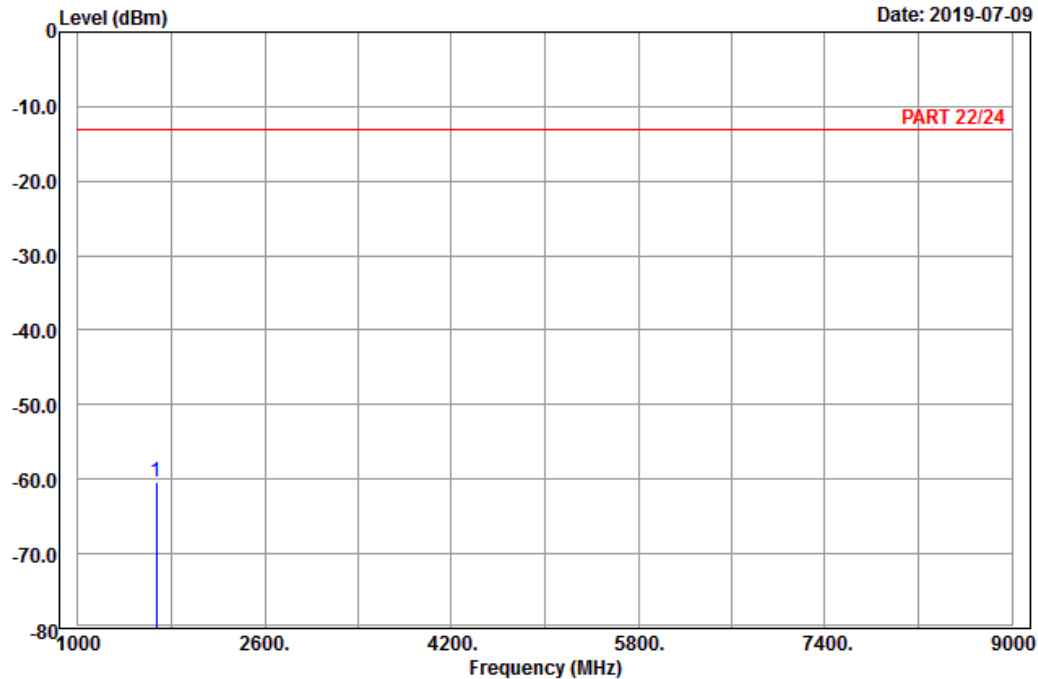

Site : 966 chamber 1  
 Condition: PART 22/24 Vertical  
 Remark : EDGE 850\_Link\_CH189  
 Tested by: Charles Hsiao

	Read	Limit	Over	
Freq	Level	Level	Factor	Line
MHz	dBm	dBm	dB	dBm
1 pp 1672.80	-60.45	-68.36	7.91	-13.00
				-47.45
				Peak

High Channel



Bureau Veritas Consumer Products Services Ltd., Taoyuan Branch

A D T

Data: 3

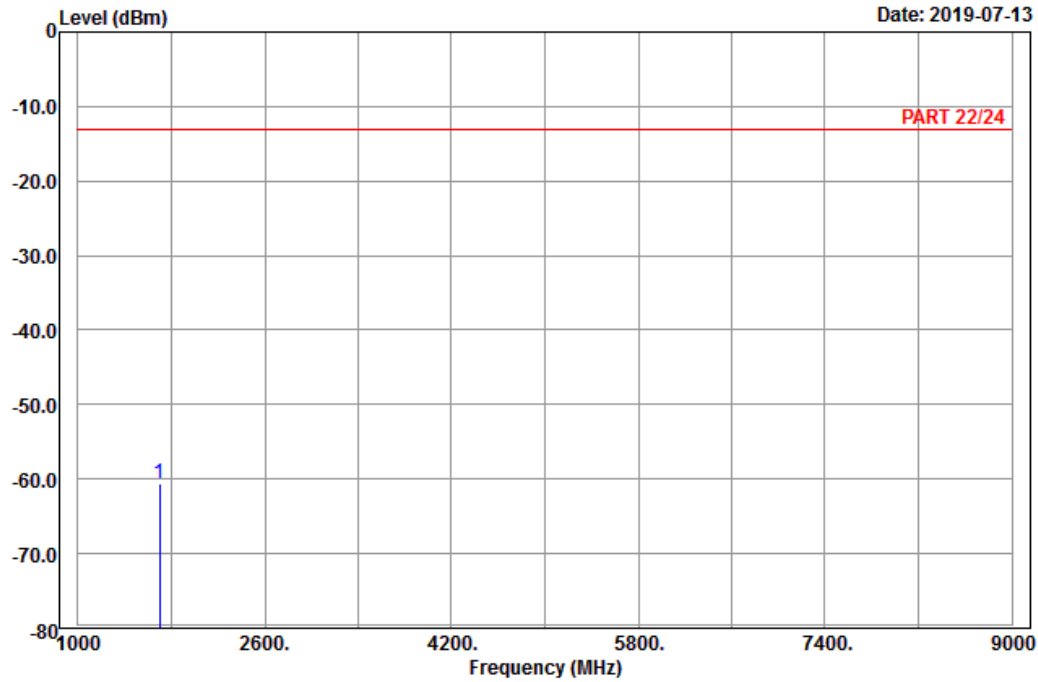

Site : 966 chamber 1  
 Condition: PART 22/24 Horizontal  
 Remark : EDGE 850\_Link\_CH251  
 Tested by: Charles Hsiao

Freq	Level	Read Level	Factor	Limit Line	Over Limit	Remark
MHz	dBm	dBm	dB	dBm	dB	
1 pp 1697.60	-60.68	-68.82	8.14	-13.00	-47.68	Peak



Bureau Veritas Consumer Products Services Ltd., Taoyuan Branch

A D T

Data: 4

Date: 2019-07-13

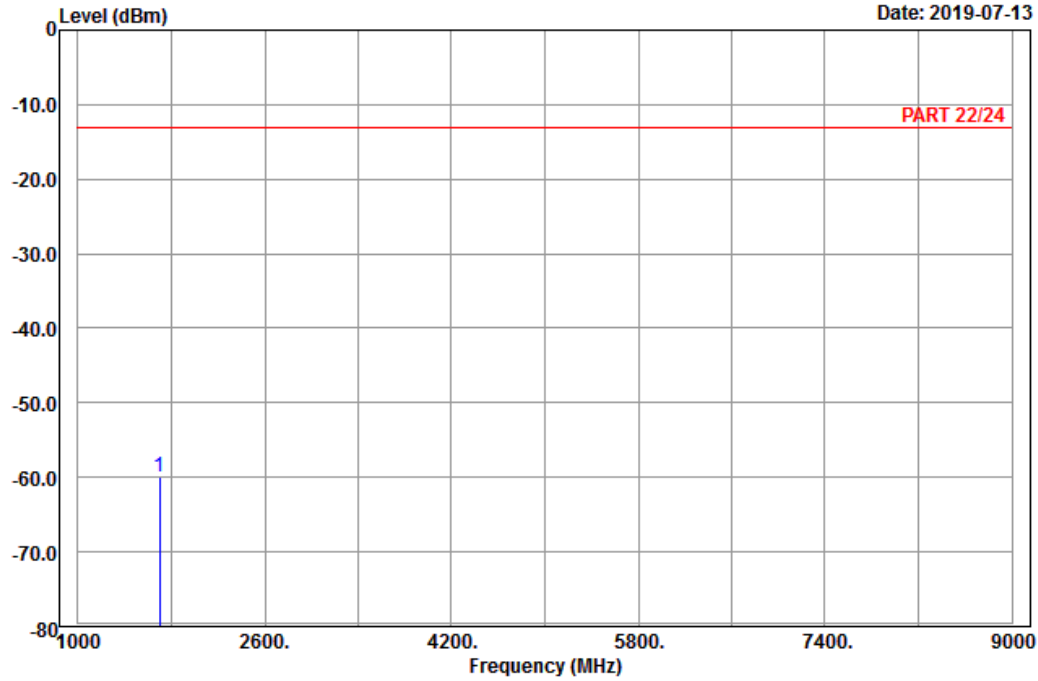

Site : 966 chamber 1  
 Condition: PART 22/24 Vertical  
 Remark : EDGE 850\_Link\_CH251  
 Tested by: Charles Hsiao

	Freq	Level	Read Level	Factor	Limit Line	Over Limit	Remark
	MHz	dBm	dBm	dB	dBm	dB	
1 pp	1697.60	-60.00	-68.14	8.14	-13.00	-47.00	Peak

WCDMA:  
Low Channel



Bureau Veritas Consumer Products Services Ltd., Taoyuan Branch

A D T

Data: 5

Date: 2019-07-08

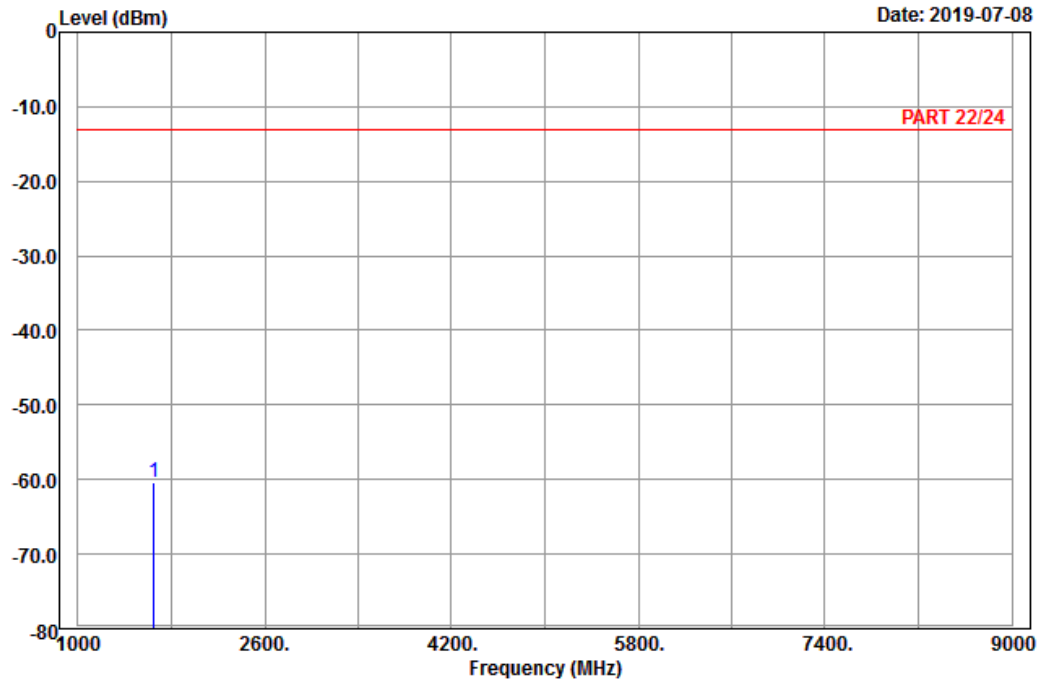

Site : 966 chamber 1  
Condition: PART 22/24 Horizontal  
Remark : Band V\_Link\_CH4132  
Tested by: Karl Lee

	Freq	Level	Read Level	Factor	Limit Line	Over Limit	Remark
	MHz	dBm	dBm	dB	dBm	dB	
1	pp 1652.80	-60.30	-68.03	7.73	-13.00	-47.30	Peak



Bureau Veritas Consumer Products Services Ltd., Taoyuan Branch

A D T

Data: 6

Date: 2019-07-08

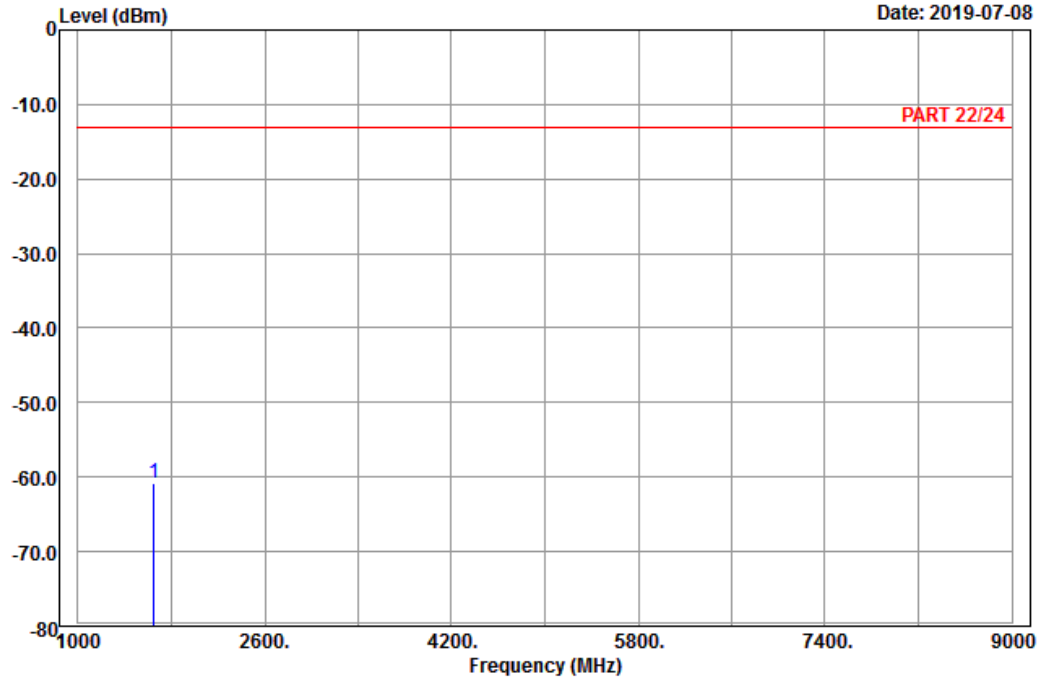

Site : 966 chamber 1  
 Condition: PART 22/24 Vertical  
 Remark : Band V\_Link\_CH4132  
 Tested by: Karl Lee

	Freq	Level	Read Level	Factor	Limit Line	Over Limit	Remark
	MHz	dBm	dBm	dB	dBm	dB	
1 pp	1652.80	-60.76	-68.49	7.73	-13.00	-47.76	Peak



Middle Channel



Bureau Veritas Consumer Products Services Ltd., Taoyuan Branch

A D T

Data: 5

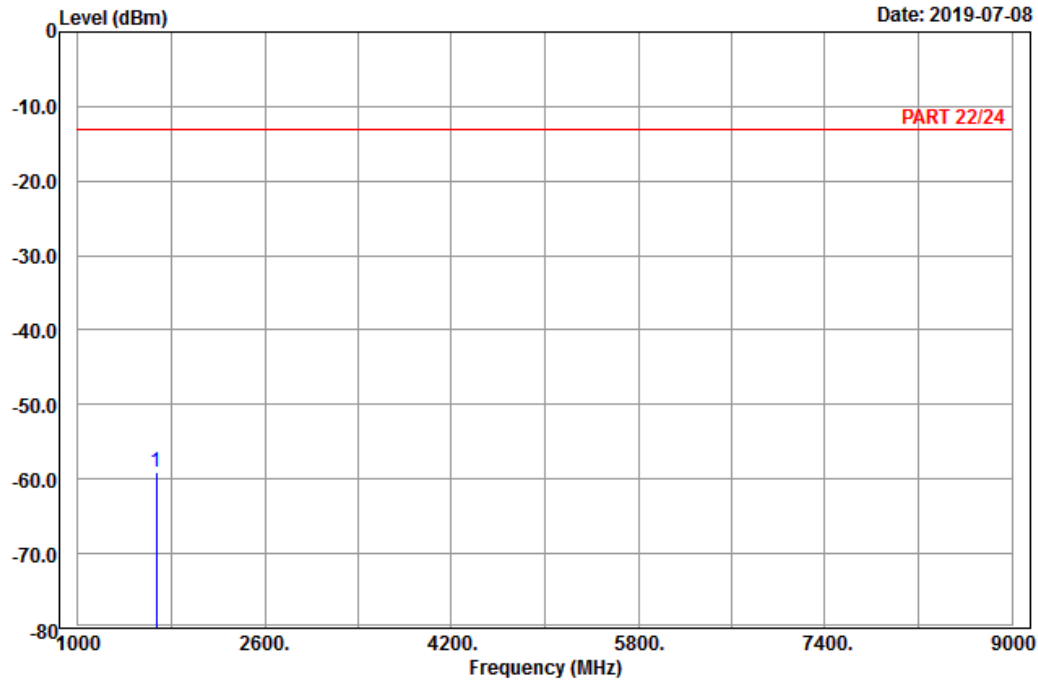

Site : 966 chamber 1  
 Condition: PART 22/24 Horizontal  
 Remark : Band V\_Link\_CH4182  
 Tested by: Karl Lee

	Freq	Level	Read Level	Factor	Limit Line	Over Limit	Remark
	MHz	dBm	dBm	dB	dBm	dB	
1	pp 1672.80	-59.00	-66.91	7.91	-13.00	-46.00	Peak



Bureau Veritas Consumer Products Services Ltd., Taoyuan Branch

A D T

Data: 6

Date: 2019-07-08

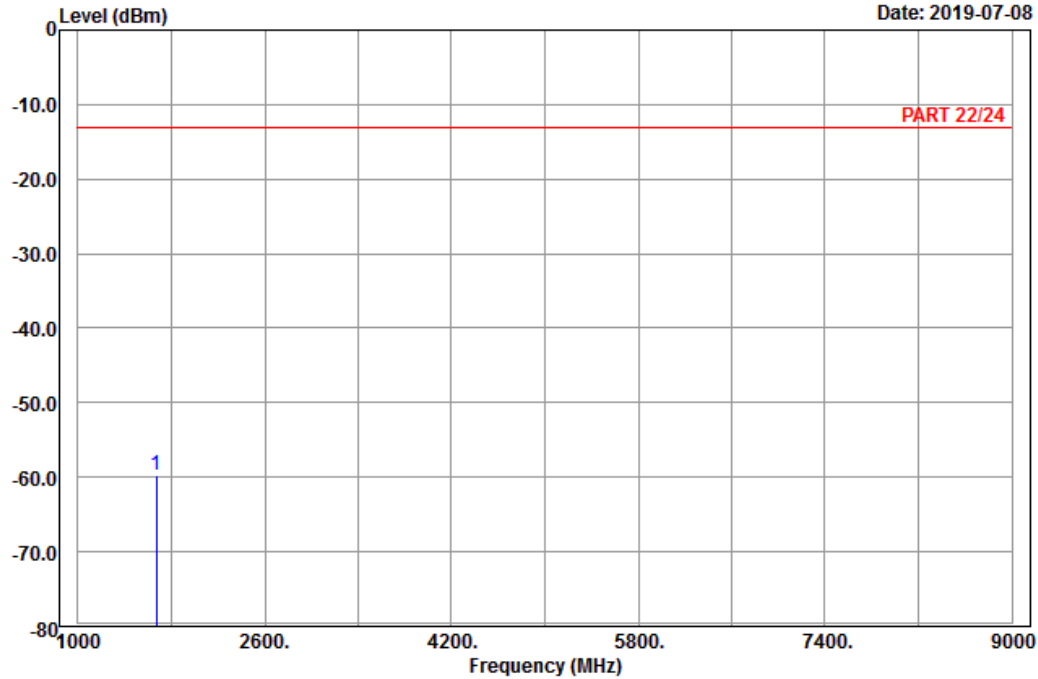

Site : 966 chamber 1  
 Condition: PART 22/24 Vertical  
 Remark : Band V\_Link\_CH4182  
 Tested by: Karl Lee

	Freq	Level	Read Level	Factor	Limit Line	Over Limit	Remark
	MHz	dBm	dBm	dB	dBm	dB	
1 pp	1672.80	-59.76	-67.67	7.91	-13.00	-46.76	Peak

High Channel



Bureau Veritas Consumer Products Services Ltd., Taoyuan Branch

A D T

Data: 5

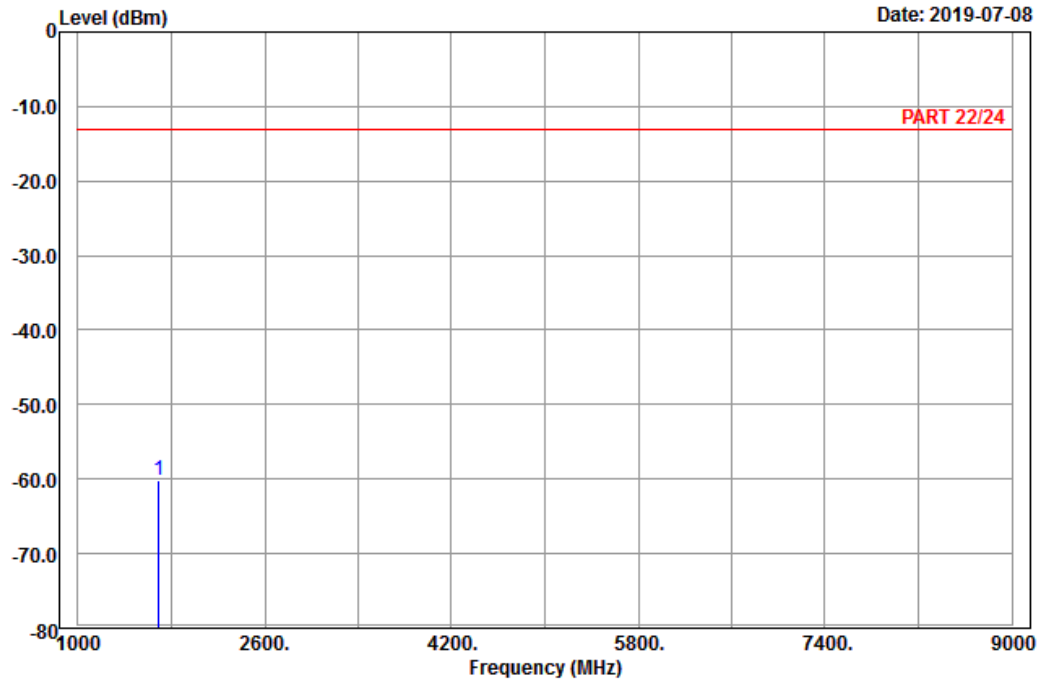

Site : 966 chamber 1  
 Condition: PART 22/24 Horizontal  
 Remark : Band V\_Link\_CH4233  
 Tested by: Karl Lee

Freq	Level	Read Level	Factor	Limit Line	Over Limit	Remark
MHz	dBm	dBm	dB	dBm	dB	
1 pp 1693.20	-60.22	-68.36	8.14	-13.00	-47.22	Peak



Bureau Veritas Consumer Products Services Ltd., Taoyuan Branch

A D T

Data: 6

Date: 2019-07-08

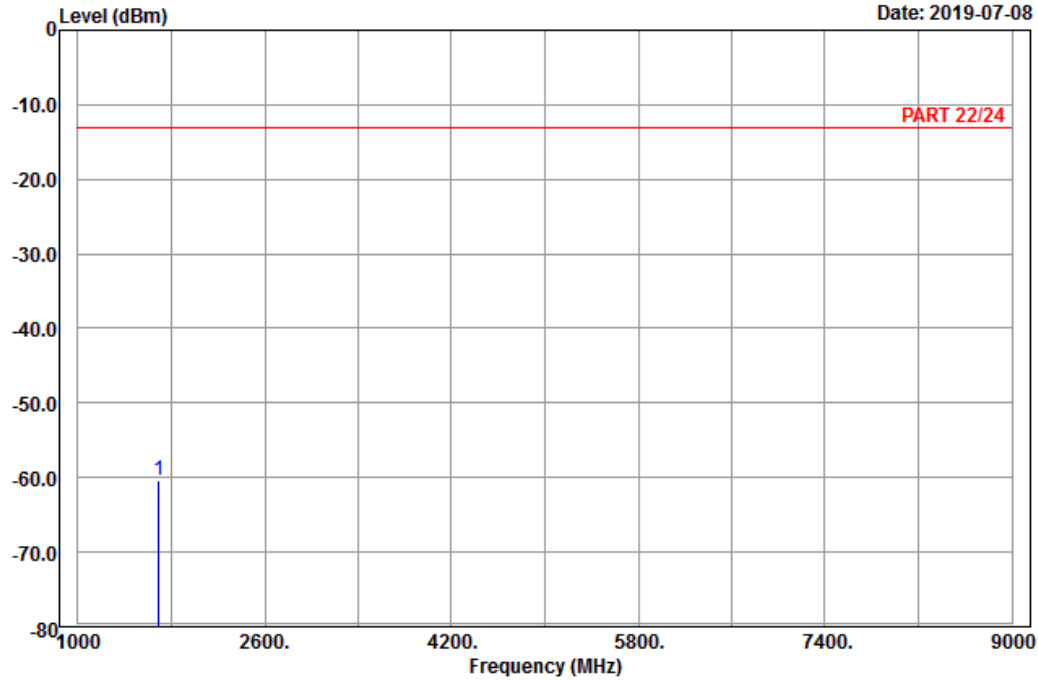

Site : 966 chamber 1  
 Condition: PART 22/24 Vertical  
 Remark : Band V\_Link\_CH4233  
 Tested by: Karl Lee

	Freq	Level	Read Level	Factor	Limit Line	Over Limit	Remark
	MHz	dBm	dBm	dB	dBm	dB	
1 pp	1693.20	-60.46	-68.60	8.14	-13.00	-47.46	Peak

LTE Band 5  
 Channel Bandwidth: 1.4 MHz / QPSK  
 Low Channel



Bureau Veritas Consumer Products Services Ltd., Taoyuan Branch

A D T

Data: 5

Date: 2019-07-06

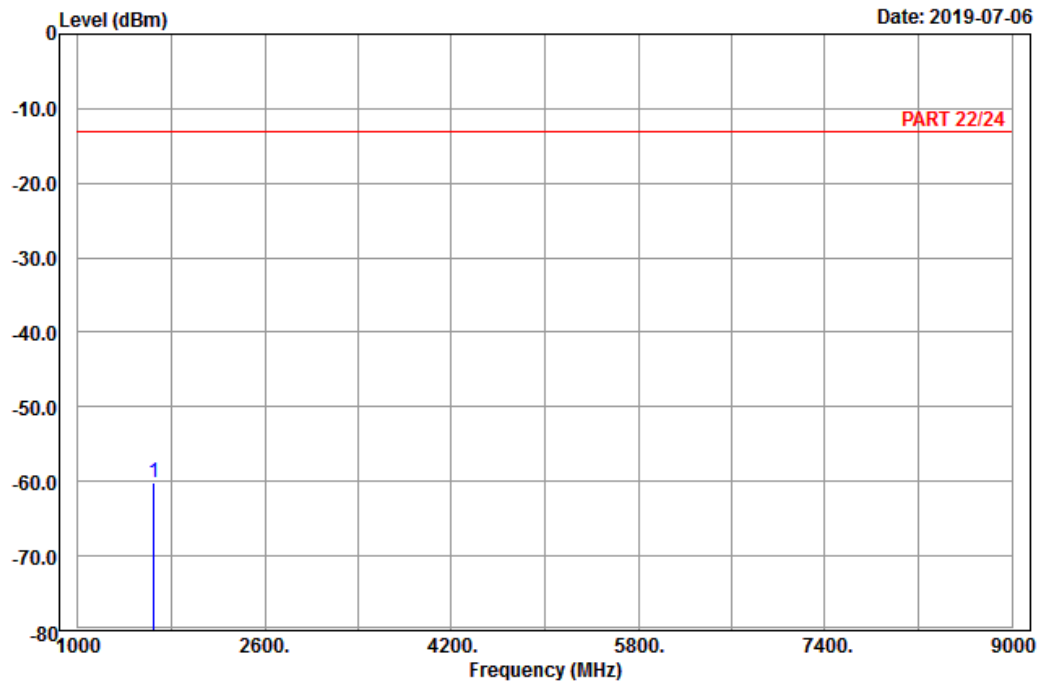

Site : 966 chamber 1  
 Condition: PART 22/24 Horizontal  
 Remark : LTE\_Band 5\_Link\_CH20407  
 Tested by: Karl Lee

	Read	Limit	Over	
Freq	Level	Level	Factor	Line
MHz	dBm	dBm	dB	dBm
1 pp 1649.40	-60.22	-67.95	7.73	-13.00
				-47.22
				Peak



Bureau Veritas Consumer Products Services Ltd., Taoyuan Branch

A D T

Data: 6

Date: 2019-07-06

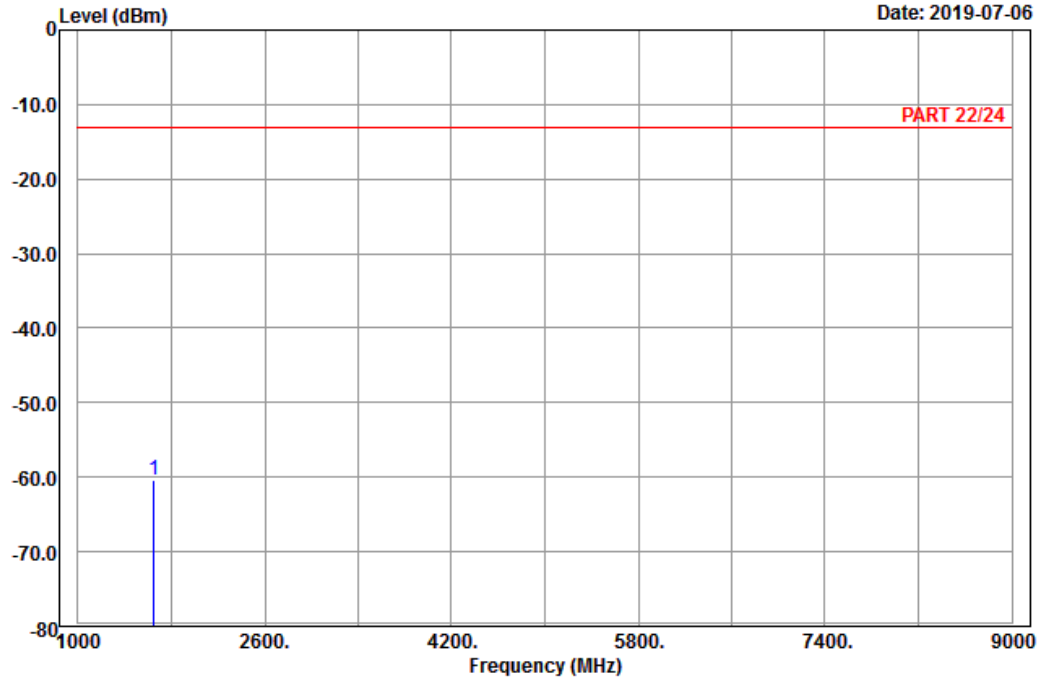

Site : 966 chamber 1  
 Condition: PART 22/24 Vertical  
 Remark : LTE\_Band 5\_Link\_CH20407  
 Tested by: Karl Lee

	Freq	Level	Read Level	Factor	Limit Line	Over Limit	Remark
	MHz	dBm	dBm	dB	dBm	dB	
1 pp	1649.40	-60.33	-68.06	7.73	-13.00	-47.33	Peak

Middle Channel



Bureau Veritas Consumer Products Services Ltd., Taoyuan Branch

A D T

Data: 5

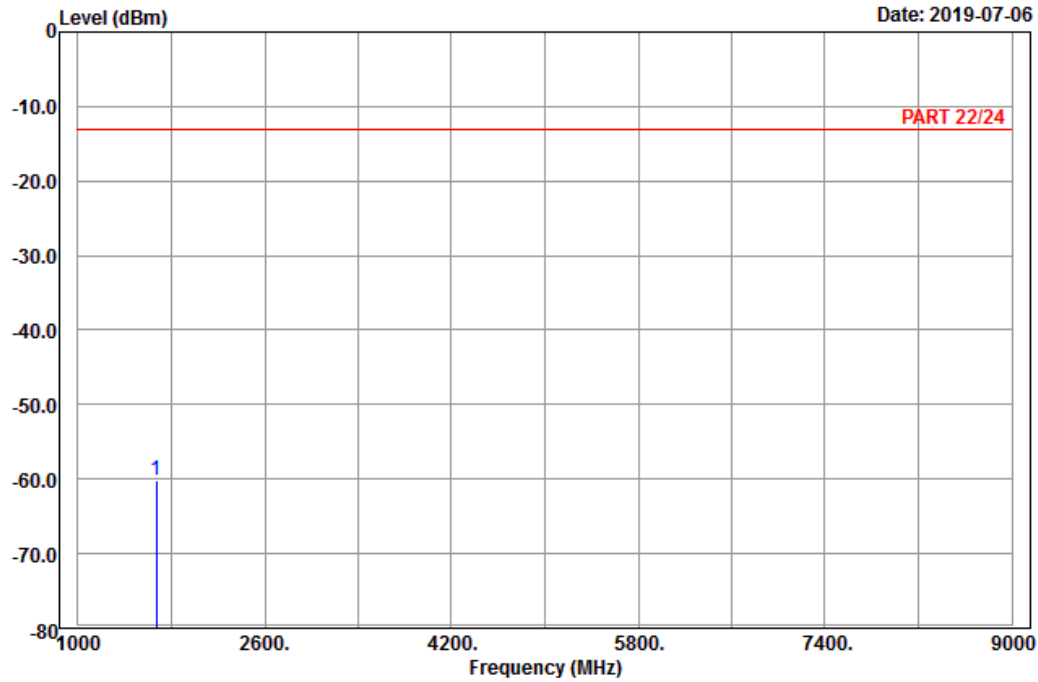

Site : 966 chamber 1  
 Condition: PART 22/24 Horizontal  
 Remark : LTE\_Band 5\_Link\_CH20525  
 Tested by: Karl Lee

Freq	Level	Read Level	Factor	Limit Line	Over Limit	Remark
MHz	dBm	dBm	dB	dBm	dB	
1 pp 1673.00	-60.18	-68.09	7.91	-13.00	-47.18	Peak



Bureau Veritas Consumer Products Services Ltd., Taoyuan Branch

A D T

Data: 6

Date: 2019-07-06

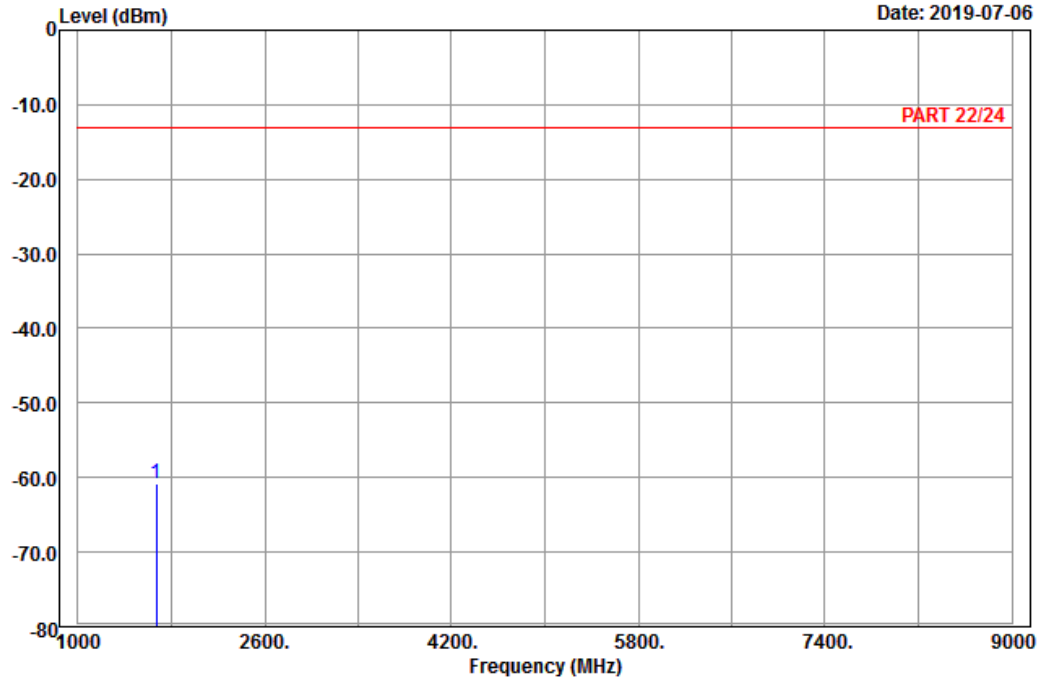

Site : 966 chamber 1  
 Condition: PART 22/24 Vertical  
 Remark : LTE\_Band 5\_Link\_CH20525  
 Tested by: Karl Lee

	Freq	Level	Read Level	Factor	Limit Line	Over Limit	Remark
	MHz	dBm	dBm	dB	dBm	dB	
1 pp	1673.00	-60.87	-68.78	7.91	-13.00	-47.87	Peak



# High Channel



Bureau Veritas Consumer Products Services Ltd., Taoyuan Branch

A D T

Data: 5

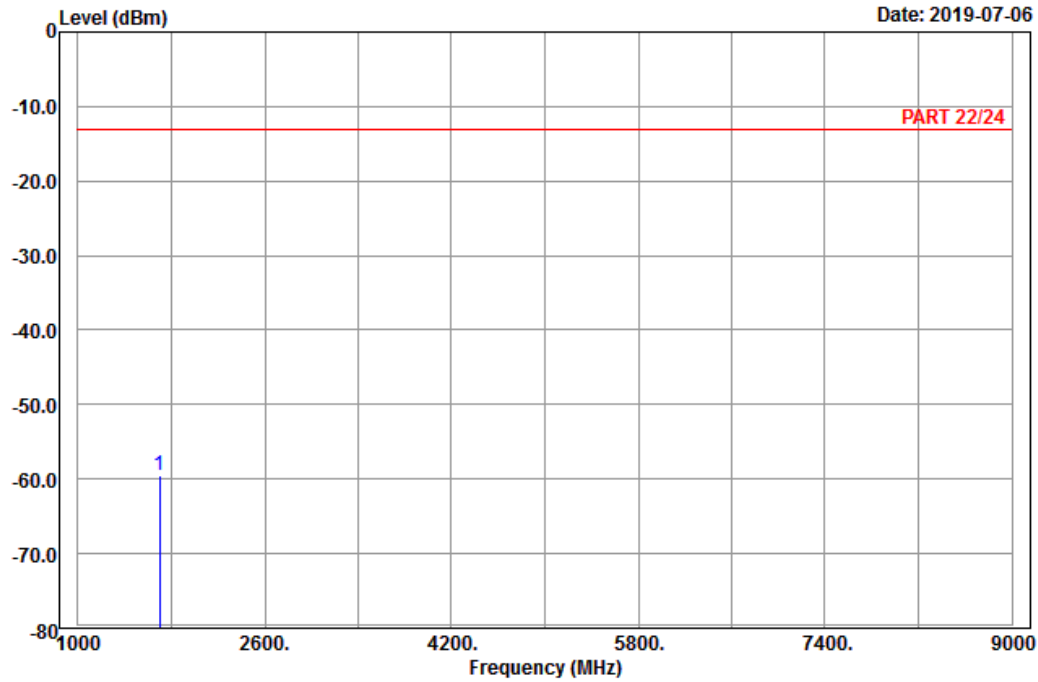

Site : 966 chamber 1  
 Condition: PART 22/24 Horizontal  
 Remark : LTE\_Band 5\_Link\_CH20643  
 Tested by: Karl Lee

	Freq	Level	Read Level	Factor	Limit Line	Over Limit	Remark
	MHz	dBm	dBm	dB	dBm	dB	
1	pp 1696.60	-59.50	-67.64	8.14	-13.00	-46.50	Peak



Bureau Veritas Consumer Products Services Ltd., Taoyuan Branch

A D T

Data: 6

Date: 2019-07-06

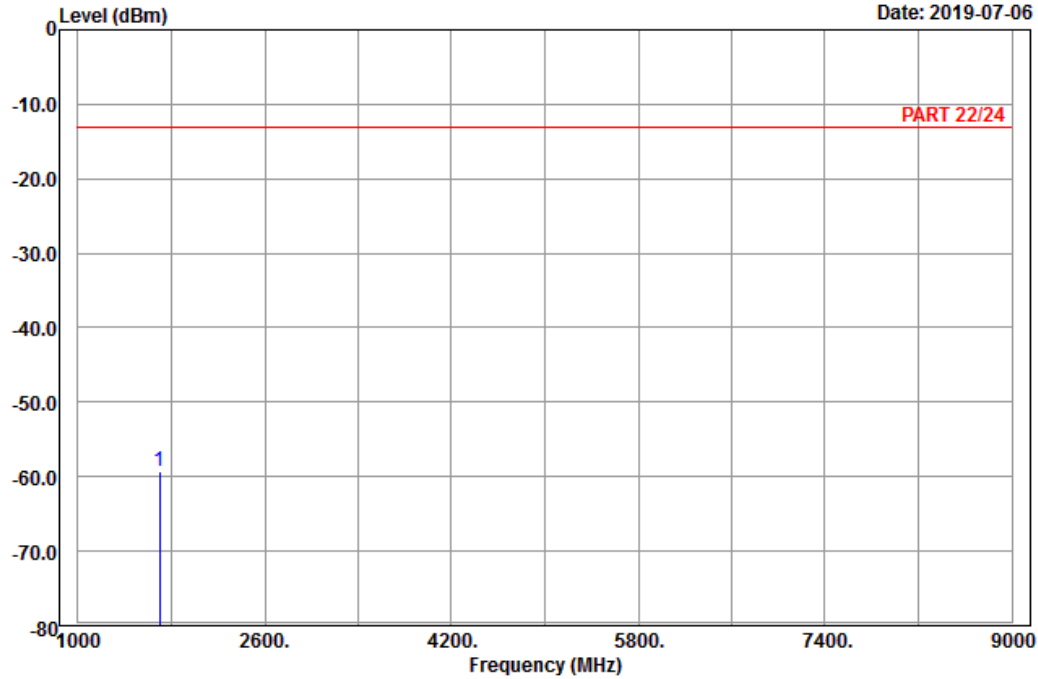

Site : 966 chamber 1  
 Condition: PART 22/24 Vertical  
 Remark : LTE\_Band 5\_Link\_CH20643  
 Tested by: Karl Lee

	Freq	Level	Read Level	Factor	Limit Line	Over Limit	Remark
	MHz	dBm	dBm	dB	dBm	dB	
1 pp	1696.60	-59.30	-67.44	8.14	-13.00	-46.30	Peak

Channel Bandwidth: 5 MHz / QPSK  
Low Channel



Bureau Veritas Consumer Products Services Ltd., Taoyuan Branch

A D T

Data: 5

Date: 2019-07-06

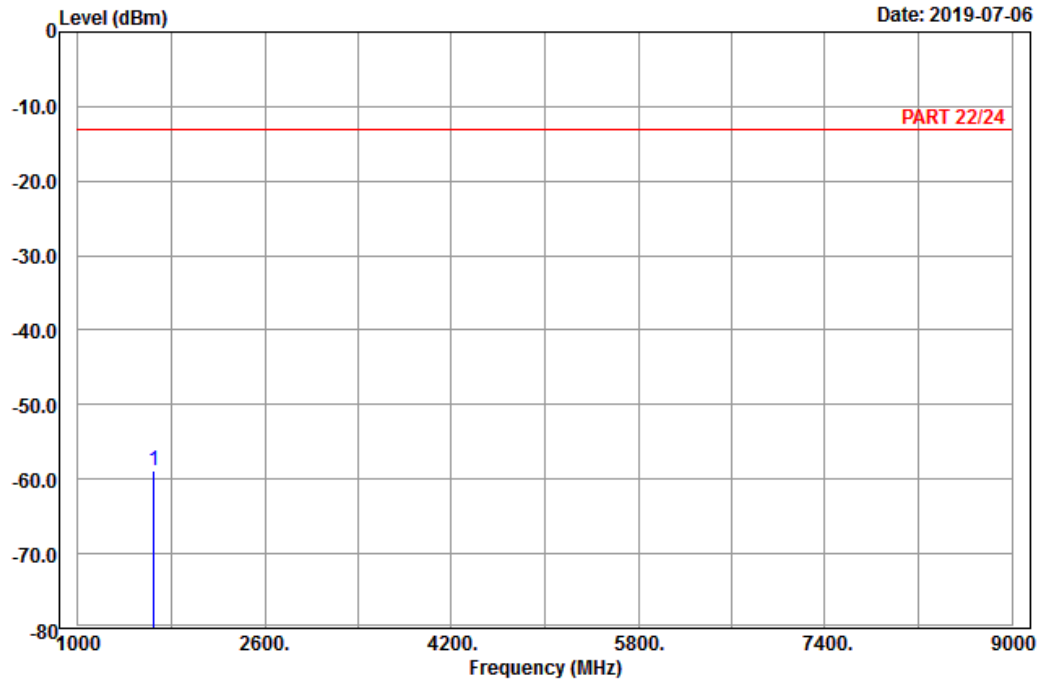

Site : 966 chamber 1  
Condition: PART 22/24 Horizontal  
Remark : LTE\_Band 5\_Link\_CH20425  
Tested by: Harry Hsueh

	Freq	Level	Read Level	Factor	Limit Line	Over Limit	Remark
	MHz	dBm	dBm	dB	dBm	dB	
1	pp 1653.00	-58.92	-66.65	7.73	-13.00	-45.92	Peak



Bureau Veritas Consumer Products Services Ltd., Taoyuan Branch

A D T

Data: 6

Date: 2019-07-06

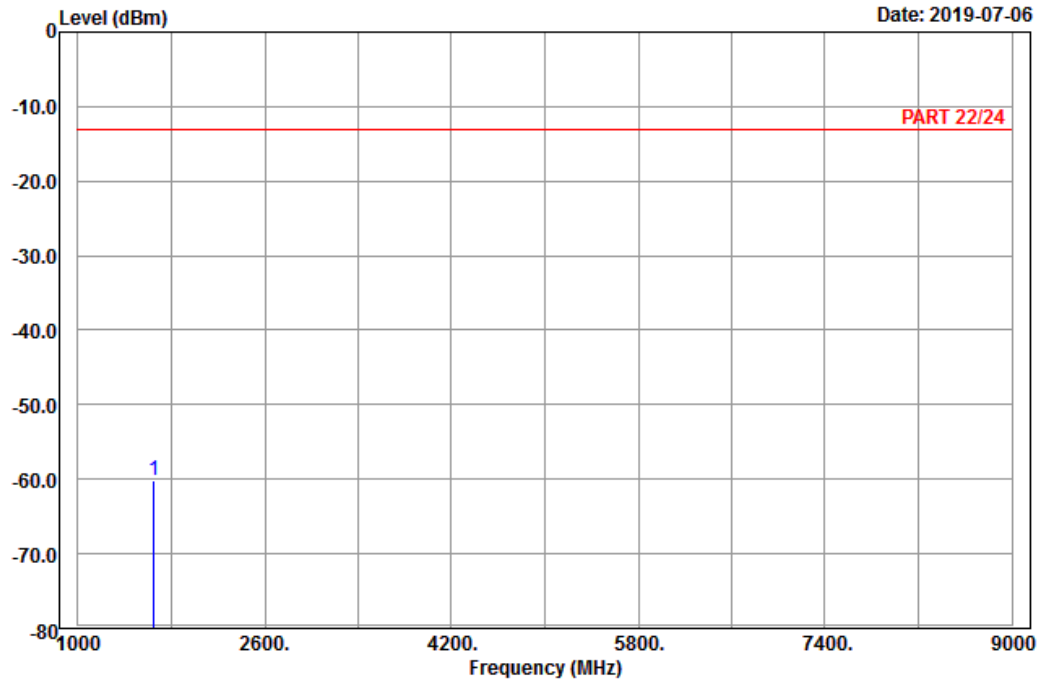

Site : 966 chamber 1  
 Condition: PART 22/24 Vertical  
 Remark : LTE\_Band 5\_Link\_CH20425  
 Tested by: Harry Hsueh

	Read	Limit	Over	
Freq	Level	Level	Factor	Line
MHz	dBm	dBm	dB	dBm
1 pp 1653.00	-60.22	-67.95	7.73	-13.00
				-47.22 Peak

Middle Channel



Bureau Veritas Consumer Products Services Ltd., Taoyuan Branch

A D T

Data: 5

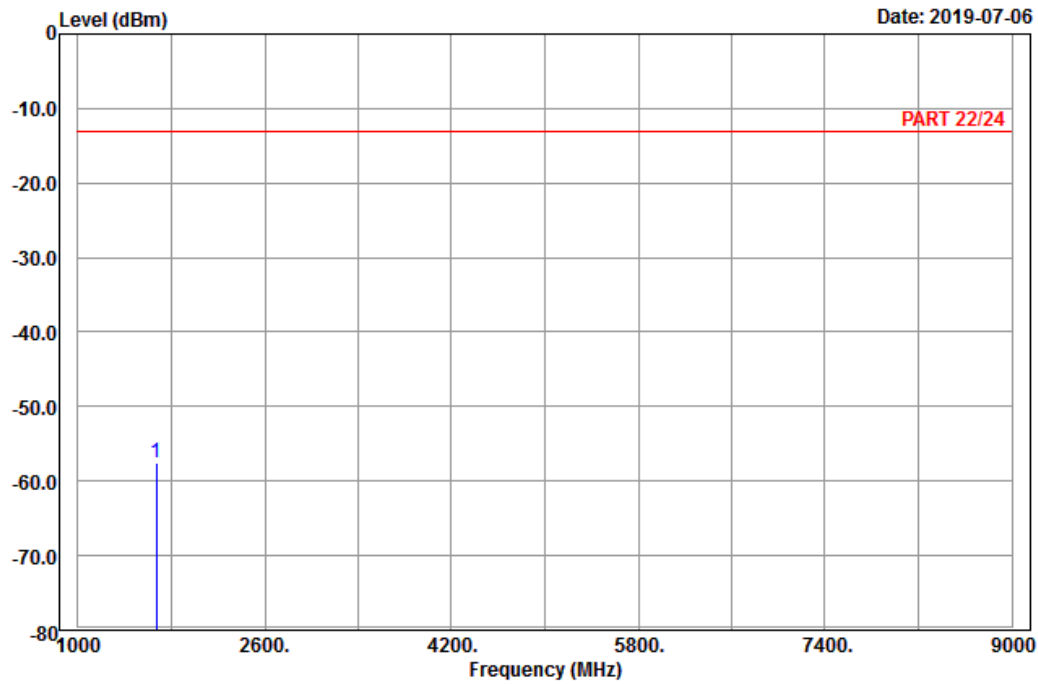

Site : 966 chamber 1  
 Condition: PART 22/24 Horizontal  
 Remark : LTE\_Band 5\_Link\_CH20525  
 Tested by: Harry Hsueh

	Freq	Level	Read Level	Factor	Limit Line	Over Limit	Remark
	MHz	dBm	dBm	dB	dBm	dB	
1	pp 1673.00	-57.46	-65.37	7.91	-13.00	-44.46	Peak



Bureau Veritas Consumer Products Services Ltd., Taoyuan Branch

A D T

Data: 6

Date: 2019-07-06

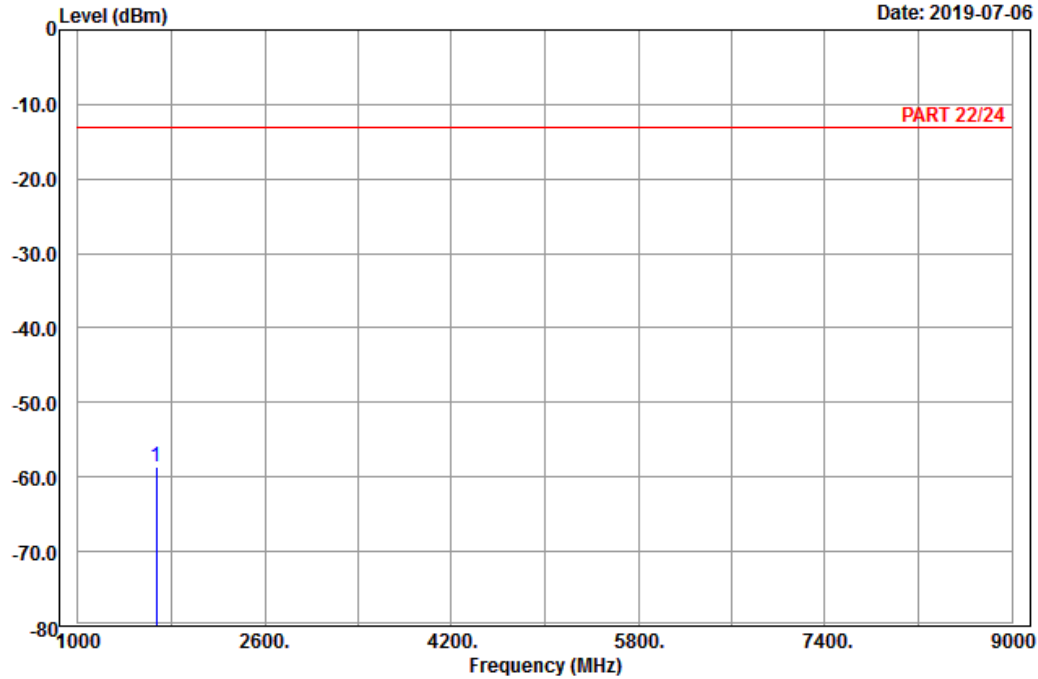

Site : 966 chamber 1  
 Condition: PART 22/24 Vertical  
 Remark : LTE\_Band 5\_Link\_CH20525  
 Tested by: Harry Hsueh

	Freq	Level	Read Level	Factor	Limit Line	Over Limit	Remark
	MHz	dBm	dBm	dB	dBm	dB	
1 pp	1673.00	-58.60	-66.51	7.91	-13.00	-45.60	Peak

# High Channel



Bureau Veritas Consumer Products Services Ltd., Taoyuan Branch

A D T

Data: 5

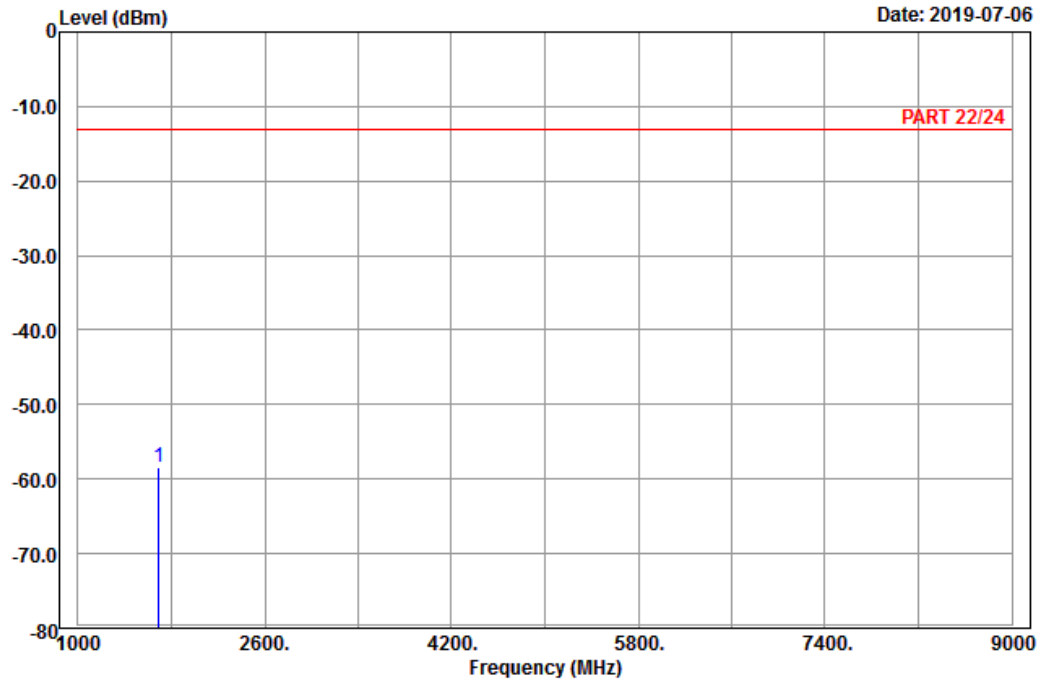

Site : 966 chamber 1  
 Condition: PART 22/24 Horizontal  
 Remark : LTE\_Band 5\_Link\_CH20625  
 Tested by: Karl Lee

	Freq	Level	Read Level	Factor	Limit Line	Over Limit	Remark
	MHz	dBm	dBm	dB	dBm	dB	
1	pp 1693.00	-58.50	-66.52	8.02	-13.00	-45.50	Peak



Bureau Veritas Consumer Products Services Ltd., Taoyuan Branch

A D T

Data: 6

Date: 2019-07-06

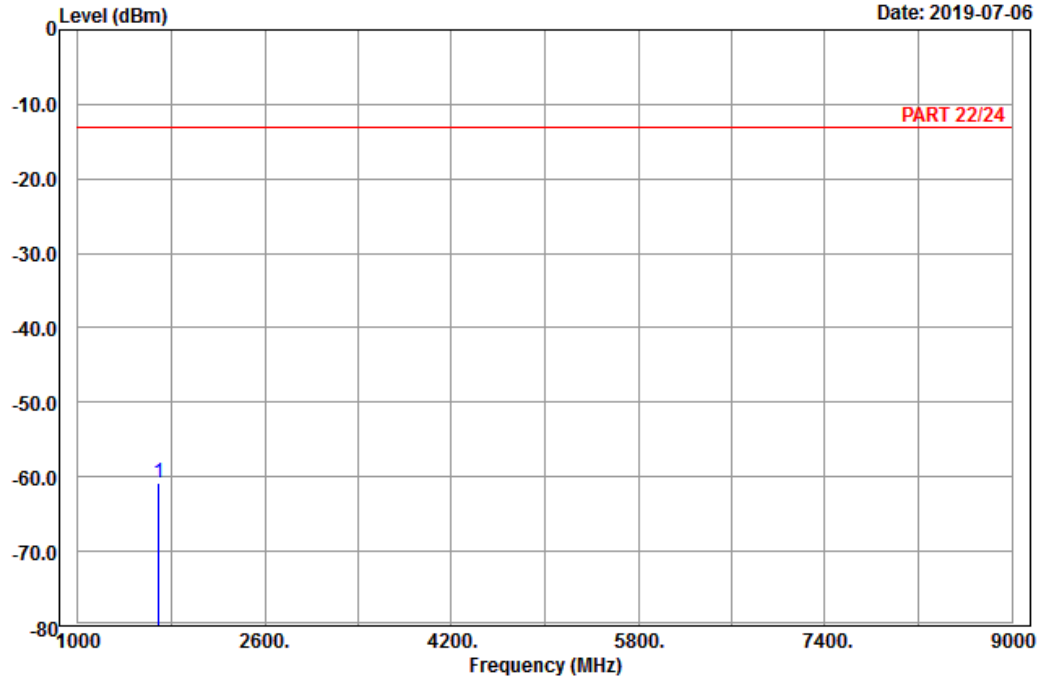

Site : 966 chamber 1  
 Condition: PART 22/24 Vertical  
 Remark : LTE\_Band 5\_Link\_CH20625  
 Tested by: Karl Lee

	Freq	Level	Read Level	Factor	Limit Line	Over Limit	Remark
	MHz	dBm	dBm	dB	dBm	dB	
1 pp	1693.00	-60.74	-68.76	8.02	-13.00	-47.74	Peak



Channel Bandwidth: 10 MHz / QPSK  
 Low Channel



Bureau Veritas Consumer Products Services Ltd., Taoyuan Branch

A D T

Data: 5

Date: 2019-07-06

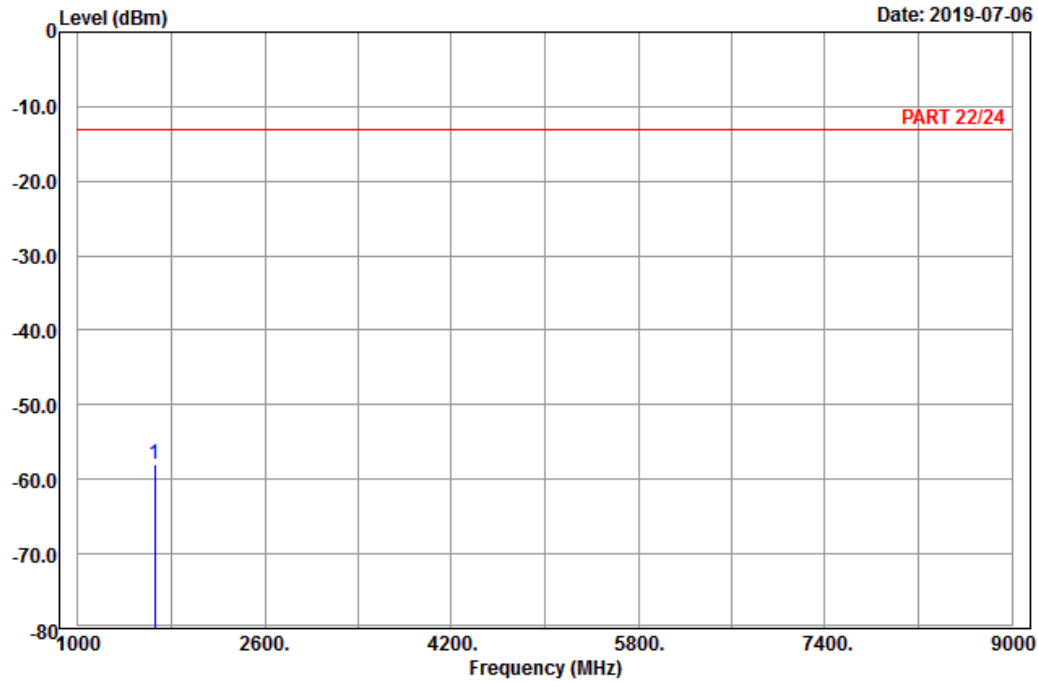

Site : 966 chamber 1  
 Condition: PART 22/24 Horizontal  
 Remark : LTE\_Band 5\_Link\_CH20450  
 Tested by: Karl Lee

	Freq	Level	Read Level	Factor	Limit Line	Over Limit	Remark
	MHz	dBm	dBm	dB	dBm	dB	
1	pp 1658.00	-58.08	-65.99	7.91	-13.00	-45.08	Peak



Bureau Veritas Consumer Products Services Ltd., Taoyuan Branch

A D T

Data: 6

Date: 2019-07-06

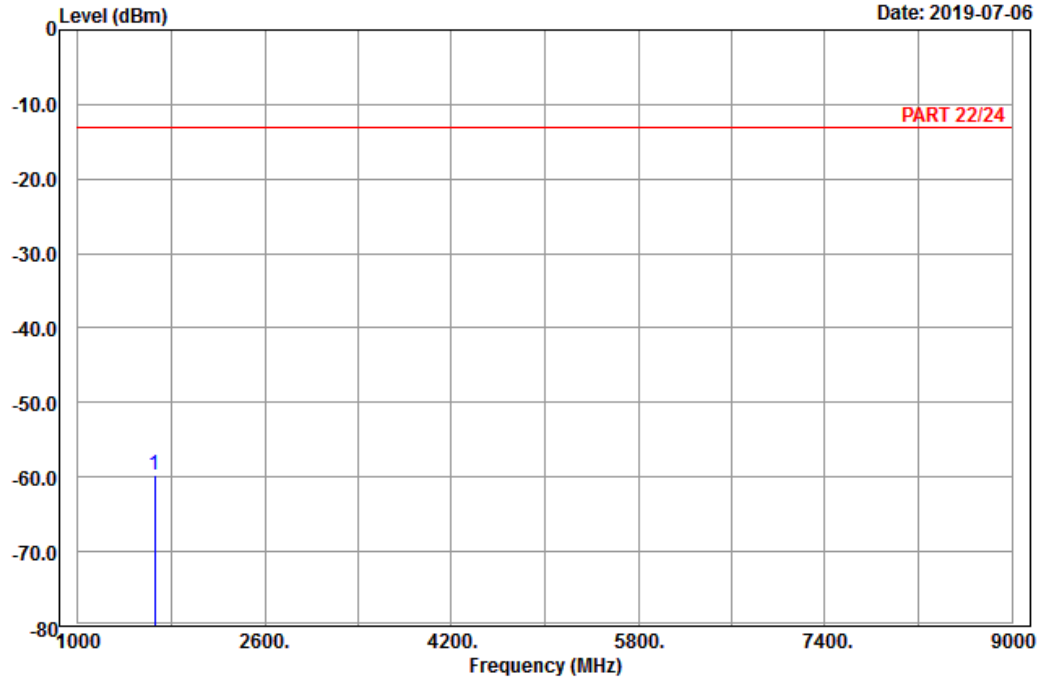

Site : 966 chamber 1  
 Condition: PART 22/24 Vertical  
 Remark : LTE\_Band 5\_Link\_CH20450  
 Tested by: Karl Lee

	Freq	Level	Read Level	Factor	Limit Line	Over Limit	Remark
	MHz	dBm	dBm	dB	dBm	dB	
1 pp	1658.00	-59.66	-67.57	7.91	-13.00	-46.66	Peak

Middle Channel



Bureau Veritas Consumer Products Services Ltd., Taoyuan Branch

A D T

Data: 9

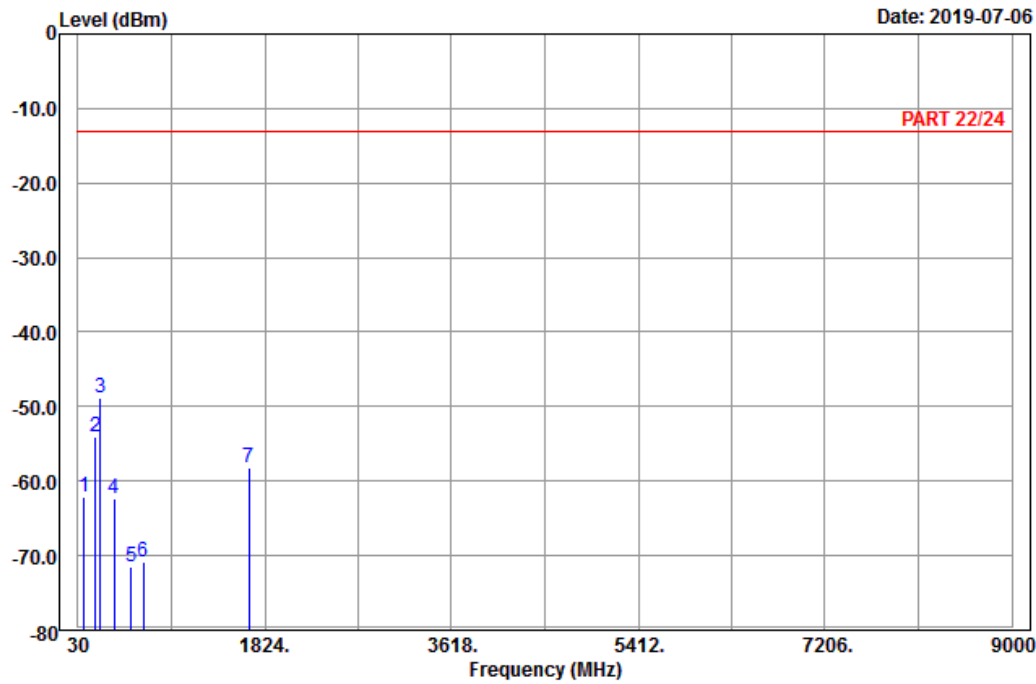

Site : 966 chamber 1  
 Condition: PART 22/24 Horizontal  
 Remark : LTE\_Band 5\_Link\_CH20525  
 Tested by: Karl Lee

	Freq	Level	Read Level	Factor	Limit Line	Over Limit	Remark
	MHz	dBm	dBm	dB	dBm	dB	
1	88.32	-62.14	-51.25	-10.89	-13.00	-49.14	Peak
2	196.59	-54.12	-48.07	-6.05	-13.00	-41.12	Peak
3 pp	241.68	-48.89	-43.27	-5.62	-13.00	-35.89	Peak
4	379.80	-62.30	-58.53	-3.77	-13.00	-49.30	Peak
5	543.60	-71.49	-69.33	-2.16	-13.00	-58.49	Peak
6	657.70	-70.81	-70.64	-0.17	-13.00	-57.81	Peak
7	1673.00	-58.19	-66.10	7.91	-13.00	-45.19	Peak



Bureau Veritas Consumer Products Services Ltd., Taoyuan Branch

A D T

Data: 10

Date: 2019-07-06

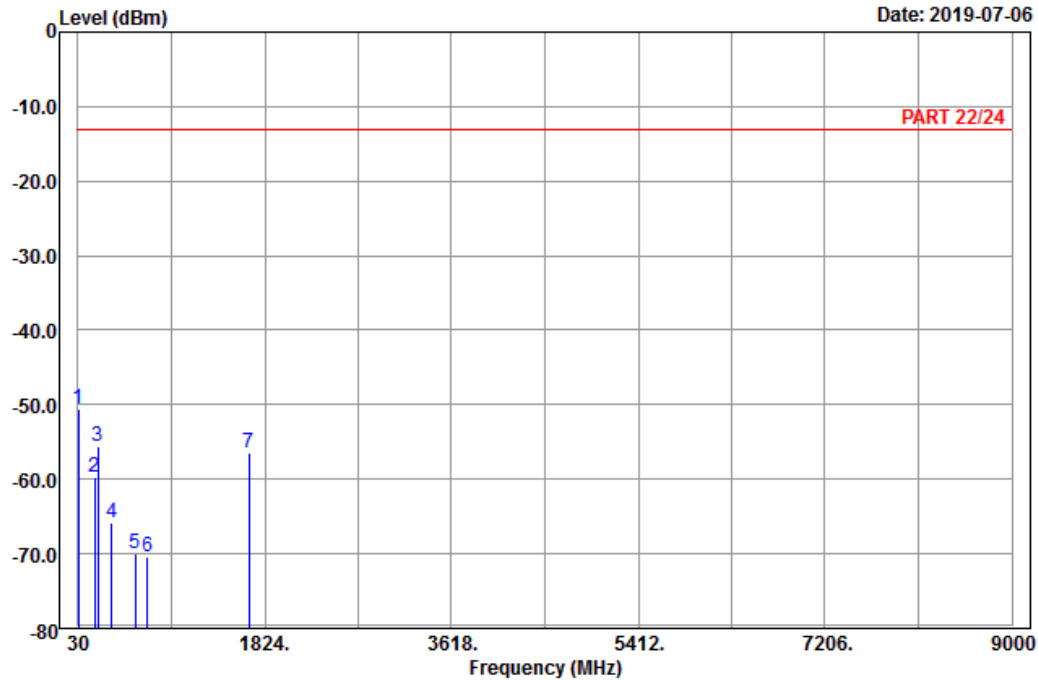

Site : 966 chamber 1  
 Condition: PART 22/24 Vertical  
 Remark : LTE\_Band 5\_Link\_CH20525  
 Tested by: Karl Lee

	Freq	Level	Read Level	Factor	Limit Line	Over Limit	Remark
	MHz	dBm	dBm	dB	dBm	dB	
1 pp	31.62	-50.56	-39.80	-10.76	-13.00	-37.56	Peak
2	192.81	-59.71	-53.84	-5.87	-13.00	-46.71	Peak
3	224.13	-55.60	-49.74	-5.86	-13.00	-42.60	Peak
4	356.00	-65.86	-60.79	-5.07	-13.00	-52.86	Peak
5	582.10	-69.97	-69.63	-0.34	-13.00	-56.97	Peak
6	694.80	-70.33	-69.98	-0.35	-13.00	-57.33	Peak
7	1673.00	-56.42	-64.33	7.91	-13.00	-43.42	Peak

# High Channel



Bureau Veritas Consumer Products Services Ltd., Taoyuan Branch

A D T

Data: 5

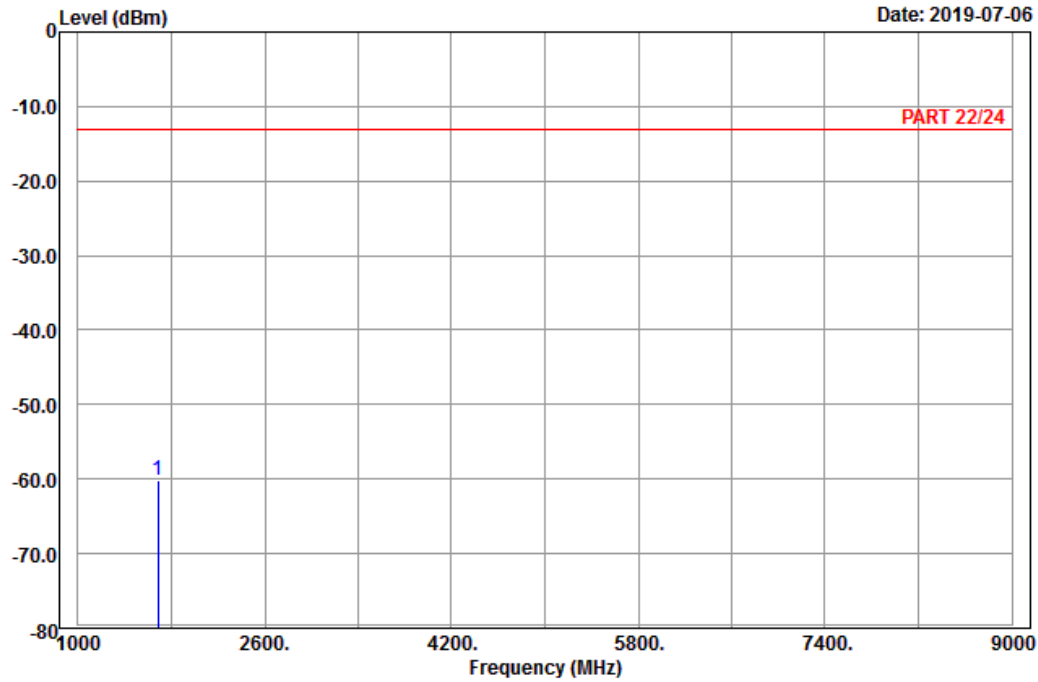

Site : 966 chamber 1  
 Condition: PART 22/24 Horizontal  
 Remark : LTE\_Band 5\_Link\_CH20600  
 Tested by: Karl Lee

Freq	Level	Read Level	Factor	Limit Line	Over Limit	Remark
MHz	dBm	dBm	dB	dBm	dB	
1 pp 1688.00	-60.07	-68.09	8.02	-13.00	-47.07	Peak



Bureau Veritas Consumer Products Services Ltd., Taoyuan Branch

A D T

Data: 6

Date: 2019-07-06

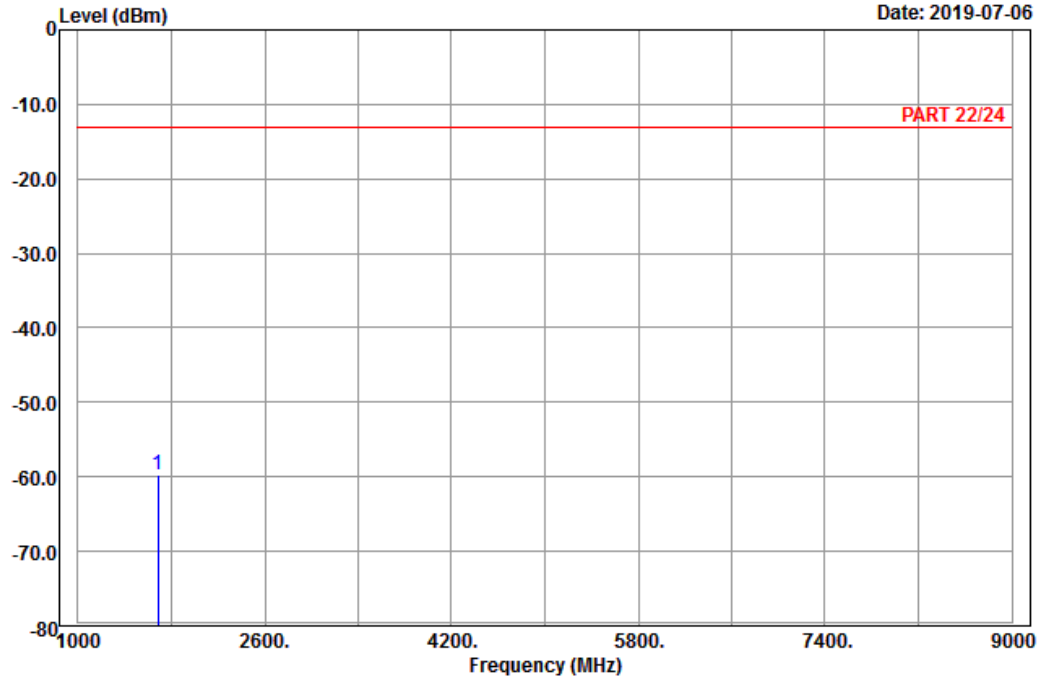

Site : 966 chamber 1  
 Condition: PART 22/24 Vertical  
 Remark : LTE\_Band 5\_Link\_CH20600  
 Tested by: Karl Lee

	Freq	Level	Read Level	Factor	Limit Line	Over Limit	Remark
	MHz	dBm	dBm	dB	dBm	dB	
1 pp	1688.00	-59.66	-67.68	8.02	-13.00	-46.66	Peak

LTE Band 26  
 Channel Bandwidth: 1.4 MHz / QPSK  
 Low Channel



Bureau Veritas Consumer Products Services Ltd., Taoyuan Branch

A D T

Data: 5

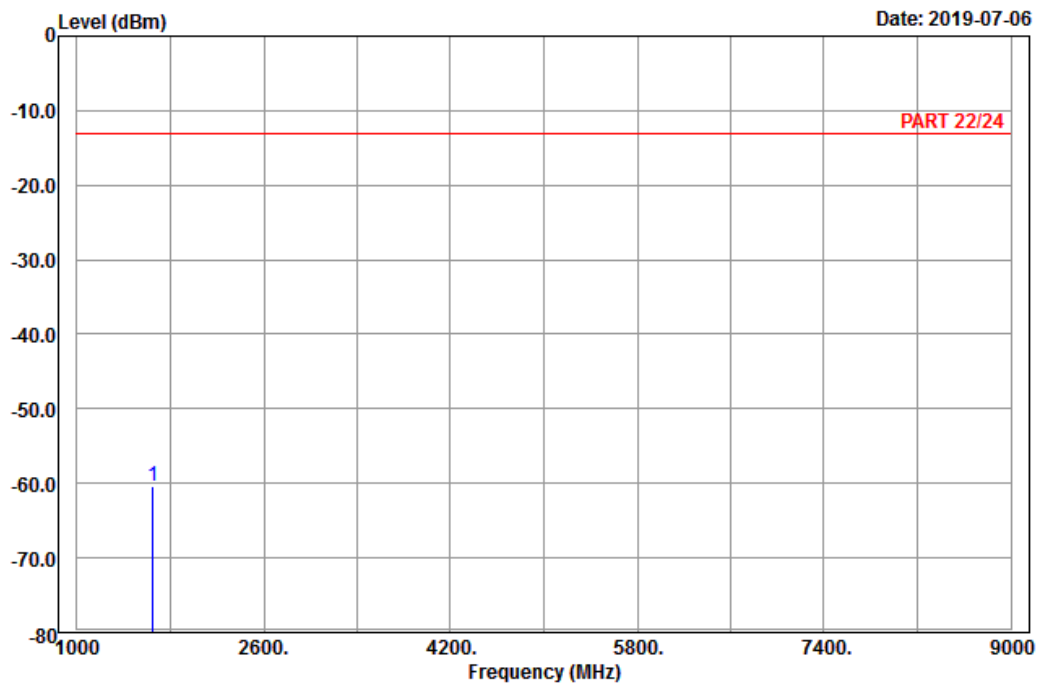

Site : 966 chamber 1  
 Condition: PART 22/24 Horizontal  
 Remark : LTE\_Band 26\_Link\_CH26797  
 Tested by: Karl Lee

	Read	Limit	Over	
Freq	Level	Level	Factor	Line
MHz	dBm	dBm	dB	dBm
1 pp 1649.40	-60.33	-68.06	7.73	-13.00
				-47.33 Peak



Bureau Veritas Consumer Products Services Ltd., Taoyuan Branch

A D T

Data: 6

Date: 2019-07-06

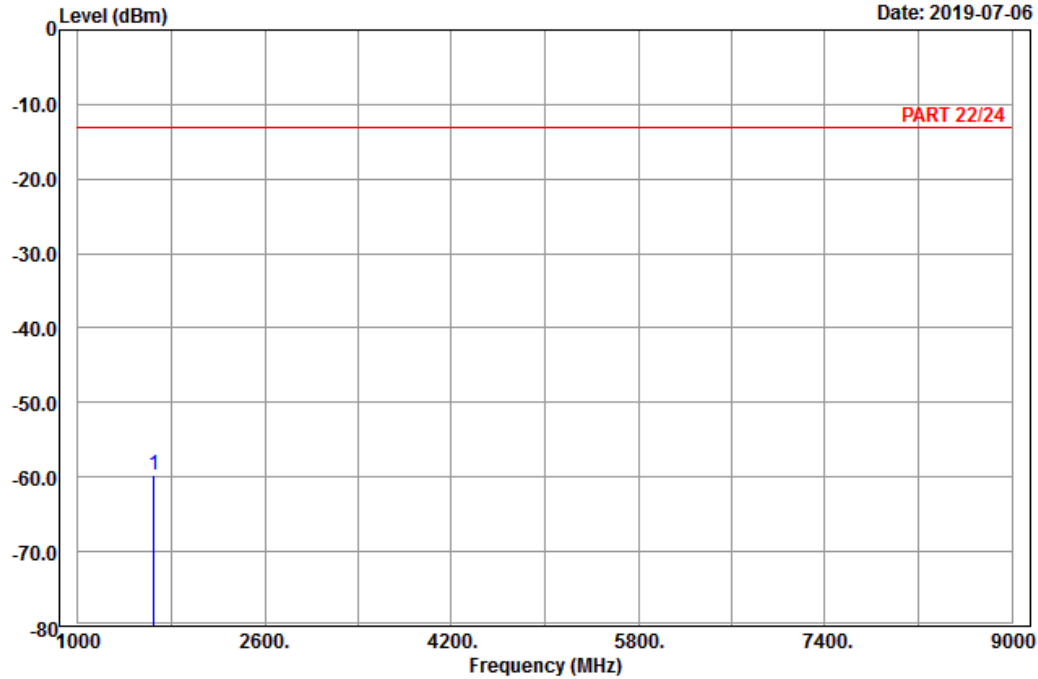

Site : 966 chamber 1  
 Condition: PART 22/24 Vertical  
 Remark : LTE\_Band 26\_Link\_CH26797  
 Tested by: Karl Lee

	Read	Limit	Over	
Freq	Level	Level	Factor	Line
MHz	dBm	dBm	dB	dBm
1 pp 1649.40	-59.75	-67.48	7.73	-13.00
				-46.75
				Peak



Middle Channel



Bureau Veritas Consumer Products Services Ltd., Taoyuan Branch

A D T

Data: 5

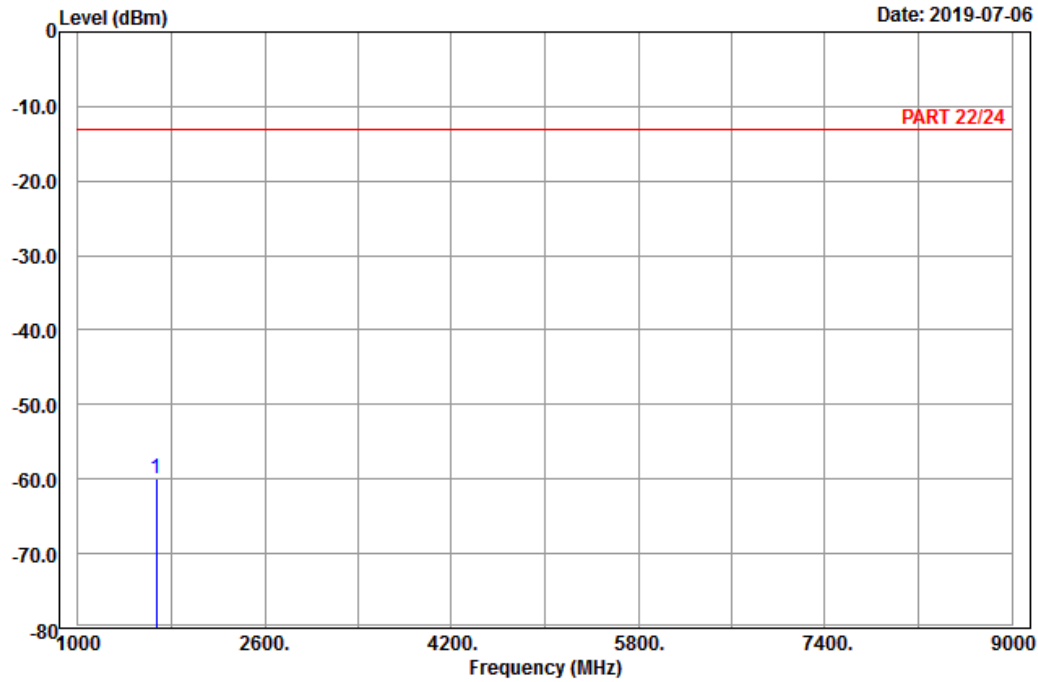

Site : 966 chamber 1  
 Condition: PART 22/24 Horizontal  
 Remark : LTE\_Band 26\_Link\_CH26915  
 Tested by: Karl Lee

	Freq	Level	Read Level	Factor	Limit Line	Over Limit	Remark
	MHz	dBm	dBm	dB	dBm	dB	
1	pp 1673.00	-60.02	-67.93	7.91	-13.00	-47.02	Peak



Bureau Veritas Consumer Products Services Ltd., Taoyuan Branch

A D T

Data: 6

Date: 2019-07-06

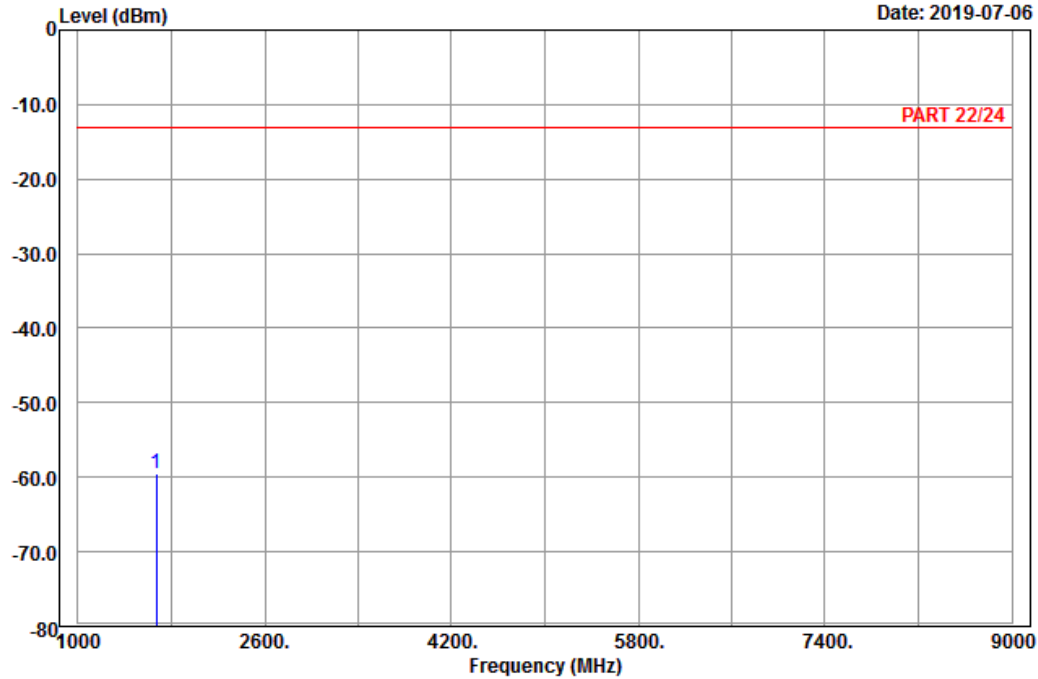

Site : 966 chamber 1  
 Condition: PART 22/24 Vertical  
 Remark : LTE\_Band 26\_Link\_CH26915  
 Tested by: Karl Lee

	Freq	Level	Read Level	Factor	Limit Line	Over Limit	Remark
	MHz	dBm	dBm	dB	dBm	dB	
1 pp	1673.00	-59.55	-67.46	7.91	-13.00	-46.55	Peak

# High Channel



Bureau Veritas Consumer Products Services Ltd., Taoyuan Branch

A D T

Data: 5

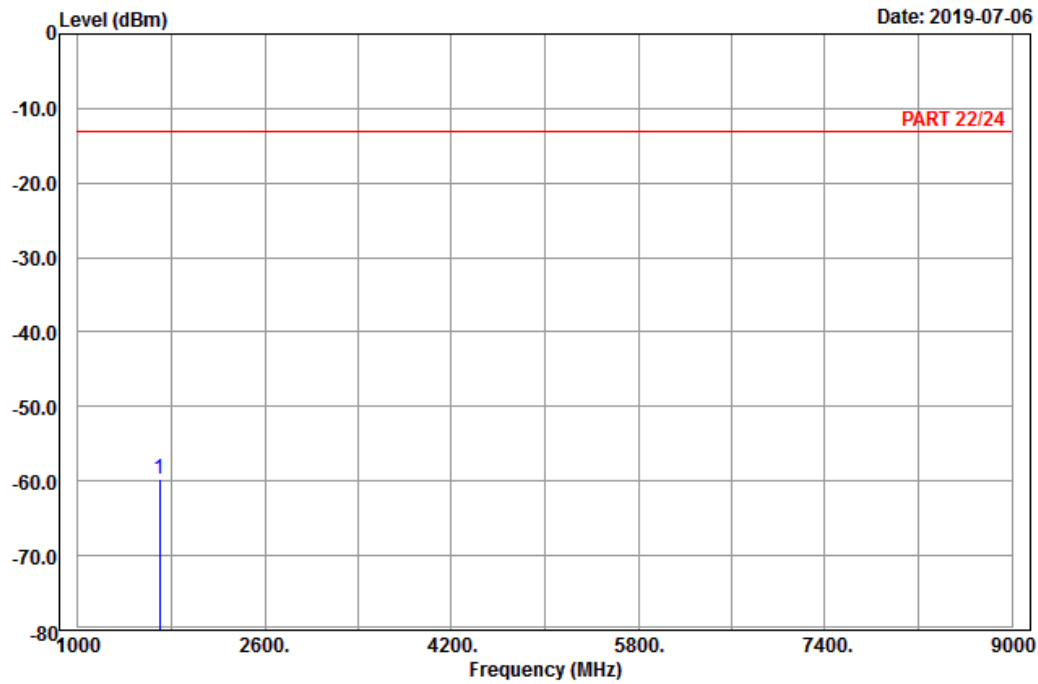

Site : 966 chamber 1  
 Condition: PART 22/24 Horizontal  
 Remark : LTE\_Band 26\_Link\_CH27033  
 Tested by: Karl Lee

Freq	Level	Read Level	Factor	Limit Line	Over Limit	Remark
MHz	dBm	dBm	dB	dBm	dB	
1 pp 1696.60	-59.67	-67.81	8.14	-13.00	-46.67	Peak



Bureau Veritas Consumer Products Services Ltd., Taoyuan Branch

A D T

Data: 6

Date: 2019-07-06

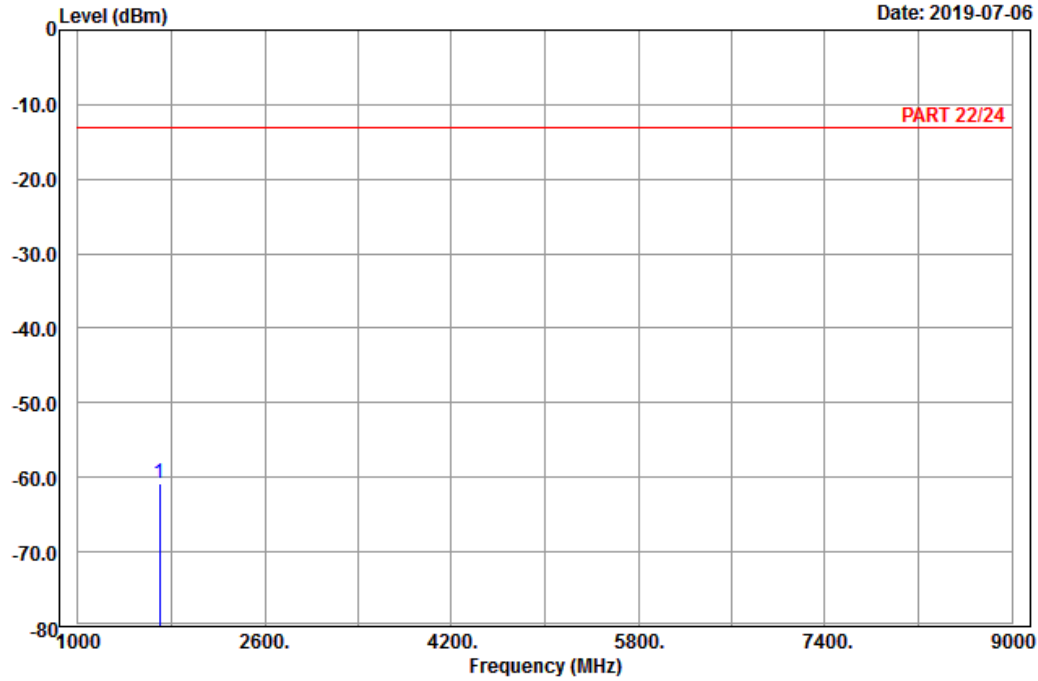

Site : 966 chamber 1  
 Condition: PART 22/24 Vertical  
 Remark : LTE\_Band 26\_Link\_CH27033  
 Tested by: Karl Lee

	Freq	Level	Read Level	Factor	Limit Line	Over Limit	Remark
	MHz	dBm	dBm	dB	dBm	dB	
1 pp	1696.60	-60.91	-69.05	8.14	-13.00	-47.91	Peak

Channel Bandwidth: 5 MHz / QPSK  
 Low Channel



Bureau Veritas Consumer Products Services Ltd., Taoyuan Branch

A D T

Data: 5

Date: 2019-07-06

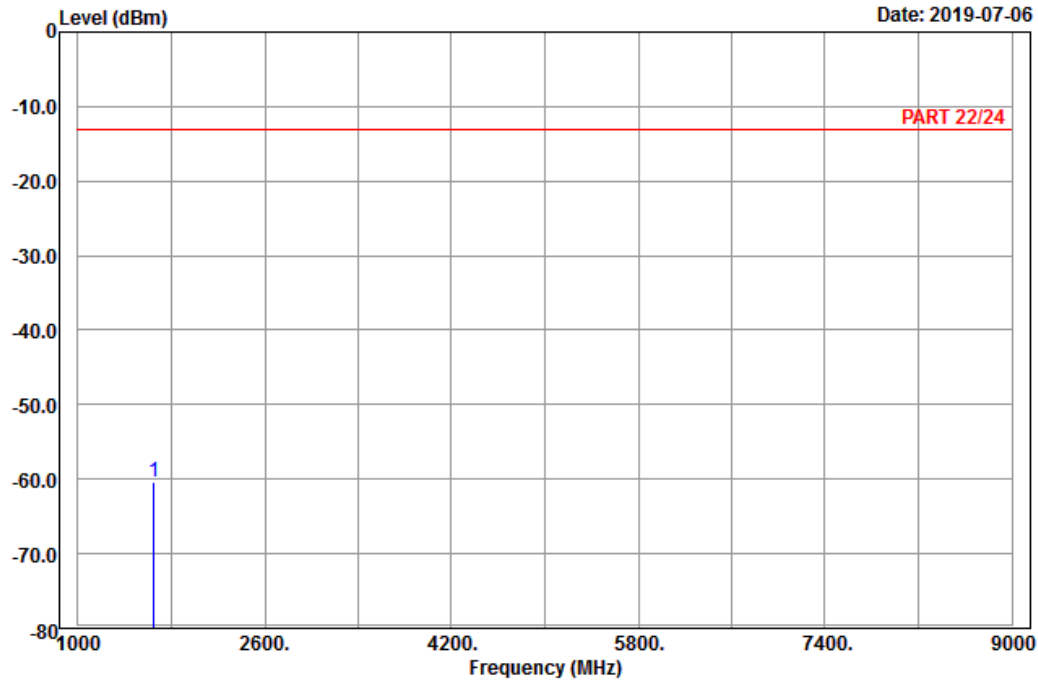

Site : 966 chamber 1  
 Condition: PART 22/24 Horizontal  
 Remark : LTE\_Band 26\_Link\_CH26815  
 Tested by: Karl Lee

	Freq	Level	Read Level	Factor	Limit Line	Over Limit	Remark
	MHz	dBm	dBm	dB	dBm	dB	
1	pp 1653.00	-60.47	-68.20	7.73	-13.00	-47.47	Peak



Bureau Veritas Consumer Products Services Ltd., Taoyuan Branch

A D T

Data: 6

Date: 2019-07-06

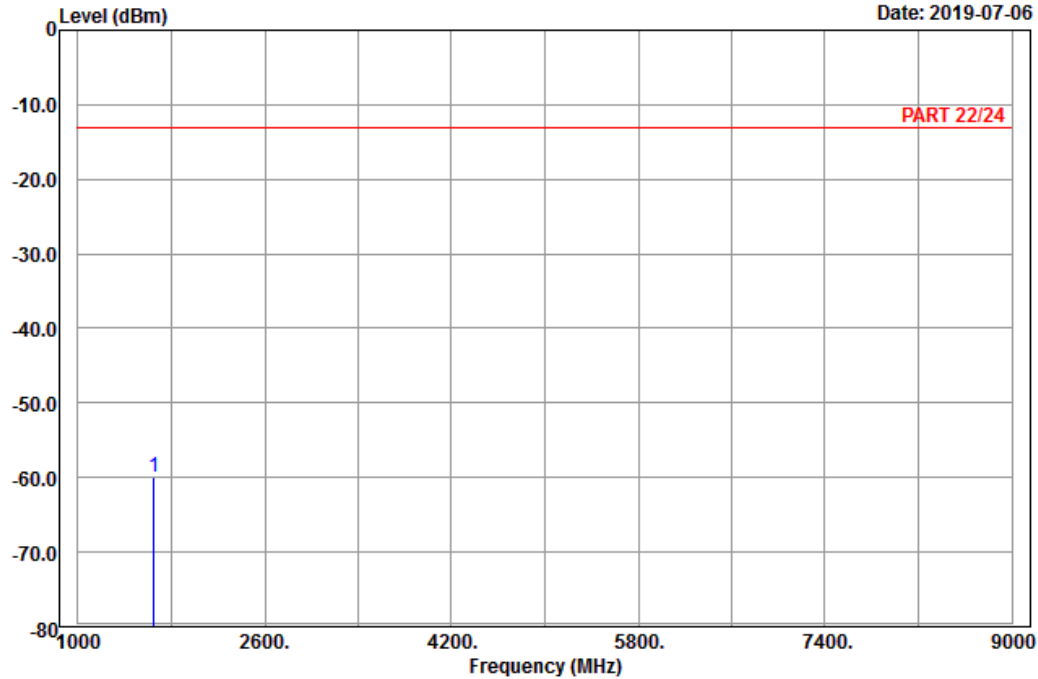

Site : 966 chamber 1  
 Condition: PART 22/24 Vertical  
 Remark : LTE\_Band 26\_Link\_CH26815  
 Tested by: Karl Lee

	Freq	Level	Read Level	Factor	Limit Line	Over Limit	Remark
	MHz	dBm	dBm	dB	dBm	dB	
1 pp	1653.00	-59.92	-67.65	7.73	-13.00	-46.92	Peak

Middle Channel



Bureau Veritas Consumer Products Services Ltd., Taoyuan Branch

A D T

Data: 5

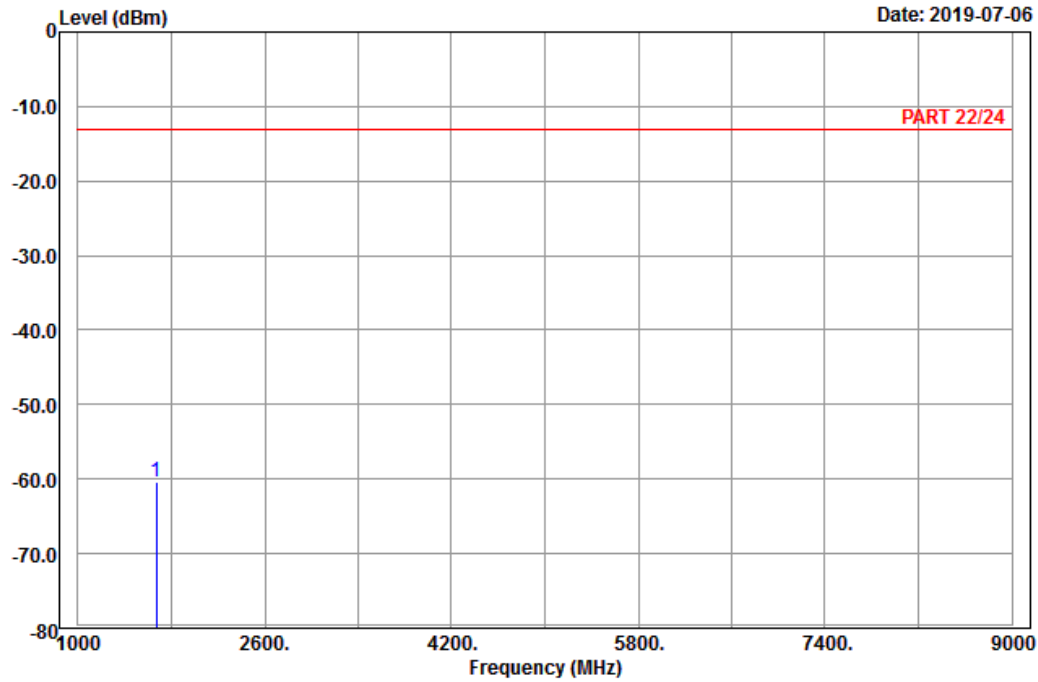

Site : 966 chamber 1  
 Condition: PART 22/24 Horizontal  
 Remark : LTE\_Band 26\_Link\_CH26915  
 Tested by: Karl Lee

	Freq	Level	Read Level	Factor	Limit Line	Over Limit	Remark
	MHz	dBm	dBm	dB	dBm	dB	
1	pp 1673.00	-60.38	-68.29	7.91	-13.00	-47.38	Peak



Bureau Veritas Consumer Products Services Ltd., Taoyuan Branch

A D T

Data: 6

Date: 2019-07-06

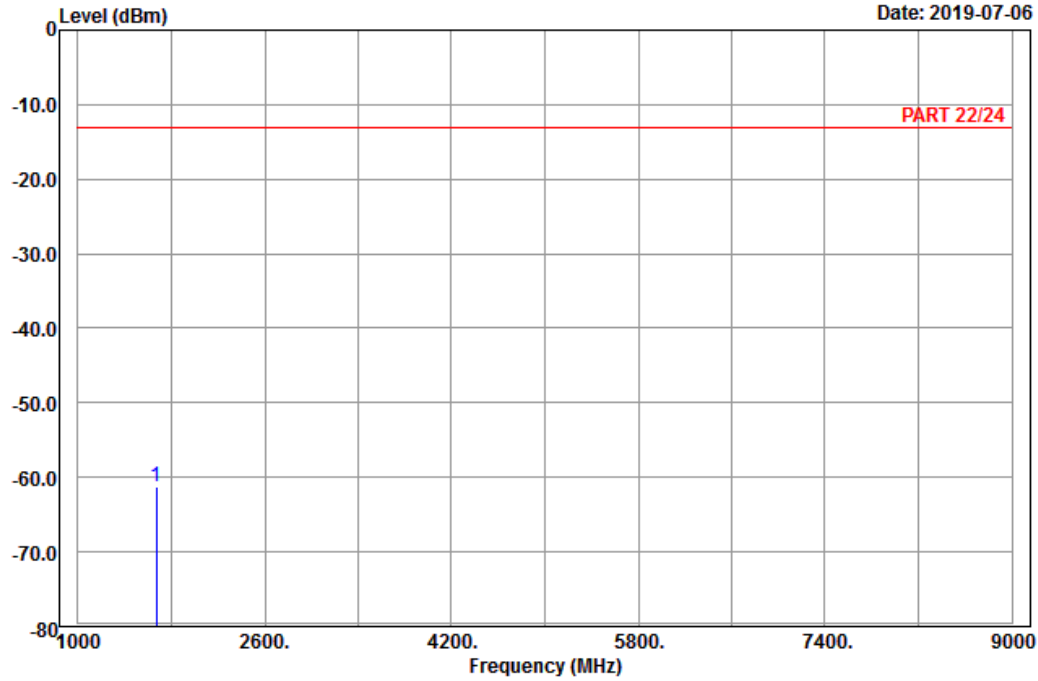

Site : 966 chamber 1  
 Condition: PART 22/24 Vertical  
 Remark : LTE\_Band 26\_Link\_CH26915  
 Tested by: Karl Lee

	Freq	Level	Read Level	Factor	Limit Line	Over Limit	Remark
	MHz	dBm	dBm	dB	dBm	dB	
1 pp	1673.00	-61.22	-69.13	7.91	-13.00	-48.22	Peak



# High Channel



Bureau Veritas Consumer Products Services Ltd., Taoyuan Branch

A D T

Data: 5

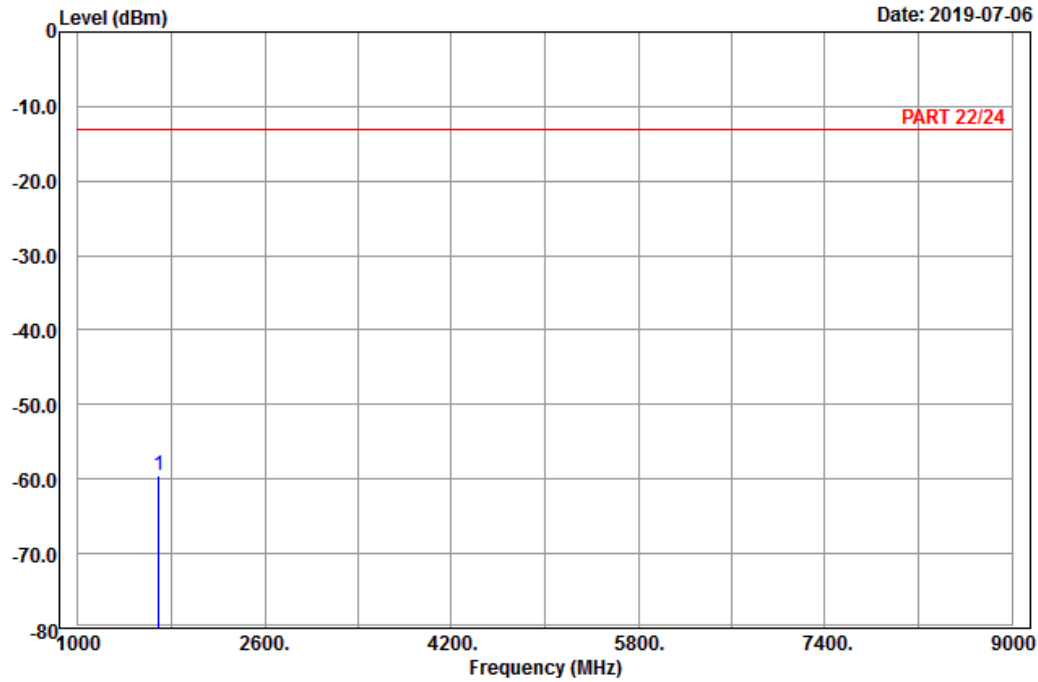

Site : 966 chamber 1  
 Condition: PART 22/24 Horizontal  
 Remark : LTE\_Band 26\_Link\_CH27015  
 Tested by: Karl Lee

	Freq	Level	Read Level	Factor	Limit Line	Over Limit	Remark
	MHz	dBm	dBm	dB	dBm	dB	
1	pp 1693.00	-59.59	-67.61	8.02	-13.00	-46.59	Peak



Bureau Veritas Consumer Products Services Ltd., Taoyuan Branch

A D T

Data: 6

Date: 2019-07-06

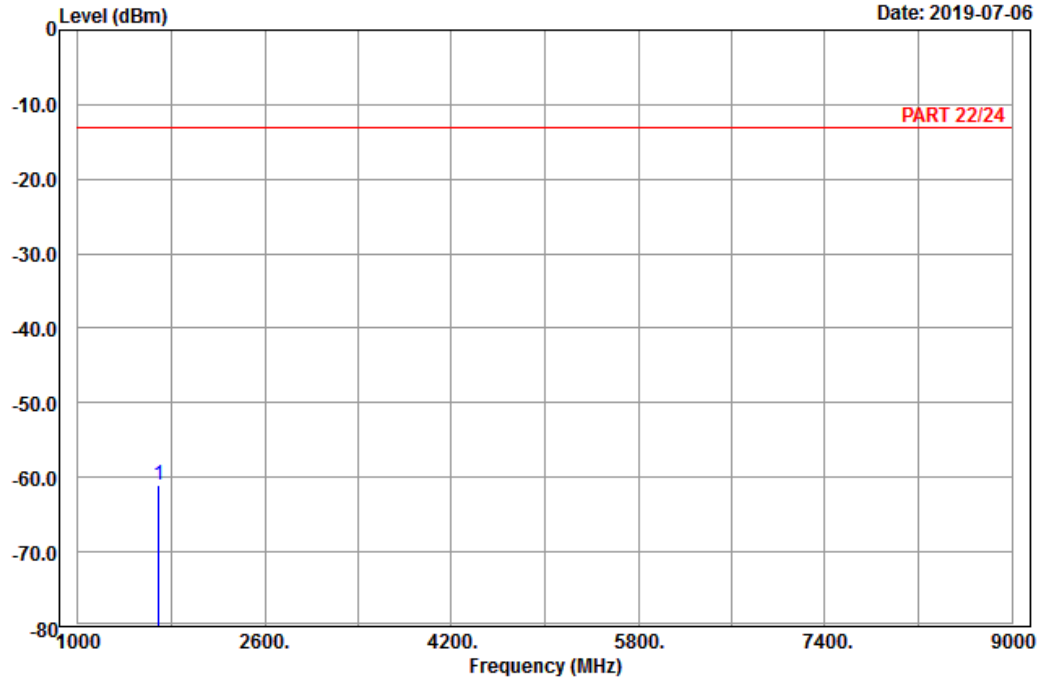

Site : 966 chamber 1  
 Condition: PART 22/24 Vertical  
 Remark : LTE\_Band 26\_Link\_CH27015  
 Tested by: Karl Lee

	Freq	Level	Read Level	Factor	Limit Line	Over Limit	Remark
	MHz	dBm	dBm	dB	dBm	dB	
1 pp	1693.00	-60.96	-68.98	8.02	-13.00	-47.96	Peak

Channel Bandwidth: 15 MHz / QPSK  
Low Channel



Bureau Veritas Consumer Products Services Ltd., Taoyuan Branch

A D T

Data: 5

Date: 2019-07-06

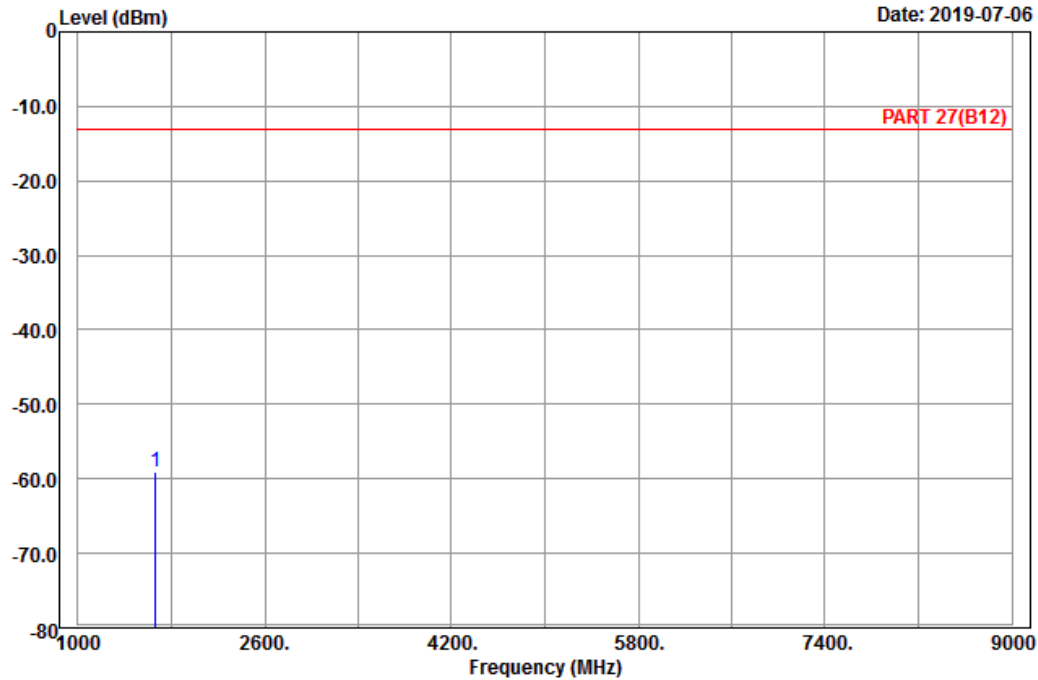

Site : 966 chamber 1  
Condition: PART 27(B12) Horizontal  
Remark : LTE\_Band 26\_Link\_CH26865  
Tested by: Karl Lee

	Freq	Level	Read Level	Factor	Limit Line	Over Limit	Remark
	MHz	dBm	dBm	dB	dBm	dB	
1	pp 1663.00	-59.09	-67.00	7.91	-13.00	-46.09	Peak



Bureau Veritas Consumer Products Services Ltd., Taoyuan Branch

A D T

Data: 6

Date: 2019-07-06

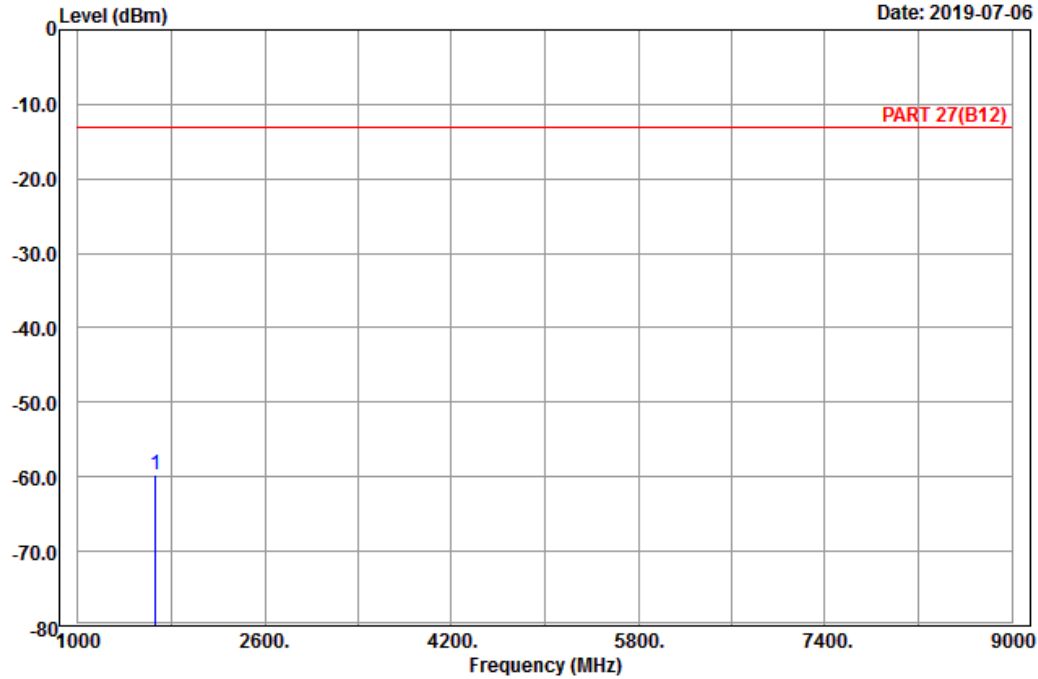

Site : 966 chamber 1  
 Condition: PART 27(B12) Vertical  
 Remark : LTE\_Band 26\_Link\_CH26865  
 Tested by: Karl Lee

	Freq	Level	Read Level	Factor	Limit Line	Over Limit	Remark
	MHz	dBm	dBm	dB	dBm	dB	
1 pp	1663.00	-59.66	-67.57	7.91	-13.00	-46.66	Peak

Middle Channel



Bureau Veritas Consumer Products Services Ltd., Taoyuan Branch

A D T

Data: 9

Date: 2019-07-06

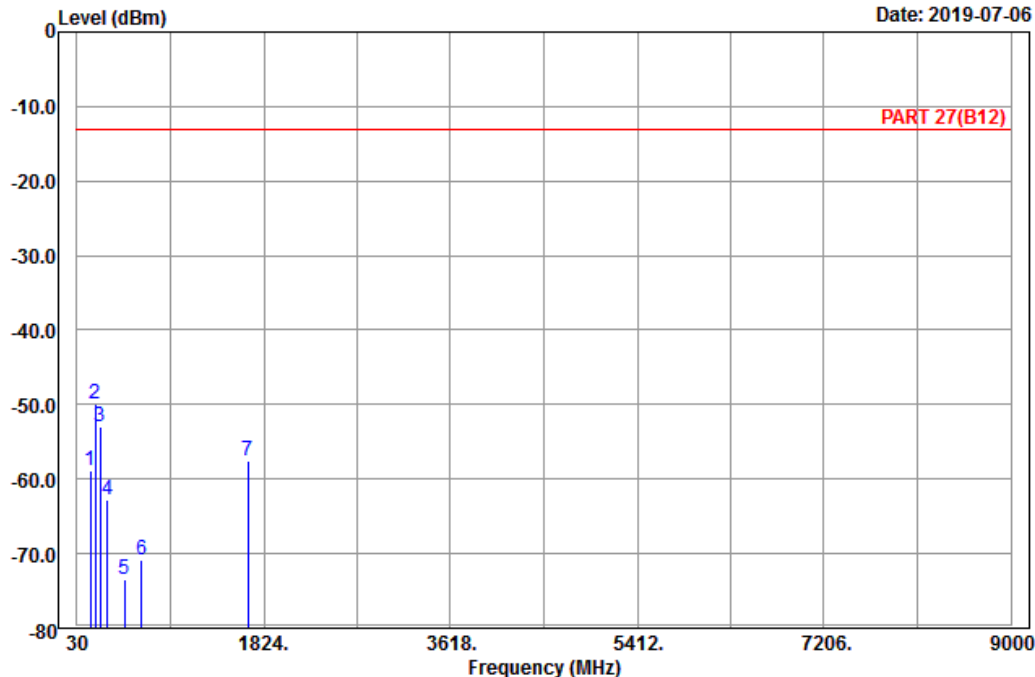

Site : 966 chamber 1  
 Condition: PART 27(B12) Horizontal  
 Remark : LTE\_Band 26\_Link\_CH26915  
 Tested by: Karl Lee

	Freq	Level	Read Level	Factor	Limit Line	Over Limit	Remark
	MHz	dBm	dBm	dB	dBm	dB	
1	162.57	-58.90	-51.52	-7.38	-13.00	-45.90	Peak
2	206.04	-49.99	-43.88	-6.11	-13.00	-36.99	Peak
3	250.32	-53.00	-47.49	-5.51	-13.00	-40.00	Peak
4	321.70	-62.80	-57.10	-5.70	-13.00	-49.80	Peak
5	484.10	-73.51	-68.70	-4.81	-13.00	-60.51	Peak
6	653.50	-70.84	-70.69	-0.15	-13.00	-57.84	Peak
7	1673.00	-57.44	-65.35	7.91	-13.00	-44.44	Peak



Bureau Veritas Consumer Products Services Ltd., Taoyuan Branch

A D T

Data: 10

Date: 2019-07-06

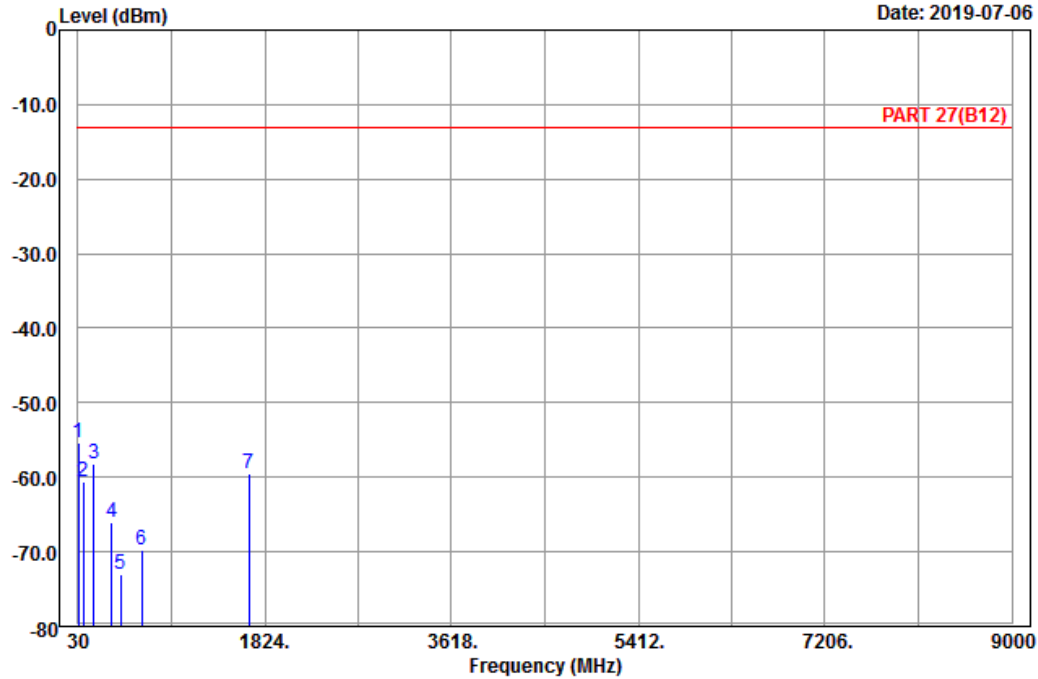

Site : 966 chamber 1  
 Condition: PART 27(B12) Vertical  
 Remark : LTE\_Band 26\_Link\_CH26915  
 Tested by: Karl Lee

	Freq	Level	Read Level	Factor	Limit Line	Over Limit	Remark
	MHz	dBm	dBm	dB	dBm	dB	
1 pp	33.51	-55.38	-44.40	-10.98	-13.00	-42.38	Peak
2	79.68	-60.57	-48.72	-11.85	-13.00	-47.57	Peak
3	185.52	-58.22	-52.57	-5.65	-13.00	-45.22	Peak
4	350.40	-65.95	-60.57	-5.38	-13.00	-52.95	Peak
5	441.40	-73.00	-69.35	-3.65	-13.00	-60.00	Peak
6	643.70	-69.77	-69.70	-0.07	-13.00	-56.77	Peak
7	1673.00	-59.47	-67.38	7.91	-13.00	-46.47	Peak

High Channel



Bureau Veritas Consumer Products Services Ltd., Taoyuan Branch

A D T

Data: 5

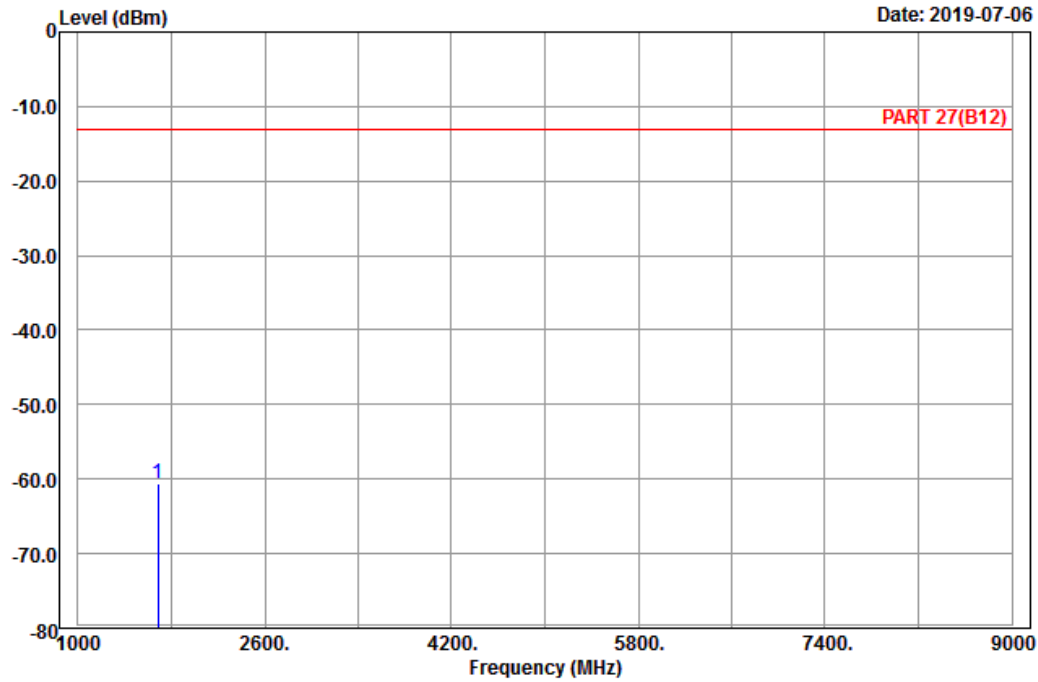

Site : 966 chamber 1  
 Condition: PART 27(B12) Horizontal  
 Remark : LTE\_Band 26\_Link\_CH26965  
 Tested by: Karl Lee

	Freq	Level	Read Level	Factor	Limit Line	Over Limit	Remark
	MHz	dBm	dBm	dB	dBm	dB	
1	pp 1683.00	-60.60	-68.62	8.02	-13.00	-47.60	Peak



Bureau Veritas Consumer Products Services Ltd., Taoyuan Branch

A D T

Data: 6

Date: 2019-07-06

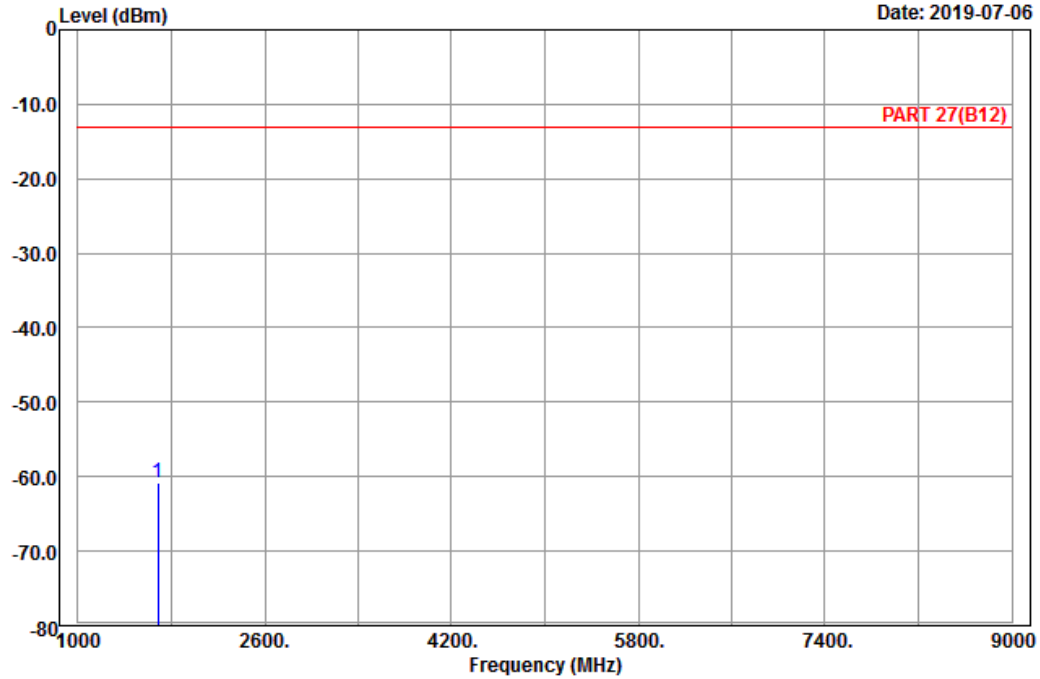

Site : 966 chamber 1  
 Condition: PART 27(B12) Vertical  
 Remark : LTE\_Band 26\_Link\_CH26965  
 Tested by: Karl Lee

	Freq	Level	Read Level	Factor	Limit Line	Over Limit	Remark
	MHz	dBm	dBm	dB	dBm	dB	
1 pp	1683.00	-60.79	-68.81	8.02	-13.00	-47.79	Peak



## 5 Pictures of Test Arrangements

Please refer to the attached file (Test Setup Photo).

## Appendix – Information of the Testing Laboratories

We, Bureau Veritas Consumer Products Services (H.K.) Ltd., Taoyuan Branch, were founded in 1988 to provide our best service in EMC, Radio, Telecom and Safety consultation. Our laboratories are FCC recognized accredited test firms and accredited according to ISO/IEC 17025.

If you have any comments, please feel free to contact us at the following:

**Lin Kou EMC/RF Lab**

Tel: 886-2-26052180

Fax: 886-2-26051924

**Hsin Chu EMC/RF/Telecom Lab**

Tel: 886-3-6668565

Fax: 886-3-6668323

**Hwa Ya EMC/RF/Safety Lab**

Tel: 886-3-3183232

Fax: 886-3-3270892

**Email:** [service.adt@tw.bureauveritas.com](mailto:service.adt@tw.bureauveritas.com)

**Web Site:** [www.bureauveritas-adt.com](http://www.bureauveritas-adt.com)

The address and road map of all our labs can be found in our web site also.

--- END ---