

FCC Test Report

(PART 27)

Report No.: RF190212C40A-8

FCC ID: B32CM5P

Test Model: CM5P

Received Date: Feb. 13, 2019

Test Date: Feb. 23, 2019 ~ Mar. 07, 2019

Issued Date: Mar. 29, 2019

Applicant: Verifone, Inc.

Address: 1400 West Stanford Ranch Road Suite 200 Rocklin CA 95765 USA

Issued By: Bureau Veritas Consumer Products Services (H.K.) Ltd., Taoyuan Branch

Lab Address: No. 47-2, 14th Ling, Chia Pau Vil., Lin Kou Dist., New Taipei City, Taiwan (R.O.C)

Test Location (1): No. 19, Hwa Ya 2nd Rd, Wen Hwa Vil, Kwei Shan Dist., Taoyuan City 33383, Taiwan (R.O.C)

Test Location (2): B2F., No.215, Sec. 3, Beixin Rd., Xindian Dist., New Taipei City 231, Taiwan, R.O.C

**FCC Registration /
Designation Number:** 427177 / TW0011



This report is for your exclusive use. Any copying or replication of this report to or for any other person or entity, or use of our name or trademark, is permitted only with our prior written permission. This report sets forth our findings solely with respect to the test samples identified herein. The results set forth in this report are not indicative or representative of the quality or characteristics of the lot from which a test sample was taken or any similar or identical product unless specifically and expressly noted. Our report includes all of the tests requested by you and the results thereof based upon the information that you provided to us. You have 60 days from date of issuance of this report to notify us of any material error or omission caused by our negligence, provided, however, that such notice shall be in writing and shall specifically address the issue you wish to raise. A failure to raise such issue within the prescribed time shall constitute your unqualified acceptance of the completeness of this report, the tests conducted and the correctness of the report contents. Unless specific mention, the uncertainty of measurement has been explicitly taken into account to declare the compliance or non-compliance to the specification. The report must not be used by the client to claim product certification, approval, or endorsement by TAF or any government agencies

Table of Contents

Release Control Record	4
1 Certificate of Conformity	5
2 Summary of Test Results	6
2.1 Measurement Uncertainty	6
2.2 Test Site and Instruments	7
3 General Information	9
3.1 General Description of EUT	9
3.2 Configuration of System under Test	10
3.2.1 Description of Support Units	10
3.3 Test Mode Applicability and Tested Channel Detail	11
3.4 EUT Operating Conditions	12
3.5 General Description of Applied Standards	12
4 Test Types and Results	13
4.1 Output Power Measurement	13
4.1.1 Limits of Output Power Measurement	13
4.1.2 Test Procedures	13
4.1.3 Test Setup	14
4.1.4 Test Results	15
4.2 Modulation Characteristics Measurement	18
4.2.1 Limits of Modulation Characteristics	18
4.2.2 Test Setup	18
4.2.3 Test Procedure	18
4.2.4 Test Results	18
4.3 Frequency Stability Measurement	19
4.3.1 Limits of Frequency Stability Measurement	19
4.3.2 Test Procedure	19
4.3.3 Test Setup	19
4.3.4 Test Results	20
4.4 Occupied Bandwidth Measurement	24
4.4.1 Limits of Occupied Bandwidth Measurement	24
4.4.2 Test Procedure	24
4.4.3 Test Setup	24
4.4.4 Test Results	25
4.5 Out-of-Band Emissions Measurement	27
4.5.1 Limits of Out-of-Band Emissions Measurement	27
4.5.2 Test Setup	27
4.5.3 Test Procedures	27
4.5.4 Test Results	28
4.6 Peak to Average Ratio	36
4.6.1 Limits of Peak to Average Ratio Measurement	36
4.6.2 Test Setup	36
4.6.3 Test Procedures	36
4.6.4 Test Results	37
4.7 Conducted Spurious Emissions	39
4.7.1 Limits of Conducted Spurious Emissions Measurement	39
4.7.2 Test Setup	39
4.7.3 Test Procedure	39
4.7.4 Test Results	40
4.8 Radiated Emission Measurement	52
4.8.1 Limits of Radiated Emission Measurement	52
4.8.2 Test Procedure	52
4.8.3 Deviation from Test Standard	52
4.8.4 Test Setup	53

4.8.5 Test Results	54
5 Pictures of Test Arrangements.....	66
Appendix – Information of the Testing Laboratories	67

Release Control Record

Issue No.	Description	Date Issued
RF190212C40A-8	Original Release	Mar. 29, 2019

1 Certificate of Conformity

Product: Point of Sale Terminal

Brand: Verifone

Test Model: CM5P

Sample Status: Identical Prototype

Applicant: Verifone, Inc.

Test Date: Feb. 23, 2019 ~ Mar. 07, 2019

Standards: FCC Part 27, Subpart C, M

The above equipment has been tested by **Bureau Veritas Consumer Products Services (H.K.) Ltd., Taoyuan Branch**, and found compliance with the requirement of the above standards. The test record, data evaluation & Equipment Under Test (EUT) configurations represented herein are true and accurate accounts of the measurements of the sample's RF characteristics under the conditions specified in this report.

Prepared by : , **Date:** Mar. 29, 2019
Ivonne Wu / Supervisor

Approved by : , **Date:** Mar. 29, 2019
Dylan Chiou / Project Engineer

2 Summary of Test Results

Applied Standard: FCC Part 27 & Part 2			
FCC Clause	Test Item	Result	Remarks
2.1046 27.50(h)(2)	Equivalent Isotropic Radiated Power	Pass	Meet the requirement of limit.
2.1047	Modulation Characteristics	Pass	Meet the requirement.
2.1055 27.54	Frequency Stability	Pass	Meet the requirement of limit.
2.1049 27.53(m)(6)	Occupied Bandwidth	Pass	Meet the requirement of limit.
--	Peak to Average Ratio	Pass	Meet the requirement of limit.
2.1051 27.53(m)(4)(6)	Out-of-Band Emissions Measurements	Pass	Meet the requirement of limit.
2.1051 27.53(m)(4)(6)	Conducted Spurious Emissions	Pass	Meet the requirement of limit.
2.1053 27.53(m)(4)(6)	Radiated Spurious Emissions	Pass	Meet the requirement of limit. Minimum passing margin is -22.58 dB at 5070.00 MHz.

Note: Determining compliance based on the results of the compliance measurement, not taking into account measurement instrumentation uncertainty.

2.1 Measurement Uncertainty

Where relevant, the following measurement uncertainty levels have been estimated for tests performed on the EUT as specified in CISPR 16-4-2:

Measurement	Frequency	Expanded Uncertainty (k=2) (±)
Radiated Emissions up to 1 GHz	9 kHz ~ 30 MHz	3.0400 dB
	30 MHz ~ 200 MHz	2.0153 dB
	200 MHz ~ 1000 MHz	2.0224 dB
Radiated Emissions above 1 GHz	1 GHz ~ 18 GHz	1.0121 dB
	18 GHz ~ 40 GHz	1.1508 dB

2.2 Test Site and Instruments

Description & Manufacturer	Model No.	Serial No.	Date of Calibration	Due Date of Calibration
Test Receiver Agilent Technologies	N9038A	MY52260177	Aug. 20, 2018	Aug. 19, 2019
Spectrum Analyzer ROHDE & SCHWARZ	FSV40	100980	Apr. 17, 2018	Apr. 16, 2019
Spectrum Analyzer ROHDE & SCHWARZ	FSW26	102023	Oct. 11, 2018	Oct. 10, 2019
BILOG Antenna SCHWARZBECK	VULB9168	9168-616	Nov. 27, 2018	Nov. 26, 2019
HORN Antenna ETS-Lindgren	3117	00143293	Nov. 25, 2018	Nov. 24, 2019
HORN Antenna SCHWARZBECK	BBHA 9170	9170-480	Nov. 25, 2018	Nov. 24, 2019
HORN Antenna SCHWARZBECK	BBHA 9120D	9120D-969	Nov. 25, 2018	Nov. 24, 2019
Fixed Attenuator Mini-Circuits	MDCS18N-10	MDCS18N-10-01	Apr. 16, 2018	Apr. 15, 2019
MXG Vector signal generator Agilent	N5182B	MY53050430	Nov. 19, 2018	Nov. 18, 2019
Preamplifier Agilent	310N	187226	Jun. 19, 2018	Jun. 18, 2019
Preamplifier Agilent	83017A	MY39501357	Jun. 19, 2018	Jun. 18, 2019
RF signal cable ETS-LINDGREN	5D-FB	Cable-CH1-01(RF C-SMS-100-SMS- 120+RFC-SMS-1 00-SMS-400)	Jun. 19, 2018	Jun. 18, 2019
RF signal cable ETS-LINDGREN	8D-FB	Cable-CH1-02(RF C-SMS-100-SMS- 24)	Jun. 19, 2018	Jun. 18, 2019
Boresight Antenna Fixture	FBA-01	FBA-SIP01	NA	NA
Software BV ADT	E3 8.130425b	NA	NA	NA
Antenna Tower MF	NA	NA	NA	NA
Turn Table MF	NA	NA	NA	NA
Antenna Tower & Turn Table Controller MF	MF-7802	NA	NA	NA
Radio Communication Analyzer Anritsu	MT8820C	6201300640	Aug. 16, 2017	Aug. 15, 2019
Temperature & Humidity Chamber	GTH-120-40-CP-AR	MAA1306-019	Sep. 05, 2018	Sep. 04, 2019
DC Power Supply Topward	33010D	807748	NA	NA

- Note:
1. The calibration interval of the above test instruments is 12 / 24 months and the calibrations are traceable to NML/ROC and NIST/USA.
 2. The test was performed in HsinTien Chamber 1.
 3. The horn antenna and preamplifier (model: 83017A) are used only for the measurement of emission frequency above 1 GHz if tested.
 4. The IC Site Registration No. is 7450I-1.

3 General Information

3.1 General Description of EUT

Product	Point of Sale Terminal	
Brand	Verifone	
Test Model	CM5P	
Status of EUT	Identical Prototype	
Power Supply Rating	5.0 Vdc (adapter or host equipment) 3.7 Vdc (Li-ion battery)	
Modulation Type	QPSK, 16QAM	
Frequency Range	LTE Band 7 (Channel Bandwidth: 5 MHz)	2502.5 ~ 2567.5 MHz
	LTE Band 7 (Channel Bandwidth: 10 MHz)	2505 ~ 2565 MHz
	LTE Band 7 (Channel Bandwidth: 15 MHz)	2507.5 ~ 2562.5 MHz
	LTE Band 7 (Channel Bandwidth: 20 MHz)	2510 ~ 2560 MHz
Max. EIRP Power	LTE Band 7 (Channel Bandwidth: 5 MHz)	277.40 mW
	LTE Band 7 (Channel Bandwidth: 10 MHz)	280.09 mW
	LTE Band 7 (Channel Bandwidth: 15 MHz)	282.36 mW
	LTE Band 7 (Channel Bandwidth: 20 MHz)	284.90 mW
Emission Designator	LTE Band 7 (Channel Bandwidth: 5 MHz)	4M50D7W
	LTE Band 7 (Channel Bandwidth: 10 MHz)	8M97G7D
	LTE Band 7 (Channel Bandwidth: 15 MHz)	13M5G7D
	LTE Band 7 (Channel Bandwidth: 20 MHz)	18M0D7W
Antenna Type	Fixed Internal Antenna with 0.9 dBi gain (Main) / 1.3 dBi gain (Aux.)	
Accessory Device	Refer to Note as below	
Data Cable Supplied	Refer to Note as below	

Note:

1. The EUT's accessories list refers to Ext. Pho.
2. The above EUT information is declared by manufacturer and for more detailed features description, please refers to the manufacturer's specifications or user's manual.

3.2 Configuration of System under Test

<Radiated Emission Test>

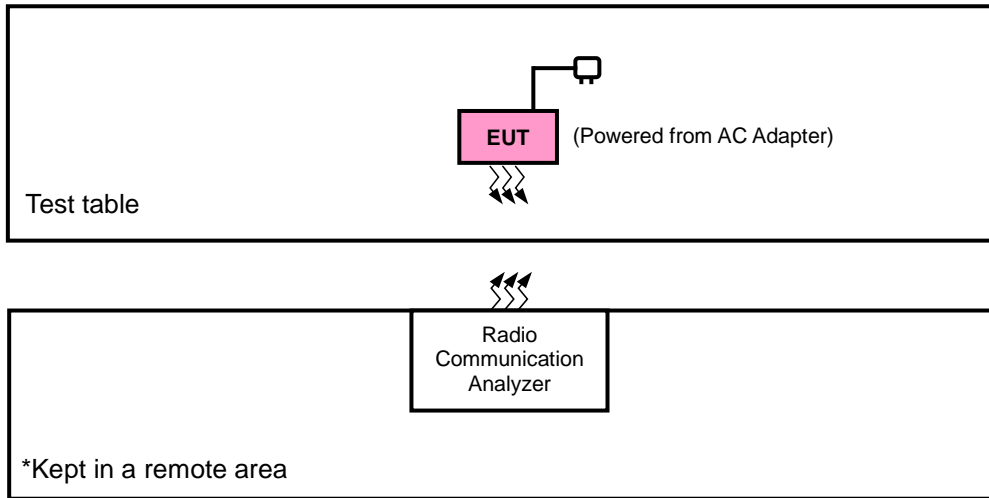

<E.I.R.P. Test>

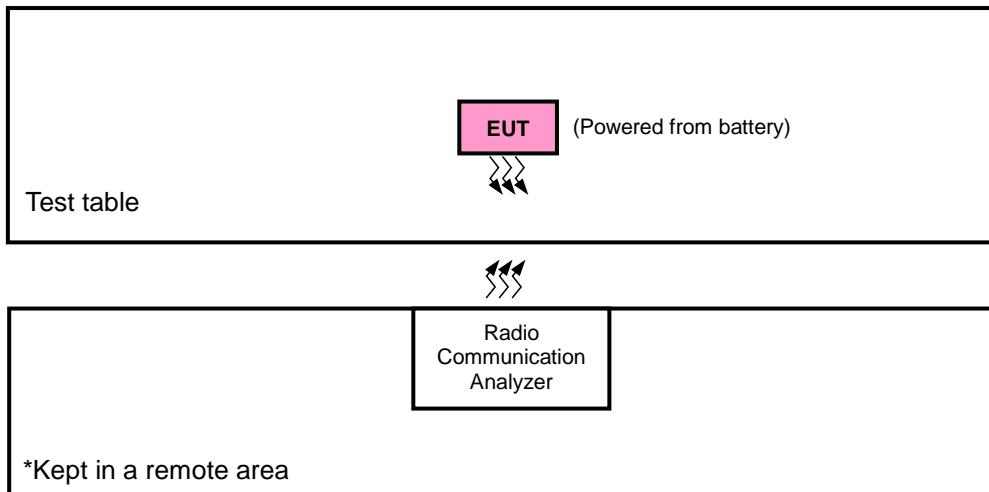

3.2.1 Description of Support Units

The EUT has been tested as an independent unit together with other necessary accessories or support units.

3.3 Test Mode Applicability and Tested Channel Detail

Pre-Scan has been conducted to determine the worst-case mode from all possible combinations between available modulations, data rates, XYZ axis, and antenna ports.

The worst case was found when positioned as the table below. Following channel(s) was (were) selected for the final test as listed below:

Band	EIRP	Radiated Emission
LTE Band 7	Z-plane	X-axis

LTE Band 7

EUT Configure Mode	Test Item	Available Channel	Tested Channel	Channel Bandwidth	Modulation	Mode
-	EIRP	20775 to 21425	20775, 21100, 21425	5 MHz	QPSK, 16QAM	1 RB / 0 RB Offset
		20800 to 21400	20800, 21100, 21400	10 MHz	QPSK, 16QAM	1 RB / 0 RB Offset
		20825 to 21375	20825, 21100, 21375	15 MHz	QPSK, 16QAM	1 RB / 0 RB Offset
		20850 to 21350	20850, 21100 21350	20 MHz	QPSK, 16QAM	1 RB / 0 RB Offset
-	Modulation Characteristics	20850 to 21350	21110	20 MHz	QPSK, 16QAM	100 RB / 0 RB Offset
-	Frequency Stability	20775 to 21425	20775, 21425	5 MHz	QPSK	1 RB / 0 RB Offset
		20800 to 21400	20800, 21400	10 MHz	QPSK	1 RB / 0 RB Offset
		20825 to 21375	20825, 21375	15 MHz	QPSK	1 RB / 0 RB Offset
		20850 to 21350	20850, 21350	20 MHz	QPSK	1 RB / 0 RB Offset
-	Occupied Bandwidth	20775 to 21425	20775, 21100, 21425	5 MHz	QPSK, 16QAM	25 RB / 0 RB Offset
		20800 to 21400	20800, 21100, 21400	10 MHz	QPSK, 16QAM	50 RB / 0 RB Offset
		20825 to 21375	20825, 21100, 21375	15 MHz	QPSK, 16QAM	75 RB / 0 RB Offset
		20850 to 21350	20850, 21100 21350	20 MHz	QPSK, 16QAM	100 RB / 0 RB Offset
-	Peak to Average Ratio	20775 to 21425	20775, 21100, 21425	5 MHz	QPSK, 16QAM	1 RB / 0 RB Offset
		20800 to 21400	20800, 21100, 21400	10 MHz	QPSK, 16QAM	1 RB / 0 RB Offset
		20825 to 21375	20825, 21100, 21375	15 MHz	QPSK, 16QAM	1 RB / 0 RB Offset
		20850 to 21350	20850, 21100 21350	20 MHz	QPSK, 16QAM	1 RB / 0 RB Offset
-	Out-of-Band Emissions	20775 to 21425	20775, 21425	5 MHz	QPSK, 16QAM	25 RB / 0 RB Offset
		20800 to 21400	20800, 21400	10 MHz	QPSK, 16QAM	50 RB / 0 RB Offset
		20825 to 21375	20825, 21375	15 MHz	QPSK, 16QAM	75 RB / 0 RB Offset
		20850 to 21350	20850, 21350	20 MHz	QPSK, 16QAM	100 RB / 0 RB Offset
-	Conducted Emission	20775 to 21425	20775, 21100, 21425	5 MHz	QPSK	1 RB / 0 RB Offset
		20800 to 21400	20800, 21100, 21400	10 MHz	QPSK	1 RB / 0 RB Offset
		20825 to 21375	20825, 21100, 21375	15 MHz	QPSK	1 RB / 0 RB Offset
		20850 to 21350	20850, 21100 21350	20 MHz	QPSK	1 RB / 0 RB Offset
-	Radiated Emission	20775 to 21425	20775, 21100, 21425	5 MHz	QPSK	1 RB / 0 RB Offset
		20850 to 21350	20850, 21100 21350	20 MHz	QPSK	1 RB / 0 RB Offset

Note:

1. This device was tested under all bandwidths, RB configurations and modulations. The worst case was found in QPSK modulation.
2. For radiated emission above 1 GHz, according to 3GPP 36.521 Section 6.6.3.1.4, choose the lowest, 5 MHz & highest channel bandwidth for final test.

Test Condition:

Test Item	Environmental Conditions	Input Power	Tested By
EIRP	25 deg. C, 65 % RH	3.7 Vdc	Karl Lee
Modulation Characteristics	25 deg. C, 65 % RH	3.7 Vdc	Getaz Yang
Frequency Stability	25 deg. C, 65 % RH	3.7 Vdc	Getaz Yang
Occupied Bandwidth	25 deg. C, 65 % RH	3.7 Vdc	Getaz Yang
Out-of-Band Emissions	25 deg. C, 65 % RH	3.7 Vdc	Getaz Yang
Peak to Average Ratio	25 deg. C, 65 % RH	3.7 Vdc	Getaz Yang
Conducted Emission	25 deg. C, 65 % RH	3.7 Vdc	Getaz Yang
Radiated Emission	25 deg. C, 65 % RH	120 Vac, 60 Hz	Karl Lee

3.4 EUT Operating Conditions

The EUT makes a call to the communication simulator. The communication simulator station system controlled a EUT to export maximum output power under transmission mode and specific channel frequency

3.5 General Description of Applied Standards

The EUT is a RF Product. According to the specifications of the manufacturer, it must comply with the requirements of the following standards:

FCC 47 CFR Part 2

FCC 47 CFR Part 27

KDB 971168 D01 Power Meas License Digital Systems v03r01

ANSI/TIA/EIA-603-E 2016

ANSI 63.26-2015

Note: All test items have been performed and recorded as per the above standards.

4 Test Types and Results

4.1 Output Power Measurement

4.1.1 Limits of Output Power Measurement

The radiated peak output power shall be according to the specific rule Part 27.50(h)(2) that “Mobile stations are limited to 2.0 watts EIRP. All user stations are limited to 2 watts transmitter output power” and 27.50(i) specific that “Peak transmit power must be measure over any interval of continuous transmission using instrumentation calibration in terms of rms-equivalent voltage.”

4.1.2 Test Procedures

EIRP Measurement:

- a. All measurements were done at low, middle and high operational frequency range. RBW and VBW is 10 MHz for LTE mode.
- b. Substitution method is used for E.I.R.P measurement. In the semi-anechoic chamber, EUT placed on the 0.8 m (below or equal 1 GHz) and/or 1.5 m (above 1 GHz) height of Turn Table, rotated the table around 360 degrees to search the maximum radiation power and receiver antenna shall be rotated vertical and horizontal polarization and moved height from 1 m to 4 m to find the maximum polar radiated power. The “Read Value” is the spectrum reading the maximum power value.
- c. The substitution horn antenna is substituted for EUT at the same position and signals generator export the CW signal to the substitution antenna via a tx cable. Rotated the Turn Table and moved receiving antenna to find the maximum radiation power. Adjust output power level of S.G to get a Value of spectrum reading equal to “Read Value“ of step b. Record the power level of S.G.
- d. $EIRP = \text{Output power level of S.G} - \text{TX cable loss} + \text{Antenna gain of substitution horn}.$

Conducted Power Measurement:

- a. The EUT was set up for the maximum power with LTE link data modulation and link up with simulator.
- b. Set the EUT to transmit under low, middle and high channel and record the power level shown on simulator.

4.1.3 Test Setup

**EIRP / ERP Measurement:
<Radiated Emission below or equal 1 GHz>**

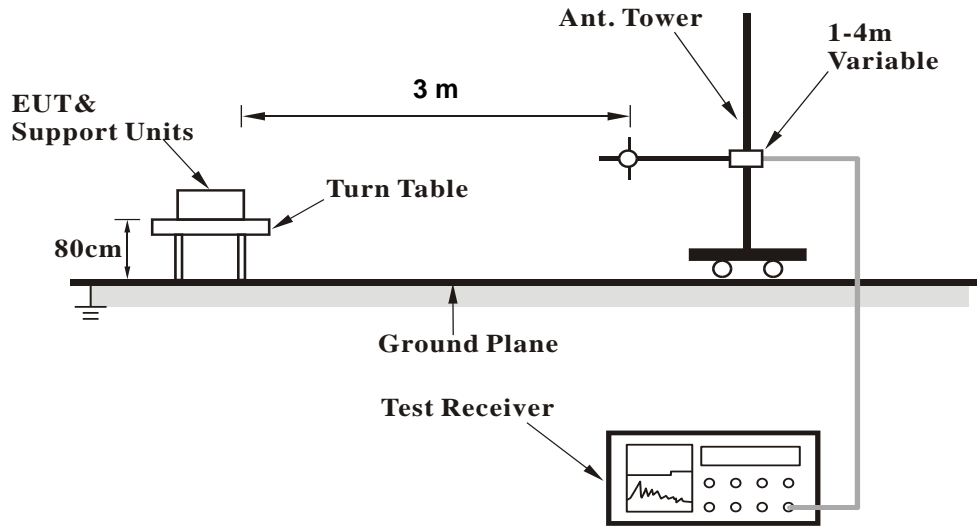

<Radiated Emission above 1 GHz>

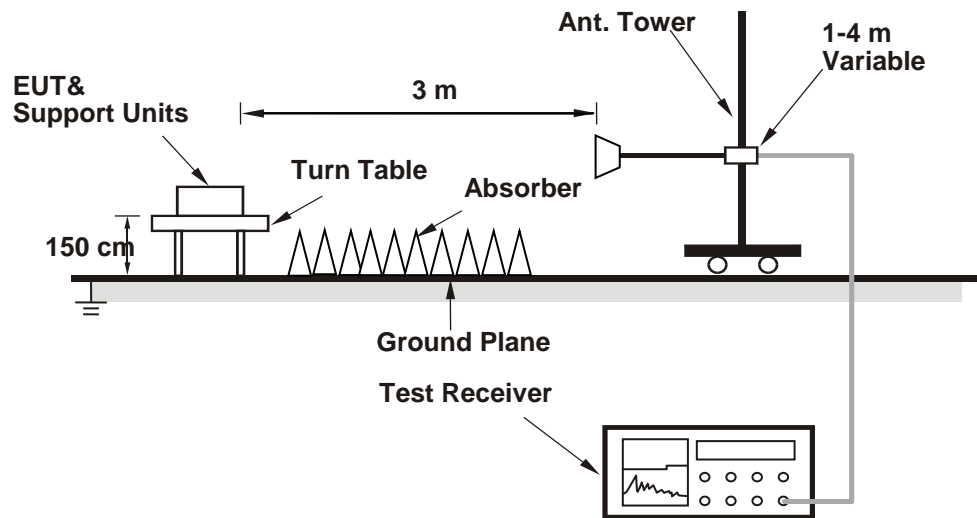

For the actual test configuration, please refer to the attached file (Test Setup Photo).

Conducted Power Measurement:



4.1.4 Test Results

Conducted Output Power (dBm)

LTE Band 7															
BW	MCS Index	RB Size	RB Offset	Low	Mid	High	3GPP MPR (dB)	BW	MCS Index	RB Size	RB Offset	Low	Mid	High	3GPP MPR (dB)
				20850	21100	21350						20825	21100	21375	
		Channel Frequency (MHz)	2510.0	2535.0	2560.0	Channel Frequency (MHz)	2507.5			2535.0	2562.5				
20M	QPSK	1	0	23.16	23.48	23.38	0	15M	QPSK	1	0	23.07	23.47	23.33	0
		1	50	23.10	23.00	23.21	0			1	37	23.09	22.94	23.11	0
		1	99	23.12	23.15	23.24	0			1	74	23.11	23.13	23.21	0
		50	0	22.11	22.24	22.23	1			36	0	22.03	22.24	22.20	1
		50	25	22.13	22.10	22.05	1			36	19	22.13	22.07	21.95	1
		50	50	22.14	22.13	22.03	1			36	39	22.06	22.09	22.03	1
		100	0	22.26	22.16	22.10	1			75	0	22.25	22.09	22.01	1
	16QAM	1	0	21.77	21.68	21.89	1		16QAM	1	0	21.70	21.65	21.82	1
		1	50	21.93	21.89	21.95	1			1	37	21.92	21.86	21.86	1
		1	99	21.95	21.95	21.97	1			1	74	21.89	21.89	21.93	1
		50	0	20.64	20.55	20.83	2			36	0	20.57	20.50	20.77	2
		50	25	20.72	20.63	20.91	2			36	19	20.63	20.59	20.88	2
		50	50	20.74	20.65	20.93	2			36	39	20.71	20.62	20.83	2
		100	0	20.57	20.48	20.76	2			75	0	20.56	20.39	20.69	2
BW	MCS Index	RB Size	RB Offset	Low	Mid	High	3GPP MPR (dB)	BW	MCS Index	RB Size	RB Offset	Low	Mid	High	3GPP MPR (dB)
				20800	21100	21400						20775	21100	21425	
		Channel Frequency (MHz)	2505.0	2535.0	2565.0	Channel Frequency (MHz)	2502.5			2535.0	2567.5				
10M	QPSK	1	0	22.98	23.25	23.16	0	5M	QPSK	1	0	22.92	23.30	23.21	0
		1	24	22.96	22.93	22.99	0			1	12	22.98	22.77	22.93	0
		1	49	22.98	23.09	23.09	0			1	24	22.97	23.04	23.07	0
		25	0	21.95	22.12	22.20	1			12	0	21.98	22.09	22.17	1
		25	12	21.90	21.92	21.84	1			12	6	21.92	22.04	21.90	1
		25	25	22.08	21.99	22.01	1			12	13	21.97	21.98	21.84	1
		50	0	22.11	22.07	21.97	1			25	0	22.04	22.09	21.95	1
	16QAM	1	0	21.61	21.49	21.66	1		16QAM	1	0	21.68	21.59	21.79	1
		1	24	21.80	21.77	21.76	1			1	12	21.85	21.73	21.84	1
		1	49	21.75	21.83	21.84	1			1	24	21.93	21.93	21.78	1
		25	0	20.52	20.38	20.76	2			12	0	20.52	20.48	20.69	2
		25	12	20.61	20.61	20.76	2			12	6	20.63	20.51	20.81	2
		25	25	20.56	20.44	20.77	2			12	13	20.62	20.61	20.92	2
		50	0	20.52	20.43	20.54	2			25	0	20.37	20.29	20.66	2

EIRP Power (dBm)

LTE Band 7							
Channel Bandwidth: 5 MHz / QPSK							
Plane	Channel	Frequency (MHz)	Reading (dBm)	Correction Factor (dB)	EIRP (dBm)	EIRP (mW)	Polarization (H/V)
Z	20775	2502.5	-20.12	44.24	24.12	258.11	H
	21100	2535.0	-19.86	44.20	24.34	271.46	
	21425	2567.5	-20.37	44.80	24.43	277.40	
	20775	2502.5	-23.05	44.19	21.14	130.05	V
	21100	2535.0	-22.73	44.09	21.36	136.71	
	21425	2567.5	-23.01	44.50	21.49	140.90	
Channel Bandwidth: 5 MHz / 16QAM							
Z	20775	2502.5	-21.13	44.24	23.11	204.55	H
	21100	2535.0	-20.86	44.20	23.34	215.63	
	21425	2567.5	-21.38	44.80	23.42	219.84	
	20775	2502.5	-24.06	44.19	20.13	103.06	V
	21100	2535.0	-23.73	44.09	20.36	108.59	
	21425	2567.5	-24.02	44.50	20.48	111.66	

Note: EIRP (dBm) = Reading (dBm) + Correction Factor (dB)

LTE Band 7							
Channel Bandwidth: 10 MHz / QPSK							
Plane	Channel	Frequency (MHz)	Reading (dBm)	Correction Factor (dB)	EIRP (dBm)	EIRP (mW)	Polarization (H/V)
Z	20800	2505.0	-20.18	44.34	24.16	260.68	H
	21100	2535.0	-19.82	44.20	24.38	273.97	
	21400	2565.0	-20.25	44.72	24.47	280.09	
	20800	2505.0	-23.05	44.23	21.18	131.10	V
	21100	2535.0	-22.69	44.09	21.40	137.97	
	21400	2565.0	-22.88	44.41	21.53	142.10	
Channel Bandwidth: 10 MHz / 16QAM							
Z	20800	2505.0	-21.19	44.34	23.15	206.59	H
	21100	2535.0	-20.84	44.20	23.36	216.82	
	21400	2565.0	-21.26	44.72	23.46	221.97	
	20800	2505.0	-24.05	44.23	20.18	104.14	V
	21100	2535.0	-23.70	44.09	20.39	109.35	
	21400	2565.0	-23.89	44.41	20.52	112.62	

Note: EIRP (dBm) = Reading (dBm) + Correction Factor (dB)

LTE Band 7							
Channel Bandwidth: 15 MHz / QPSK							
Plane	Channel	Frequency (MHz)	Reading (dBm)	Correction Factor (dB)	EIRP (dBm)	EIRP (mW)	Polarization (H/V)
Z	20825	2507.5	-20.12	44.32	24.20	262.91	H
	21100	2535.0	-19.78	44.20	24.42	276.50	
	21375	2562.5	-20.34	44.85	24.51	282.36	
	20825	2507.5	-22.77	43.99	21.22	132.50	V
	21100	2535.0	-22.65	44.09	21.44	139.25	
	21375	2562.5	-22.95	44.51	21.56	143.22	
Channel Bandwidth: 15 MHz / 16QAM							
Z	20825	2507.5	-21.12	44.32	23.20	208.83	H
	21100	2535.0	-20.79	44.20	23.41	219.13	
	21375	2562.5	-21.35	44.85	23.50	223.77	
	20825	2507.5	-23.78	43.99	20.21	105.00	V
	21100	2535.0	-23.66	44.09	20.43	110.36	
	21375	2562.5	-23.95	44.51	20.56	113.76	

Note: EIRP (dBm) = Reading (dBm) + Correction Factor (dB)

LTE Band 7							
Channel Bandwidth: 20 MHz / QPSK							
Plane	Channel	Frequency (MHz)	Reading (dBm)	Correction Factor (dB)	EIRP (dBm)	EIRP (mW)	Polarization (H/V)
Z	20850	2510.0	-19.92	44.16	24.24	265.46	H
	21100	2535.0	-19.74	44.20	24.46	279.06	
	21350	2560.0	-20.26	44.81	24.55	284.90	
	20850	2510.0	-23.52	44.78	21.26	133.66	V
	21100	2535.0	-22.61	44.09	21.48	140.54	
	21350	2560.0	-23.12	44.72	21.60	144.54	
Channel Bandwidth: 20 MHz / 16QAM							
Z	20850	2510.0	-20.92	44.16	23.24	210.86	H
	21100	2535.0	-20.75	44.20	23.45	221.16	
	21350	2560.0	-21.26	44.81	23.55	226.31	
	20850	2510.0	-24.53	44.78	20.25	105.93	V
	21100	2535.0	-23.61	44.09	20.48	111.63	
	21350	2560.0	-24.12	44.72	20.60	114.82	

Note: EIRP (dBm) = Reading (dBm) + Correction Factor (dB)

4.2 Modulation Characteristics Measurement

4.2.1 Limits of Modulation Characteristics

N/A

4.2.2 Test Setup

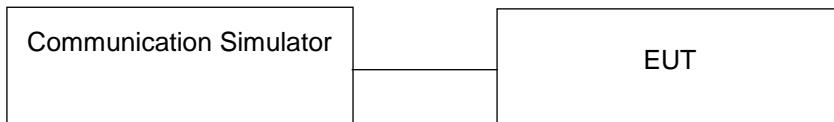

4.2.3 Test Procedure

Connect the EUT to Communication Simulator via the antenna connector. The frequency band is set as EUT supported Modulation and Channels, the EUT output is matched with 50 ohm load, the waveform quality and constellation of the EUT was tested.

4.2.4 Test Results

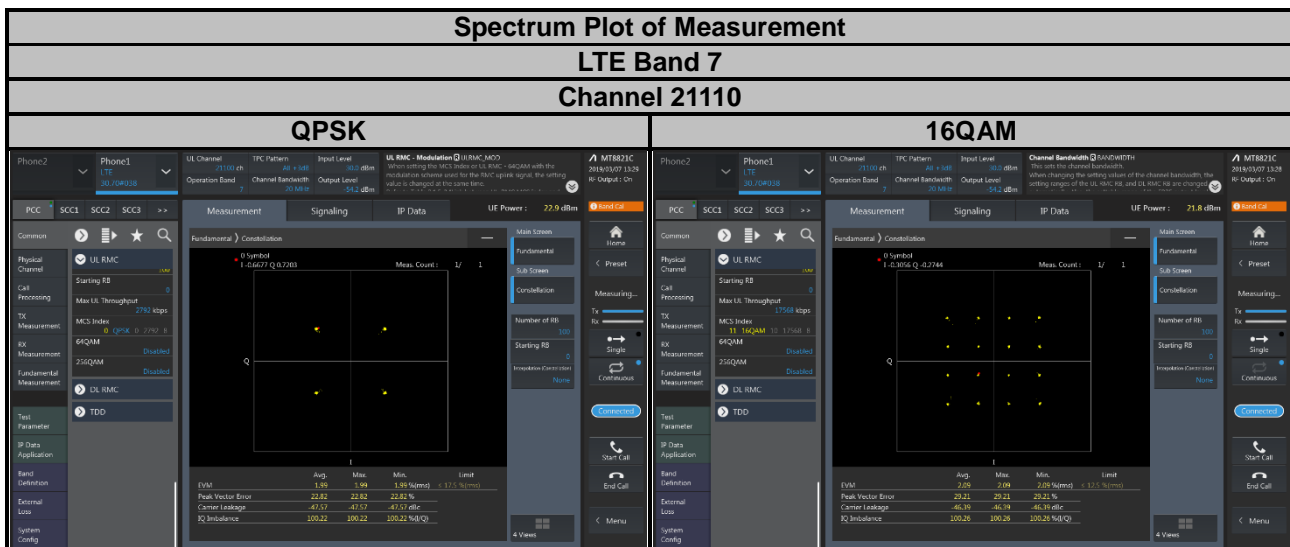

4.3 Frequency Stability Measurement

4.3.1 Limits of Frequency Stability Measurement

According to the FCC part 2.1055 shall be tested the frequency stability. The rule is defined that "The frequency stability shall be sufficient to ensure that the fundamental emission stays within the authorized frequency block." The test extreme voltage is according to the 2.1055(d)(1) Vary primary supply voltage from 85 to 115 percent of the nominal value for other than hand carried battery equipment and the extreme temperature rule is comply with specification of EUT $-30^{\circ}\text{C} \sim 50^{\circ}\text{C}$.

4.3.2 Test Procedure

- Device is placed at the oven room. The oven room could control the temperatures and humidity. Power warm up is at least 15 min and power applied should perform before recording frequency error.
- EUT is connected the external power supply to control the DC input power. The test voltage range is from minimum to maximum working voltage. Each step shall be record the frequency error rate.
- The temperature range step is 10 degrees in this test items. All temperature levels shall be hold the $\pm 0.5^{\circ}\text{C}$ during the measurement testing. The each temperature step shall be at least 0.5 hours, consider the EUT could be test under the stability condition.

NOTE: The frequency error was recorded frequency error from the communication simulator.

4.3.3 Test Setup

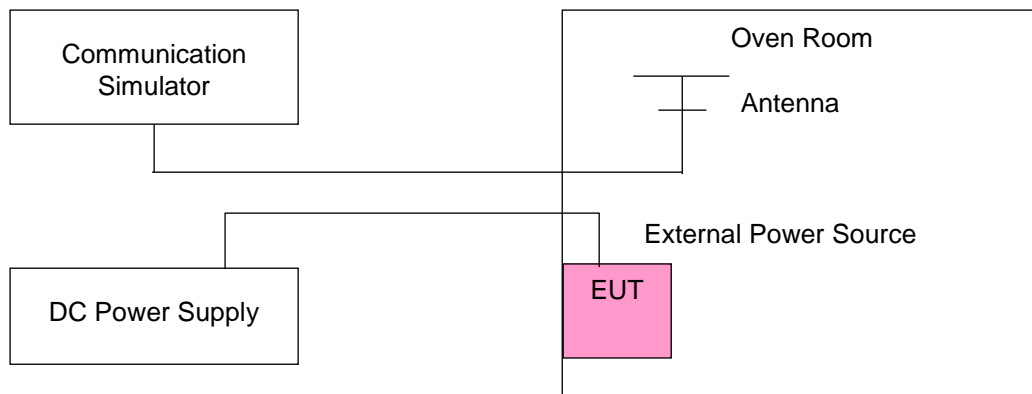

4.3.4 Test Results

Frequency Error vs. Voltage

Voltage (Volts)	LTE Band 7			
	Channel Bandwidth: 5 MHz			
	Low Channel		High Channel	
	Frequency (MHz)	Frequency Error (ppm)	Frequency (MHz)	Frequency Error (ppm)
3.7	2502.500001	0.0005	2567.500002	0.0009
3.145	2502.500002	0.0008	2567.500002	0.0006
4.255	2502.500002	0.0008	2567.500002	0.0006

Note: The applicant defined the normal working voltage of the battery is from 3.145 Vdc to 4.255 Vdc.

Frequency Error vs. Temperature

Temp. (°C)	LTE Band 7			
	Channel Bandwidth: 5 MHz			
	Low Channel		High Channel	
	Frequency (MHz)	Frequency Error (ppm)	Frequency (MHz)	Frequency Error (ppm)
-30	2502.500004	0.0015	2567.500002	0.0007
-20	2502.500002	0.0006	2567.500003	0.0011
-10	2502.500003	0.0012	2567.500002	0.0007
0	2502.500004	0.0015	2567.500003	0.0013
10	2502.500002	0.0006	2567.500003	0.0012
20	2502.499998	-0.0010	2567.499998	-0.0007
30	2502.499997	-0.0014	2567.499998	-0.0007
40	2502.499998	-0.0008	2567.499998	-0.0007
50	2502.499998	-0.0008	2567.499998	-0.0009

Frequency Error vs. Voltage

Voltage (Volts)	LTE Band 7			
	Channel Bandwidth: 10 MHz			
	Low Channel		High Channel	
	Frequency (MHz)	Frequency Error (ppm)	Frequency (MHz)	Frequency Error (ppm)
3.7	2502.500003	0.0012	2567.500001	0.0005
3.145	2502.500003	0.0010	2567.500001	0.0005
4.255	2502.500002	0.0006	2567.500004	0.0016

Note: The applicant defined the normal working voltage of the battery is from 3.145 Vdc to 4.255 Vdc.

Frequency Error vs. Temperature

Temp. (°C)	LTE Band 7			
	Channel Bandwidth: 10 MHz			
	Low Channel		High Channel	
	Frequency (MHz)	Frequency Error (ppm)	Frequency (MHz)	Frequency Error (ppm)
-30	2502.500002	0.0007	2567.500001	0.0005
-20	2502.500002	0.0006	2567.500002	0.0007
-10	2502.500004	0.0016	2567.500003	0.0010
0	2502.500002	0.0009	2567.500002	0.0006
10	2502.500001	0.0005	2567.500004	0.0014
20	2502.499999	-0.0004	2567.499998	-0.0009
30	2502.499997	-0.0013	2567.499997	-0.0011
40	2502.499998	-0.0010	2567.499997	-0.0013
50	2502.499998	-0.0010	2567.499999	-0.0005

Frequency Error vs. Voltage

Voltage (Volts)	LTE Band 7			
	Channel Bandwidth: 15 MHz			
	Low Channel		High Channel	
	Frequency (MHz)	Frequency Error (ppm)	Frequency (MHz)	Frequency Error (ppm)
3.7	2502.500003	0.0014	2567.500004	0.0015
3.145	2502.500003	0.0012	2567.500003	0.0012
4.255	2502.500004	0.0016	2567.500003	0.0011

Note: The applicant defined the normal working voltage of the battery is from 3.145 Vdc to 4.255 Vdc.

Frequency Error vs. Temperature

Temp. (°C)	LTE Band 7			
	Channel Bandwidth: 15 MHz			
	Low Channel		High Channel	
	Frequency (MHz)	Frequency Error (ppm)	Frequency (MHz)	Frequency Error (ppm)
-30	2502.500002	0.0008	2567.500002	0.0008
-20	2502.500003	0.0011	2567.500001	0.0004
-10	2502.500003	0.0011	2567.500002	0.0006
0	2502.500004	0.0015	2567.500002	0.0007
10	2502.500003	0.0010	2567.500003	0.0013
20	2502.499997	-0.0013	2567.499996	-0.0014
30	2502.499996	-0.0014	2567.499997	-0.0011
40	2502.499996	-0.0016	2567.499997	-0.0012
50	2502.499998	-0.0007	2567.499999	-0.0004

Frequency Error vs. Voltage

Voltage (Volts)	LTE Band 7			
	Channel Bandwidth: 20 MHz			
	Low Channel		High Channel	
	Frequency (MHz)	Frequency Error (ppm)	Frequency (MHz)	Frequency Error (ppm)
3.7	2502.500002	0.0008	2567.500004	0.0015
3.145	2502.500002	0.0008	2567.500003	0.0010
4.255	2502.500003	0.0012	2567.500004	0.0014

Note: The applicant defined the normal working voltage of the battery is from 3.145 Vdc to 4.255 Vdc.

Frequency Error vs. Temperature

Temp. (°C)	LTE Band 7			
	Channel Bandwidth: 20 MHz			
	Low Channel		High Channel	
	Frequency (MHz)	Frequency Error (ppm)	Frequency (MHz)	Frequency Error (ppm)
-30	2502.500002	0.0010	2567.500002	0.0007
-20	2502.500002	0.0007	2567.500003	0.0012
-10	2502.500001	0.0006	2567.500003	0.0011
0	2502.500002	0.0008	2567.500003	0.0011
10	2502.500003	0.0013	2567.500002	0.0008
20	2502.499996	-0.0015	2567.499997	-0.0012
30	2502.499997	-0.0011	2567.499998	-0.0008
40	2502.499997	-0.0012	2567.499996	-0.0015
50	2502.499999	-0.0004	2567.499996	-0.0014

4.4 Occupied Bandwidth Measurement

4.4.1 Limits of Occupied Bandwidth Measurement

The width of a frequency band such that, below the lower and above the upper frequency limits, the mean powers emitted are each equal to a specified percentage 0.5 % of the total mean power of a given emission.

4.4.2 Test Procedure

- The conducted occupied bandwidth used the power splitter via EUT RF power connector between simulation base station and spectrum analyzer.
- Use OBW measurement function of Spectrum analyzer to measure 99 % occupied bandwidth.

4.4.3 Test Setup

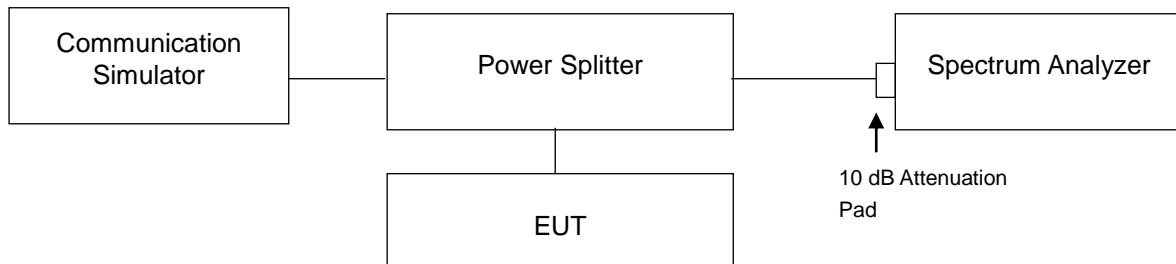

4.4.4 Test Results

LTE Band 7					
Channel Bandwidth: 5 MHz					
Channel	Frequency (MHz)	99 % Occupied Bandwidth (MHz)		26 dB Bandwidth (MHz)	
		QPSK	16QAM	QPSK	16QAM
20775	2502.5	4.4959	4.4973	4.845	4.834
21100	2535.0	4.4938	4.4944	4.829	4.833
21425	2567.5	4.4933	4.4946	4.836	4.827
Channel Bandwidth: 10 MHz					
Channel	Frequency (MHz)	99 % Occupied Bandwidth (MHz)		26 dB Bandwidth (MHz)	
		QPSK	16QAM	QPSK	16QAM
20800	2505.0	8.9658	8.9676	9.543	9.527
21100	2535.0	8.9718	8.9712	9.528	9.535
21400	2565.0	8.9677	8.9643	9.526	9.531



LTE Band 7					
Channel Bandwidth: 15 MHz					
Channel	Frequency (MHz)	99 % Occupied Bandwidth (MHz)		26 dB Bandwidth (MHz)	
		QPSK	16QAM	QPSK	16QAM
20825	2507.5	13.469	13.461	14.28	14.26
21100	2535.0	13.485	13.473	14.29	14.27
21375	2562.5	13.479	13.460	14.26	14.25

Channel Bandwidth: 20 MHz					
Channel	Frequency (MHz)	99 % Occupied Bandwidth (MHz)		26 dB Bandwidth (MHz)	
		QPSK	16QAM	QPSK	16QAM
20850	2510.0	17.917	17.944	19.05	19.05
21100	2535.0	17.969	17.987	19.06	19.07
21350	2560.0	17.932	17.949	19.03	19.04



4.5 Out-of-Band Emissions Measurement

4.5.1 Limits of Out-of-Band Emissions Measurement

According to FCC 27.53(m)(4)&(6) specified that power of any emission outside of the channel edge must be attenuated below the transmitting power (P) by a factor shall be not less than $40 + 10 \log (P)$ dB on all frequencies between the channel edge and 5 megahertz from the channel edge, $43 + 10 \log (P)$ dB on all frequencies between 5 megahertz and X megahertz from the channel edge, and $55 + 10 \log (P)$ dB on all frequencies more than X megahertz from the channel edge, where X is the greater of 6 megahertz or the actual emission bandwidth. In addition, the attenuation factor shall not be less that $43 + 10 \log (P)$ dB on all frequencies between 2490.5 MHz and 2496 MHz and $55 + 10 \log (P)$ dB at or below 2490.5 MHz. In the 1 MHz bands immediately outside and adjacent to the frequency block a resolution bandwidth of at least two percent may be employed, except when the 1 megahertz band is 2495-2496 MHz, in which case a resolution bandwidth of at least one percent may be employed.

4.5.2 Test Setup

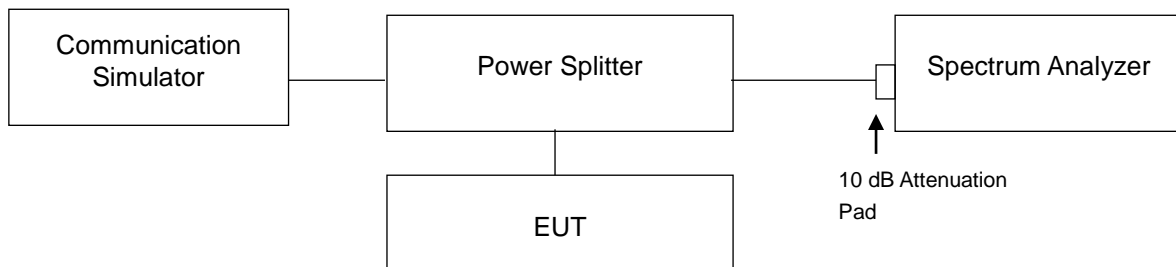

4.5.3 Test Procedures

- a. The EUT was set up for the maximum peak power with LTE link data modulation. The power was measured with R&S Spectrum Analyzer. All measurements were done at 2 channels (low and high operational frequency range).
- b. The out-of-band emissions measurement used the power splitter via EUT RF power connector between simulation base station and spectrum analyzer.
- c. Record the max. trace plot into the test report.

4.5.4 Test Results

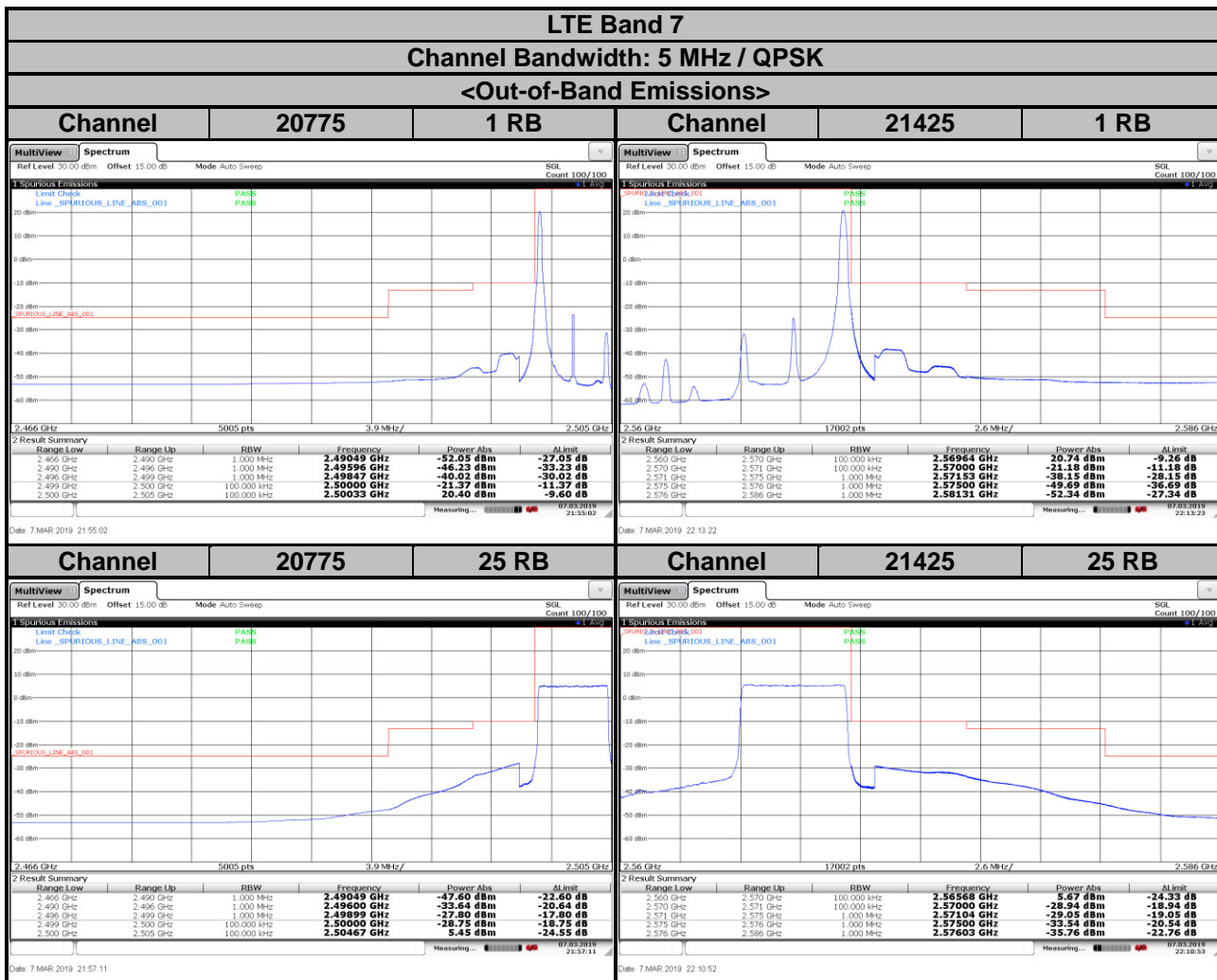

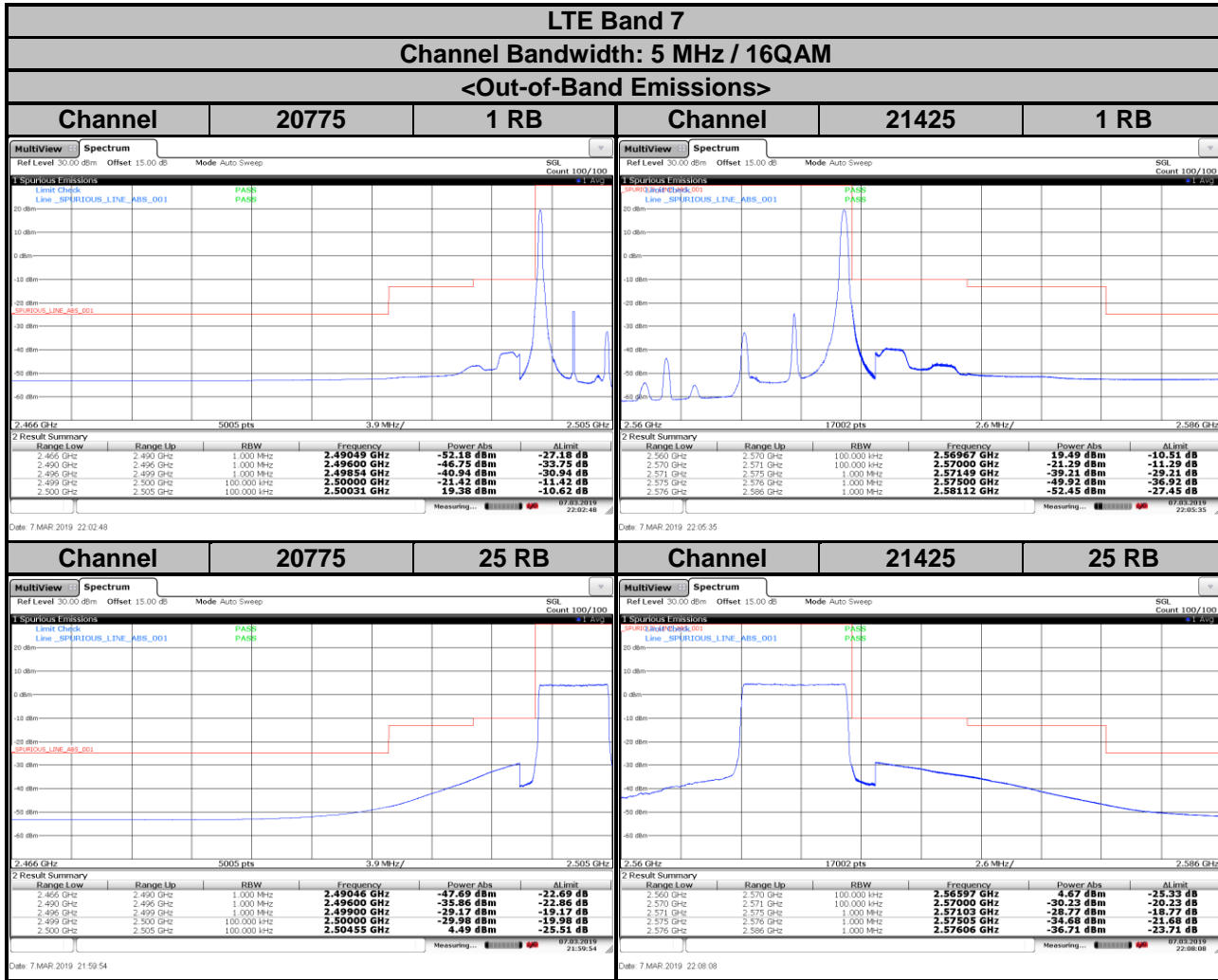

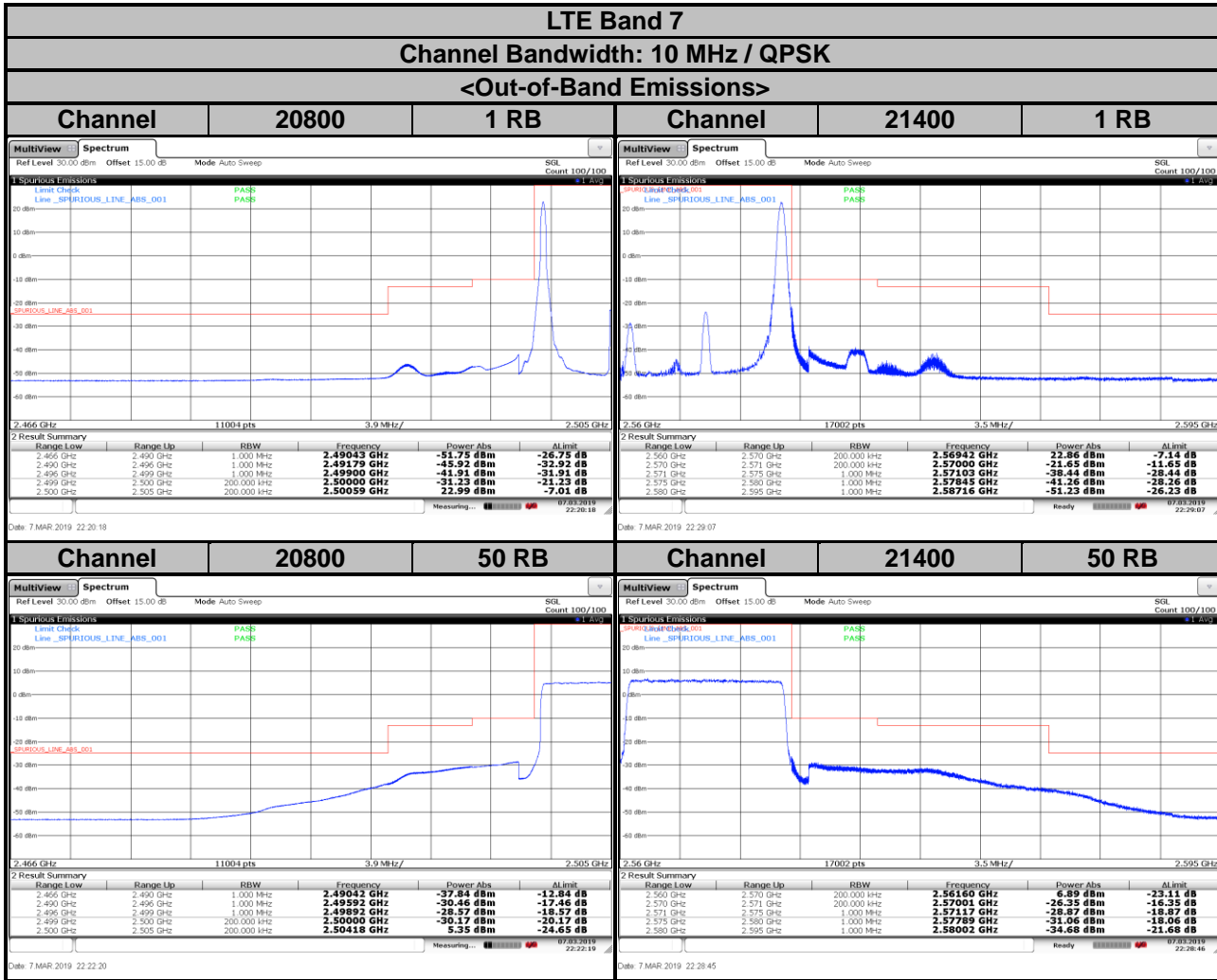

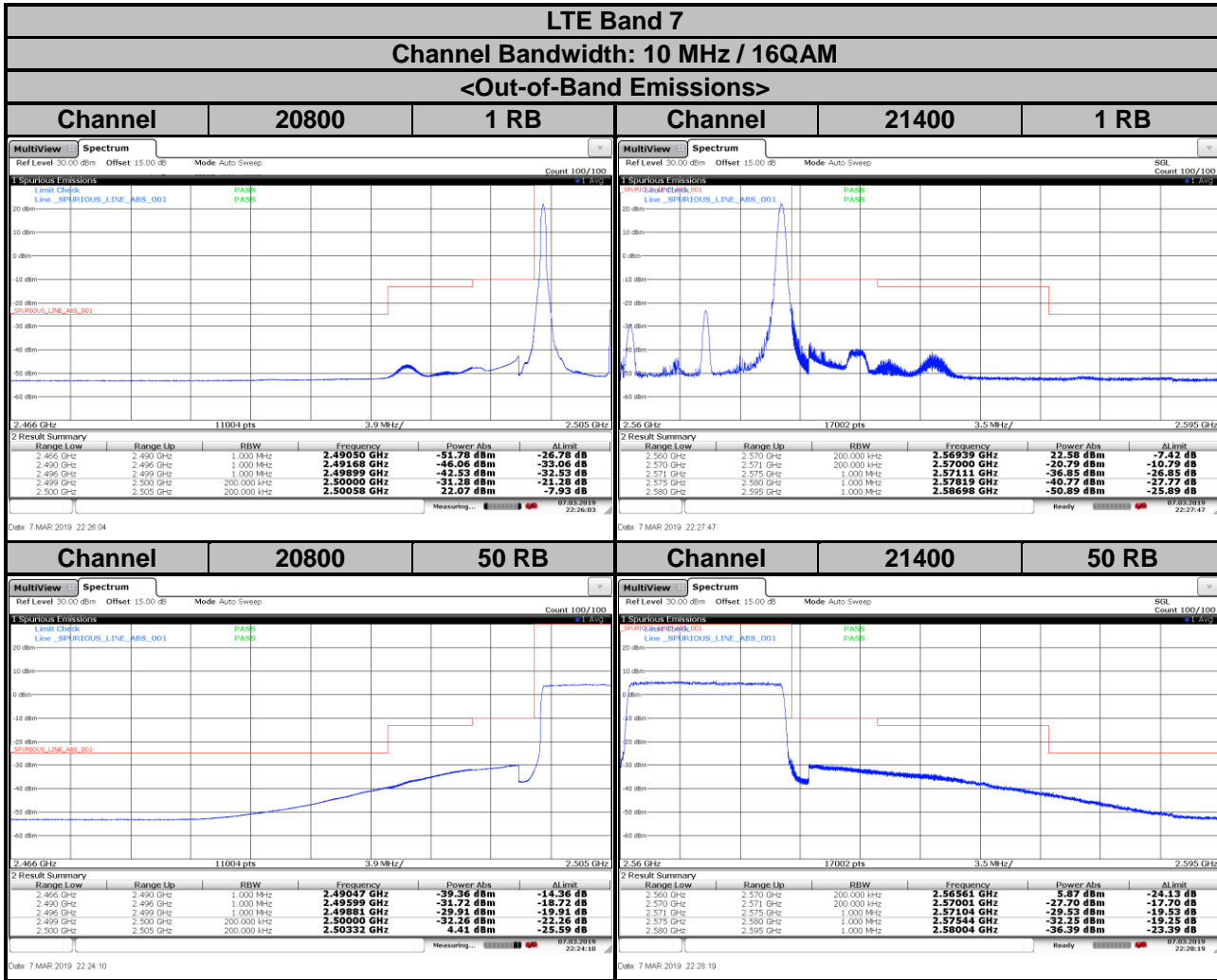

LTE Band 7

Channel Bandwidth: 15 MHz / QPSK

<Out-of-Band Emissions>

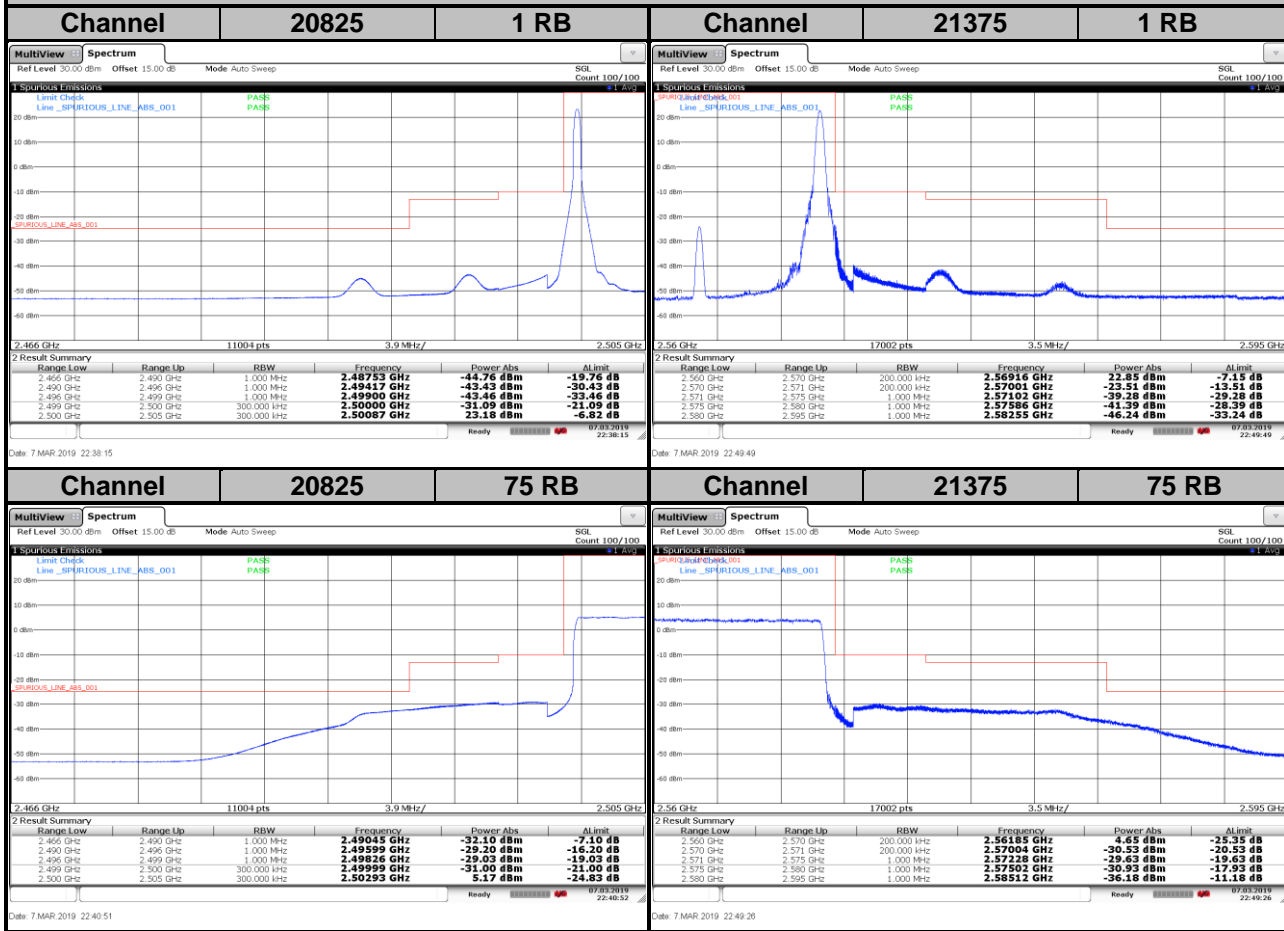

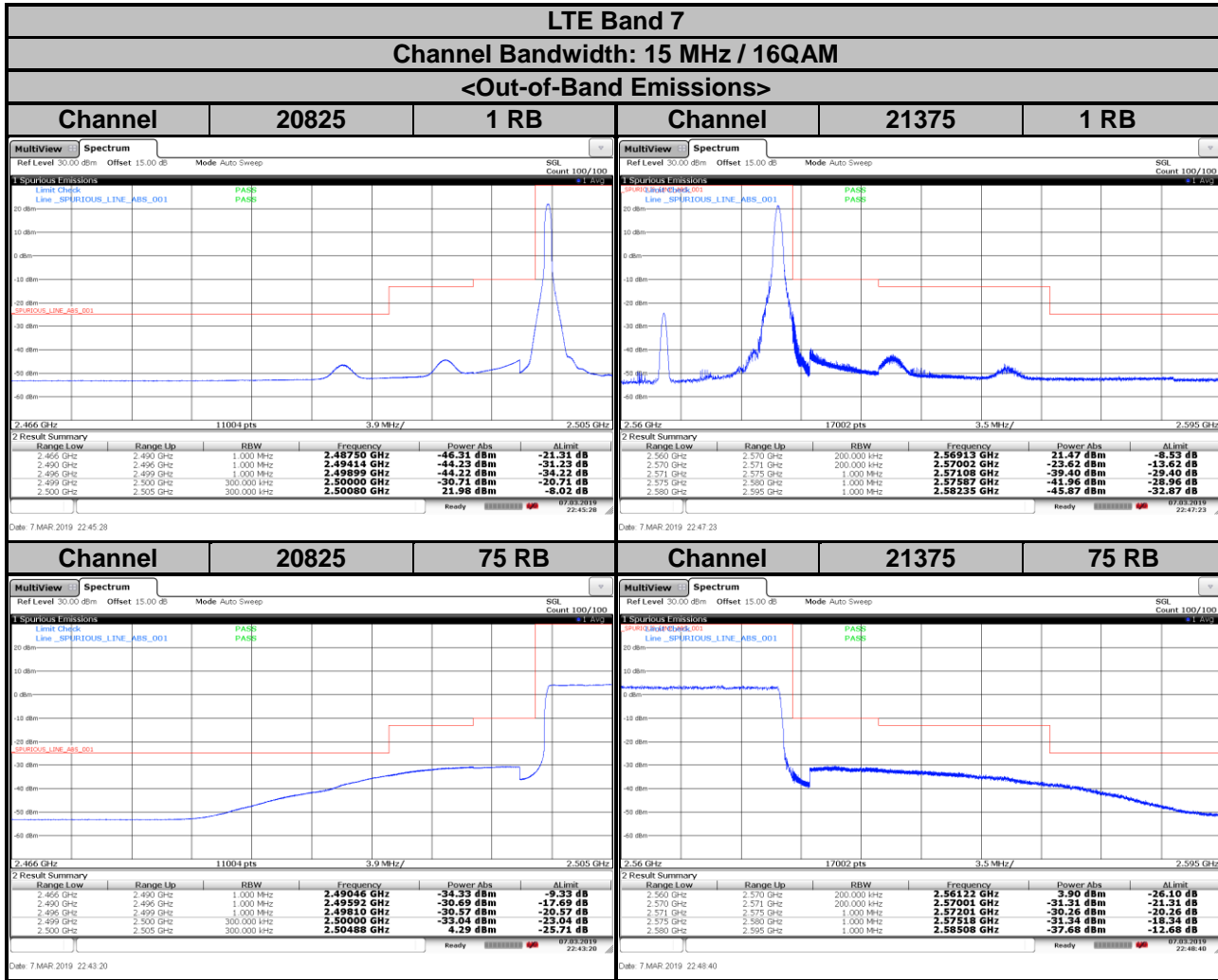

LTE Band 7

Channel Bandwidth: 20 MHz / QPSK

<Out-of-Band Emissions>

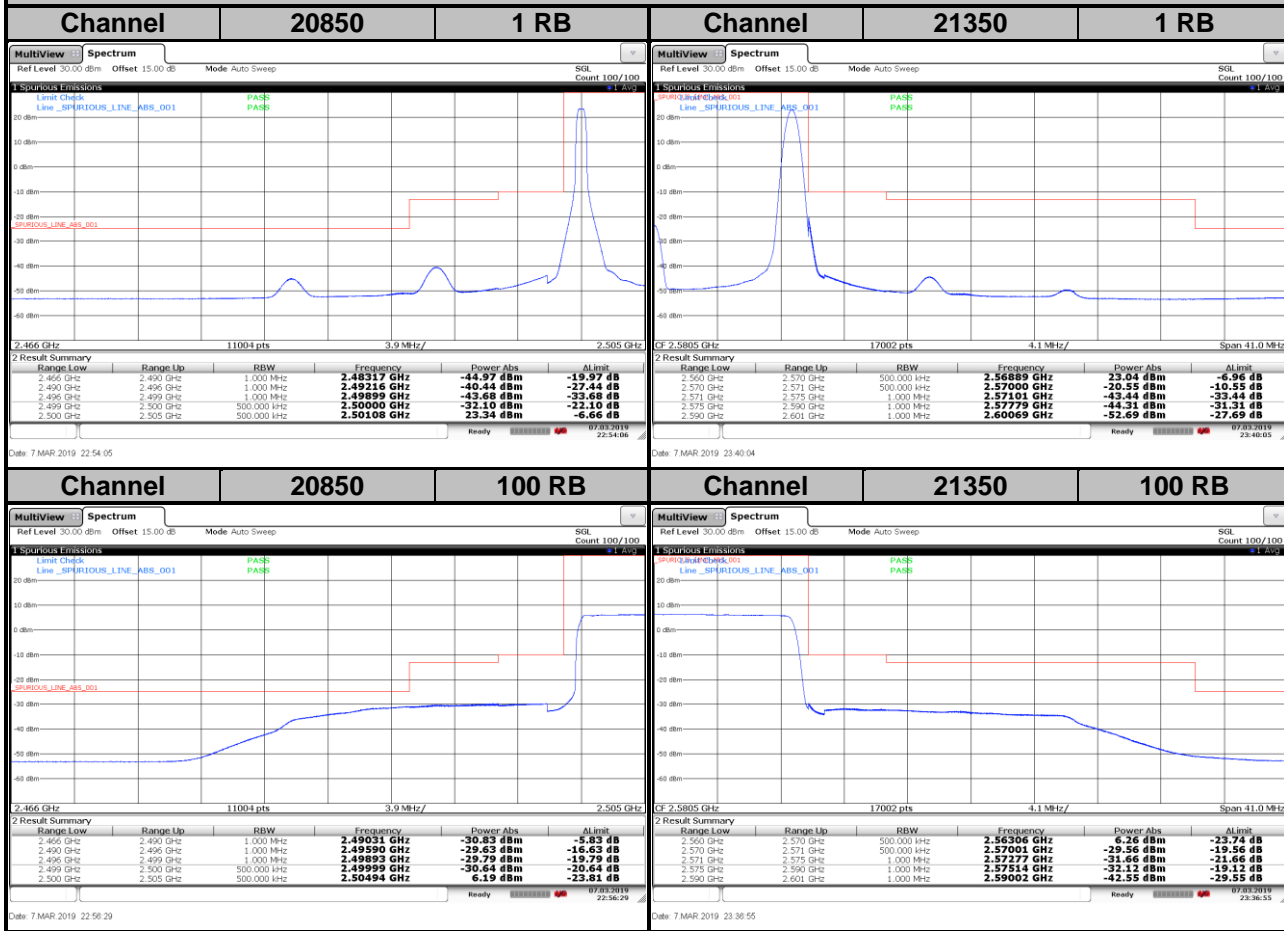

LTE Band 7

Channel Bandwidth: 20 MHz / 16QAM

<Out-of-Band Emissions>

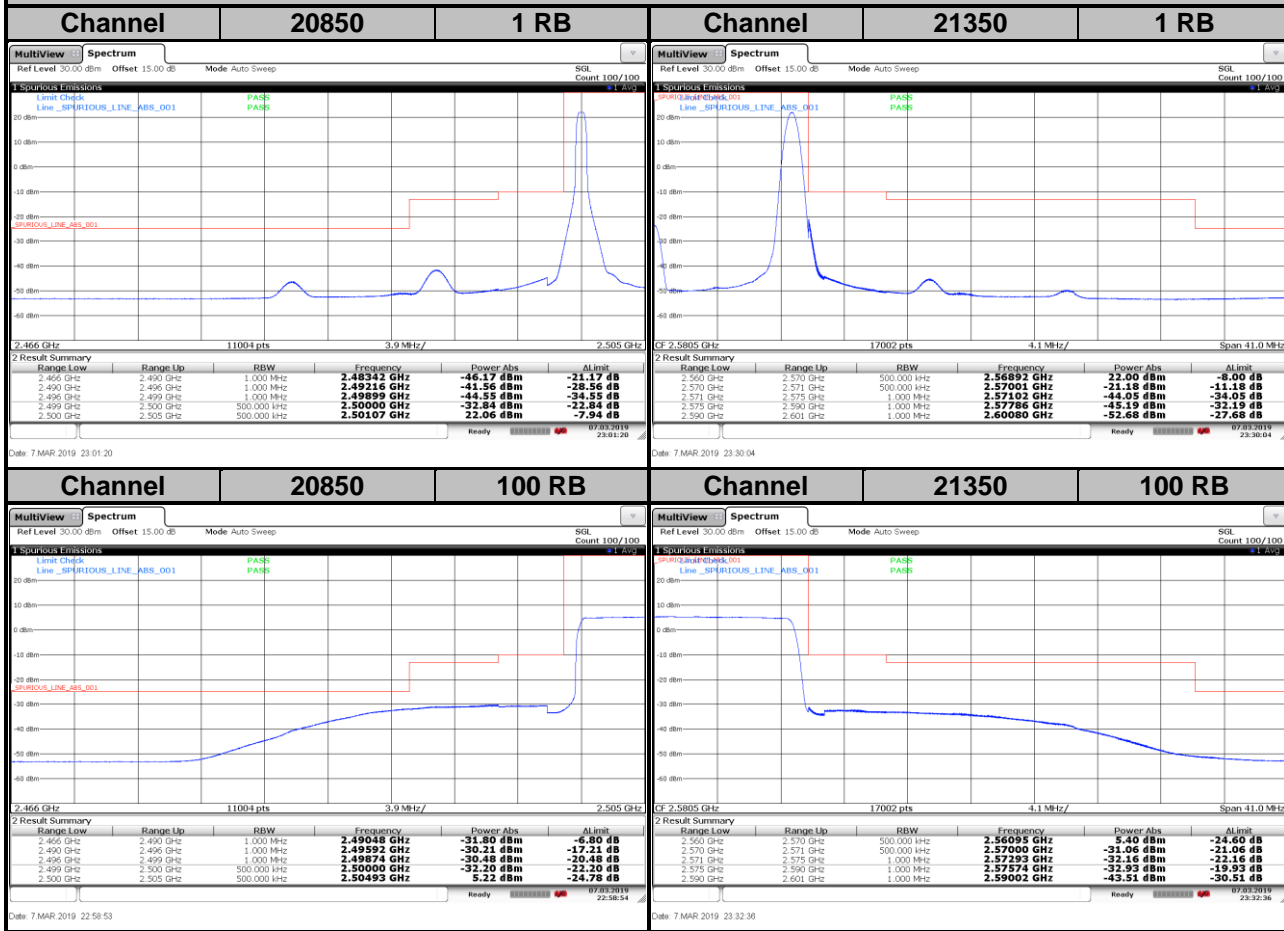

4.6 Peak to Average Ratio

4.6.1 Limits of Peak to Average Ratio Measurement

In measuring transmissions in this band using an average power technique, the peak to-average ratio (PAR) of the transmission may not exceed 13 dB.

4.6.2 Test Setup

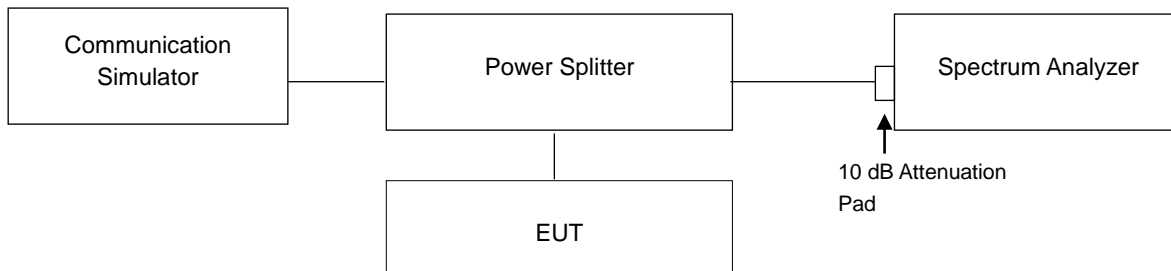

4.6.3 Test Procedures

1. Set resolution/measurement bandwidth \geq signal's occupied bandwidth;
2. Set the number of counts to a value that stabilizes the measured CCDF curve;
3. Record the maximum PAPR level associated with a probability of 0.1 %.

4.6.4 Test Results

LTE Band 7							
Channel Bandwidth: 5 MHz				Channel Bandwidth: 10 MHz			
Channel	Frequency (MHz)	Peak to Average Ratio (dB)		Channel	Frequency (MHz)	Peak to Average Ratio (dB)	
		QPSK	16QAM			QPSK	16QAM
20775	2502.5	3.69	4.67	20800	2505.0	3.56	4.20
21100	2535.0	3.94	4.73	21100	2535.0	3.99	4.89
21425	2567.5	3.78	4.43	21400	2565.0	3.64	4.59

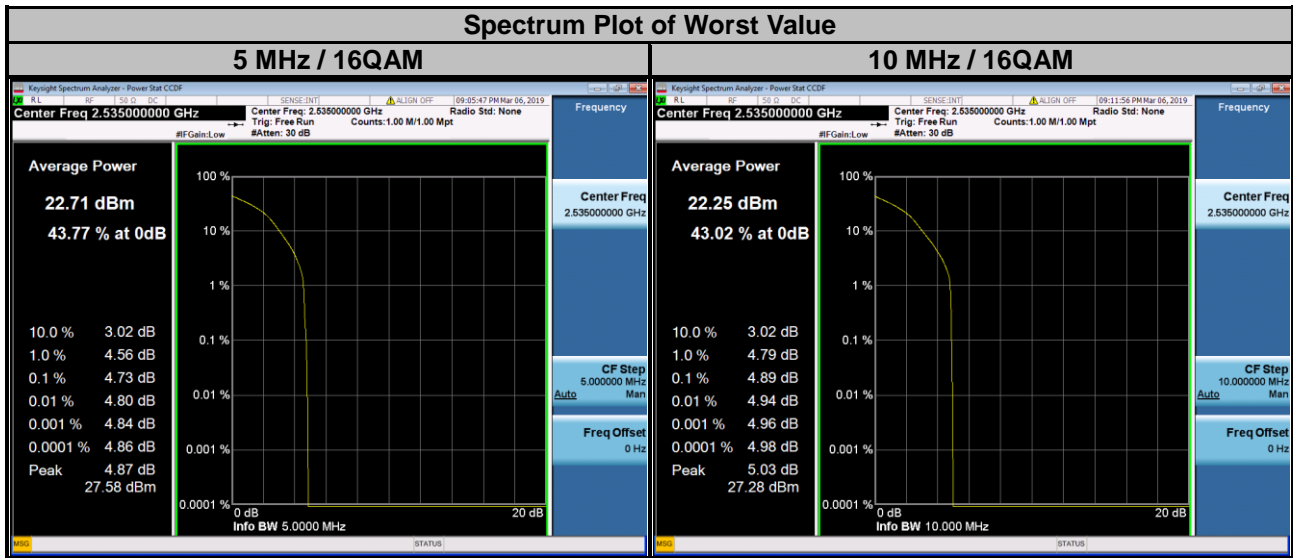

LTE Band 7							
Channel Bandwidth: 15 MHz				Channel Bandwidth: 20 MHz			
Channel	Frequency (MHz)	Peak to Average Ratio (dB)		Channel	Frequency (MHz)	Peak to Average Ratio (dB)	
		QPSK	16QAM			QPSK	16QAM
20825	2507.5	3.46	4.33	20850	2510.0	3.56	4.54
21100	2535.0	3.70	4.23	21100	2535.0	3.69	4.58
21375	2562.5	3.71	4.67	21350	2560.0	3.76	4.40

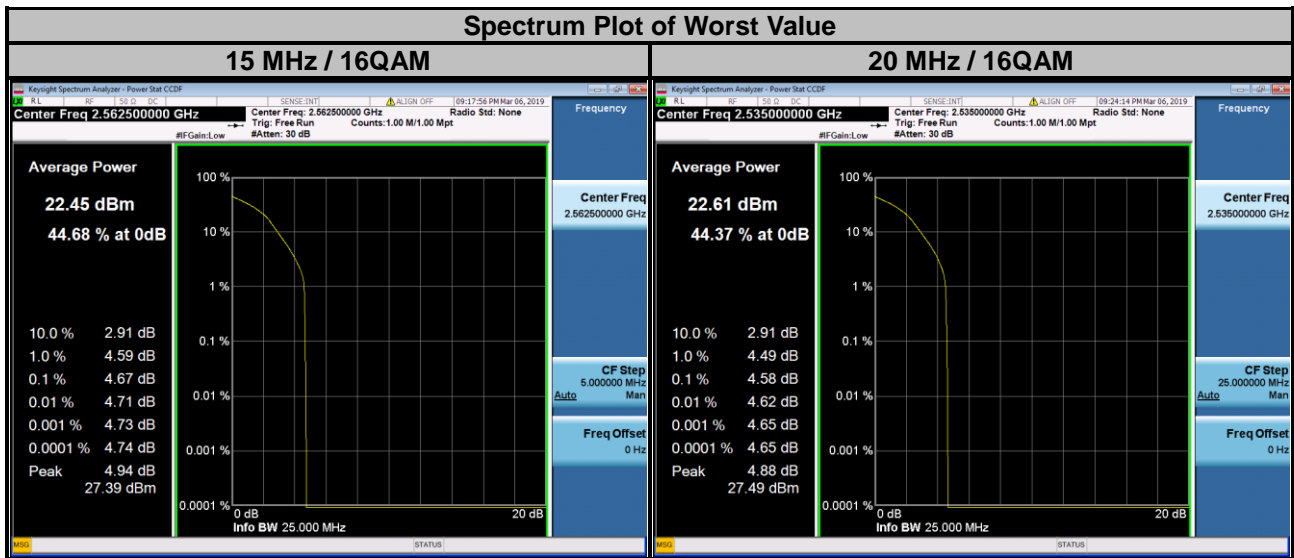

4.7 Conducted Spurious Emissions

4.7.1 Limits of Conducted Spurious Emissions Measurement

The power of any emission outside a licensee's frequency block shall be attenuated below the transmitter power (P) by at least $55 + 10 \log (P)$ dB. The limit of emission is equal to -25 dBm.

4.7.2 Test Setup

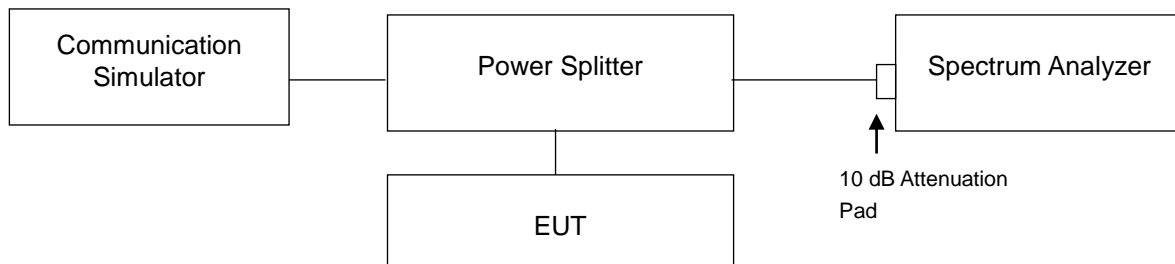

4.7.3 Test Procedure

- The EUT makes a phone call to the communication simulator. All measurements were done at low, middle and high operational frequency range.
- Measuring frequency range is from 9 kHz to 1 GHz. 10 dB attenuation pad is connected with spectrum. RBW = 100 kHz and VBW = 300 kHz are used for conducted emission measurement.
- Measuring frequency range is from 1 GHz to 26 GHz. 10 dB attenuation pad is connected with spectrum. RBW = 1 MHz and VBW = 3 MHz are used for conducted emission measurement.

4.7.4 Test Results

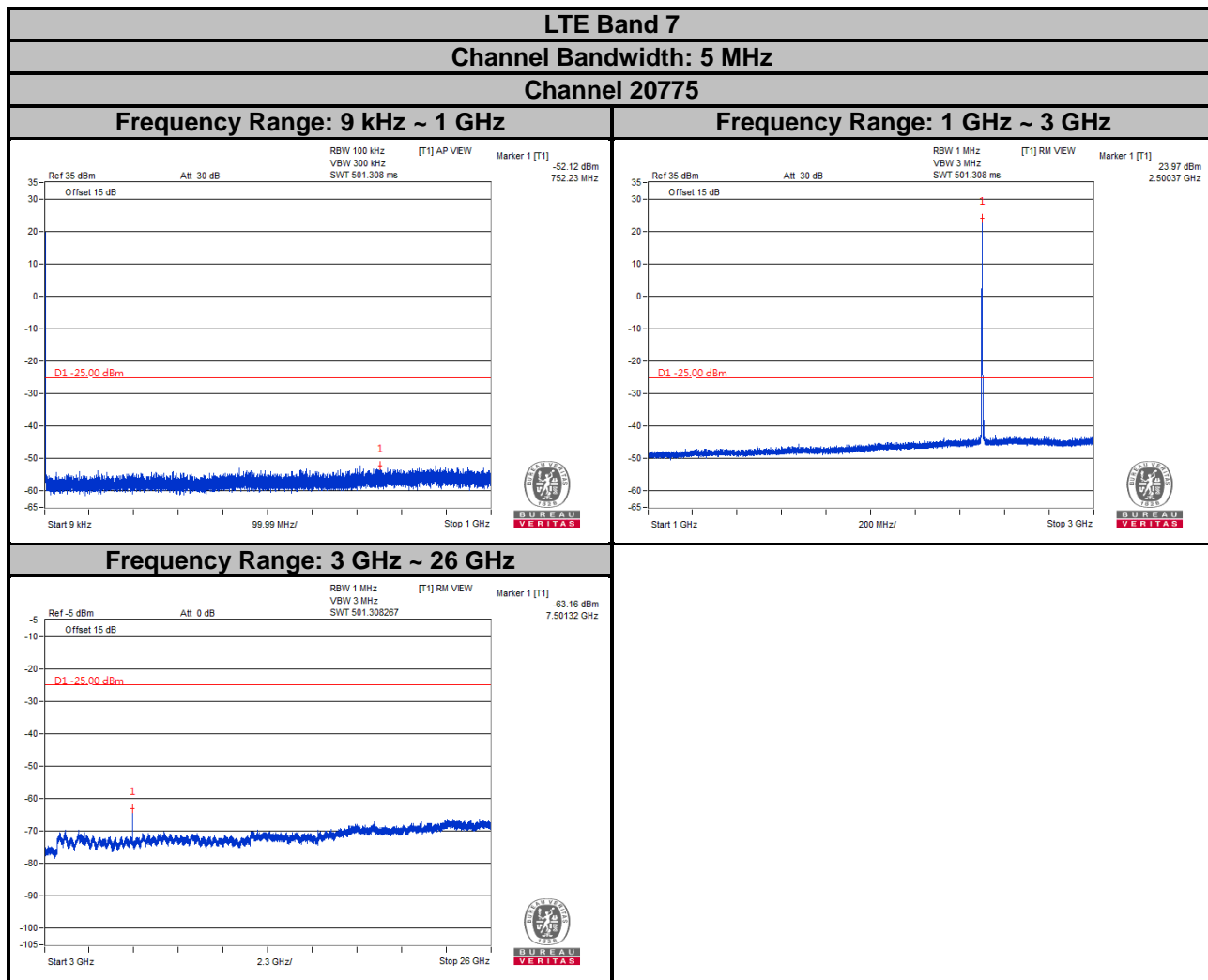

Note: The signal over the limit in 9 kHz is from spectrum analyzer.

LTE Band 7

Channel Bandwidth: 5 MHz

Channel 21100

Frequency Range: 9 kHz ~ 1 GHz

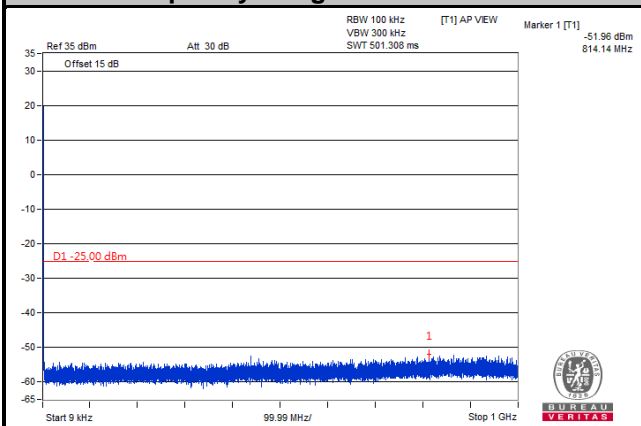

Frequency Range: 1 GHz ~ 3 GHz

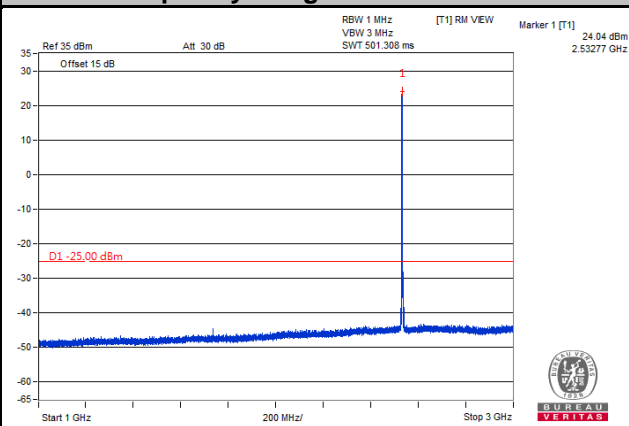

Frequency Range: 3 GHz ~ 26 GHz

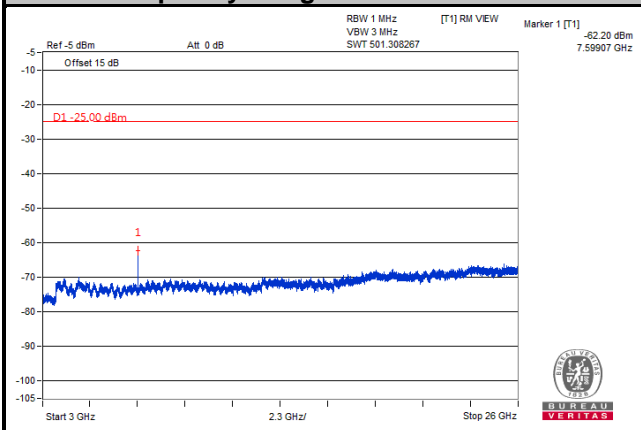

Note: The signal over the limit in 9 kHz is from spectrum analyzer.

LTE Band 7

Channel Bandwidth: 5 MHz

Channel 21425

Frequency Range: 9 kHz ~ 1 GHz

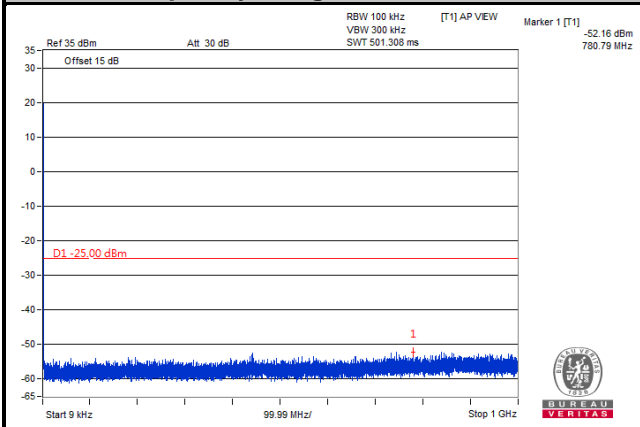

Frequency Range: 1 GHz ~ 3 GHz

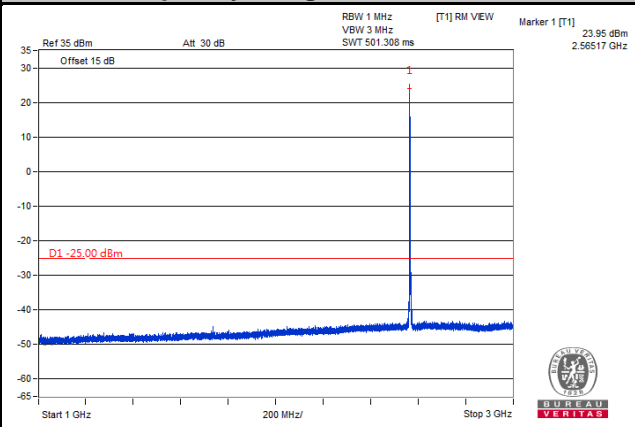

Frequency Range: 3 GHz ~ 26 GHz

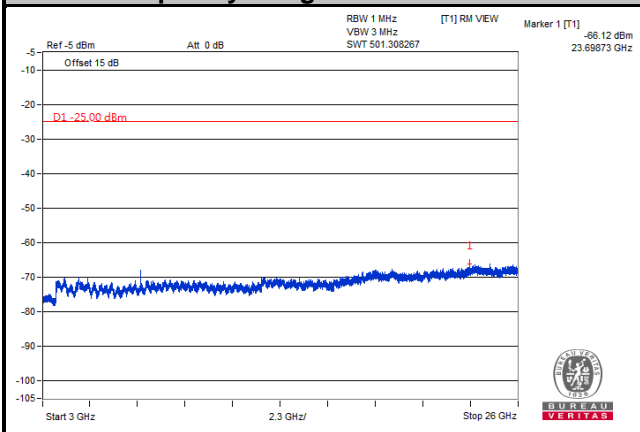

Note: The signal over the limit in 9 kHz is from spectrum analyzer.

LTE Band 7

Channel Bandwidth: 10 MHz

Channel 20800

Frequency Range: 9 kHz ~ 1 GHz

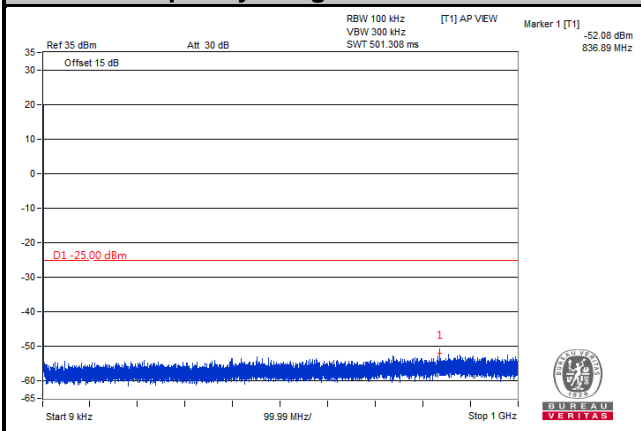

Frequency Range: 1 GHz ~ 3 GHz

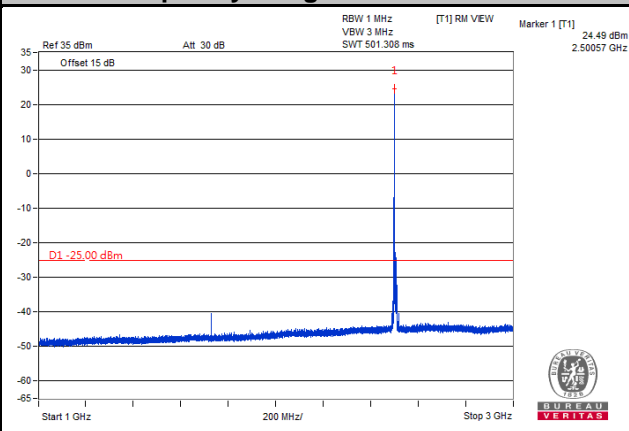

Frequency Range: 3 GHz ~ 26 GHz

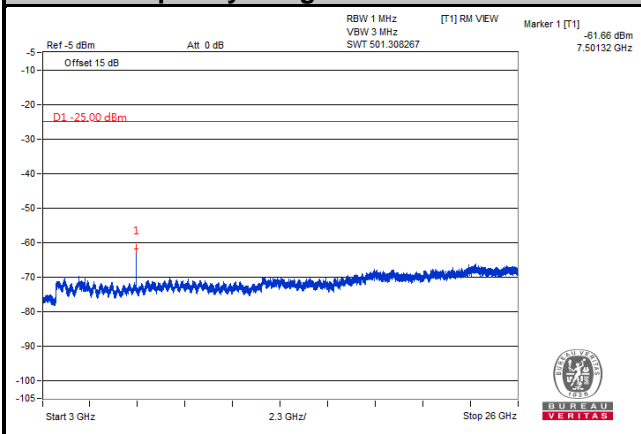

Note: The signal over the limit in 9 kHz is from spectrum analyzer.

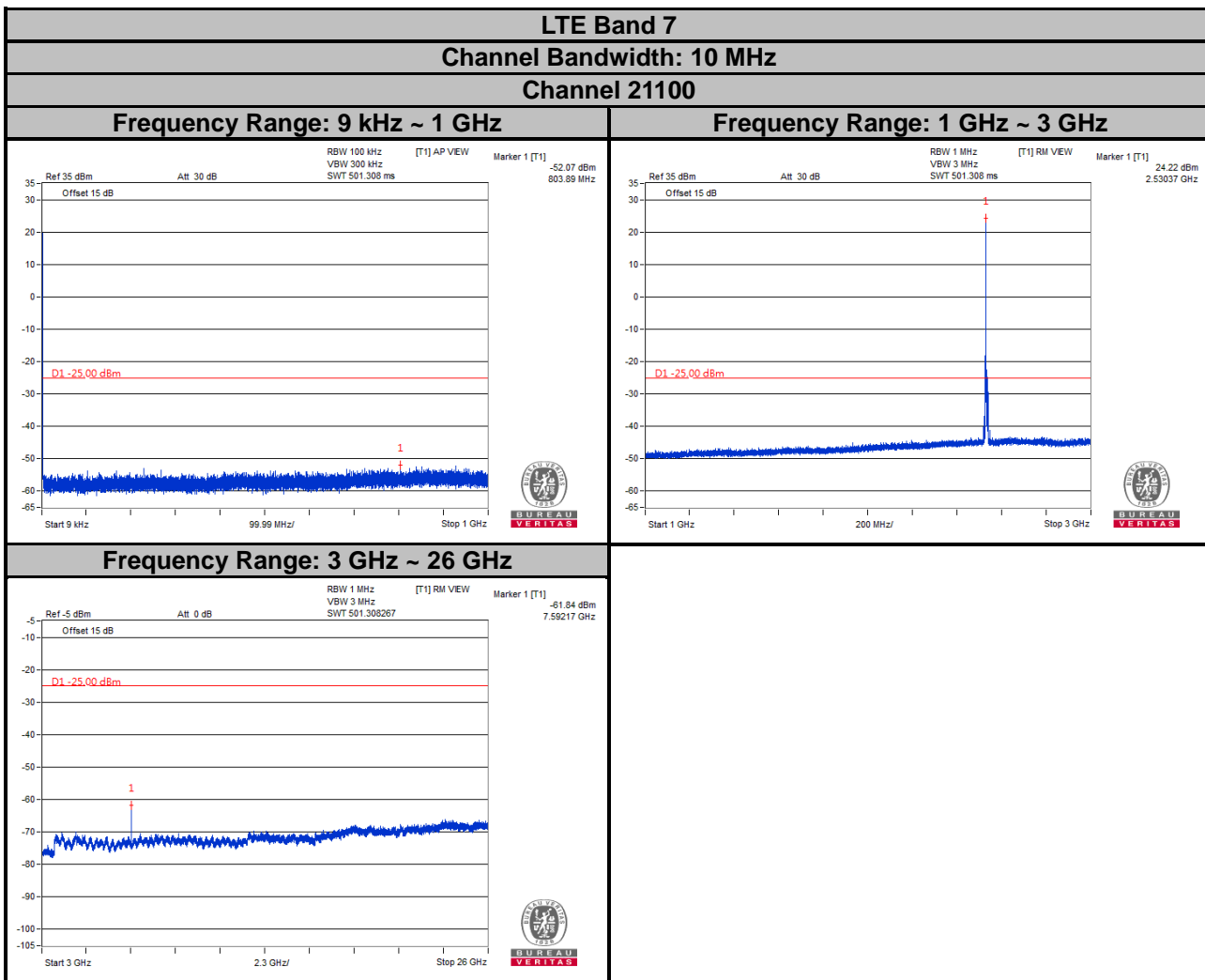

Note: The signal over the limit in 9 kHz is from spectrum analyzer.

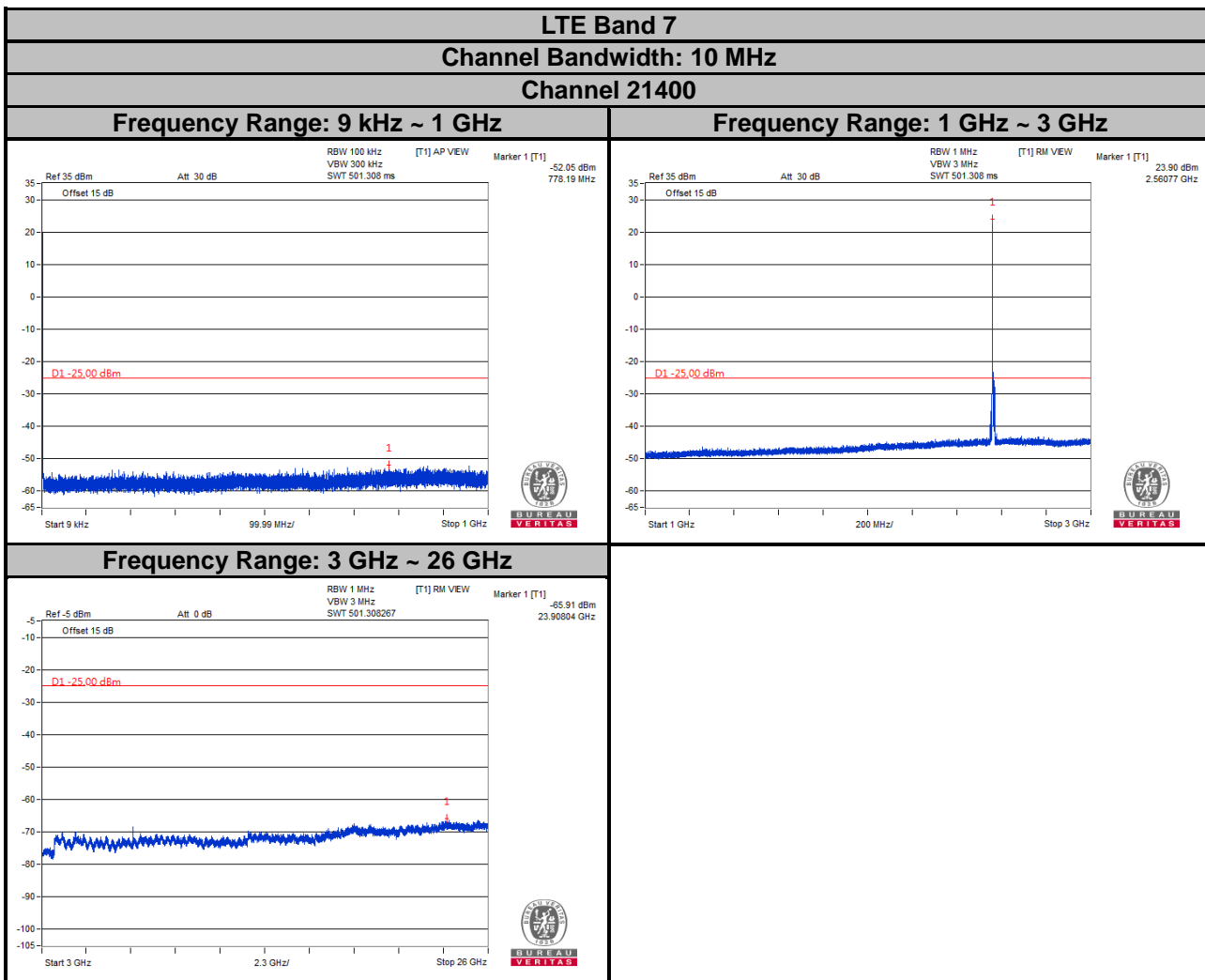

Note: The signal over the limit in 9 kHz is from spectrum analyzer.

LTE Band 7

Channel Bandwidth: 15 MHz

Channel 20825

Frequency Range: 9 kHz ~ 1 GHz

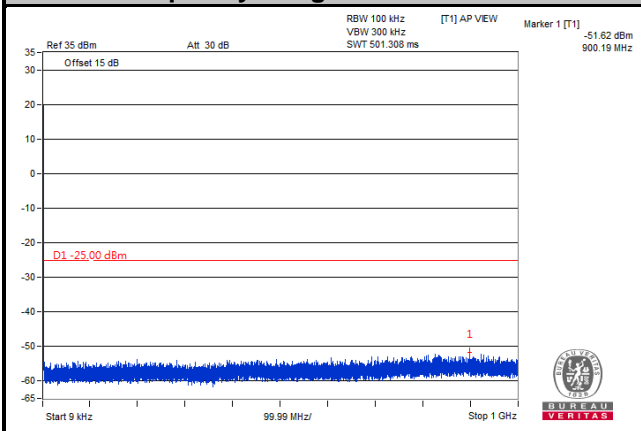

Frequency Range: 1 GHz ~ 3 GHz

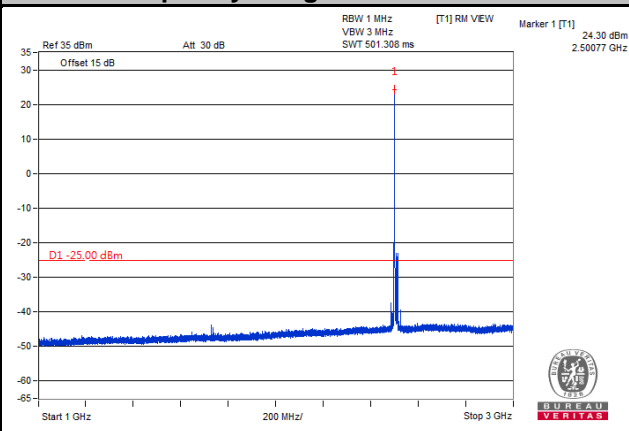

Frequency Range: 3 GHz ~ 26 GHz

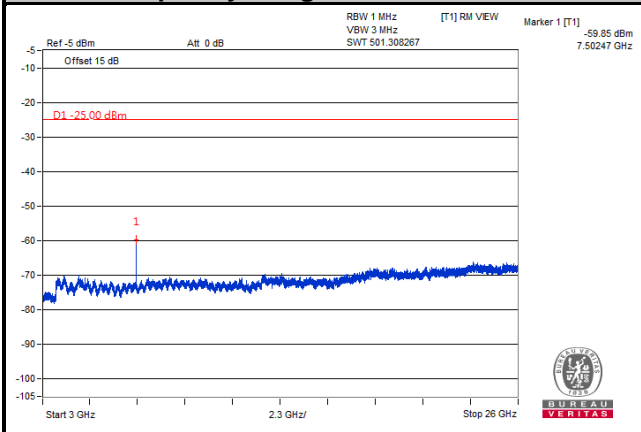

Note: The signal over the limit in 9 kHz is from spectrum analyzer.

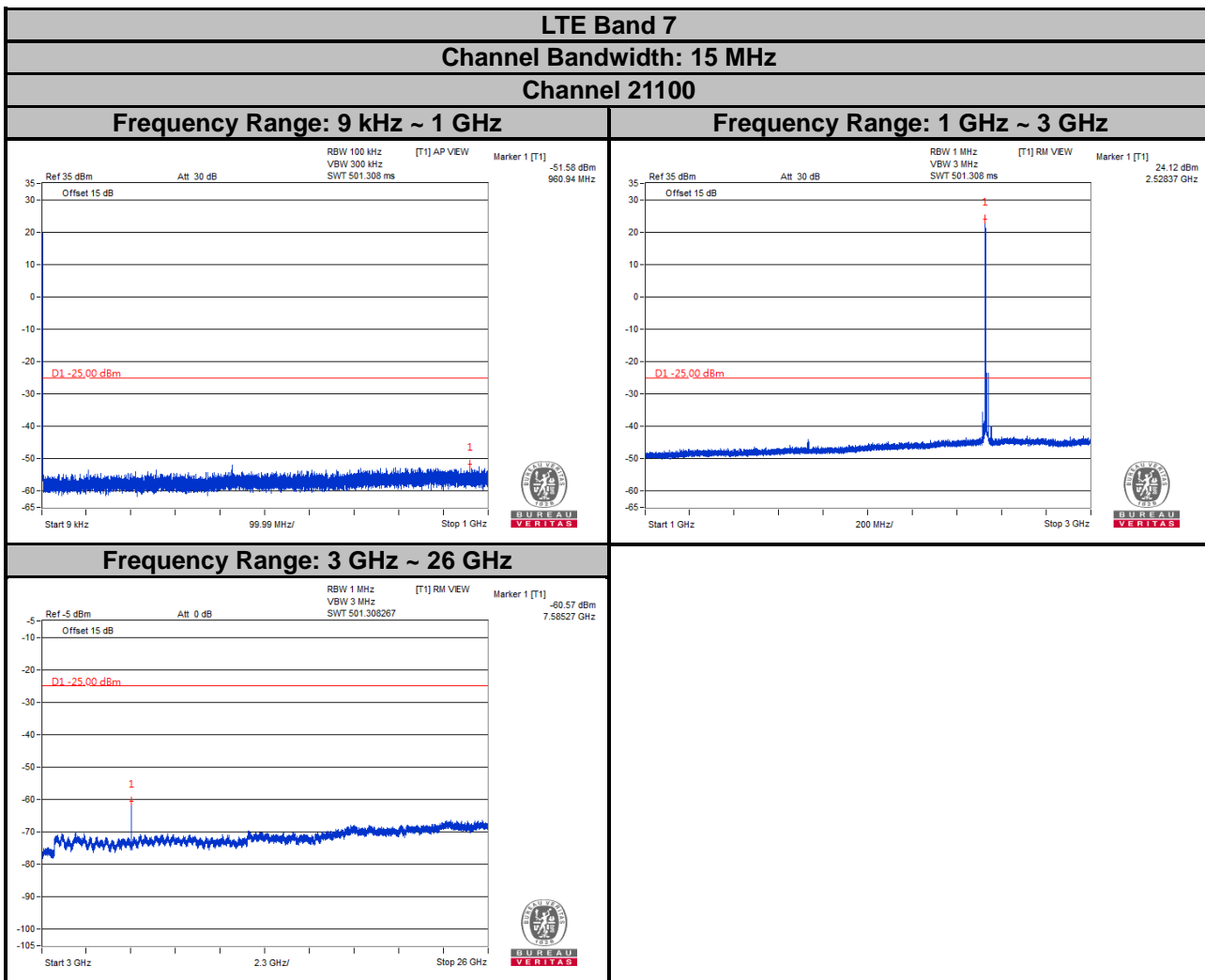

Note: The signal over the limit in 9 kHz is from spectrum analyzer.

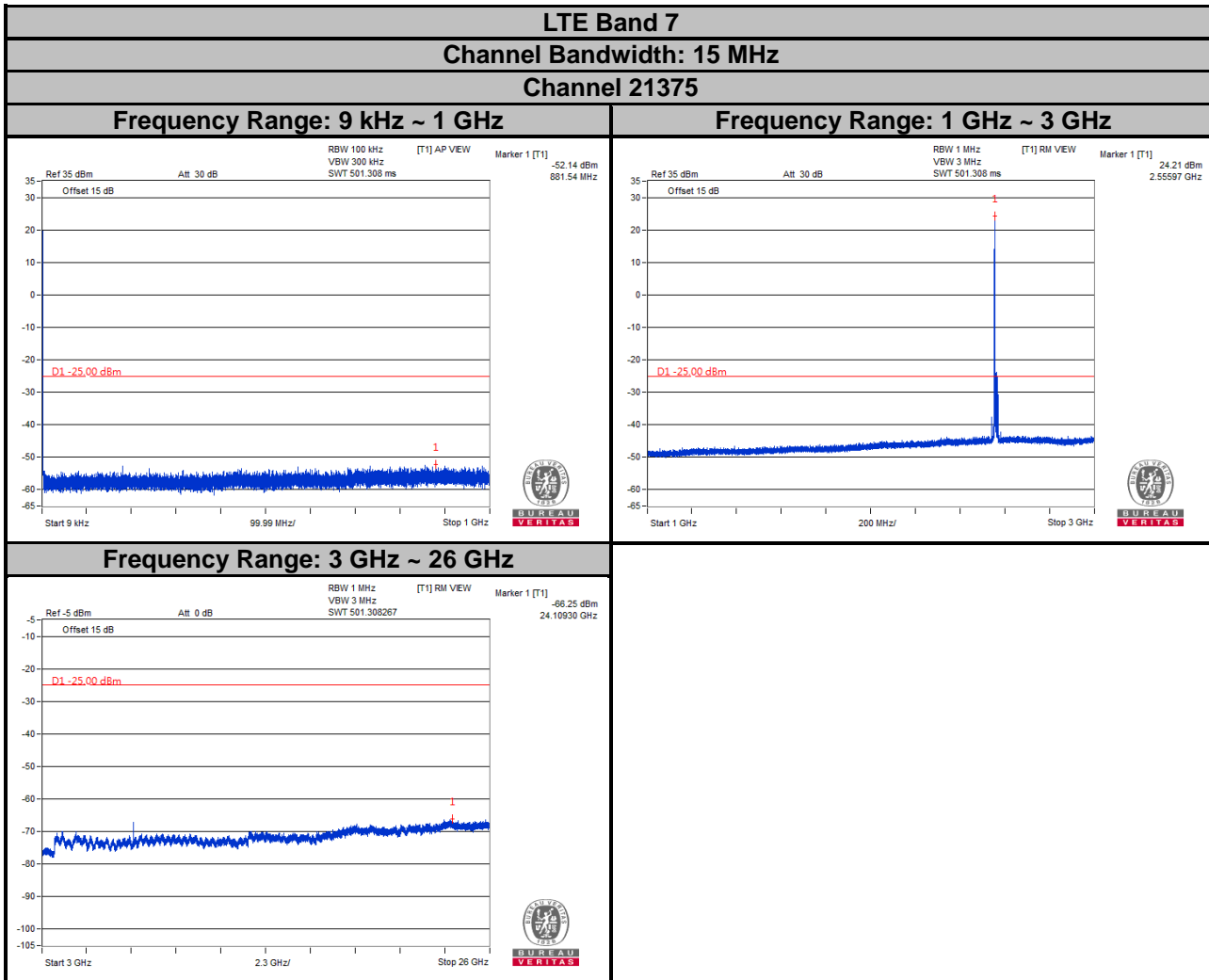

Note: The signal over the limit in 9 kHz is from spectrum analyzer.

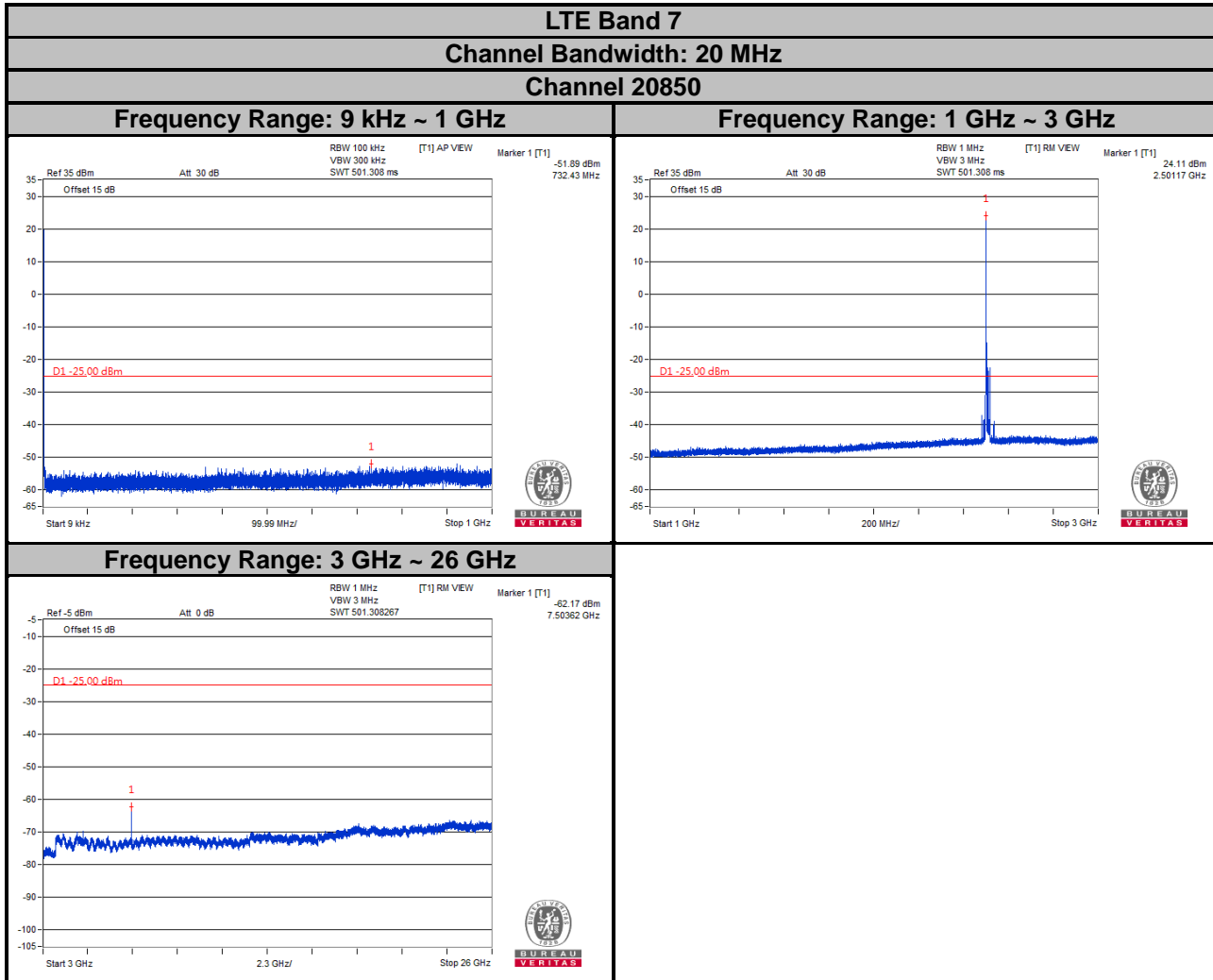

Note: The signal over the limit in 9 kHz is from spectrum analyzer.

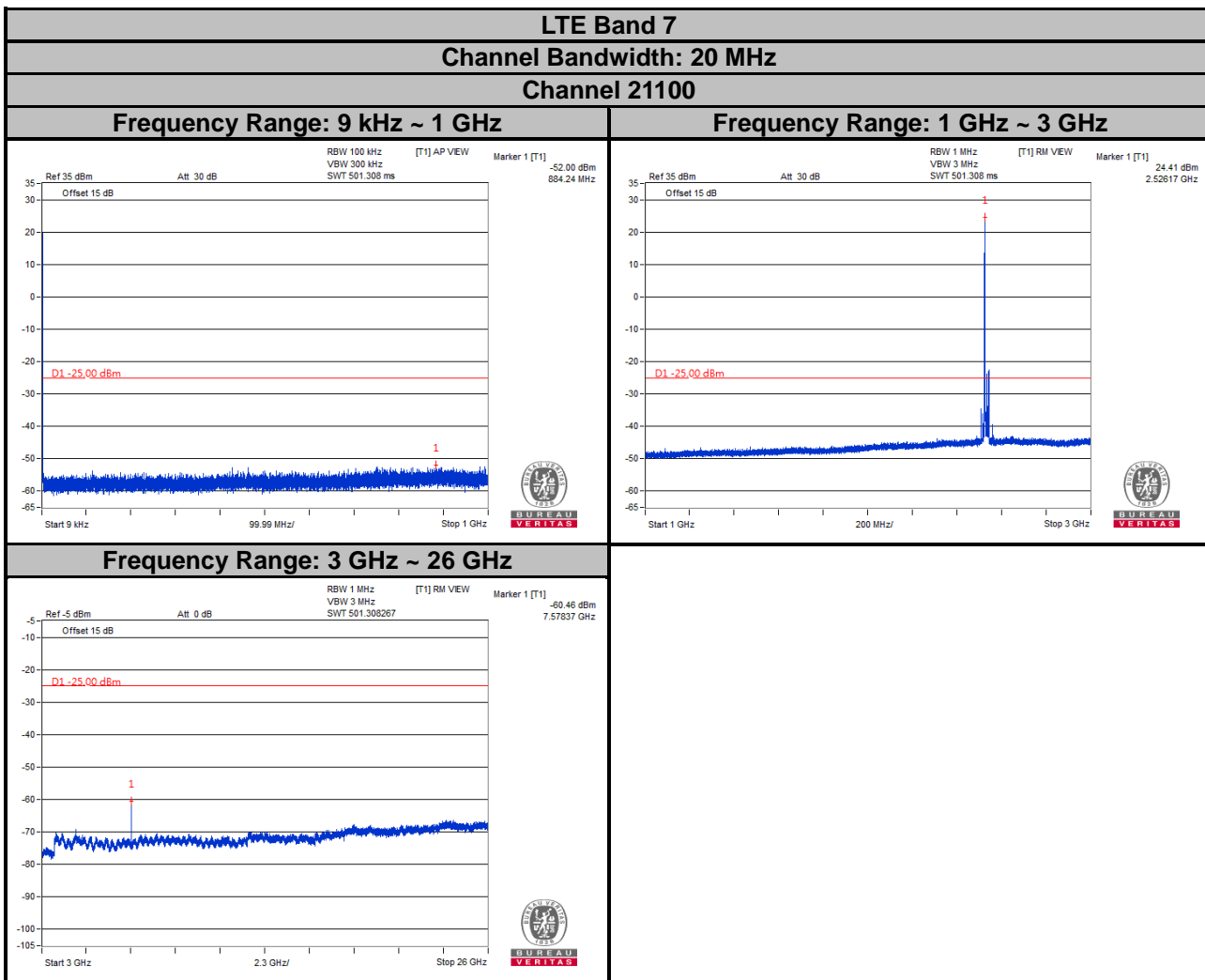

Note: The signal over the limit in 9 kHz is from spectrum analyzer.

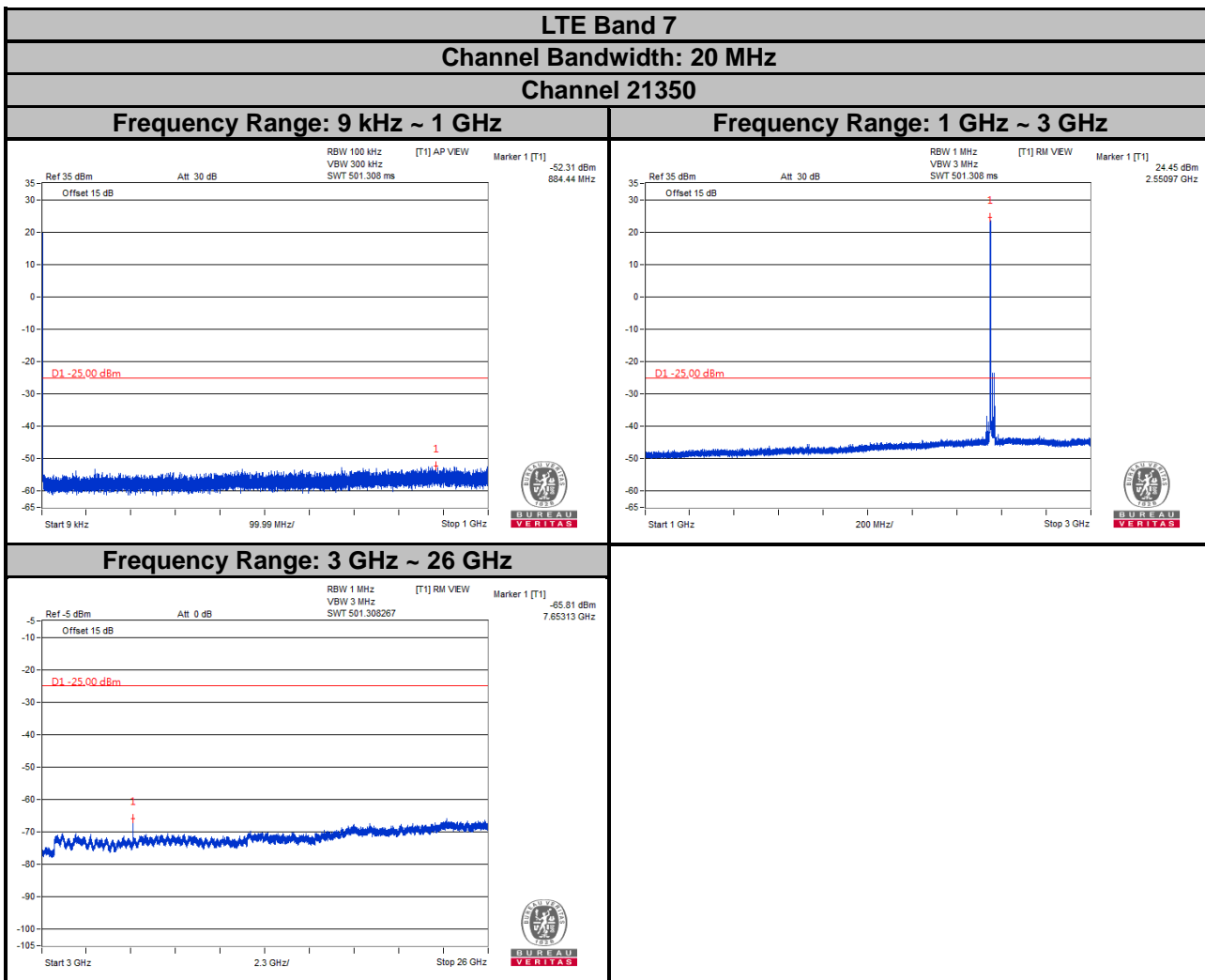

Note: The signal over the limit in 9 kHz is from spectrum analyzer.

4.8 Radiated Emission Measurement

4.8.1 Limits of Radiated Emission Measurement

The power of any emission outside a licensee's frequency block shall be attenuated below the transmitter power (P) by at least $55 + 10 \log (P)$ dB. The limit of emission is equal to -25 dBm.

4.8.2 Test Procedure

- a. Substitution method is used for E.I.R.P measurement. In the semi-anechoic chamber, EUT placed on the 0.8 m (below or equal 1 GHz) and/or 1.5 m (above 1 GHz) height of Turn Table, rotated the table around 360 degrees to search the maximum radiation power and receiver antenna shall be rotated vertical and horizontal polarization and moved height from 1 m to 4 m to find the maximum polar radiated power. The "Read Value" is the spectrum reading the maximum power value.
- b. The substitution horn antenna is substituted for EUT at the same position and signals generator export the CW signal to the substitution antenna via a TX cable. Rotated the Turn Table and moved receiving antenna to find the maximum radiation power. Adjust output power level of S.G to get a Value of spectrum reading equal to "Read Value" of step a. Record the power level of S.G.
- c. EIRP = Output power level of S.G – TX cable loss + Antenna gain of substitution horn.
- d. E.R.P power can be calculated form E.I.R.P power by subtracting the gain of dipole, E.R.P power = E.I.R.P power - 2.15 dB.

NOTE: The resolution bandwidth of spectrum analyzer is 1 MHz and the video bandwidth is 3 MHz.

4.8.3 Deviation from Test Standard

No deviation.

4.8.4 Test Setup

<Radiated Emission below or equal 1 GHz>

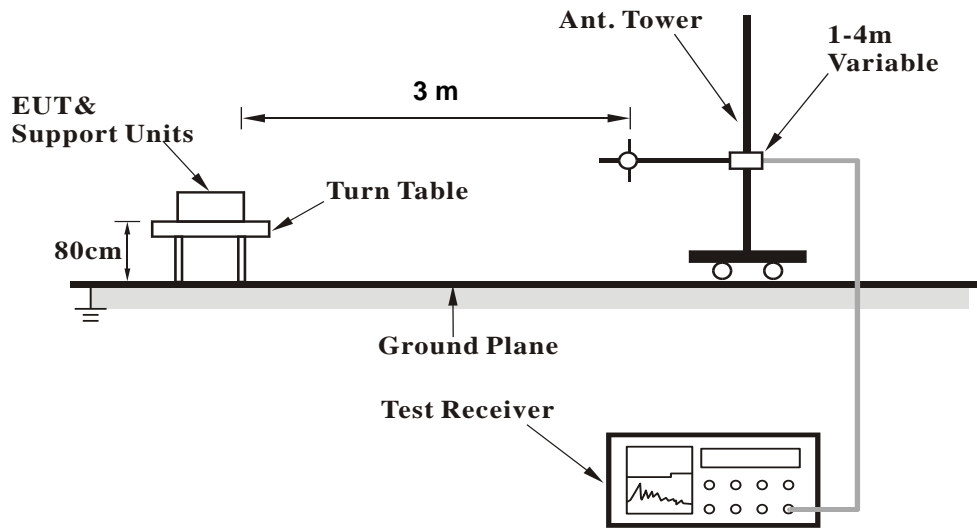

<Radiated Emission above 1 GHz>

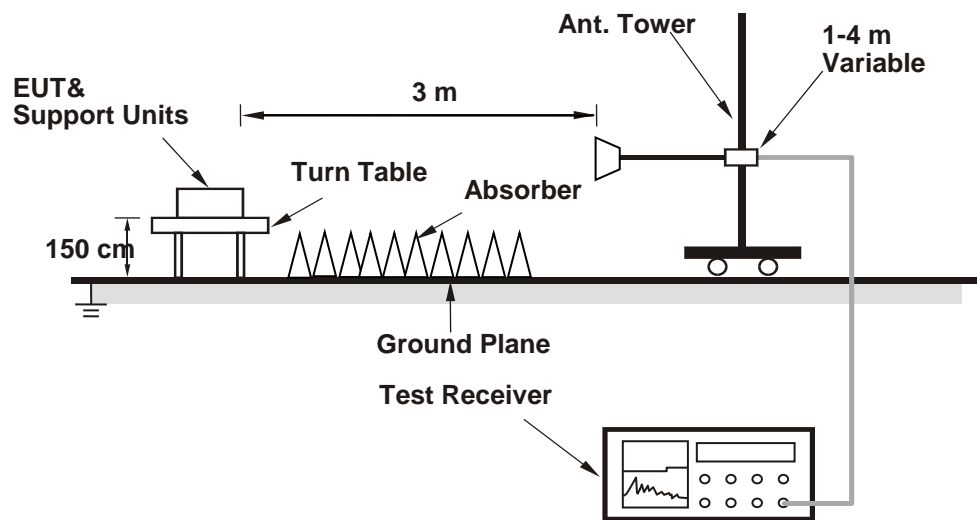

For the actual test configuration, please refer to the attached file (Test Setup Photo).

4.8.5 Test Results

LTE Band 7

Channel Bandwidth: 5 MHz / QPSK

Low Channel



Bureau Veritas Consumer Products Services Ltd., Taoyuan Branch

A D T

Data: 9

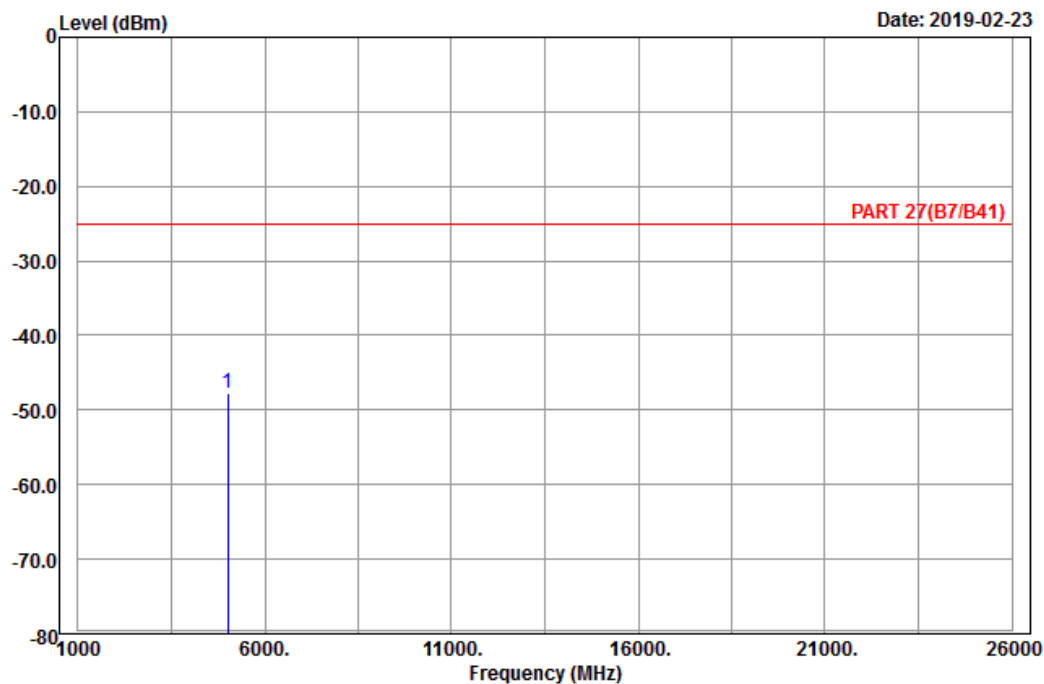

Site : 966 chamber 1
 Condition: PART 27(B7/B41) Horizontal
 Remark : LTE_Band 7_Link_CH20775
 Tested by: Karl Lee

	Read	Limit	Over			
Freq	Level	Level	Line	Limit	Factor	Remark
MHz	dBm	dBm	dBm	dB	dB	
1 pp 5005.00	-47.81	-67.39	-25.00	-22.81	19.58	Peak



Bureau Veritas Consumer Products Services Ltd., Taoyuan Branch

A D T

Data: 10

Date: 2019-02-23

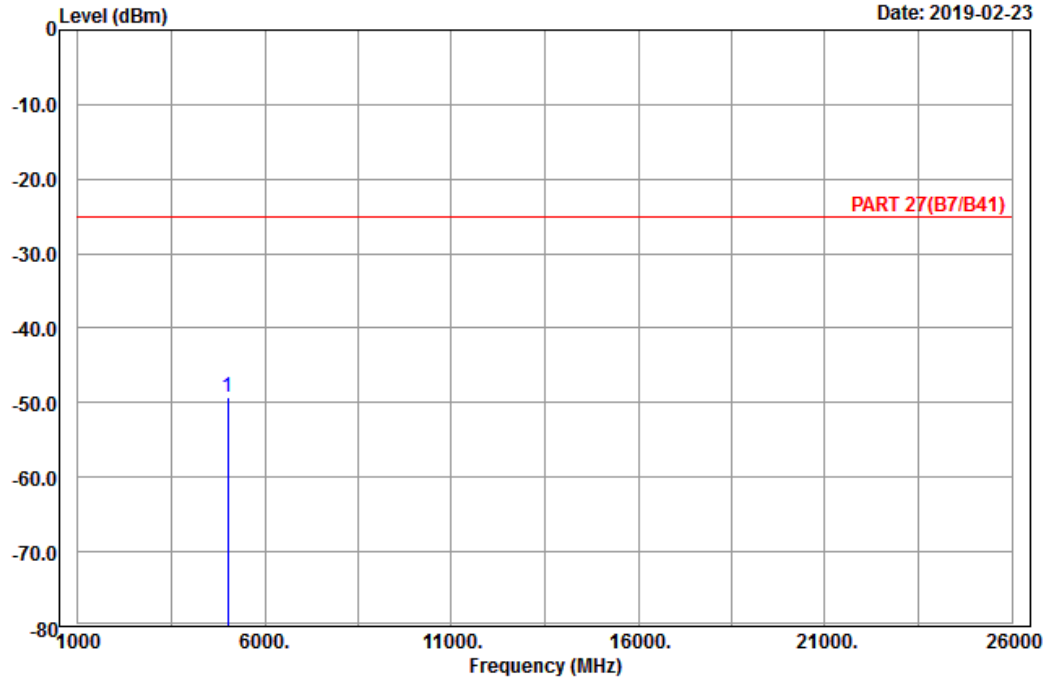

Site : 966 chamber 1
 Condition: PART 27(B7/B41) Vertical
 Remark : LTE_Band 7_Link_CH20775
 Tested by: Karl Lee

	Read	Limit	Over			
Freq	Level	Level	Line	Limit	Factor	Remark
MHz	dBm	dBm	dBm	dB	dB	
1 pp 5005.00	-49.17	-68.75	-25.00	-24.17	19.58	Peak

Middle Channel



Bureau Veritas Consumer Products Services Ltd., Taoyuan Branch

A D T

Data: 9

Date: 2019-02-23

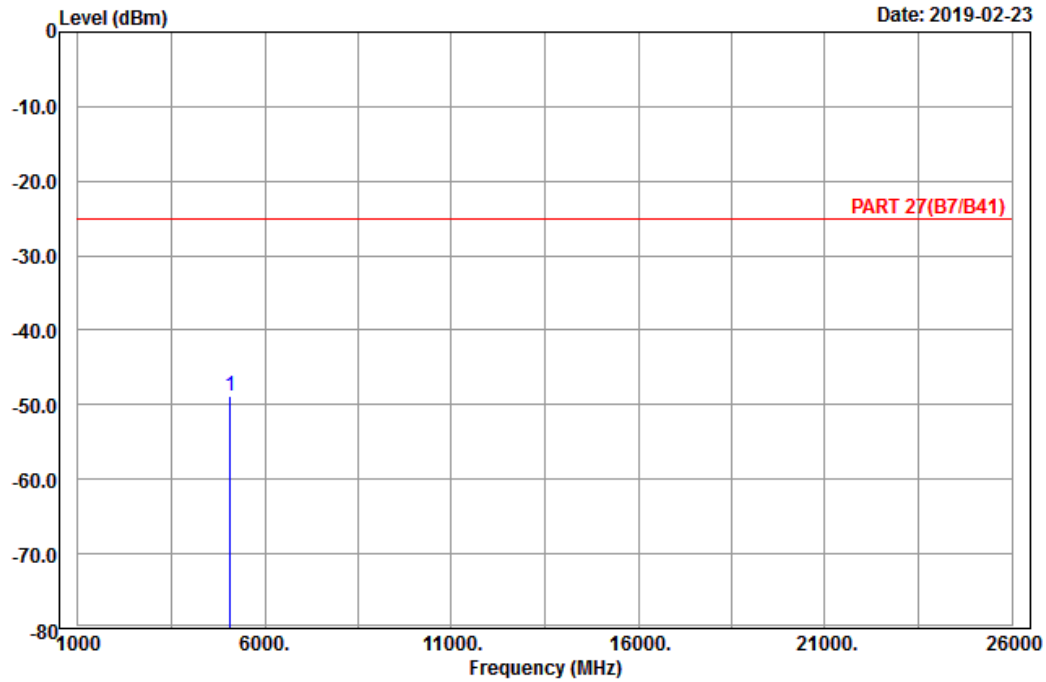

Site : 966 chamber 1
 Condition: PART 27(B7/B41) Horizontal
 Remark : LTE_Band 7_Link_CH21100
 Tested by: Karl Lee

Freq	Level	Read Level	Limit Line	Over Limit	Factor	Remark
MHz	dBm	dBm	dBm	dB	dB	
1 pp 5070.00	-48.90	-68.29	-25.00	-23.90	19.39	Peak



Bureau Veritas Consumer Products Services Ltd., Taoyuan Branch

A D T

Data: 10

Date: 2019-02-23

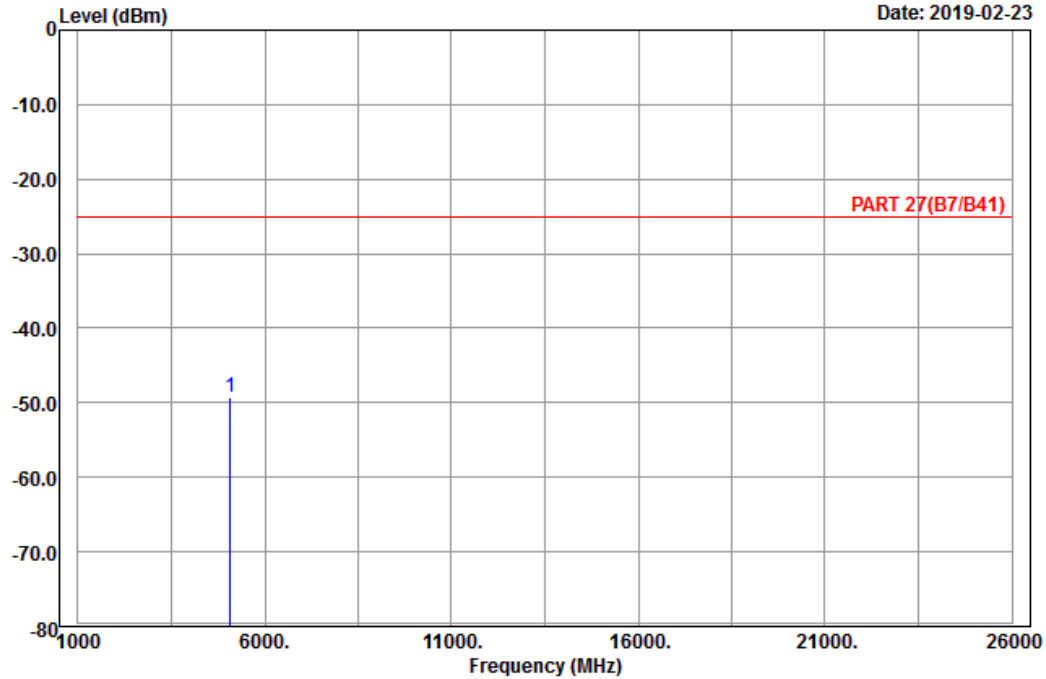

Site : 966 chamber 1
 Condition: PART 27(B7/B41) Vertical
 Remark : LTE_Band 7_Link_CH21100
 Tested by: Karl Lee

	Read	Limit	Over			
Freq	Level	Level	Line	Limit	Factor	Remark
MHz	dBm	dBm	dBm	dB	dB	
1 pp 5070.00	-49.32	-68.71	-25.00	-24.32	19.39	Peak

High Channel



Bureau Veritas Consumer Products Services Ltd., Taoyuan Branch

A D T

Data: 9

Date: 2019-02-23

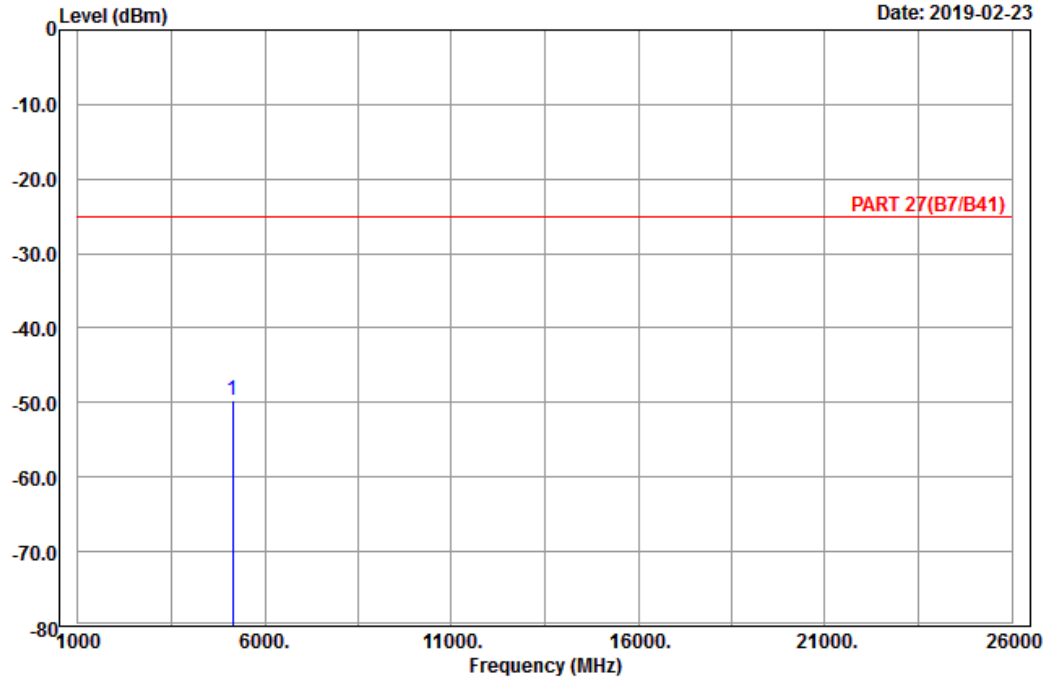

Site : 966 chamber 1
 Condition: PART 27(B7/B41) Horizontal
 Remark : LTE_Band 7_Link_CH21425
 Tested by: Karl Lee

	Read	Limit	Over		
Freq	Level	Level	Line	Limit	Factor Remark
MHz	dBm	dBm	dBm	dB	dB
1 pp 5135.00	-49.60	-69.41	-25.00	-24.60	19.81 Peak



Bureau Veritas Consumer Products Services Ltd., Taoyuan Branch

A D T

Data: 10

Date: 2019-02-23

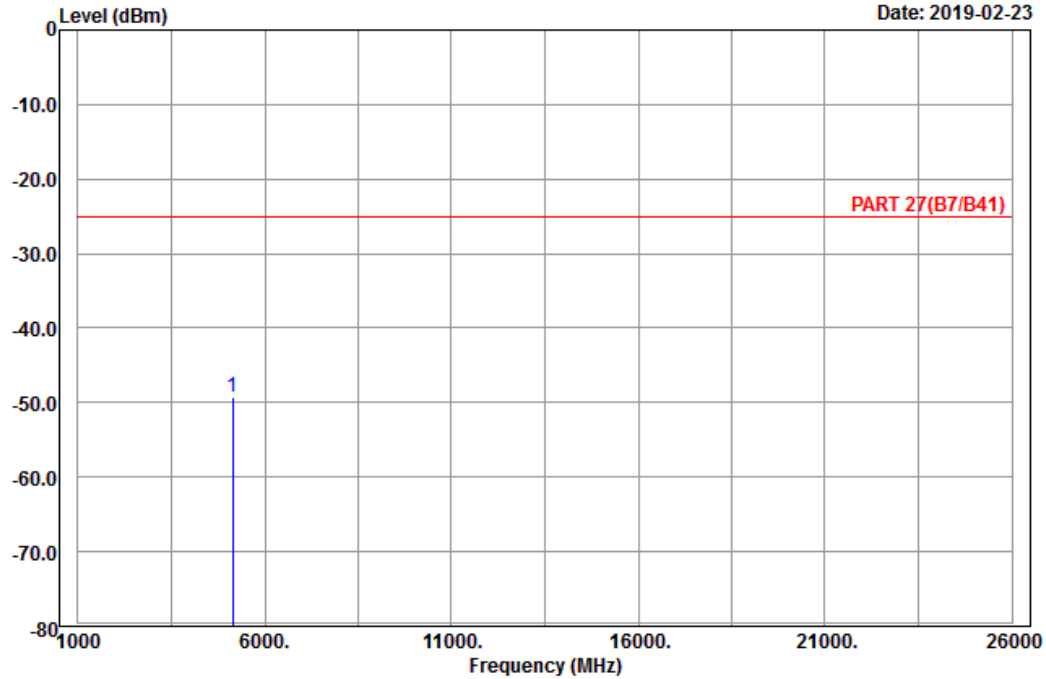

Site : 966 chamber 1
 Condition: PART 27(B7/B41) Vertical
 Remark : LTE_Band 7_Link_CH21425
 Tested by: Karl Lee

	Read	Limit	Over			
Freq	Level	Level	Line	Limit	Factor	Remark
MHz	dBm	dBm	dBm	dB	dB	
1 pp 5135.00	-49.21	-69.02	-25.00	-24.21	19.81	Peak

Channel Bandwidth: 20 MHz / QPSK
Low Channel



Bureau Veritas Consumer Products Services Ltd., Taoyuan Branch

A D T

Data: 9

Date: 2019-02-23

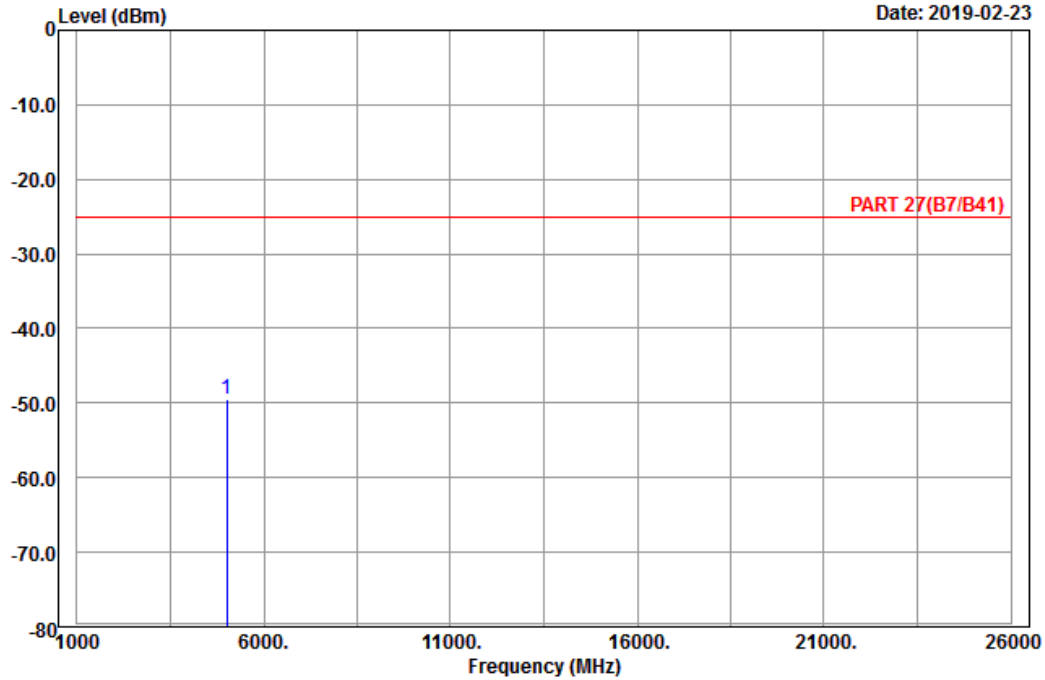

Site : 966 chamber 1
Condition: PART 27(B7/B41) Horizontal
Remark : LTE_Band 7_Link_CH20850
Tested by: Karl Lee

	Read	Limit	Over			
Freq	Level	Level	Line	Limit	Factor	Remark
MHz	dBm	dBm	dBm	dB	dB	
1 pp 5020.00	-49.44	-68.52	-25.00	-24.44	19.08	Peak



Bureau Veritas Consumer Products Services Ltd., Taoyuan Branch

A D T

Data: 10

Date: 2019-02-23

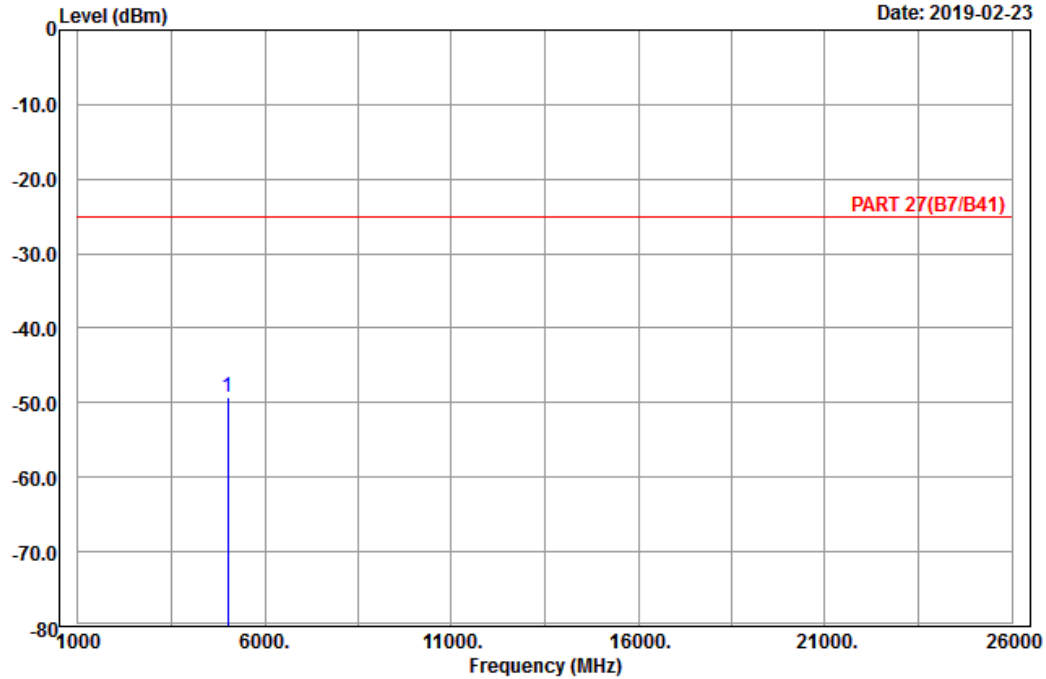

Site : 966 chamber 1
 Condition: PART 27(B7/B41) Vertical
 Remark : LTE_Band 7_Link_CH20850
 Tested by: Karl Lee

	Read	Limit	Over			
Freq	Level	Level	Line	Limit	Factor	Remark
MHz	dBm	dBm	dBm	dB	dB	
1 pp 5020.00	-49.25	-68.33	-25.00	-24.25	19.08	Peak

Middle Channel



Bureau Veritas Consumer Products Services Ltd., Taoyuan Branch

A D T

Data: 13

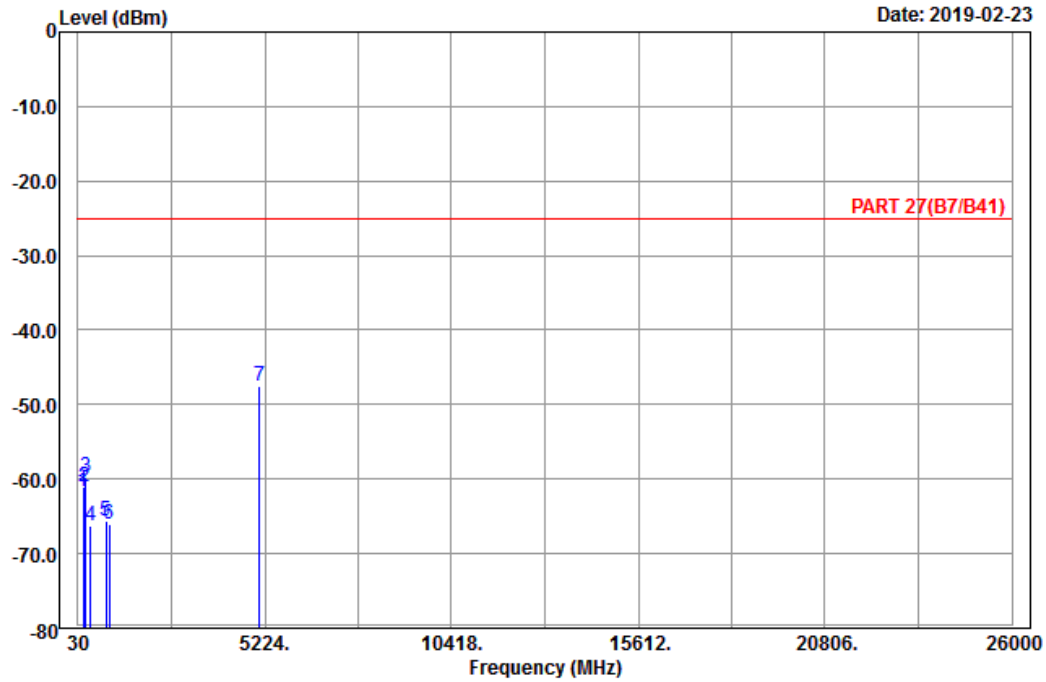

Site : 966 chamber 1
 Condition: PART 27(B7/B41) Horizontal
 Remark : LTE_Band 7_Link_CH21100
 Tested by: Karl Lee

	Read	Limit	Over				
Freq	Level	Level	Line	Limit	Factor	Remark	
MHz	dBm	dBm	dBm	dB	dB		
1	177.69	-61.67	-55.79	-25.00	-36.67	-5.88	Peak
2	197.94	-60.98	-54.89	-25.00	-35.98	-6.09	Peak
3	246.81	-59.73	-54.18	-25.00	-34.73	-5.55	Peak
4	381.20	-66.35	-62.63	-25.00	-41.35	-3.72	Peak
5	801.20	-65.65	-67.65	-25.00	-40.65	2.00	Peak
6	890.80	-66.08	-68.69	-25.00	-41.08	2.61	Peak
7 pp	5070.00	-47.58	-66.97	-25.00	-22.58	19.39	Peak



Bureau Veritas Consumer Products Services Ltd., Taoyuan Branch

A D T

Data: 14

Date: 2019-02-23

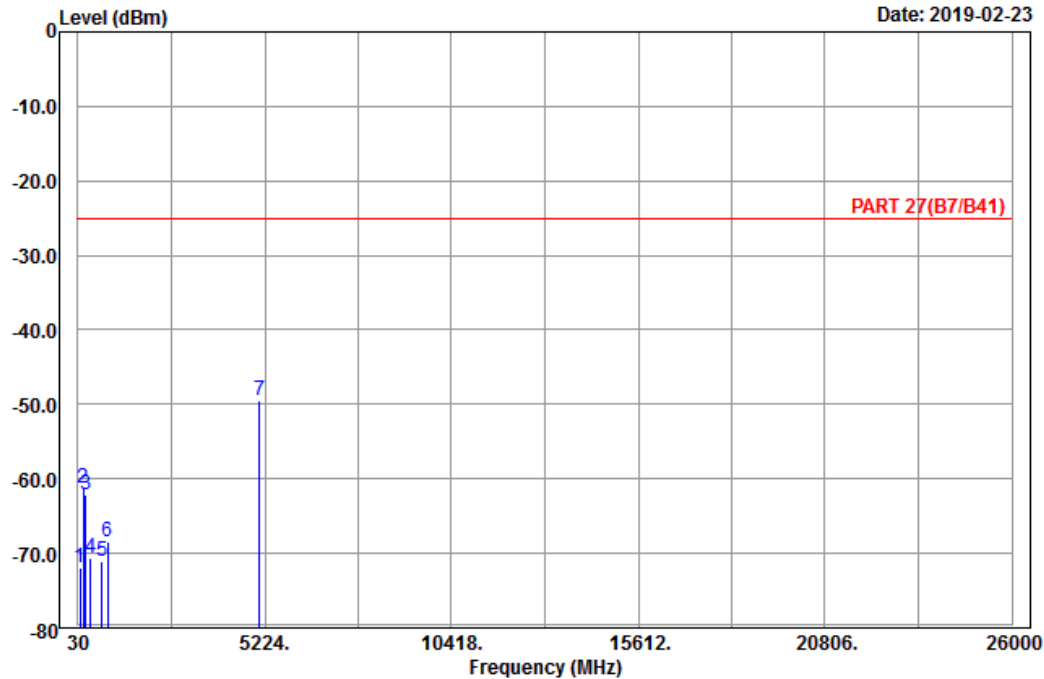

Site : 966 chamber 1
 Condition: PART 27(B7/B41) Vertical
 Remark : LTE_Band 7_Link_CH21100
 Tested by: Karl Lee

	Freq	Level	Read Level	Limit Line	Over Limit	Factor	Remark
	MHz	dBm	dBm	dBm	dB	dB	
1	86.16	-71.94	-60.83	-25.00	-46.94	-11.11	Peak
2	186.60	-61.15	-55.48	-25.00	-36.15	-5.67	Peak
3	247.89	-62.23	-56.70	-25.00	-37.23	-5.53	Peak
4	386.80	-70.61	-67.20	-25.00	-45.61	-3.41	Peak
5	707.40	-70.96	-70.45	-25.00	-45.96	-0.51	Peak
6	864.20	-68.43	-70.29	-25.00	-43.43	1.86	Peak
7 pp	5070.00	-49.55	-68.94	-25.00	-24.55	19.39	Peak

High Channel



Bureau Veritas Consumer Products Services Ltd., Taoyuan Branch

A D T

Data: 9

Date: 2019-02-23

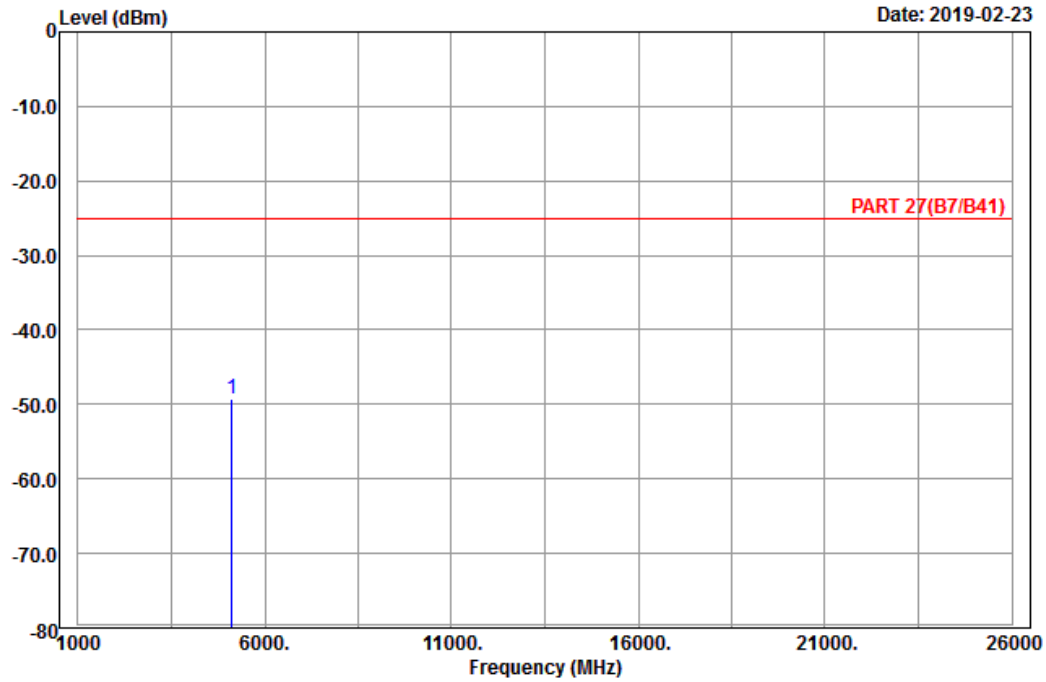

Site : 966 chamber 1
 Condition: PART 27(B7/B41) Horizontal
 Remark : LTE_Band 7_Link_CH21350
 Tested by: Karl Lee

	Read	Limit	Over		
Freq	Level	Level	Line	Limit	Factor Remark
MHz	dBm	dBm	dBm	dB	dB
1 pp 5120.00	-49.29	-69.00	-25.00	-24.29	19.71 Peak



Bureau Veritas Consumer Products Services Ltd., Taoyuan Branch

A D T

Data: 10

Date: 2019-02-23

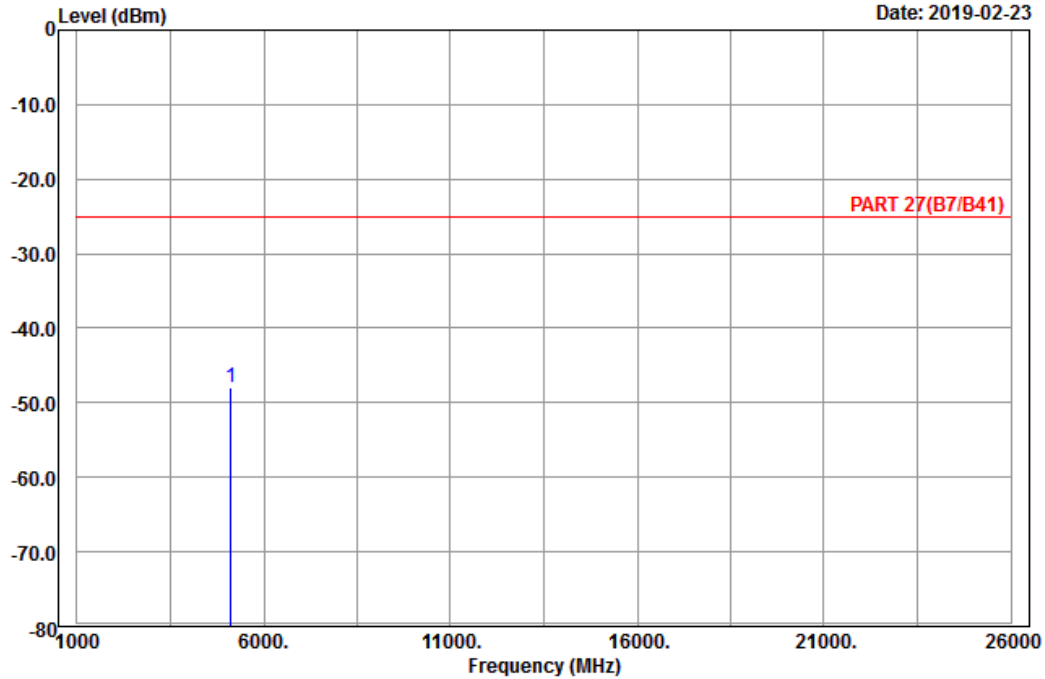

Site : 966 chamber 1
 Condition: PART 27(B7/B41) Vertical
 Remark : LTE_Band 7_Link_CH21350
 Tested by: Karl Lee

	Read	Limit	Over			
Freq	Level	Level	Line	Limit	Factor	Remark
MHz	dBm	dBm	dBm	dB	dB	
1 pp 5120.00	-48.04	-67.75	-25.00	-23.04	19.71	Peak

5 Pictures of Test Arrangements

Please refer to the attached file (Test Setup Photo).

Appendix – Information of the Testing Laboratories

We, Bureau Veritas Consumer Products Services (H.K.) Ltd., Taoyuan Branch, were founded in 1988 to provide our best service in EMC, Radio, Telecom and Safety consultation. Our laboratories are FCC recognized accredited test firms and accredited according to ISO/IEC 17025.

If you have any comments, please feel free to contact us at the following:

Lin Kou EMC/RF Lab

Tel: 886-2-26052180

Fax: 886-2-26051924

Hsin Chu EMC/RF/Telecom Lab

Tel: 886-3-6668565

Fax: 886-3-6668323

Hwa Ya EMC/RF/Safety

Tel: 886-3-3183232

Fax: 886-3-3270892

Email: service.adt@tw.bureauveritas.com

Web Site: www.bureauveritas-adt.com

The address and road map of all our labs can be found in our web site also.

--- END ---