

FCC Test Report

Report No.: RF190211C01-1

FCC ID: B32CM5

Test Model: CM5

Received Date: Feb. 11, 2019

Test Date: Feb. 14, 2019 ~ Mar. 06, 2019

Issued Date: Mar. 20, 2019

Applicant: Verifone, Inc.

Address: 1400 West Stanford Ranch Road Suite 200 Rocklin CA 95765 USA

Issued By: Bureau Veritas Consumer Products Services (H.K.) Ltd., Taoyuan Branch

Lab Address: No. 47-2, 14th Ling, Chia Pau Vil., Lin Kou Dist., New Taipei City, Taiwan
(R.O.C)

Test Location (1): No.19, Hwa Ya 2nd Rd., Wen Hwa Vil., Kwei Shan Dist., Taoyuan City
33383, Taiwan, R.O.C.

Test Location (2): B2F., No.215, Sec. 3, Beixin Rd., Xindian Dist., New Taipei City 231,
Taiwan, R.O.C

**FCC Registration /
Designation Number:** 427177 / TW0011



This report is for your exclusive use. Any copying or replication of this report to or for any other person or entity, or use of our name or trademark, is permitted only with our prior written permission. This report sets forth our findings solely with respect to the test samples identified herein. The results set forth in this report are not indicative or representative of the quality or characteristics of the lot from which a test sample was taken or any similar or identical product unless specifically and expressly noted. Our report includes all of the tests requested by you and the results thereof based upon the information that you provided to us. You have 60 days from date of issuance of this report to notify us of any material error or omission caused by our negligence, provided, however, that such notice shall be in writing and shall specifically address the issue you wish to raise. A failure to raise such issue within the prescribed time shall constitute your unqualified acceptance of the completeness of this report, the tests conducted and the correctness of the report contents. Unless specific mention, the uncertainty of measurement has been explicitly taken into account to declare the compliance or non-compliance to the specification. The report must not be used by the client to claim product certification, approval, or endorsement by TAF or any government agencies.

Table of Contents

Release Control Record	4
1 Certificate of Conformity	5
2 Summary of Test Results	6
2.1 Measurement Uncertainty	6
2.2 Modification Record	6
3 General Information	7
3.1 General Description of EUT	7
3.2 Description of Test Modes	8
3.2.1 Test Mode Applicability and Tested Channel Detail	9
3.3 Duty Cycle of Test Signal	10
3.4 Description of Support Units	11
3.4.1 Configuration of System under Test	11
3.5 General Description of Applied Standards	11
4 Test Types and Results	12
4.1 Radiated Emission and Bandedge Measurement	12
4.1.1 Limits of Radiated Emission and Bandedge Measurement	12
4.1.2 Test Instruments	13
4.1.3 Test Procedures	14
4.1.4 Deviation from Test Standard	14
4.1.5 Test Set Up	15
4.1.6 EUT Operating Conditions	16
4.1.7 Test Results	17
4.2 Conducted Emission Measurement	22
4.2.1 Limits of Conducted Emission Measurement	22
4.2.2 Test Instruments	22
4.2.3 Test Procedures	22
4.2.4 Deviation from Test Standard	23
4.2.5 Test Setup	23
4.2.6 EUT Operating Conditions	23
4.2.7 Test Results	24
4.3 6 dB Bandwidth Measurement	26
4.3.1 Limits of 6 dB Bandwidth Measurement	26
4.3.2 Test Setup	26
4.3.3 Test Instruments	26
4.3.4 Test Procedure	26
4.3.5 Deviation from Test Standard	26
4.3.6 EUT Operating Conditions	26
4.3.7 Test Results	27
4.4 Occupied Bandwidth Measurement	28
4.4.1 Test Setup	28
4.4.2 Test Instruments	28
4.4.3 Test Procedure	28
4.4.4 Deviation from Test Standard	28
4.4.5 EUT Operating Conditions	28
4.4.6 Test Results	29
4.5 Conducted Output Power Measurement	30
4.5.1 Limits of Conducted Output Power Measurement	30
4.5.2 Test Setup	30
4.5.3 Test Instruments	30
4.5.4 Test Procedures	30
4.5.5 Deviation from Test Standard	30
4.5.6 EUT Operating Conditions	30
4.5.7 Test Results	30

4.6	Power Spectral Density Measurement	31
4.6.1	Limits of Power Spectral Density Measurement.....	31
4.6.2	Test Setup.....	31
4.6.3	Test Instruments	31
4.6.4	Test Procedure	31
4.6.5	Deviation from Test Standard	31
4.6.6	EUT Operating Condition	31
4.6.7	Test Results	32
4.7	Conducted Out of Band Emission Measurement	33
4.7.1	Limits of Conducted Out of Band Emission Measurement.....	33
4.7.2	Test Setup.....	33
4.7.3	Test Instruments	33
4.7.4	Test Procedure	33
4.7.5	Deviation from Test Standard	33
4.7.6	EUT Operating Condition	33
4.7.7	Test Results	34
5	Pictures of Test Arrangements.....	36
	Appendix – Information of the Testing Laboratories	37

Release Control Record

Issue No.	Description	Date Issued
RF190211C01-1	Original Release	Mar. 20, 2019

1 Certificate of Conformity

Product: Point of Sale Terminal

Brand: Verifone

Test Model: CM5

Sample Status: Identical Prototype

Applicant: Verifone, Inc.

Test Date: Feb. 14, 2019 ~ Mar. 06, 2019

Standards: 47 CFR FCC Part 15, Subpart C (Section 15.247)
ANSI C63.10:2013

The above equipment has been tested by **Bureau Veritas Consumer Products Services (H.K.) Ltd., Taoyuan Branch**, and found compliance with the requirement of the above standards. The test record, data evaluation & Equipment Under Test (EUT) configurations represented herein are true and accurate accounts of the measurements of the sample's RF characteristics under the conditions specified in this report.

Prepared by :



Date: Mar. 20, 2019

Ivonne Wu / Supervisor

Approved by :



Date: Mar. 20, 2019

Dylan Chiou / Project Engineer

2 Summary of Test Results

47 CFR FCC Part 15, Subpart C (Section 15.247)			
FCC Clause	Test Item	Result	Remarks
15.207	AC Power Conducted Emission	Pass	Meet the requirement of limit. Minimum passing margin is -15.17 dB at 0.79063 MHz.
15.205 & 209	Radiated Emissions	Pass	Meet the requirement of limit. Minimum passing margin is -12.04 dB at 62.94 MHz.
15.247(d)	Band Edge Measurement	Pass	Meet the requirement of limit.
15.247(d)	Antenna Port Emission	Pass	Meet the requirement of limit.
15.247(a)(2)	6 dB Bandwidth	Pass	Meet the requirement of limit.
---	Occupied Bandwidth Measurement	Pass	Reference only
15.247(b)	Conducted Power	Pass	Meet the requirement of limit.
15.247(e)	Power Spectral Density	Pass	Meet the requirement of limit.
15.203	Antenna Requirement	Pass	No antenna connector is used.

Note: Determining compliance based on the results of the compliance measurement, not taking into account measurement instrumentation uncertainty.

2.1 Measurement Uncertainty

Where relevant, the following measurement uncertainty levels have been estimated for tests performed on the EUT as specified in CISPR 16-4-2:

Measurement	Frequency	Expanded Uncertainty (k=2) (±)
Conducted Emissions at mains ports	150 kHz ~ 30 MHz	2.44 dB
Radiated Emissions up to 1 GHz	9 kHz ~ 30 MHz	3.04 dB
	30 MHz ~ 200 MHz	2.0153 dB
	200 MHz ~ 1000 MHz	2.0224 dB
Radiated Emissions above 1 GHz	1 GHz ~ 18 GHz	1.0121 dB
	18 GHz ~ 40 GHz	1.1508 dB

2.2 Modification Record

There were no modifications required for compliance.

3 General Information

3.1 General Description of EUT

Product	Point of Sale Terminal
Brand	Verifone
Test Model	CM5
Status of EUT	Identical Prototype
Power Supply Rating	5.0 Vdc (adapter or host equipment) 3.85 Vdc (Li-ion battery)
Modulation Type	GFSK
Transfer Rate	1 Mbps
Operating Frequency	2402 ~ 2480 MHz
Number of Channel	40
Output Power	0.9376 mW
Antenna Type	Monopole antenna with 1.7 dBi gain
Antenna Connector	N/A
Accessory Device	Refer to Note as below
Data Cable Supplied	Refer to Note as below

Note:

1. The EUT's accessories list refers to Ext. Pho.
2. The above EUT information is declared by manufacturer and for more detailed features description, please refers to the manufacturer's specifications or User's Manual.

3.2 Description of Test Modes

40 channels are provided to this EUT:

Channel	Freq. (MHz)	Channel	Freq. (MHz)	Channel	Freq. (MHz)	Channel	Freq. (MHz)
0	2402	10	2422	20	2442	30	2462
1	2404	11	2424	21	2444	31	2464
2	2406	12	2426	22	2446	32	2466
3	2408	13	2428	23	2448	33	2468
4	2410	14	2430	24	2450	34	2470
5	2412	15	2432	25	2452	35	2472
6	2414	16	2434	26	2454	36	2474
7	2416	17	2436	27	2456	37	2476
8	2418	18	2438	28	2458	38	2478
9	2420	19	2440	29	2460	39	2480

3.2.1 Test Mode Applicability and Tested Channel Detail

EUT Configure Mode	Applicable To				Description
	RE \geq 1G	RE<1G	PLC	APCM	
-	√	√	√	√	-

Where **RE \geq 1G**: Radiated Emission above 1 GHz **RE<1G**: Radiated Emission below 1 GHz
PLC: Power Line Conducted Emission **APCM**: Antenna Port Conducted Measurement

Note: The EUT had been pre-tested on the positioned of each 3 axis. The worst case was found when positioned on **Z-plane**.
Note: “-” means no effect.

Radiated Emission Test (Above 1 GHz):

- Pre-Scan has been conducted to determine the worst-case mode from all possible combinations between available modulations, data rates and antenna ports (if EUT with antenna diversity architecture).
- Following channel(s) was (were) selected for the final test as listed below.

EUT Configure Mode	Available Channel	Tested Channel	Modulation Type	Data Rate (Mbps)
-	0 to 39	0, 19, 39	GFSK	1

Radiated Emission Test (Below 1 GHz):

- Pre-Scan has been conducted to determine the worst-case mode from all possible combinations between available modulations, data rates and antenna ports (if EUT with antenna diversity architecture).
- Following channel(s) was (were) selected for the final test as listed below.

EUT Configure Mode	Available Channel	Tested Channel	Modulation Type	Data Rate (Mbps)
-	0 to 39	19	GFSK	1

Power Line Conducted Emission Test:

- Pre-Scan has been conducted to determine the worst-case mode from all possible combinations between available modulations, data rates and antenna ports (if EUT with antenna diversity architecture).
- Following channel(s) was (were) selected for the final test as listed below.

EUT Configure Mode	Available Channel	Tested Channel	Modulation Type	Data Rate (Mbps)
-	0 to 39	19	GFSK	1

Antenna Port Conducted Measurement:

- This item includes all test value of each mode, but only includes spectrum plot of worst value of each mode.
- Pre-Scan has been conducted to determine the worst-case mode from all possible combinations between available modulations, data rates and antenna ports (if EUT with antenna diversity architecture).
- Following channel(s) was (were) selected for the final test as listed below.

EUT Configure Mode	Available Channel	Tested Channel	Modulation Type	Data Rate (Mbps)
-	0 to 39	0, 19, 39	GFSK	1

Test Condition:

Applicable To	Environmental Conditions	Input Power	Tested by
RE≥1G	25 deg. C, 65 % RH	120 Vac, 60 Hz	Charles Hsiao
RE<1G	25 deg. C, 65 % RH	120 Vac, 60 Hz	Charles Hsiao
PLC	25 deg. C, 65 % RH	120 Vac, 60 Hz	Thomas Wei
APCM	25 deg. C, 65 % RH	3.85 Vdc	Gavin Wu

3.3 Duty Cycle of Test Signal

Duty cycle = 385/634 = 0.607, Duty factor = 10 * log(1/0.607) = 2.17

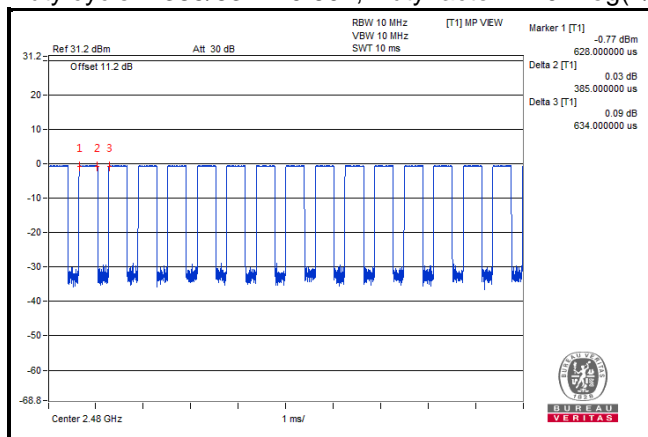

3.4 Description of Support Units

The EUT has been tested as an independent unit together with other necessary accessories or support units.

3.4.1 Configuration of System under Test

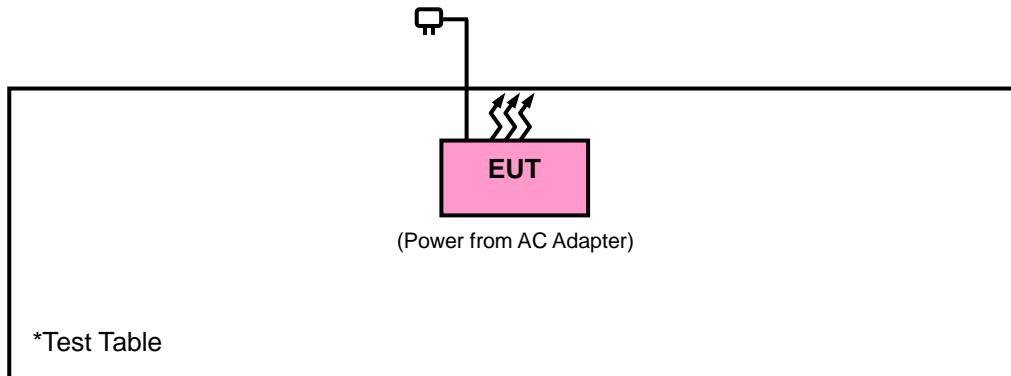

3.5 General Description of Applied Standards

The EUT is a RF Product. According to the specifications of the manufacturer, it must comply with the requirements of the following standards:

FCC Part 15, Subpart C (15.247)

KDB 558074 D01 15.247 Meas Guidance v05r01

ANSI C63.10-2013

All test items have been performed and recorded as per the above standards.

4 Test Types and Results

4.1 Radiated Emission and Bandedge Measurement

4.1.1 Limits of Radiated Emission and Bandedge Measurement

Radiated emissions which fall in the restricted bands must comply with the radiated emission limits specified as below table. Other emissions shall be at least 20 dB below the highest level of the desired power:

Frequencies (MHz)	Field Strength (microvolts/meter)	Measurement Distance (meters)
0.009 ~ 0.490	2400/F (kHz)	300
0.490 ~ 1.705	24000/F (kHz)	30
1.705 ~ 30.0	30	30
30 ~ 88	100	3
88 ~ 216	150	3
216 ~ 960	200	3
Above 960	500	3

Note:

1. The lower limit shall apply at the transition frequencies.
2. Emission level (dBuV/m) = 20 log Emission level (uV/m).
3. For frequencies above 1000 MHz, the field strength limits are based on average detector, however, the peak field strength of any emission shall not exceed the maximum permitted average limits, specified above by more than 20 dB under any condition of modulation.

4.1.2 Test Instruments

Description & Manufacturer	Model No.	Serial No.	Date of Calibration	Due Date of Calibration
Test Receiver Agilent Technologies	N9038A	MY52260177	Aug. 20, 2018	Aug. 19, 2019
Spectrum Analyzer ROHDE & SCHWARZ	FSV40	100980	Apr. 17, 2018	Apr. 16, 2019
HORN Antenna ETS-Lindgren	3117	00143293	Nov. 25, 2018	Nov. 24, 2019
BILOG Antenna SCHWARZBECK	VULB 9168	9168-616	Nov. 27, 2018	Nov. 26, 2019
HORN Antenna SCHWARZBECK	BBHA 9170	9170-480	Nov. 25, 2018	Nov. 24, 2019
Fixed Attenuator Mini-Circuits	MDCS18N-10	MDCS18N-10-01	Apr. 16, 2018	Apr. 15, 2019
Loop Antenna	EM-6879	269	Sep. 07, 2018	Sep. 06, 2019
Preamplifier Agilent	310N	187226	Jun. 19, 2018	Jun. 18, 2019
Preamplifier Agilent	83017A	MY39501357	Jun. 19, 2018	Jun. 18, 2019
Power Meter Anritsu	ML2495A	1012010	Sep. 05, 2018	Sep. 04, 2019
Power Sensor Anritsu	MA2411B	1315050	Sep. 04, 2018	Sep. 03, 2019
RF signal cable ETS-LINDGREN	5D-FB	Cable-CH1-01(R FC-SMS-100-SM S-120+RFC-SMS -100-SMS-400)	Jun. 19, 2018	Jun. 18, 2019
RF signal cable ETS-LINDGREN	8D-FB	Cable-CH1-02(R FC-SMS-100-SM S-24)	Jun. 19, 2018	Jun. 18, 2019
Boresight Antenna Fixture	FBA-01	FBA-SIP01	NA	NA
Software BV ADT	E3 8.130425b	NA	NA	NA
Antenna Tower MF	NA	NA	NA	NA
Turn Table MF	NA	NA	NA	NA
Antenna Tower & Turn Table Controller MF	MF-7802	NA	NA	NA

- Note: 1. The calibration interval of the above test instruments is 12 months and the calibrations are traceable to NML/ROC and NIST/USA.
2. The test was performed in HsinTien Chamber 1.
3. The horn antenna and preamplifier (model: 83017A) are used only for the measurement of emission frequency above 1 GHz if tested.
4. The IC Site Registration No. is 7450I-1.

4.1.3 Test Procedures

For Radiated Emission below 30 MHz

- a. The EUT was placed on the top of a rotating table 0.8 meters above the ground at a 3 meter chamber room. The table was rotated 360 degrees to determine the position of the highest radiation.
- b. The EUT was set 3 meters away from the interference-receiving antenna, which was mounted on the top of a variable-height antenna tower.
- c. Parallel, perpendicular, and ground-parallel orientations of the antenna are set to make the measurement.
- d. For each suspected emission, the EUT was arranged to its worst case and the rotatable table was turned from 0 degrees to 360 degrees to find the maximum reading.
- e. The test-receiver system was set to Quasi-Peak Detect Function and Specified Bandwidth with Maximum Hold Mode.

Note:

1. The resolution bandwidth and video bandwidth of test receiver/spectrum analyzer is 9 kHz at frequency below 30 MHz.

For Radiated Emission above 30 MHz

- a. The EUT was placed on the top of a rotating table 0.8 meters (for 30 MHz ~ 1 GHz) / 1.5 meters (for above 1 GHz) above the ground at 3 meter chamber room for test. The table was rotated 360 degrees to determine the position of the highest radiation.
- b. The EUT was set 3 meters away from the interference-receiving antenna, which was mounted on the top of a variable-height antenna tower.
- c. The height of antenna is varied from one meter to four meters above the ground to determine the maximum value of the field strength. Both horizontal and vertical polarizations of the antenna are set to make the measurement.
- d. For each suspected emission, the EUT was arranged to its worst case and then the antenna was tuned to heights from 1 meter to 4 meters and the rotatable table was turned from 0 degrees to 360 degrees to find the maximum reading.
- e. The test-receiver system was set to quasi-peak detect function and specified bandwidth with maximum hold mode when the test frequency is below 1 GHz.
- f. The test-receiver system was set to peak and average detected function and specified bandwidth with maximum hold mode when the test frequency is above 1 GHz. If the peak reading value also meets average limit, measurement with the average detector is unnecessary.

Note:

1. The resolution bandwidth and video bandwidth of test receiver/spectrum analyzer is 120 kHz for Quasi-peak detection (QP) or Peak detection (PK) at frequency below 1 GHz.
2. The resolution bandwidth of test receiver/spectrum analyzer is 1 MHz and the video bandwidth is 3 MHz for Peak detection (PK) at frequency above 1 GHz.
3. The resolution bandwidth of test receiver/spectrum analyzer is 1 MHz and the video bandwidth is $\geq 1/T$ (Duty cycle $< 98\%$) or 10 Hz (Duty cycle $\geq 98\%$) for Average detection (AV) at frequency above 1 GHz. (RBW = 1 MHz, VBW = 3 kHz)
4. All modes of operation were investigated and the worst-case emissions are reported.

4.1.4 Deviation from Test Standard

No deviation.

4.1.5 Test Set Up

<Radiated Emission below 30 MHz>

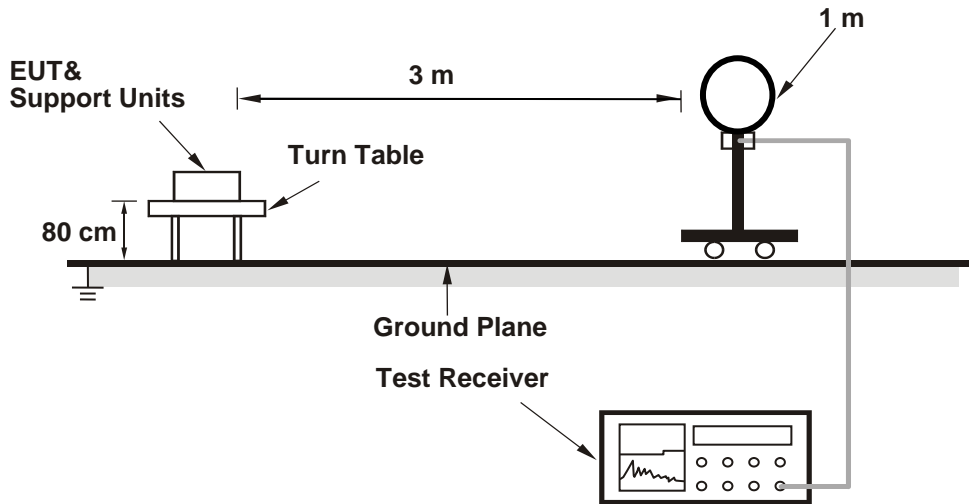

<Radiated Emission 30 MHz to 1 GHz>

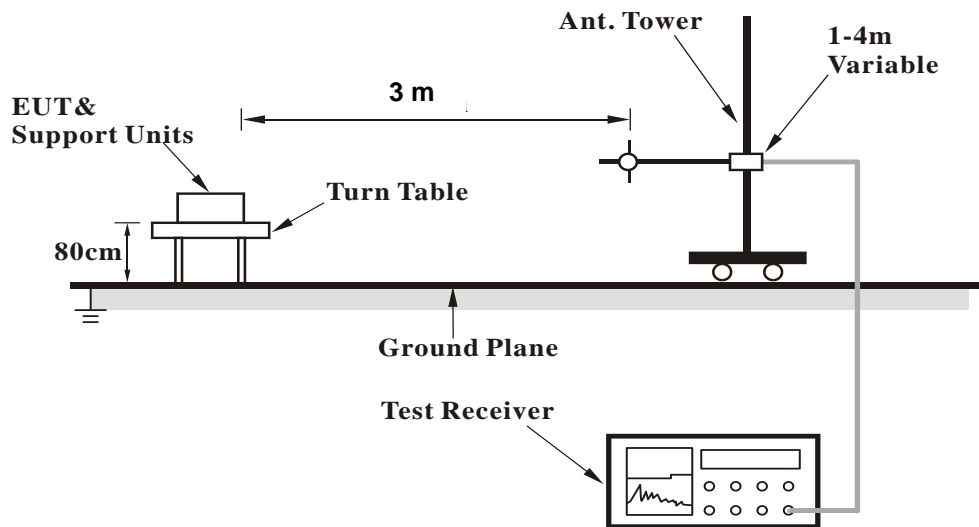

<Radiated Emission above 1 GHz>

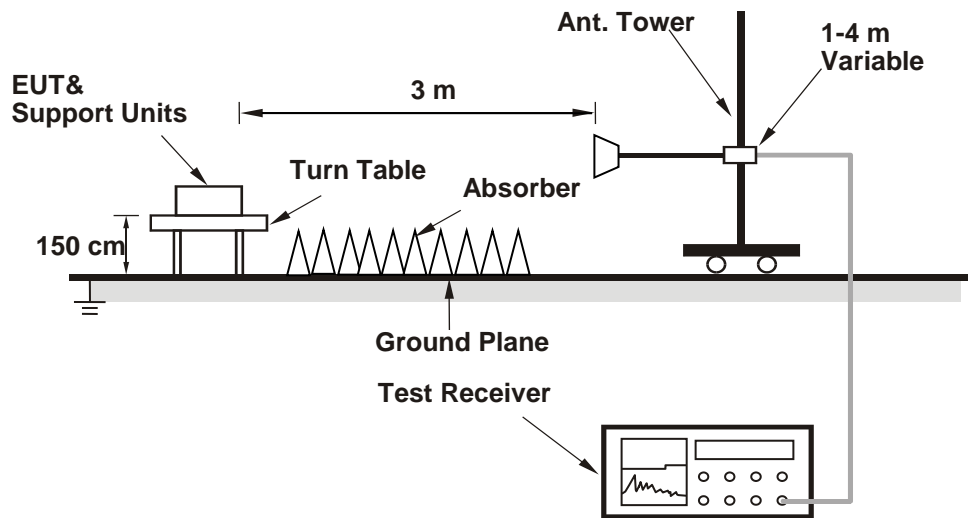

For the actual test configuration, please refer to the attached file (Test Setup Photo).

4.1.6 EUT Operating Conditions

- a. Placed the EUT on the testing table.
- b. Set the EUT under transmission condition continuously at specific channel frequency.

4.1.7 Test Results

Above 1 GHz Data:

EUT Test Condition		Measurement Detail	
Channel	Channel 0	Frequency Range	1 GHz ~ 25 GHz
Input Power	120 Vac, 60 Hz	Detector Function	Peak (PK) Average (AV)
Environmental Conditions	25 deg. C, 65 % RH	Tested By	Charles Hsiao

Antennal Polarity & Test Distance: Horizontal at 3 m										
Frequency (MHz)	Emission Level (dBuV/m)	Read Level (dBuV)	Limit (dBuV/m)	Margin (dB)	Antenna Factor (dB/m)	Cable Loss (dB)	Preamp Factor (dB)	Antenna Height (cm)	Table Angle (Degree)	Remark
2387.4	41.1	39.39	54	-12.9	31.8	5.4	35.49	192	33	Average
2387.4	51.78	50.07	74	-22.22	31.8	5.4	35.49	192	33	Peak
2402	95.55	93.82			31.8	5.4	35.47	192	33	Average
2402	96.45	94.72			31.8	5.4	35.47	192	33	Peak
4804	40.6	32.51	54	-13.4	33.96	8.25	34.12	105	5	Average
4804	46.83	38.74	74	-27.17	33.96	8.25	34.12	105	5	Peak

Antennal Polarity & Test Distance: Vertical at 3 m										
Frequency (MHz)	Emission Level (dBuV/m)	Read Level (dBuV)	Limit (dBuV/m)	Margin (dB)	Antenna Factor (dB/m)	Cable Loss (dB)	Preamp Factor (dB)	Antenna Height (cm)	Table Angle (Degree)	Remark
2380.83	41.27	39.58	54	-12.73	31.78	5.4	35.49	198	99	Average
2380.83	51.65	49.96	74	-22.35	31.78	5.4	35.49	198	99	Peak
2402	94.47	92.74			31.8	5.4	35.47	198	99	Average
2402	95.02	93.29			31.8	5.4	35.47	198	99	Peak
4804	40.57	32.48	54	-13.43	33.96	8.25	34.12	124	216	Average
4804	46.69	38.6	74	-27.31	33.96	8.25	34.12	124	216	Peak

Remarks:

- Emission Level = Read Level + Antenna Factor + Cable Loss - Preamp Factor
Margin value = Emission level – Limit value
- 2402 MHz: Fundamental frequency.
- The emission levels of other frequencies were very low against the limit.

EUT Test Condition		Measurement Detail	
Channel	Channel 19	Frequency Range	1 GHz ~ 25 GHz
Input Power	120 Vac, 60 Hz	Detector Function	Peak (PK) Average (AV)
Environmental Conditions	25 deg. C, 65 % RH	Tested By	Charles Hsiao

Antennal Polarity & Test Distance: Horizontal at 3 m										
Frequency (MHz)	Emission Level (dBUV/m)	Read Level (dBUV)	Limit (dBUV/m)	Margin (dB)	Antenna Factor (dB/m)	Cable Loss (dB)	Preamp Factor (dB)	Antenna Height (cm)	Table Angle (Degree)	Remark
2351.76	41.24	39.65	54	-12.76	31.76	5.33	35.5	192	33	Average
2351.76	51.8	50.21	74	-22.2	31.76	5.33	35.5	192	33	Peak
2440	95.8	93.95			31.85	5.46	35.46	192	33	Average
2440	96.27	94.42			31.85	5.46	35.46	192	33	Peak
2491.4	41.9	39.89	54	-12.1	31.9	5.53	35.42	192	33	Average
2491.4	52.32	50.31	74	-21.68	31.9	5.53	35.42	192	33	Peak
4880	40.33	32.14	54	-13.67	33.98	8.27	34.06	111	179	Average
4880	47.01	38.82	74	-26.99	33.98	8.27	34.06	111	179	Peak
Antennal Polarity & Test Distance: Vertical at 3 m										
Frequency (MHz)	Emission Level (dBUV/m)	Read Level (dBUV)	Limit (dBUV/m)	Margin (dB)	Antenna Factor (dB/m)	Cable Loss (dB)	Preamp Factor (dB)	Antenna Height (cm)	Table Angle (Degree)	Remark
2373	41.46	39.8	54	-12.54	31.78	5.37	35.49	198	99	Average
2373	51.55	49.89	74	-22.45	31.78	5.37	35.49	198	99	Peak
2440	94.57	92.72			31.85	5.46	35.46	198	99	Average
2440	95.91	94.06			31.85	5.46	35.46	198	99	Peak
2491.32	41.68	39.67	54	-12.32	31.9	5.53	35.42	198	99	Average
2491.32	52.17	50.16	74	-21.83	31.9	5.53	35.42	198	99	Peak
4880	40.44	32.25	54	-13.56	33.98	8.27	34.06	124	175	Average
4880	46.19	38	74	-27.81	33.98	8.27	34.06	124	175	Peak

Remarks:

- Emission Level = Read Level + Antenna Factor + Cable Loss - Preamp Factor
Margin value = Emission level – Limit value
- 2440 MHz: Fundamental frequency.
- The emission levels of other frequencies were very low against the limit.

EUT Test Condition		Measurement Detail	
Channel	Channel 39	Frequency Range	1 GHz ~ 25 GHz
Input Power	120 Vac, 60 Hz	Detector Function	Peak (PK) Average (AV)
Environmental Conditions	25 deg. C, 65 % RH	Tested By	Charles Hsiao

Antennal Polarity & Test Distance: Horizontal at 3 m										
Frequency (MHz)	Emission Level (dBuV/m)	Read Level (dBuV)	Limit (dBuV/m)	Margin (dB)	Antenna Factor (dB/m)	Cable Loss (dB)	Preamp Factor (dB)	Antenna Height (cm)	Table Angle (Degree)	Remark
2480	94.33	92.37			31.88	5.5	35.42	192	33	Average
2480	95.42	93.46			31.88	5.5	35.42	192	33	Peak
2492.6	41.86	39.84	54	-12.14	31.9	5.53	35.41	192	33	Average
2492.6	51.89	49.87	74	-22.11	31.9	5.53	35.41	192	33	Peak
4960	40.62	32.35	54	-13.38	33.99	8.29	34.01	148	77	Average
4960	47.18	38.91	74	-26.82	33.99	8.29	34.01	148	77	Peak

Antennal Polarity & Test Distance: Vertical at 3 m										
Frequency (MHz)	Emission Level (dBuV/m)	Read Level (dBuV)	Limit (dBuV/m)	Margin (dB)	Antenna Factor (dB/m)	Cable Loss (dB)	Preamp Factor (dB)	Antenna Height (cm)	Table Angle (Degree)	Remark
2480	93.24	91.28			31.88	5.5	35.42	198	99	Average
2480	94.09	92.13			31.88	5.5	35.42	198	99	Peak
2494.04	41.78	39.76	54	-12.22	31.9	5.53	35.41	198	99	Average
2494.04	52.36	50.34	74	-21.64	31.9	5.53	35.41	198	99	Peak
4960	40.83	32.56	54	-13.17	33.99	8.29	34.01	132	44	Average
4960	46.59	38.32	74	-27.41	33.99	8.29	34.01	132	44	Peak

Remarks:

- Emission Level = Read Level + Antenna Factor + Cable Loss - Preamp Factor
Margin value = Emission level – Limit value
- 2480 MHz: Fundamental frequency.
- The emission levels of other frequencies were very low against the limit.

9 kHz ~ 30 MHz Data:

The amplitude of spurious emissions attenuated more than 20 dB below the permissible value is not required to be report.

30 MHz ~ 1 GHz Worst-Case Data:

EUT Test Condition		Measurement Detail	
Channel	Channel 19	Frequency Range	30 MHz ~ 1 GHz
Input Power	120 Vac, 60 Hz	Detector Function	Peak (PK) Quasi-peak (QP)
Environmental Conditions	25 deg. C, 65 % RH	Tested By	Charles Hsiao

Horizontal

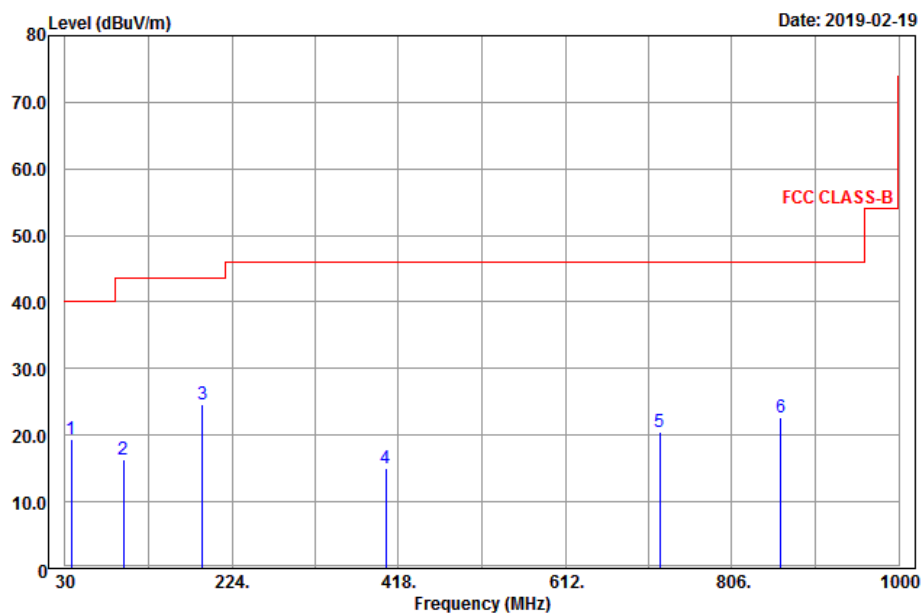

Vertical

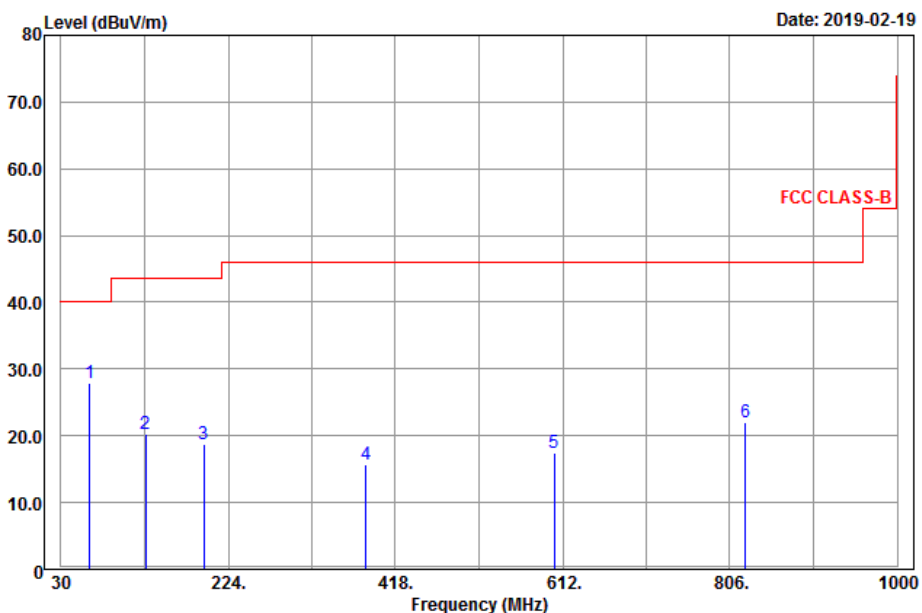

Antenna Polarity & Test Distance: Horizontal at 3 m

Frequency (MHz)	Emission Level (dBuV/m)	Read Level (dBuV)	Factor (dB/m)	Limit (dBuV/m)	Margin (dB)	Antenna Height (cm)	Table Angle (Degree)	Remark
37.29	19.34	37.88	40	-20.66	12.95	0.74	32.23	131
98.31	16.38	35.23	43.5	-27.12	12.02	1.28	32.15	195
190.11	24.54	44.56	43.5	-18.96	10.62	1.61	32.25	174
402.9	15.04	29.9	46	-30.96	15.02	2.34	32.22	192
722.1	20.5	29.91	46	-25.5	19.54	3.16	32.11	155
862.8	22.73	29.81	46	-23.27	21.19	3.44	31.71	160

Antenna Polarity & Test Distance: Vertical at 3 m

Frequency (MHz)	Emission Level (dBuV/m)	Read Level (dBuV)	Factor (dB/m)	Limit (dBuV/m)	Margin (dB)	Antenna Height (cm)	Table Angle (Degree)	Remark
62.94	27.96	46.69	40	-12.04	12.6	0.9	32.23	117
128.01	20.31	41.96	43.5	-23.19	9.2	1.38	32.23	144
196.05	18.8	38.5	43.5	-24.7	10.97	1.61	32.28	188
384	15.69	30.86	46	-30.31	14.67	2.34	32.18	171
602.4	17.49	28.86	46	-28.51	17.95	2.87	32.19	195
824.3	21.97	29.82	46	-24.03	20.7	3.38	31.93	123

Remarks:

- Emission Level = Read Level + Antenna Factor + Cable Loss - Preamp Factor
Margin value = Emission level – Limit value
- The emission levels of other frequencies were very low against the limit.

4.2 Conducted Emission Measurement

4.2.1 Limits of Conducted Emission Measurement

Frequency (MHz)	Conducted Limit (dBuV)	
	Quasi-Peak	Average
0.15 - 0.5	66 - 56	56 - 46
0.50 - 5.0	56	46
5.0 - 30.0	60	50

- Note: 1. The lower limit shall apply at the transition frequencies.
 2. The limit decreases in line with the logarithm of the frequency in the range of 0.15 to 0.50 MHz.

4.2.2 Test Instruments

Description & Manufacturer	Model No.	Serial No.	Date of Calibration	Due Date of Calibration
Test Receiver ROHDE & SCHWARZ	ESCS 30	100288	Jan. 03, 2019	Jan. 02, 2020
RF signal cable Woken	5D-FB	Cable-cond1-01	Sep. 05, 2018	Sep. 04, 2019
LISN/AMN ROHDE & SCHWARZ (EUT)	ENV216	101826	Feb. 21, 2019	Feb. 20, 2020
LISN/AMN ROHDE & SCHWARZ (Peripheral)	ESH3-Z5	100311	Aug. 19, 2018	Aug. 18, 2019
Software ADT	BV ADT_Cond_ V7.3.7.4	NA	NA	NA

- Note: 1. The calibration interval of the above test instruments is 12 months and the calibrations are traceable to NML/ROC and NIST/USA.
 2. The test was performed in HwaYa Shielded Room 1.
 3. The VCCI Site Registration No. is C-2040.

4.2.3 Test Procedures

- The EUT was placed 0.4 meters from the conducting wall of the shielded room with EUT being connected to the power mains through a line impedance stabilization network (LISN). Other support units were connected to the power mains through another LISN. The two LISNs provide 50 ohm/50 uH of coupling impedance for the measuring instrument.
- Both lines of the power mains connected to the EUT were checked for maximum conducted interference.
- The frequency range from 150 kHz to 30 MHz was searched. Emission levels under (Limit – 20 dB) was not recorded.

Note: The resolution bandwidth and video bandwidth of test receiver is 9 kHz for quasi-peak detection (QP) and average detection (AV) at frequency 0.15 MHz - 30 MHz.

4.2.4 Deviation from Test Standard

No deviation.

4.2.5 Test Setup

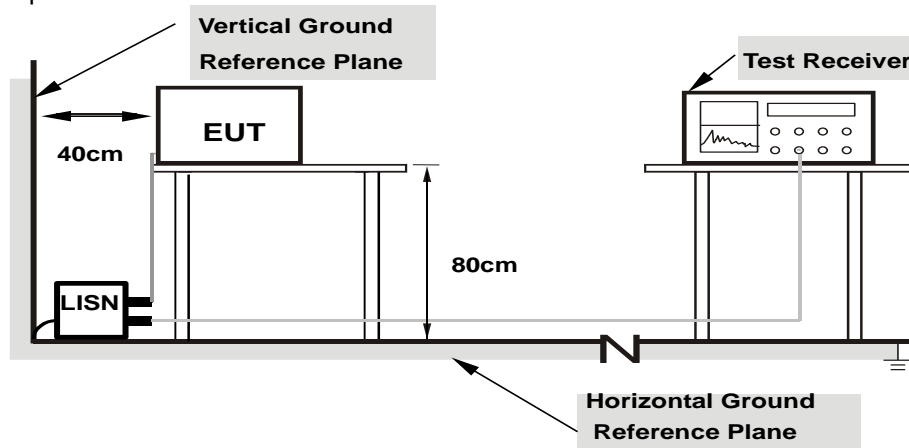

Note: 1.Support units were connected to second LISN.

2.Both of LISNs (AMN) are 80 cm from EUT and at least 80 from other units and other metal planes

4.2.6 EUT Operating Conditions

- Placed the EUT on the testing table.
- Set the EUT under transmission condition continuously at specific channel frequency.

4.2.7 Test Results

CONDUCTED WORST-CASE DATA

Frequency Range	150kHz ~ 30MHz	Detector Function & Resolution Bandwidth	Quasi-Peak (QP) / Average (AV), 9kHz
Input Power	120Vac, 60Hz	Environmental Conditions	25°C, 65%RH
Tested by	Thomas Wei	Test Date	2019/3/6

Phase Of Power : Line (L)										
No	Frequency (MHz)	Correction Factor (dB)	Reading Value (dBuV)		Emission Level (dBuV)		Limit (dBuV)		Margin (dB)	
			Q.P.	AV.	Q.P.	AV.	Q.P.	AV.	Q.P.	AV.
1	0.19297	9.68	25.89	11.00	35.57	20.68	63.91	53.91	-28.34	-33.23
2	0.32188	9.68	23.48	8.33	33.16	18.01	59.66	49.66	-26.50	-31.65
3	0.56797	9.68	23.41	9.80	33.09	19.48	56.00	46.00	-22.91	-26.52
4	0.79063	9.67	31.16	14.72	40.83	24.39	56.00	46.00	-15.17	-21.61
5	2.31641	9.71	22.83	7.44	32.54	17.15	56.00	46.00	-23.46	-28.85
6	7.67578	9.82	20.09	4.69	29.91	14.51	60.00	50.00	-30.09	-35.49

Remarks:

1. Q.P. and AV. are abbreviations of quasi-peak and average individually.
2. The emission levels of other frequencies were very low against the limit.
3. Margin value = Emission level – Limit value
4. Correction factor = Insertion loss + Cable loss
5. Emission Level = Correction Factor + Reading Value

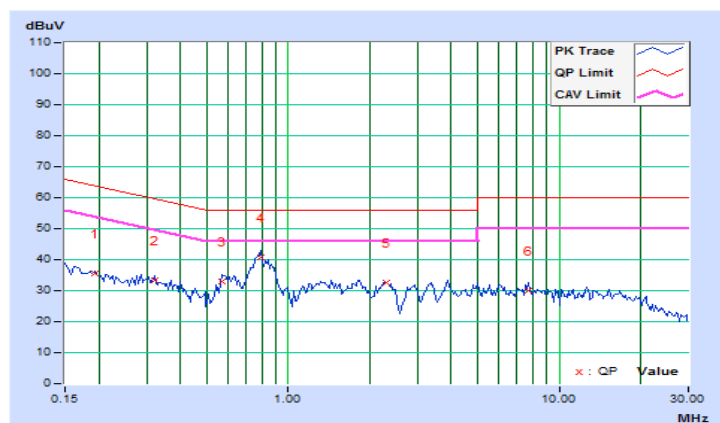

Frequency Range	150kHz ~ 30MHz	Detector Function & Resolution Bandwidth	Quasi-Peak (QP) / Average (AV), 9kHz
Input Power	120Vac, 60Hz	Environmental Conditions	25°C, 65%RH
Tested by	Thomas Wei	Test Date	2019/3/6

Phase Of Power : Neutral (N)										
No	Frequency (MHz)	Correction Factor (dB)	Reading Value (dBuV)		Emission Level (dBuV)		Limit (dBuV)		Margin (dB)	
			Q.P.	AV.	Q.P.	AV.	Q.P.	AV.	Q.P.	AV.
1	0.16953	9.66	26.04	10.17	35.70	19.83	64.98	54.98	-29.28	-35.15
2	0.26719	9.66	20.04	7.33	29.70	16.99	61.20	51.20	-31.50	-34.21
3	0.45469	9.65	21.55	5.86	31.20	15.51	56.79	46.79	-25.59	-31.28
4	0.79063	9.64	27.02	13.02	36.66	22.66	56.00	46.00	-19.34	-23.34
5	3.37109	9.70	19.43	6.01	29.13	15.71	56.00	46.00	-26.87	-30.29
6	8.60156	9.82	16.18	0.93	26.00	10.75	60.00	50.00	-34.00	-39.25

Remarks:

1. Q.P. and AV. are abbreviations of quasi-peak and average individually.
2. The emission levels of other frequencies were very low against the limit.
3. Margin value = Emission level – Limit value
4. Correction factor = Insertion loss + Cable loss
5. Emission Level = Correction Factor + Reading Value

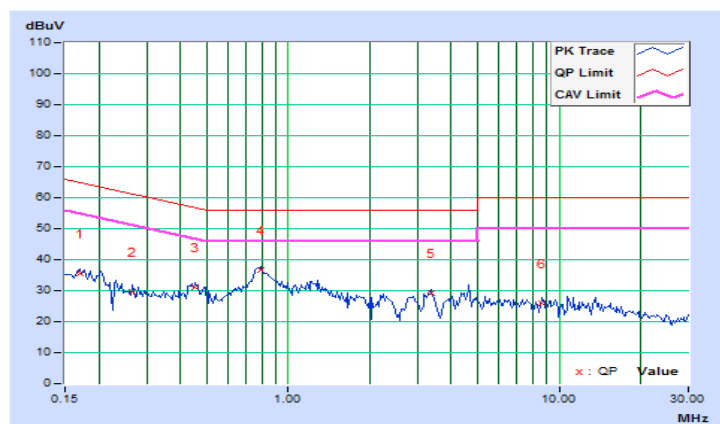

4.3 6 dB Bandwidth Measurement

4.3.1 Limits of 6 dB Bandwidth Measurement

The minimum of 6 dB Bandwidth Measurement is 0.5 MHz.

4.3.2 Test Setup

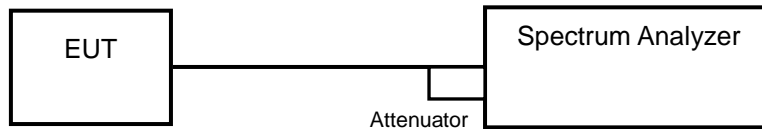

4.3.3 Test Instruments

Refer to section 4.1.2 to get information of above instrument.

4.3.4 Test Procedure

- Set resolution bandwidth (RBW) = 100 kHz
- Set the video bandwidth (VBW) $\geq 3 \times$ RBW, Detector = Peak.
- Trace mode = max hold.
- Sweep = auto couple.
- Measure the maximum width of the emission that is constrained by the frequencies associated with the two amplitude points (upper and lower) that are attenuated by 6 dB relative to the maximum level measured in the fundamental emission

4.3.5 Deviation from Test Standard

No deviation.

4.3.6 EUT Operating Conditions

The software provided by client to enable the EUT under transmission condition continuously at lowest, middle and highest channel frequencies individually.

4.3.7 Test Results

Channel	Frequency (MHz)	6 dB Bandwidth (MHz)	Minimum Limit (MHz)	Pass / Fail
0	2402	0.68	0.5	Pass
19	2440	0.67	0.5	Pass
39	2480	0.68	0.5	Pass

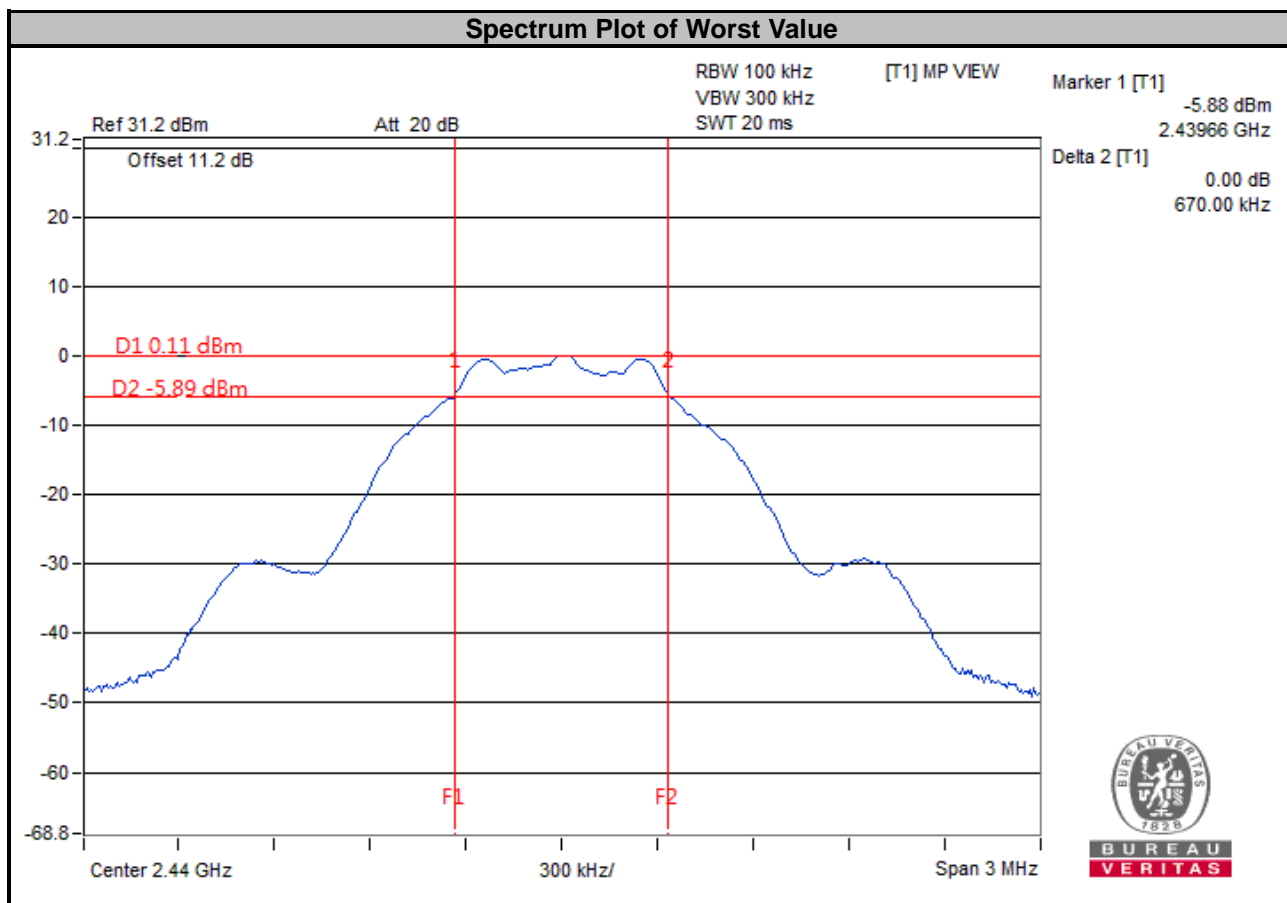

4.4 Occupied Bandwidth Measurement

4.4.1 Test Setup

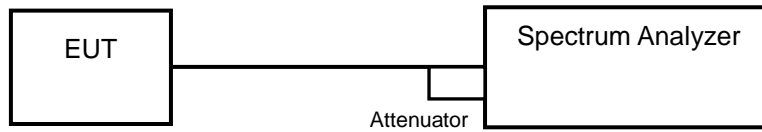

4.4.2 Test Instruments

Refer to section 4.1.2 to get information of above instrument.

4.4.3 Test Procedure

The transmitter output was connected to the spectrum analyzer through an attenuator. The bandwidth of the fundamental frequency was measured by spectrum analyzer with resolution bandwidth in the range of 1 % to 5 % of the anticipated emission bandwidth, and a video bandwidth at least 3x the resolution bandwidth and set the detector to PEAK. The width of a frequency band such that, below the lower and above the upper frequency limits, the mean powers emitted are each equal to a specified percentage 0.5 % of the total mean power of a given emission.

4.4.4 Deviation from Test Standard

No deviation.

4.4.5 EUT Operating Conditions

The software provided by client to enable the EUT under transmission condition continuously at lowest, middle and highest channel frequencies individually.

4.4.6 Test Results

Channel	Frequency (MHz)	Occupied Bandwidth (MHz)	Pass / Fail
0	2402	1.06	Pass
19	2440	1.05	Pass
39	2480	1.06	Pass

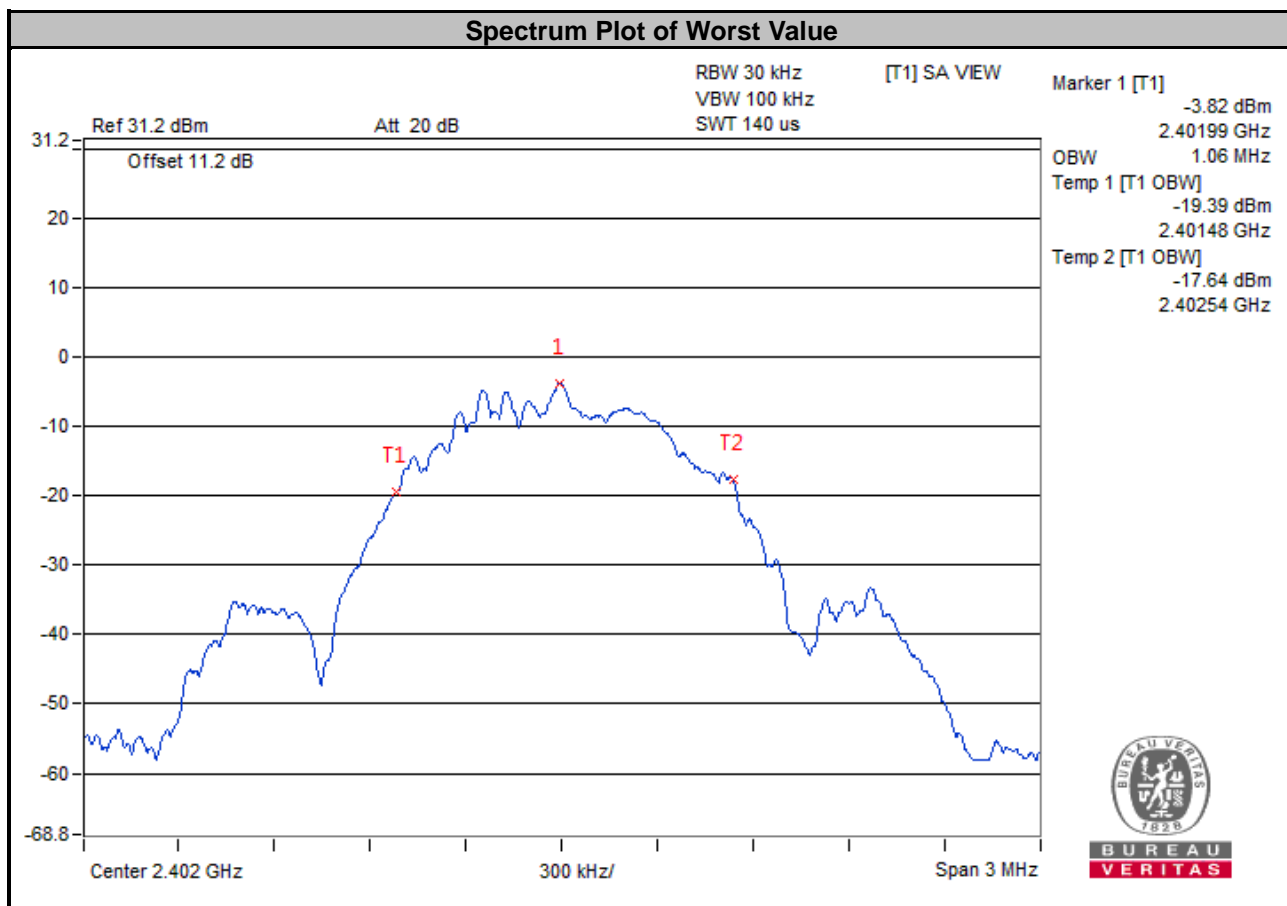

4.5 Conducted Output Power Measurement

4.5.1 Limits of Conducted Output Power Measurement

For systems using digital modulation in the 2400–2483.5 MHz bands: 1 Watt (30 dBm)

4.5.2 Test Setup

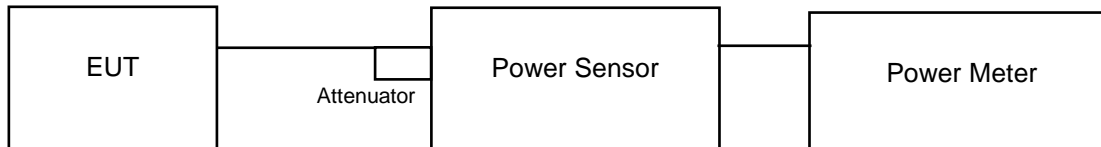

4.5.3 Test Instruments

Refer to section 4.1.2 to get information of above instrument.

4.5.4 Test Procedures

A peak power sensor was used on the output port of the EUT. A power meter was used to read the response of the peak power sensor. Record the power level.

4.5.5 Deviation from Test Standard

No deviation.

4.5.6 EUT Operating Conditions

The software provided by client to enable the EUT under transmission condition continuously at lowest, middle and highest channel frequencies individually.

4.5.7 Test Results

Channel	Frequency (MHz)	Peak Power (mW)	Peak Power (dBm)	Limit (dBm)	Pass / Fail
0	2402	0.869	-0.61	30	Pass
19	2440	0.9376	-0.28	30	Pass
39	2480	0.8054	-0.94	30	Pass

4.6 Power Spectral Density Measurement

4.6.1 Limits of Power Spectral Density Measurement

The Maximum of Power Spectral Density Measurement is 8 dBm.

4.6.2 Test Setup

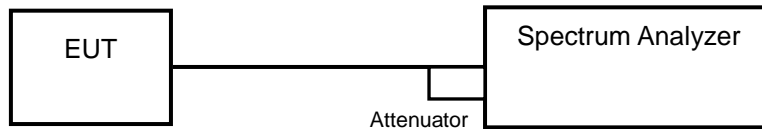

4.6.3 Test Instruments

Refer to section 4.1.2 to get information of above instrument.

4.6.4 Test Procedure

- a. Set analyzer center frequency to DTS channel center frequency.
- b. Set the span to 1.5 times the DTS bandwidth.
- c. Set the RBW to: $3 \text{ kHz} \leq \text{RBW} \leq 100 \text{ kHz}$.
- d. Set the VBW $\geq 3 \times \text{RBW}$.
- e. Detector = peak.
- f. Sweep time = auto couple.
- g. Trace mode = max hold.
- h. Allow trace to fully stabilize.
- i. Use the peak marker function to determine the maximum amplitude level within the RBW.

4.6.5 Deviation from Test Standard

No deviation.

4.6.6 EUT Operating Condition

The software provided by client to enable the EUT under transmission condition continuously at lowest, middle and highest channel frequencies individually.

4.6.7 Test Results

Channel	Frequency (MHz)	PSD (dBm/3 kHz)	Limit (dBm/3 kHz)	Pass / Fail
0	2402	-14.89	8	Pass
19	2440	-14.59	8	Pass
39	2480	-15.86	8	Pass

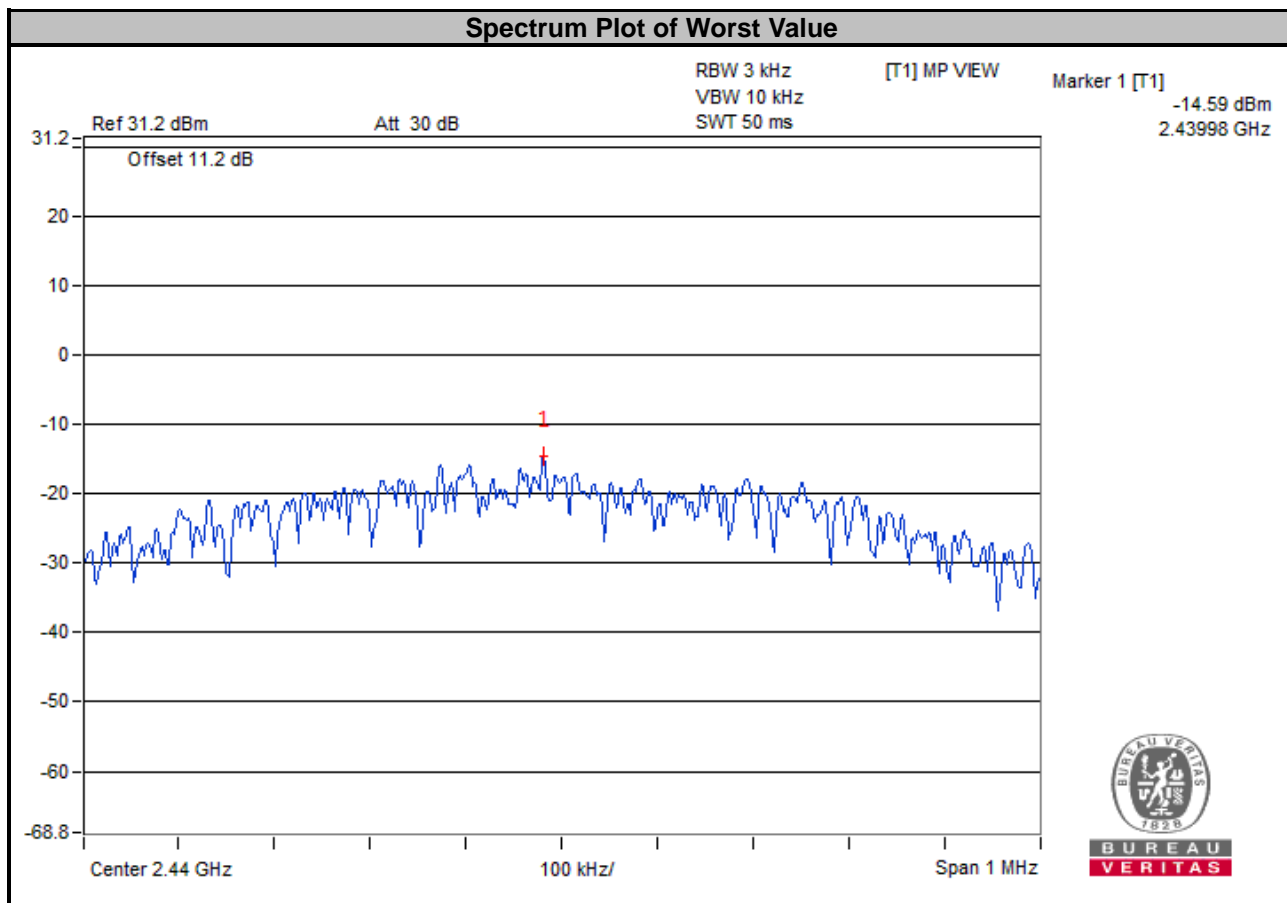

4.7 Conducted Out of Band Emission Measurement

4.7.1 Limits of Conducted Out of Band Emission Measurement

Below -20 dB of the highest emission level of operating band (in 100 kHz Resolution Bandwidth).

4.7.2 Test Setup

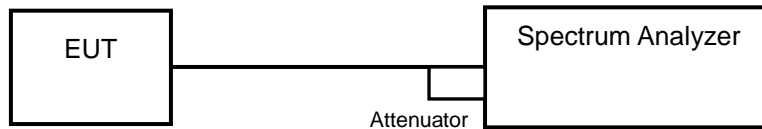

4.7.3 Test Instruments

Refer to section 4.1.2 to get information of above instrument.

4.7.4 Test Procedure

MEASUREMENT PROCEDURE REF

1. Set the RBW = 100 kHz.
2. Set the VBW \geq 300 kHz.
3. Detector = peak.
4. Sweep time = auto couple.
5. Trace mode = max hold.
6. Allow trace to fully stabilize.
7. Use the peak marker function to determine the maximum power level in any 100 kHz band segment within the fundamental EBW.

MEASUREMENT PROCEDURE OOB

1. Set RBW = 100 kHz.
2. Set VBW \geq 300 kHz.
3. Detector = peak.
4. Sweep = auto couple.
5. Trace Mode = max hold.
6. Allow trace to fully stabilize.
7. Use the peak marker function to determine the maximum amplitude level.

4.7.5 Deviation from Test Standard

No deviation.

4.7.6 EUT Operating Condition

The software provided by client to enable the EUT under transmission condition continuously at lowest, middle and highest channel frequencies individually.

4.7.7 Test Results

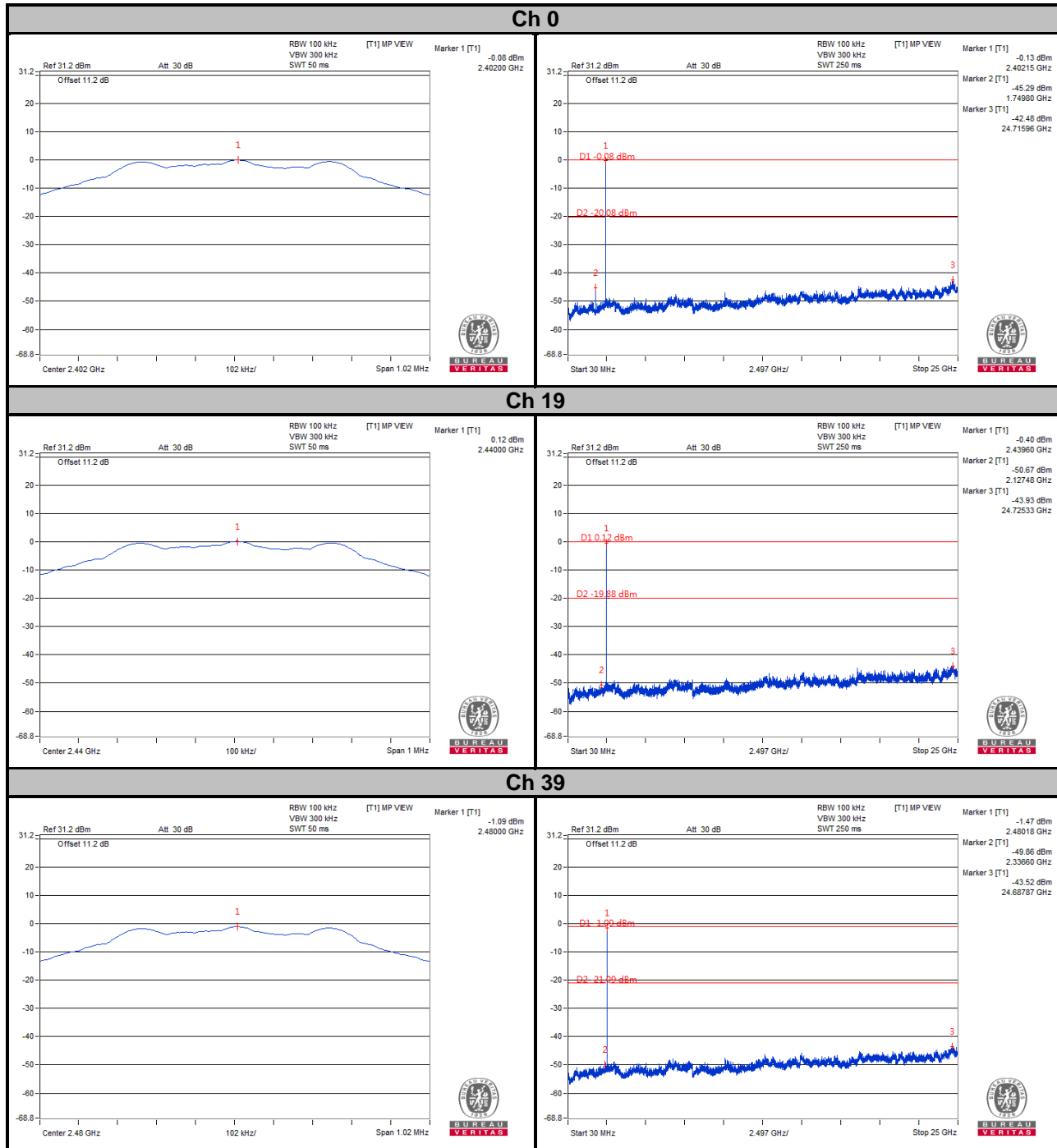

Ch 0 Band Edge

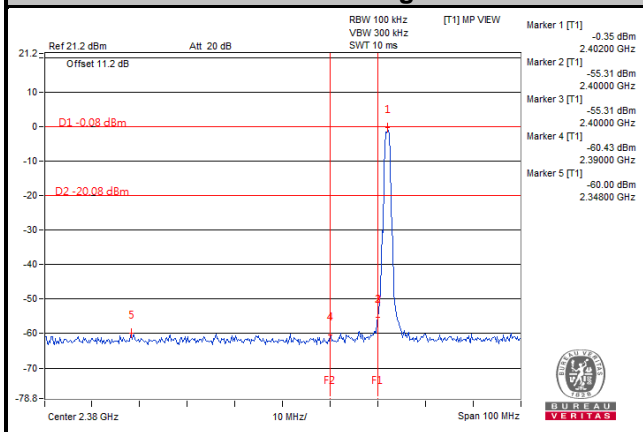

Ch 39 Band Edge

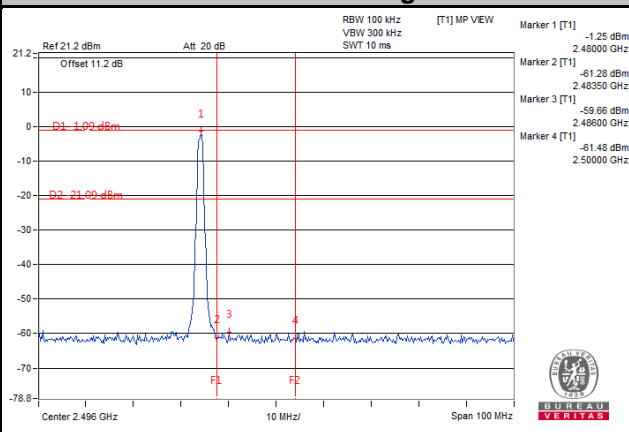

5 Pictures of Test Arrangements

Please refer to the attached file (Test Setup Photo).

Appendix – Information of the Testing Laboratories

We, Bureau Veritas Consumer Products Services (H.K.) Ltd., Taoyuan Branch, were founded in 1988 to provide our best service in EMC, Radio, Telecom and Safety consultation. Our laboratories are FCC recognized accredited test firms and accredited according to ISO/IEC 17025.

If you have any comments, please feel free to contact us at the following:

Lin Kou EMC/RF Lab

Tel: 886-2-26052180

Fax: 886-2-26051924

Hsin Chu EMC/RF/Telecom Lab

Tel: 886-3-6668565

Fax: 886-3-6668323

Hwa Ya EMC/RF/Safety

Tel: 886-3-3183232

Fax: 886-3-3270892

Email: service.adt@tw.bureauveritas.com

Web Site: www.bureauveritas-adt.com

The address and road map of all our labs can be found in our web site also.

--- END ---