

FCC Test Report

(PART 27)

Report No.: RF190211C01-8

FCC ID: B32CM5

Test Model: CM5

Received Date: Feb. 06, 2019

Test Date: Feb. 06, 2019 ~ Mar. 09, 2019

Issued Date: Mar. 20, 2019

Applicant: Verifone, Inc.

Address: 1400 West Stanford Ranch Road Suite 200 Rocklin CA 95765 USA

Issued By: Bureau Veritas Consumer Products Services (H.K.) Ltd., Taoyuan Branch

Lab Address: No. 47-2, 14th Ling, Chia Pau Vil., Lin Kou Dist., New Taipei City, Taiwan (R.O.C)

Test Location (1): No. 19, Hwa Ya 2nd Rd, Wen Hwa Vil, Kwei Shan Dist., Taoyuan City 33383, Taiwan (R.O.C)

Test Location (2): B2F., No.215, Sec. 3, Beixin Rd., Xindian Dist., New Taipei City 231, Taiwan, R.O.C

**FCC Registration /
Designation Number:** 427177 / TW0011



This report is for your exclusive use. Any copying or replication of this report to or for any other person or entity, or use of our name or trademark, is permitted only with our prior written permission. This report sets forth our findings solely with respect to the test samples identified herein. The results set forth in this report are not indicative or representative of the quality or characteristics of the lot from which a test sample was taken or any similar or identical product unless specifically and expressly noted. Our report includes all of the tests requested by you and the results thereof based upon the information that you provided to us. You have 60 days from date of issuance of this report to notify us of any material error or omission caused by our negligence, provided, however, that such notice shall be in writing and shall specifically address the issue you wish to raise. A failure to raise such issue within the prescribed time shall constitute your unqualified acceptance of the completeness of this report, the tests conducted and the correctness of the report contents. Unless specific mention, the uncertainty of measurement has been explicitly taken into account to declare the compliance or non-compliance to the specification. The report must not be used by the client to claim product certification, approval, or endorsement by TAF or any government agencies

Table of Contents

Release Control Record	4
1 Certificate of Conformity	5
2 Summary of Test Results	6
2.1 Measurement Uncertainty	8
2.2 Test Site and Instruments	9
3 General Information	11
3.1 General Description of EUT	11
3.2 Configuration of System under Test	13
3.2.1 Description of Support Units	13
3.3 Test Mode Applicability and Tested Channel Detail	14
3.4 EUT Operating Conditions	19
3.5 General Description of Applied Standards	19
4 Test Types and Results	20
4.1 Output Power Measurement	20
4.1.1 Limits of Output Power Measurement	20
4.1.2 Test Procedures	20
4.1.3 Test Setup	21
4.1.4 Test Results	22
4.2 Modulation Characteristics Measurement	32
4.2.1 Limits of Modulation Characteristics	32
4.2.2 Test Setup	32
4.2.3 Test Procedure	32
4.2.4 Test Results	33
4.3 Frequency Stability Measurement	35
4.3.1 Limits of Frequency Stability Measurement	35
4.3.2 Test Procedure	35
4.3.3 Test Setup	35
4.3.4 Test Results	36
4.4 Occupied Bandwidth Measurement	49
4.4.1 Limits of Occupied Bandwidth Measurement	49
4.4.2 Test Procedure	49
4.4.3 Test Setup	49
4.4.4 Test Result	50
4.5 Band Edge Measurement	57
4.5.1 Limits of Band Edge Measurement	57
4.5.2 Test Setup	57
4.5.3 Test Procedures	57
4.5.4 Test Results	58
4.6 Peak to Average Ratio	72
4.6.1 Limits of Peak to Average Ratio Measurement	72
4.6.2 Test Setup	72
4.6.3 Test Procedures	72
4.6.4 Test Results	73
4.7 Conducted Spurious Emissions	80
4.7.1 Limits of Conducted Spurious Emissions Measurement	80
4.7.2 Test Setup	80
4.7.3 Test Procedure	80
4.7.4 Test Results	81
4.8 Radiated Emission Measurement	110
4.8.1 Limits of Radiated Emission Measurement	110
4.8.2 Test Procedure	110
4.8.3 Deviation from Test Standard	110
4.8.4 Test Setup	111

4.8.5 Test Results	112
5 Pictures of Test Arrangements.....	162
Appendix – Information of the Testing Laboratories	163

Release Control Record

Issue No.	Description	Date Issued
RF190211C01-8	Original Release	Mar. 20, 2019

1 Certificate of Conformity

Product: Point of Sale Terminal

Brand: Verifone

Test Model: CM5

Sample Status: Identical Prototype

Applicant: Verifone, Inc.

Test Date: Feb. 06, 2019 ~ Mar. 09, 2019

Standards: FCC Part 27, Subpart C, H, F, L

The above equipment has been tested by **Bureau Veritas Consumer Products Services (H.K.) Ltd., Taoyuan Branch**, and found compliance with the requirement of the above standards. The test record, data evaluation & Equipment Under Test (EUT) configurations represented herein are true and accurate accounts of the measurements of the sample's RF characteristics under the conditions specified in this report.

Prepared by : , **Date:** Mar. 20, 2019
Ivonne Wu / Supervisor

Approved by : , **Date:** Mar. 20, 2019
Dylan Chiou / Project Engineer

2 Summary of Test Results

Applied Standard: FCC Part 27 & Part 2 (WCDMA)			
FCC Clause	Test Item	Result	Remarks
2.1046 27.50(d)(4)	Equivalent Isotropic Radiated Power	Pass	Meet the requirement of limit.
2.1047	Modulation Characteristics	Pass	Meet the requirement.
2.1055 27.54	Frequency Stability	Pass	Meet the requirement of limit.
2.1049	Occupied Bandwidth	Pass	Meet the requirement of limit.
27.50(d)(5)	Peak to Average Ratio	Pass	Meet the requirement of limit.
27.53(h)	Band Edge Measurements	Pass	Meet the requirement of limit.
2.1051 27.53(h)	Conducted Spurious Emissions	Pass	Meet the requirement of limit.
2.1053 27.53(h)	Radiated Spurious Emissions	Pass	Meet the requirement of limit. Minimum passing margin is -39.18 dB at 3505.20 MHz.

Applied Standard: FCC Part 27 & Part 2 (LTE 4)			
FCC Clause	Test Item	Result	Remarks
2.1046 27.50(d)(4)	Maximum Peak Output Power	Pass	Meet the requirement of limit.
2.1047	Modulation Characteristics	Pass	Meet the requirement.
2.1055 27.54	Frequency Stability	Pass	Meet the requirement of limit.
2.1049	Occupied Bandwidth	Pass	Meet the requirement of limit.
27.50(d)(5)	Peak to Average Ratio	Pass	Meet the requirement of limit.
27.53(h)	Band Edge Measurements	Pass	Meet the requirement of limit.
2.1051 27.53(h)	Conducted Spurious Emissions	Pass	Meet the requirement of limit.
2.1053 27.53(h)	Radiated Spurious Emissions	Pass	Meet the requirement of limit. Minimum passing margin is -26.69 dB at 6880.00 MHz.

Applied Standard: FCC Part 27 & Part 2 (LTE 12)			
FCC Clause	Test Item	Result	Remarks
2.1046 27.50(c)(10)	Maximum Peak Output Power	Pass	Meet the requirement of limit.
2.1047	Modulation Characteristics	Pass	Meet the requirement.
2.1055 27.54	Frequency Stability	Pass	Meet the requirement of limit.
2.1049	Occupied Bandwidth	Pass	Meet the requirement of limit.
---	Peak to Average Ratio	Pass	Meet the requirement of limit.
27.53(g)	Band Edge Measurements	Pass	Meet the requirement of limit.
2.1051 27.53(g)	Conducted Spurious Emissions	Pass	Meet the requirement of limit.
2.1053 27.53(g)	Radiated Spurious Emissions	Pass	Meet the requirement of limit. Minimum passing margin is -30.46 dB at 1415.00 MHz.

Applied Standard: FCC Part 27 & Part 2 (LTE 13)			
FCC Clause	Test Item	Result	Remarks
2.1046 27.50(b)(10)	Maximum Peak Output Power	Pass	Meet the requirement of limit.
2.1047	Modulation Characteristics	Pass	Meet the requirement.
2.1055 27.54	Frequency Stability	Pass	Meet the requirement of limit.
2.1049	Occupied Bandwidth	Pass	Meet the requirement of limit.
---	Peak to Average Ratio	Pass	Meet the requirement of limit.
27.53(c)(2)(4)	Band Edge Measurements	Pass	Meet the requirement of limit.
2.1051 27.53(c)(2)&(f)	Conducted Spurious Emissions	Pass	Meet the requirement of limit.
2.1053 27.53(c)(2)&(f)	Radiated Spurious Emissions	Pass	Meet the requirement of limit. Minimum passing margin is -16.68 dB at 1564.00 MHz.

Note: Determining compliance based on the results of the compliance measurement, not taking into account measurement instrumentation uncertainty.

2.1 Measurement Uncertainty

Where relevant, the following measurement uncertainty levels have been estimated for tests performed on the EUT as specified in CISPR 16-4-2:

Measurement	Frequency	Expanded Uncertainty (k=2) (\pm)
Radiated Emissions up to 1 GHz	9 kHz ~ 30 MHz	3.0400 dB
	30 MHz ~ 200 MHz	2.0153 dB
	200 MHz ~ 1000 MHz	2.0224 dB
Radiated Emissions above 1 GHz	1 GHz ~ 18 GHz	1.0121 dB
	18 GHz ~ 40 GHz	1.1508 dB

2.2 Test Site and Instruments

Description & Manufacturer	Model No.	Serial No.	Date of Calibration	Due Date of Calibration
Test Receiver Agilent Technologies	N9038A	MY52260177	Aug. 20, 2018	Aug. 19, 2019
Spectrum Analyzer ROHDE & SCHWARZ	FSV40	100980	Apr. 17, 2018	Apr. 16, 2019
Spectrum Analyzer ROHDE & SCHWARZ	FSW26	102023	Oct. 11, 2018	Oct. 10, 2019
BILOG Antenna SCHWARZBECK	VULB9168	9168-616	Nov. 27, 2018	Nov. 26, 2019
HORN Antenna ETS-Lindgren	3117	00143293	Nov. 25, 2018	Nov. 24, 2019
HORN Antenna SCHWARZBECK	BBHA 9120D	9120D-969	Nov. 25, 2018	Nov. 24, 2019
Fixed Attenuator Mini-Circuits	MDCS18N-10	MDCS18N-10-01	Apr. 16, 2018	Apr. 15, 2019
MXG Vector signal generator Agilent	N5182B	MY53050430	Nov. 19, 2018	Nov. 18, 2019
Preamplifier Agilent	310N	187226	Jun. 19, 2018	Jun. 18, 2019
Preamplifier Agilent	83017A	MY39501357	Jun. 19, 2018	Jun. 18, 2019
RF signal cable ETS-LINDGREN	5D-FB	Cable-CH1-01(RFC -SMS-100-SMS-12 0+RFC-SMS-100-S MS-400)	Jun. 19, 2018	Jun. 18, 2019
RF signal cable ETS-LINDGREN	8D-FB	Cable-CH1-02(RFC -SMS-100-SMS-24)	Jun. 19, 2018	Jun. 18, 2019
Boresight Antenna Fixture	FBA-01	FBA-SIP01	NA	NA
Software BV ADT	E3 8.130425b	NA	NA	NA
Antenna Tower MF	NA	NA	NA	NA
Turn Table MF	NA	NA	NA	NA
Antenna Tower & Turn Table Controller MF	MF-7802	NA	NA	NA
Communications Tester-Wireless Agilent	8960 Series 10	MY53201073	Jun. 28, 2017	Jun. 27, 2019
Radio Communication Analyzer Anritsu	MT8820C	6201300640	Aug. 16, 2017	Aug. 15, 2019
Temperature & Humidity Chamber	GTH-120-40-CP-AR	MAA1306-019	Sep. 05, 2018	Sep. 04, 2019
DC Power Supply Topward	33010D	807748	NA	NA

- Note:
1. The calibration interval of the above test instruments is 12 / 24 months and the calibrations are traceable to NML/ROC and NIST/USA.
 2. The test was performed in HsinTien Chamber 1.
 3. The horn antenna and preamplifier (model: 83017A) are used only for the measurement of emission frequency above 1 GHz if tested.
 4. The IC Site Registration No. is 7450I-1.



3 General Information

3.1 General Description of EUT

Product	Point of Sale Terminal	
Brand	Verifone	
Test Model	CM5	
Status of EUT	Identical Prototype	
Power Supply Rating	5.0 Vdc (adapter or host equipment) 3.85 Vdc (Li-ion battery)	
Modulation Type	WCDMA	QPSK
	LTE	QPSK, 16QAM
Frequency Range	WCDMA	1712.4 ~ 1752.6 MHz
	LTE Band 4 (Channel Bandwidth: 1.4 MHz)	1710.7 ~ 1754.3 MHz
	LTE Band 4 (Channel Bandwidth: 3 MHz)	1711.5 ~ 1753.5 MHz
	LTE Band 4 (Channel Bandwidth: 5 MHz)	1712.5 ~ 1752.5 MHz
	LTE Band 4 (Channel Bandwidth: 10 MHz)	1715.0 ~ 1750.0 MHz
	LTE Band 4 (Channel Bandwidth: 15 MHz)	1717.5 ~ 1747.5 MHz
	LTE Band 4 (Channel Bandwidth: 20 MHz)	1720.0 ~ 1745.0 MHz
	LTE Band 12 (Channel Bandwidth: 1.4 MHz)	699.7 ~ 715.3 MHz
	LTE Band 12 (Channel Bandwidth: 3 MHz)	700.5 ~ 714.5 MHz
	LTE Band 12 (Channel Bandwidth: 5 MHz)	701.5 ~ 713.5 MHz
	LTE Band 12 (Channel Bandwidth: 10 MHz)	704.0 ~ 711.0 MHz
	LTE Band 13 (Channel Bandwidth: 5 MHz)	779.5 ~ 784.5 MHz
	LTE Band 13 (Channel Bandwidth: 10 MHz)	782.0 MHz
	Emission Designator	WCDMA
LTE Band 4 (Channel Bandwidth: 1.4 MHz)		1M09D7W
LTE Band 4 (Channel Bandwidth: 3 MHz)		2M70G7D
LTE Band 4 (Channel Bandwidth: 5 MHz)		4M50G7D
LTE Band 4 (Channel Bandwidth: 10 MHz)		8M97D7W
LTE Band 4 (Channel Bandwidth: 15 MHz)		13M5G7D
LTE Band 4 (Channel Bandwidth: 20 MHz)		18M0D7W
LTE Band 12 (Channel Bandwidth: 1.4 MHz)		1M09D7W
LTE Band 12 (Channel Bandwidth: 3 MHz)		2M71G7D
LTE Band 12 (Channel Bandwidth: 5 MHz)		4M50G7D
LTE Band 12 (Channel Bandwidth: 10 MHz)		8M98D7W
LTE Band 13 (Channel Bandwidth: 5 MHz)		4M50D7W
LTE Band 13 (Channel Bandwidth: 10 MHz)		8M95D7W
Max. ERP Power		LTE Band 12 (Channel Bandwidth: 1.4 MHz)
	LTE Band 12 (Channel Bandwidth: 3 MHz)	73.38 mW
	LTE Band 12 (Channel Bandwidth: 5 MHz)	74.06 mW
	LTE Band 12 (Channel Bandwidth: 10 MHz)	74.80 mW
	LTE Band 13 (Channel Bandwidth: 5 MHz)	152.90 mW
	LTE Band 13 (Channel Bandwidth: 10 MHz)	152.30 mW

Max. EIRP Power	WCDMA	268.23 mW
	LTE Band 4 (Channel Bandwidth: 1.4 MHz)	246.04 mW
	LTE Band 4 (Channel Bandwidth: 3 MHz)	248.31 mW
	LTE Band 4 (Channel Bandwidth: 5 MHz)	250.61 mW
	LTE Band 4 (Channel Bandwidth: 10 MHz)	252.35 mW
	LTE Band 4 (Channel Bandwidth: 15 MHz)	254.68 mW
	LTE Band 4 (Channel Bandwidth: 20 MHz)	257.04 mW
Antenna Type	Fixed Internal Antenna	
Antenna Gain	WCDMA	1.1 dBi
	LTE Band 4	1.1 dBi
	LTE Band 12	-1.7 dBi
	LTE Band 13	0.4 dBi
Accessory Device	Refer to Note as below	
Data Cable Supplied	Refer to Note as below	

Note:

1. The EUT's accessories list refers to Ext. Pho.
2. The above EUT information is declared by manufacturer and for more detailed features description, please refers to the manufacturer's specifications or user's manual.

3.2 Configuration of System under Test

<Radiated Emission Test>

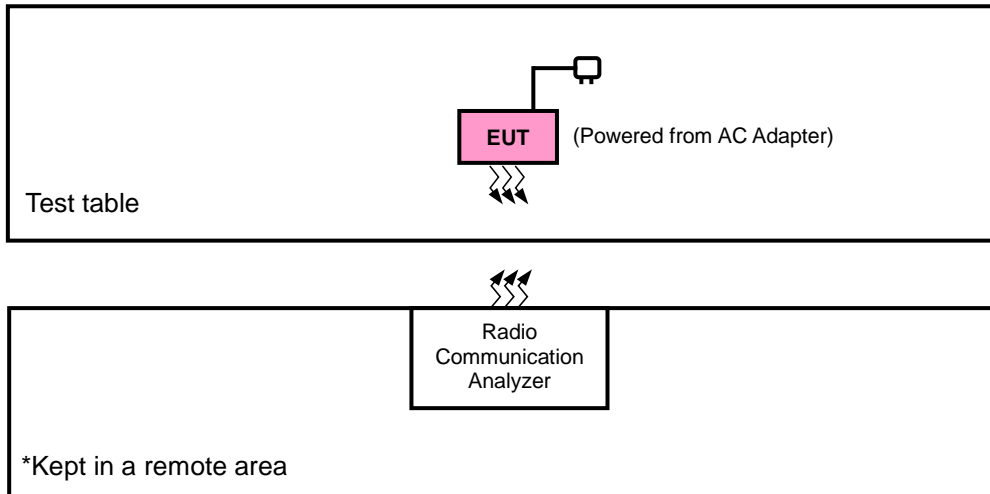

<E.R.P. / E.I.R.P. Test>

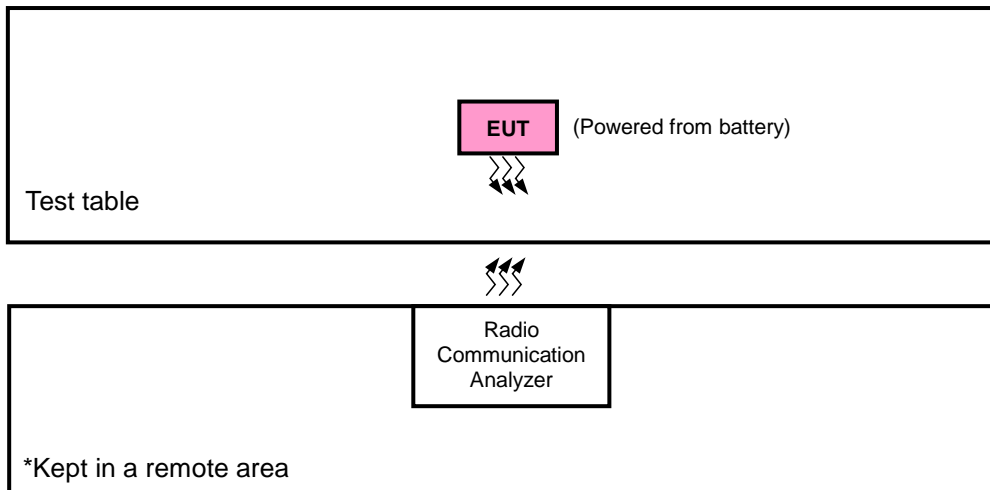

3.2.1 Description of Support Units

The EUT has been tested as an independent unit together with other necessary accessories or support units.

3.3 Test Mode Applicability and Tested Channel Detail

Pre-Scan has been conducted to determine the worst-case mode from all possible combinations between available modulations, data rates, XYZ axis, and antenna ports

The worst case was found when positioned as the table below. Following channel(s) was (were) selected for the final test as listed below:

Band	ERP / EIRP	Radiated Emission
WCDMA	X-plane	X-axis
LTE Band 4	X-plane	Z-axis
LTE Band 12	X-plane	X-axis
LTE Band 13	X-plane	Y-axis

WCDMA

EUT Configure Mode	Test Item	Available Channel	Tested Channel	Mode
-	EIRP	1312 to 1513	1312, 1413, 1513	WCDMA
-	Modulation Characteristics	1312 to 1513	1413	WCDMA
-	Frequency Stability	1312 to 1513	1312, 1513	WCDMA
-	Occupied Bandwidth	1312 to 1513	1312, 1413, 1513	WCDMA
-	Band Edge	1312 to 1513	1312, 1513	WCDMA
-	Peak to Average Ratio	1312 to 1513	1312, 1413, 1513	WCDMA
-	Conducted Emission	1312 to 1513	1312, 1413, 1513	WCDMA
-	Radiated Emission	1312 to 1513	1312, 1413, 1513	WCDMA

LTE Band 4

EUT Configure Mode	Test Item	Available Channel	Tested Channel	Channel Bandwidth	Modulation	Mode
-	EIRP	19957 to 20393	19957, 20175, 20393	1.4 MHz	QPSK, 16QAM	1 RB / 0 RB Offset
		19965 to 20385	19965, 20175, 20385	3 MHz	QPSK, 16QAM	1 RB / 0 RB Offset
		19975 to 20375	19975, 20175, 20375	5 MHz	QPSK, 16QAM	1 RB / 0 RB Offset
		20000 to 20350	20000, 20175, 20350	10 MHz	QPSK, 16QAM	1 RB / 0 RB Offset
		20025 to 20325	20025, 20175, 20325	15 MHz	QPSK, 16QAM	1 RB / 0 RB Offset
		20050 to 20300	20050, 20175, 20300	20 MHz	QPSK, 16QAM	1 RB / 0 RB Offset
-	Modulation Characteristics	20050 to 20300	20175	20 MHz	QPSK, 16QAM	100 RB / 0 RB Offset
-	Frequency Stability	19957 to 20393	19957, 20393	1.4 MHz	QPSK	1 RB / 0 RB Offset
		19965 to 20385	19965, 20385	3 MHz	QPSK	1 RB / 0 RB Offset
		19975 to 20375	19975, 20375	5 MHz	QPSK	1 RB / 0 RB Offset
		20000 to 20350	20000, 20350	10 MHz	QPSK	1 RB / 0 RB Offset
		20025 to 20325	20025, 20325	15 MHz	QPSK	1 RB / 0 RB Offset
		20050 to 20300	20050, 20300	20 MHz	QPSK	1 RB / 0 RB Offset
-	Occupied Bandwidth	19957 to 20393	19957, 20175, 20393	1.4 MHz	QPSK, 16QAM	6 RB / 0 RB Offset
		19965 to 20385	19965, 20175, 20385	3 MHz	QPSK, 16QAM	15 RB / 0 RB Offset
		19975 to 20375	19975, 20175, 20375	5 MHz	QPSK, 16QAM	25 RB / 0 RB Offset
		20000 to 20350	20000, 20175, 20350	10 MHz	QPSK, 16QAM	50 RB / 0 RB Offset
		20025 to 20325	20025, 20175, 20325	15 MHz	QPSK, 16QAM	75 RB / 0 RB Offset
		20050 to 20300	20050, 20175, 20300	20 MHz	QPSK, 16QAM	100 RB / 0 RB Offset
-	Peak to Average Ratio	19957 to 20393	19957, 20175, 20393	1.4 MHz	QPSK, 16QAM	1 RB / 0 RB Offset
		19965 to 20385	19965, 20175, 20385	3 MHz	QPSK, 16QAM	1 RB / 0 RB Offset
		19975 to 20375	19975, 20175, 20375	5 MHz	QPSK, 16QAM	1 RB / 0 RB Offset
		20000 to 20350	20000, 20175, 20350	10 MHz	QPSK, 16QAM	1 RB / 0 RB Offset
		20025 to 20325	20025, 20175, 20325	15 MHz	QPSK, 16QAM	1 RB / 0 RB Offset
		20050 to 20300	20050, 20175, 20300	20 MHz	QPSK, 16QAM	1 RB / 0 RB Offset

EUT Configure Mode	Test Item	Available Channel	Tested Channel	Channel Bandwidth	Modulation	Mode		
-	Band Edge	19957 to 20393	19957	1.4 MHz	QPSK	1 RB / 0 RB Offset 6 RB / 0 RB Offset		
			20393	1.4 MHz	QPSK	1 RB / 5 RB Offset 6 RB / 0 RB Offset		
		19965 to 20385	19965	3 MHz	QPSK	1 RB / 0 RB Offset 15 RB / 0 RB Offset		
			20385	3 MHz	QPSK	1 RB / 14 RB Offset 15 RB / 0 RB Offset		
		19975 to 20375	19975	5 MHz	QPSK	1 RB / 0 RB Offset 25 RB / 0 RB Offset		
			20375	5 MHz	QPSK	1 RB / 24 RB Offset 25 RB / 0 RB Offset		
		20000 to 20350	20000	10 MHz	QPSK	1 RB / 0 RB Offset 50 RB / 0 RB Offset		
			20350	10 MHz	QPSK	1 RB / 49 RB Offset 50 RB / 0 RB Offset		
		20025 to 20325	20025	15 MHz	QPSK	1 RB / 0 RB Offset 75 RB / 0 RB Offset		
			20325	15 MHz	QPSK	1 RB / 74 RB Offset 75 RB / 0 RB Offset		
		20050 to 20300	20050	20 MHz	QPSK	1 RB / 0 RB Offset 100 RB / 0 RB Offset		
			20300	20 MHz	QPSK	1 RB / 99 RB Offset 100 RB / 0 RB Offset		
		-	Conducted Emission	19957 to 20393	19957, 20175, 20393	1.4 MHz	QPSK	1 RB / 0 RB Offset
				19965 to 20385	19965, 20175, 20385	3 MHz	QPSK	1 RB / 0 RB Offset
				19975 to 20375	19975, 20175, 20375	5 MHz	QPSK	1 RB / 0 RB Offset
				20000 to 20350	20000, 20175, 20350	10 MHz	QPSK	1 RB / 0 RB Offset
				20025 to 20325	20025, 20175, 20325	15 MHz	QPSK	1 RB / 0 RB Offset
				20050 to 20300	20050, 20175, 20300	20 MHz	QPSK	1 RB / 0 RB Offset
-	Radiated Emission	19957 to 20393	19957, 20175, 20393	1.4 MHz	QPSK	1 RB / 0 RB Offset		
		19975 to 20375	19975, 20175, 20375	5 MHz	QPSK	1 RB / 0 RB Offset		
		20050 to 20300	20050, 20175, 20300	20 MHz	QPSK	1 RB / 0 RB Offset		

Note:

1. This device was tested under all bandwidths, RB configurations and modulations. The worst case was found in QPSK modulation.
2. For radiated emission above 1 GHz, according to 3GPP 36.521 Section 6.6.3.1.4, choose the lowest, 5 MHz & highest channel bandwidth for final test.

LTE Band 12

EUT Configure Mode	Test Item	Available Channel	Tested Channel	Channel Bandwidth	Modulation	Mode		
-	ERP	23017 to 23173	23017, 23095, 23173	1.4 MHz	QPSK, 16QAM	1 RB / 0 RB Offset		
		23025 to 23165	23025, 23095, 23165	3 MHz	QPSK, 16QAM	1 RB / 0 RB Offset		
		23035 to 23155	23035, 23095, 23155	5 MHz	QPSK, 16QAM	1 RB / 0 RB Offset		
		23060 to 23130	23060, 23095, 23130	10 MHz	QPSK, 16QAM	1 RB / 0 RB Offset		
-	Modulation Characteristics	23060 to 23130	23095	10 MHz	QPSK, 16QAM	50 RB / 0 RB Offset		
-	Frequency Stability	23017 to 23173	23017, 23173	1.4 MHz	QPSK	1 RB / 0 RB Offset		
		23025 to 23165	23025, 23165	3 MHz	QPSK	1 RB / 0 RB Offset		
		23035 to 23155	23035, 23155	5 MHz	QPSK	1 RB / 0 RB Offset		
		23060 to 23130	23060, 23130	10 MHz	QPSK	1 RB / 0 RB Offset		
-	Occupied Bandwidth	23017 to 23173	23017, 23095, 23173	1.4 MHz	QPSK, 16QAM	6 RB / 0 RB Offset		
		23025 to 23165	23025, 23095, 23165	3 MHz	QPSK, 16QAM	15 RB / 0 RB Offset		
		23035 to 23155	23035, 23095, 23155	5 MHz	QPSK, 16QAM	25 RB / 0 RB Offset		
		23060 to 23130	23060, 23095, 23130	10 MHz	QPSK, 16QAM	50 RB / 0 RB Offset		
-	Peak to Average Ratio	23017 to 23173	23017, 23095, 23173	1.4 MHz	QPSK, 16QAM	1 RB / 0 RB Offset		
		23025 to 23165	23025, 23095, 23165	3 MHz	QPSK, 16QAM	1 RB / 0 RB Offset		
		23035 to 23155	23035, 23095, 23155	5 MHz	QPSK, 16QAM	1 RB / 0 RB Offset		
		23060 to 23130	23060, 23095, 23130	10 MHz	QPSK, 16QAM	1 RB / 0 RB Offset		
-	Band Edge	23017 to 23173	23017	1.4 MHz	QPSK	1 RB / 0 RB Offset		
			23173	1.4 MHz	QPSK	6 RB / 0 RB Offset		
		23025 to 23165	23025	3 MHz	QPSK	1 RB / 5 RB Offset		
			23165	3 MHz	QPSK	6 RB / 0 RB Offset		
		23035 to 23155	23035	5 MHz	QPSK	1 RB / 0 RB Offset		
			23155	5 MHz	QPSK	15 RB / 0 RB Offset		
		23060 to 23130	23060	10 MHz	QPSK	1 RB / 14 RB Offset		
			23130	10 MHz	QPSK	15 RB / 0 RB Offset		
		-	Conducted Emission	23017 to 23173	23017, 23095, 23173	1.4 MHz	QPSK	1 RB / 0 RB Offset
				23025 to 23165	23025, 23095, 23165	3 MHz	QPSK	1 RB / 0 RB Offset
				23035 to 23155	23035, 23095, 23155	5 MHz	QPSK	1 RB / 0 RB Offset
				23060 to 23130	23060, 23095, 23130	10 MHz	QPSK	1 RB / 0 RB Offset
-	Radiated Emission	23017 to 23173	23017, 23095, 23173	1.4 MHz	QPSK	1 RB / 0 RB Offset		
		23035 to 23155	23035, 23095, 23155	5 MHz	QPSK	1 RB / 0 RB Offset		
		23060 to 23130	23060, 23095, 23130	10 MHz	QPSK	1 RB / 0 RB Offset		

Note:

1. This device was tested under all bandwidths, RB configurations and modulations. The worst case was found in QPSK modulation.
2. For radiated emission above 1 GHz, according to 3GPP 36.521 Section 6.6.3.1.4, choose the lowest, 5 MHz & highest channel bandwidth for final test.

LTE Band 13

EUT Configure Mode	Test Item	Available Channel	Tested Channel	Channel Bandwidth	Modulation	Mode
-	ERP	23205 to 23255	23205, 23230, 23255	5 MHz	QPSK, 16QAM	1 RB / 0 RB Offset
		23230	23230	10 MHz	QPSK, 16QAM	1 RB / 0 RB Offset
-	Modulation Characteristics	23230	23230	10 MHz	QPSK, 16QAM	50 RB / 0 RB Offset
-	Frequency Stability	23205 to 23255	23205, 23255	5 MHz	QPSK	1 RB / 0 RB Offset
		23230	23230	10 MHz	QPSK	1 RB / 0 RB Offset
-	Occupied Bandwidth	23205 to 23255	23205, 23230, 23255	5 MHz	QPSK, 16QAM	25 RB / 0 RB Offset
		23230	23230	10 MHz	QPSK, 16QAM	50 RB / 0 RB Offset
-	Peak to Average Ratio	23205 to 23255	23205, 23230, 23255	5 MHz	QPSK, 16QAM	1 RB / 0 RB Offset
		23230	23230	10 MHz	QPSK, 16QAM	1 RB / 0 RB Offset
-	Band Edge	23205 to 23255	23205	5 MHz	QPSK	1 RB / 0 RB Offset
			23255	5 MHz	QPSK	25 RB / 0 RB Offset
		23230	23230	10 MHz	QPSK	1 RB / 24 RB Offset
			23230	10 MHz	QPSK	25 RB / 0 RB Offset
			23230	10 MHz	QPSK	1 RB / 0 RB Offset
			23230	10 MHz	QPSK	50 RB / 0 RB Offset
-	Conducted Emission	23205 to 23255	23205, 23230, 23255	5 MHz	QPSK	1 RB / 0 RB Offset
		23230	23230	10 MHz	QPSK	1 RB / 0 RB Offset
-	Radiated Emission	23205 to 23255	23205, 23230, 23255	5 MHz	QPSK	1 RB / 0 RB Offset
		23230	23230	10 MHz	QPSK	1 RB / 0 RB Offset

Note:

1. This device was tested under all bandwidths, RB configurations and modulations. The worst case was found in QPSK modulation.
2. For radiated emission above 1 GHz, according to 3GPP 36.521 Section 6.6.3.1.4, choose the lowest, 5 MHz & highest channel bandwidth for final test.

Test Condition:

Test Item	Environmental Conditions	Input Power	Tested By
ERP / EIRP	25 deg. C, 65 % RH	3.85 Vdc	Karl Lee
Modulation Characteristics	25 deg. C, 65 % RH	3.85 Vdc	Vincent Huang
Frequency Stability	25 deg. C, 65 % RH	3.85 Vdc	Vincent Huang
Occupied Bandwidth	25 deg. C, 65 % RH	3.85 Vdc	Vincent Huang
Band Edge	25 deg. C, 65 % RH	3.85 Vdc	Vincent Huang
Peak to Average Ratio	25 deg. C, 65 % RH	3.85 Vdc	Vincent Huang
Conducted Emission	25 deg. C, 65 % RH	3.85 Vdc	Vincent Huang
Radiated Emission	25 deg. C, 65 % RH	120 Vac, 60 Hz	Karl Lee

3.4 EUT Operating Conditions

The EUT makes a call to the communication simulator. The communication simulator station system controlled a EUT to export maximum output power under transmission mode and specific channel frequency

3.5 General Description of Applied Standards

The EUT is a RF Product. According to the specifications of the manufacturer, it must comply with the requirements of the following standards:

FCC 47 CFR Part 2

FCC 47 CFR Part 27

KDB 971168 D01 Power Meas License Digital Systems v03r01

ANSI/TIA/EIA-603-E 2016

ANSI 63.26-2015

Note: All test items have been performed and recorded as per the above standards.

4 Test Types and Results

4.1 Output Power Measurement

4.1.1 Limits of Output Power Measurement

Fixed, mobile, and portable (hand-held) stations operating in the 1710–1755 MHz band and mobile and portable stations operating in the 1695-1710 MHz and 1755-1780 MHz bands are limited to 1 watt EIRP.

Portable stations (hand-held devices) operating in the 746-757 MHz, 776-788 MHz and 805-806 MHz band are limited to 3 watts ERP

Portable stations (hand-held device) operating in the 600 MHz uplink band and the 698-746 MHz band, and fixed and mobile stations in the 600 MHz uplink band are limited to 3 watts ERP.

4.1.2 Test Procedures

EIRP / ERP Measurement:

- a. All measurements were done at low, middle and high operational frequency range. RBW and VBW is 5 MHz for WCDMA and 10 MHz for LTE mode.
- b. Substitution method is used for E.I.R.P measurement. In the semi-anechoic chamber, EUT placed on the 0.8 m (below or equal 1 GHz) and/or 1.5 m (above 1 GHz) height of Turn Table, rotated the table around 360 degrees to search the maximum radiation power and receiver antenna shall be rotated vertical and horizontal polarization and moved height from 1 m to 4 m to find the maximum polar radiated power. The “Read Value” is the spectrum reading the maximum power value.
- c. The substitution horn antenna is substituted for EUT at the same position and signals generator export the CW signal to the substitution antenna via a tx cable. Rotated the Turn Table and moved receiving antenna to find the maximum radiation power. Adjust output power level of S.G to get a Value of spectrum reading equal to “Read Value” of step b. Record the power level of S.G.
- d. $EIRP = \text{Output power level of S.G} - \text{TX cable loss} + \text{Antenna gain of substitution horn}$. E.R.P power can be calculated form E.I.R.P power by subtracting the gain of dipole, $E.R.P \text{ power} = E.I.R.P \text{ power} - 2.15 \text{ dB}$.

Conducted Power Measurement:

- a. The EUT was set up for the maximum power with WCDMA and LTE link data modulation and link up with simulator.
- b. Set the EUT to transmit under low, middle and high channel and record the power level shown on simulator.

4.1.3 Test Setup

EIRP / ERP Measurement:

<Radiated Emission below or equal 1 GHz>

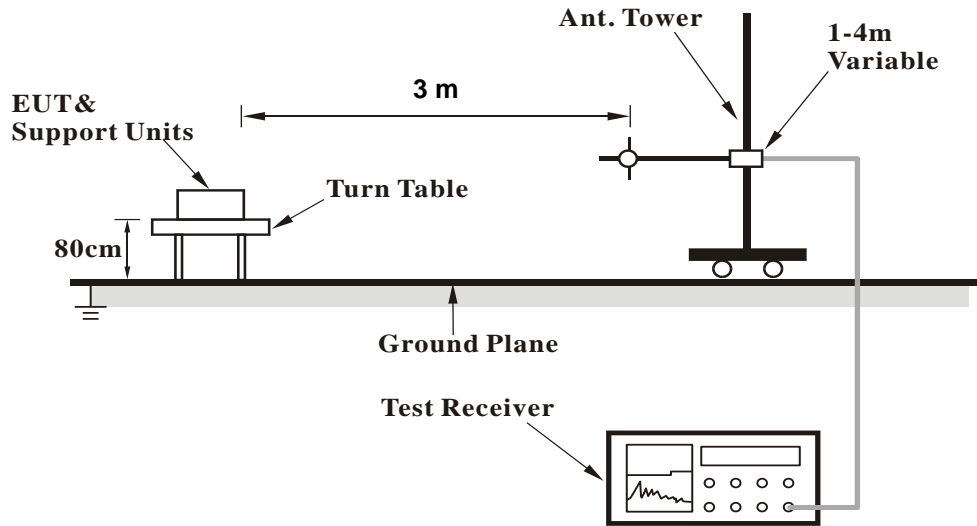

<Radiated Emission above 1 GHz>

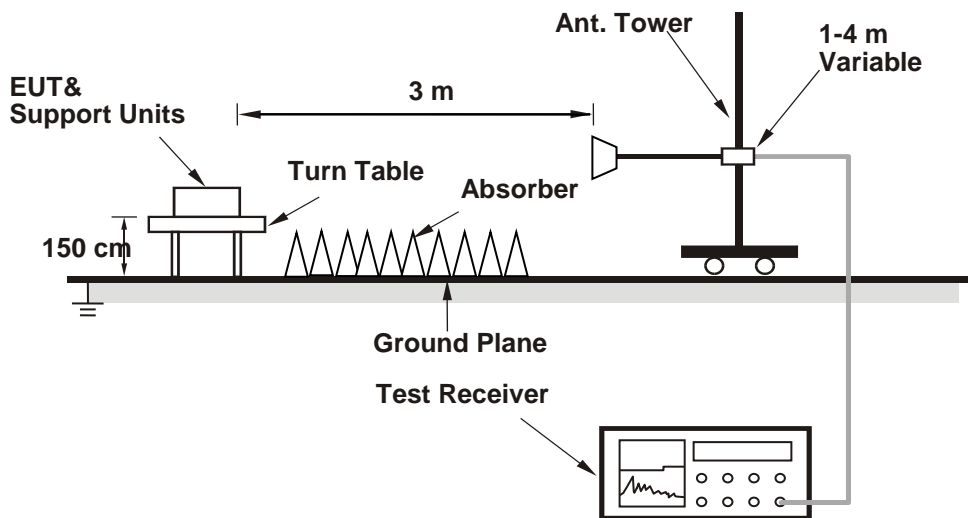

For the actual test configuration, please refer to the attached file (Test Setup Photo).

Conducted Power Measurement:

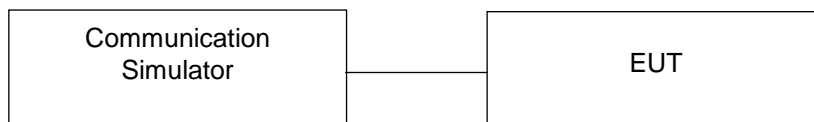

4.1.4 Test Results

Conducted Output Power (dBm)

Band	WCDMA IV		
	1312	1413	1513
Channel	1712.4	1732.6	1752.6
Frequency (MHz)	1712.4	1732.6	1752.6
RMC 12.2K	23.77	23.68	23.73
HSDPA Subtest-1	23.02	23.08	23.05
HSDPA Subtest-2	23.01	23.07	23.04
HSDPA Subtest-3	22.54	22.60	22.57
HSDPA Subtest-4	22.53	22.59	22.56
DC-HSDPA Subtest-1	23.00	23.06	23.03
DC-HSDPA Subtest-2	22.99	23.05	23.02
DC-HSDPA Subtest-3	22.52	22.58	22.55
DC-HSDPA Subtest-4	22.51	22.57	22.54
HSUPA Subtest-1	22.80	22.84	22.82
HSUPA Subtest-2	21.07	21.11	21.08
HSUPA Subtest-3	22.09	22.13	22.10
HSUPA Subtest-4	21.07	21.11	21.05
HSUPA Subtest-5	23.09	23.13	23.11

LTE Band 4																	
BW	MCS Index	RB Size	RB Offset	Low	Mid	High	3GPP MPR (dB)	BW	MCS Index	RB Size	RB Offset	Low	Mid	High	3GPP MPR (dB)		
				Channel	20050	20175						20300	Channel	20025		20175	20325
				Frequency (MHz)	1720.0	1732.5						1745.0	Frequency (MHz)	1717.5		1732.5	1747.5
20M	QPSK	1	0	23.81	23.82	23.83	0	15M	QPSK	1	0	23.79	23.80	23.86	0		
		1	50	23.68	23.69	23.75	0			1	37	23.66	23.67	23.73	0		
		1	99	23.62	23.63	23.69	0			1	74	23.60	23.61	23.67	0		
		50	0	22.82	22.83	22.90	1			36	0	22.80	22.81	22.87	1		
		50	25	22.85	22.86	22.89	1			36	19	22.83	22.84	22.88	1		
		50	50	22.86	22.87	22.88	1			36	39	22.84	22.85	22.90	1		
		100	0	22.81	22.85	22.87	1			75	0	22.79	22.83	22.88	1		
	16QAM	1	0	22.87	22.88	22.80	1		16QAM	1	0	22.85	22.86	22.78	1		
		1	50	22.86	22.87	22.83	1			1	37	22.84	22.85	22.81	1		
		1	99	22.77	22.78	22.84	1			1	74	22.75	22.76	22.82	1		
		50	0	21.87	21.88	21.75	2			36	0	21.85	21.86	21.73	2		
		50	25	21.84	21.85	21.76	2			36	19	21.82	21.83	21.74	2		
		50	50	21.79	21.80	21.86	2			36	39	21.77	21.78	21.84	2		
		100	0	21.86	21.87	21.75	2			75	0	21.84	21.85	21.73	2		
10M	QPSK	1	0	23.76	23.77	23.83	0	5M	QPSK	1	0	23.75	23.76	23.82	0		
		1	24	23.63	23.64	23.70	0			1	12	23.62	23.63	23.69	0		
		1	49	23.57	23.58	23.64	0			1	24	23.56	23.57	23.63	0		
		25	0	22.77	22.78	22.84	1			12	0	22.76	22.77	22.83	1		
		25	12	22.80	22.81	22.85	1			12	6	22.79	22.80	22.84	1		
		25	25	22.81	22.82	22.88	1			12	13	22.80	22.81	22.87	1		
		50	0	22.76	22.80	22.88	1			25	0	22.75	22.79	22.87	1		
	16QAM	1	0	22.82	22.83	22.75	1		16QAM	1	0	22.81	22.82	22.74	1		
		1	24	22.81	22.82	22.78	1			1	12	22.80	22.81	22.77	1		
		1	49	22.72	22.73	22.79	1			1	24	22.71	22.72	22.78	1		
		25	0	21.82	21.83	21.70	2			12	0	21.81	21.82	21.69	2		
		25	12	21.79	21.80	21.71	2			12	6	21.78	21.79	21.70	2		
		25	25	21.74	21.75	21.81	2			12	13	21.73	21.74	21.80	2		
		50	0	21.81	21.82	21.70	2			25	0	21.80	21.81	21.69	2		
3M	QPSK	1	0	23.72	23.73	23.79	0	1.4M	QPSK	1	0	23.68	23.69	23.75	0		
		1	7	23.59	23.60	23.66	0			1	2	23.55	23.56	23.62	0		
		1	14	23.53	23.54	23.60	0			1	5	23.49	23.50	23.56	0		
		8	0	22.73	22.74	22.80	1			3	0	23.66	23.67	23.73	0		
		8	3	22.76	22.77	22.81	1			3	1	23.53	23.54	23.60	0		
		8	7	22.77	22.78	22.84	1			3	3	23.47	23.48	23.54	0		
		15	0	22.72	22.76	22.80	1			6	0	22.68	22.72	22.88	1		
	16QAM	1	0	22.78	22.79	22.71	1		16QAM	1	0	22.65	22.66	22.72	1		
		1	7	22.77	22.78	22.74	1			1	2	22.52	22.53	22.59	1		
		1	14	22.68	22.69	22.75	1			1	5	22.46	22.47	22.53	1		
		8	0	21.78	21.79	21.66	2			3	0	22.63	22.64	22.70	1		
		8	3	21.75	21.76	21.67	2			3	1	22.50	22.51	22.57	1		
		8	7	21.70	21.71	21.77	2			3	3	22.44	22.45	22.51	1		
		15	0	21.77	21.78	21.66	2			6	0	21.65	21.69	21.85	2		

LTE Band 12																	
BW	MCS Index	RB Size	RB Offset	Low	Mid	High	3GPP MPR (dB)	BW	MCS Index	RB Size	RB Offset	Low	Mid	High	3GPP MPR (dB)		
				Channel	23060	23095						23130	Channel	23035		23095	23155
				Frequency (MHz)	704.0	707.5						711.0	Frequency (MHz)	701.5		707.5	713.5
10M	QPSK	1	0	22.61	22.85	22.84	0	5M	QPSK	1	0	22.50	22.68	22.69	0		
		1	24	22.60	22.84	22.83	0			1	12	22.58	22.75	22.62	0		
		1	49	22.47	22.71	22.70	0			1	24	22.38	22.55	22.49	0		
		25	0	21.62	21.86	21.85	1			12	0	21.46	21.65	21.57	1		
		25	12	21.70	21.94	21.93	1			12	6	21.57	21.80	21.82	1		
		25	25	21.54	21.78	21.77	1			12	13	21.36	21.67	21.47	1		
		50	0	21.56	21.80	21.79	1			25	0	21.47	21.74	21.55	1		
	16QAM	1	0	21.59	21.83	21.82	1		16QAM	1	0	21.47	21.71	21.63	1		
		1	24	21.94	21.99	21.98	1			1	12	21.72	21.99	21.99	1		
		1	49	21.68	21.92	21.91	1			1	24	21.57	21.76	21.77	1		
		25	0	20.58	20.82	20.81	2			12	0	20.45	20.66	20.77	2		
		25	12	20.60	20.84	20.83	2			12	6	20.47	20.69	20.61	2		
		25	25	20.53	20.77	20.76	2			12	13	20.44	20.65	20.61	2		
		50	0	20.57	20.81	20.80	2			25	0	20.52	20.71	20.74	2		

LTE Band 13																	
BW	MCS Index	RB Size	RB Offset	Low	Mid	High	3GPP MPR (dB)	BW	MCS Index	RB Size	RB Offset	Low	Mid	High	3GPP MPR (dB)		
				Channel	23230	23230						23230	Channel	23205		23230	23225
				Frequency (MHz)	782.0	782.0						782.0	Frequency (MHz)	779.5		782.0	784.5
10M	QPSK	1	0		23.64		0	5M	QPSK	1	0	23.54	23.57	23.59	0		
		1	24		23.37		0			1	12	23.17	23.33	23.29	0		
		1	49		23.24		0			1	24	23.09	23.24	23.10	0		
		25	0		23.06		1			12	0	22.89	22.99	22.97	1		
		25	12		22.59		1			12	6	22.40	22.59	22.54	1		
		25	25		22.31		1			12	13	22.16	22.25	22.21	1		
		50	0		22.79		1			25	0	22.62	22.71	22.67	1		
	16QAM	1	0		22.88		1		16QAM	1	0	22.76	22.79	22.80	1		
		1	24		22.93		1			1	12	22.73	22.84	22.83	1		
		1	49		22.74		1			1	24	22.54	22.65	22.66	1		
		25	0		21.85		2			12	0	21.70	21.85	21.72	2		
		25	12		21.44		2			12	6	21.32	21.38	21.38	2		
		25	25		21.31		2			12	13	21.11	21.22	21.20	2		
		50	0		21.67		2			25	0	21.49	21.61	21.62	2		

ERP Power (dBm)

LTE Band 12							
Channel Bandwidth: 1.4 MHz / QPSK							
Plane	Channel	Frequency (MHz)	Reading (dBm)	Correction Factor (dB)	ERP (dBm)	ERP (mW)	Polarization (H/V)
X	23017	699.7	-12.32	32.719	18.25	66.82	H
	23095	707.5	-11.96	32.736	18.63	72.88	
	23173	715.3	-11.87	32.591	18.57	71.96	
	23017	699.7	-17.25	32.69	13.29	21.33	V
	23095	707.5	-17.03	32.81	13.63	23.07	
	23173	715.3	-17.08	32.74	13.51	22.44	
Channel Bandwidth: 1.4 MHz / 16QAM							
X	23017	699.7	-13.33	32.719	17.24	52.95	H
	23095	707.5	-12.97	32.736	17.62	57.76	
	23173	715.3	-12.88	32.591	17.56	57.03	
	23017	699.7	-18.26	32.69	12.28	16.90	V
	23095	707.5	-18.03	32.81	12.63	18.32	
	23173	715.3	-18.09	32.74	12.50	17.78	

Note: ERP (dBm) = Reading (dBm) + Correction Factor (dB) – 2.15

LTE Band 12							
Channel Bandwidth: 3 MHz / QPSK							
Plane	Channel	Frequency (MHz)	Reading (dBm)	Correction Factor (dB)	ERP (dBm)	ERP (mW)	Polarization (H/V)
X	23025	700.5	-12.28	32.719	18.29	67.44	H
	23095	707.5	-11.93	32.736	18.66	73.38	
	23165	714.5	-11.83	32.591	18.61	72.63	
	23025	700.5	-17.21	32.69	13.33	21.53	V
	23095	707.5	-16.99	32.81	13.67	23.28	
	23165	714.5	-17.04	32.74	13.55	22.65	
Channel Bandwidth: 3 MHz / 16QAM							
X	23025	700.5	-13.29	32.719	17.28	53.44	H
	23095	707.5	-12.93	32.736	17.66	58.29	
	23165	714.5	-12.83	32.591	17.61	57.69	
	23025	700.5	-18.22	32.69	12.32	17.06	V
	23095	707.5	-18.00	32.81	12.66	18.45	
	23165	714.5	-18.05	32.74	12.54	17.95	

Note: ERP (dBm) = Reading (dBm) + Correction Factor (dB) – 2.15

LTE Band 12							
Channel Bandwidth: 5 MHz / QPSK							
Plane	Channel	Frequency (MHz)	Reading (dBm)	Correction Factor (dB)	ERP (dBm)	ERP (mW)	Polarization (H/V)
X	23035	701.5	-12.24	32.719	18.33	68.06	H
	23095	707.5	-11.89	32.736	18.70	74.06	
	23155	713.5	-11.80	32.591	18.64	73.13	
	23035	701.5	-17.17	32.69	13.37	21.73	V
	23095	707.5	-16.95	32.81	13.71	23.50	
	23155	713.5	-17.00	32.74	13.59	22.86	
Channel Bandwidth: 5 MHz / 16QAM							
X	23035	701.5	-13.24	32.719	17.33	54.06	H
	23095	707.5	-12.89	32.736	17.70	58.83	
	23155	713.5	-12.81	32.591	17.63	57.96	
	23035	701.5	-18.18	32.69	12.36	17.22	V
	23095	707.5	-17.95	32.81	12.71	18.66	
	23155	713.5	-18.01	32.74	12.58	18.11	

Note: ERP (dBm) = Reading (dBm) + Correction Factor (dB) – 2.15

LTE Band 12							
Channel Bandwidth: 10 MHz / QPSK							
Plane	Channel	Frequency (MHz)	Reading (dBm)	Correction Factor (dB)	ERP (dBm)	ERP (mW)	Polarization (H/V)
X	23060	704.0	-12.20	32.727	18.38	68.82	H
	23095	707.5	-11.85	32.739	18.74	74.80	
	23130	711.0	-11.90	32.728	18.68	73.76	
	23060	704.0	-17.19	32.75	13.41	21.93	V
	23095	707.5	-16.91	32.81	13.75	23.71	
	23130	711.0	-17.06	32.84	13.63	23.07	
Channel Bandwidth: 10 MHz / 16QAM							
X	23060	704.0	-13.21	32.727	17.37	54.54	H
	23095	707.5	-12.86	32.739	17.73	59.28	
	23130	711.0	-12.91	32.728	17.67	58.45	
	23060	704.0	-18.20	32.75	12.40	17.38	V
	23095	707.5	-17.92	32.81	12.74	18.79	
	23130	711.0	-18.07	32.84	12.62	18.28	

Note: ERP (dBm) = Reading (dBm) + Correction Factor (dB) – 2.15

LTE Band 13							
Channel Bandwidth: 5 MHz / QPSK							
Plane	Channel	Frequency (MHz)	Reading (dBm)	Correction Factor (dB)	ERP (dBm)	ERP (mW)	Polarization (H/V)
X	23205	779.5	-8.90	32.771	21.72	148.63	H
	23230	782.0	-8.80	32.741	21.79	151.04	
	23255	784.5	-8.86	32.854	21.84	152.90	
	23205	779.5	-12.56	32.5	17.79	60.12	V
	23230	782.0	-12.54	32.52	17.83	60.67	
	23255	784.5	-12.58	32.62	17.89	61.52	
Channel Bandwidth: 5 MHz / 16QAM							
X	23205	779.5	-9.91	32.771	20.71	117.79	H
	23230	782.0	-9.82	32.741	20.77	119.43	
	23255	784.5	-9.88	32.854	20.82	120.89	
	23205	779.5	-13.57	32.5	16.78	47.64	V
	23230	782.0	-13.55	32.52	16.82	48.08	
	23255	784.5	-13.59	32.62	16.88	48.75	

Note: ERP (dBm) = Reading (dBm) + Correction Factor (dB) – 2.15

LTE Band 13							
Channel Bandwidth: 10 MHz / QPSK							
Plane	Channel	Frequency (MHz)	Reading (dBm)	Correction Factor (dB)	ERP (dBm)	ERP (mW)	Polarization (H/V)
X	23230	782.0	-8.76	32.737	21.83	152.30	H
	23230	782.0	-12.50	32.52	17.87	61.24	V
Channel Bandwidth: 10 MHz / 16QAM							
X	23230	782.0	-9.77	32.737	20.82	120.70	H
	23230	782.0	-13.51	32.52	16.86	48.53	V

Note: ERP (dBm) = Reading (dBm) + Correction Factor (dB) – 2.15

EIRP Power (dBm)

WCDMA							
Plane	Channel	Frequency (MHz)	Reading (dBm)	Correction Factor (dB)	EIRP (dBm)	EIRP (mW)	Polarization (H/V)
X	1312	1712.4	-18.20	42.49	24.29	268.23	H
	1413	1732.6	-18.10	42.33	24.23	264.67	
	1513	1752.6	-17.90	42.10	24.20	263.03	
	1312	1712.4	-22.70	42.99	20.29	106.91	V
	1413	1732.6	-22.50	42.74	20.24	105.68	
	1513	1752.6	-22.00	42.21	20.21	104.95	

Note: EIRP (dBm) = Reading (dBm) + Correction Factor (dB)

LTE Band 4							
Channel Bandwidth: 1.4 MHz / QPSK							
Plane	Channel	Frequency (MHz)	Reading (dBm)	Correction Factor (dB)	EIRP (dBm)	EIRP (mW)	Polarization (H/V)
X	19957	1710.7	-18.60	42.49	23.89	244.62	H
	20175	1732.5	-18.58	42.33	23.75	236.97	
	20393	1754.3	-18.19	42.10	23.91	246.04	
	19957	1710.7	-23.09	42.99	19.90	97.72	V
	20175	1732.5	-22.89	42.74	19.85	96.61	
	20393	1754.3	-22.28	42.21	19.93	98.40	
Channel Bandwidth: 1.4 MHz / 16QAM							
X	19957	1710.7	-19.61	42.49	22.88	193.87	H
	20175	1732.5	-19.59	42.33	22.74	187.80	
	20393	1754.3	-19.20	42.10	22.90	194.98	
	19957	1710.7	-24.10	42.99	18.89	77.45	V
	20175	1732.5	-23.90	42.74	18.84	76.56	
	20393	1754.3	-23.28	42.21	18.93	78.16	

Note: EIRP (dBm) = Reading (dBm) + Correction Factor (dB)

LTE Band 4							
Channel Bandwidth: 3 MHz / QPSK							
Plane	Channel	Frequency (MHz)	Reading (dBm)	Correction Factor (dB)	EIRP (dBm)	EIRP (mW)	Polarization (H/V)
X	19965	1711.5	-18.56	42.49	23.93	246.89	H
	20175	1732.5	-18.55	42.33	23.78	238.62	
	20385	1753.5	-18.15	42.10	23.95	248.31	
	19965	1711.5	-23.05	42.99	19.94	98.63	V
	20175	1732.5	-22.85	42.74	19.89	97.50	
	20385	1753.5	-22.24	42.21	19.97	99.31	
Channel Bandwidth: 3 MHz / 16QAM							
X	19965	1711.5	-19.56	42.49	22.93	196.11	H
	20175	1732.5	-19.55	42.33	22.78	189.54	
	20385	1753.5	-19.16	42.10	22.94	196.79	
	19965	1711.5	-24.05	42.99	18.94	78.34	V
	20175	1732.5	-23.85	42.74	18.89	77.45	
	20385	1753.5	-23.25	42.21	18.96	78.70	

Note: EIRP (dBm) = Reading (dBm) + Correction Factor (dB)

LTE Band 4							
Channel Bandwidth: 5 MHz / QPSK							
Plane	Channel	Frequency (MHz)	Reading (dBm)	Correction Factor (dB)	EIRP (dBm)	EIRP (mW)	Polarization (H/V)
X	19975	1712.5	-18.52	42.49	23.97	249.17	H
	20175	1732.5	-18.51	42.33	23.82	240.82	
	20375	1752.5	-18.11	42.10	23.99	250.61	
	19975	1712.5	-23.02	42.99	19.97	99.31	V
	20175	1732.5	-22.81	42.74	19.93	98.40	
	20375	1752.5	-22.20	42.21	20.01	100.23	
Channel Bandwidth: 5 MHz / 16QAM							
X	19975	1712.5	-19.52	42.49	22.97	197.92	H
	20175	1732.5	-19.52	42.33	22.81	190.85	
	20375	1752.5	-19.12	42.10	22.98	198.61	
	19975	1712.5	-24.03	42.99	18.96	78.70	V
	20175	1732.5	-23.82	42.74	18.92	77.98	
	20375	1752.5	-23.21	42.21	19.00	79.43	

Note: EIRP (dBm) = Reading (dBm) + Correction Factor (dB)

LTE Band 4							
Channel Bandwidth: 10 MHz / QPSK							
Plane	Channel	Frequency (MHz)	Reading (dBm)	Correction Factor (dB)	EIRP (dBm)	EIRP (mW)	Polarization (H/V)
X	20000	1715.0	-18.49	42.49	24.00	250.90	H
	20175	1732.5	-18.47	42.33	23.86	243.05	
	20350	1750.0	-18.08	42.10	24.02	252.35	
	20000	1715.0	-22.98	42.99	20.01	100.23	V
	20175	1732.5	-22.77	42.74	19.97	99.31	
	20350	1750.0	-22.16	42.21	20.05	101.16	
Channel Bandwidth: 10 MHz / 16QAM							
X	20000	1715.0	-19.50	42.49	22.99	198.84	H
	20175	1732.5	-19.47	42.33	22.86	193.06	
	20350	1750.0	-19.09	42.10	23.01	199.99	
	20000	1715.0	-23.98	42.99	19.01	79.62	V
	20175	1732.5	-23.78	42.74	18.96	78.70	
	20350	1750.0	-23.16	42.21	19.05	80.35	

Note: EIRP (dBm) = Reading (dBm) + Correction Factor (dB)

LTE Band 4							
Channel Bandwidth: 15 MHz / QPSK							
Plane	Channel	Frequency (MHz)	Reading (dBm)	Correction Factor (dB)	EIRP (dBm)	EIRP (mW)	Polarization (H/V)
X	20025	1717.5	-18.45	42.49	24.04	253.22	H
	20175	1732.5	-18.34	42.33	23.99	250.44	
	20325	1747.5	-18.04	42.10	24.06	254.68	
	20025	1717.5	-22.94	42.99	20.05	101.16	V
	20175	1732.5	-22.74	42.74	20.00	100.00	
	20325	1747.5	-22.13	42.21	20.08	101.86	
Channel Bandwidth: 15 MHz / 16QAM							
X	20025	1717.5	-19.46	42.49	23.03	200.68	H
	20175	1732.5	-19.35	42.33	22.98	198.47	
	20325	1747.5	-19.04	42.10	23.06	202.30	
	20025	1717.5	-23.94	42.99	19.05	80.35	V
	20175	1732.5	-23.74	42.74	19.00	79.43	
	20325	1747.5	-23.14	42.21	19.07	80.72	

Note: EIRP (dBm) = Reading (dBm) + Correction Factor (dB)

LTE Band 4							
Channel Bandwidth: 20 MHz / QPSK							
Plane	Channel	Frequency (MHz)	Reading (dBm)	Correction Factor (dB)	EIRP (dBm)	EIRP (mW)	Polarization (H/V)
X	20050	1720.0	-18.41	42.49	24.08	255.56	H
	20175	1732.5	-18.30	42.33	24.03	252.76	
	20300	1745.0	-18.00	42.10	24.10	257.04	
	20050	1720.0	-22.90	42.99	20.09	102.09	V
	20175	1732.5	-22.70	42.74	20.04	100.93	
	20300	1745.0	-22.09	42.21	20.12	102.80	
Channel Bandwidth: 20 MHz / 16QAM							
X	20050	1720.0	-19.42	42.49	23.07	202.53	H
	20175	1732.5	-19.31	42.33	23.02	200.31	
	20300	1745.0	-19.00	42.10	23.10	204.17	
	20050	1720.0	-23.90	42.99	19.09	81.10	V
	20175	1732.5	-23.71	42.74	19.03	79.98	
	20300	1745.0	-23.10	42.21	19.11	81.47	

Note: EIRP (dBm) = Reading (dBm) + Correction Factor (dB)

4.2 Modulation Characteristics Measurement

4.2.1 Limits of Modulation Characteristics

N/A

4.2.2 Test Setup



4.2.3 Test Procedure

Connect the EUT to Communication Simulator via the antenna connector. The frequency band is set as EUT supported Modulation and Channels, the EUT output is matched with 50 ohm load, the waveform quality and constellation of the EUT was tested.

4.2.4 Test Results

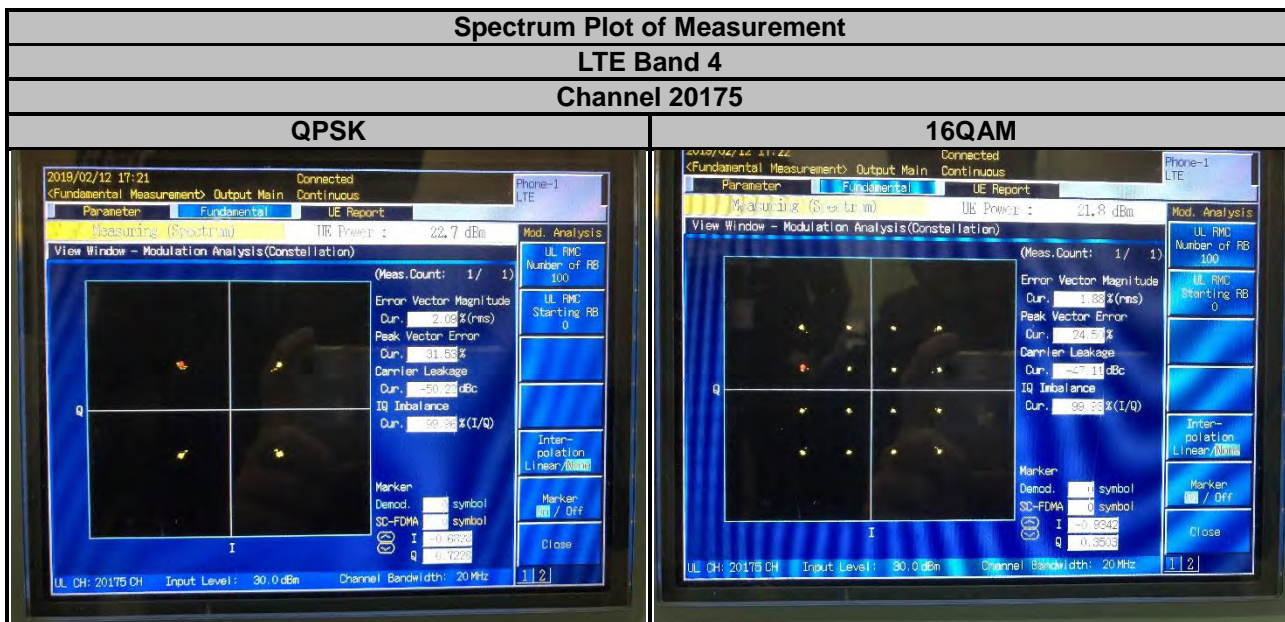
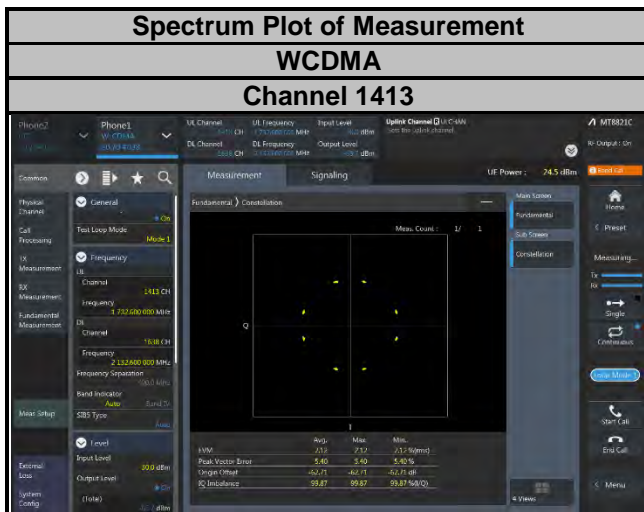

Spectrum Plot of Measurement

LTE Band 12

Channel 23095

QPSK

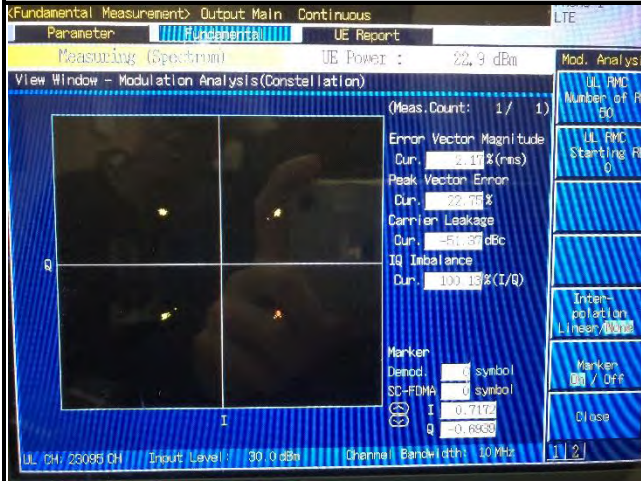

16QAM



Spectrum Plot of Measurement

LTE Band 13

Channel 23230

QPSK

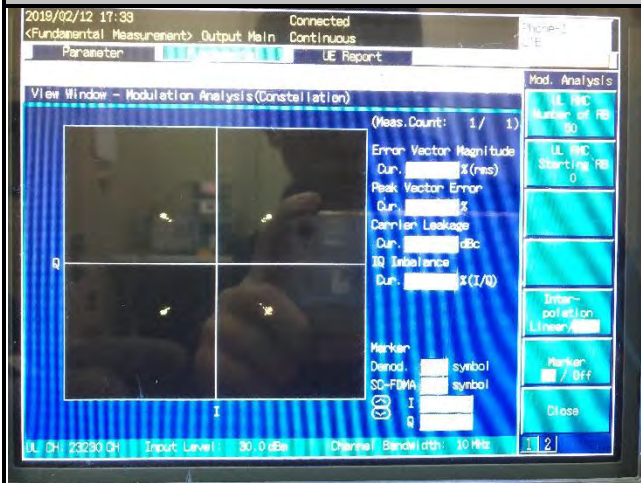

16QAM



4.3 Frequency Stability Measurement

4.3.1 Limits of Frequency Stability Measurement

The frequency stability shall be sufficient to ensure that the fundamental emissions stay within the authorized bands of operation.

4.3.2 Test Procedure

- Device is placed at the oven room. The oven room could control the temperatures and humidity. Power warm up is at least 15 min and power applied should perform before recording frequency error.
- EUT is connected the external power supply to control the DC input power. The test voltage range is from minimum to maximum working voltage. Each step shall be record the frequency error rate.
- The temperature range step is 10 degrees in this test items. All temperature levels shall be hold the ± 0.5 °C during the measurement testing. The each temperature step shall be at least 0.5 hours, consider the EUT could be test under the stability condition.

Note: The frequency error was recorded frequency error from the communication simulator.

4.3.3 Test Setup

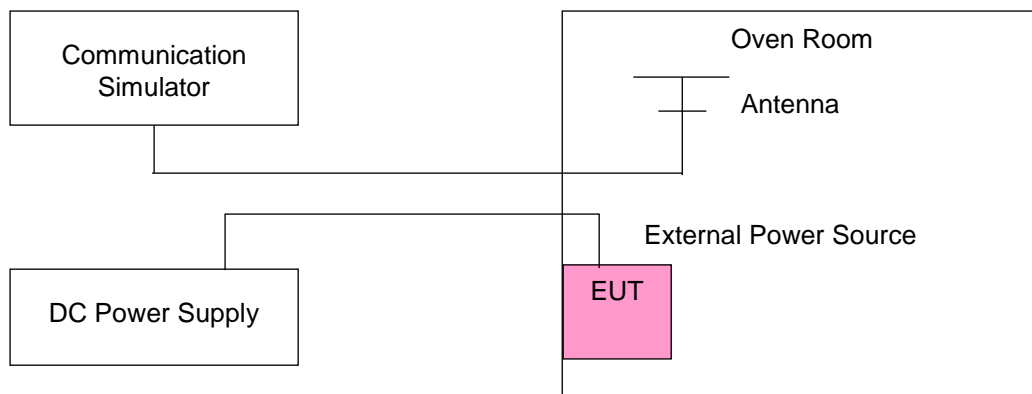

4.3.4 Test Results

Frequency Error vs. Voltage

Voltage (Volts)	WCDMA			
	Low Channel		High Channel	
	Frequency (MHz)	Frequency Error (ppm)	Frequency (MHz)	Frequency Error (ppm)
3.85	1712.400001	0.001	1752.600001	0.001
3.27	1712.400004	0.002	1752.600002	0.001
4.43	1712.400003	0.002	1752.600002	0.001

Note: The applicant defined the normal working voltage of the battery is from 3.27 Vdc to 4.43 Vdc.

Frequency Error vs. Temperature

Temp. (°C)	WCDMA			
	Low Channel		High Channel	
	Frequency (MHz)	Frequency Error (ppm)	Frequency (MHz)	Frequency Error (ppm)
-30	1712.400004	0.002	1752.600003	0.001
-20	1712.400002	0.001	1752.600003	0.002
-10	1712.400002	0.001	1752.600003	0.002
0	1712.400001	0.001	1752.600003	0.001
10	1712.400001	0.001	1752.600001	0.001
20	1712.399997	-0.002	1752.599999	-0.001
30	1712.399996	-0.002	1752.599998	-0.001
40	1712.399997	-0.002	1752.599996	-0.002
50	1712.399997	-0.002	1752.599998	-0.001
55	1712.399999	-0.001	1752.599999	-0.001

Frequency Error vs. Voltage

Voltage (Volts)	LTE Band 4			
	Channel Bandwidth: 1.4 MHz			
	Low Channel		High Channel	
	Frequency (MHz)	Frequency Error (ppm)	Frequency (MHz)	Frequency Error (ppm)
3.85	1710.700004	0.002	1754.300001	0.001
3.27	1710.700001	0.001	1754.300002	0.001
4.43	1710.700003	0.002	1754.300004	0.002

Note: The applicant defined the normal working voltage of the battery is from 3.27 Vdc to 4.43 Vdc.

Frequency Error vs. Temperature

Temp. (°C)	LTE Band 4			
	Channel Bandwidth: 1.4 MHz			
	Low Channel		High Channel	
	Frequency (MHz)	Frequency Error (ppm)	Frequency (MHz)	Frequency Error (ppm)
-30	1710.700002	0.001	1754.300003	0.001
-20	1710.700003	0.002	1754.300002	0.001
-10	1710.700002	0.001	1754.300003	0.002
0	1710.700004	0.002	1754.300002	0.001
10	1710.700002	0.001	1754.300001	0.001
20	1710.699998	-0.001	1754.299997	-0.002
30	1710.699997	-0.002	1754.299998	-0.001
40	1710.699997	-0.002	1754.299997	-0.002
50	1710.699999	-0.001	1754.299996	-0.002
55	1710.699998	-0.001	1754.299998	-0.001

Frequency Error vs. Voltage

Voltage (Volts)	LTE Band 4			
	Channel Bandwidth: 3 MHz			
	Low Channel		High Channel	
	Frequency (MHz)	Frequency Error (ppm)	Frequency (MHz)	Frequency Error (ppm)
3.85	1711.500002	0.001	1753.500003	0.002
3.27	1711.500003	0.002	1753.500003	0.002
4.43	1711.500003	0.002	1753.500002	0.001

Note: The applicant defined the normal working voltage of the battery is from 3.27 Vdc to 4.43 Vdc.

Frequency Error vs. Temperature

Temp. (°C)	LTE Band 4			
	Channel Bandwidth: 3 MHz			
	Low Channel		High Channel	
	Frequency (MHz)	Frequency Error (ppm)	Frequency (MHz)	Frequency Error (ppm)
-30	1711.500003	0.002	1753.500002	0.001
-20	1711.500001	0.001	1753.500001	0.001
-10	1711.500001	0.001	1753.500001	0.001
0	1711.500001	0.001	1753.500001	0.001
10	1711.500001	0.001	1753.500002	0.001
20	1711.499996	-0.002	1753.499996	-0.002
30	1711.499998	-0.001	1753.499999	-0.001
40	1711.499999	-0.001	1753.499996	-0.002
50	1711.499997	-0.002	1753.499998	-0.001
55	1711.499997	-0.002	1753.499998	-0.001

Frequency Error vs. Voltage

Voltage (Volts)	LTE Band 4			
	Channel Bandwidth: 5 MHz			
	Low Channel		High Channel	
	Frequency (MHz)	Frequency Error (ppm)	Frequency (MHz)	Frequency Error (ppm)
3.85	1712.500003	0.002	1752.500004	0.002
3.27	1712.500003	0.002	1752.500004	0.002
4.43	1712.500001	0.001	1752.500002	0.001

Note: The applicant defined the normal working voltage of the battery is from 3.27 Vdc to 4.43 Vdc.

Frequency Error vs. Temperature

Temp. (°C)	LTE Band 4			
	Channel Bandwidth: 5 MHz			
	Low Channel		High Channel	
	Frequency (MHz)	Frequency Error (ppm)	Frequency (MHz)	Frequency Error (ppm)
-30	1712.500002	0.001	1752.500001	0.001
-20	1712.500004	0.002	1752.500002	0.001
-10	1712.500003	0.002	1752.500002	0.001
0	1712.500003	0.001	1752.500003	0.002
10	1712.500003	0.002	1752.500003	0.002
20	1712.499997	-0.002	1752.499998	-0.001
30	1712.499999	-0.001	1752.499999	-0.001
40	1712.499999	-0.001	1752.499997	-0.002
50	1712.499998	-0.001	1752.499999	-0.001
55	1712.499999	-0.001	1752.499996	-0.002

Frequency Error vs. Voltage

Voltage (Volts)	LTE Band 4			
	Channel Bandwidth: 10 MHz			
	Low Channel		High Channel	
	Frequency (MHz)	Frequency Error (ppm)	Frequency (MHz)	Frequency Error (ppm)
3.85	1715.000003	0.002	1750.000003	0.001
3.27	1715.000002	0.001	1750.000003	0.002
4.43	1715.000002	0.001	1750.000003	0.002

Note: The applicant defined the normal working voltage of the battery is from 3.27 Vdc to 4.43 Vdc.

Frequency Error vs. Temperature

Temp. (°C)	LTE Band 4			
	Channel Bandwidth: 10 MHz			
	Low Channel		High Channel	
	Frequency (MHz)	Frequency Error (ppm)	Frequency (MHz)	Frequency Error (ppm)
-30	1715.000003	0.002	1750.000002	0.001
-20	1715.000002	0.001	1750.000001	0.001
-10	1715.000001	0.001	1750.000004	0.002
0	1715.000004	0.002	1750.000002	0.001
10	1715.000004	0.002	1750.000004	0.002
20	1714.999998	-0.001	1749.999997	-0.002
30	1714.999997	-0.002	1749.999998	-0.001
40	1714.999999	-0.001	1749.999997	-0.002
50	1714.999999	-0.001	1749.999996	-0.002
55	1714.999996	-0.002	1749.999999	-0.001

Frequency Error vs. Voltage

Voltage (Volts)	LTE Band 4			
	Channel Bandwidth: 15 MHz			
	Low Channel		High Channel	
	Frequency (MHz)	Frequency Error (ppm)	Frequency (MHz)	Frequency Error (ppm)
3.85	1717.500003	0.002	1747.500004	0.002
3.27	1717.500004	0.002	1747.500002	0.001
4.43	1717.500002	0.001	1747.500001	0.001

Note: The applicant defined the normal working voltage of the battery is from 3.27 Vdc to 4.43 Vdc.

Frequency Error vs. Temperature

Temp. (°C)	LTE Band 4			
	Channel Bandwidth: 15 MHz			
	Low Channel		High Channel	
	Frequency (MHz)	Frequency Error (ppm)	Frequency (MHz)	Frequency Error (ppm)
-30	1717.500002	0.001	1747.500001	0.001
-20	1717.500001	0.001	1747.500004	0.002
-10	1717.500002	0.001	1747.500003	0.002
0	1717.500003	0.002	1747.500003	0.002
10	1717.500002	0.001	1747.500002	0.001
20	1717.499996	-0.002	1747.499997	-0.002
30	1717.499998	-0.001	1747.499999	-0.001
40	1717.499998	-0.001	1747.499998	-0.001
50	1717.499999	-0.001	1747.499996	-0.002
55	1717.499998	-0.001	1747.499996	-0.002

Frequency Error vs. Voltage

Voltage (Volts)	LTE Band 4			
	Channel Bandwidth: 20 MHz			
	Low Channel		High Channel	
	Frequency (MHz)	Frequency Error (ppm)	Frequency (MHz)	Frequency Error (ppm)
3.85	1720.000002	0.001	1745.000003	0.001
3.27	1720.000004	0.002	1745.000001	0.001
4.43	1720.000004	0.002	1745.000002	0.001

Note: The applicant defined the normal working voltage of the battery is from 3.27 Vdc to 4.43 Vdc.

Frequency Error vs. Temperature

Temp. (°C)	LTE Band 4			
	Channel Bandwidth: 20 MHz			
	Low Channel		High Channel	
	Frequency (MHz)	Frequency Error (ppm)	Frequency (MHz)	Frequency Error (ppm)
-30	1720.000002	0.001	1745.000004	0.002
-20	1720.000003	0.002	1745.000004	0.002
-10	1720.000003	0.002	1745.000003	0.001
0	1720.000003	0.002	1745.000003	0.002
10	1720.000004	0.002	1745.000002	0.001
20	1719.999997	-0.002	1744.999998	-0.001
30	1719.999999	-0.001	1744.999998	-0.001
40	1719.999997	-0.002	1744.999997	-0.002
50	1719.999999	-0.001	1744.999999	-0.001
55	1719.999996	-0.002	1744.999996	-0.002

Frequency Error vs. Voltage

Voltage (Volts)	LTE Band 12			
	Channel Bandwidth: 1.4 MHz			
	Low Channel		High Channel	
	Frequency (MHz)	Frequency Error (ppm)	Frequency (MHz)	Frequency Error (ppm)
3.85	699.700002	0.003	715.300002	0.003
3.27	699.700003	0.004	715.300001	0.001
4.43	699.700003	0.005	715.300002	0.003

Note: The applicant defined the normal working voltage of the battery is from 3.27 Vdc to 4.43 Vdc.

Frequency Error vs. Temperature

Temp. (°C)	LTE Band 12			
	Channel Bandwidth: 1.4 MHz			
	Low Channel		High Channel	
	Frequency (MHz)	Frequency Error (ppm)	Frequency (MHz)	Frequency Error (ppm)
-30	699.700001	0.002	715.300001	0.002
-20	699.700004	0.005	715.300002	0.003
-10	699.700002	0.003	715.300003	0.004
0	699.700001	0.001	715.300004	0.005
10	699.700003	0.004	715.300002	0.003
20	699.699999	-0.001	715.299996	-0.005
30	699.699998	-0.003	715.299998	-0.003
40	699.699999	-0.002	715.299997	-0.004
50	699.699999	-0.001	715.299997	-0.005
55	699.699997	-0.005	715.299999	-0.002

Frequency Error vs. Voltage

Voltage (Volts)	LTE Band 12			
	Channel Bandwidth: 3 MHz			
	Low Channel		High Channel	
	Frequency (MHz)	Frequency Error (ppm)	Frequency (MHz)	Frequency Error (ppm)
3.85	700.500002	0.002	714.500002	0.003
3.27	700.500002	0.003	714.500004	0.005
4.43	700.500004	0.005	714.500004	0.005

Note: The applicant defined the normal working voltage of the battery is from 3.27 Vdc to 4.43 Vdc.

Frequency Error vs. Temperature

Temp. (°C)	LTE Band 12			
	Channel Bandwidth: 3 MHz			
	Low Channel		High Channel	
	Frequency (MHz)	Frequency Error (ppm)	Frequency (MHz)	Frequency Error (ppm)
-30	700.500001	0.002	714.500004	0.005
-20	700.500004	0.005	714.500003	0.004
-10	700.500002	0.002	714.500002	0.003
0	700.500003	0.005	714.500003	0.004
10	700.500002	0.003	714.500003	0.004
20	700.499998	-0.003	714.499997	-0.005
30	700.499997	-0.005	714.499999	-0.002
40	700.499997	-0.005	714.499997	-0.004
50	700.499999	-0.001	714.499997	-0.005
55	700.499996	-0.005	714.499999	-0.002

Frequency Error vs. Voltage

Voltage (Volts)	LTE Band 12			
	Channel Bandwidth: 5 MHz			
	Low Channel		High Channel	
	Frequency (MHz)	Frequency Error (ppm)	Frequency (MHz)	Frequency Error (ppm)
3.85	701.500002	0.002	713.500003	0.004
3.27	701.500003	0.004	713.500004	0.005
4.43	701.500003	0.004	713.500001	0.002

Note: The applicant defined the normal working voltage of the battery is from 3.27 Vdc to 4.43 Vdc.

Frequency Error vs. Temperature

Temp. (°C)	LTE Band 12			
	Channel Bandwidth: 5 MHz			
	Low Channel		High Channel	
	Frequency (MHz)	Frequency Error (ppm)	Frequency (MHz)	Frequency Error (ppm)
-30	701.500001	0.001	713.500002	0.003
-20	701.500002	0.002	713.500002	0.003
-10	701.500001	0.002	713.500004	0.005
0	701.500003	0.004	713.500001	0.002
10	701.500001	0.002	713.500004	0.006
20	701.499998	-0.003	713.499998	-0.003
30	701.499999	-0.002	713.499998	-0.003
40	701.499999	-0.002	713.499998	-0.003
50	701.499996	-0.006	713.499997	-0.004
55	701.499999	-0.002	713.499997	-0.004

Frequency Error vs. Voltage

Voltage (Volts)	LTE Band 12			
	Channel Bandwidth: 10 MHz			
	Low Channel		High Channel	
	Frequency (MHz)	Frequency Error (ppm)	Frequency (MHz)	Frequency Error (ppm)
3.85	704.000002	0.002	711.000003	0.004
3.27	704.000003	0.004	711.000003	0.004
4.43	704.000004	0.005	711.000002	0.003

Note: The applicant defined the normal working voltage of the battery is from 3.27 Vdc to 4.43 Vdc.

Frequency Error vs. Temperature

Temp. (°C)	LTE Band 12			
	Channel Bandwidth: 10 MHz			
	Low Channel		High Channel	
	Frequency (MHz)	Frequency Error (ppm)	Frequency (MHz)	Frequency Error (ppm)
-30	704.000002	0.003	711.000003	0.004
-20	704.000002	0.003	711.000002	0.003
-10	704.000004	0.005	711.000002	0.003
0	704.000002	0.003	711.000002	0.003
10	704.000002	0.003	711.000001	0.002
20	703.999999	-0.002	710.999996	-0.005
30	703.999997	-0.004	710.999999	-0.002
40	703.999996	-0.006	710.999999	-0.002
50	703.999996	-0.005	710.999998	-0.003
55	703.999999	-0.002	710.999998	-0.003

Frequency Error vs. Voltage

Voltage (Volts)	LTE Band 13			
	Channel Bandwidth: 5 MHz			
	Low Channel		High Channel	
	Frequency (MHz)	Frequency Error (ppm)	Frequency (MHz)	Frequency Error (ppm)
3.85	779.500003	0.003	784.500002	0.002
3.27	779.500003	0.004	784.500002	0.002
4.43	779.500003	0.004	784.500003	0.004

Note: The applicant defined the normal working voltage of the battery is from 3.27 Vdc to 4.43 Vdc.

Frequency Error vs. Temperature

Temp. (°C)	LTE Band 13			
	Channel Bandwidth: 5 MHz			
	Low Channel		High Channel	
	Frequency (MHz)	Frequency Error (ppm)	Frequency (MHz)	Frequency Error (ppm)
-30	779.500003	0.004	784.500003	0.004
-20	779.500003	0.004	784.500001	0.001
-10	779.500003	0.004	784.500001	0.002
0	779.500003	0.003	784.500001	0.002
10	779.500002	0.003	784.500003	0.004
20	779.499999	-0.001	784.499998	-0.003
30	779.499998	-0.002	784.499996	-0.005
40	779.499998	-0.002	784.499996	-0.005
50	779.499998	-0.002	784.499997	-0.004
55	779.499999	-0.001	784.499997	-0.004

Frequency Error vs. Voltage

Voltage (Volts)	LTE Band 13	
	Channel Bandwidth: 10 MHz	
	Frequency (MHz)	Frequency Error (ppm)
3.85	782.000002	0.003
3.27	782.000003	0.003
4.43	782.000002	0.002

Note: The applicant defined the normal working voltage of the battery is from 3.27 Vdc to 4.43 Vdc.

Frequency Error vs. Temperature

Temp. (°C)	LTE Band 13	
	Channel Bandwidth: 10 MHz	
	Frequency (MHz)	Frequency Error (ppm)
-30	782.000003	0.004
-20	782.000003	0.003
-10	782.000003	0.004
0	782.000002	0.003
10	782.000003	0.004
20	781.999998	-0.002
30	781.999997	-0.004
40	781.999998	-0.003
50	781.999996	-0.005
55	781.999996	-0.005

4.4 Occupied Bandwidth Measurement

4.4.1 Limits of Occupied Bandwidth Measurement

The width of a frequency band such that, below the lower and above the upper frequency limits, the mean powers emitted are each equal to a specified percentage 0.5 % of the total mean power of a given emission.

4.4.2 Test Procedure

- The conducted occupied bandwidth used the power splitter via EUT RF power connector between simulation base station and spectrum analyzer.
- Use OBW measurement function of Spectrum analyzer to measure 99 % occupied bandwidth.

4.4.3 Test Setup

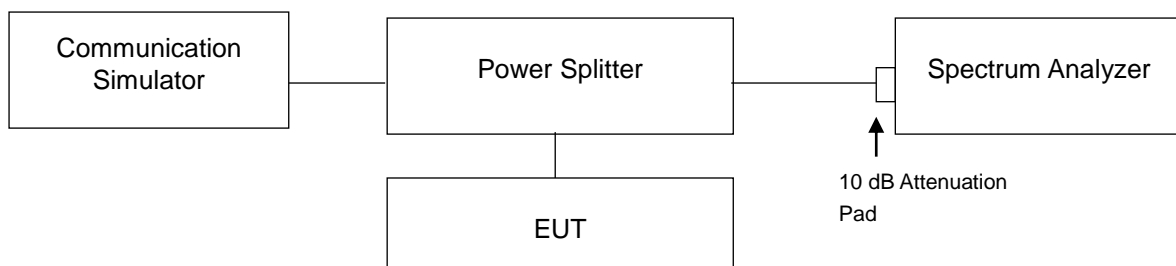

4.4.4 Test Result

WCDMA			
Channel	Frequency (MHz)	99 % Occupied Bandwidth (MHz)	26 dB Bandwidth (MHz)
1312	1712.4	4.1737	4.764
1413	1732.6	4.1703	4.750
1513	1752.6	4.1869	4.769

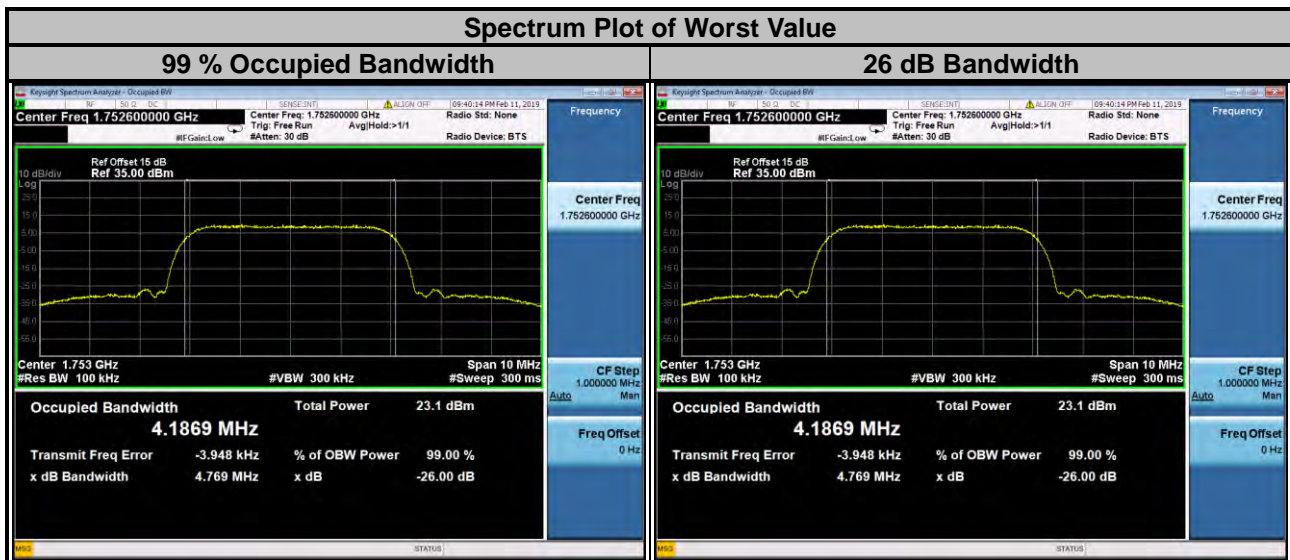

LTE Band 4					
Channel Bandwidth: 1.4 MHz					
Channel	Frequency (MHz)	99 % Occupied Bandwidth (MHz)		26 dB Bandwidth (MHz)	
		QPSK	16QAM	QPSK	16QAM
19957	1710.7	1.0883	1.0901	1.255	1.264
20175	1732.5	1.0879	1.0878	1.251	1.249
20393	1754.3	1.0888	1.0927	1.265	1.244

Channel Bandwidth: 3 MHz					
Channel	Frequency (MHz)	99 % Occupied Bandwidth (MHz)		26 dB Bandwidth (MHz)	
		QPSK	16QAM	QPSK	16QAM
19965	1711.5	2.7020	2.6978	2.925	2.926
20175	1732.5	2.7010	2.6985	2.910	2.922
20385	1753.5	2.7016	2.6998	2.931	2.937

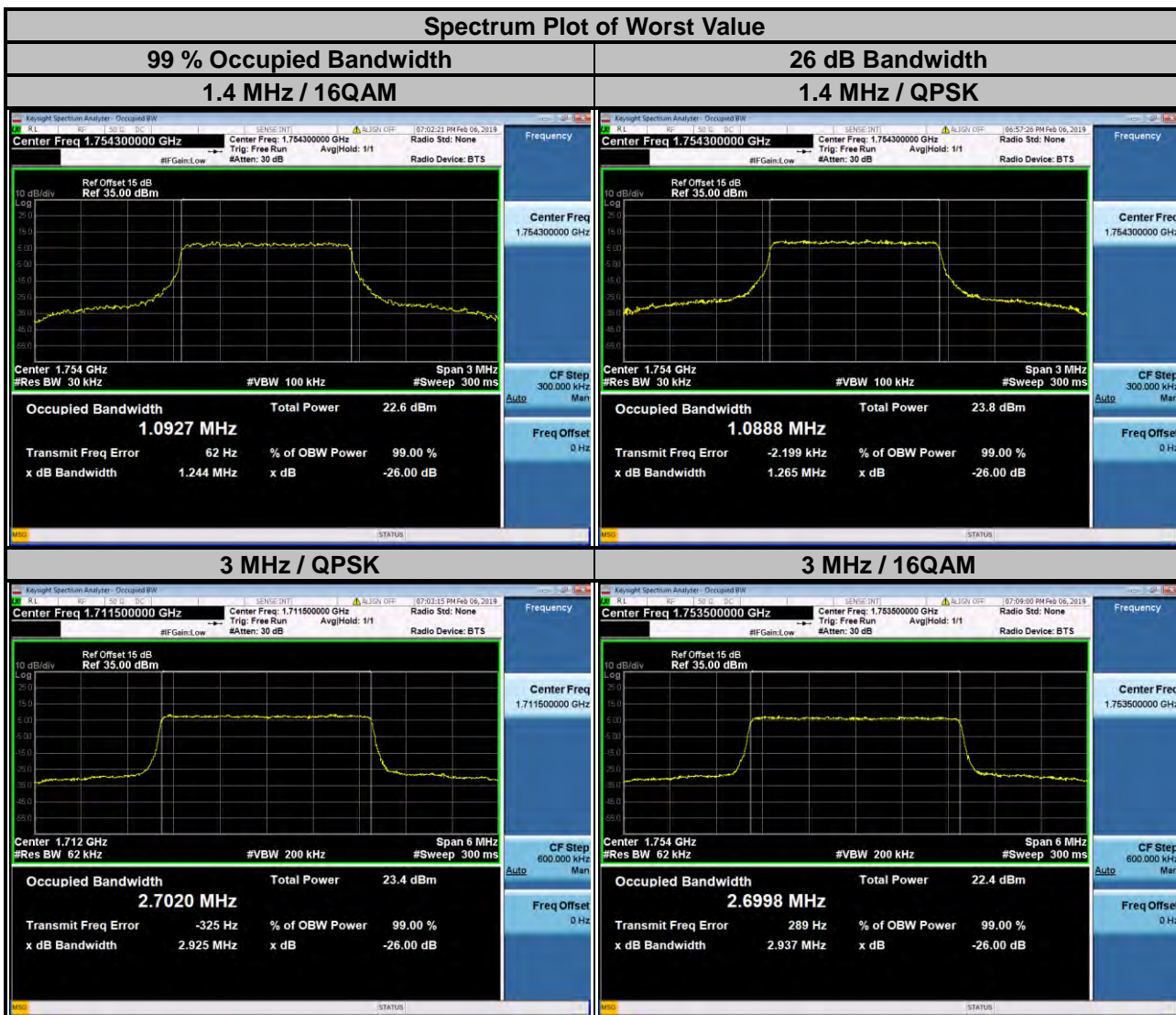

LTE Band 4					
Channel Bandwidth: 5 MHz					
Channel	Frequency (MHz)	99 % Occupied Bandwidth (MHz)		26 dB Bandwidth (MHz)	
		QPSK	16QAM	QPSK	16QAM
19975	1712.5	4.4934	4.4973	4.845	4.842
20175	1732.5	4.4906	4.4946	4.821	4.812
20375	1752.5	4.4979	4.4948	4.835	4.824

Channel Bandwidth: 10 MHz					
Channel	Frequency (MHz)	99 % Occupied Bandwidth (MHz)		26 dB Bandwidth (MHz)	
		QPSK	16QAM	QPSK	16QAM
20000	1715.0	8.9642	8.9652	9.512	9.519
20175	1732.5	8.9678	8.9691	9.510	9.522
20350	1750.0	8.9690	8.9676	9.530	9.535



LTE Band 4

Channel Bandwidth: 15 MHz

Channel	Frequency (MHz)	99 % Occupied Bandwidth (MHz)		26 dB Bandwidth (MHz)	
		QPSK	16QAM	QPSK	16QAM
20025	1717.5	13.486	13.466	14.27	14.27
20175	1732.5	13.468	13.458	14.25	14.24
20325	1747.5	13.467	13.451	14.29	14.26

Channel Bandwidth: 20 MHz

Channel	Frequency (MHz)	99 % Occupied Bandwidth (MHz)		26 dB Bandwidth (MHz)	
		QPSK	16QAM	QPSK	16QAM
20050	1720.0	17.959	17.982	19.04	19.05
20175	1732.5	17.929	17.952	19.01	19.04
20300	1745.0	17.919	17.936	19.03	19.04

Spectrum Plot of Worst Value

99 % Occupied Bandwidth 15 MHz / QPSK

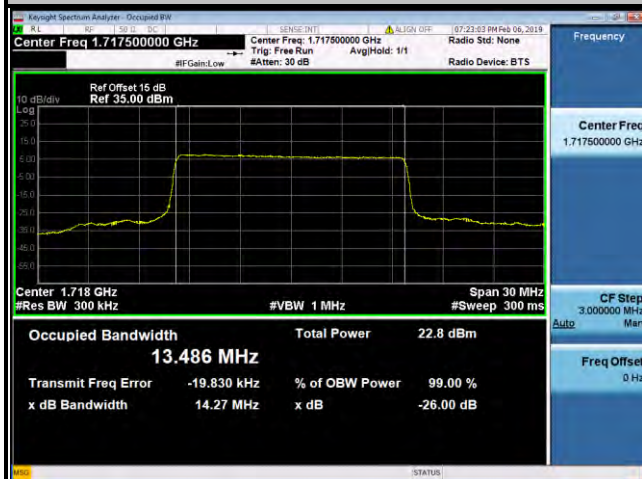

26 dB Bandwidth 15 MHz / QPSK

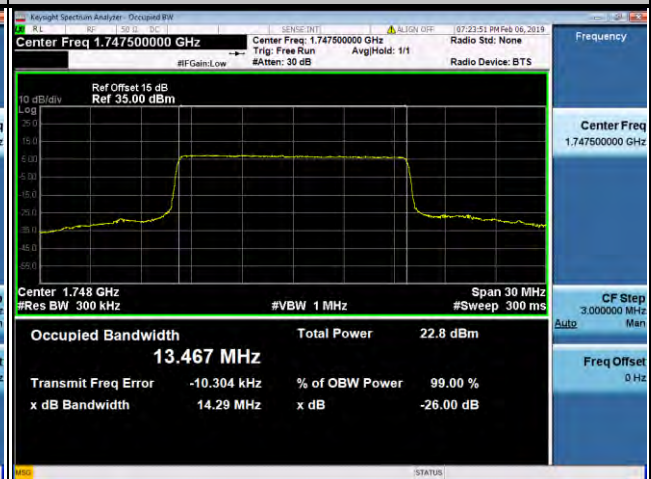

20 MHz / 16QAM

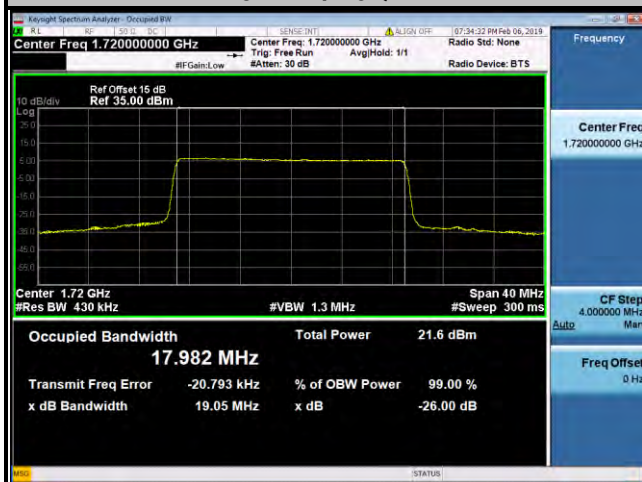

20 MHz / 16QAM

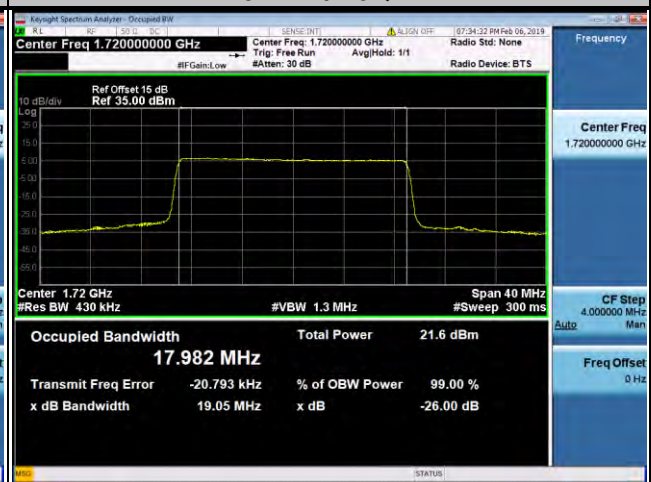

LTE Band 12					
Channel Bandwidth: 1.4 MHz					
Channel	Frequency (MHz)	99 % Occupied Bandwidth (MHz)		26 dB Bandwidth (MHz)	
		QPSK	16QAM	QPSK	16QAM
23017	699.7	1.0881	1.0882	1.243	1.258
23095	707.5	1.0879	1.0899	1.246	1.245
23173	715.3	1.0890	1.0933	1.243	1.247

Channel Bandwidth: 3 MHz					
Channel	Frequency (MHz)	99 % Occupied Bandwidth (MHz)		26 dB Bandwidth (MHz)	
		QPSK	16QAM	QPSK	16QAM
23025	700.5	2.7021	2.6984	2.908	2.918
23095	707.5	2.7030	2.6991	2.918	2.923
23165	714.5	2.7061	2.7011	2.920	2.927



LTE Band 12					
Channel Bandwidth: 5 MHz					
Channel	Frequency (MHz)	99 % Occupied Bandwidth (MHz)		26 dB Bandwidth (MHz)	
		QPSK	16QAM	QPSK	16QAM
23035	701.5	4.4940	4.4971	4.819	4.826
23095	707.5	4.4966	4.4971	4.839	4.819
23155	713.5	4.4988	4.4983	4.822	4.821
Channel Bandwidth: 10 MHz					
Channel	Frequency (MHz)	99 % Occupied Bandwidth (MHz)		26 dB Bandwidth (MHz)	
		QPSK	16QAM	QPSK	16QAM
23060	704.0	8.9829	8.9842	9.522	9.526
23095	707.5	8.9717	8.9720	9.513	9.529
23130	711.0	8.9509	8.9523	9.502	9.502



LTE Band 13					
Channel Bandwidth: 5 MHz					
Channel	Frequency (MHz)	99 % Occupied Bandwidth (MHz)		26 dB Bandwidth (MHz)	
		QPSK	16QAM	QPSK	16QAM
23205	779.5	4.4869	4.4879	4.816	4.819
23230	782.0	4.4953	4.4945	4.837	4.827
23255	784.5	4.4955	4.4971	4.822	4.837

Channel Bandwidth: 10 MHz					
Channel	Frequency (MHz)	99 % Occupied Bandwidth (MHz)		26 dB Bandwidth (MHz)	
		QPSK	16QAM	QPSK	16QAM
23230	782.0	8.9474	8.9523	9.517	9.520

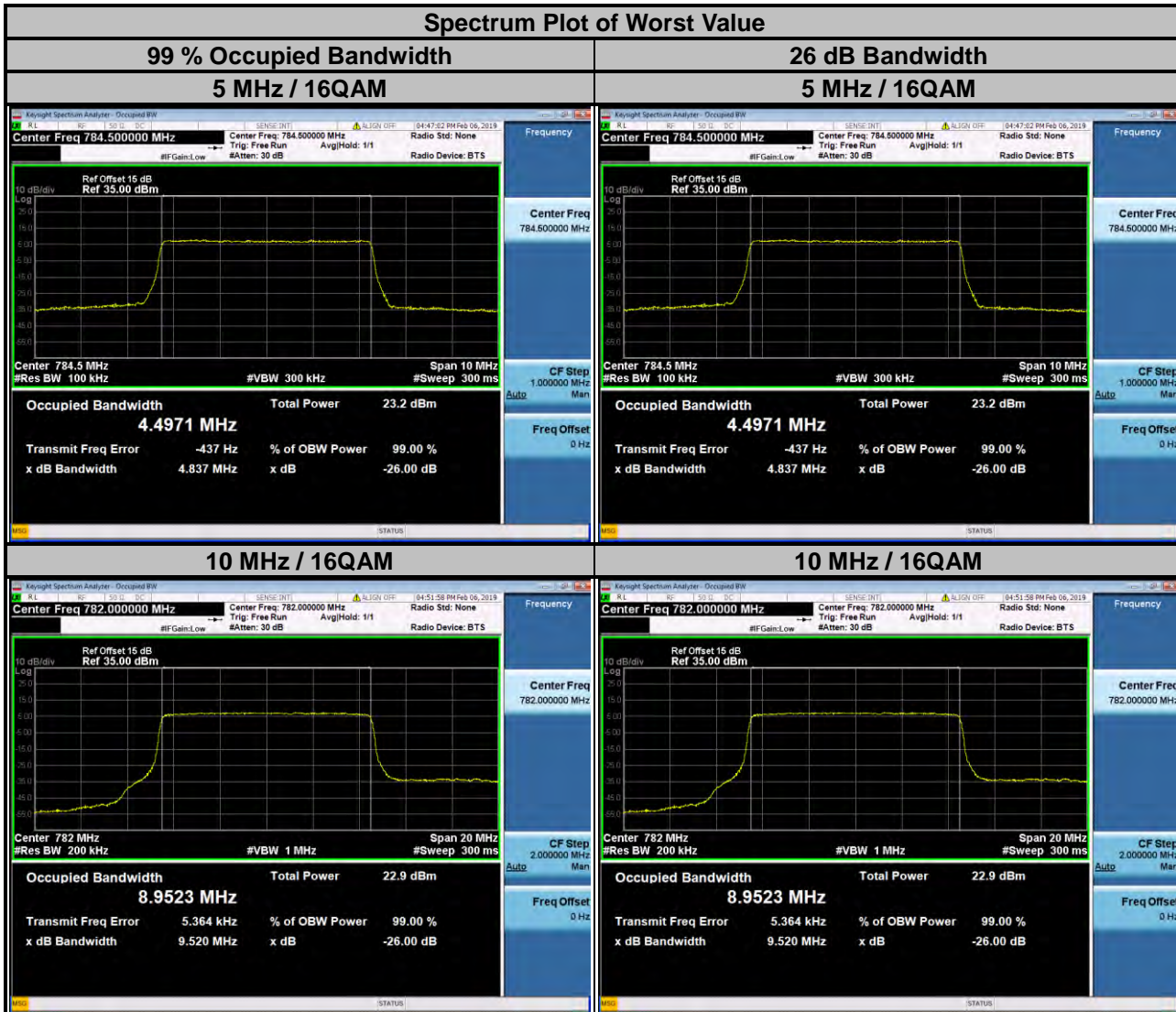

4.5 Band Edge Measurement

4.5.1 Limits of Band Edge Measurement

For operations in the 698-787 MHz band, the power of any emission outside a licensee's frequency band(s) of operation shall be attenuated below the transmitter power (P) within the licensed band(s) of operation, measured in watts, by at least $43 + 10 \log (P)$ dB. Compliance with this provision is based on the use of measurement instrumentation employing a resolution bandwidth of 100 kilohertz or greater.

However, in the 100 kilohertz bands immediately outside and adjacent to a licensee's frequency block, a resolution bandwidth of at least 30 kHz may be employed.

For operations in the 746-758 MHz band and the 776-788 MHz band, the power of any emission outside a licensee's frequency band(s) of operation shall be attenuated below the transmitter power (P) within the licensed band(s) of operation, measured in watts, by at least $43 + 10 \log (P)$ dB.

On all frequencies between 763-775 MHz and 793-805 MHz, by a factor no less than $65 + 10 \log (P)$ dB in a 6.25 kHz band segment, for mobile and portable stations.

For operations in the 1710–1755 MHz bands, the power of any emission outside a licensee's frequency block shall be attenuated below the transmitter power (P) by at least $43 + 10 \log (P)$ dB.

4.5.2 Test Setup

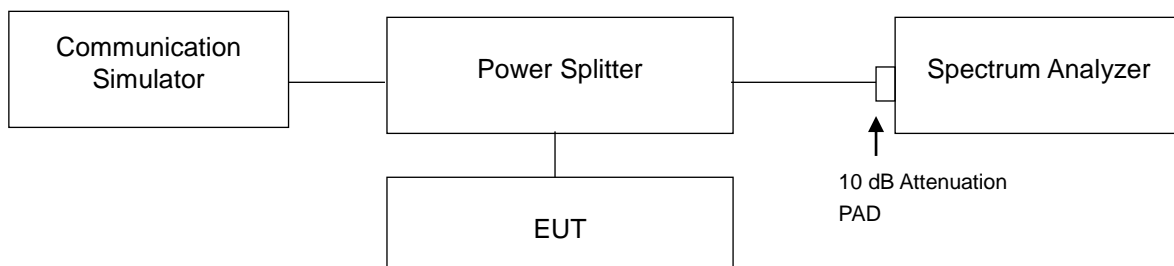

4.5.3 Test Procedures

- All measurements were done at low and high operational frequency range.
- The center frequency of spectrum is the band edge frequency and span is 5 MHz. RB of the spectrum is 100 kHz and VB of the spectrum is 300 kHz (WCDMA).
- The center frequency of spectrum is the band edge frequency and span is 1 MHz. RB of the spectrum is 15 kHz and VB of the spectrum is 51 kHz (LTE Bandwidth 1.4 MHz).
- The center frequency of spectrum is the band edge frequency and span is 1 MHz. RB of the spectrum is 30 kHz and VB of the spectrum is 100 kHz (LTE Bandwidth 3 MHz).
- The center frequency of spectrum is the band edge frequency and span is 1 MHz. RB of the spectrum is 62 kHz and VB of the spectrum is 200 kHz (LTE Bandwidth 5 MHz).
- The center frequency of spectrum is the band edge frequency and span is 1 MHz. RB of the spectrum is 100 kHz and VB of the spectrum is 300 kHz (LTE Bandwidth 10 MHz).
- The center frequency of spectrum is the band edge frequency and span is 1 MHz. RB of the spectrum is 150 kHz and VB of the spectrum is 470 kHz (LTE Bandwidth 15 MHz).
- The center frequency of spectrum is the band edge frequency and span is 1 MHz. RB of the spectrum is 200 kHz and VB of the spectrum is 1 MHz (LTE Bandwidth 20 MHz).
- Record the max. trace plot into the test report.

4.5.4 Test Results

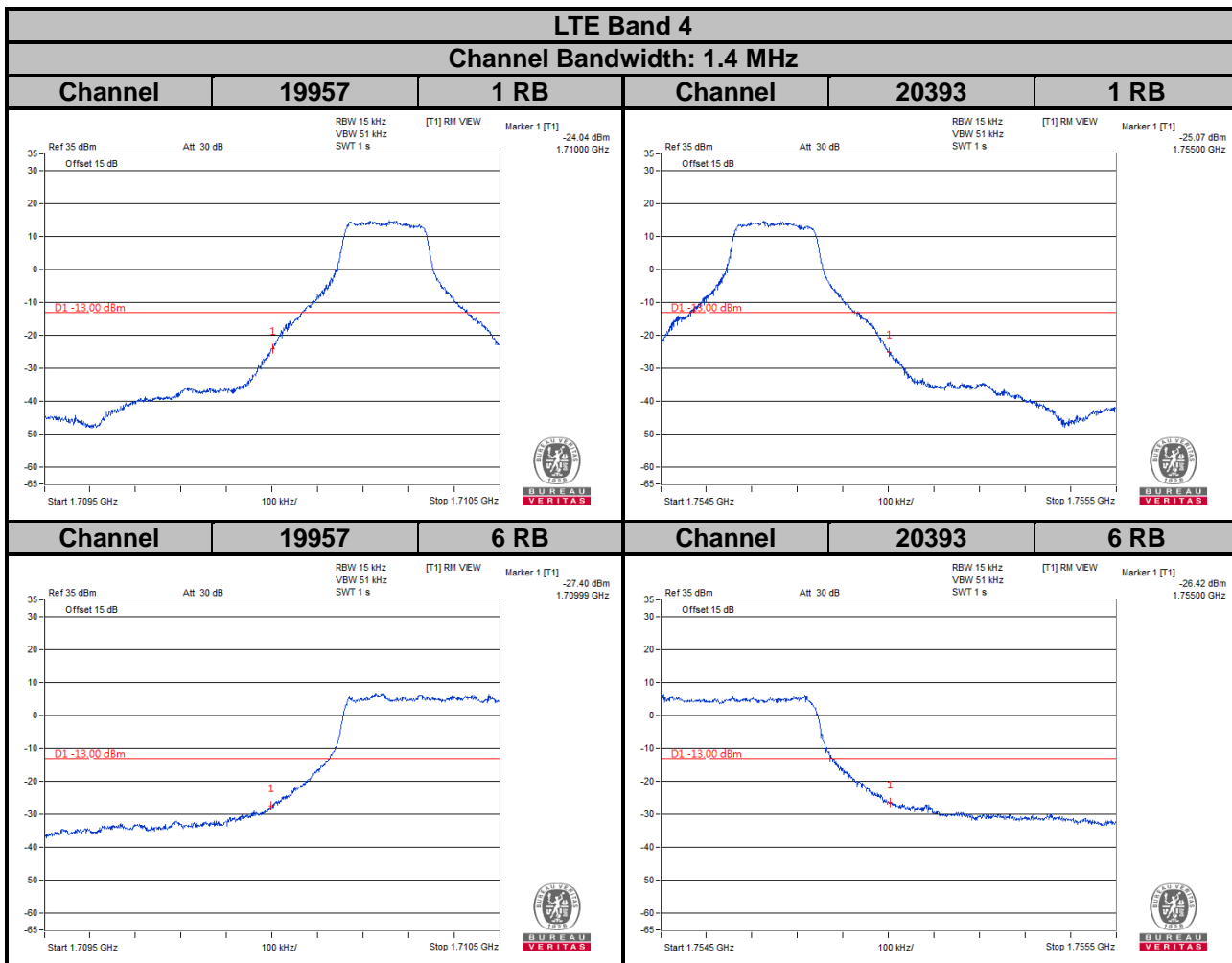
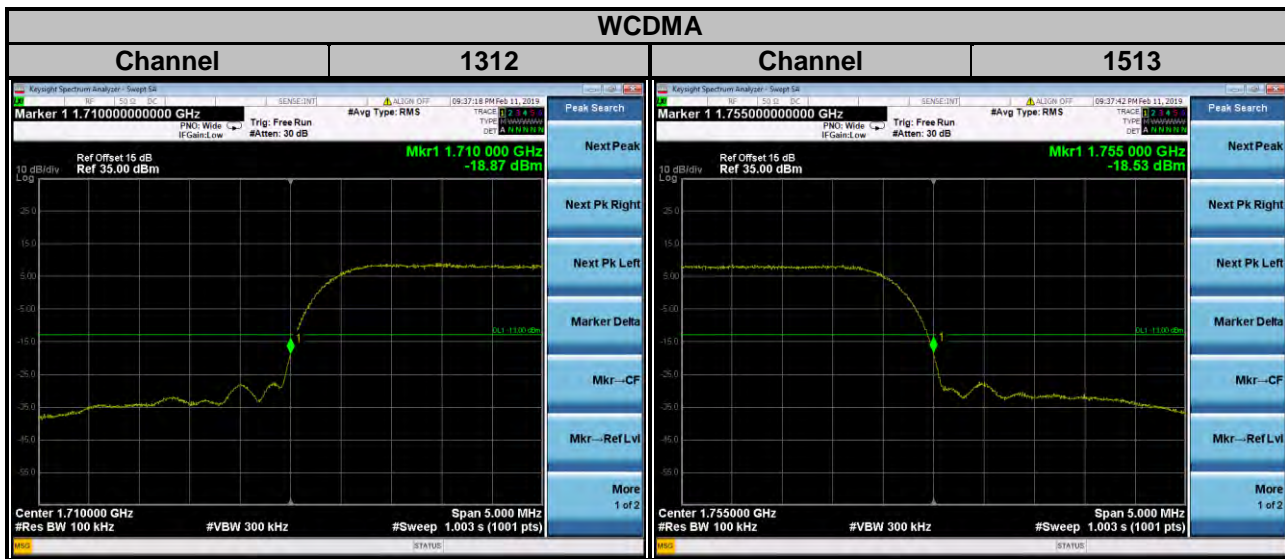

LTE Band 4

Channel Bandwidth: 3 MHz

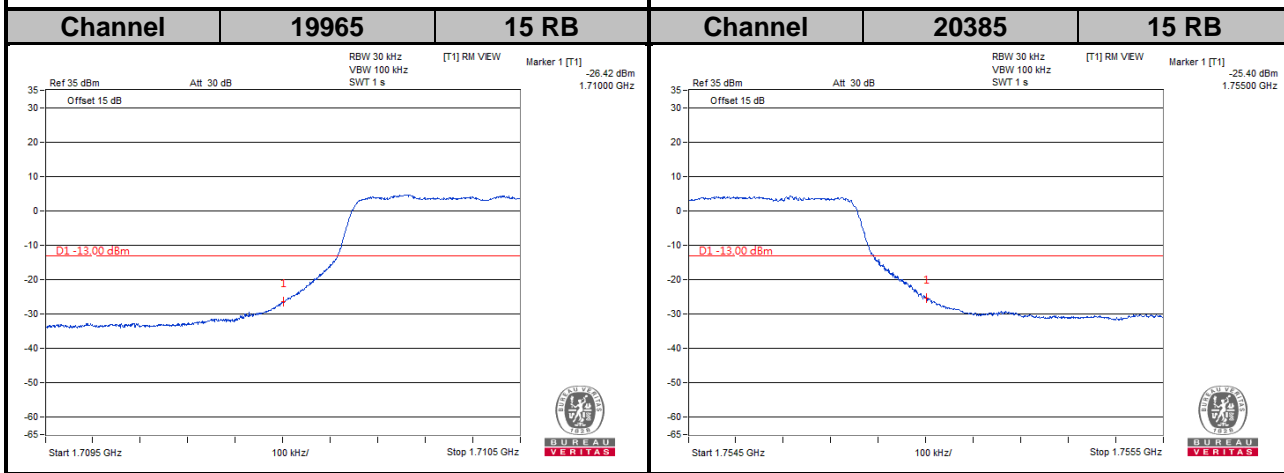
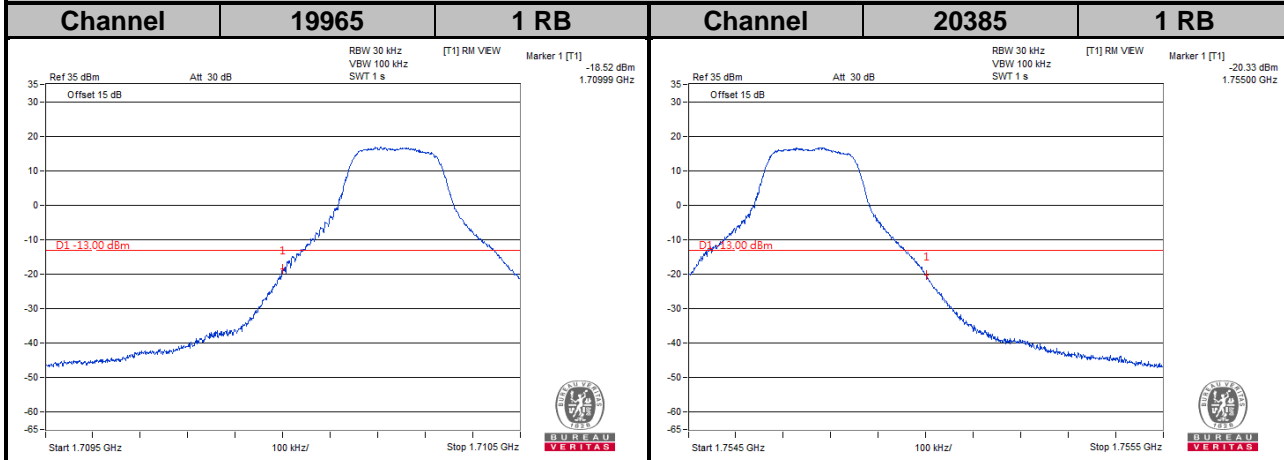

LTE Band 4
Channel Bandwidth: 5 MHz

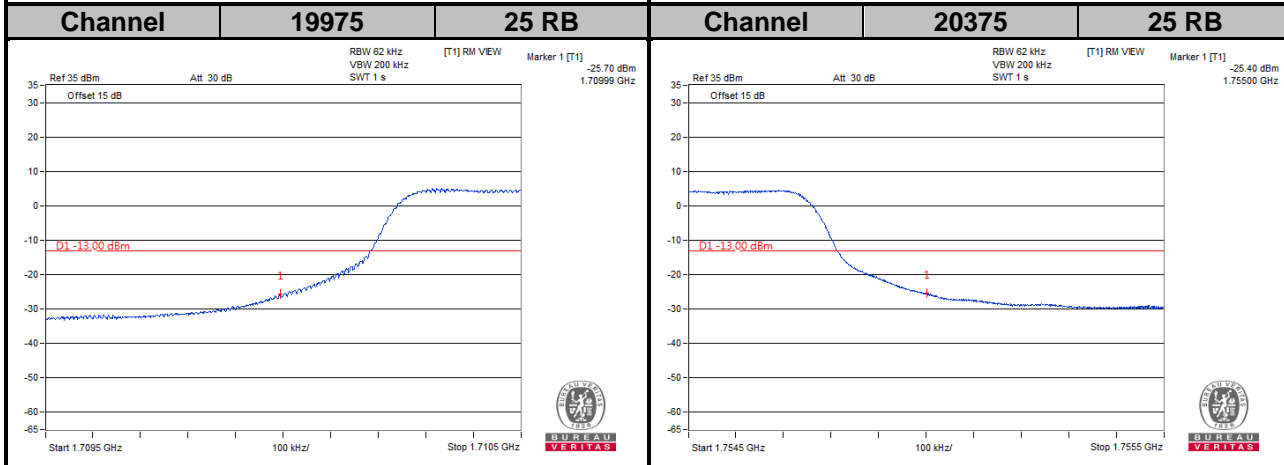
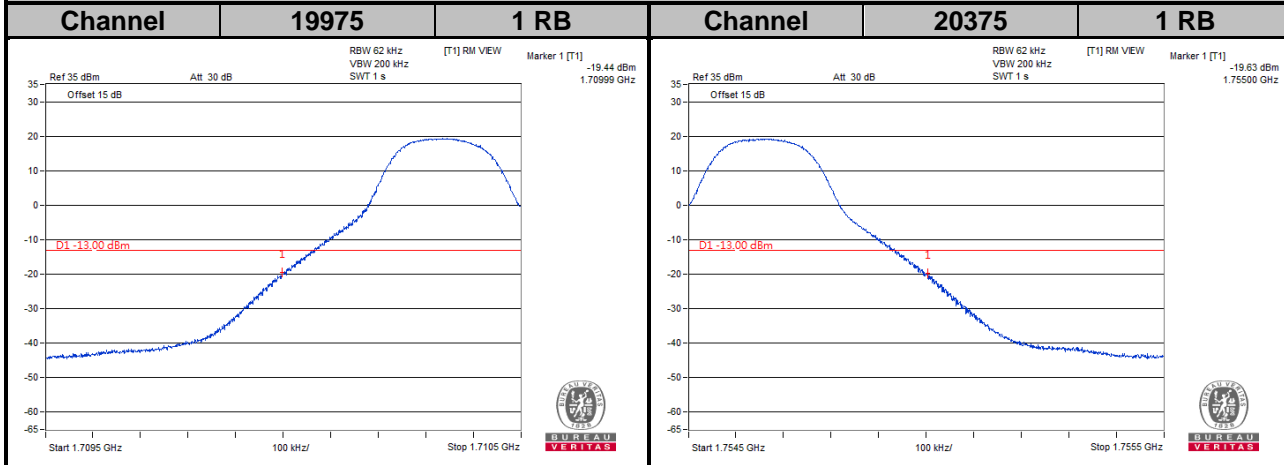

LTE Band 4

Channel Bandwidth: 10 MHz

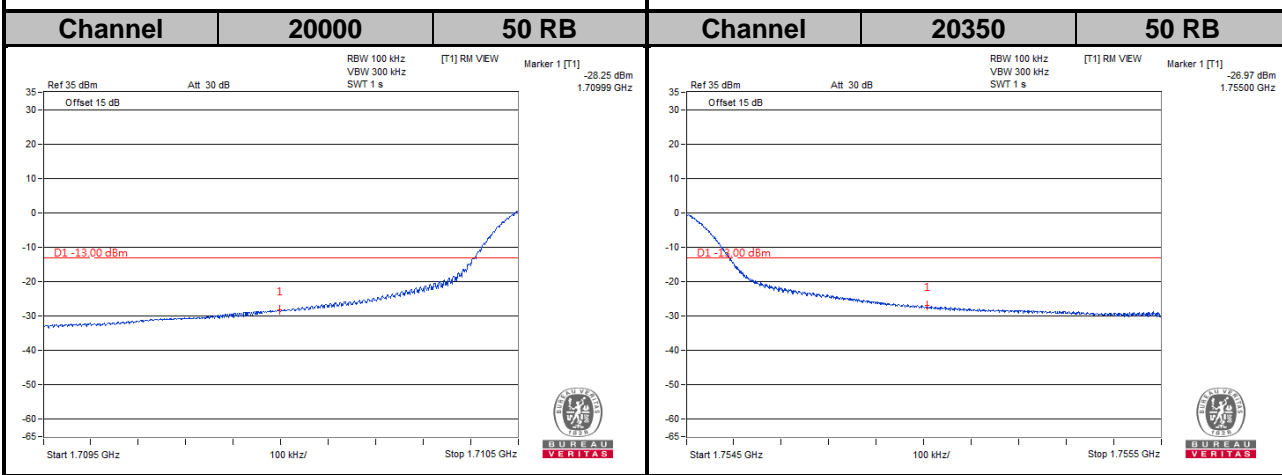
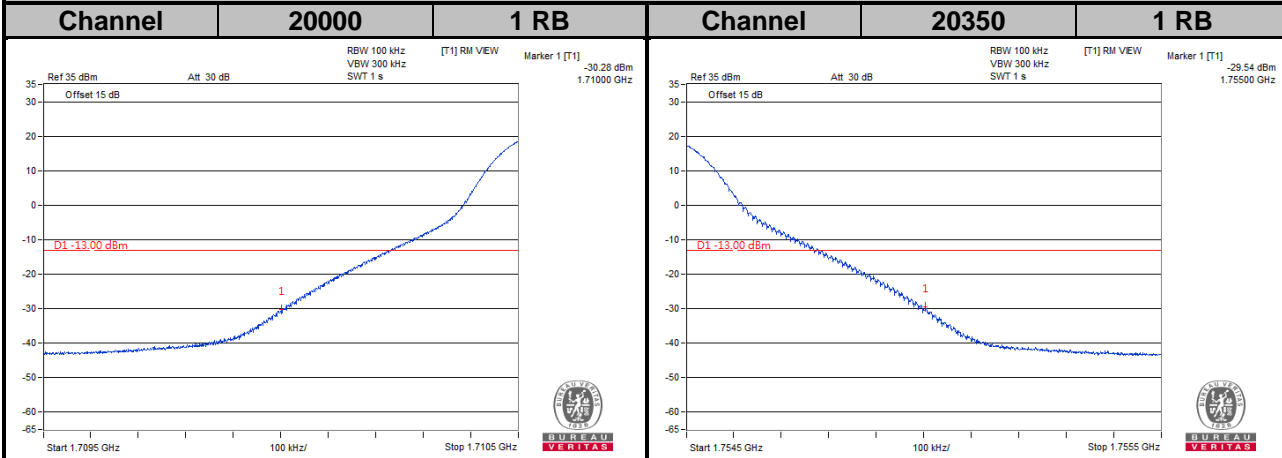

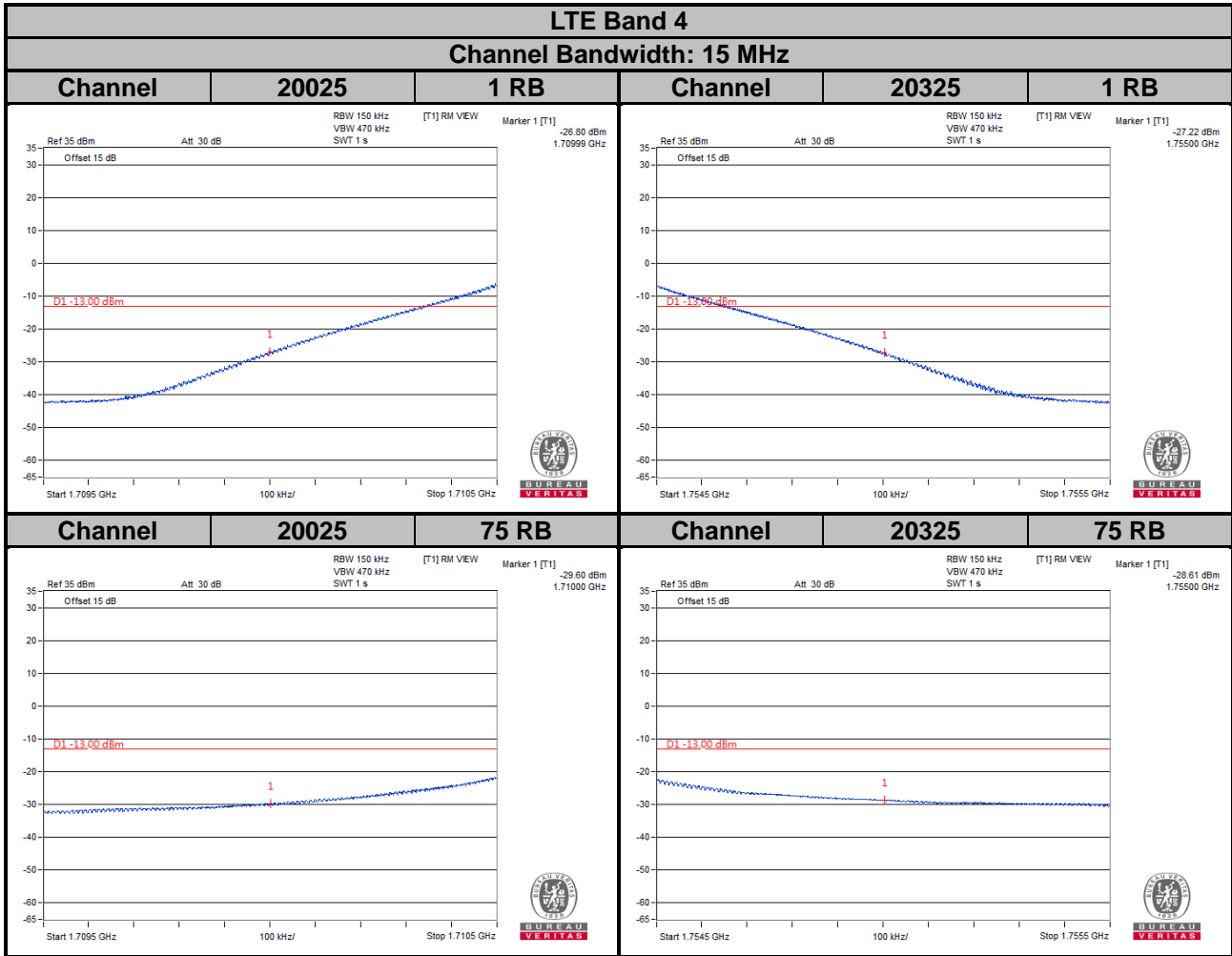

LTE Band 4

Channel Bandwidth: 20 MHz

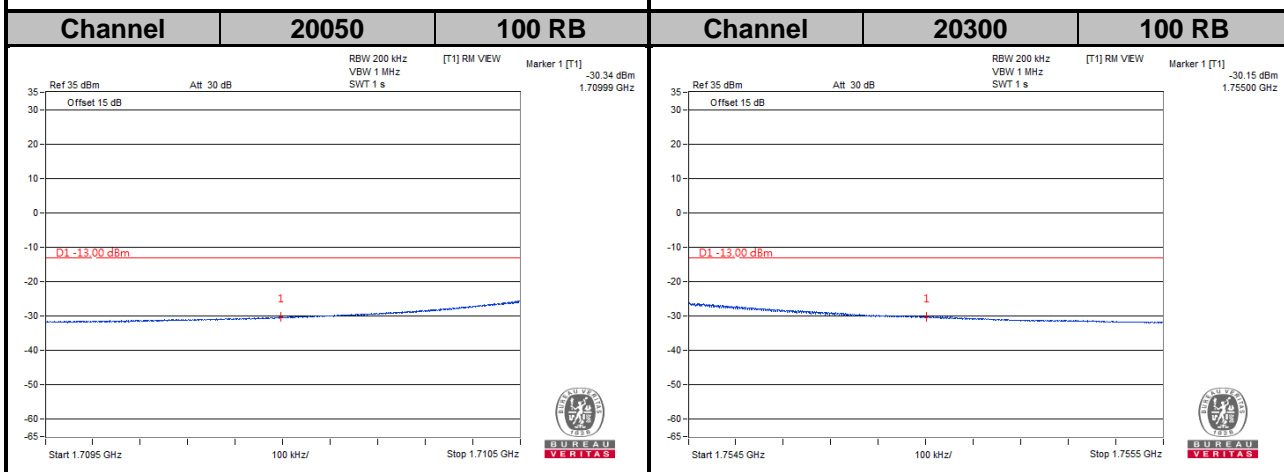
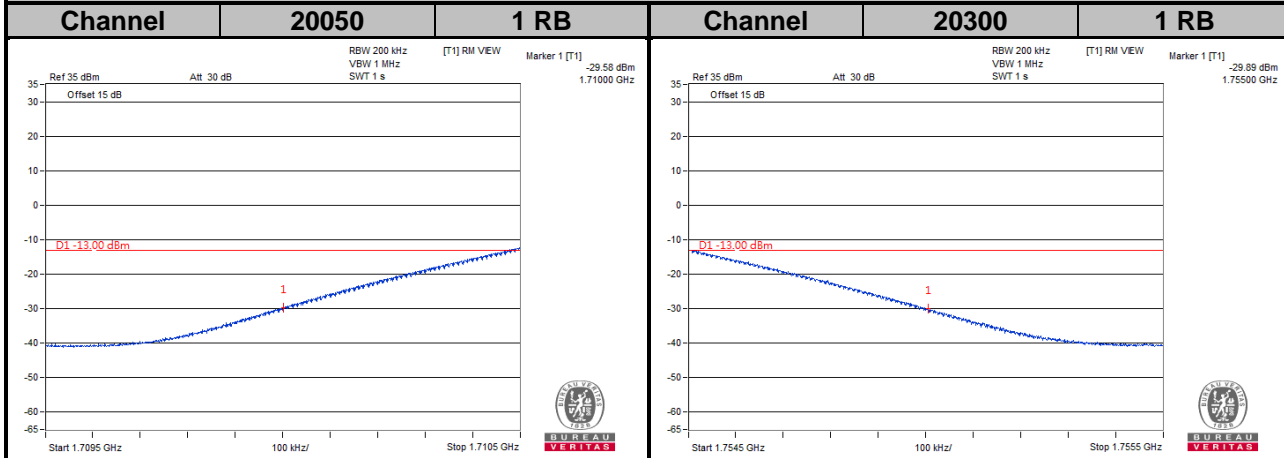

LTE Band 12
Channel Bandwidth: 1.4 MHz

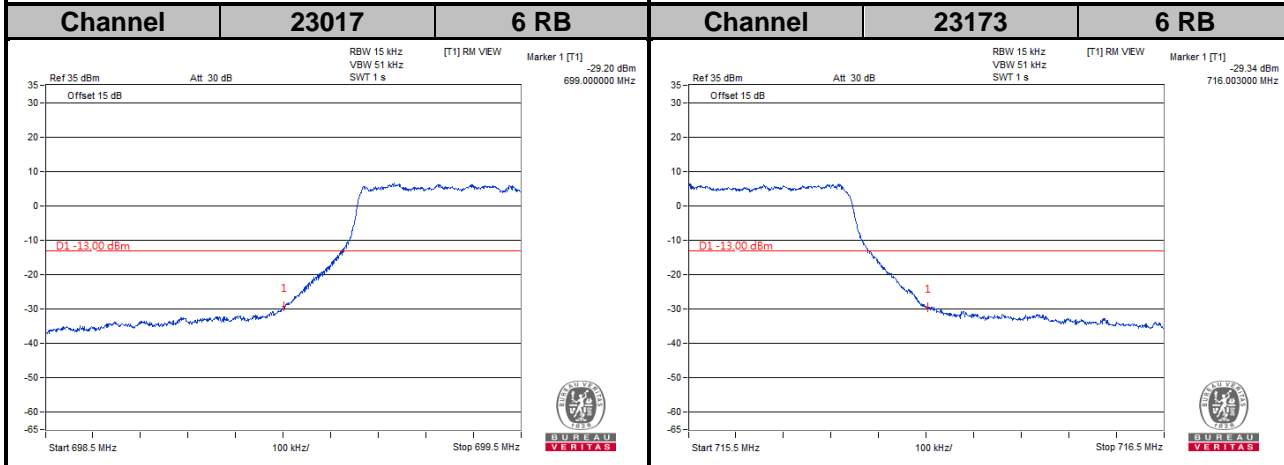
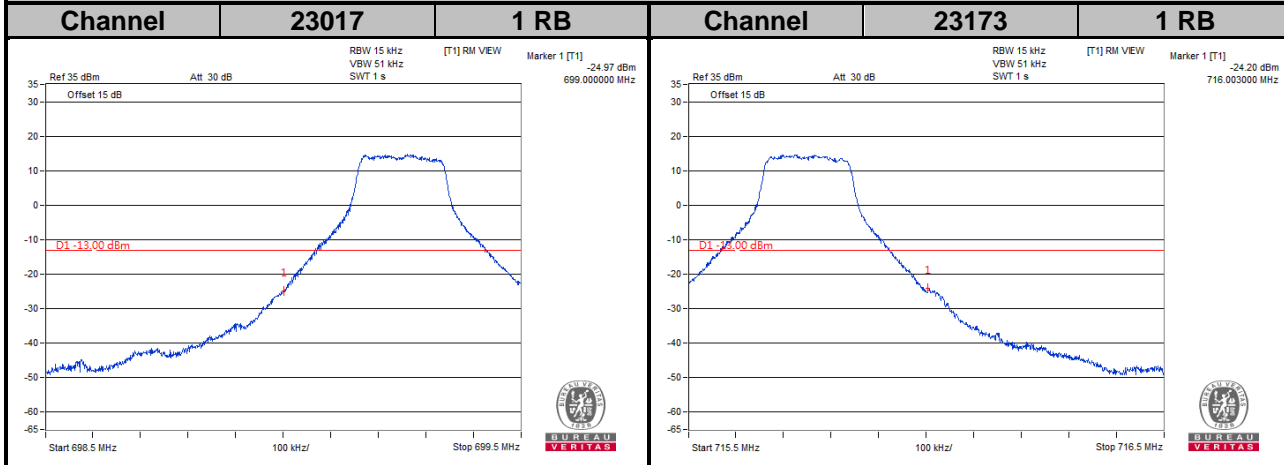

LTE Band 12
Channel Bandwidth: 3 MHz

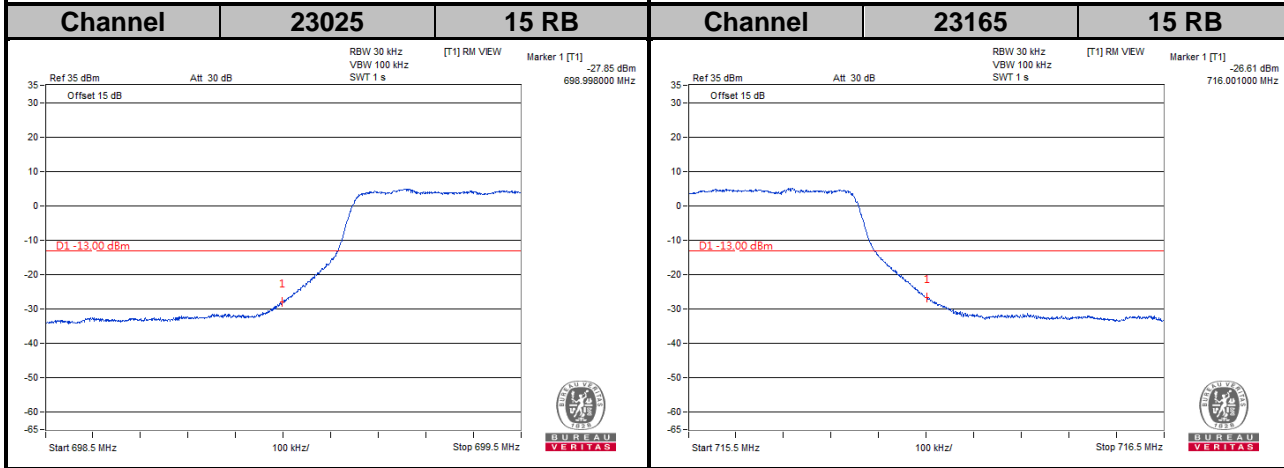
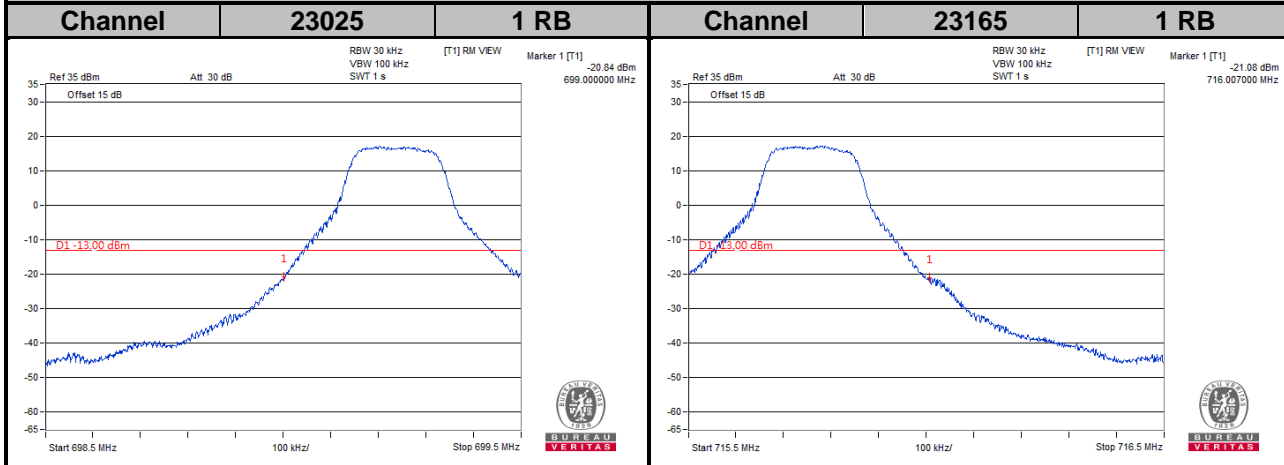

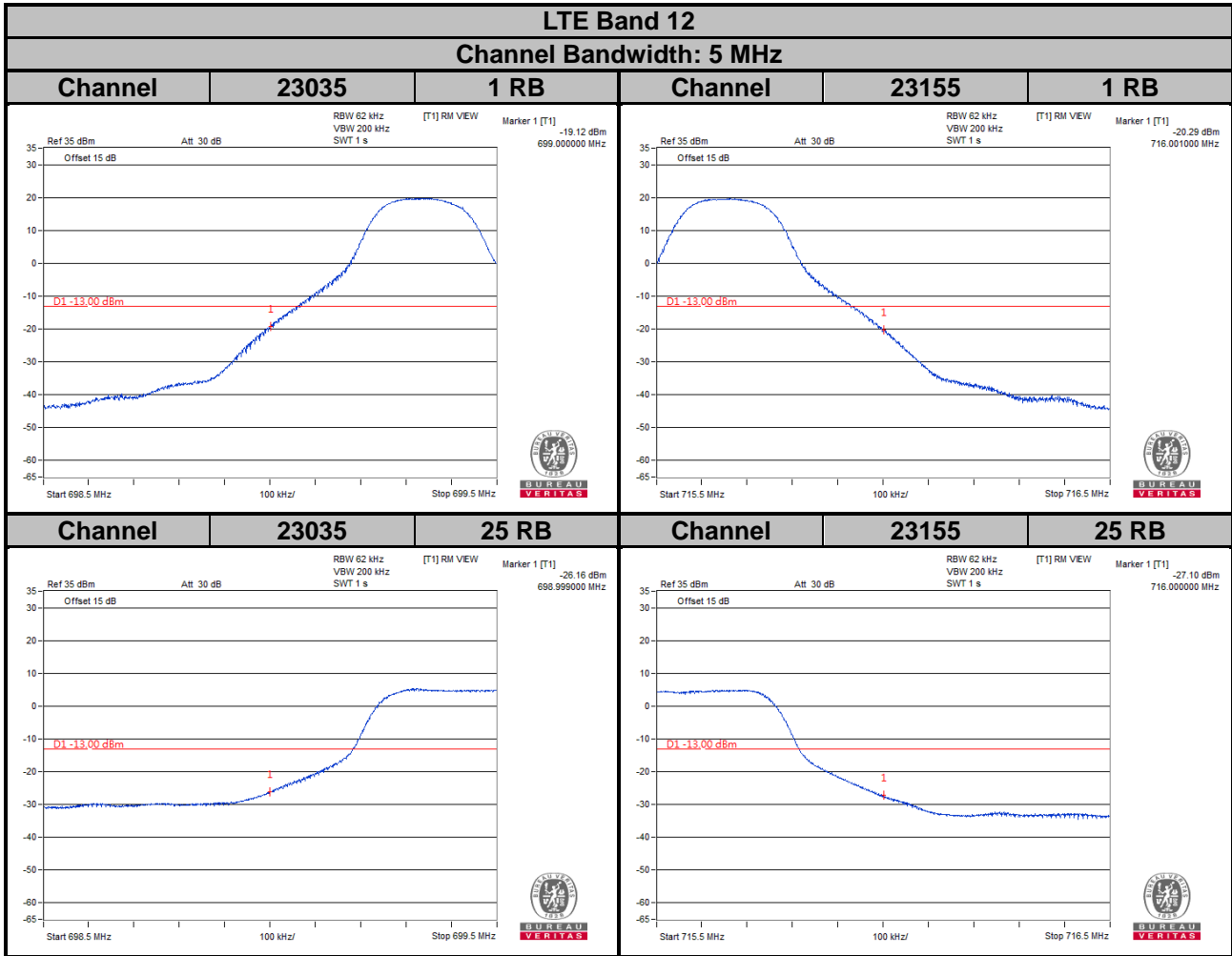

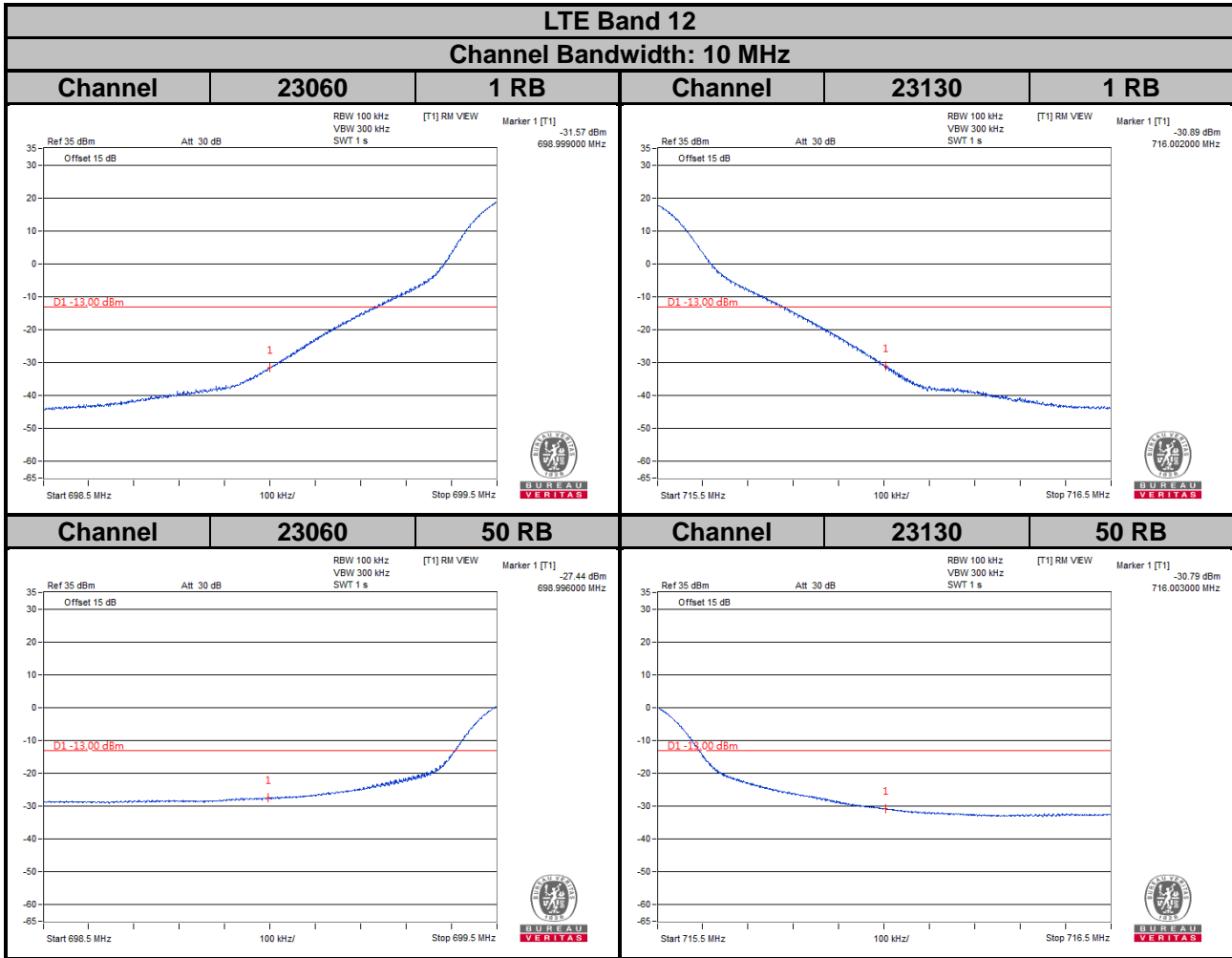

LTE Band 13

Channel Bandwidth: 5 MHz

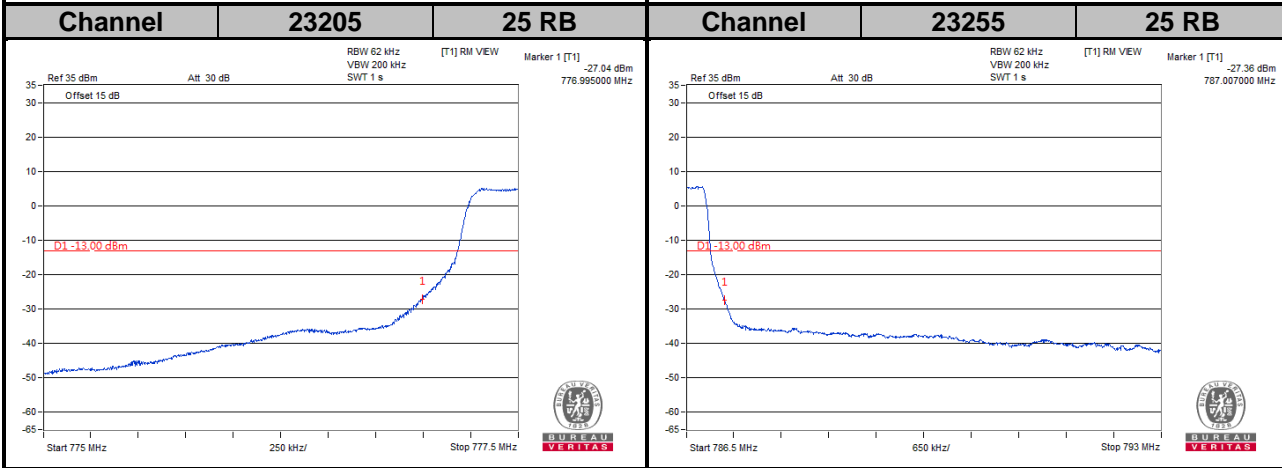
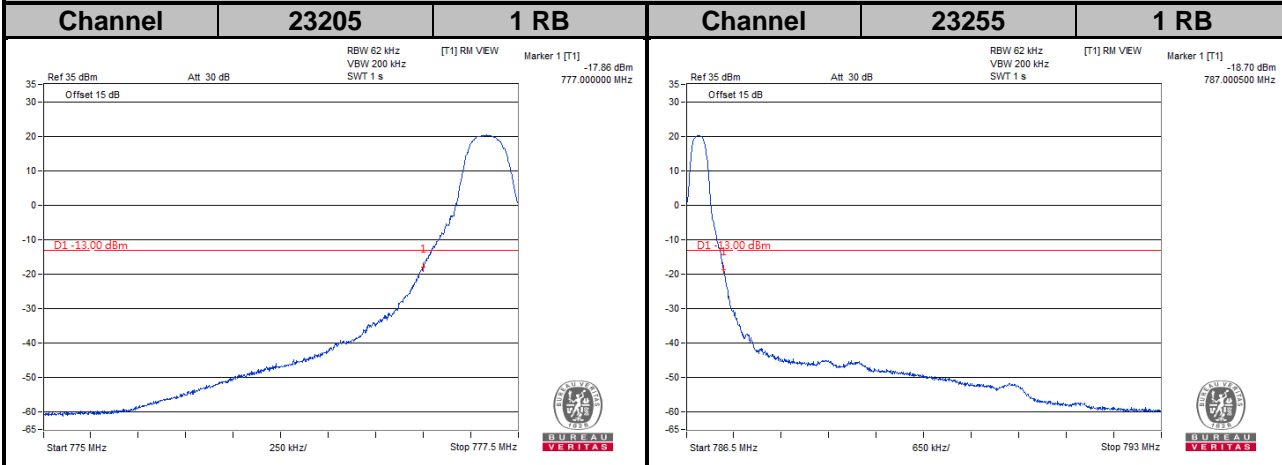

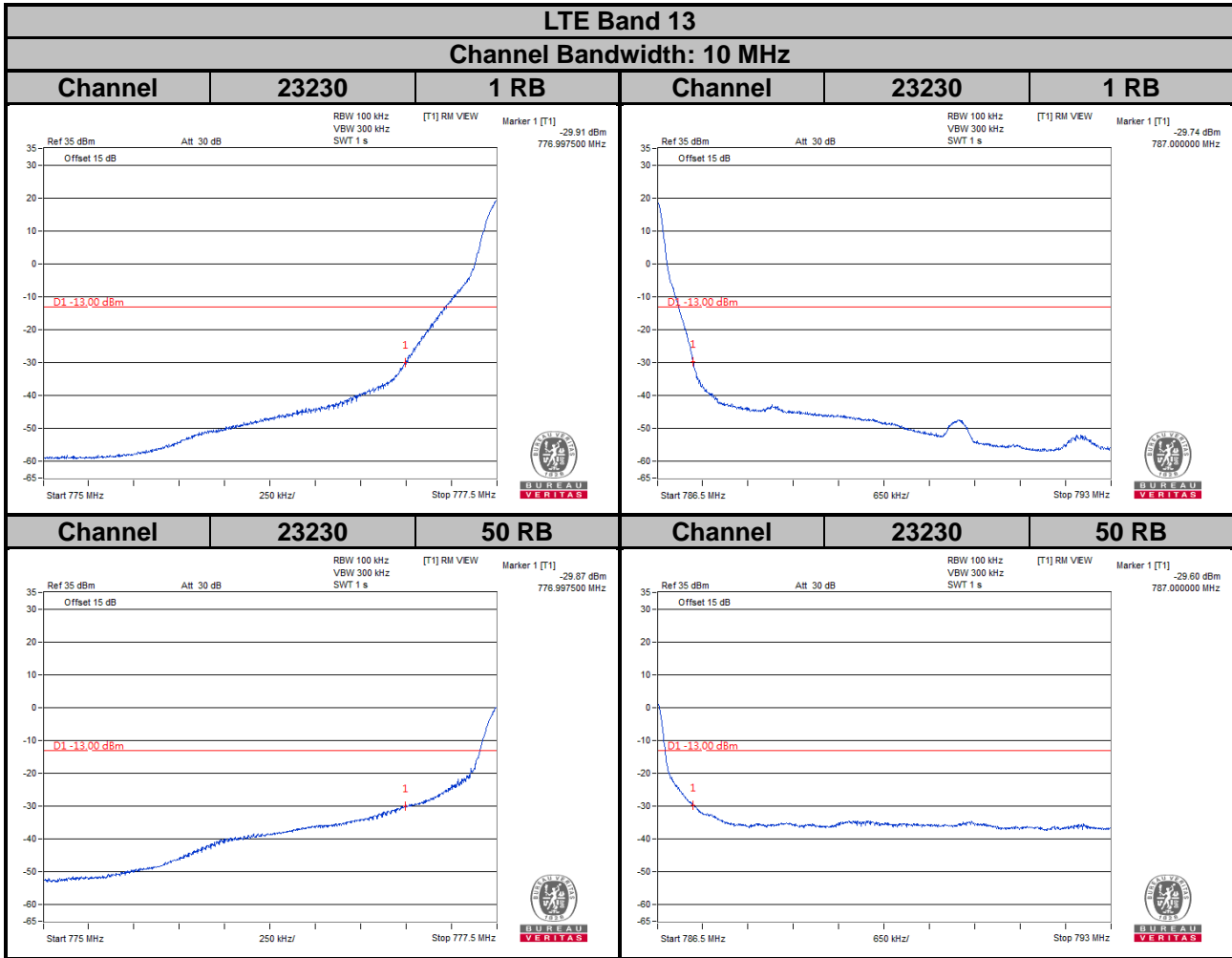

Emission Mask

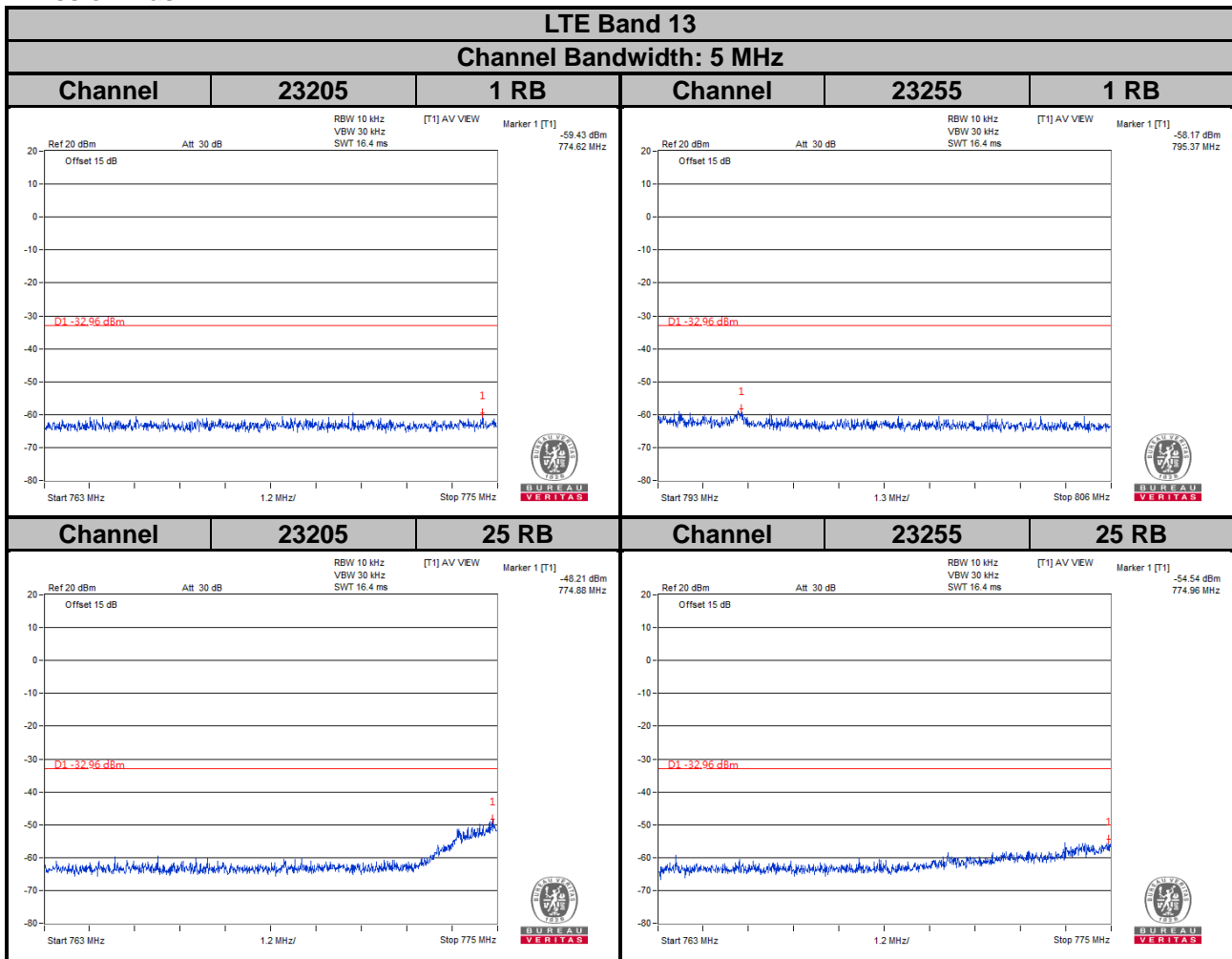

For the 763 - 775 MHz and 793 - 805 MHz band, the FCC limit is $65 + 10 \log(P[\text{watt}])$ in a 6.25 kHz bandwidth. Since it was not possible to set the resolution bandwidth to 6.25 kHz with the available equipment, a bandwidth of 10 kHz was used instead to show compliance. By using a 10 kHz bandwidth on the spectrum analyzer.

$$10 \log(10\text{kHz}/6.25\text{kHz}) = 2.04 \text{ dB}$$

$$\text{Limit line} = -35 \text{ dBm} + 2.04 \text{ dB} = -32.96 \text{ dBm}$$

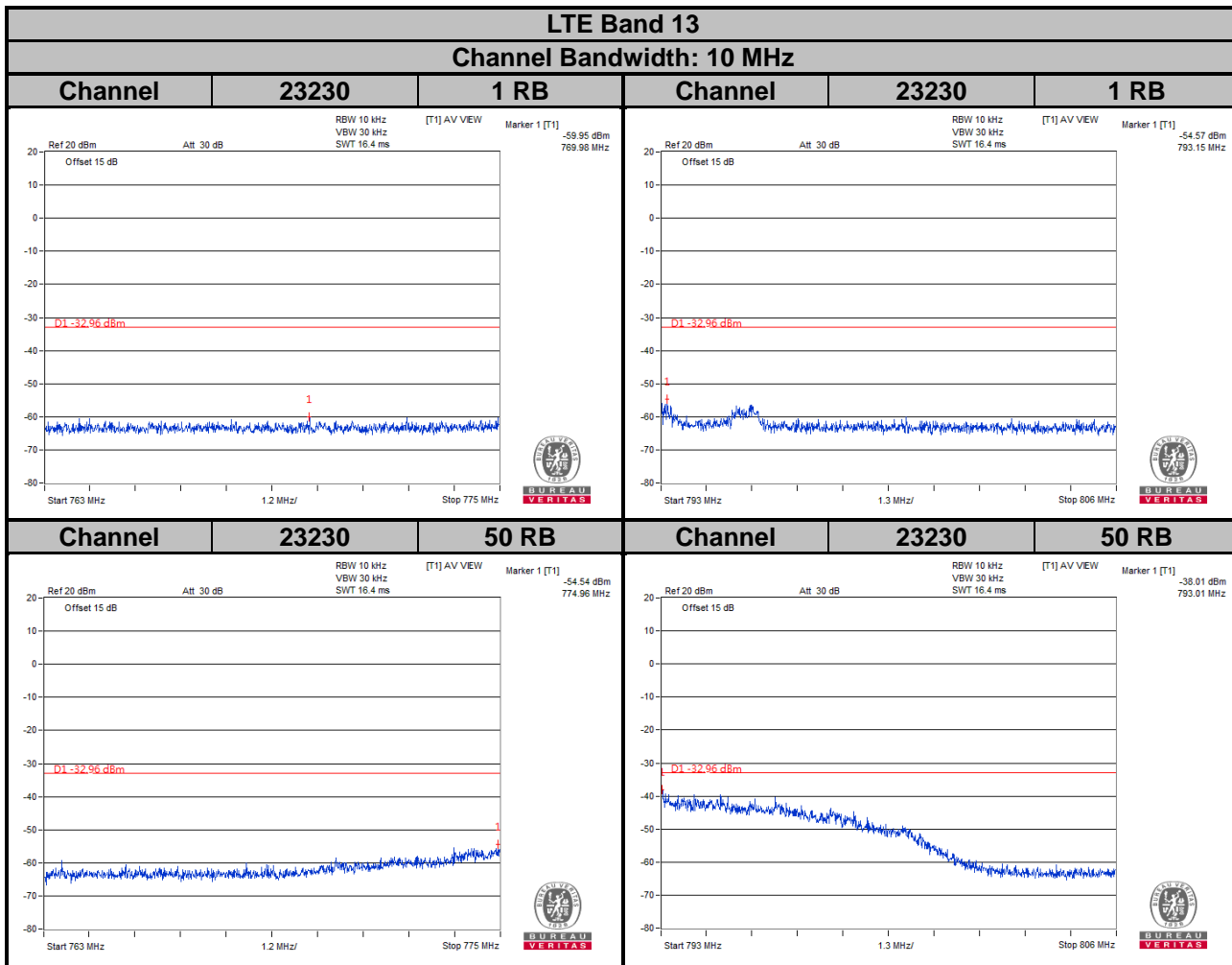

For the 763 - 775 MHz and 793 - 805 MHz band, the FCC limit is $65+10\log(P[\text{watt}])$ in a 6.25 kHz bandwidth. Since it was not possible to set the resolution bandwidth to 6.25 kHz with the available equipment, a bandwidth of 10 kHz was used instead to show compliance. By using a 10 kHz bandwidth on the spectrum analyzer.

$$10\log(10\text{kHz}/6.25\text{kHz}) = 2.04 \text{ dB}$$

$$\text{Limit line} = -35 \text{ dBm} + 2.04 \text{ dB} = -32.96 \text{ dBm}$$

4.6 Peak to Average Ratio

4.6.1 Limits of Peak to Average Ratio Measurement

In measuring transmissions in this band using an average power technique, the peak to-average ratio (PAR) of the transmission may not exceed 13 dB.

4.6.2 Test Setup

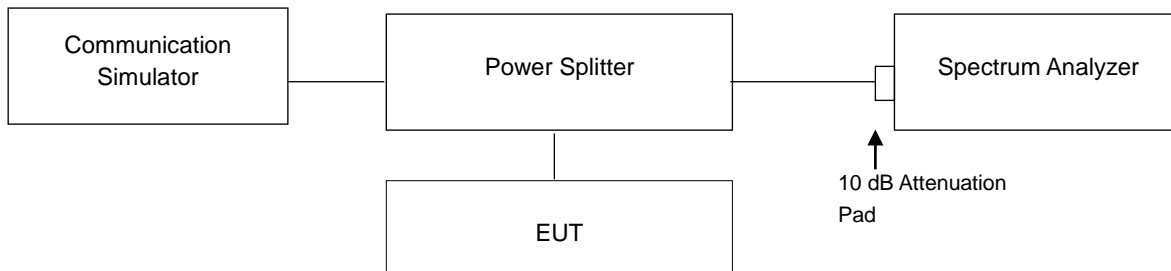

4.6.3 Test Procedures

1. Set resolution/measurement bandwidth \geq signal's occupied bandwidth;
2. Set the number of counts to a value that stabilizes the measured CCDF curve;
3. Record the maximum PAPR level associated with a probability of 0.1 %.

4.6.4 Test Results

WCDMA		
Channel	Frequency (MHz)	Peak to Average Ratio (dB)
1312	1712.4	2.78
1413	1732.6	2.98
1513	1752.6	2.73

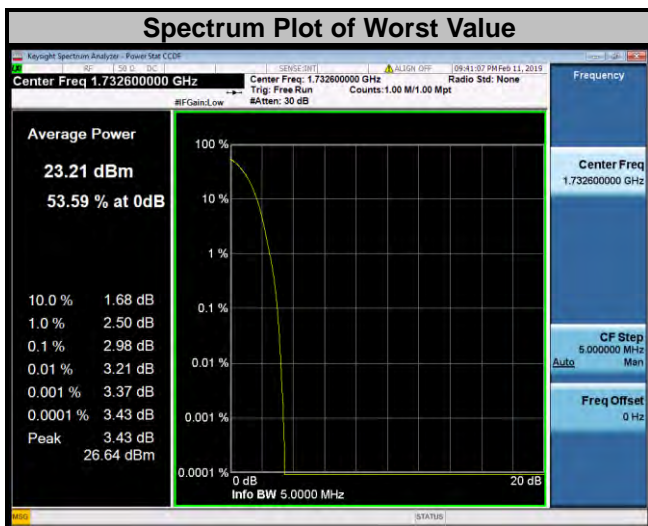

LTE Band 4							
Channel Bandwidth: 1.4 MHz				Channel Bandwidth: 3 MHz			
Channel	Frequency (MHz)	Peak to Average Ratio (dB)		Channel	Frequency (MHz)	Peak to Average Ratio (dB)	
		QPSK	16QAM			QPSK	16QAM
19957	1710.7	3.83	4.41	19965	1711.5	3.85	4.65
20175	1732.5	4.50	5.33	20175	1732.5	4.57	5.30
20393	1754.3	3.72	4.54	20385	1753.5	3.78	4.58

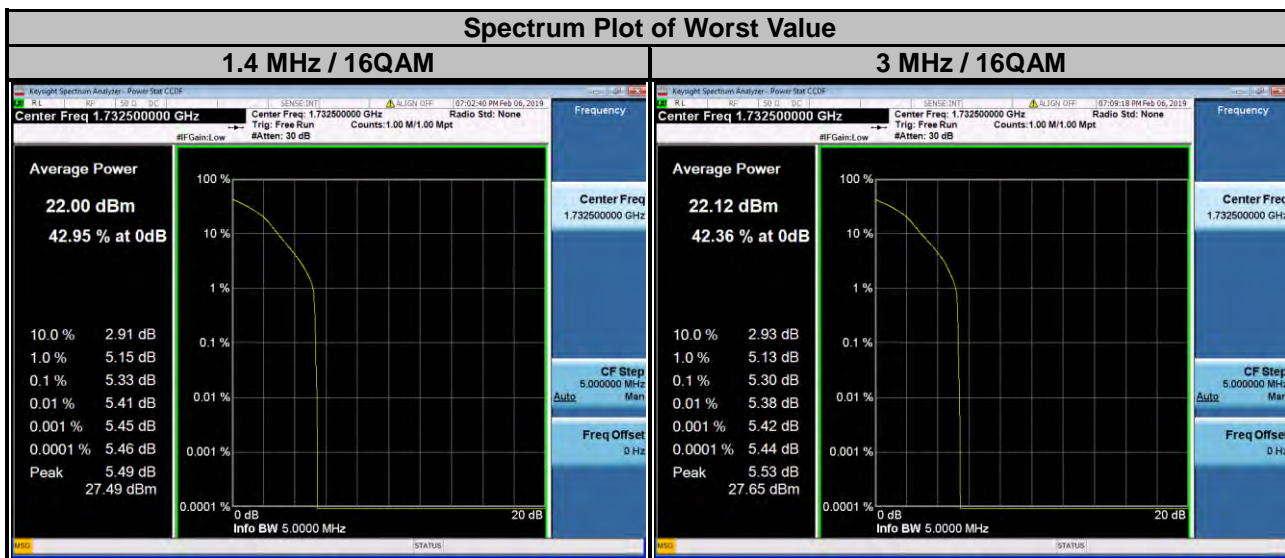

LTE Band 4							
Channel Bandwidth: 5 MHz				Channel Bandwidth: 10 MHz			
Channel	Frequency (MHz)	Peak to Average Ratio (dB)		Channel	Frequency (MHz)	Peak to Average Ratio (dB)	
		QPSK	16QAM			QPSK	16QAM
19975	1712.5	3.81	4.40	20000	1715.0	3.74	4.42
20175	1732.5	4.56	5.25	20175	1732.5	4.36	5.06
20375	1752.5	3.69	4.43	20350	1750.0	3.71	4.62



LTE Band 4							
Channel Bandwidth: 15 MHz				Channel Bandwidth: 20 MHz			
Channel	Frequency (MHz)	Peak to Average Ratio (dB)		Channel	Frequency (MHz)	Peak to Average Ratio (dB)	
		QPSK	16QAM			QPSK	16QAM
20025	1717.5	3.72	4.43	20050	1720.0	3.76	4.27
20175	1732.5	4.31	5.04	20175	1732.5	4.17	5.00
20325	1747.5	3.98	4.82	20300	1745.0	4.35	5.15

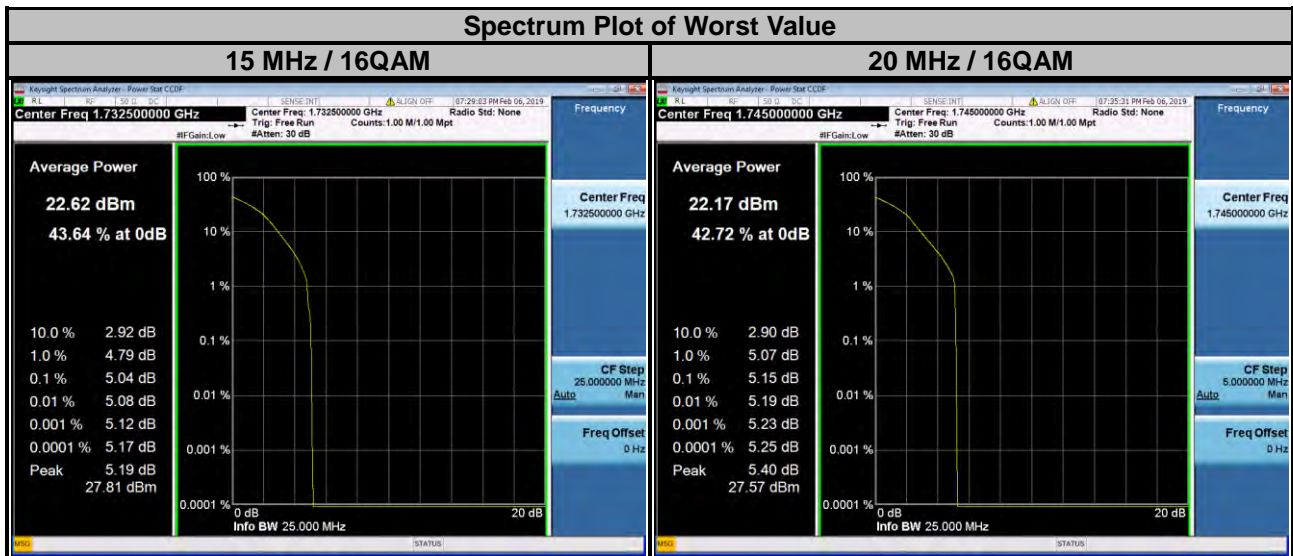

LTE Band 12							
Channel Bandwidth: 1.4 MHz				Channel Bandwidth: 3 MHz			
Channel	Frequency (MHz)	Peak to Average Ratio (dB)		Channel	Frequency (MHz)	Peak to Average Ratio (dB)	
		QPSK	16QAM			QPSK	16QAM
23017	699.7	4.74	5.60	23025	700.5	4.73	5.44
23095	707.5	5.05	5.75	23095	707.5	5.05	5.83
23173	715.3	4.73	5.44	23165	714.5	4.56	5.32

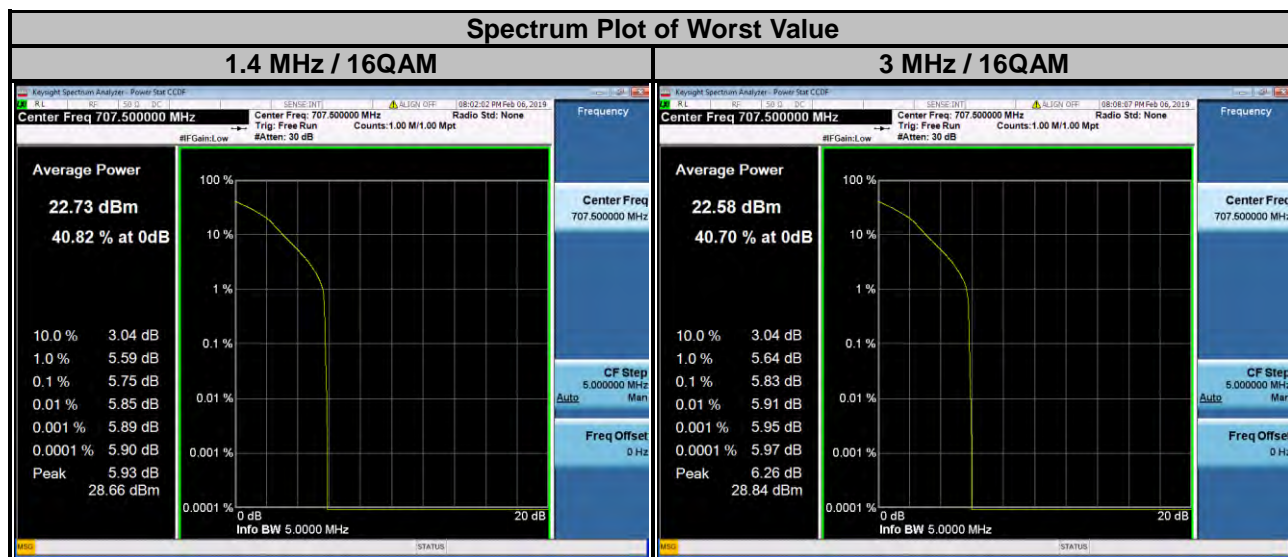

LTE Band 12							
Channel Bandwidth: 5 MHz				Channel Bandwidth: 10 MHz			
Channel	Frequency (MHz)	Peak to Average Ratio (dB)		Channel	Frequency (MHz)	Peak to Average Ratio (dB)	
		QPSK	16QAM			QPSK	16QAM
23035	701.5	4.68	5.35	23060	704.0	4.73	5.47
23095	707.5	4.98	5.66	23095	707.5	4.87	5.61
23155	713.5	4.62	5.35	23130	711.0	4.98	5.67

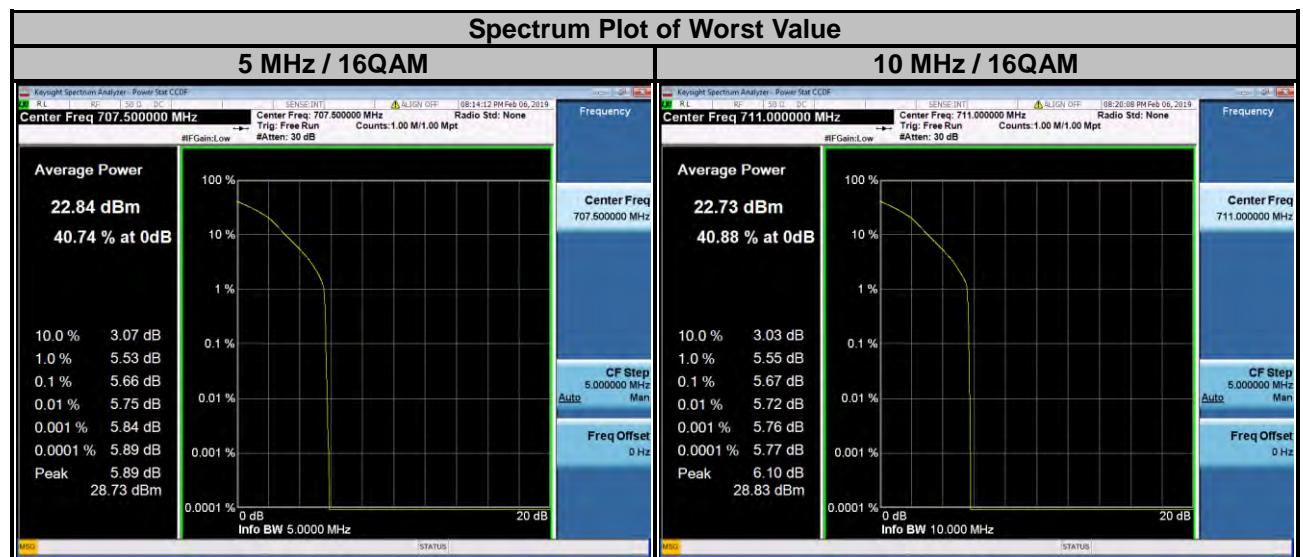

LTE Band 13

Channel Bandwidth: 5 MHz				Channel Bandwidth: 10 MHz			
Channel	Frequency (MHz)	Peak to Average Ratio (dB)		Channel	Frequency (MHz)	Peak to Average Ratio (dB)	
		QPSK	16QAM			QPSK	16QAM
23205	779.5	3.38	4.12	23230	782.0	3.44	4.28
23230	782.0	3.37	3.83				
23255	784.5	3.82	4.31				

Spectrum Plot of Worst Value

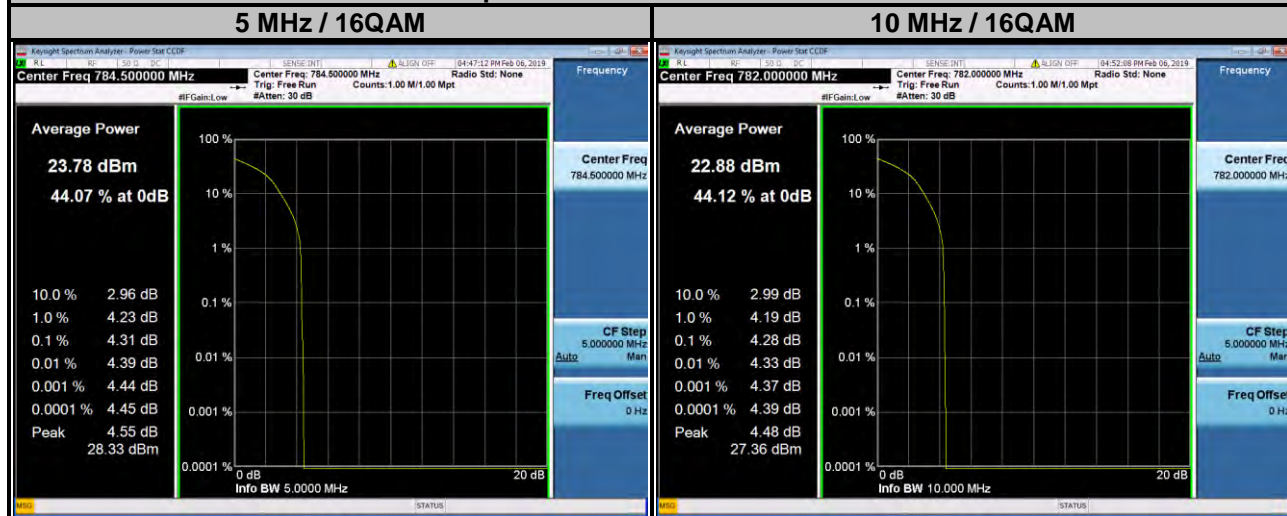

4.7 Conducted Spurious Emissions

4.7.1 Limits of Conducted Spurious Emissions Measurement

The power of any emission outside a licensee's frequency block shall be attenuated below the transmitter power (P) by at least $43 + 10 \log (P)$ dB. The limit of emission is equal to -13 dBm.

4.7.2 Test Setup

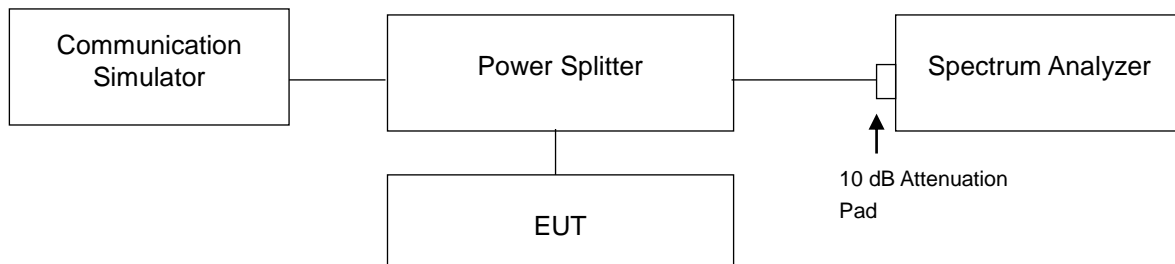

4.7.3 Test Procedure

- The EUT makes a phone call to the communication simulator. All measurements were done at low, middle and high operational frequency range.
- Measuring frequency range is from 9 kHz to 1 GHz. 10 dB attenuation pad is connected with spectrum. RBW = 100 kHz and VBW = 300 kHz is used for conducted emission measurement.
- Measuring frequency range is from 1 GHz to 8 GHz / 18 GHz. 10 dB attenuation pad is connected with spectrum. RBW = 1 MHz and VBW = 3 MHz is used for conducted emission measurement.

4.7.4 Test Results

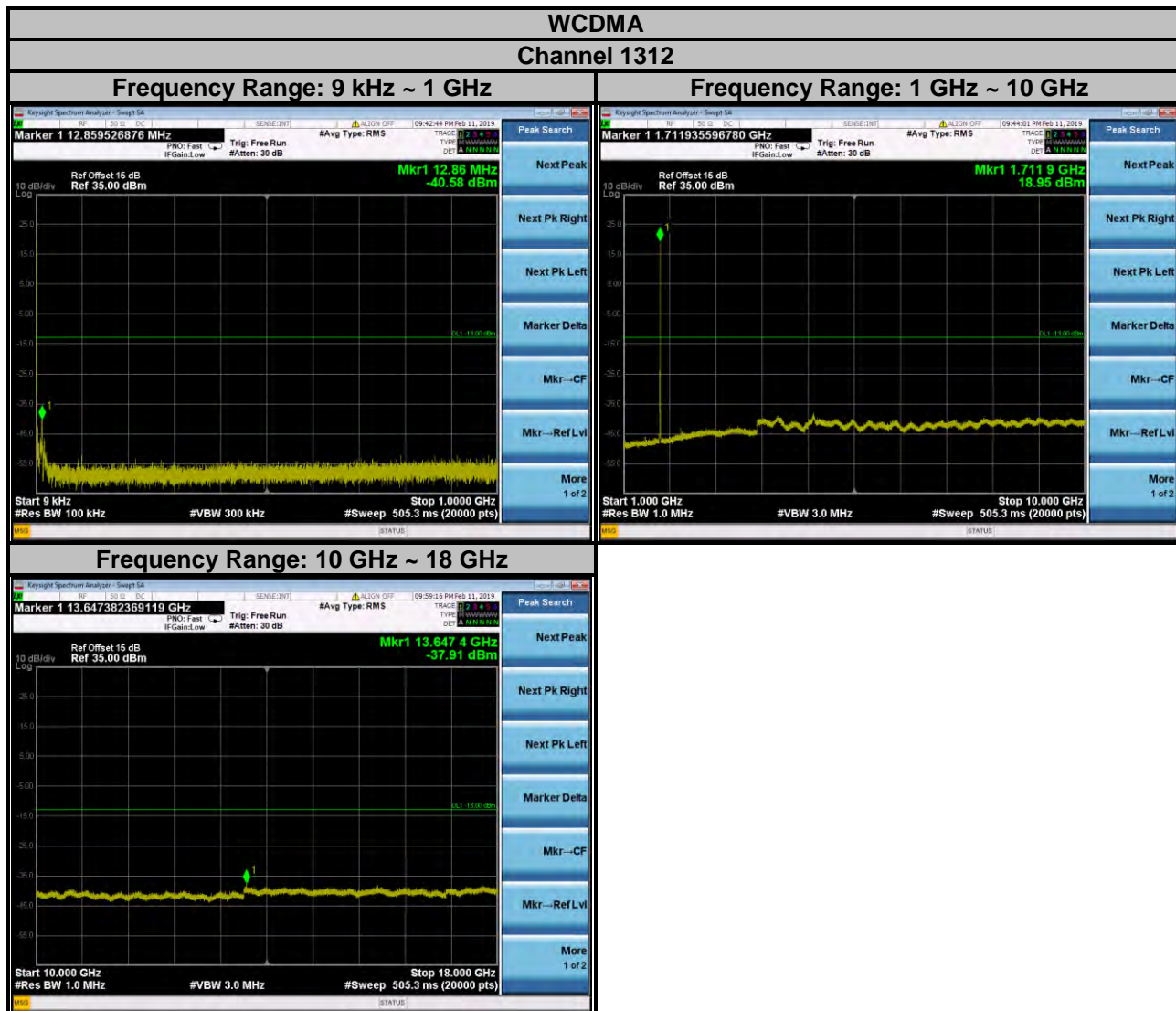

Note: The signal over the limit in 9 kHz is from spectrum analyzer.

WCDMA

Channel 1413

Frequency Range: 9 kHz ~ 1 GHz

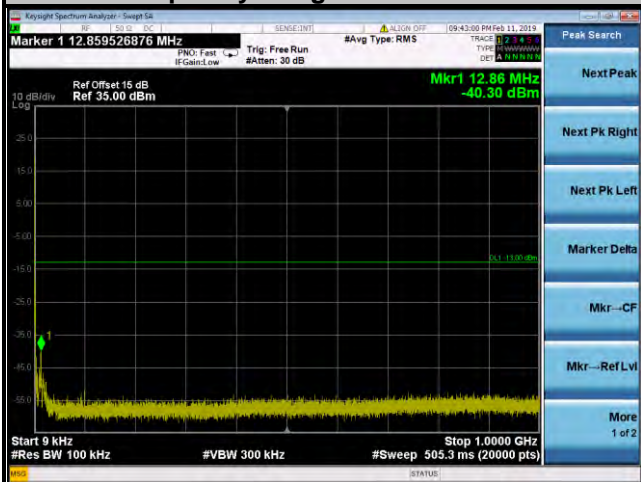

Frequency Range: 1 GHz ~ 10 GHz

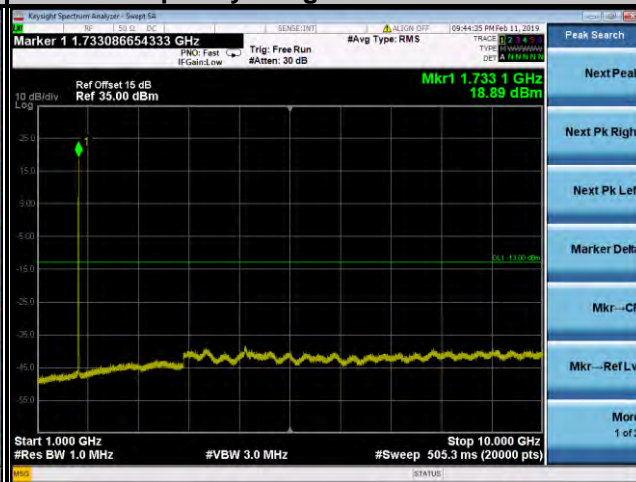

Frequency Range: 10 GHz ~ 18 GHz



Note: The signal over the limit in 9 kHz is from spectrum analyzer.

WCDMA

Channel 1513

Frequency Range: 9 kHz ~ 1 GHz

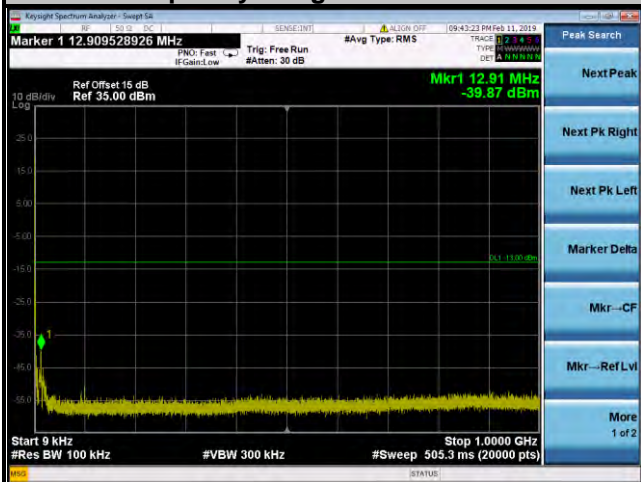

Frequency Range: 1 GHz ~ 10 GHz



Frequency Range: 10 GHz ~ 18 GHz



Note: The signal over the limit in 9 kHz is from spectrum analyzer.

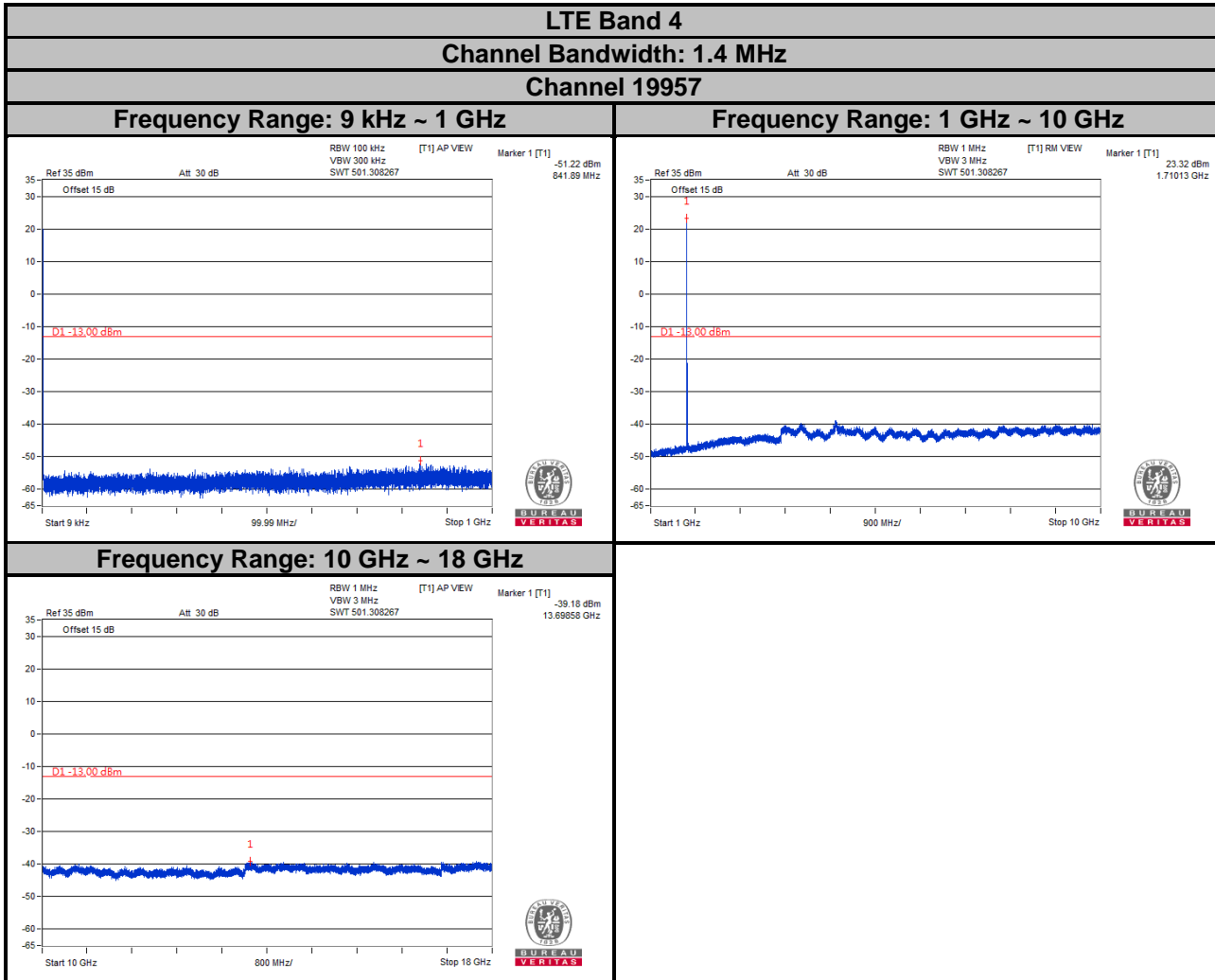

Note: The signal over the limit in 9 kHz is from spectrum analyzer.

LTE Band 4

Channel Bandwidth: 1.4 MHz

Channel 20175

Frequency Range: 9 kHz ~ 1 GHz

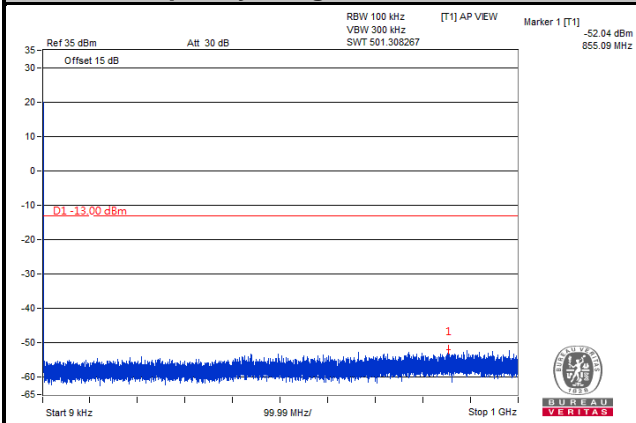

Frequency Range: 1 GHz ~ 10 GHz

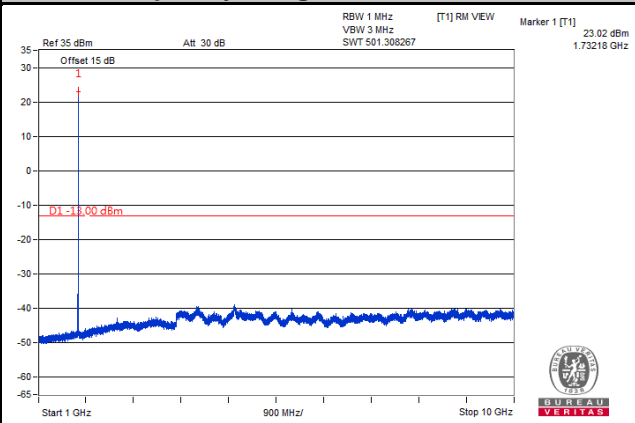

Frequency Range: 10 GHz ~ 18 GHz

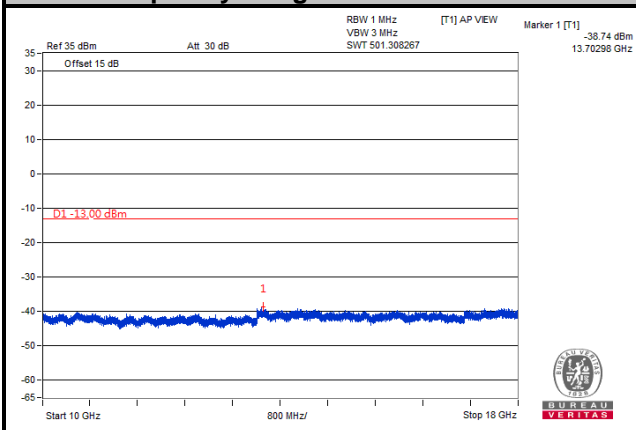

Note: The signal over the limit in 9 kHz is from spectrum analyzer.

LTE Band 4

Channel Bandwidth: 1.4 MHz

Channel 20393

Frequency Range: 9 kHz ~ 1 GHz

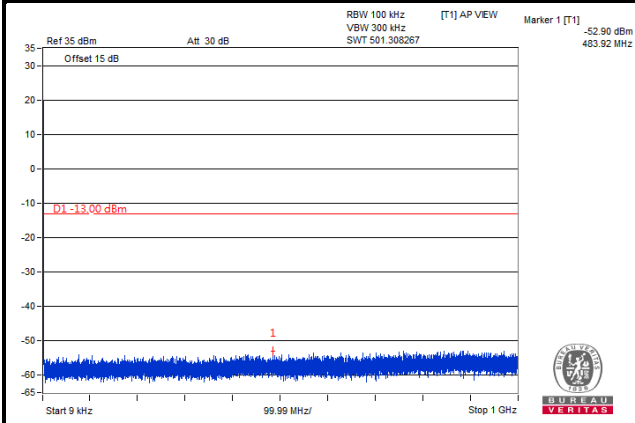

Frequency Range: 1 GHz ~ 10 GHz

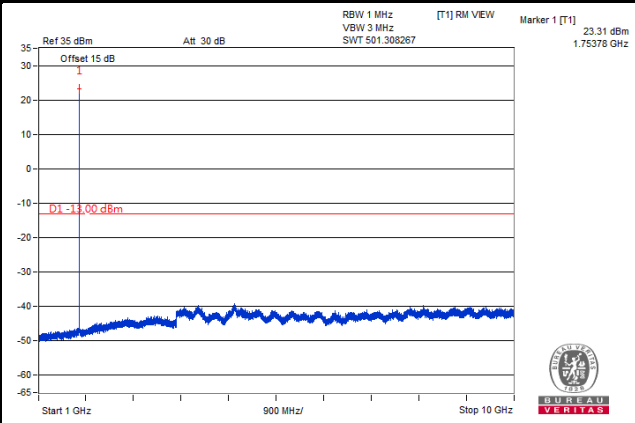

Frequency Range: 10 GHz ~ 18 GHz

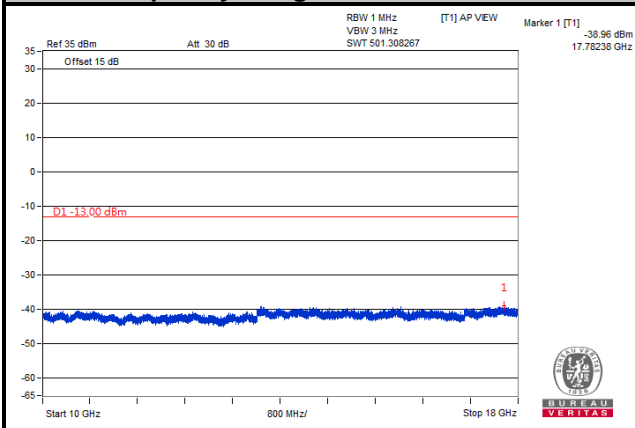

Note: The signal over the limit in 9 kHz is from spectrum analyzer.

LTE Band 4
Channel Bandwidth: 3 MHz
Channel 19965

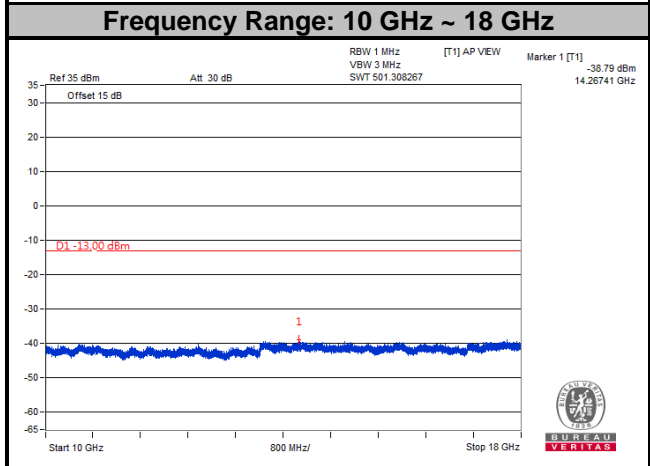
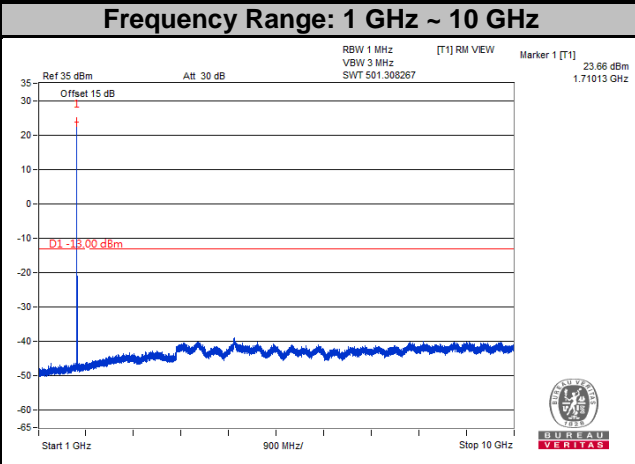
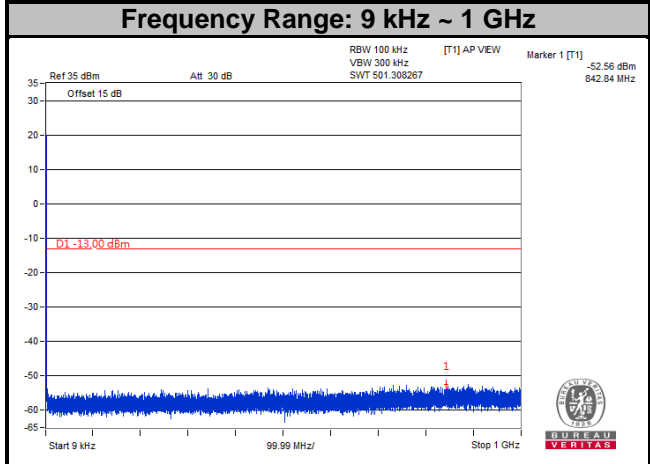

Note: The signal over the limit in 9 kHz is from spectrum analyzer.

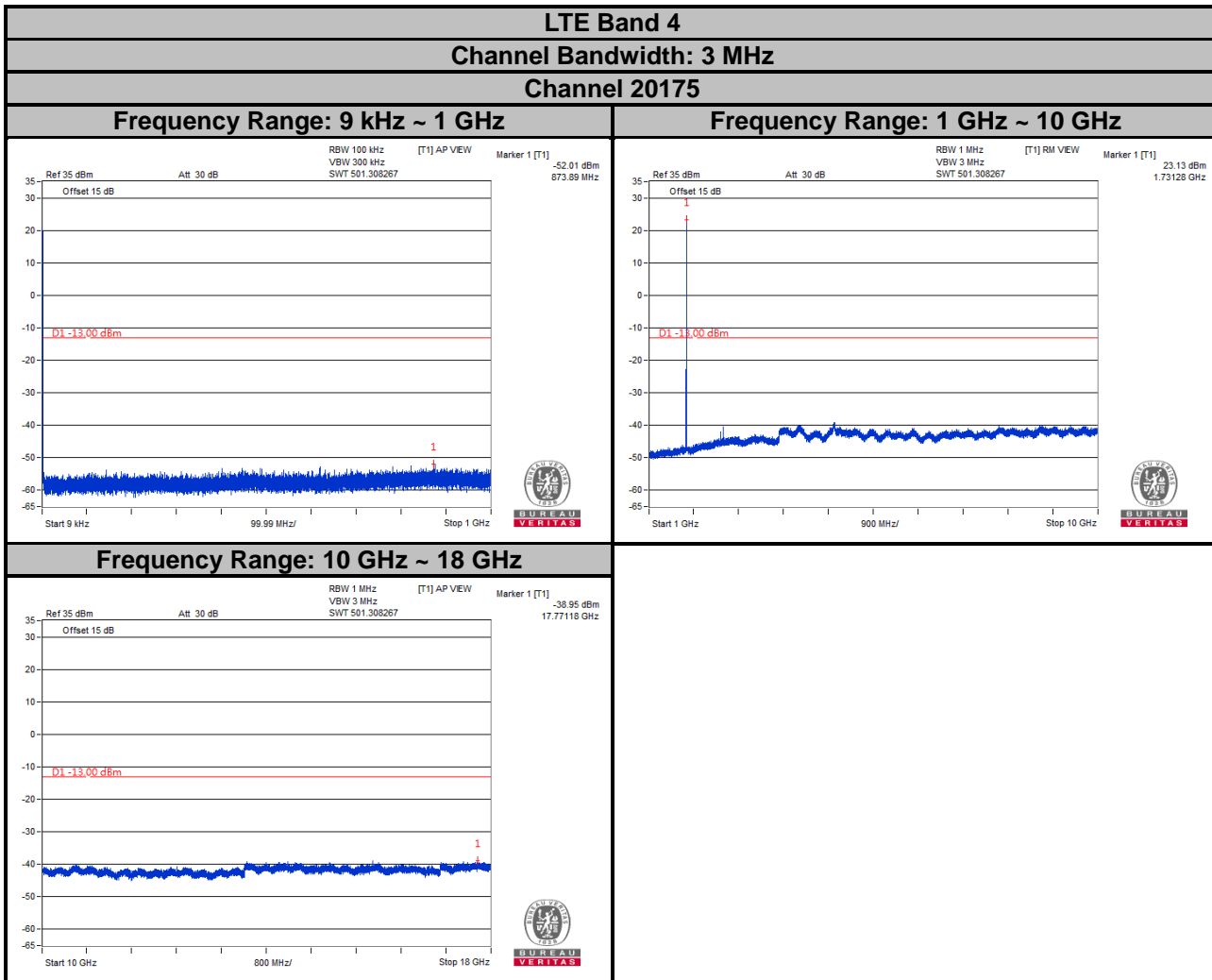

Note: The signal over the limit in 9 kHz is from spectrum analyzer.

LTE Band 4

Channel Bandwidth: 3 MHz

Channel 20385

Frequency Range: 9 kHz ~ 1 GHz

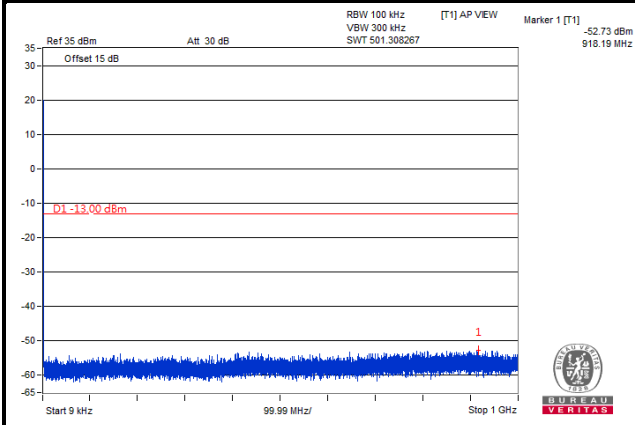

Frequency Range: 1 GHz ~ 10 GHz

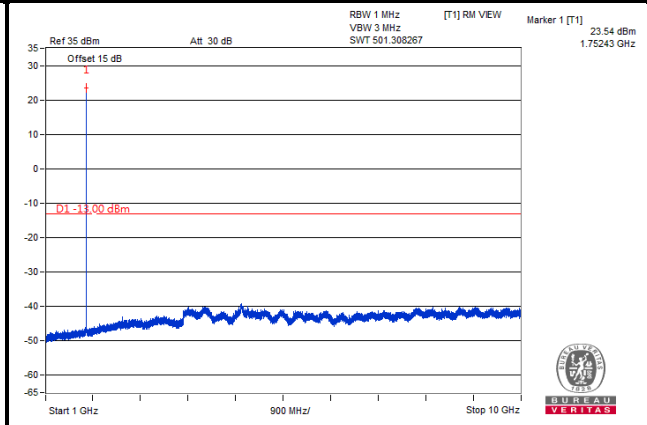

Frequency Range: 10 GHz ~ 18 GHz

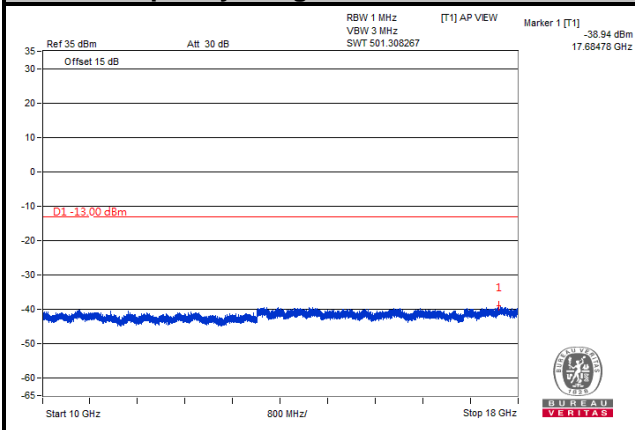

Note: The signal over the limit in 9 kHz is from spectrum analyzer.

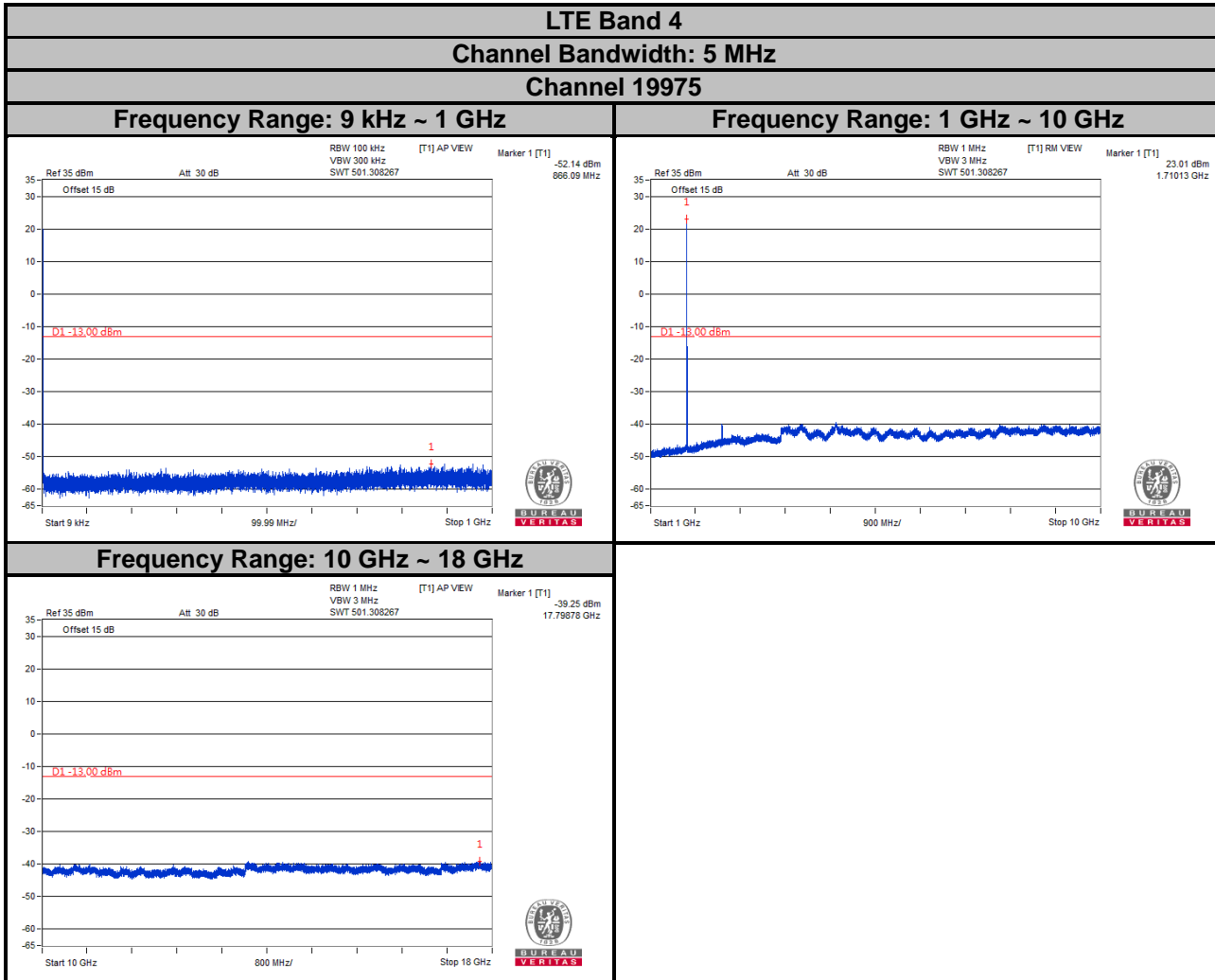

Note: The signal over the limit in 9 kHz is from spectrum analyzer.

LTE Band 4

Channel Bandwidth: 5 MHz

Channel 20175

Frequency Range: 9 kHz ~ 1 GHz

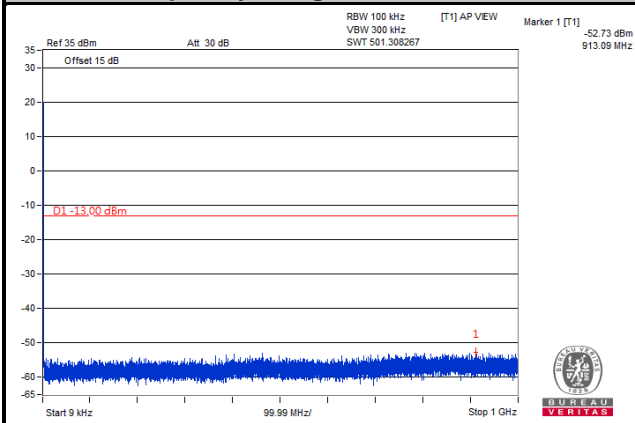

Frequency Range: 1 GHz ~ 10 GHz

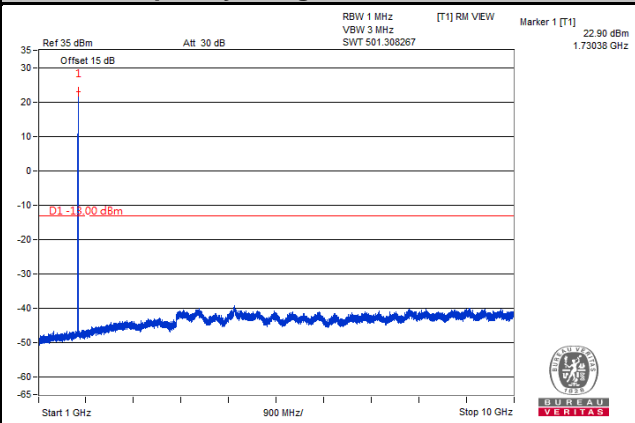

Frequency Range: 10 GHz ~ 18 GHz

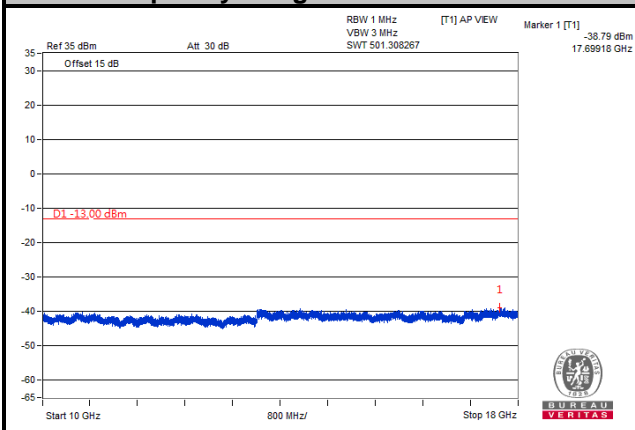

Note: The signal over the limit in 9 kHz is from spectrum analyzer.

LTE Band 4

Channel Bandwidth: 5 MHz

Channel 20375

Frequency Range: 9 kHz ~ 1 GHz

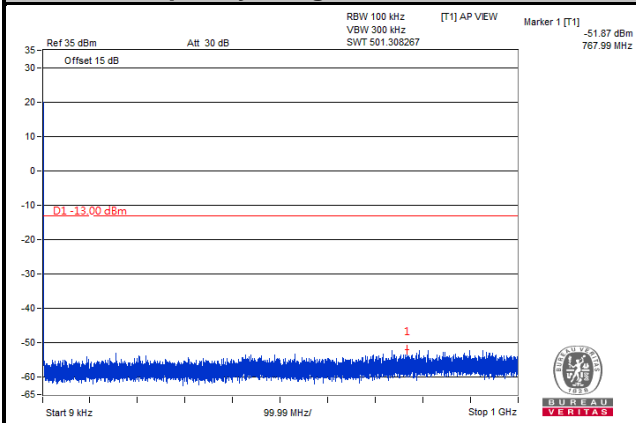

Frequency Range: 1 GHz ~ 10 GHz

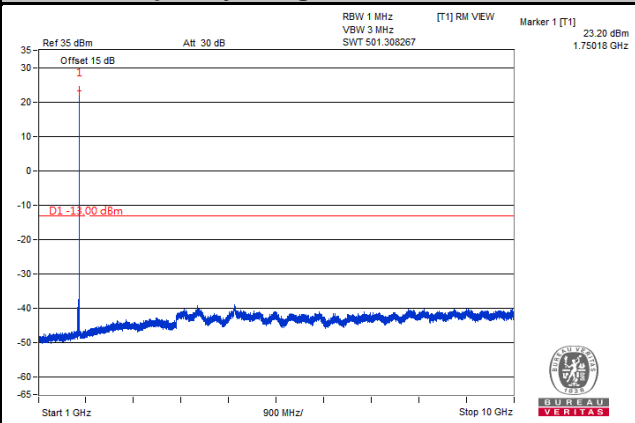

Frequency Range: 10 GHz ~ 18 GHz

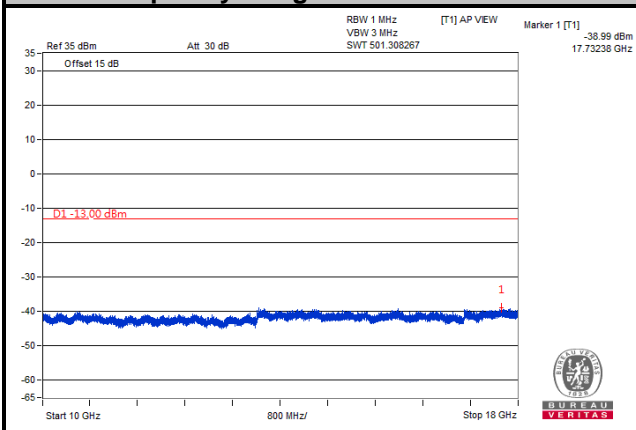

Note: The signal over the limit in 9 kHz is from spectrum analyzer.

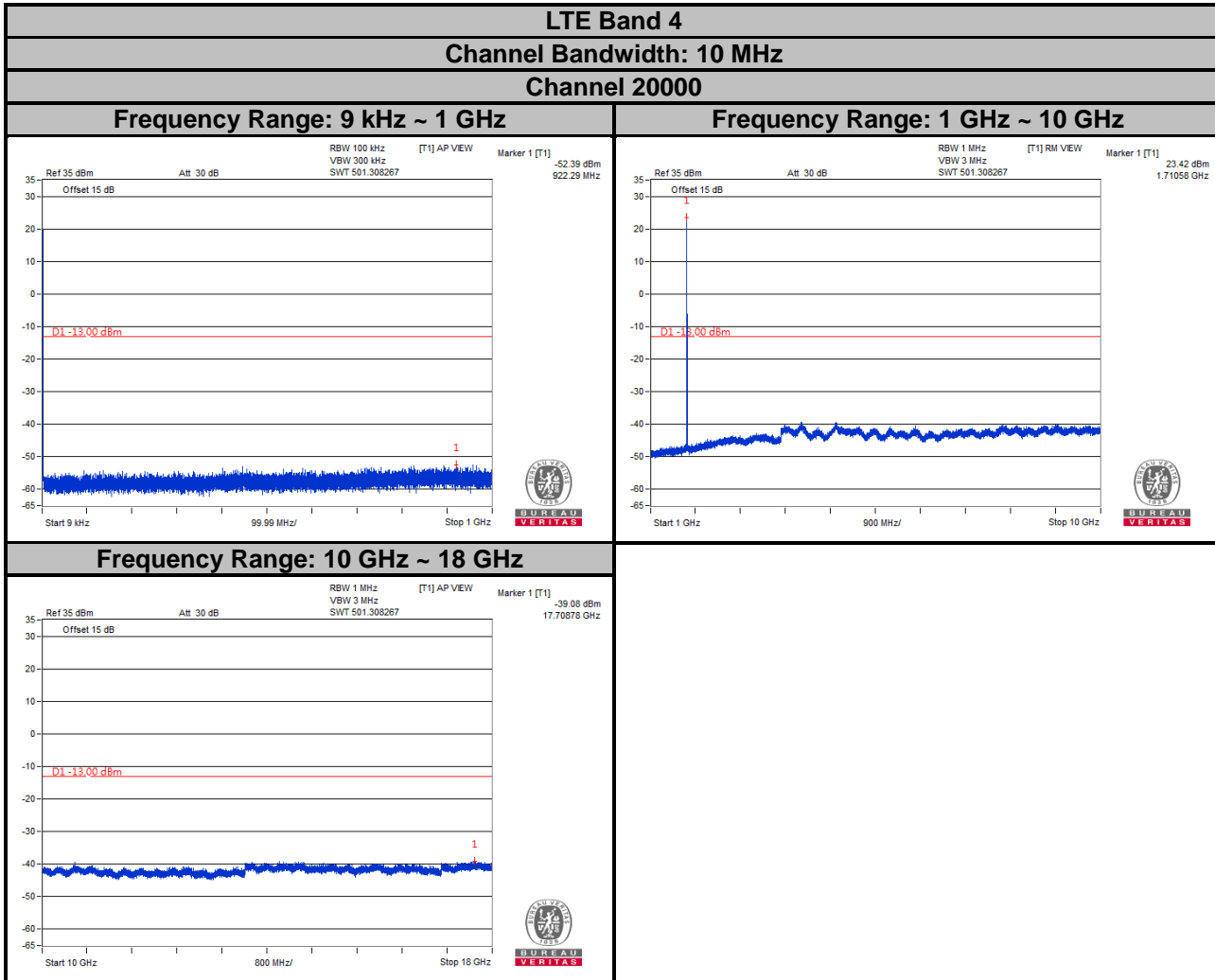

Note: The signal over the limit in 9 kHz is from spectrum analyzer.

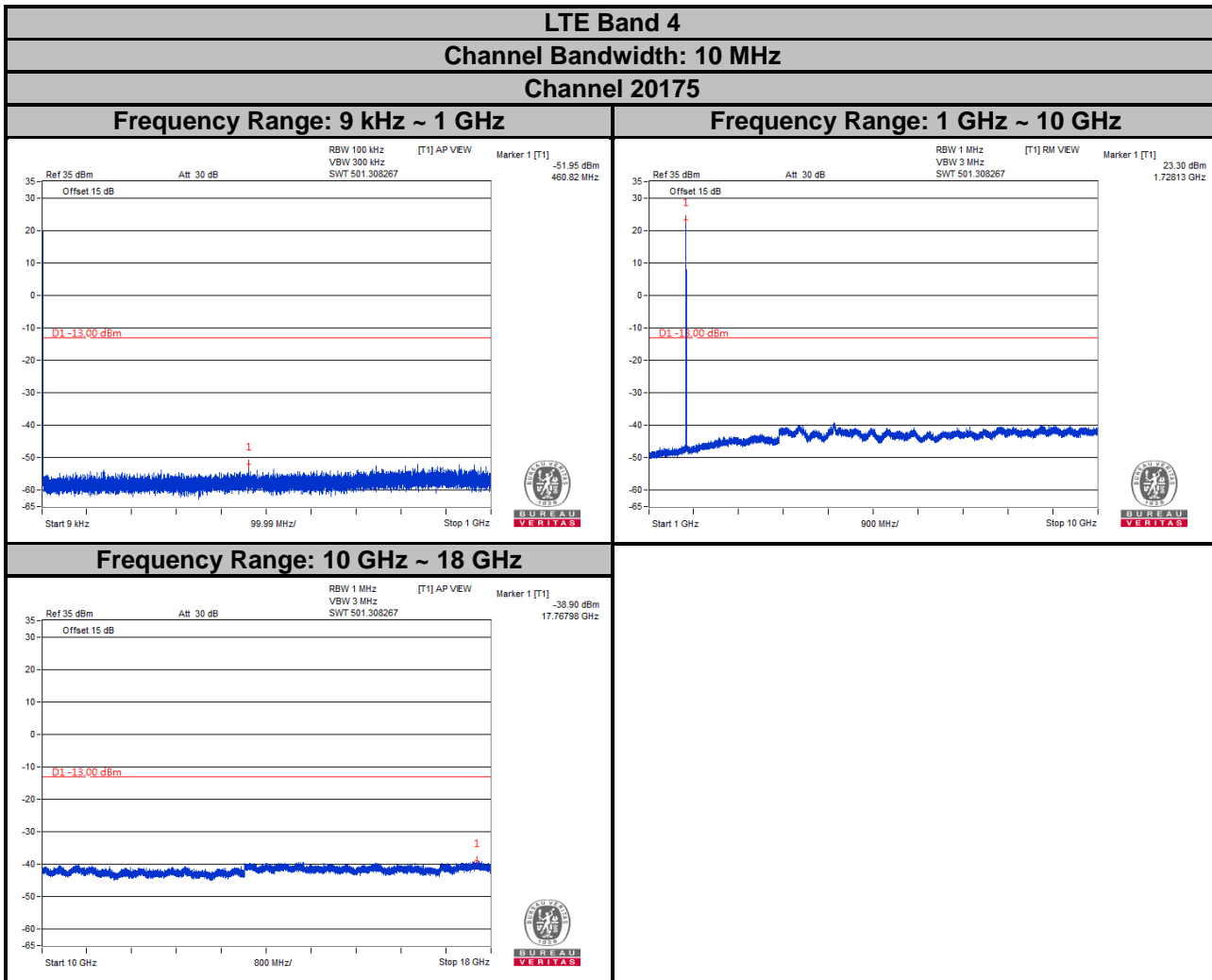

Note: The signal over the limit in 9 kHz is from spectrum analyzer.

LTE Band 4

Channel Bandwidth: 10 MHz

Channel 20350

Frequency Range: 9 kHz ~ 1 GHz

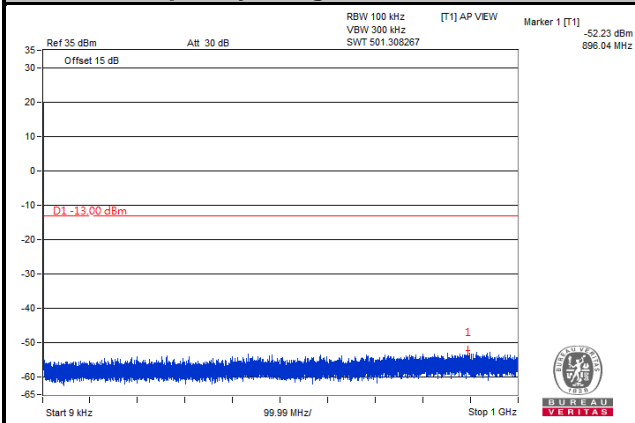

Frequency Range: 1 GHz ~ 10 GHz

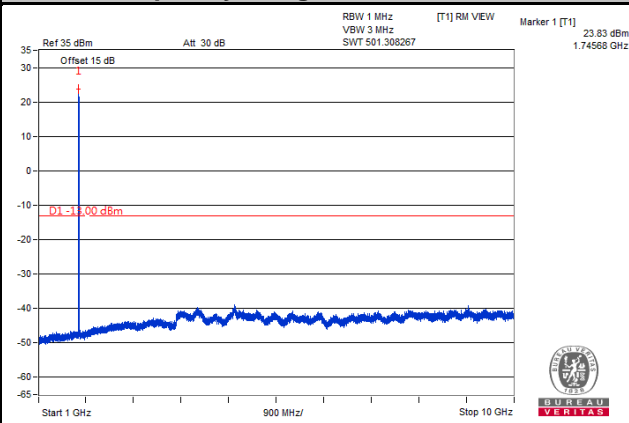

Frequency Range: 10 GHz ~ 18 GHz

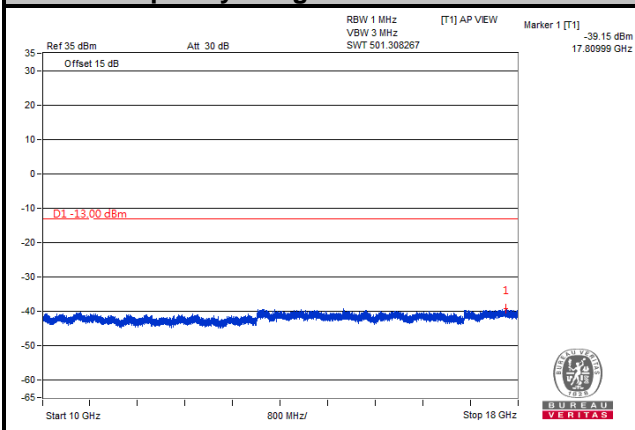

Note: The signal over the limit in 9 kHz is from spectrum analyzer.

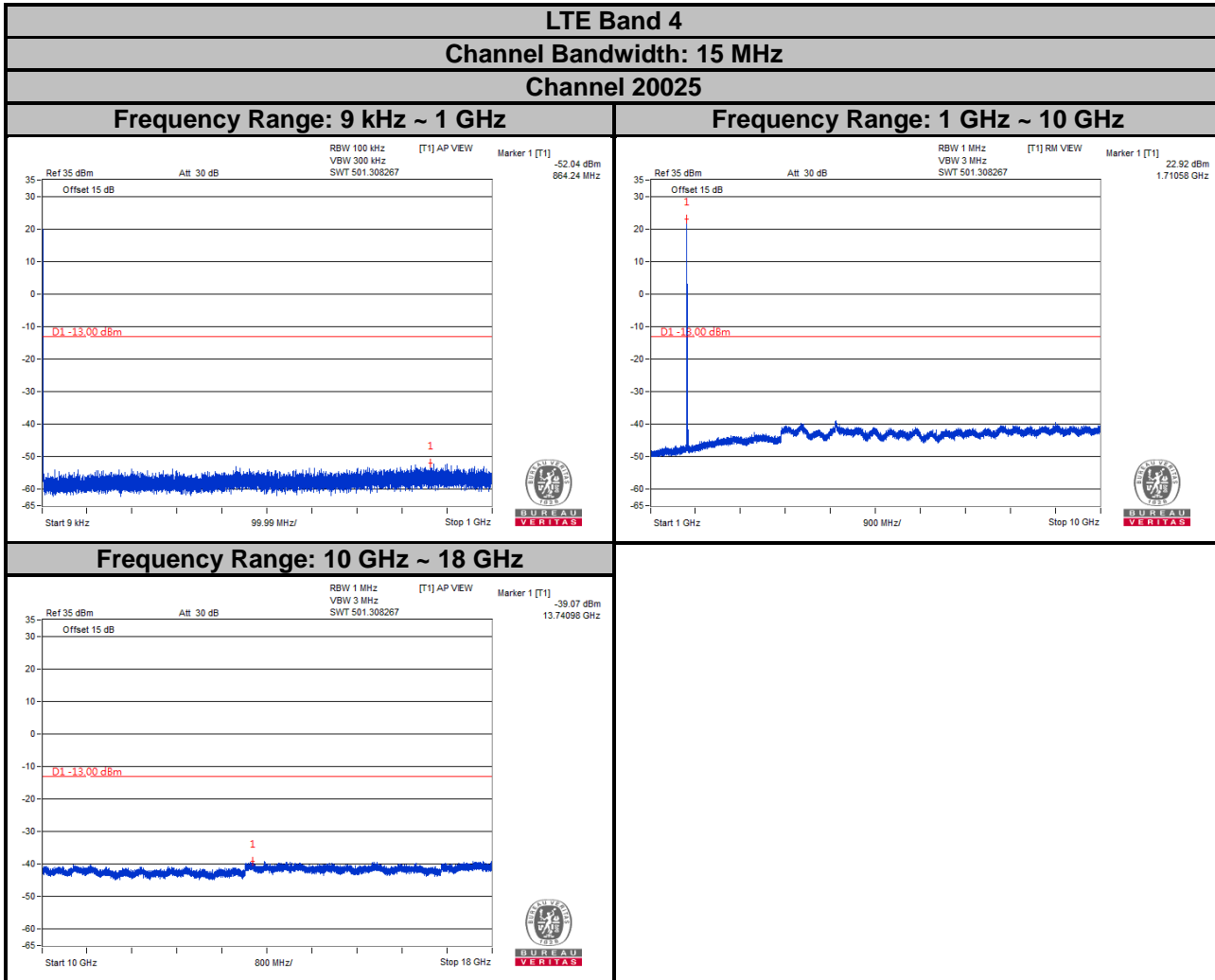

Note: The signal over the limit in 9 kHz is from spectrum analyzer.

LTE Band 4

Channel Bandwidth: 15 MHz

Channel 20175

Frequency Range: 9 kHz ~ 1 GHz

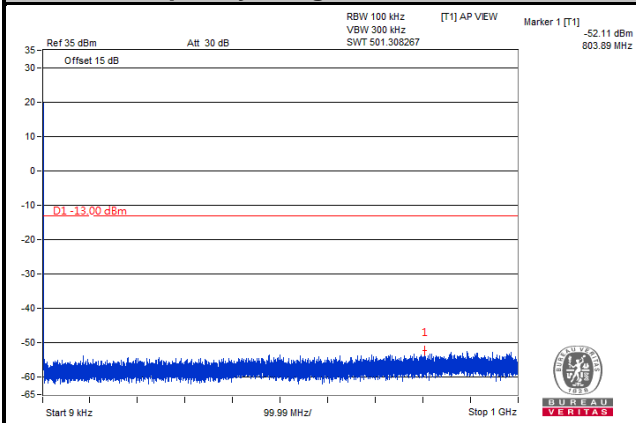

Frequency Range: 1 GHz ~ 10 GHz

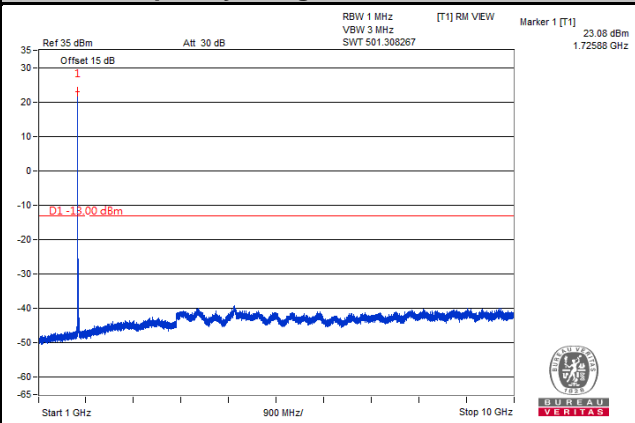

Frequency Range: 10 GHz ~ 18 GHz

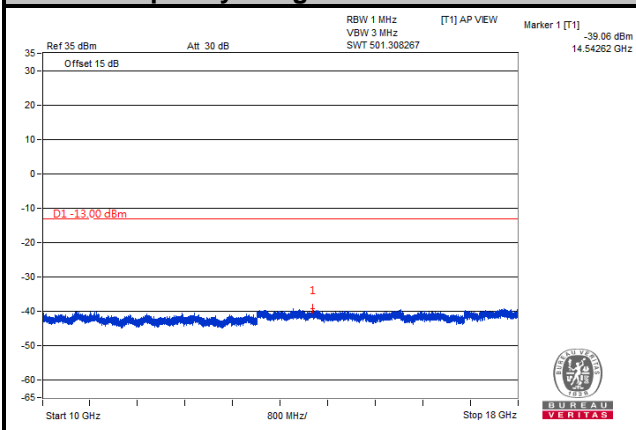

Note: The signal over the limit in 9 kHz is from spectrum analyzer.

LTE Band 4

Channel Bandwidth: 15 MHz

Channel 20325

Frequency Range: 9 kHz ~ 1 GHz

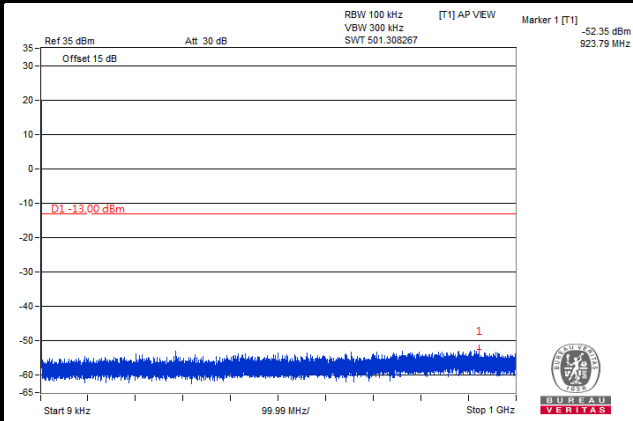

Frequency Range: 1 GHz ~ 10 GHz

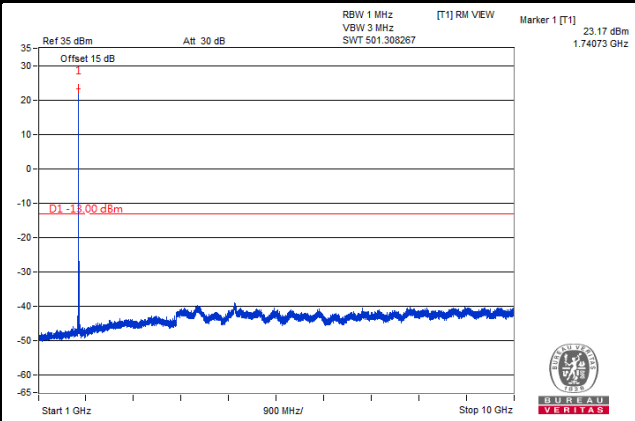

Frequency Range: 10 GHz ~ 18 GHz

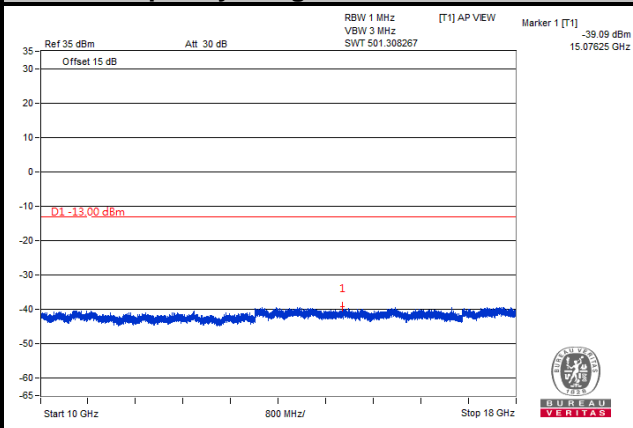

Note: The signal over the limit in 9 kHz is from spectrum analyzer.

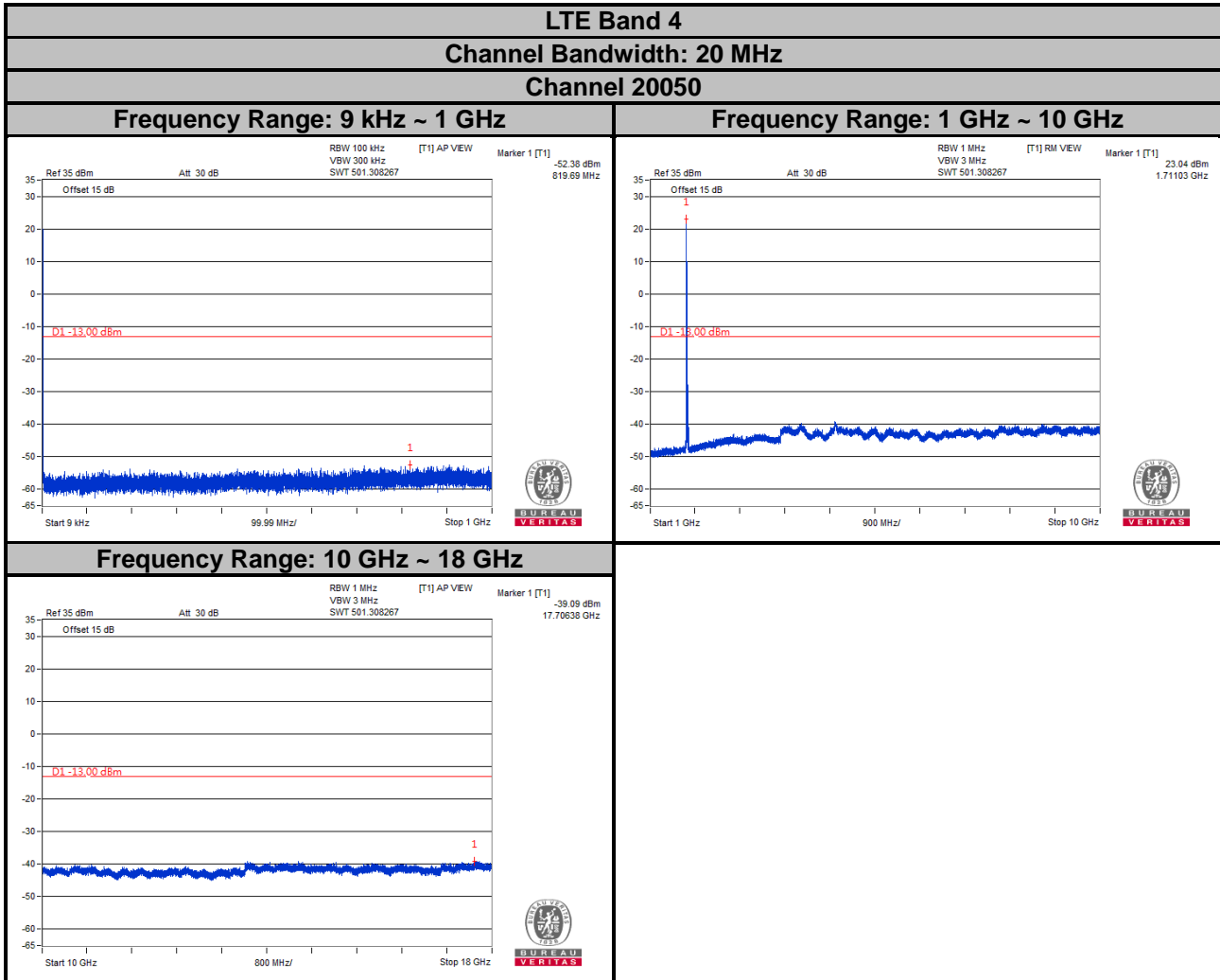

Note: The signal over the limit in 9 kHz is from spectrum analyzer.

LTE Band 4

Channel Bandwidth: 20 MHz

Channel 20175

Frequency Range: 9 kHz ~ 1 GHz

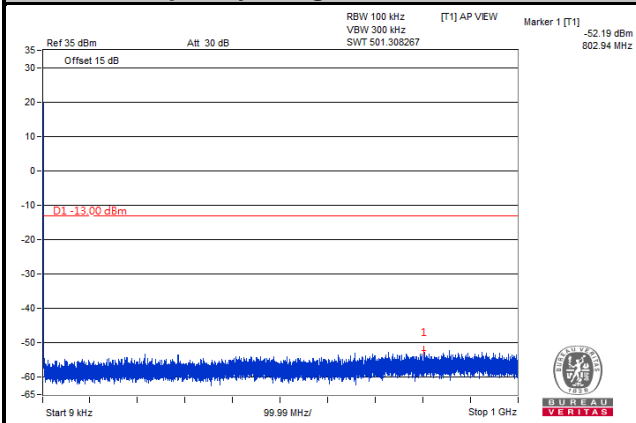

Frequency Range: 1 GHz ~ 10 GHz

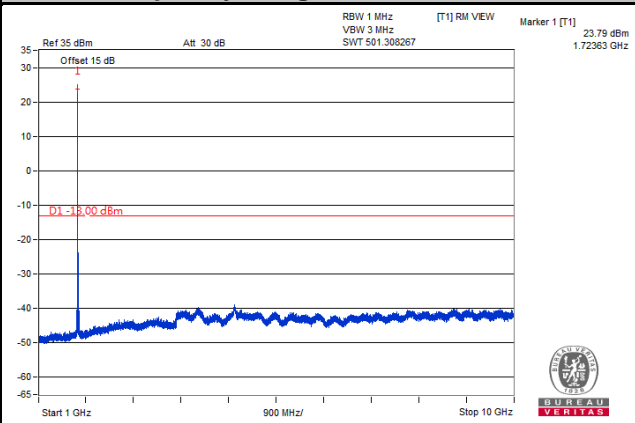

Frequency Range: 10 GHz ~ 18 GHz

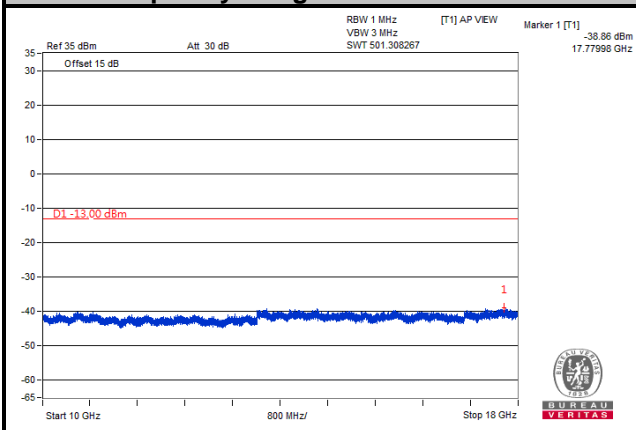

Note: The signal over the limit in 9 kHz is from spectrum analyzer.

LTE Band 4

Channel Bandwidth: 20 MHz

Channel 20300

Frequency Range: 9 kHz ~ 1 GHz

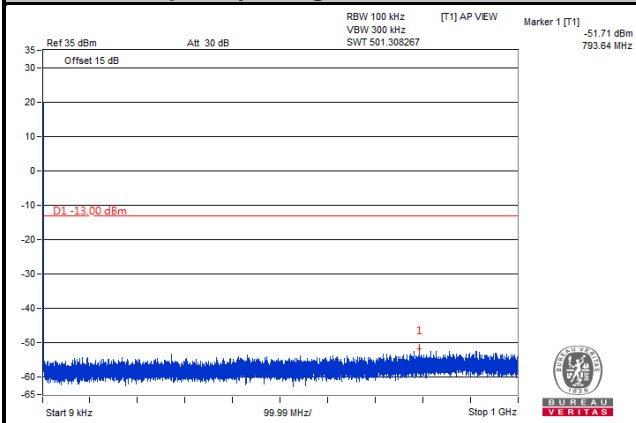

Frequency Range: 1 GHz ~ 10 GHz

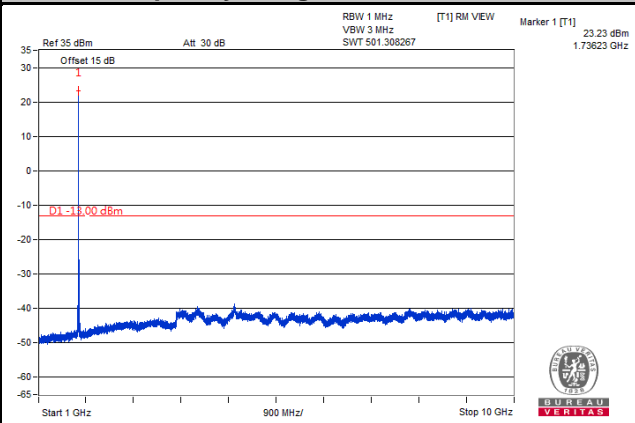

Frequency Range: 10 GHz ~ 18 GHz

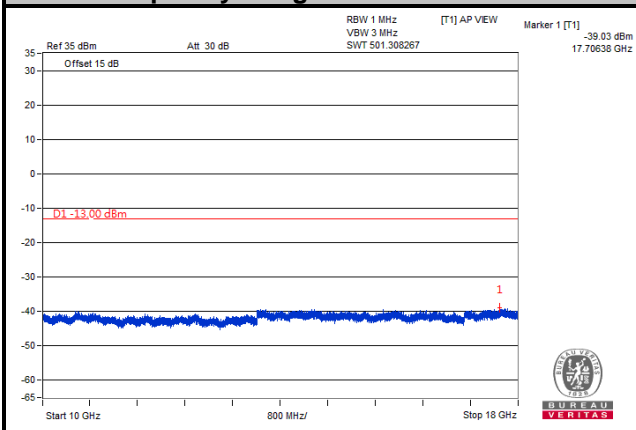

Note: The signal over the limit in 9 kHz is from spectrum analyzer.

LTE Band 12
Channel Bandwidth: 1.4 MHz
Channel 23017

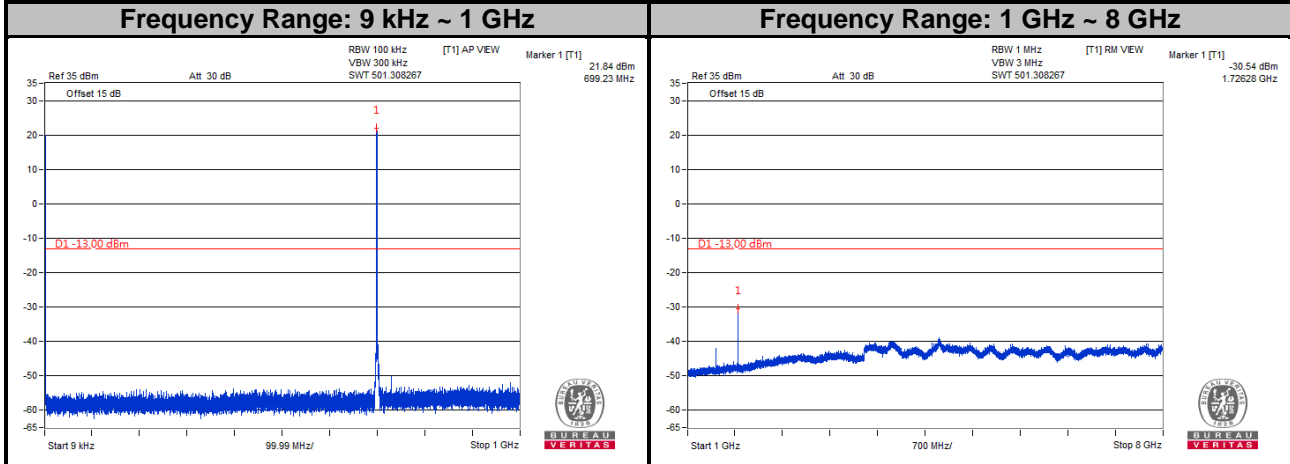

Channel 23095

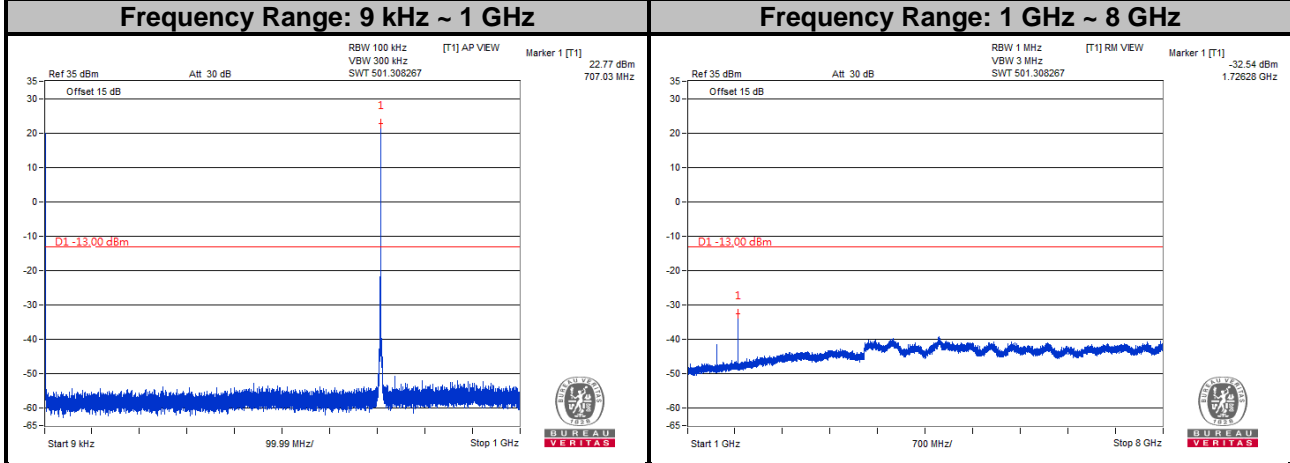

Channel 23173

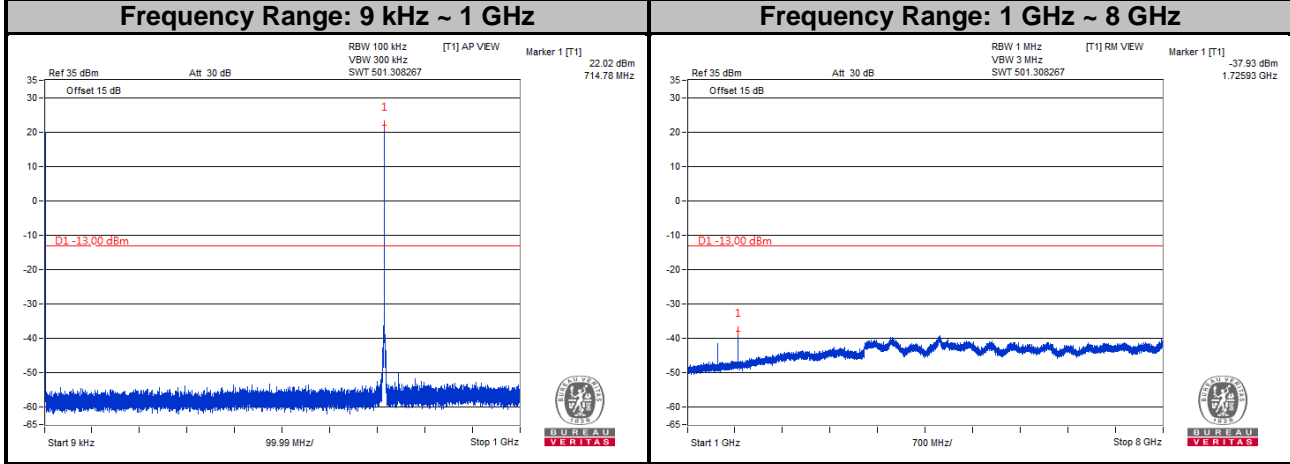

Note: The signal over the limit in 9 kHz is from spectrum analyzer.

LTE Band 12
Channel Bandwidth: 3 MHz
Channel 23025

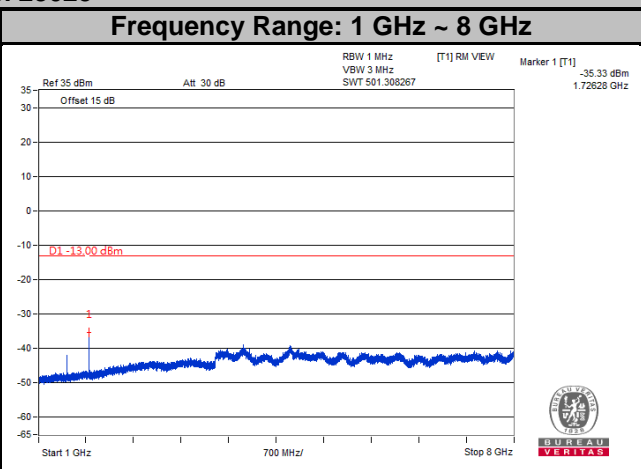
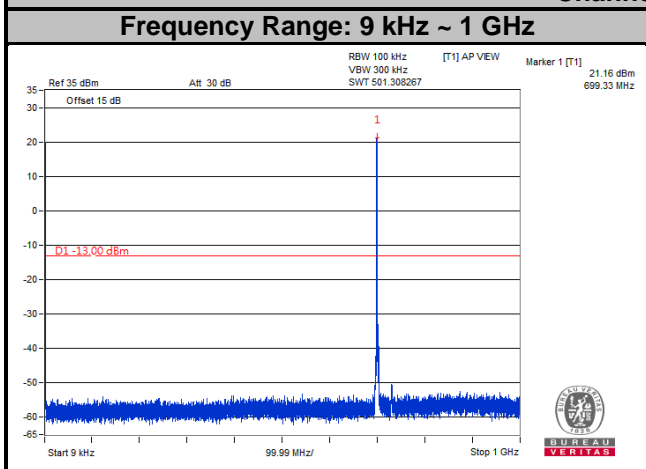

Channel 23095

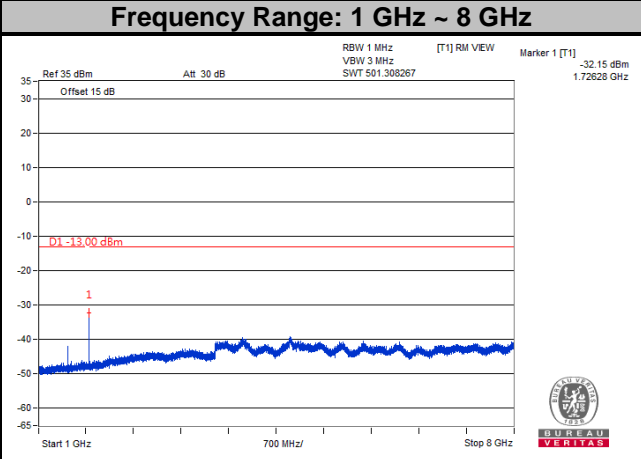
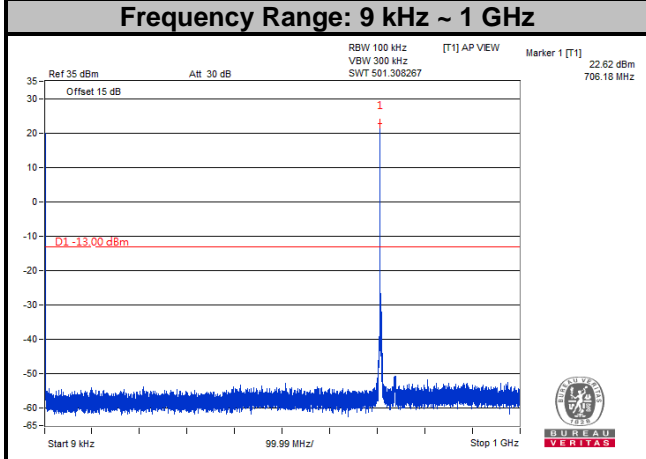

Channel 23165

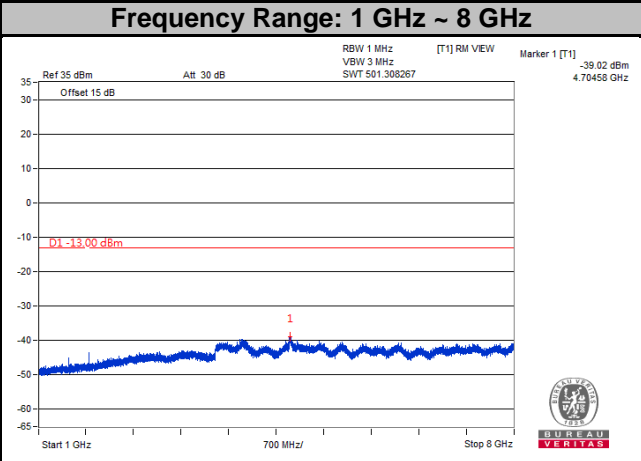
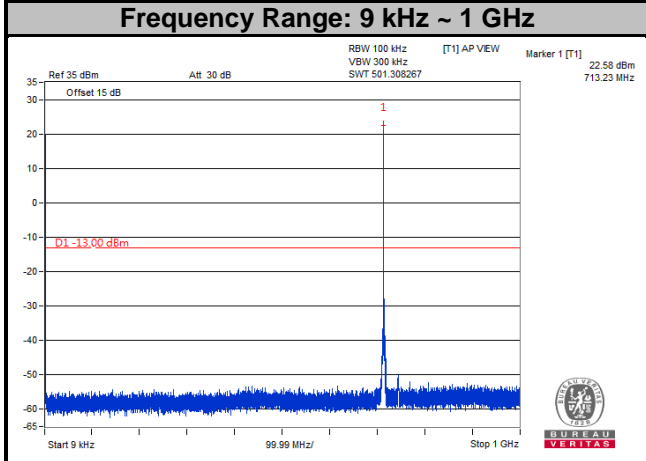

Note: The signal over the limit in 9 kHz is from spectrum analyzer.

LTE Band 12
Channel Bandwidth: 5 MHz
Channel 23035

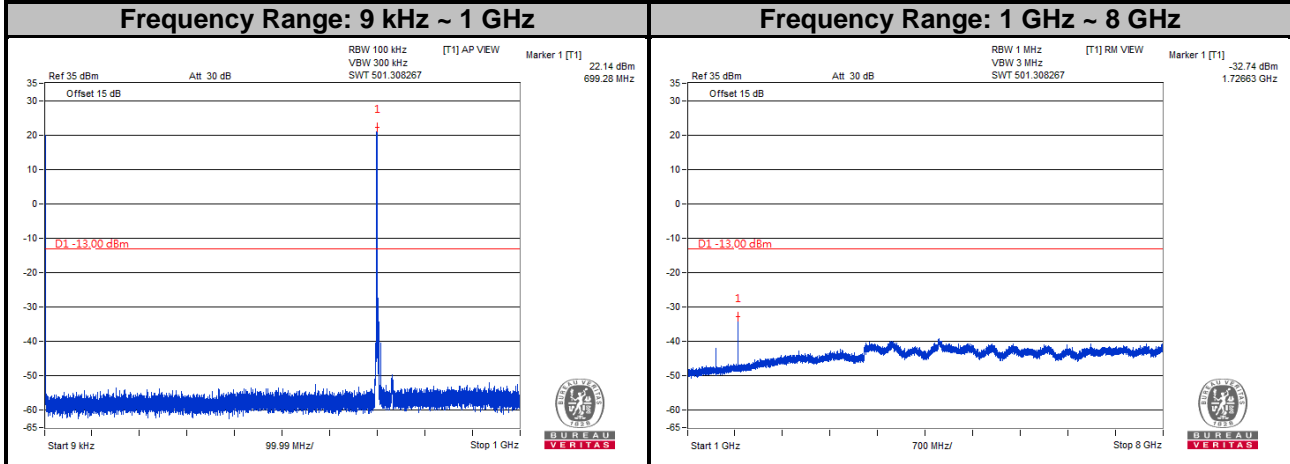

Channel 23095

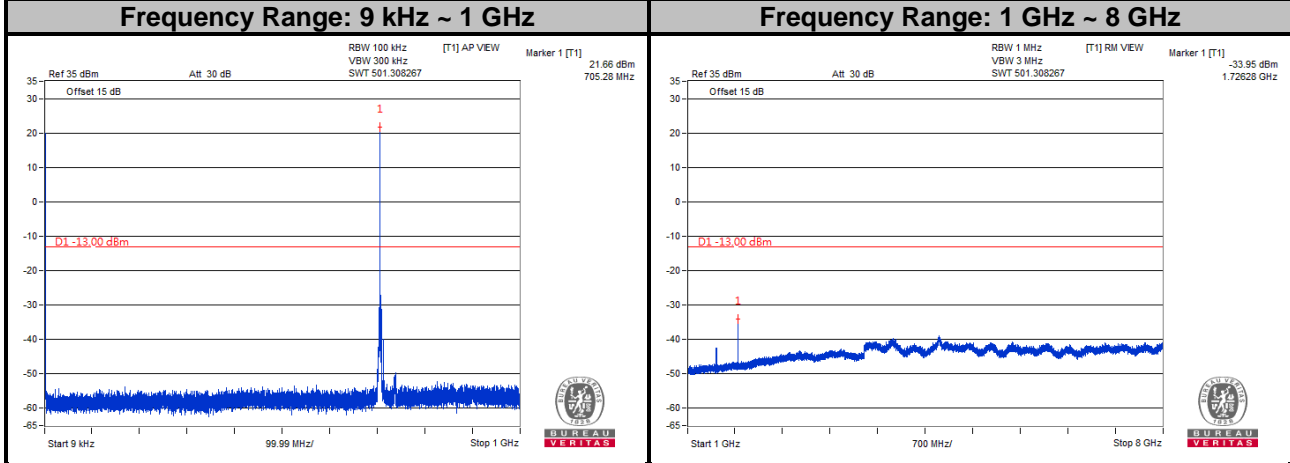

Channel 23155

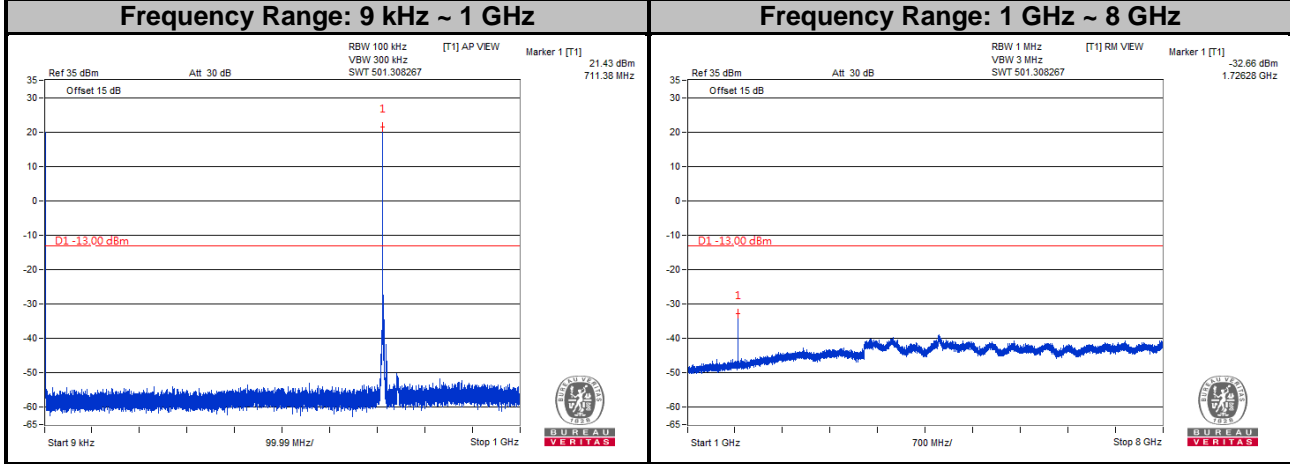

Note: The signal over the limit in 9 kHz is from spectrum analyzer.

LTE Band 12
Channel Bandwidth: 10 MHz
Channel 23060

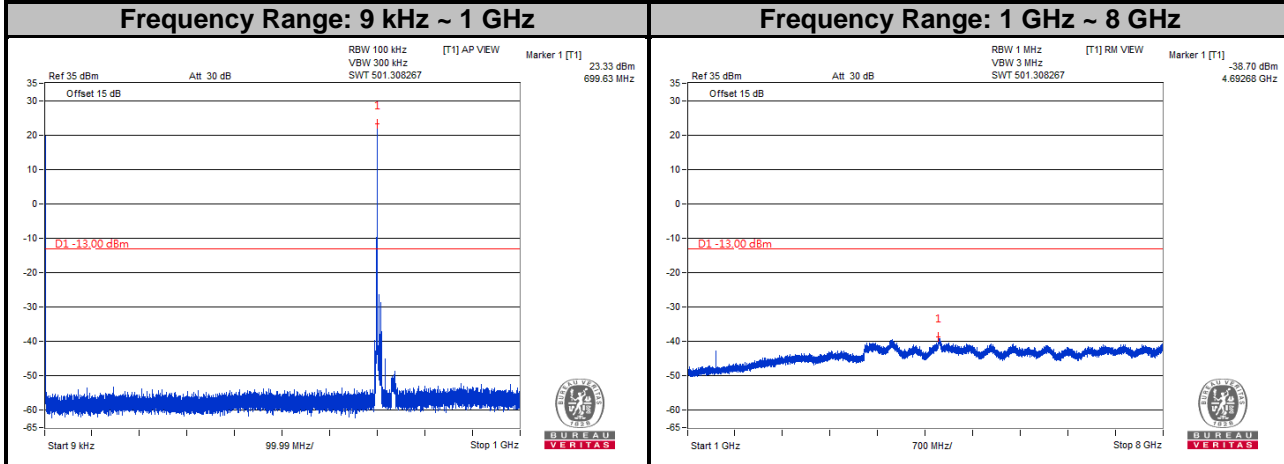

Channel 23095

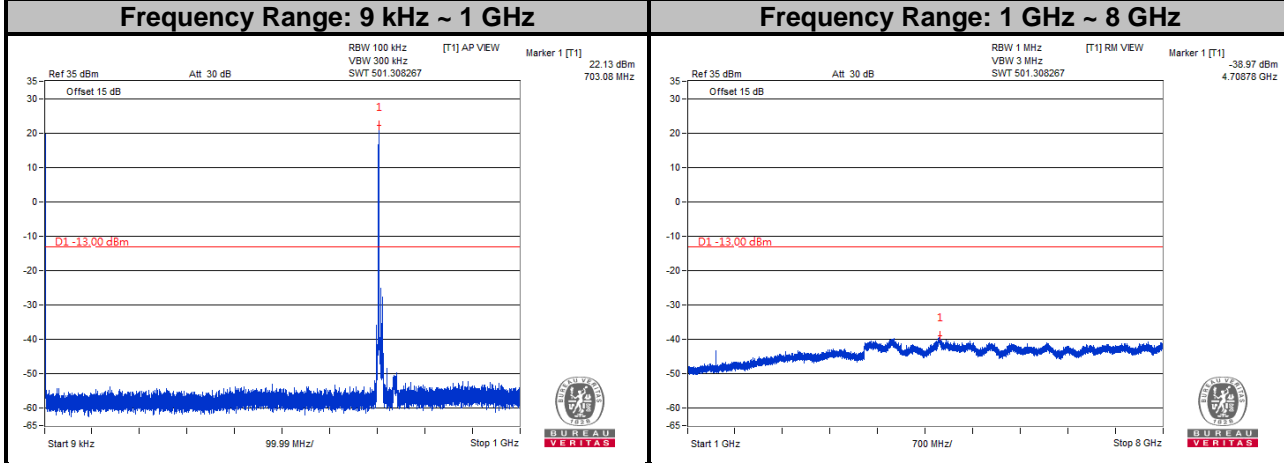

Channel 23130

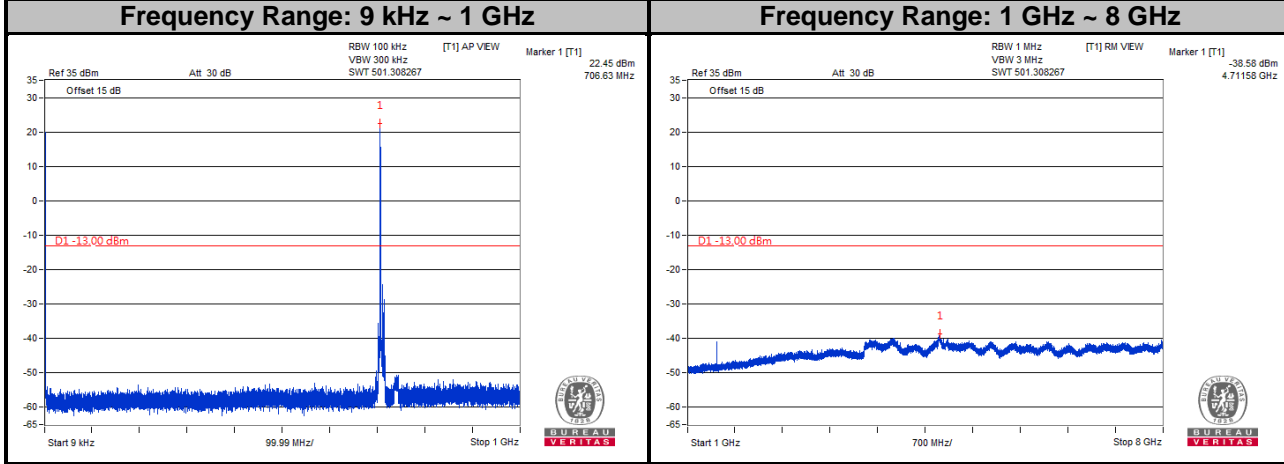

Note: The signal over the limit in 9 kHz is from spectrum analyzer.

LTE Band 13

Channel Bandwidth: 5 MHz

Channel 23205

Frequency Range: 9 kHz ~ 1 GHz

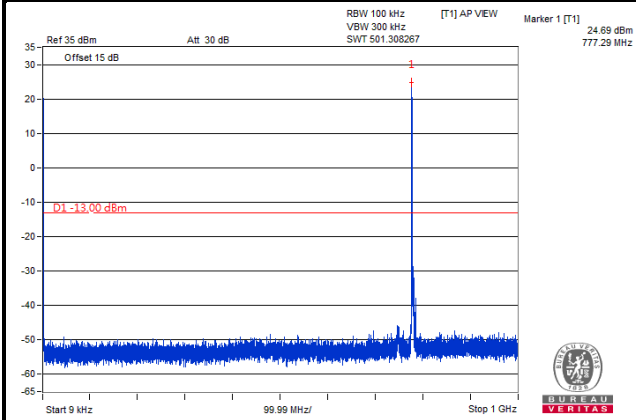

Frequency Range: 1 GHz ~ 1.559 GHz

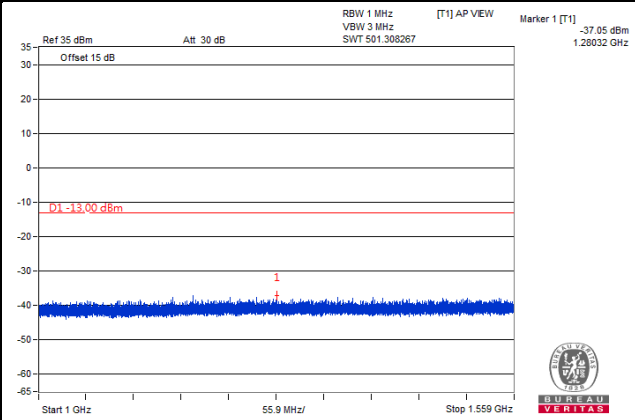

Frequency Range: 1.559 GHz ~ 1.61 GHz

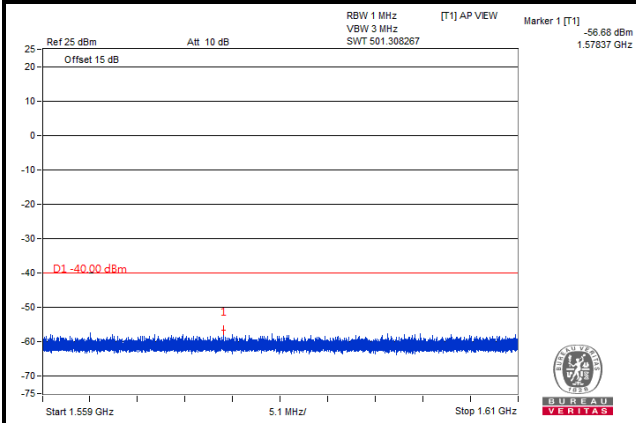

Frequency Range: 1.61 GHz ~ 8 GHz

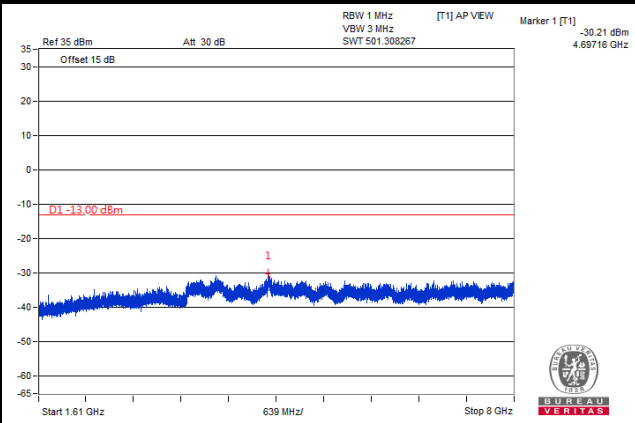

Note: The signal over the limit in 9 kHz is from spectrum analyzer.

LTE Band 13

Channel Bandwidth: 5 MHz

Channel 23230

Frequency Range: 9 kHz ~ 1 GHz

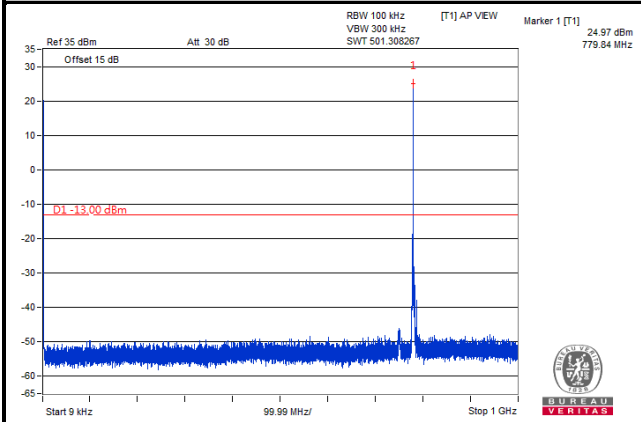

Frequency Range: 1 GHz ~ 1.559 GHz

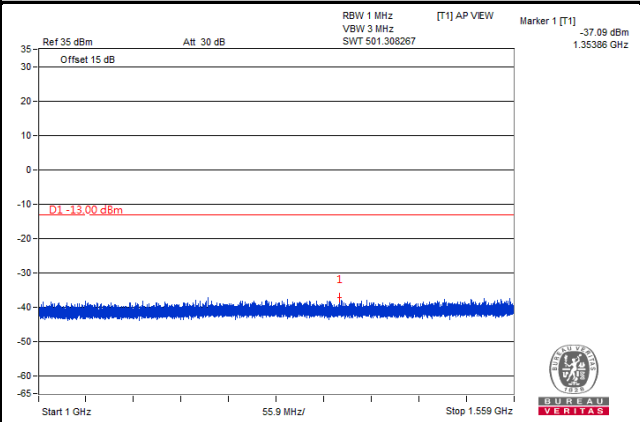

Frequency Range: 1.559 GHz ~ 1.61 GHz

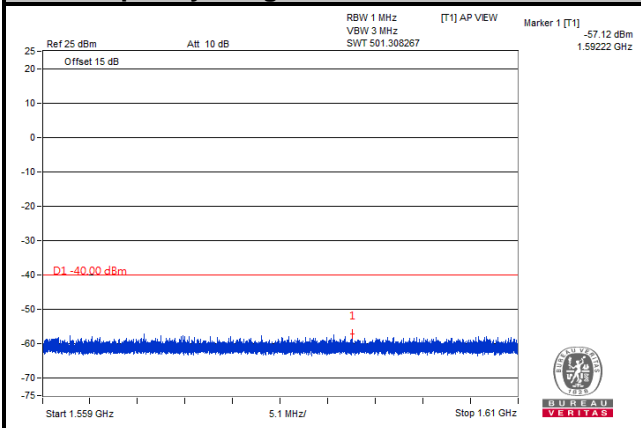

Frequency Range: 1.61 GHz ~ 8 GHz

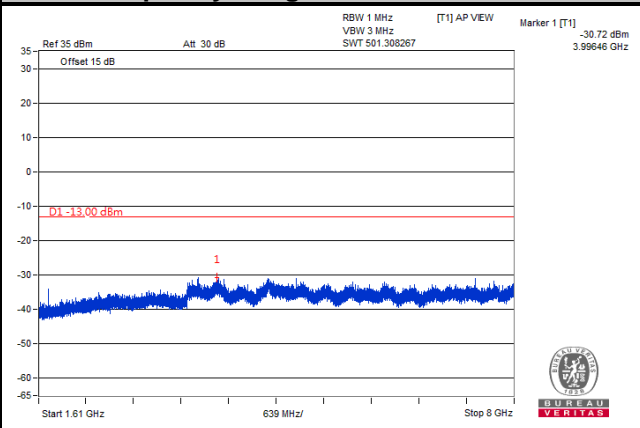

Note: The signal over the limit in 9 kHz is from spectrum analyzer.

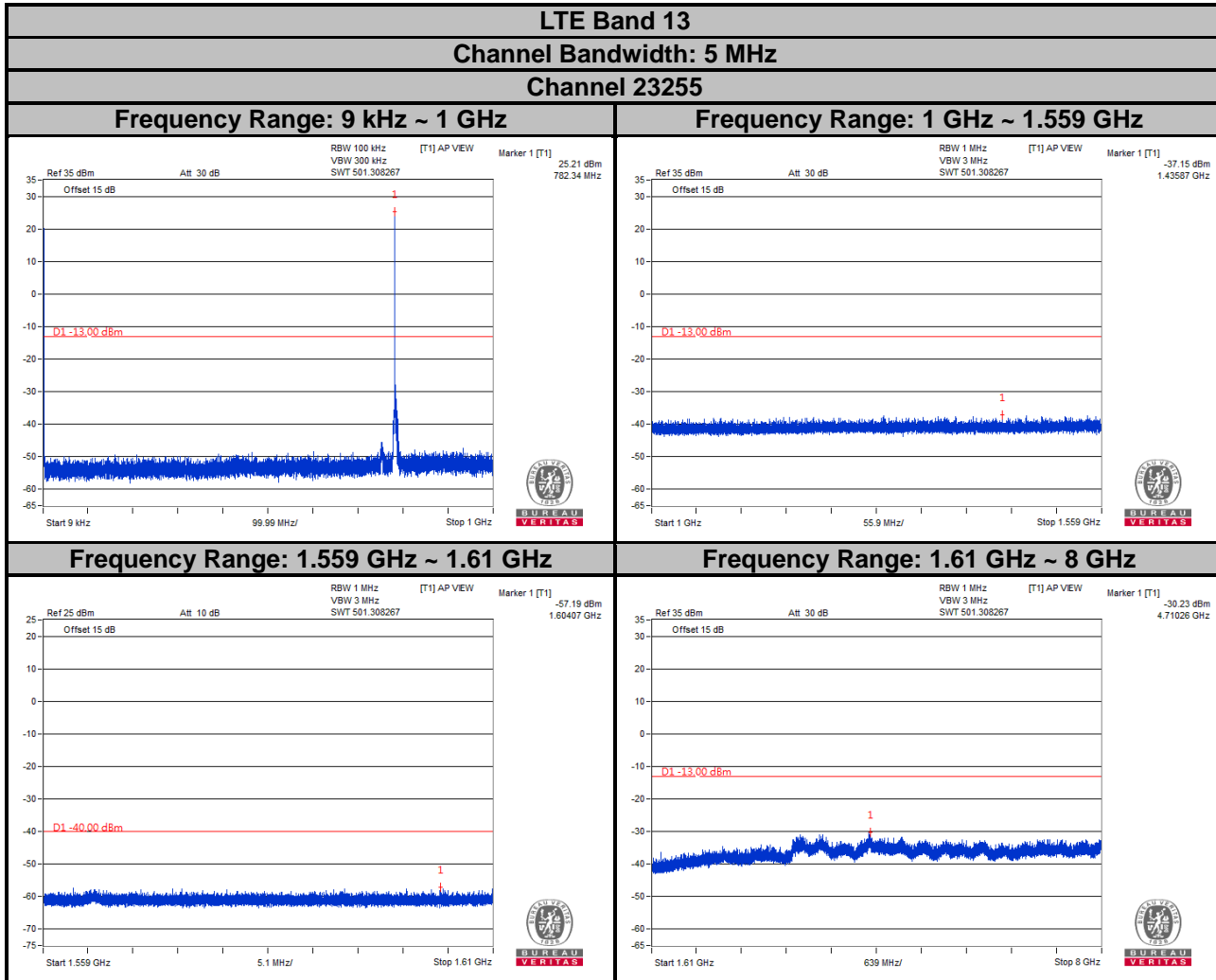

Note: The signal over the limit in 9 kHz is from spectrum analyzer.

LTE Band 13

Channel Bandwidth: 10 MHz

Channel 23230

Frequency Range: 9 kHz ~ 1 GHz

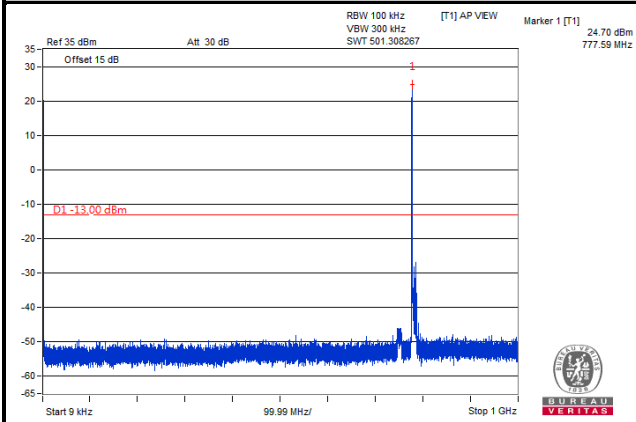

Frequency Range: 1 GHz ~ 1.559 GHz

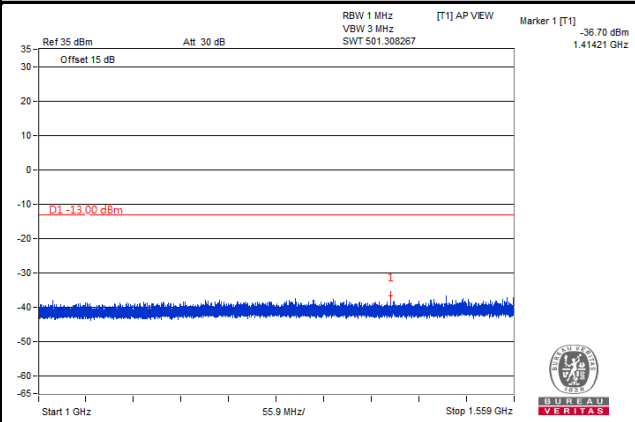

Frequency Range: 1.559 GHz ~ 1.61 GHz

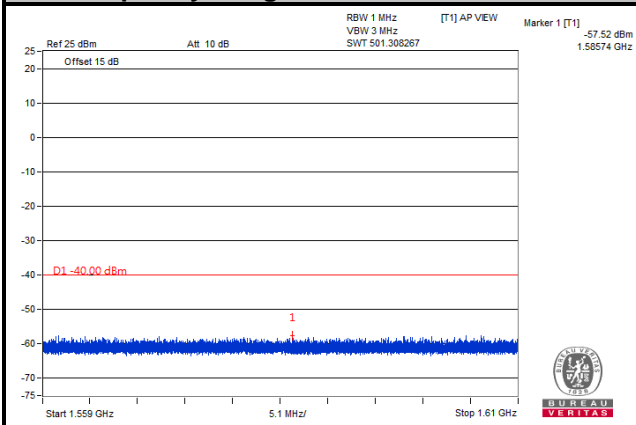

Frequency Range: 1.61 GHz ~ 8 GHz

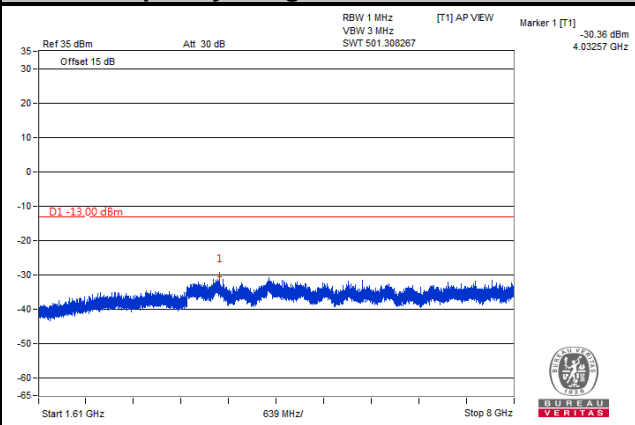

Note: The signal over the limit in 9 kHz is from spectrum analyzer.

4.8 Radiated Emission Measurement

4.8.1 Limits of Radiated Emission Measurement

- a. The power of any emission outside a licensee's frequency block shall be attenuated below the transmitter power (P) by at least $43 + 10 \log (P)$ dB. The limit of emission is equal to -13 dBm.
- b. For operations in the 775-788 MHz, emissions in the band 1559-1610 MHz shall be limited to -70 dBW/MHz. The limit of emissions is equal to -40 dBm.

4.8.2 Test Procedure

- a. Substitution method is used for E.I.R.P measurement. In the semi-anechoic chamber, EUT placed on the 0.8 m (below or equal 1 GHz) and/or 1.5 m (above 1 GHz) height of Turn Table, rotated the table around 360 degrees to search the maximum radiation power and receiver antenna shall be rotated vertical and horizontal polarization and moved height from 1 m to 4 m to find the maximum polar radiated power. The "Read Value" is the spectrum reading the maximum power value.
- b. The substitution horn antenna is substituted for EUT at the same position and signals generator export the CW signal to the substitution antenna via a TX cable. Rotated the Turn Table and moved receiving antenna to find the maximum radiation power. Adjust output power level of S.G to get a Value of spectrum reading equal to "Read Value" of step a. Record the power level of S.G.
- c. $EIRP = \text{Output power level of S.G} - \text{TX cable loss} + \text{Antenna gain of substitution horn}$.
- d. E.R.P power can be calculated form E.I.R.P power by subtracting the gain of dipole, $E.R.P \text{ power} = E.I.R.P \text{ power} - 2.15 \text{ dB}$.

Note: The resolution bandwidth of spectrum analyzer is 1 MHz and the video bandwidth is 3 MHz.

4.8.3 Deviation from Test Standard

No deviation.

4.8.4 Test Setup

<Radiated Emission below or equal 1 GHz>

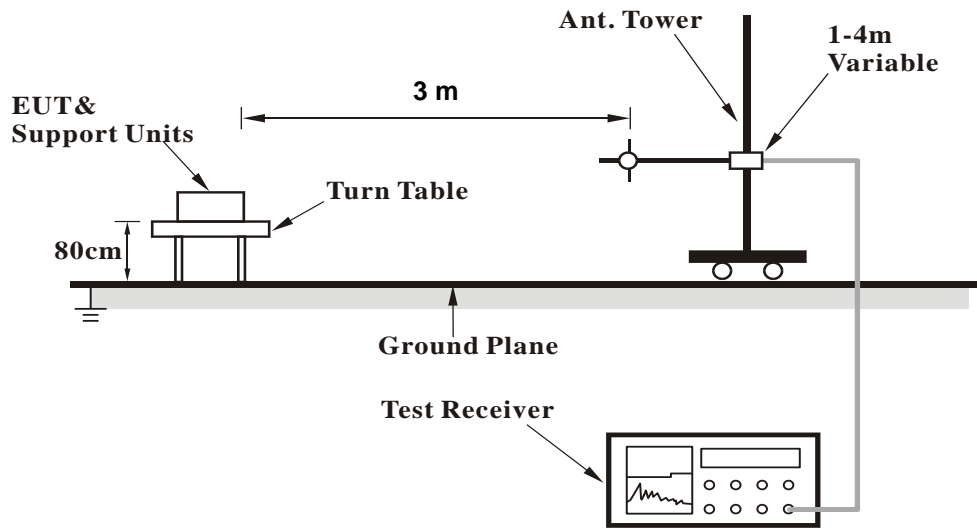

<Radiated Emission above 1 GHz>

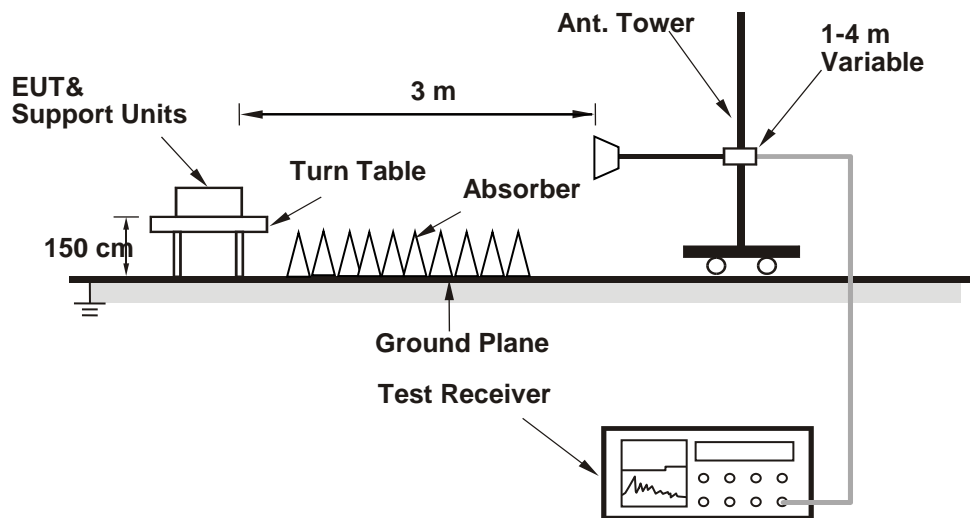

For the actual test configuration, please refer to the attached file (Test Setup Photo).

4.8.5 Test Results

WCDMA:
Low Channel



Bureau Veritas Consumer Products Services Ltd., Taoyuan Branch

A D T

Data: 3

Date: 2019-02-16

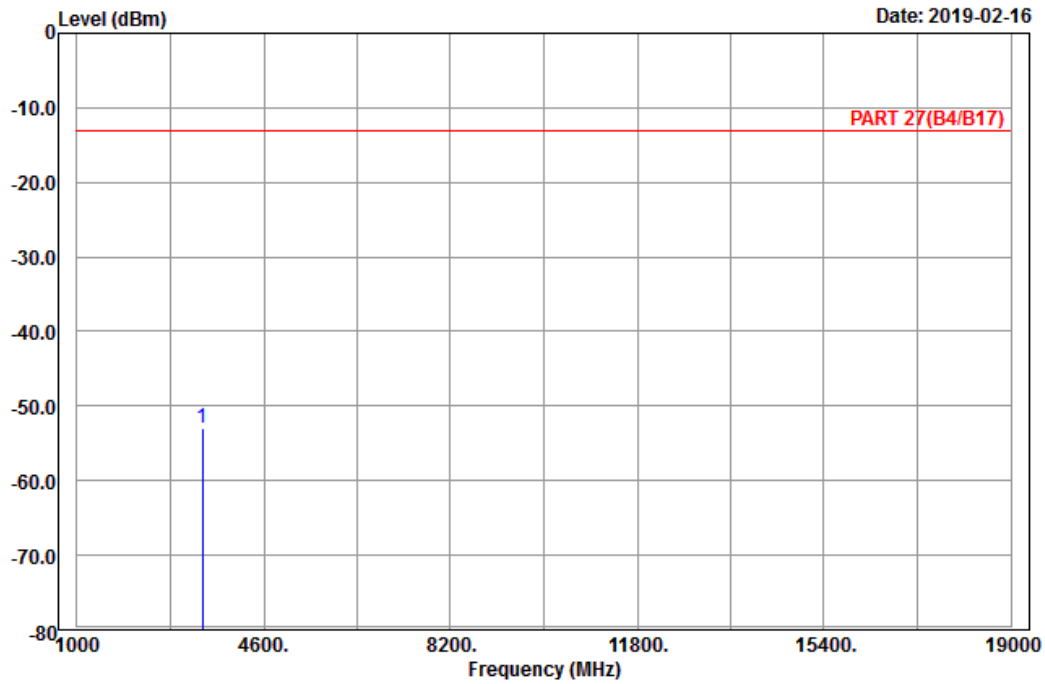

Site : 966 chamber 1
Condition: PART 27(B4/B17) Horizontal
Remark : Band IV_Link_CH1312
Tested by: Karl Lee

	Read	Limit	Over			
Freq	Level	Level	Line	Limit	Factor	Remark
MHz	dBm	dBm	dBm	dB	dB	
1 pp 3424.80	-52.91	-67.28	-13.00	-39.91	14.37	Peak



Bureau Veritas Consumer Products Services Ltd., Taoyuan Branch

A D T

Data: 4

Date: 2019-02-16

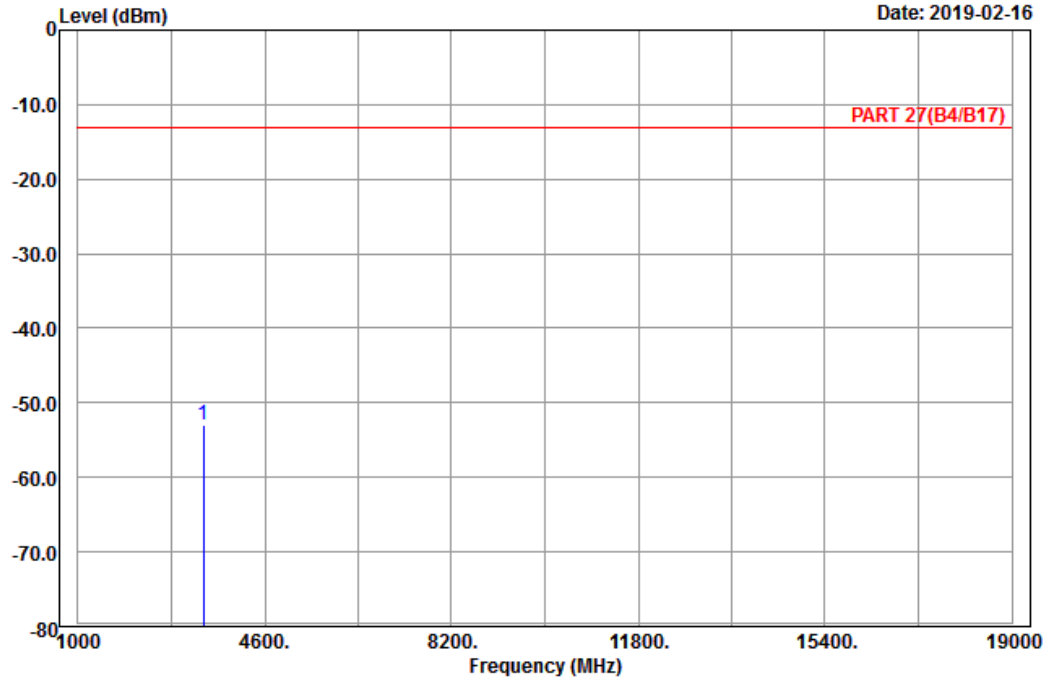

Site : 966 chamber 1
 Condition: PART 27(B4/B17) Vertical
 Remark : Band IV_Link_CH1312
 Tested by: Karl Lee

	Read	Limit	Over			
Freq	Level	Level	Line	Limit	Factor	Remark
MHz	dBm	dBm	dBm	dB	dB	
1 pp 3424.80	-52.92	-67.29	-13.00	-39.92	14.37	Peak

Middle Channel



Bureau Veritas Consumer Products Services Ltd., Taoyuan Branch

A D T

Data: 3

Date: 2019-02-16

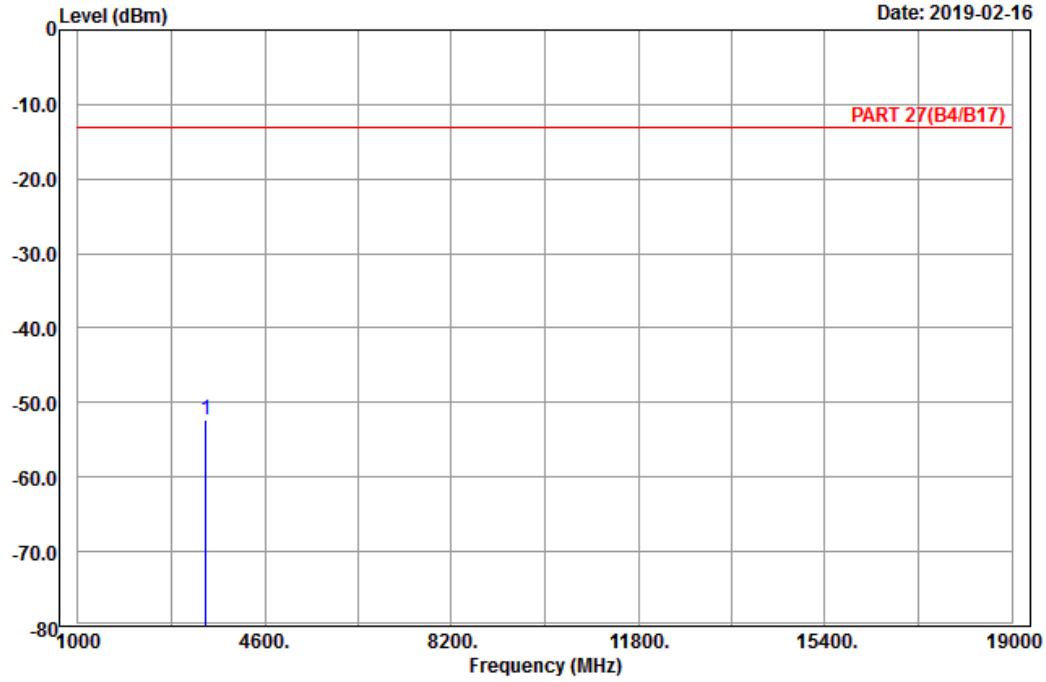

Site : 966 chamber 1
 Condition: PART 27(B4/B17) Horizontal
 Remark : Band IV_Link_CH1413
 Tested by: Karl Lee

Freq	Level	Read Level	Limit Line	Over Limit	Factor	Remark
MHz	dBm	dBm	dBm	dB	dB	
1 pp 3465.20	-52.30	-66.64	-13.00	-39.30	14.34	Peak



Bureau Veritas Consumer Products Services Ltd., Taoyuan Branch

A D T

Data: 4

Date: 2019-02-16

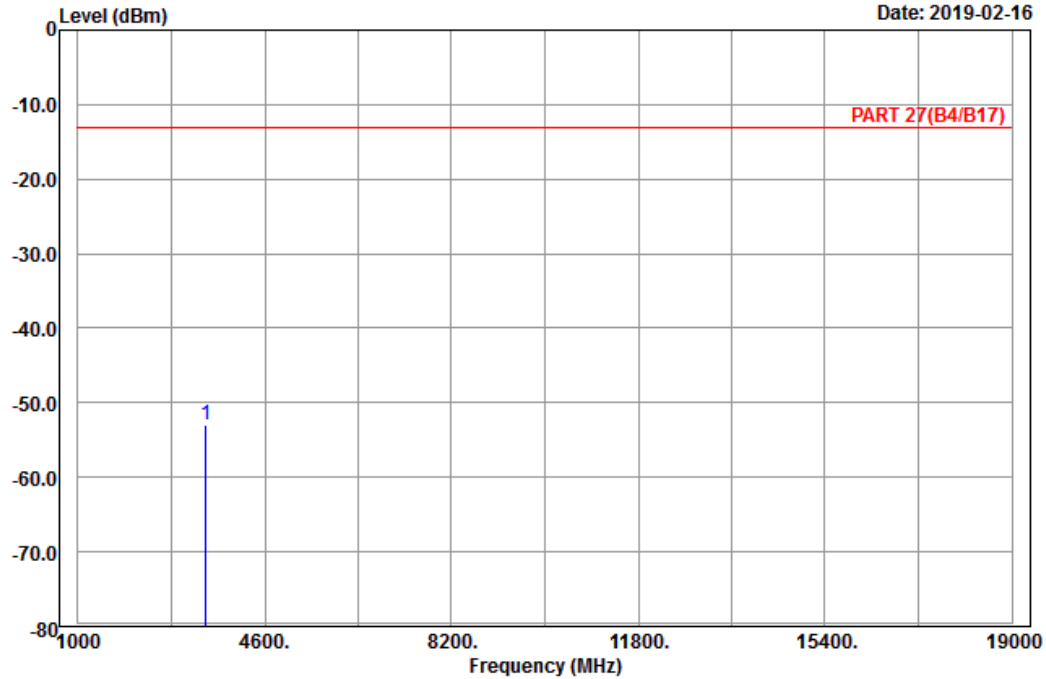

Site : 966 chamber 1
 Condition: PART 27(B4/B17) Vertical
 Remark : Band IV_Link_CH1413
 Tested by: Karl Lee

	Read	Limit	Over			
Freq	Level	Level	Line	Limit	Factor	Remark
MHz	dBm	dBm	dBm	dB	dB	
1 pp 3465.20	-52.89	-67.23	-13.00	-39.89	14.34	Peak

High Channel



Bureau Veritas Consumer Products Services Ltd., Taoyuan Branch

A D T

Data: 7

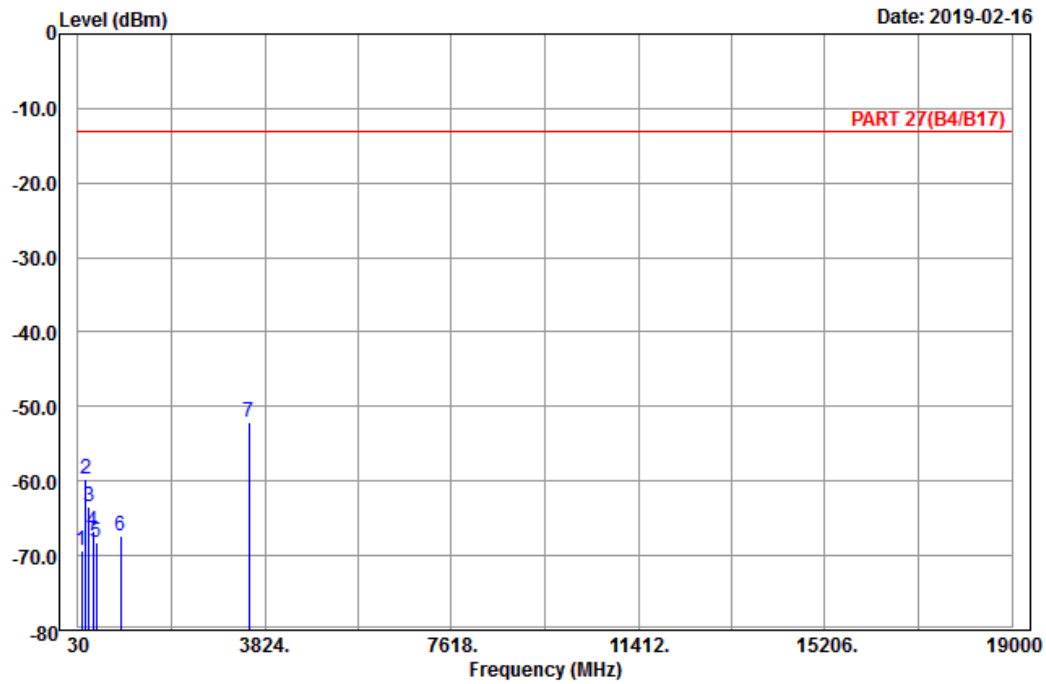

Site : 966 chamber 1
 Condition: PART 27(B4/B17) Horizontal
 Remark : Band IV_Link_CH1513
 Tested by: Karl Lee

	Freq	Level	Read Level	Limit Line	Over Limit	Factor	Remark
	MHz	dBm	dBm	dBm	dB	dB	
1	100.74	-69.27	-59.27	-13.00	-56.27	-10.00	Peak
2	191.46	-59.67	-53.89	-13.00	-46.67	-5.78	Peak
3	254.37	-63.33	-57.79	-13.00	-50.33	-5.54	Peak
4	342.70	-66.67	-61.20	-13.00	-53.67	-5.47	Peak
5	402.90	-68.25	-65.45	-13.00	-55.25	-2.80	Peak
6	900.60	-67.26	-70.19	-13.00	-54.26	2.93	Peak
7 pp	3505.20	-52.18	-66.46	-13.00	-39.18	14.28	Peak



Bureau Veritas Consumer Products Services Ltd., Taoyuan Branch

A D T

Data: 8

Date: 2019-02-16

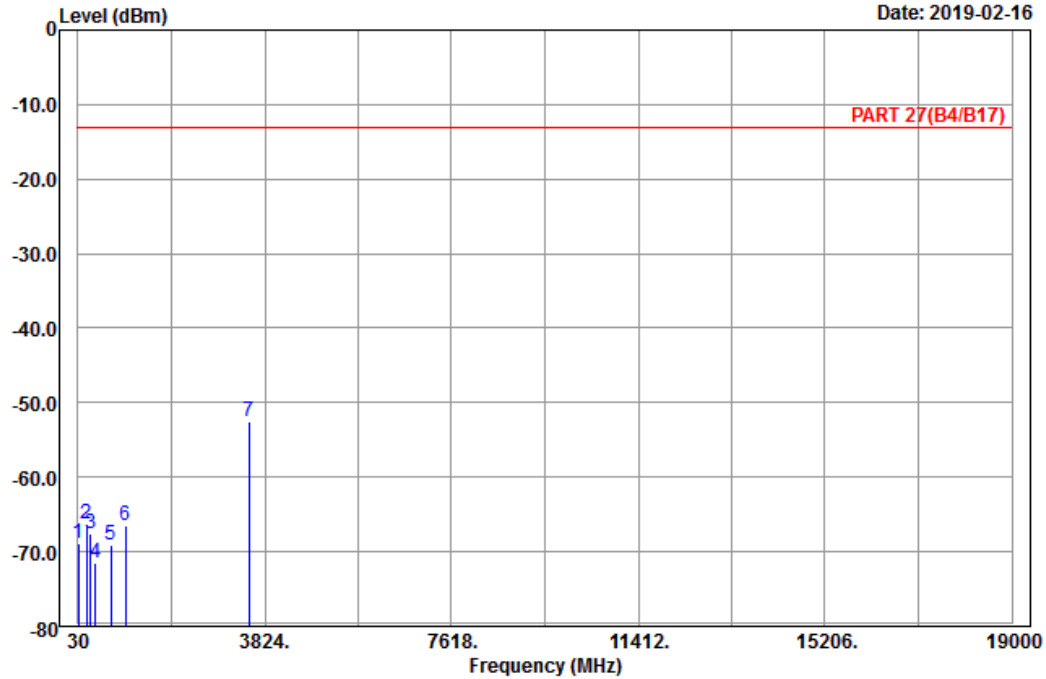

Site : 966 chamber 1
 Condition: PART 27(B4/B17) Vertical
 Remark : Band IV_Link_CH1513
 Tested by: Karl Lee

	Freq	Level	Read Level	Limit Line	Over Limit	Factor	Remark
	MHz	dBm	dBm	dBm	dB	dB	
1	34.05	-68.93	-57.95	-13.00	-55.93	-10.98	Peak
2	197.94	-66.33	-60.24	-13.00	-53.33	-6.09	Peak
3	288.93	-67.63	-61.77	-13.00	-54.63	-5.86	Peak
4	381.20	-71.51	-67.79	-13.00	-58.51	-3.72	Peak
5	705.30	-69.13	-68.66	-13.00	-56.13	-0.47	Peak
6	998.60	-66.54	-71.80	-13.00	-53.54	5.26	Peak
7 pp	3505.20	-52.62	-66.90	-13.00	-39.62	14.28	Peak

LTE Band 4
 Channel Bandwidth: 1.4 MHz / QPSK
 Low Channel



Bureau Veritas Consumer Products Services Ltd., Taoyuan Branch

A D T

Data: 9

Date: 2019-02-14

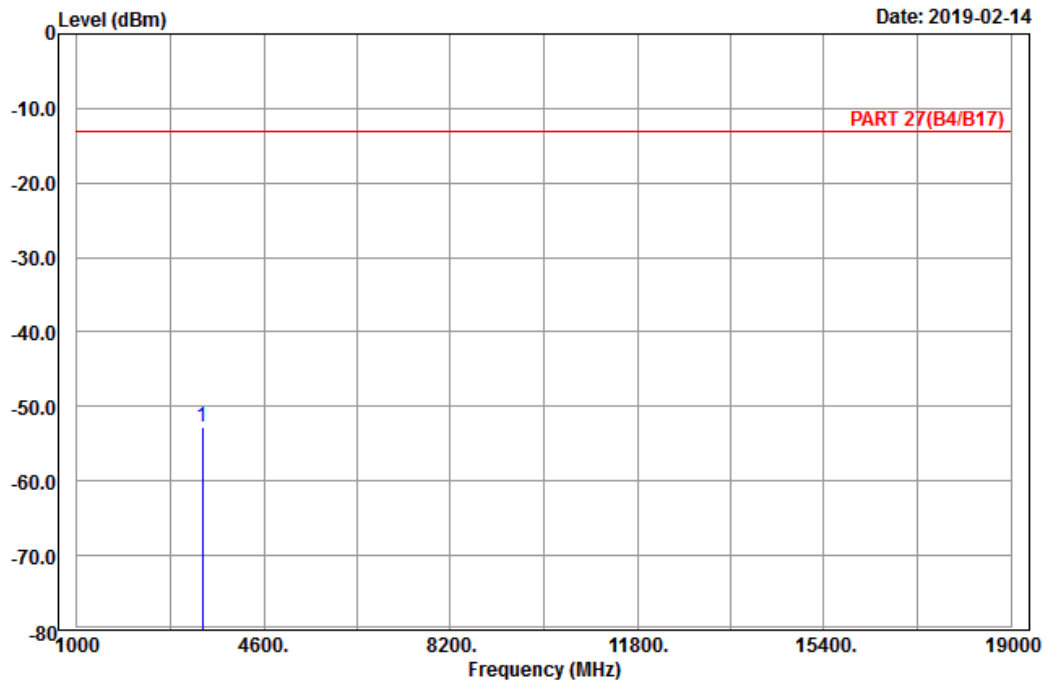

Site : 966 chamber 1
 Condition: PART 27(B4/B17) Horizontal
 Remark : LTE_Band 4_Link_CH19957
 Tested by: Karl Lee

	Read	Limit	Over		
Freq	Level	Level	Line	Limit	Factor Remark
MHz	dBm	dBm	dBm	dB	dB
1 pp 3421.40	-52.69	-67.06	-13.00	-39.69	14.37 Peak



Bureau Veritas Consumer Products Services Ltd., Taoyuan Branch

A D T

Data: 10

Date: 2019-02-14

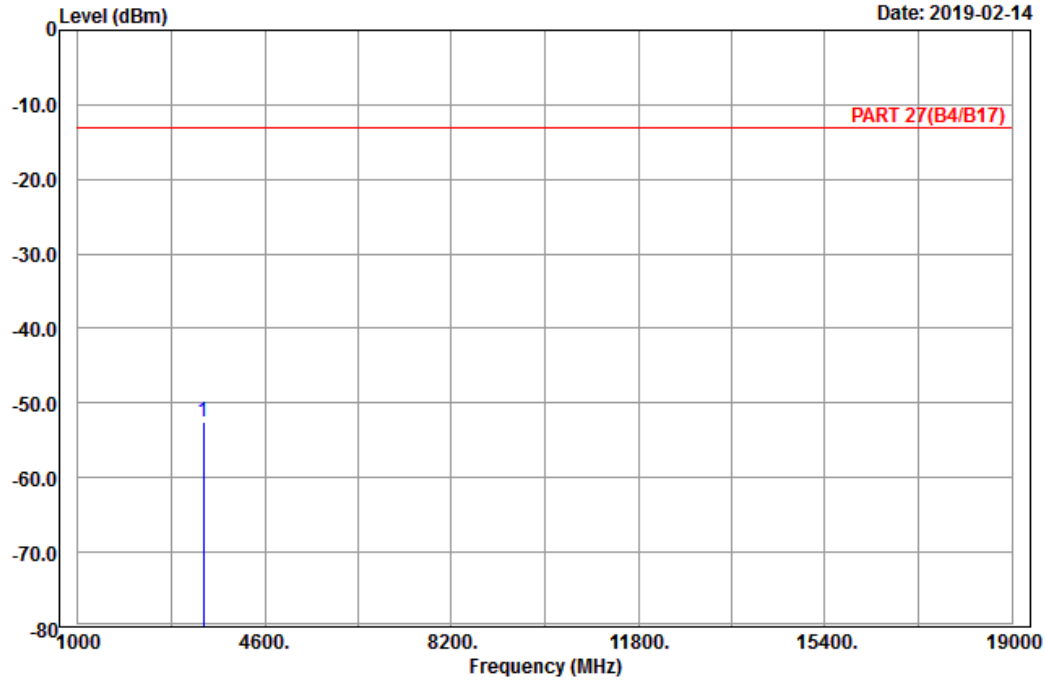

Site : 966 chamber 1
 Condition: PART 27(B4/B17) Vertical
 Remark : LTE_Band 4_Link_CH19957
 Tested by: Karl Lee

	Read	Limit	Over		
Freq	Level	Level	Line	Limit	Factor
MHz	dBm	dBm	dBm	dB	dB
1 pp 3421.40	-52.63	-67.00	-13.00	-39.63	14.37

Middle Channel



Bureau Veritas Consumer Products Services Ltd., Taoyuan Branch

A D T

Data: 9

Date: 2019-02-14

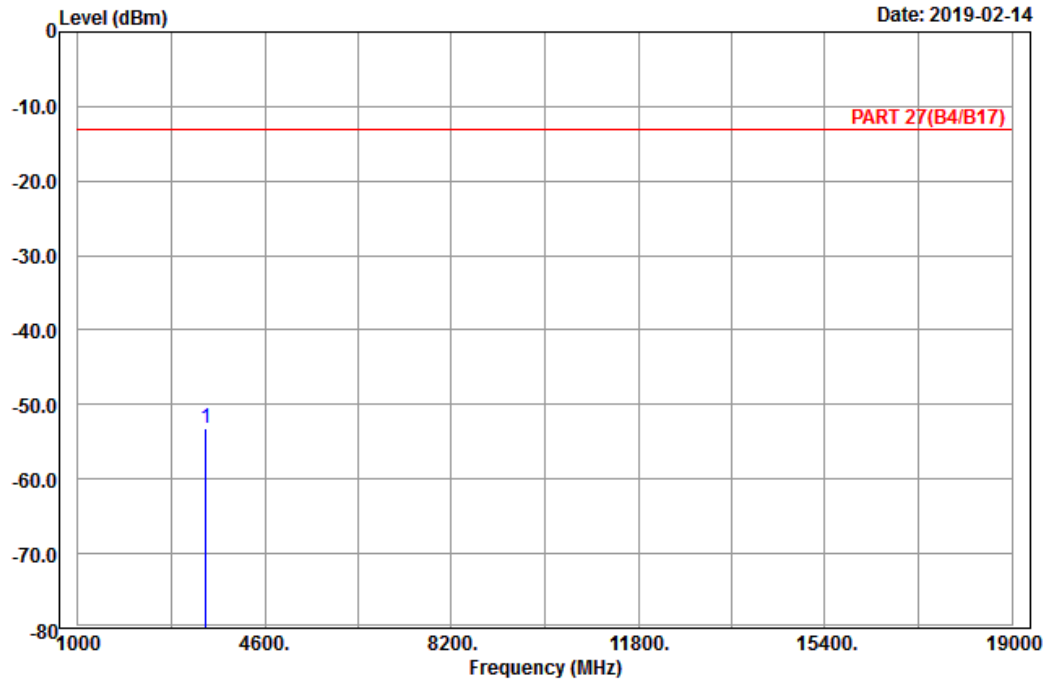

Site : 966 chamber 1
 Condition: PART 27(B4/B17) Horizontal
 Remark : LTE_Band 4_Link_CH20175
 Tested by: Karl Lee

Freq	Level	Read Level	Limit Line	Over Limit	Factor	Remark
MHz	dBm	dBm	dBm	dB	dB	
1 pp 3465.00	-53.28	-67.62	-13.00	-40.28	14.34	Peak



Bureau Veritas Consumer Products Services Ltd., Taoyuan Branch

A D T

Data: 10

Date: 2019-02-14

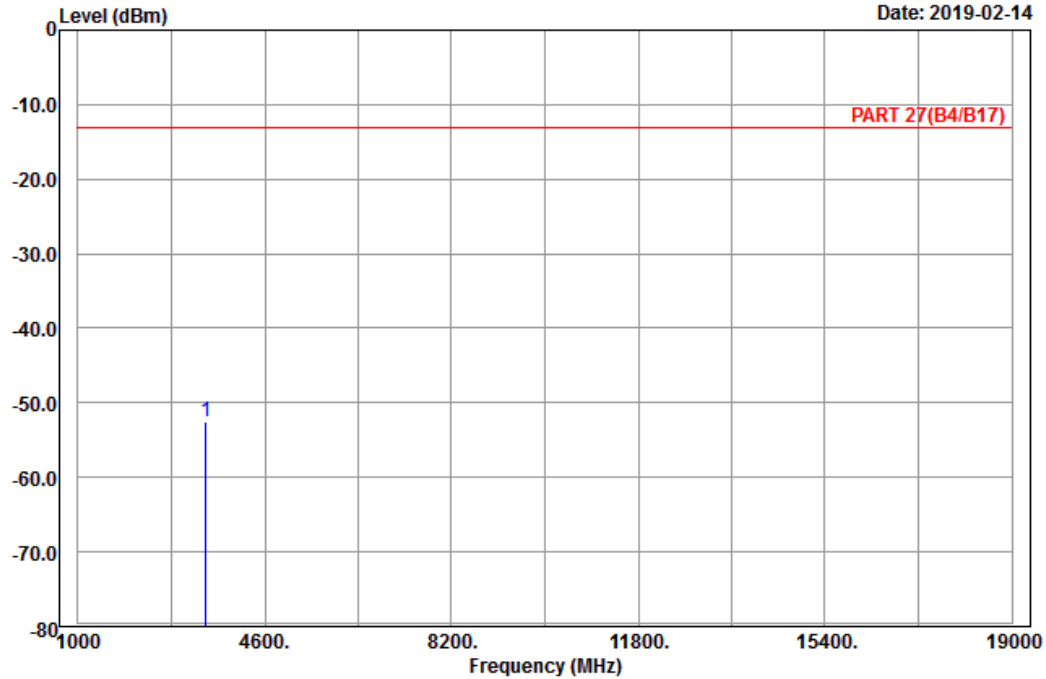

Site : 966 chamber 1
 Condition: PART 27(B4/B17) Vertical
 Remark : LTE_Band 4_Link_CH20175
 Tested by: Karl Lee

	Read	Limit	Over			
Freq	Level	Level	Line	Limit	Factor	Remark
MHz	dBm	dBm	dBm	dB	dB	
1 pp 3465.00	-52.43	-66.77	-13.00	-39.43	14.34	Peak

High Channel



Bureau Veritas Consumer Products Services Ltd., Taoyuan Branch

A D T

Data: 9

Date: 2019-02-14

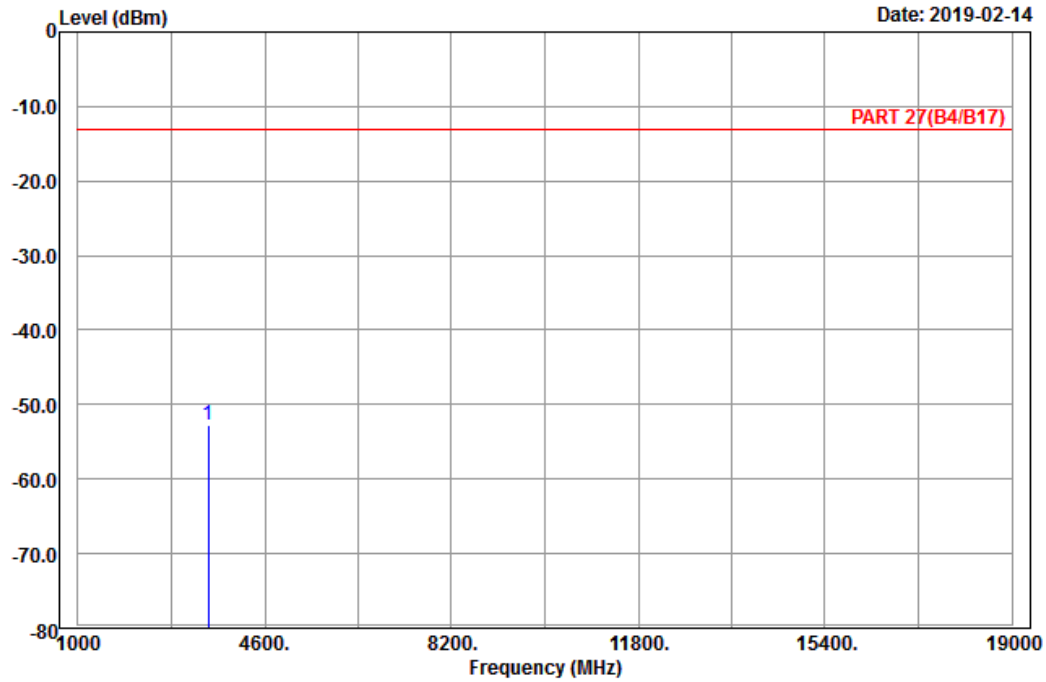

Site : 966 chamber 1
 Condition: PART 27(B4/B17) Horizontal
 Remark : LTE_Band 4_Link_CH20393
 Tested by: Karl Lee

Freq	Level	Read Level	Limit Line	Over Limit	Factor	Remark
MHz	dBm	dBm	dBm	dB	dB	
1 pp 3508.60	-52.83	-67.11	-13.00	-39.83	14.28	Peak



Bureau Veritas Consumer Products Services Ltd., Taoyuan Branch

A D T

Data: 10

Date: 2019-02-14

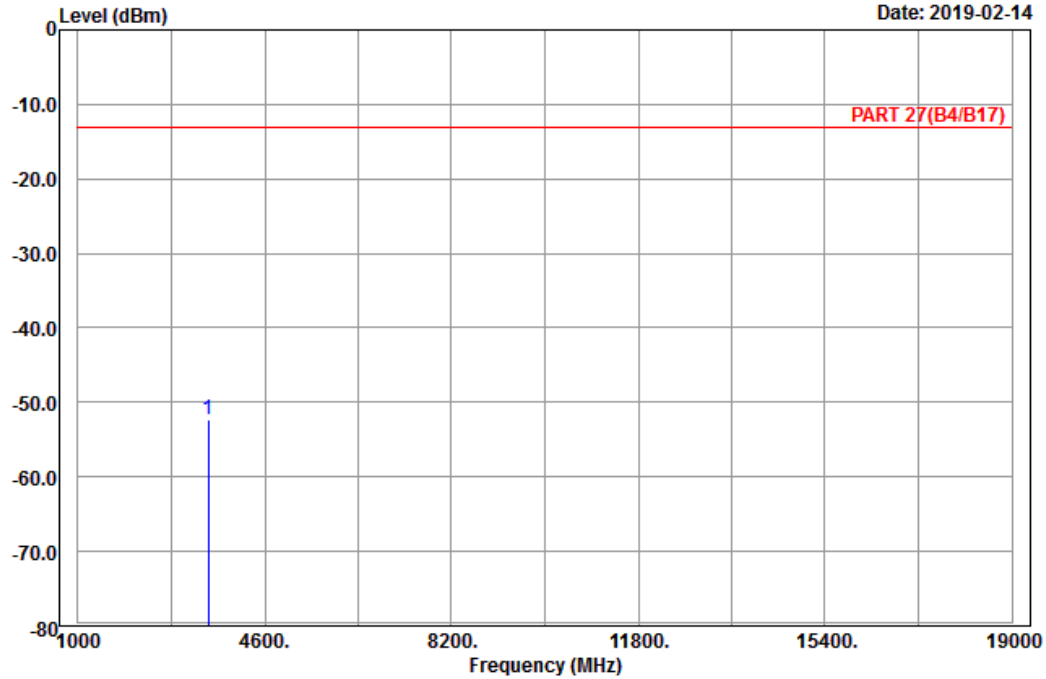

Site : 966 chamber 1
 Condition: PART 27(B4/B17) Vertical
 Remark : LTE_Band 4_Link_CH20393
 Tested by: Karl Lee

	Read	Limit	Over			
Freq	Level	Level	Line	Limit	Factor	Remark
MHz	dBm	dBm	dBm	dB	dB	
1 pp 3508.60	-52.32	-66.60	-13.00	-39.32	14.28	Peak

Channel Bandwidth: 5 MHz / QPSK
Low Channel



Bureau Veritas Consumer Products Services Ltd., Taoyuan Branch

A D T

Data: 9

Date: 2019-02-14

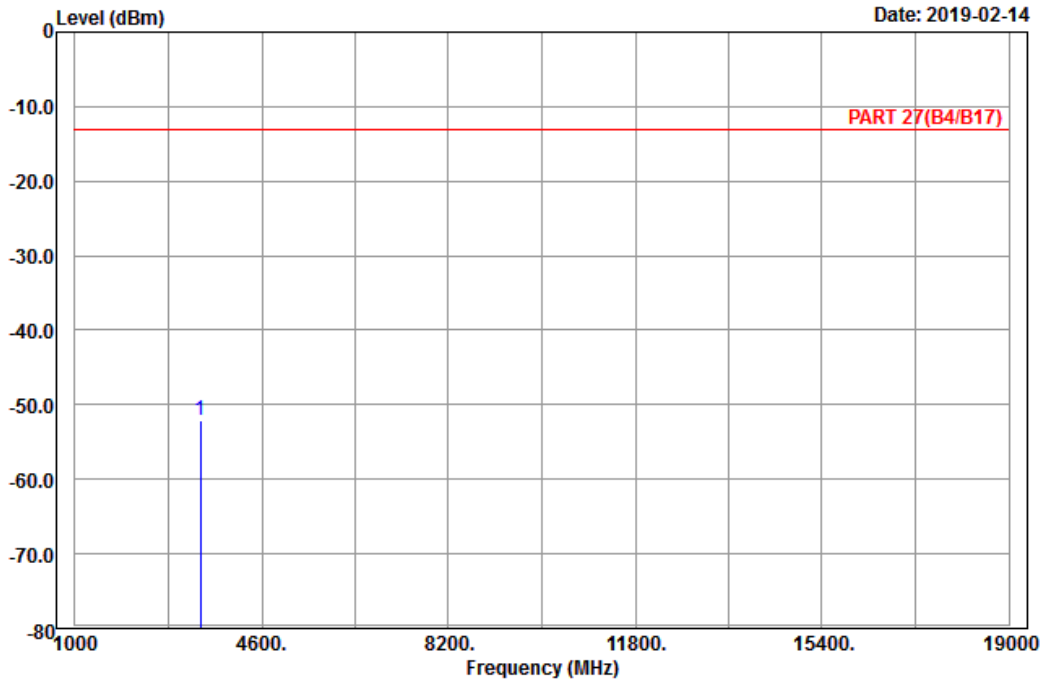

Site : 966 chamber 1
Condition: PART 27(B4/B17) Horizontal
Remark : LTE_Band 4_Link_CH19975
Tested by: Karl Lee

	Read	Limit	Over			
Freq	Level	Level	Line	Limit	Factor	Remark
MHz	dBm	dBm	dBm	dB	dB	
1 pp 3425.00	-52.01	-66.38	-13.00	-39.01	14.37	Peak



Bureau Veritas Consumer Products Services Ltd., Taoyuan Branch

A D T

Data: 10

Date: 2019-02-14

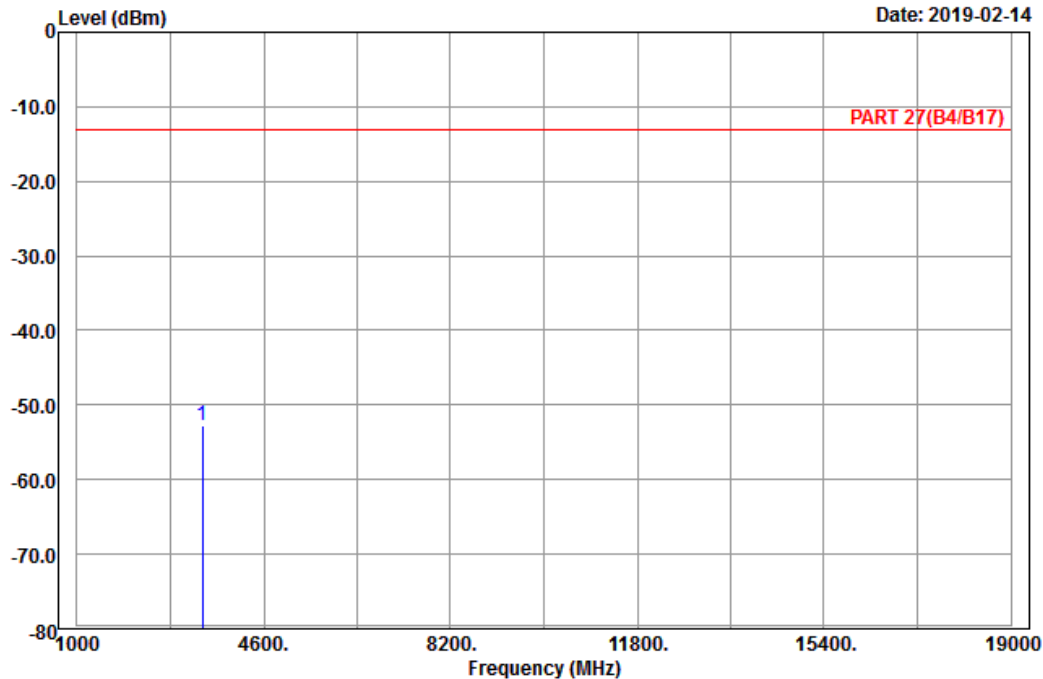

Site : 966 chamber 1
 Condition: PART 27(B4/B17) Vertical
 Remark : LTE_Band 4_Link_CH19975
 Tested by: Karl Lee

	Read	Limit	Over			
Freq	Level	Level	Line	Limit	Factor	Remark
MHz	dBm	dBm	dBm	dB	dB	
1 pp 3425.00	-52.77	-67.14	-13.00	-39.77	14.37	Peak

Middle Channel



Bureau Veritas Consumer Products Services Ltd., Taoyuan Branch

A D T

Data: 9

Date: 2019-02-14

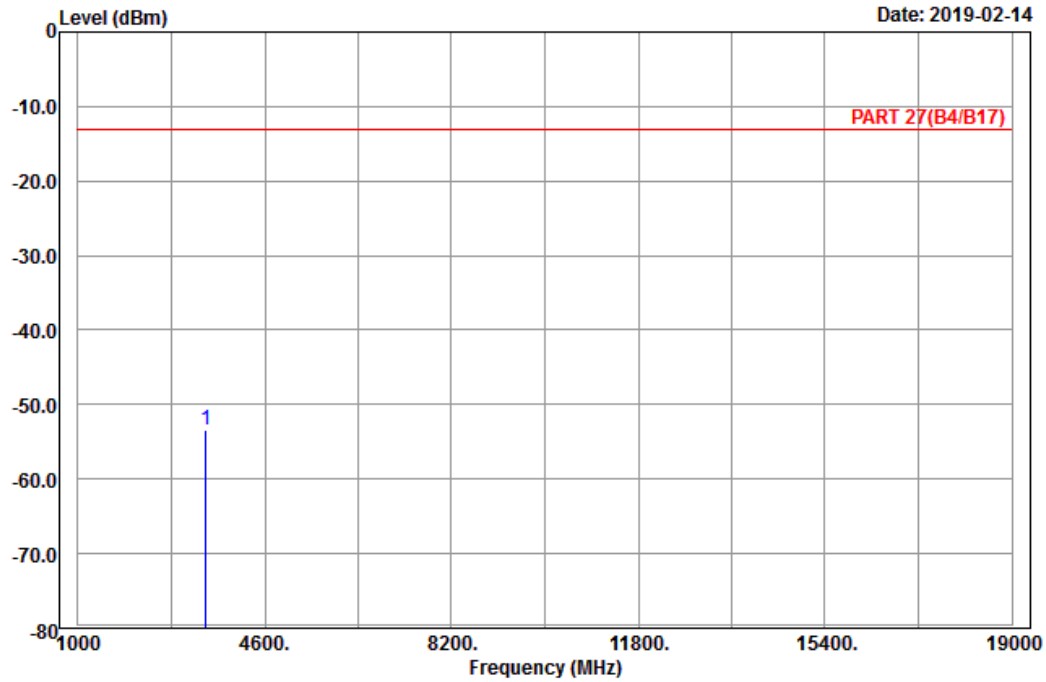

Site : 966 chamber 1
 Condition: PART 27(B4/B17) Horizontal
 Remark : LTE_Band 4_Link_CH20175
 Tested by: Karl Lee

Freq	Level	Read Level	Limit Line	Over Limit	Factor	Remark
MHz	dBm	dBm	dBm	dB	dB	
1 pp 3465.00	-53.35	-67.69	-13.00	-40.35	14.34	Peak



Bureau Veritas Consumer Products Services Ltd., Taoyuan Branch

A D T

Data: 10

Date: 2019-02-14

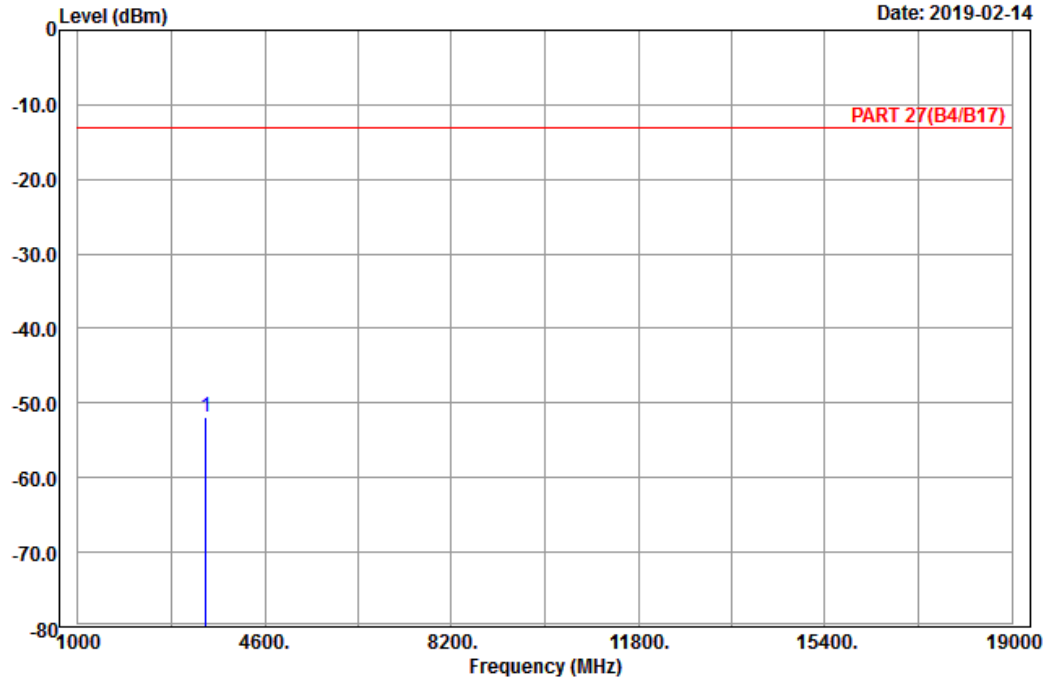

Site : 966 chamber 1
 Condition: PART 27(B4/B17) Vertical
 Remark : LTE_Band 4_Link_CH20175
 Tested by: Karl Lee

	Read	Limit	Over		
Freq	Level	Level	Line	Limit	Factor Remark
MHz	dBm	dBm	dBm	dB	dB
1 pp 3465.00	-51.88	-66.22	-13.00	-38.88	14.34 Peak

High Channel



Bureau Veritas Consumer Products Services Ltd., Taoyuan Branch

A D T

Data: 9

Date: 2019-02-14

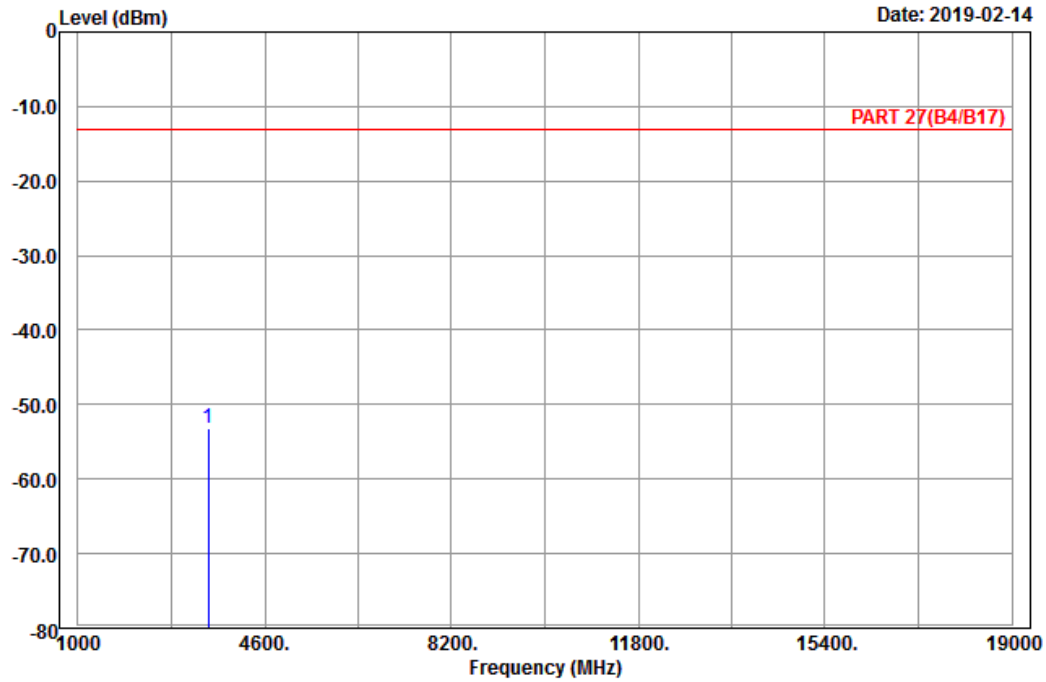

Site : 966 chamber 1
 Condition: PART 27(B4/B17) Horizontal
 Remark : LTE_Band 4_Link_CH20375
 Tested by: Karl Lee

Freq	Level	Read Level	Limit Line	Over Limit	Factor	Remark
MHz	dBm	dBm	dBm	dB	dB	
1 pp 3505.00	-53.17	-67.45	-13.00	-40.17	14.28	Peak



Bureau Veritas Consumer Products Services Ltd., Taoyuan Branch

A D T

Data: 10

Date: 2019-02-14

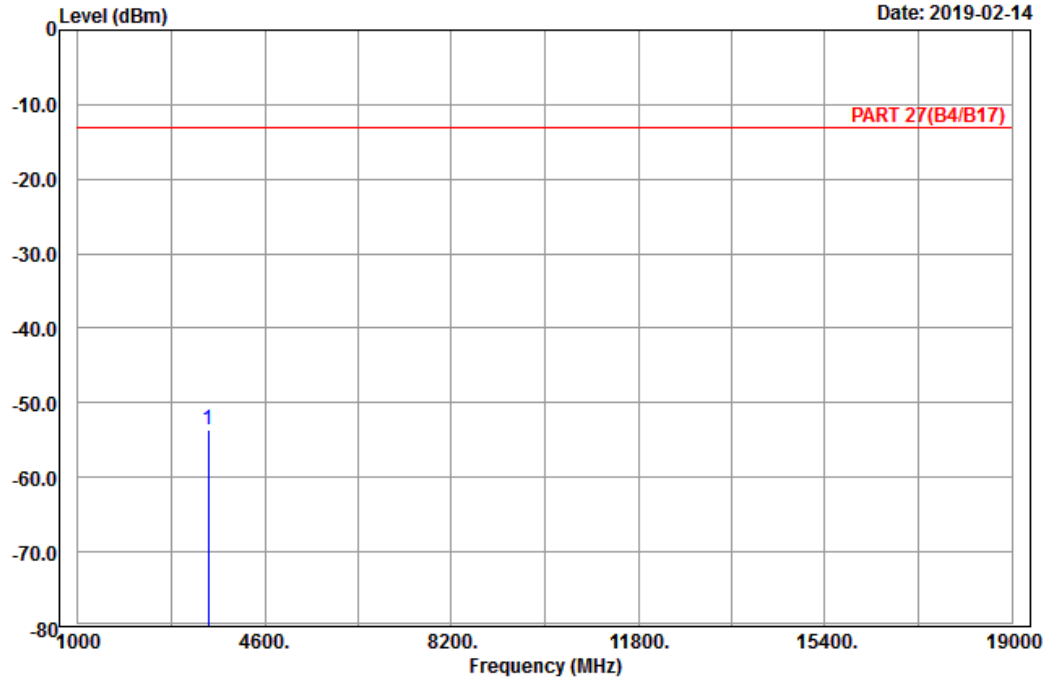

Site : 966 chamber 1
 Condition: PART 27(B4/B17) Vertical
 Remark : LTE_Band 4_Link_CH20375
 Tested by: Karl Lee

	Read	Limit	Over			
Freq	Level	Level	Line	Limit	Factor	Remark
MHz	dBm	dBm	dBm	dB	dB	
1 pp 3505.00	-53.61	-67.89	-13.00	-40.61	14.28	Peak

Channel Bandwidth: 20 MHz / QPSK
Low Channel



Bureau Veritas Consumer Products Services Ltd., Taoyuan Branch

A D T

Data: 13

Date: 2019-02-14

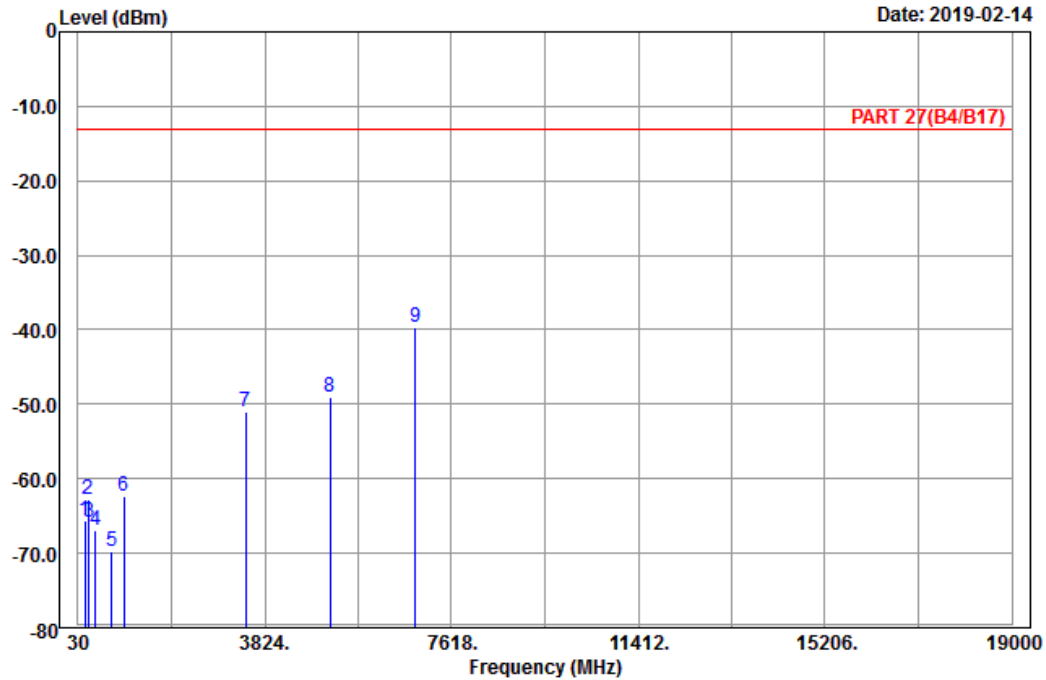

Site : 966 chamber 1
Condition: PART 27(B4/B17) Horizontal
Remark : LTE_Band 4_Link_CH20050
Tested by: Karl Lee

	Freq	Level	Read Level	Limit Line	Over Limit	Factor	Remark
	MHz	dBm	dBm	dBm	dB	dB	
1	174.99	-65.55	-59.36	-13.00	-52.55	-6.19	Peak
2	230.88	-62.72	-56.95	-13.00	-49.72	-5.77	Peak
3	258.96	-65.76	-60.17	-13.00	-52.76	-5.59	Peak
4	379.80	-66.85	-63.08	-13.00	-53.85	-3.77	Peak
5	720.00	-69.82	-69.08	-13.00	-56.82	-0.74	Peak
6	961.50	-62.44	-67.58	-13.00	-49.44	5.14	Peak
7	3440.00	-51.01	-65.36	-13.00	-38.01	14.35	Peak
8	5160.00	-49.04	-68.96	-13.00	-36.04	19.92	Peak
9 pp	6880.00	-39.69	-62.49	-13.00	-26.69	22.80	Peak



Bureau Veritas Consumer Products Services Ltd., Taoyuan Branch

A D T

Data: 14

Date: 2019-02-14

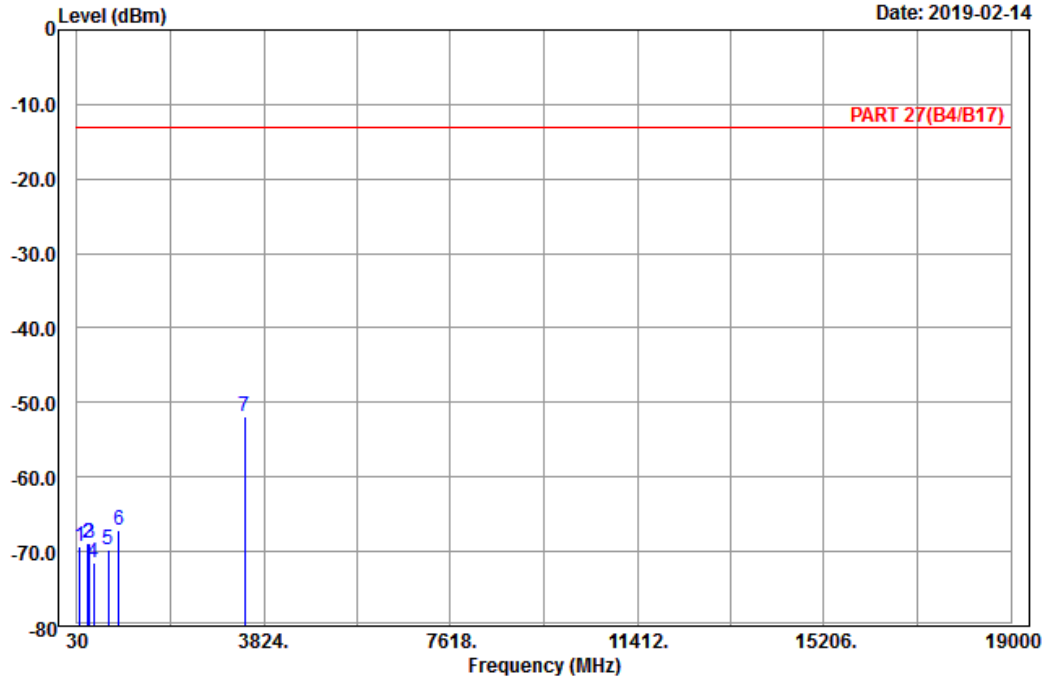

Site : 966 chamber 1
 Condition: PART 27(B4/B17) Vertical
 Remark : LTE_Band 4_Link_CH20050
 Tested by: Karl Lee

	Freq	Level	Read Level	Limit Line	Over Limit	Factor	Remark
	MHz	dBm	dBm	dBm	dB	dB	
1	87.51	-69.39	-58.39	-13.00	-56.39	-11.00	Peak
2	254.91	-68.95	-63.40	-13.00	-55.95	-5.55	Peak
3	280.29	-68.77	-62.99	-13.00	-55.77	-5.78	Peak
4	372.80	-71.51	-67.32	-13.00	-58.51	-4.19	Peak
5	661.90	-69.70	-69.51	-13.00	-56.70	-0.19	Peak
6	883.10	-67.11	-69.50	-13.00	-54.11	2.39	Peak
7 pp	3440.00	-51.96	-66.31	-13.00	-38.96	14.35	Peak

Middle Channel



Bureau Veritas Consumer Products Services Ltd., Taoyuan Branch

A D T

Data: 9

Date: 2019-02-14

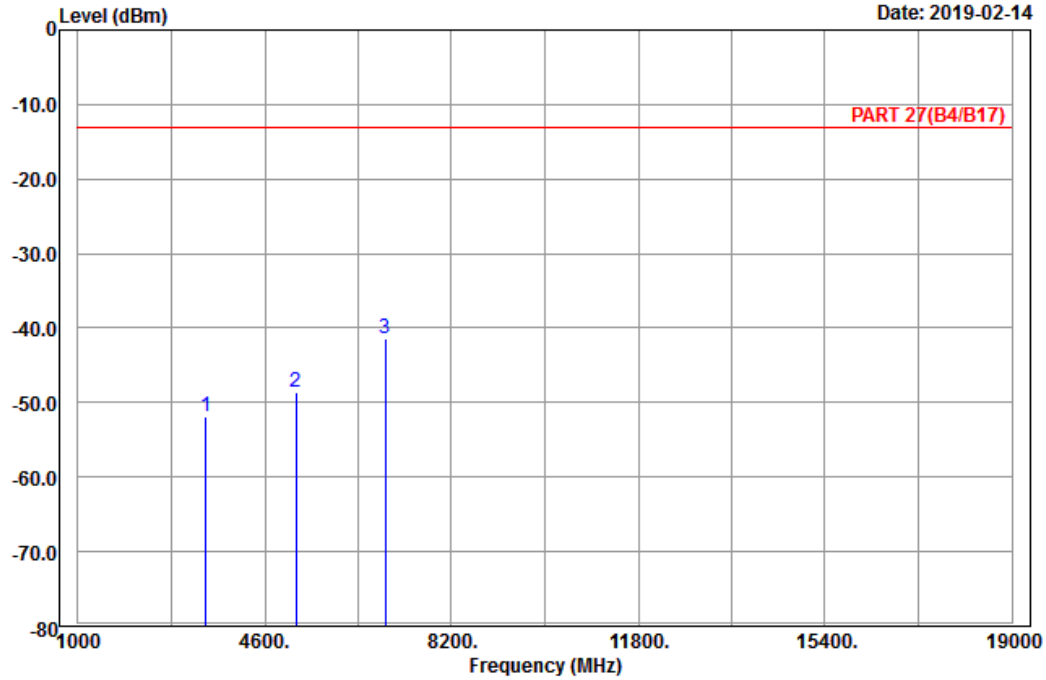

Site : 966 chamber 1
 Condition: PART 27(B4/B17) Horizontal
 Remark : LTE_Band 4_Link_CH20175
 Tested by: Karl Lee

	Freq	Level	Read Level	Limit Line	Over Limit	Factor	Remark
	MHz	dBm	dBm	dBm	dB	dB	
1	3465.00	-51.81	-66.15	-13.00	-38.81	14.34	Peak
2	5197.50	-48.64	-68.76	-13.00	-35.64	20.12	Peak
3 pp	6930.00	-41.36	-64.23	-13.00	-28.36	22.87	Peak



Bureau Veritas Consumer Products Services Ltd., Taoyuan Branch

A D T

Data: 10

Date: 2019-02-14

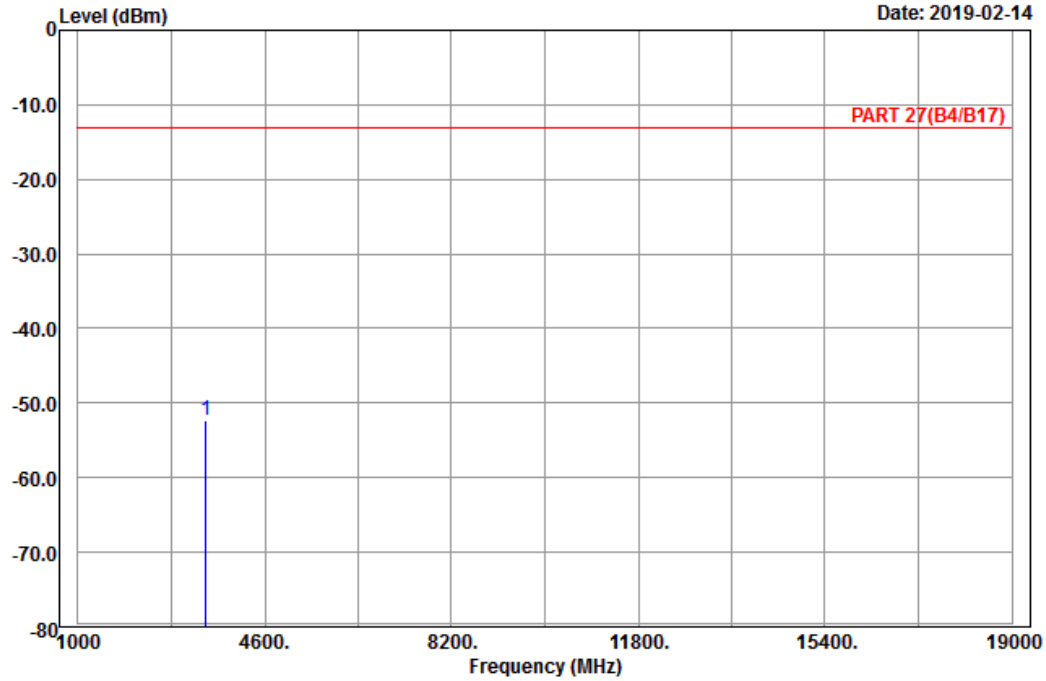

Site : 966 chamber 1
 Condition: PART 27(B4/B17) Vertical
 Remark : LTE_Band 4_Link_CH20175
 Tested by: Karl Lee

	Read	Limit	Over		
Freq	Level	Level	Line	Limit	Factor
MHz	dBm	dBm	dBm	dB	dB
1 pp 3465.00	-52.27	-66.61	-13.00	-39.27	14.34
					Peak

High Channel



Bureau Veritas Consumer Products Services Ltd., Taoyuan Branch

A D T

Data: 9

Date: 2019-02-14

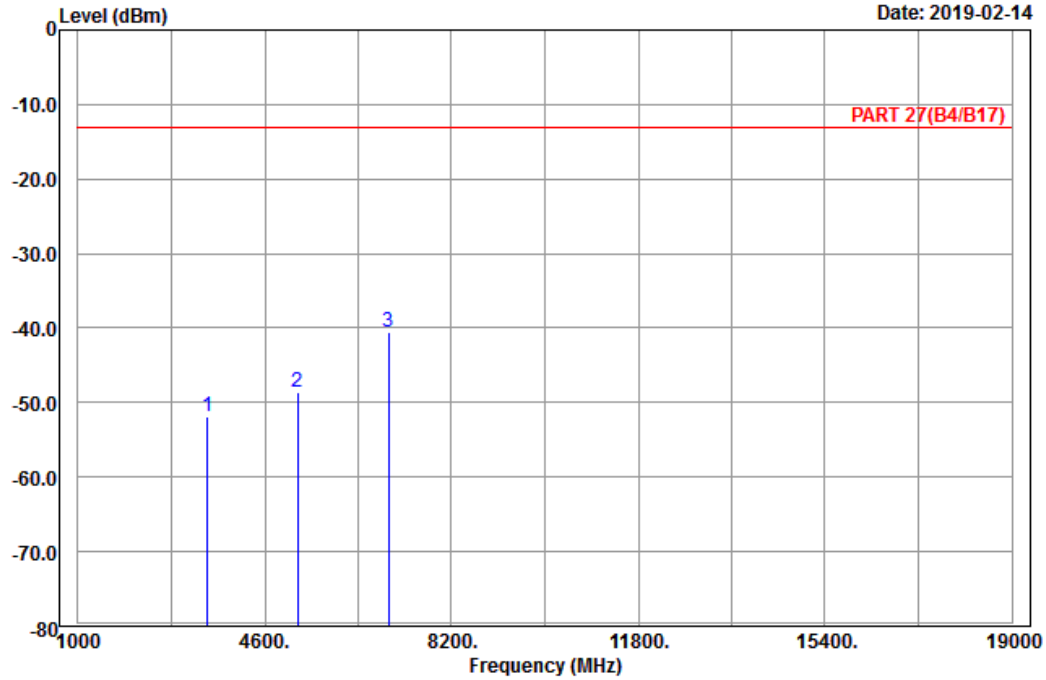

Site : 966 chamber 1
 Condition: PART 27(B4/B17) Horizontal
 Remark : LTE_Band 4_Link_CH20300
 Tested by: Karl Lee

	Freq	Level	Read Level	Limit Line	Over Limit	Factor	Remark
	MHz	dBm	dBm	dBm	dB	dB	
1	3490.00	-51.83	-66.14	-13.00	-38.83	14.31	Peak
2	5235.00	-48.50	-68.66	-13.00	-35.50	20.16	Peak
3 pp	6980.00	-40.65	-63.34	-13.00	-27.65	22.69	Peak



Bureau Veritas Consumer Products Services Ltd., Taoyuan Branch

A D T

Data: 10

Date: 2019-02-14

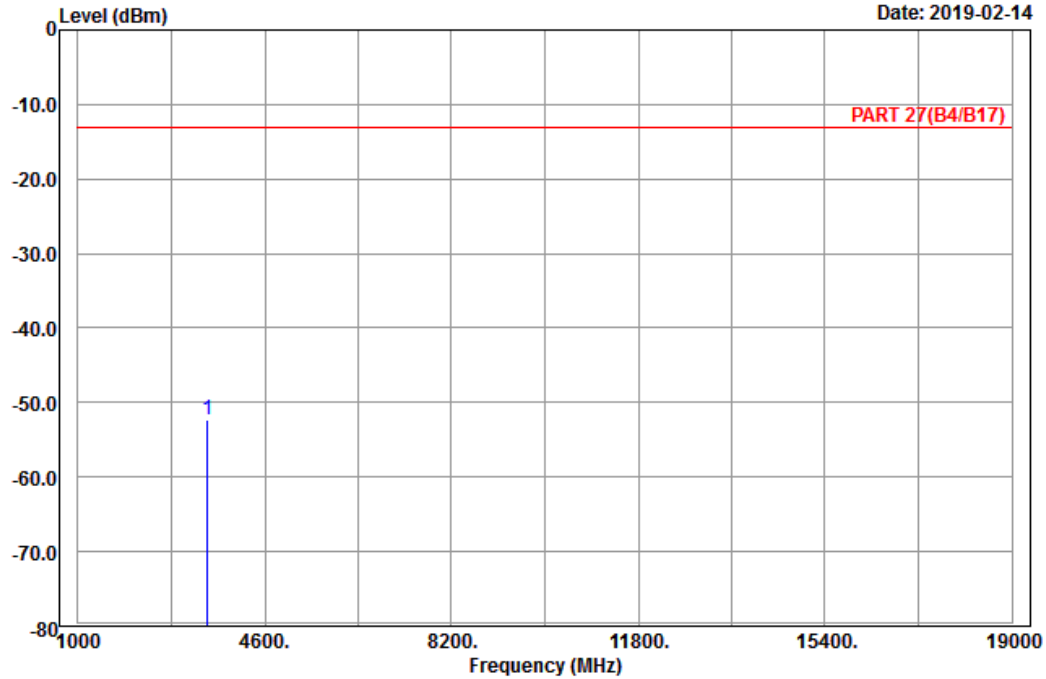

Site : 966 chamber 1
 Condition: PART 27(B4/B17) Vertical
 Remark : LTE_Band 4_Link_CH20300
 Tested by: Karl Lee

	Read	Limit	Over			
Freq	Level	Level	Line	Limit	Factor	Remark
MHz	dBm	dBm	dBm	dB	dB	
1 pp 3490.00	-52.25	-66.56	-13.00	-39.25	14.31	Peak

LTE Band 12
 Channel Bandwidth: 1.4 MHz / QPSK
 Low Channel



Bureau Veritas Consumer Products Services Ltd., Taoyuan Branch

A D T

Data: 5

Date: 2019-03-09

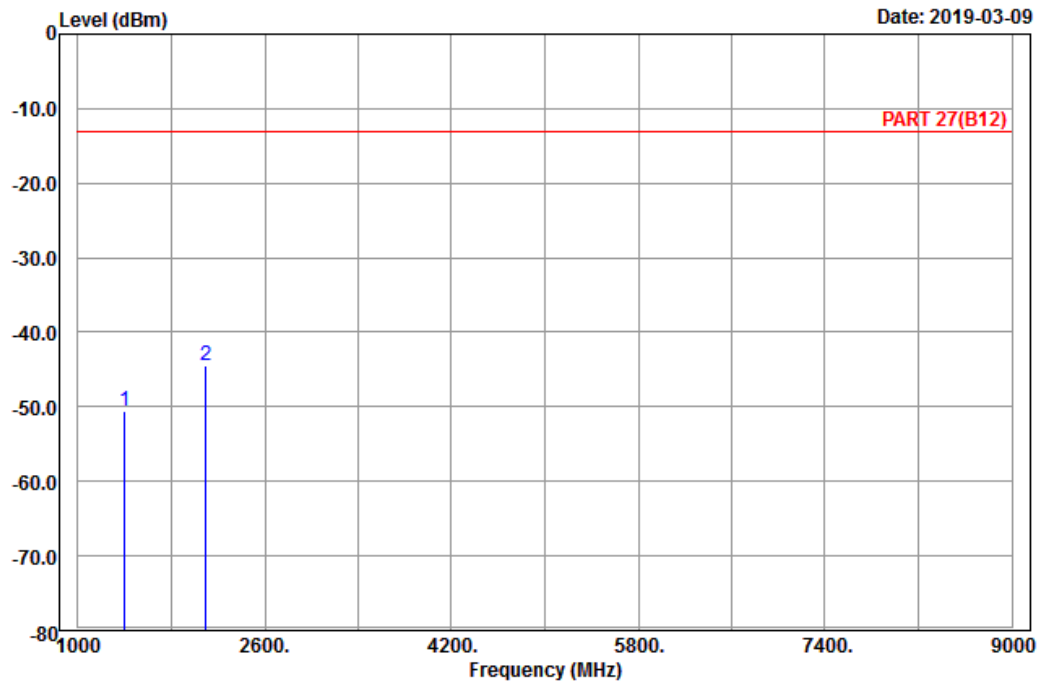

Site : 966 chamber 1
 Condition: PART 27(B12) Horizontal
 Remark : LTE_Band 12_Link_CH23017
 Tested by: Karl Lee

	Read	Limit	Over			
Freq	Level	Level	Line	Limit	Factor	Remark
MHz	dBm	dBm	dBm	dB	dB	
1	1399.40	-50.57	-56.67	-13.00	-37.57	6.10 Peak
2 pp	2099.10	-44.56	-55.49	-13.00	-31.56	10.93 Peak



Bureau Veritas Consumer Products Services Ltd., Taoyuan Branch

A D T

Data: 6

Date: 2019-03-09

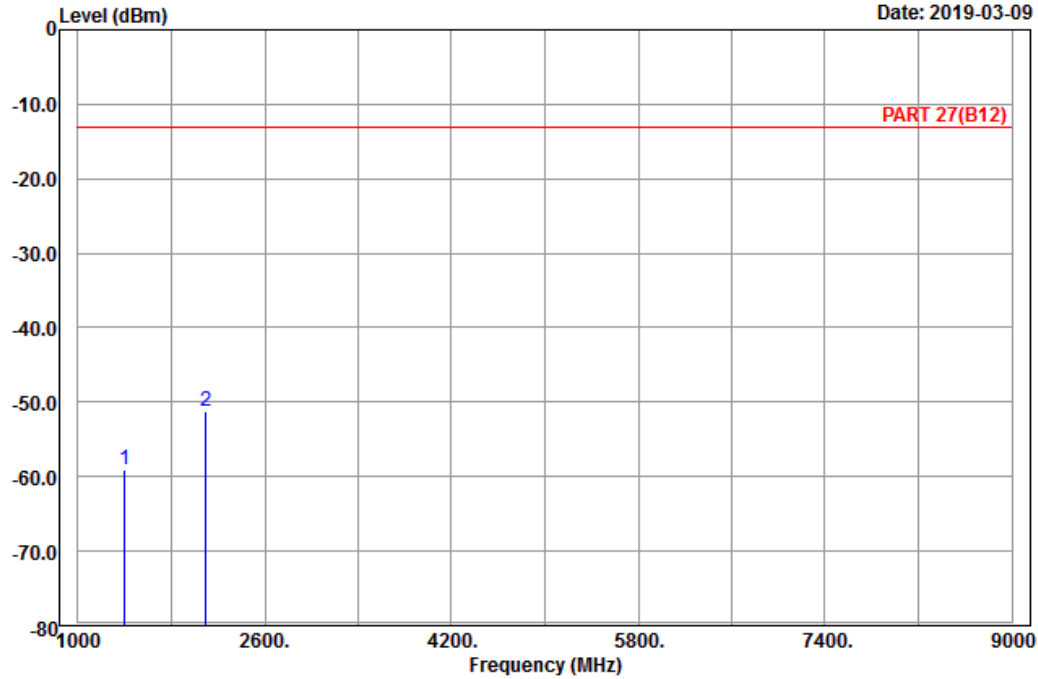

Site : 966 chamber 1
 Condition: PART 27(B12) Vertical
 Remark : LTE_Band 12_Link_CH23017
 Tested by: Karl Lee

	Freq	Level	Read Level	Limit Line	Over Limit	Factor	Remark
	MHz	dBm	dBm	dBm	dB	dB	
1	1399.40	-59.01	-65.11	-13.00	-46.01	6.10	Peak
2 pp	2099.10	-51.18	-62.11	-13.00	-38.18	10.93	Peak

Middle Channel



Bureau Veritas Consumer Products Services Ltd., Taoyuan Branch

A D T

Data: 5

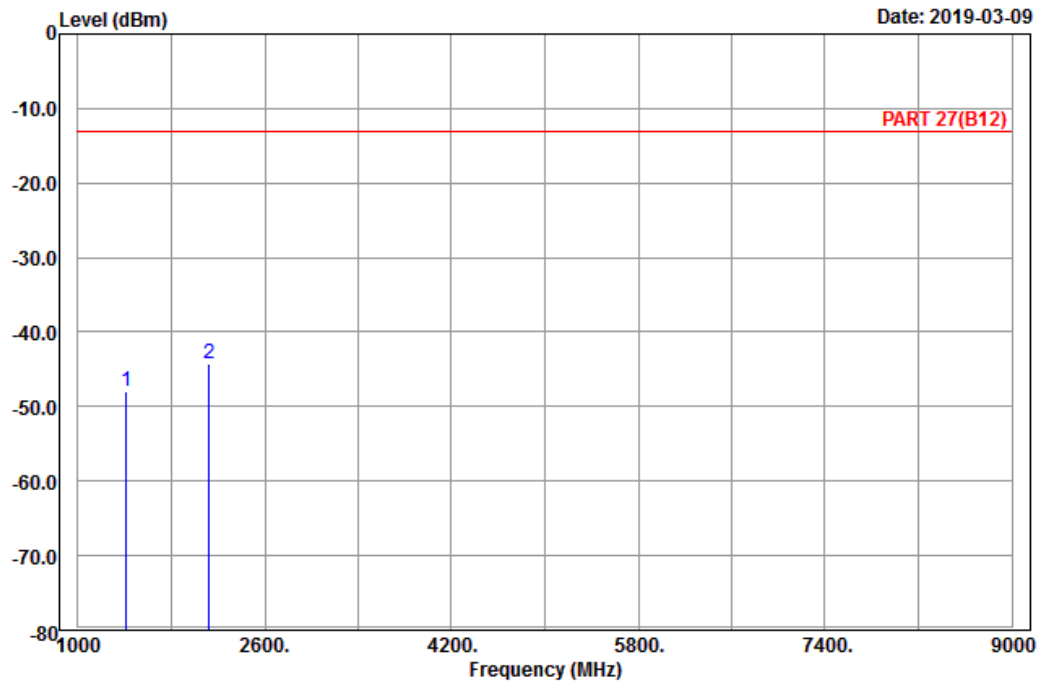

Site : 966 chamber 1
 Condition: PART 27(B12) Horizontal
 Remark : LTE_Band 12_Link_CH23095
 Tested by: Karl Lee

	Freq	Level	Read Level	Limit Line	Over Limit	Factor	Remark
	MHz	dBm	dBm	dBm	dB	dB	
1	1415.00	-47.90	-54.26	-13.00	-34.90	6.36	Peak
2	2122.50	-44.26	-55.37	-13.00	-31.26	11.11	Peak



Bureau Veritas Consumer Products Services Ltd., Taoyuan Branch

A D T

Data: 6

Date: 2019-03-09

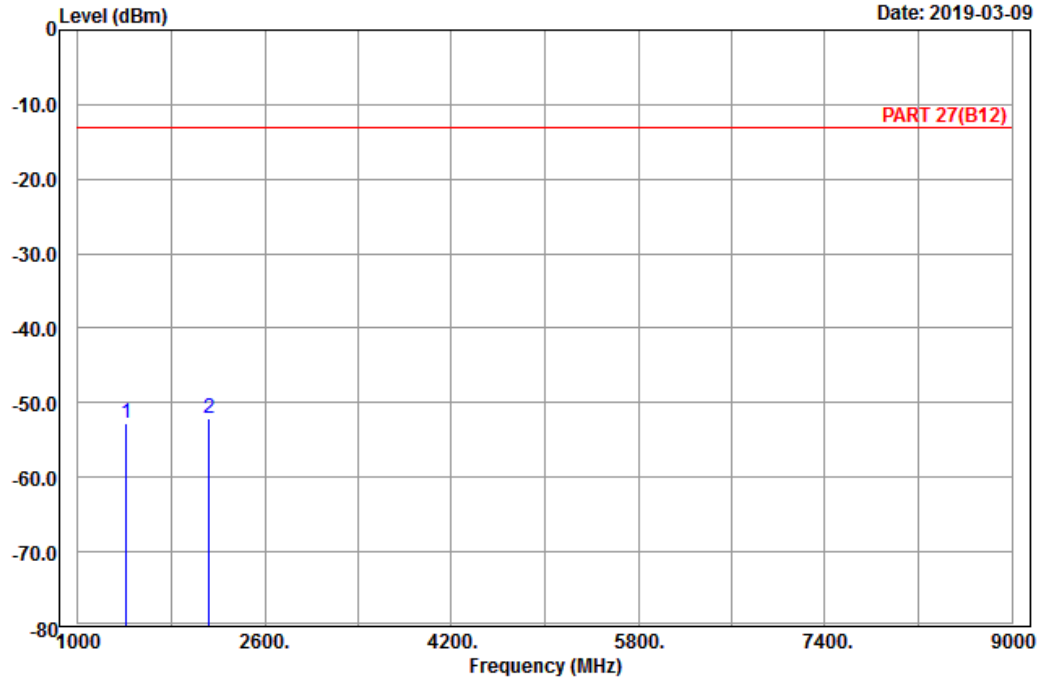

Site : 966 chamber 1
 Condition: PART 27(B12) Vertical
 Remark : LTE_Band 12_Link_CH23095
 Tested by: Karl Lee

	Freq	Level	Read Level	Limit Line	Over Limit	Factor	Remark
	MHz	dBm	dBm	dBm	dB	dB	
1	1415.00	-52.85	-59.21	-13.00	-39.85	6.36	Peak
2 pp	2122.50	-52.06	-63.17	-13.00	-39.06	11.11	Peak

High Channel



Bureau Veritas Consumer Products Services Ltd., Taoyuan Branch

A D T

Data: 5

Date: 2019-03-09

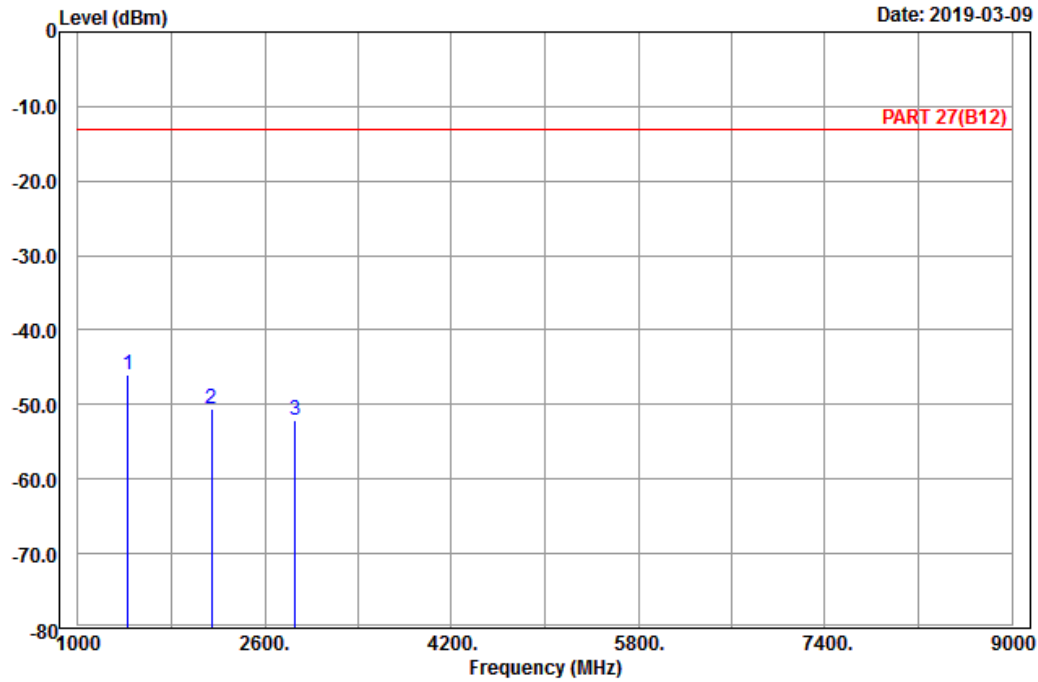

Site : 966 chamber 1
 Condition: PART 27(B12) Horizontal
 Remark : LTE_Band 12_Link_CH23173
 Tested by: Karl Lee

	Read	Limit	Over			
Freq	Level	Level	Line	Limit	Factor	Remark
MHz	dBm	dBm	dBm	dB	dB	
1 pp	1430.60	-45.98	-52.22	-13.00	-32.98	6.24 Peak
2	2145.90	-50.68	-61.93	-13.00	-37.68	11.25 Peak
3	2861.20	-52.06	-65.08	-13.00	-39.06	13.02 Peak



Bureau Veritas Consumer Products Services Ltd., Taoyuan Branch

A D T

Data: 6

Date: 2019-03-09

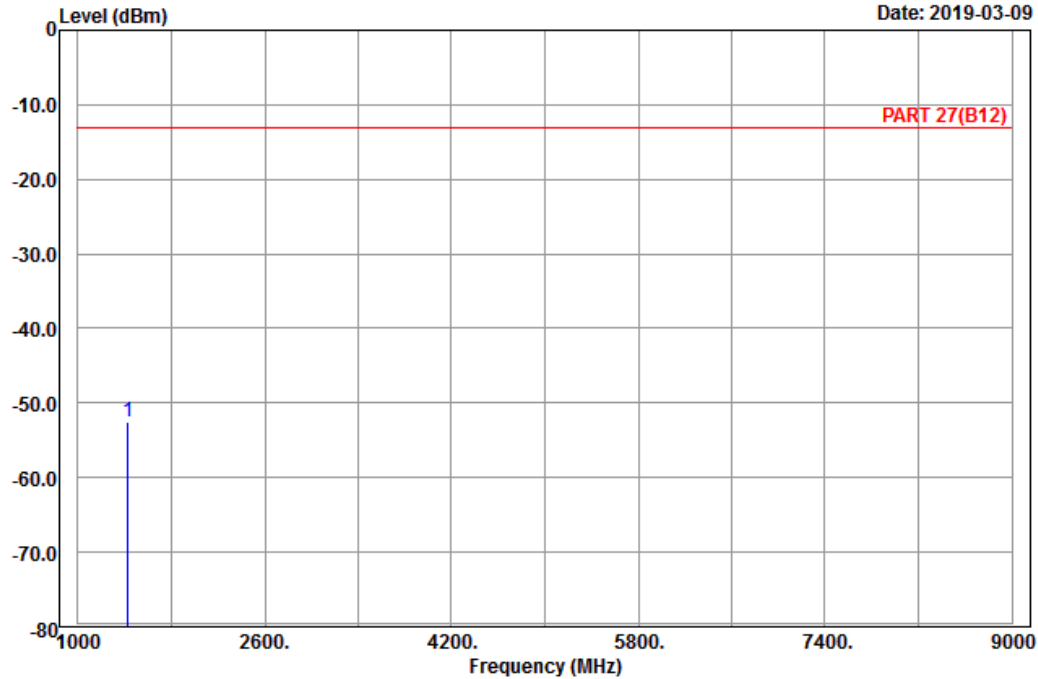

Site : 966 chamber 1
 Condition: PART 27(B12) Vertical
 Remark : LTE_Band 12_Link_CH23173
 Tested by: Karl Lee

	Freq	Level	Read Level	Limit Line	Over Limit	Factor	Remark
	MHz	dBm	dBm	dBm	dB	dB	
1 pp	1430.60	-52.57	-58.81	-13.00	-39.57	6.24	Peak

Channel Bandwidth: 5 MHz / QPSK
Low Channel



Bureau Veritas Consumer Products Services Ltd., Taoyuan Branch

A D T

Data: 5

Date: 2019-03-08

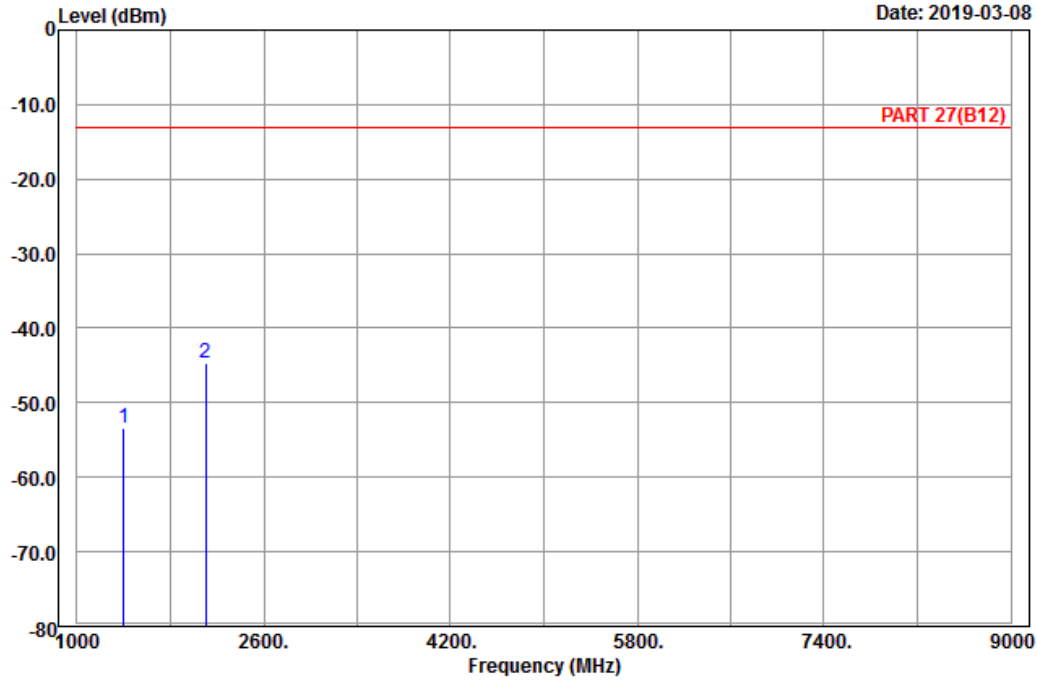

Site : 966 chamber 1
Condition: PART 27(B12) Horizontal
Remark : LTE_Band 12_Link_CH23035
Tested by: Karl Lee

	Freq	Level	Read Level	Limit Line	Over Limit	Factor	Remark
	MHz	dBm	dBm	dBm	dB	dB	
1	1403.00	-53.51	-59.61	-13.00	-40.51	6.10	Peak
2	pp 2104.50	-44.67	-55.60	-13.00	-31.67	10.93	Peak



Bureau Veritas Consumer Products Services Ltd., Taoyuan Branch

A D T

Data: 6

Date: 2019-03-08

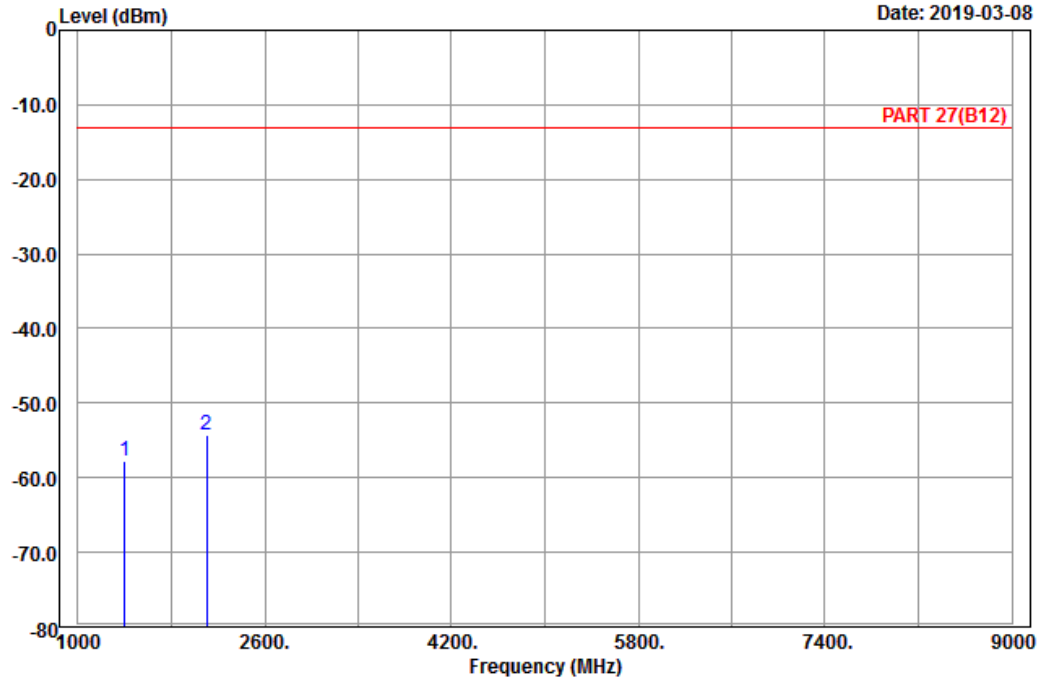

Site : 966 chamber 1
 Condition: PART 27(B12) Vertical
 Remark : LTE_Band 12_Link_CH23035
 Tested by: Karl Lee

	Freq	Level	Read Level	Limit Line	Over Limit	Factor	Remark
	MHz	dBm	dBm	dBm	dB	dB	
1	1403.00	-57.71	-63.81	-13.00	-44.71	6.10	Peak
2	pp 2104.50	-54.31	-65.24	-13.00	-41.31	10.93	Peak

Middle Channel



Bureau Veritas Consumer Products Services Ltd., Taoyuan Branch

A D T

Data: 5

Date: 2019-03-08

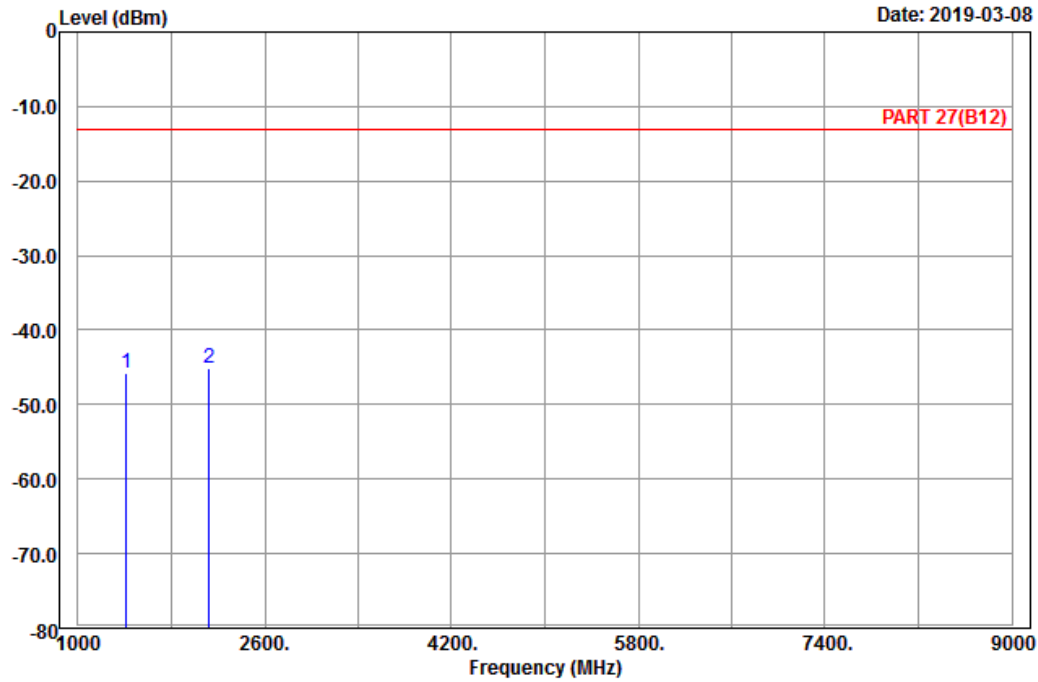

Site : 966 chamber 1
 Condition: PART 27(B12) Horizontal
 Remark : LTE_Band 12_Link_CH23095
 Tested by: Karl Lee

	Read	Limit	Over			
Freq	Level	Level	Line	Limit	Factor	Remark
MHz	dBm	dBm	dBm	dB	dB	
1	1415.00	-45.86	-52.22	-13.00	-32.86	6.36 Peak
2 pp	2122.50	-45.11	-56.22	-13.00	-32.11	11.11 Peak



Bureau Veritas Consumer Products Services Ltd., Taoyuan Branch

A D T

Data: 6

Date: 2019-03-08

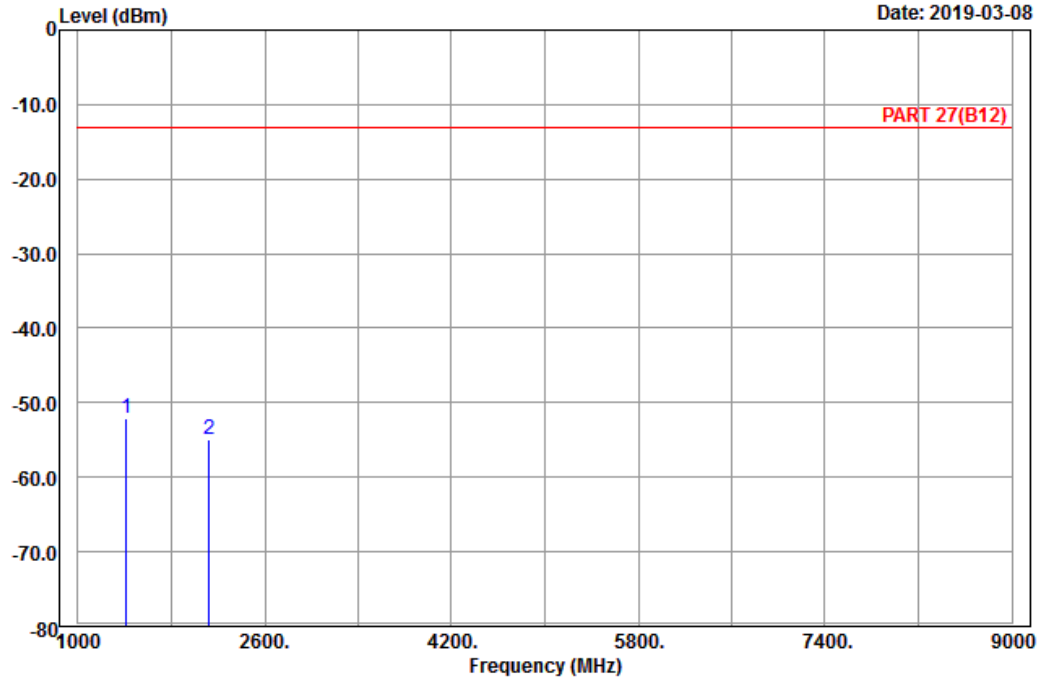

Site : 966 chamber 1
 Condition: PART 27(B12) Vertical
 Remark : LTE_Band 12_Link_CH23095
 Tested by: Karl Lee

	Freq	Level	Read Level	Limit Line	Over Limit	Factor	Remark
	MHz	dBm	dBm	dBm	dB	dB	
1 pp	1415.00	-52.16	-58.52	-13.00	-39.16	6.36	Peak
2	2122.50	-54.95	-66.06	-13.00	-41.95	11.11	Peak

High Channel



Bureau Veritas Consumer Products Services Ltd., Taoyuan Branch

A D T

Data: 5

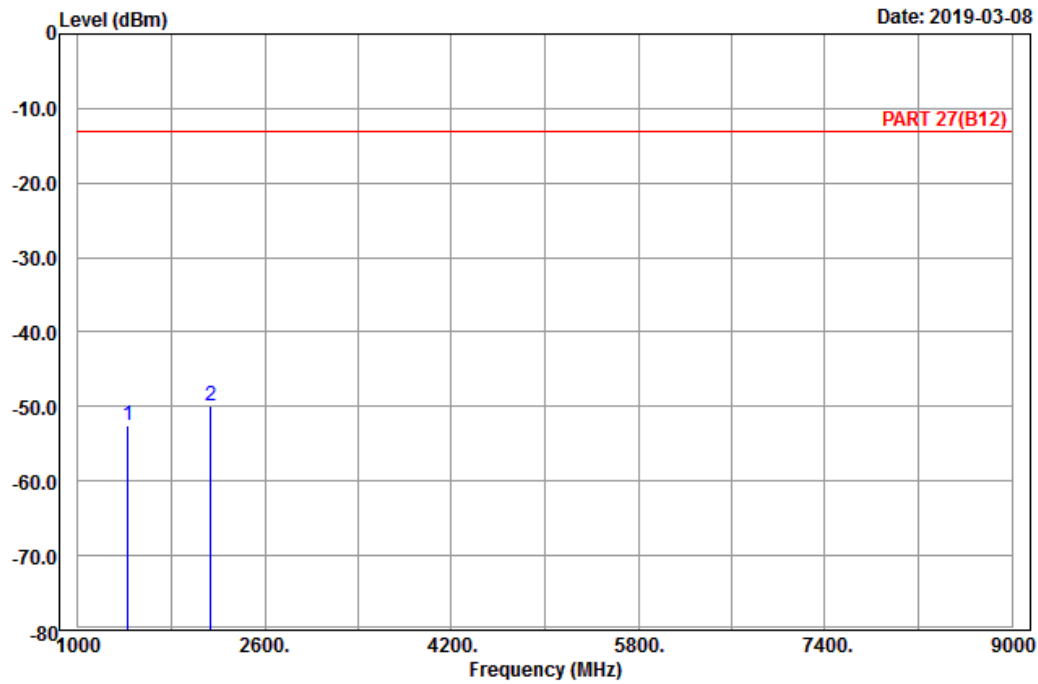

Site : 966 chamber 1
 Condition: PART 27(B12) Horizontal
 Remark : LTE_Band 12_Link_CH23155
 Tested by: Karl Lee

	Freq	Level	Read Level	Limit Line	Over Limit	Factor	Remark
	MHz	dBm	dBm	dBm	dB	dB	
1	1427.00	-52.46	-58.70	-13.00	-39.46	6.24	Peak
2	2140.50	-49.81	-61.09	-13.00	-36.81	11.28	Peak



Bureau Veritas Consumer Products Services Ltd., Taoyuan Branch

A D T

Data: 6

Date: 2019-03-09

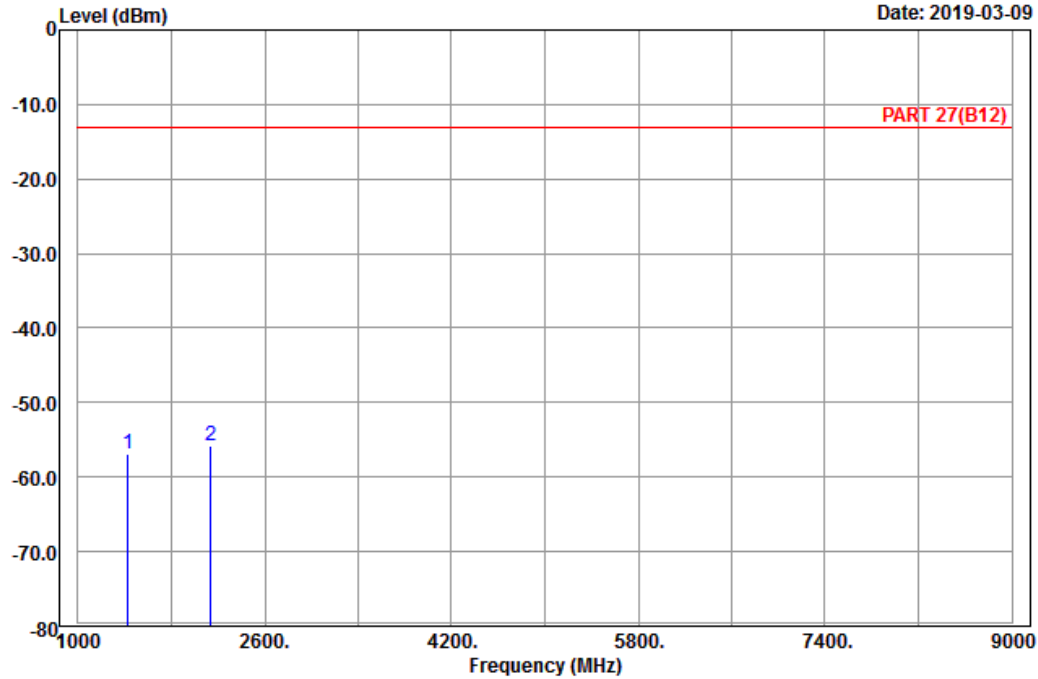

Site : 966 chamber 1
 Condition: PART 27(B12) Vertical
 Remark : LTE_Band 12_Link_CH23155
 Tested by: Karl Lee

	Freq	Level	Read Level	Limit Line	Over Limit	Factor	Remark
	MHz	dBm	dBm	dBm	dB	dB	
1	1427.00	-56.87	-63.11	-13.00	-43.87	6.24	Peak
2 pp	2140.50	-55.85	-67.13	-13.00	-42.85	11.28	Peak

Channel Bandwidth: 10 MHz / QPSK
Low Channel



Bureau Veritas Consumer Products Services Ltd., Taoyuan Branch

A D T

Data: 5

Date: 2019-03-08

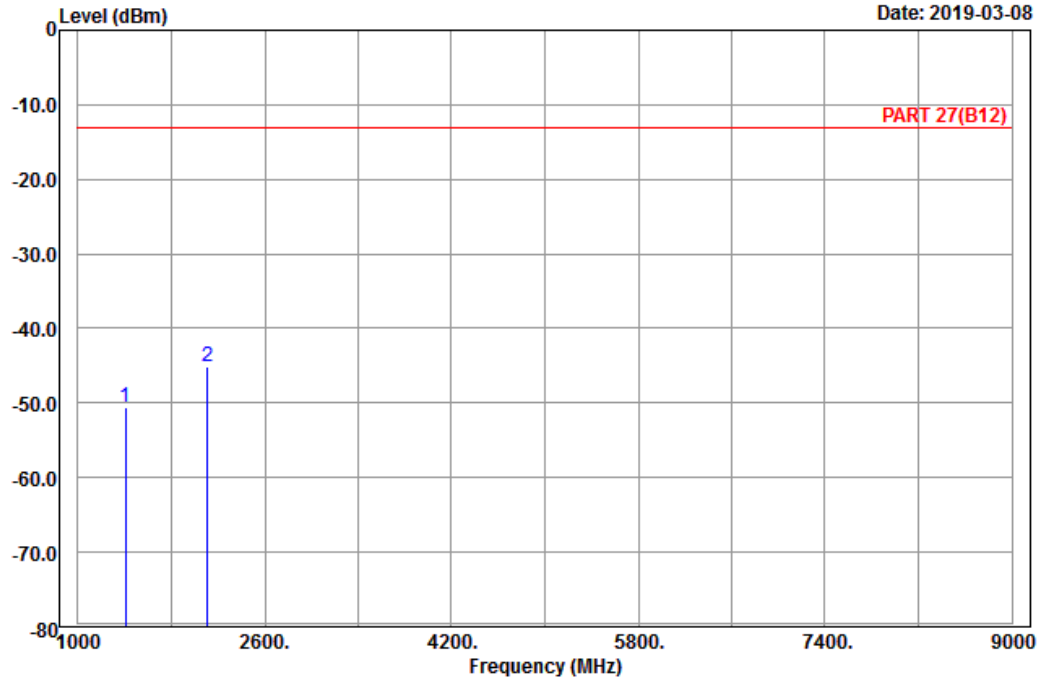

Site : 966 chamber 1
Condition: PART 27(B12) Horizontal
Remark : LTE_Band 12_Link_CH23060
Tested by: Karl Lee

	Freq	Level	Read Level	Limit Line	Over Limit	Factor	Remark
	MHz	dBm	dBm	dBm	dB	dB	
1	1408.00	-50.52	-56.88	-13.00	-37.52	6.36	Peak
2 pp	2112.00	-45.11	-56.22	-13.00	-32.11	11.11	Peak



Bureau Veritas Consumer Products Services Ltd., Taoyuan Branch

A D T

Data: 6

Date: 2019-03-08

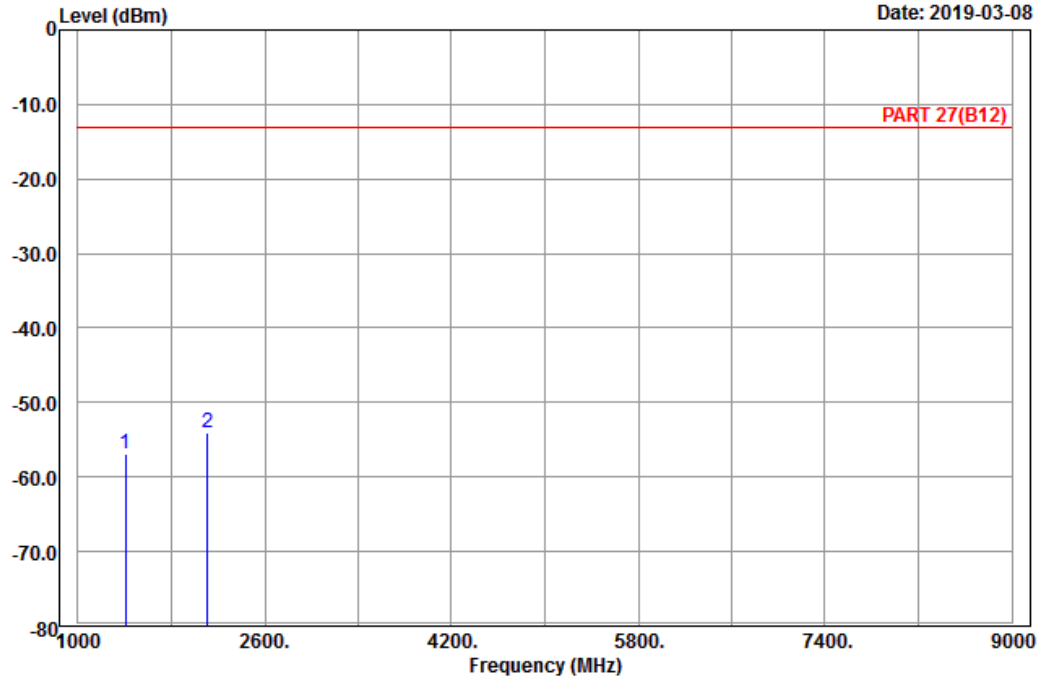

Site : 966 chamber 1
 Condition: PART 27(B12) Vertical
 Remark : LTE_Band 12_Link_CH23060
 Tested by: Karl Lee

	Freq	Level	Read Level	Limit Line	Over Limit	Factor	Remark
	MHz	dBm	dBm	dBm	dB	dB	
1	1408.00	-56.79	-63.15	-13.00	-43.79	6.36	Peak
2 pp	2112.00	-54.16	-65.27	-13.00	-41.16	11.11	Peak

Middle Channel



Bureau Veritas Consumer Products Services Ltd., Taoyuan Branch

A D T

Data: 9

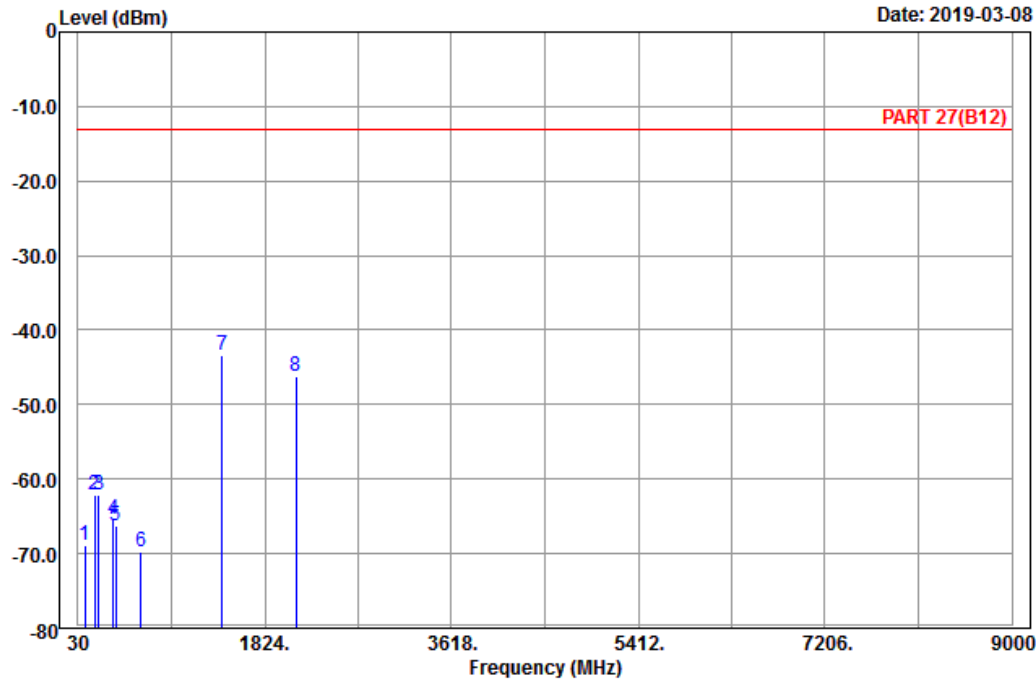

Site : 966 chamber 1
 Condition: PART 27(B12) Horizontal
 Remark : LTE_Band 12_Link_CH23095
 Tested by: Karl Lee

	Freq	Level	Read Level	Limit Line	Over Limit	Factor	Remark
	MHz	dBm	dBm	dBm	dB	dB	
1	97.23	-68.99	-58.70	-13.00	-55.99	-10.29	Peak
2	193.62	-62.22	-56.31	-13.00	-49.22	-5.91	Peak
3	225.75	-62.15	-56.32	-13.00	-49.15	-5.83	Peak
4	370.70	-65.45	-61.16	-13.00	-52.45	-4.29	Peak
5	392.40	-66.24	-63.14	-13.00	-53.24	-3.10	Peak
6	636.70	-69.83	-69.85	-13.00	-56.83	0.02	Peak
7 pp	1415.00	-43.46	-49.82	-13.00	-30.46	6.36	Peak
8	2122.50	-46.18	-57.29	-13.00	-33.18	11.11	Peak



Bureau Veritas Consumer Products Services Ltd., Taoyuan Branch

A D T

Data: 10

Date: 2019-03-08

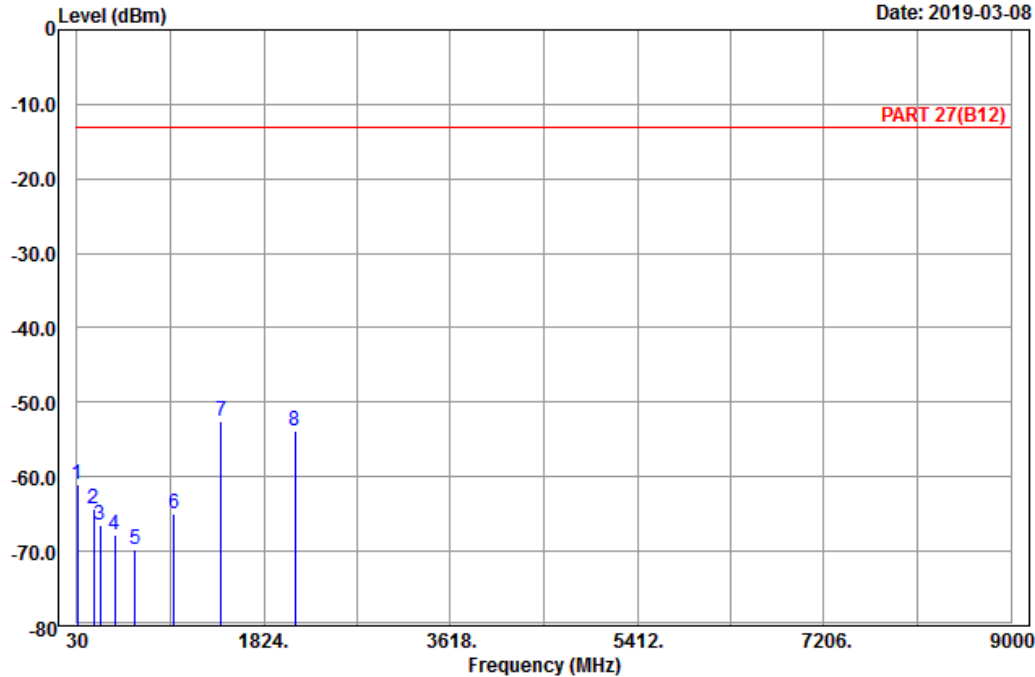

Site : 966 chamber 1
 Condition: PART 27(B12) Vertical
 Remark : LTE_Band 12_Link_CH23095
 Tested by: Karl Lee

	Freq	Level	Read Level	Limit Line	Over Limit	Factor	Remark
	MHz	dBm	dBm	dBm	dB	dB	
1	32.16	-60.95	-50.19	-13.00	-47.95	-10.76	Peak
2	190.92	-64.31	-58.53	-13.00	-51.31	-5.78	Peak
3	251.67	-66.54	-61.02	-13.00	-53.54	-5.52	Peak
4	388.90	-67.89	-64.58	-13.00	-54.89	-3.31	Peak
5	590.50	-69.84	-69.87	-13.00	-56.84	0.03	Peak
6	959.40	-64.88	-70.02	-13.00	-51.88	5.14	Peak
7 pp	1415.00	-52.56	-58.92	-13.00	-39.56	6.36	Peak
8	2122.50	-53.76	-64.87	-13.00	-40.76	11.11	Peak

High Channel



Bureau Veritas Consumer Products Services Ltd., Taoyuan Branch

A D T

Data: 5

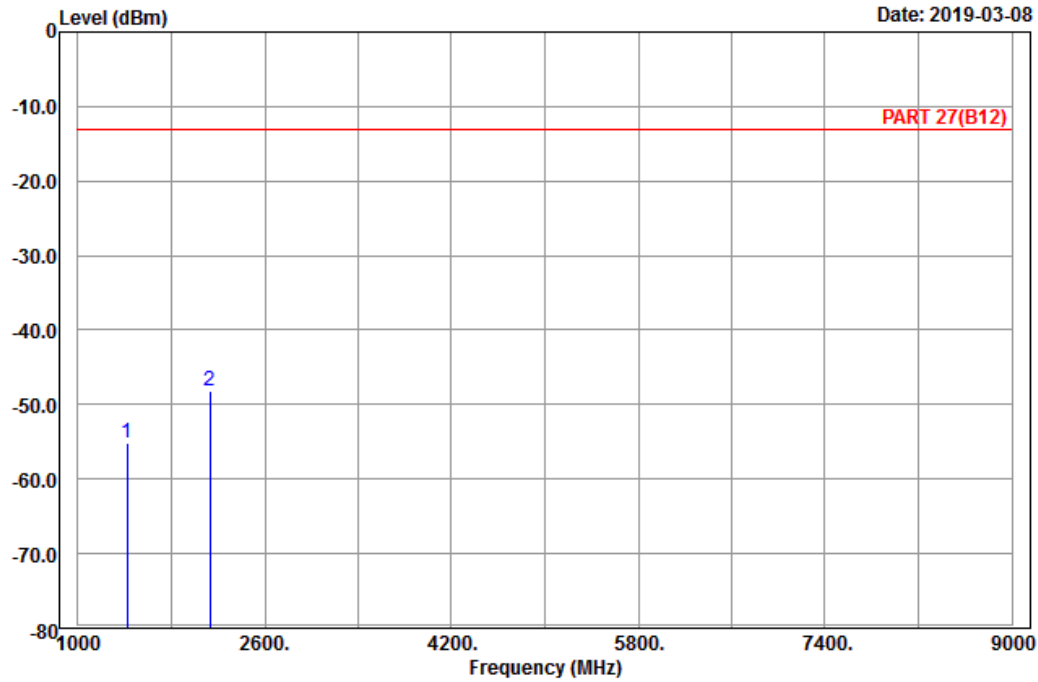

Site : 966 chamber 1
 Condition: PART 27(B12) Horizontal
 Remark : LTE_Band 12_Link_CH23130
 Tested by: Karl Lee

	Freq	Level	Read Level	Limit Line	Over Limit	Factor	Remark
	MHz	dBm	dBm	dBm	dB	dB	
1	1422.00	-55.16	-61.52	-13.00	-42.16	6.36	Peak
2	2133.00	-48.07	-59.35	-13.00	-35.07	11.28	Peak



Bureau Veritas Consumer Products Services Ltd., Taoyuan Branch

A D T

Data: 6

Date: 2019-03-08

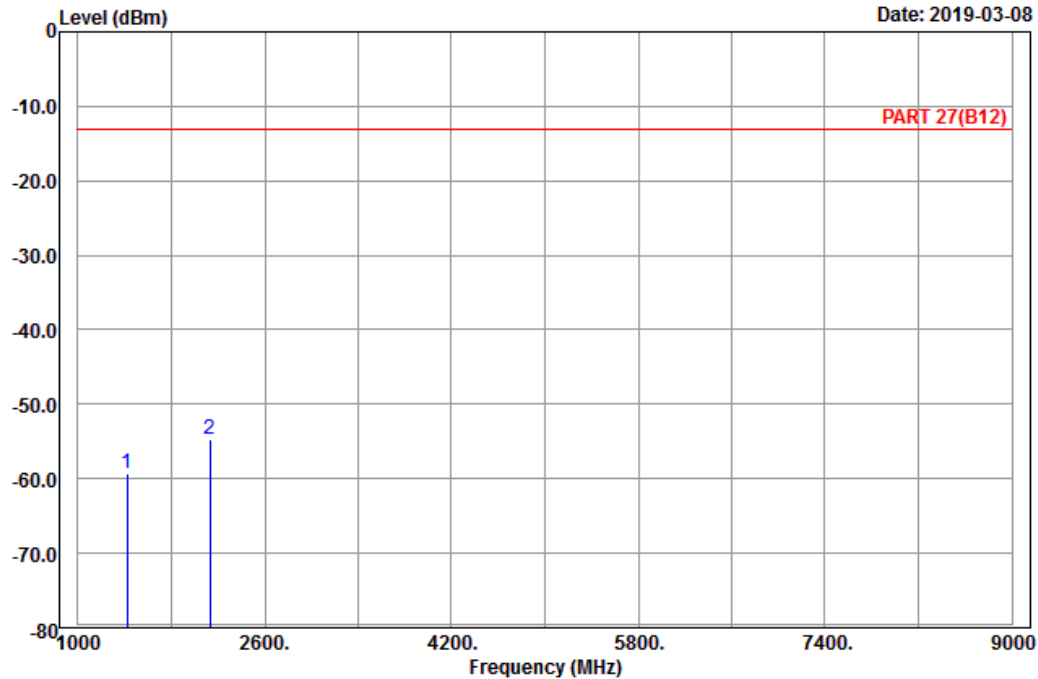

Site : 966 chamber 1
 Condition: PART 27(B12) Vertical
 Remark : LTE_Band 12_Link_CH23130
 Tested by: Karl Lee

	Freq	Level	Read Level	Limit Line	Over Limit	Factor	Remark
	MHz	dBm	dBm	dBm	dB	dB	
1	1422.00	-59.23	-65.59	-13.00	-46.23	6.36	Peak
2 pp	2133.00	-54.66	-65.94	-13.00	-41.66	11.28	Peak

LTE Band 13
 Channel Bandwidth: 5 MHz / QPSK
 Low Channel



Bureau Veritas Consumer Products Services Ltd., Taoyuan Branch

A D T

Data: 3

Date: 2019-02-16

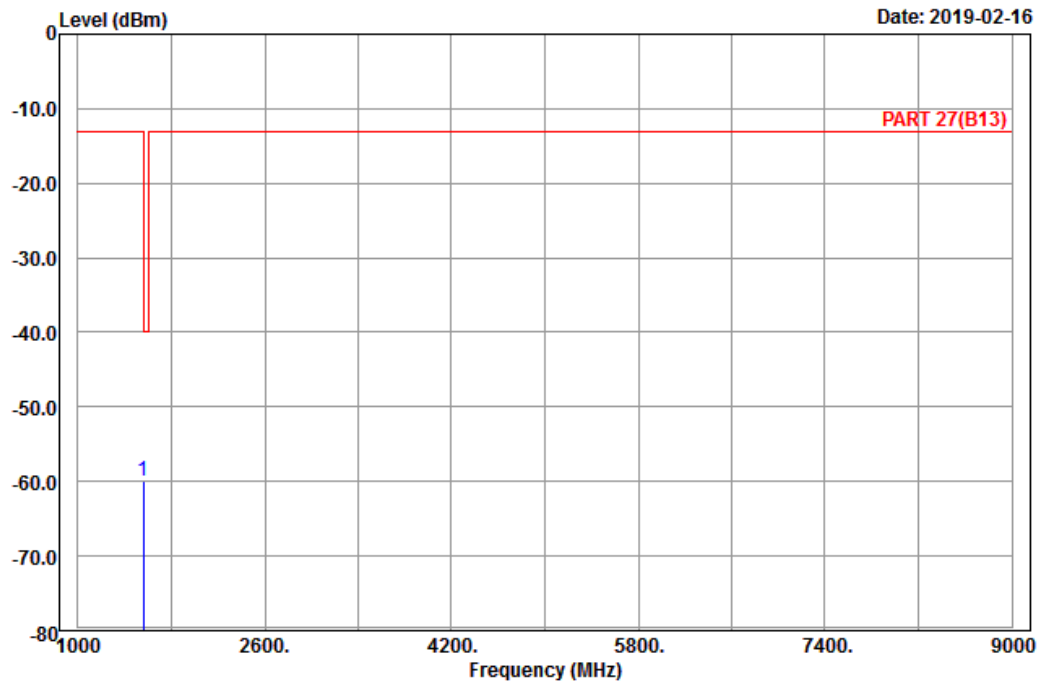

Site : 966 chamber 1
 Condition: PART 27(B13) Horizontal
 Remark : LTE_Band 13_Link_CH23205
 Tested by: Karl Lee

	Read	Limit	Over		
Freq	Level	Level	Line	Limit	Factor Remark
MHz	dBm	dBm	dBm	dB	dB
1 pp 1559.00	-59.90	-66.76	-40.00	-19.90	6.86 Peak



Bureau Veritas Consumer Products Services Ltd., Taoyuan Branch

A D T

Data: 4

Date: 2019-02-16

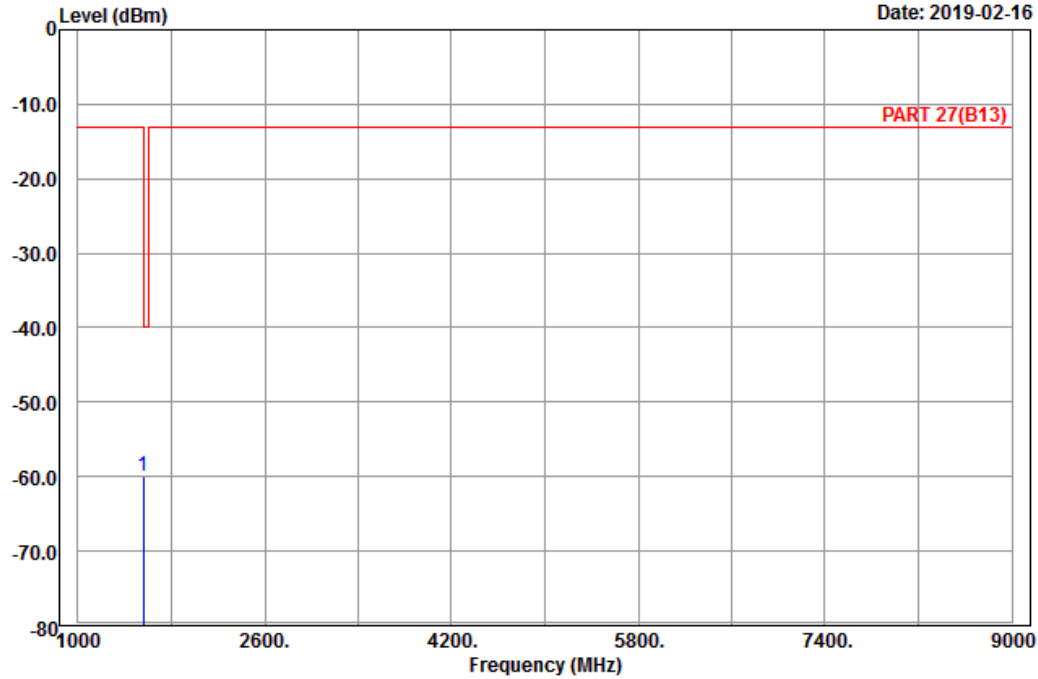

Site : 966 chamber 1
 Condition: PART 27(B13) Vertical
 Remark : LTE_Band 13_Link_CH23205
 Tested by: Karl Lee

	Freq	Level	Read Level	Limit Line	Over Limit	Factor	Remark
	MHz	dBm	dBm	dBm	dB	dB	
1	pp 1559.00	-59.93	-66.79	-40.00	-19.93	6.86	Peak

Middle Channel



Bureau Veritas Consumer Products Services Ltd., Taoyuan Branch

A D T

Data: 3

Date: 2019-02-16

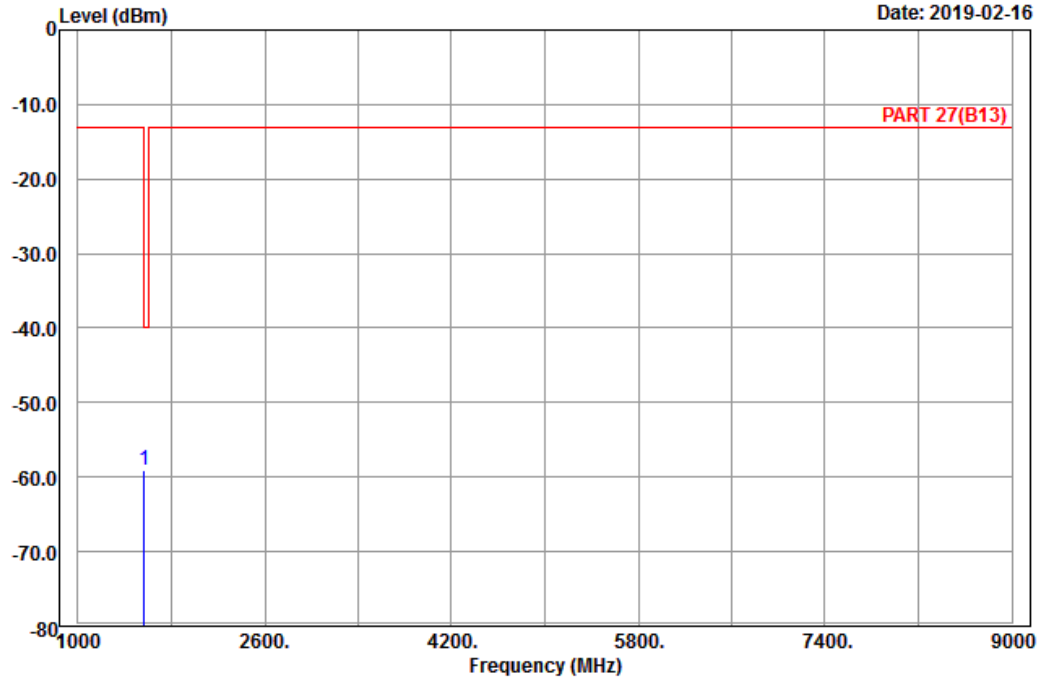

Site : 966 chamber 1
 Condition: PART 27(B13) Horizontal
 Remark : LTE_Band 13_Link_CH23230
 Tested by: Karl Lee

	Read	Limit	Over		
Freq	Level	Level	Line	Limit	Factor Remark
MHz	dBm	dBm	dBm	dB	dB
1 pp 1564.00	-59.13	-65.99	-40.00	-19.13	6.86 Peak



Bureau Veritas Consumer Products Services Ltd., Taoyuan Branch

A D T

Data: 4

Date: 2019-02-16

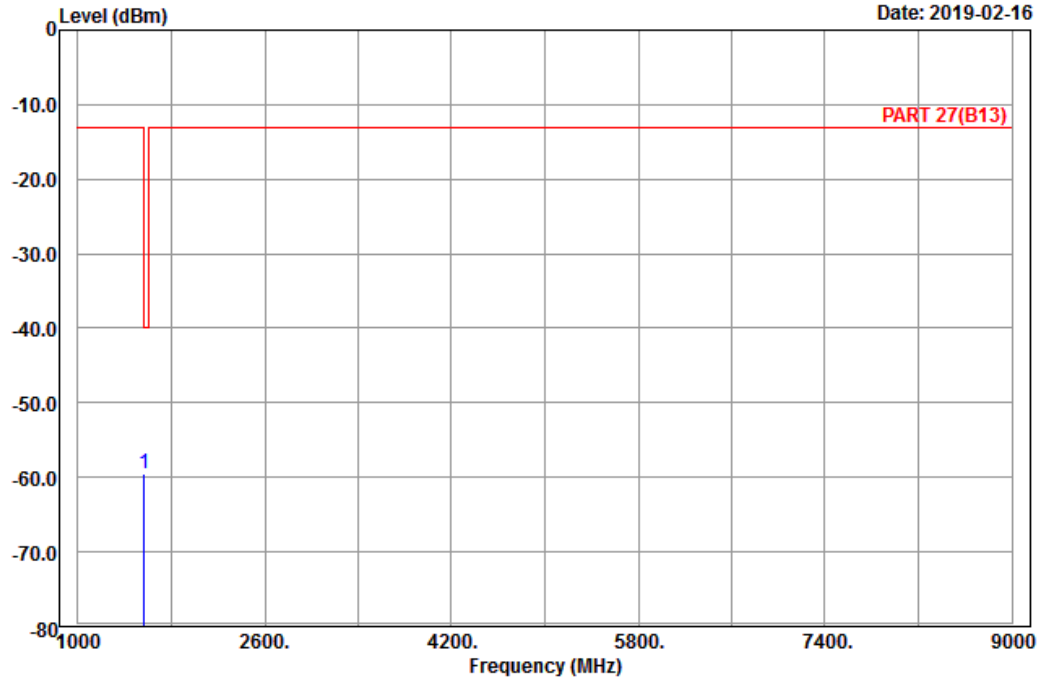

Site : 966 chamber 1
 Condition: PART 27(B13) Vertical
 Remark : LTE_Band 13_Link_CH23230
 Tested by: Karl Lee

	Freq	Level	Read Level	Limit Line	Over Limit	Factor	Remark
	MHz	dBm	dBm	dBm	dB	dB	
1	pp 1564.00	-59.46	-66.32	-40.00	-19.46	6.86	Peak

High Channel



Bureau Veritas Consumer Products Services Ltd., Taoyuan Branch

A D T

Data: 3

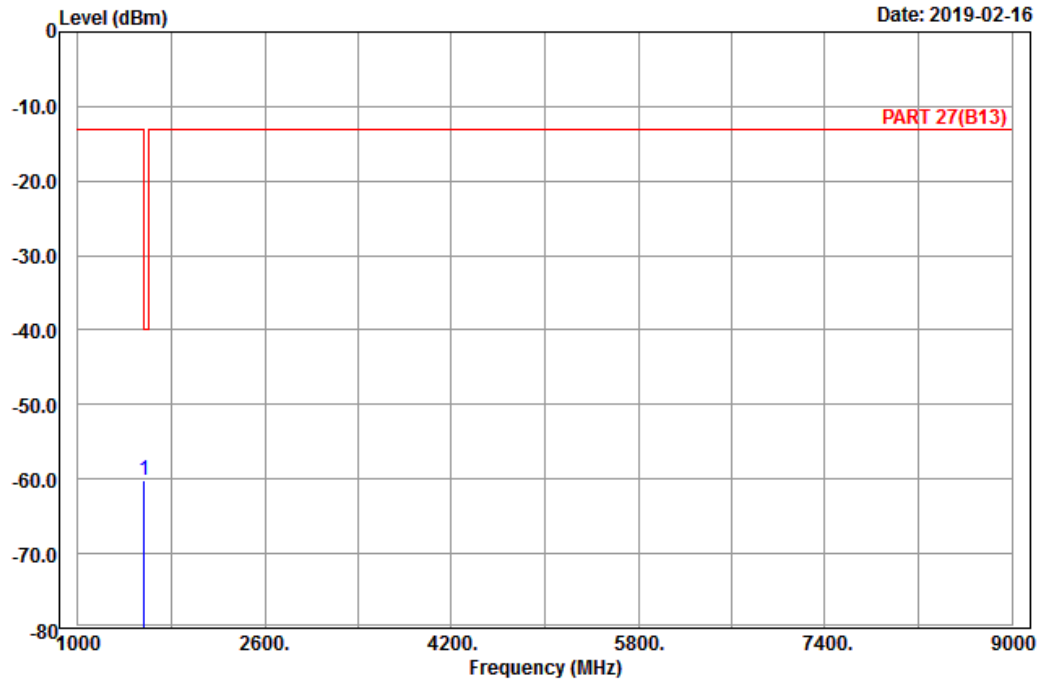

Site : 966 chamber 1
 Condition: PART 27(B13) Horizontal
 Remark : LTE_Band 13_Link_CH23255
 Tested by: Karl Lee

	Read	Limit	Over		
Freq	Level	Level	Line	Limit	Factor Remark
MHz	dBm	dBm	dBm	dB	dB
1 pp 1569.00	-60.16	-67.20	-40.00	-20.16	7.04 Peak



Bureau Veritas Consumer Products Services Ltd., Taoyuan Branch

A D T

Data: 4

Date: 2019-02-16

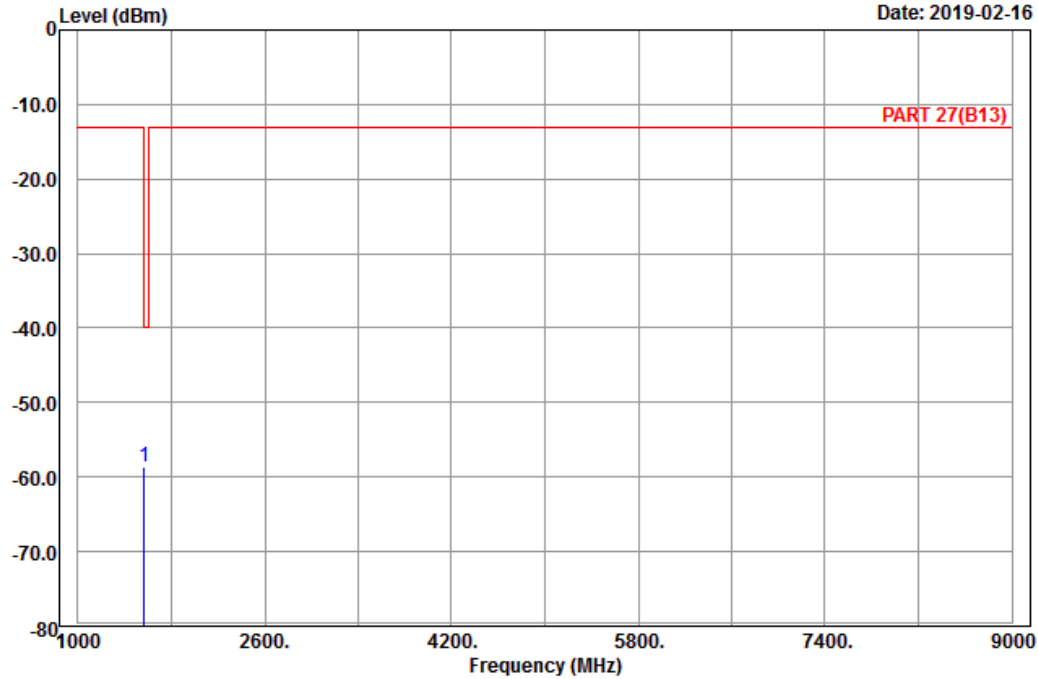

Site : 966 chamber 1
 Condition: PART 27(B13) Vertical
 Remark : LTE_Band 13_Link_CH23255
 Tested by: Karl Lee

	Read	Limit	Over			
Freq	Level	Level	Line	Limit	Factor	Remark
MHz	dBm	dBm	dBm	dB	dB	
1 pp 1569.00	-58.57	-65.61	-40.00	-18.57	7.04	Peak

Channel Bandwidth: 10 MHz / QPSK
Middle Channel



Bureau Veritas Consumer Products Services Ltd., Taoyuan Branch

A D T

Data: 9

Date: 2019-02-15

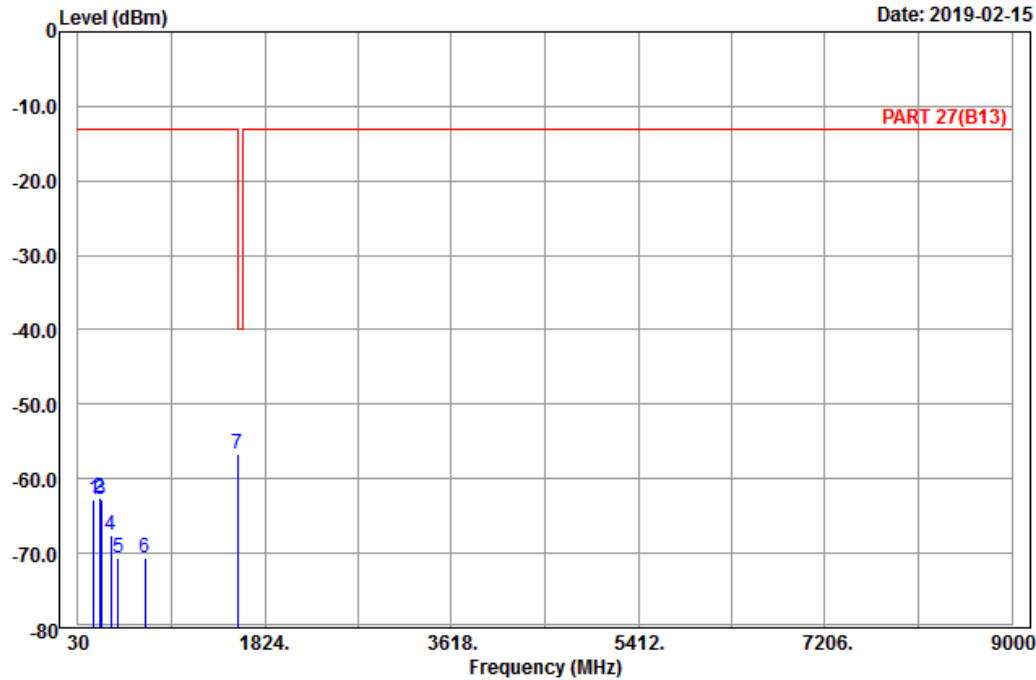

Site : 966 chamber 1
Condition: PART 27(B13) Horizontal
Remark : LTE_Band 13_Link_CH23230
Tested by: Karl Lee

	Read	Limit	Over				
Freq	Level	Level	Line	Limit	Factor	Remark	
MHz	dBm	dBm	dBm	dB	dB		
1	182.55	-62.84	-57.23	-13.00	-49.84	-5.61	Peak
2	235.74	-62.50	-56.80	-13.00	-49.50	-5.70	Peak
3	252.75	-62.87	-57.34	-13.00	-49.87	-5.53	Peak
4	346.90	-67.59	-62.18	-13.00	-54.59	-5.41	Peak
5	415.50	-70.56	-67.48	-13.00	-57.56	-3.08	Peak
6	675.90	-70.57	-70.31	-13.00	-57.57	-0.26	Peak
7 pp	1564.00	-56.68	-63.54	-40.00	-16.68	6.86	Peak



Bureau Veritas Consumer Products Services Ltd., Taoyuan Branch

A D T

Data: 10

Date: 2019-02-15

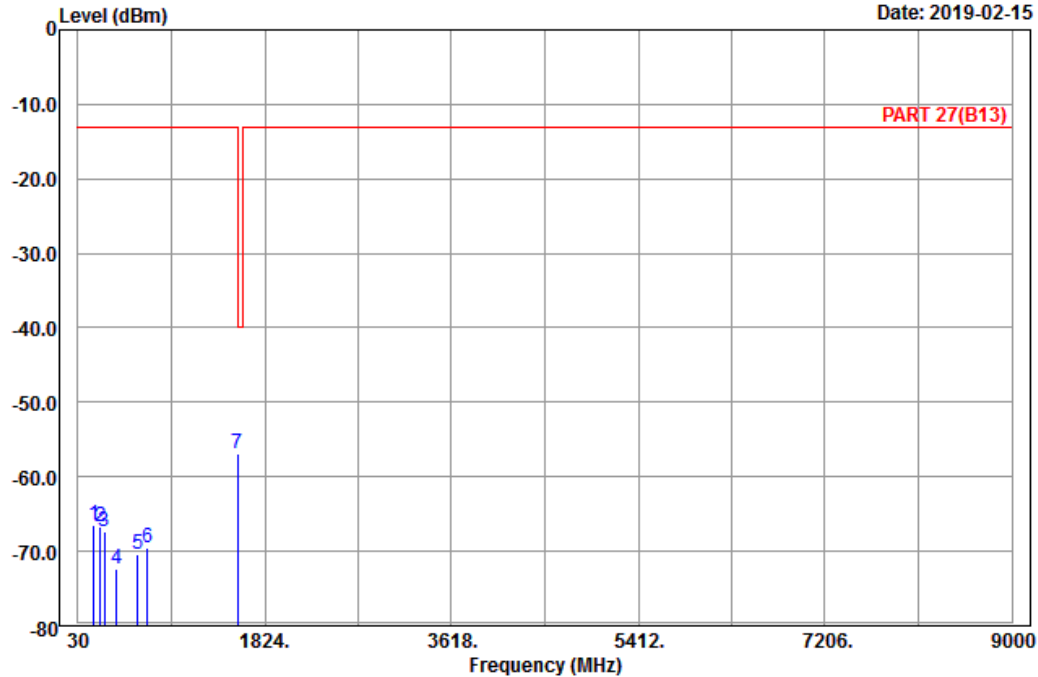

Site : 966 chamber 1
 Condition: PART 27(B13) Vertical
 Remark : LTE_Band 13_Link_CH23230
 Tested by: Karl Lee

	Freq	Level	Read Level	Limit Line	Over Limit	Factor	Remark
	MHz	dBm	dBm	dBm	dB	dB	
1	180.39	-66.45	-60.87	-13.00	-53.45	-5.58	Peak
2	247.89	-66.78	-61.25	-13.00	-53.78	-5.53	Peak
3	287.31	-67.38	-61.54	-13.00	-54.38	-5.84	Peak
4	402.90	-72.47	-69.67	-13.00	-59.47	-2.80	Peak
5	601.70	-70.45	-70.87	-13.00	-57.45	0.42	Peak
6	696.90	-69.47	-69.11	-13.00	-56.47	-0.36	Peak
7 pp	1564.00	-56.81	-63.67	-40.00	-16.81	6.86	Peak

5 Pictures of Test Arrangements

Please refer to the attached file (Test Setup Photo).

Appendix – Information of the Testing Laboratories

We, Bureau Veritas Consumer Products Services (H.K.) Ltd., Taoyuan Branch, were founded in 1988 to provide our best service in EMC, Radio, Telecom and Safety consultation. Our laboratories are FCC recognized accredited test firms and accredited according to ISO/IEC 17025.

If you have any comments, please feel free to contact us at the following:

Lin Kou EMC/RF Lab

Tel: 886-2-26052180

Fax: 886-2-26051924

Hsin Chu EMC/RF/Telecom Lab

Tel: 886-3-6668565

Fax: 886-3-6668323

Hwa Ya EMC/RF/Safety

Tel: 886-3-3183232

Fax: 886-3-3270892

Email: service.adt@tw.bureauveritas.com

Web Site: www.bureauveritas-adt.com

The address and road map of all our labs can be found in our web site also.

--- END ---