

# FCC Test Report

## (PART 90S)

**Report No.:** RF190211C01-10

**FCC ID:** B32CM5

**Test Model:** CM5

**Received Date:** Feb. 06, 2019

**Test Date:** Feb. 06, 2019 ~ Feb. 15, 2019

**Issued Date:** Mar. 20, 2019

**Applicant:** Verifone, Inc.

**Address:** 1400 West Stanford Ranch Road Suite 200 Rocklin CA 95765 USA

**Issued By:** Bureau Veritas Consumer Products Services (H.K.) Ltd., Taoyuan Branch

**Lab Address:** No. 47-2, 14th Ling, Chia Pau Vil., Lin Kou Dist., New Taipei City, Taiwan ( R.O.C )

**Test Location (1):** No. 19, Hwa Ya 2nd Rd, Wen Hwa Vil, Kwei Shan Dist., Taoyuan City 33383, Taiwan (R.O.C)

**Test Location (2):** B2F., No.215, Sec. 3, Beixin Rd., Xindian Dist., New Taipei City 231, Taiwan, R.O.C

**FCC Registration /  
Designation Number:** 427177 / TW0011



This report is for your exclusive use. Any copying or replication of this report to or for any other person or entity, or use of our name or trademark, is permitted only with our prior written permission. This report sets forth our findings solely with respect to the test samples identified herein. The results set forth in this report are not indicative or representative of the quality or characteristics of the lot from which a test sample was taken or any similar or identical product unless specifically and expressly noted. Our report includes all of the tests requested by you and the results thereof based upon the information that you provided to us. You have 60 days from date of issuance of this report to notify us of any material error or omission caused by our negligence, provided, however, that such notice shall be in writing and shall specifically address the issue you wish to raise. A failure to raise such issue within the prescribed time shall constitute your unqualified acceptance of the completeness of this report, the tests conducted and the correctness of the report contents. Unless specific mention, the uncertainty of measurement has been explicitly taken into account to declare the compliance or non-compliance to the specification. The report must not be used by the client to claim product certification, approval, or endorsement by TAF or any government agencies

## Table of Contents

<b>Release Control Record</b> .....	<b>3</b>
<b>1 Certificate of Conformity</b> .....	<b>4</b>
<b>2 Summary of Test Results</b> .....	<b>5</b>
2.1 Measurement Uncertainty .....	5
2.2 Test Site and Instruments .....	6
<b>3 General Information</b> .....	<b>7</b>
3.1 General Description of EUT .....	7
3.2 Configuration of System under Test .....	8
3.2.1 Description of Support Units .....	8
3.3 Test Mode Applicability and Tested Channel Detail .....	9
3.4 EUT Operating Conditions .....	10
3.5 General Description of Applied Standards .....	10
<b>4 Test Types and Results</b> .....	<b>11</b>
4.1 Output Power Measurement .....	11
4.1.1 Limits of Output Power Measurement .....	11
4.1.2 Test Procedures .....	11
4.1.3 Test Setup .....	12
4.1.4 Test Results .....	13
4.2 Modulation Characteristics Measurement .....	16
4.2.1 Limits of Modulation Characteristics .....	16
4.2.2 Test Setup .....	16
4.2.3 Test Procedure .....	16
4.2.4 Test Results .....	17
4.3 Frequency Stability Measurement .....	18
4.3.1 Limits of Frequency Stability Measurement .....	18
4.3.2 Test Procedure .....	18
4.3.3 Test Setup .....	18
4.3.4 Test Results .....	19
4.4 Occupied Bandwidth Measurement .....	23
4.4.1 Limits of Occupied Bandwidth Measurement .....	23
4.4.2 Test Procedure .....	23
4.4.3 Test Setup .....	23
4.4.4 Test Results .....	24
4.5 Emission Mask Measurement .....	26
4.5.1 Limits of Emission Mask Measurement .....	26
4.5.2 Test Setup .....	26
4.5.3 Test Procedures .....	26
4.5.4 Test Results .....	27
4.6 Conducted Spurious Emissions .....	35
4.6.1 Limits of Conducted Spurious Emissions Measurement .....	35
4.6.2 Test Setup .....	35
4.6.3 Test Procedure .....	35
4.6.4 Test Results .....	36
4.7 Radiated Emission Measurement .....	40
4.7.1 Limits of Radiated Emission Measurement .....	40
4.7.2 Test Procedure .....	40
4.7.3 Deviation from Test Standard .....	40
4.7.4 Test Setup .....	41
4.7.5 Test Results .....	42
<b>5 Pictures of Test Arrangements</b> .....	<b>56</b>
<b>Appendix – Information of the Testing Laboratories</b> .....	<b>57</b>

### Release Control Record

Issue No.	Description	Date Issued
RF190211C01-10	Original Release	Mar. 20, 2019

## 1 Certificate of Conformity

**Product:** Point of Sale Terminal

**Brand:** Verifone

**Test Model:** CM5

**Sample Status:** Identical Prototype

**Applicant:** Verifone, Inc.

**Test Date:** Feb. 06, 2019 ~ Feb. 15, 2019

**Standards:** FCC Part 90, Subpart I, S  
FCC Part 2

The above equipment has been tested by **Bureau Veritas Consumer Products Services (H.K.) Ltd., Taoyuan Branch**, and found compliance with the requirement of the above standards. The test record, data evaluation & Equipment Under Test (EUT) configurations represented herein are true and accurate accounts of the measurements of the sample's RF characteristics under the conditions specified in this report.

**Prepared by :** , **Date:** Mar. 20, 2019  
Ivonne Wu / Supervisor

**Approved by :** , **Date:** Mar. 20, 2019  
Dylan Chiou / Project Engineer

## 2 Summary of Test Results

Applied Standard: FCC Part 90 & Part 2 (LTE 26)			
FCC Clause	Test Item	Result	Remarks
2.1046 90.635 (b)	Effective Radiated Power	Pass	Meet the requirement of limit.
2.1047	Modulation Characteristics	Pass	Meet the requirement.
2.1055 90.213	Frequency Stability	Pass	Meet the requirement of limit.
2.1049 90.209	Occupied Bandwidth	Pass	Meet the requirement of limit.
2.1051 90.210	Emission Masks	Pass	Meet the requirement of limit.
2.1051 90.691	Conducted Spurious Emissions	Pass	Meet the requirement of limit.
2.1053 90.691	Radiated Spurious Emissions	Pass	Meet the requirement of limit. Minimum passing margin is -37.13 dB at 2457.00 MHz.

Note: Determining compliance based on the results of the compliance measurement, not taking into account measurement instrumentation uncertainty.

### 2.1 Measurement Uncertainty

Where relevant, the following measurement uncertainty levels have been estimated for tests performed on the EUT as specified in CISPR 16-4-2:

Measurement	Frequency	Expanded Uncertainty (k=2) (±)
Radiated Emissions up to 1 GHz	9 kHz ~ 30 MHz	3.0400 dB
	30 MHz ~ 200 MHz	2.0153 dB
	200 MHz ~ 1000 MHz	2.0224 dB
Radiated Emissions above 1 GHz	1 GHz ~ 18 GHz	1.0121 dB
	18 GHz ~ 40 GHz	1.1508 dB

## 2.2 Test Site and Instruments

Description & Manufacturer	Model No.	Serial No.	Date of Calibration	Due Date of Calibration
Test Receiver Agilent Technologies	N9038A	MY52260177	Aug. 20, 2018	Aug. 19, 2019
Spectrum Analyzer ROHDE & SCHWARZ	FSV40	100980	Apr. 17, 2018	Apr. 16, 2019
Spectrum Analyzer ROHDE & SCHWARZ	FSW26	102023	Oct. 11, 2018	Oct. 10, 2019
BILOG Antenna SCHWARZBECK	VULB9168	9168-616	Nov. 27, 2018	Nov. 26, 2019
HORN Antenna ETS-Lindgren	3117	00143293	Nov. 25, 2018	Nov. 24, 2019
HORN Antenna SCHWARZBECK	BBHA 9120D	9120D-969	Nov. 25, 2018	Nov. 24, 2019
Fixed Attenuator Mini-Circuits	MDCS18N-10	MDCS18N-10-01	Apr. 16, 2018	Apr. 15, 2019
MXG Vector signal generator Agilent	N5182B	MY53050430	Nov. 19, 2018	Nov. 18, 2019
Preamplifier Agilent	310N	187226	Jun. 19, 2018	Jun. 18, 2019
Preamplifier Agilent	83017A	MY39501357	Jun. 19, 2018	Jun. 18, 2019
RF signal cable ETS-LINDGREN	5D-FB	Cable-CH1-01(RFC -SMS-100-SMS-12 0+RFC-SMS-100-S MS-400)	Jun. 19, 2018	Jun. 18, 2019
RF signal cable ETS-LINDGREN	8D-FB	Cable-CH1-02(RFC -SMS-100-SMS-24)	Jun. 19, 2018	Jun. 18, 2019
Boresight Antenna Fixture	FBA-01	FBA-SIP01	NA	NA
Software BV ADT	E3 8.130425b	NA	NA	NA
Antenna Tower MF	NA	NA	NA	NA
Turn Table MF	NA	NA	NA	NA
Antenna Tower & Turn Table Controller MF	MF-7802	NA	NA	NA
Radio Communication Analyzer Anritsu	MT8820C	6201300640	Aug. 16, 2017	Aug. 15, 2019
Temperature & Humidity Chamber	GTH-120-40-CP-AR	MAA1306-019	Sep. 05, 2018	Sep. 04, 2019
DC Power Supply Topward	33010D	807748	NA	NA

- Note: 1. The calibration interval of the above test instruments is 12 / 24 months and the calibrations are traceable to NML/ROC and NIST/USA.
2. The test was performed in HsinTien Chamber 1.
3. The horn antenna and preamplifier (model: 83017A) are used only for the measurement of emission frequency above 1 GHz if tested.
4. The IC Site Registration No. is 7450I-1.

### 3 General Information

#### 3.1 General Description of EUT

<b>Product</b>	Point of Sale Terminal	
<b>Brand</b>	Verifone	
<b>Test Model</b>	CM5	
<b>Status of EUT</b>	Identical Prototype	
<b>Power Supply Rating</b>	5.0 Vdc (adapter or host equipment) 3.85 Vdc (Li-ion battery)	
<b>Modulation Type</b>	LTE	QPSK, 16QAM
<b>Frequency Range</b>	LTE Band 26 (Channel Bandwidth: 1.4 MHz)	814.7 ~ 823.3 MHz
	LTE Band 26 (Channel Bandwidth: 3 MHz)	815.5 ~ 822.5 MHz
	LTE Band 26 (Channel Bandwidth: 5 MHz)	816.5 ~ 821.5 MHz
	LTE Band 26 (Channel Bandwidth: 10 MHz)	819 MHz
<b>Emission Designator</b>	LTE Band 26 (Channel Bandwidth: 1.4 MHz)	1M09D7W
	LTE Band 26 (Channel Bandwidth: 3 MHz)	2M70G7D
	LTE Band 26 (Channel Bandwidth: 5 MHz)	4M50D7W
	LTE Band 26 (Channel Bandwidth: 10 MHz)	8M96G7D
<b>Max. ERP Power</b>	LTE Band 26 (Channel Bandwidth: 1.4 MHz)	87.70 mW
	LTE Band 26 (Channel Bandwidth: 3 MHz)	88.51 mW
	LTE Band 26 (Channel Bandwidth: 5 MHz)	89.33 mW
	LTE Band 26 (Channel Bandwidth: 10 MHz)	90.16 mW
<b>Antenna Type</b>	Fixed Internal Antenna with -1.8 dBi gain	
<b>Accessory Device</b>	Refer to Note as below	
<b>Data Cable Supplied</b>	Refer to Note as below	

Note:

1. The EUT's accessories list refers to Ext. Pho.
2. The above EUT information is declared by manufacturer and for more detailed features description, please refers to the manufacturer's specifications or user's manual.

### 3.2 Configuration of System under Test

#### <Radiated Emission Test>

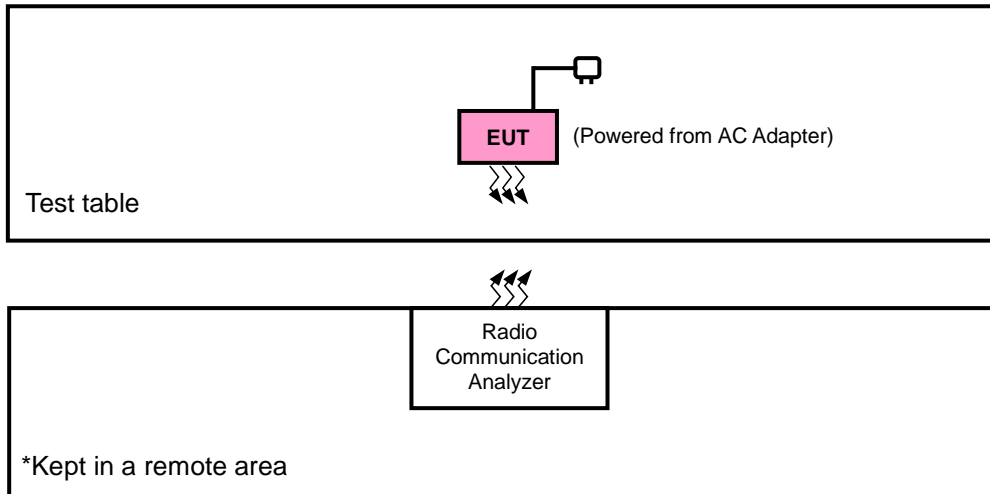

#### <E.R.P. Test>

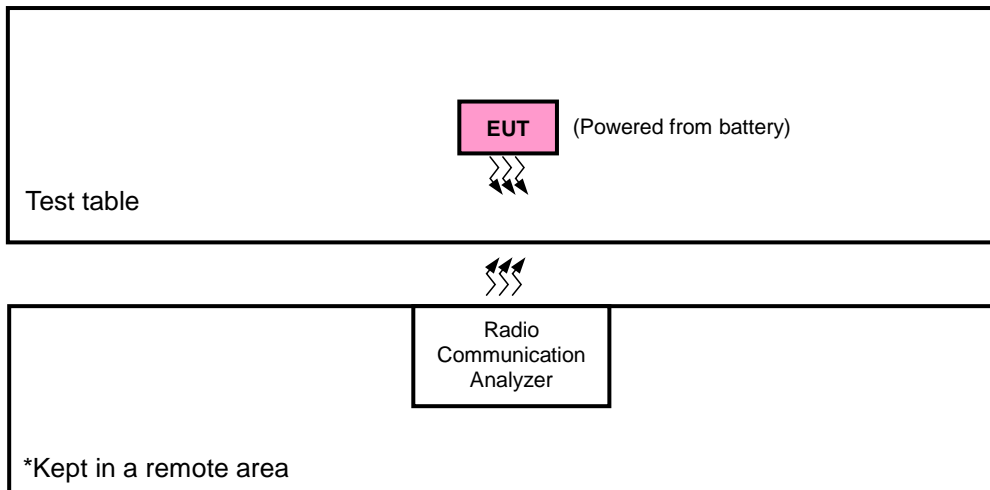

#### 3.2.1 Description of Support Units

The EUT has been tested as an independent unit together with other necessary accessories or support units.



### 3.3 Test Mode Applicability and Tested Channel Detail

Pre-Scan has been conducted to determine the worst-case mode from all possible combinations between available modulations, data rates, XYZ axis, and antenna ports

The worst case was found when positioned as the table below. Following channel(s) was (were) selected for the final test as listed below:

Band	ERP	Radiated Emission
LTE Band 26	X-plane	Y-axis

#### LTE Band 26

EUT Configure Mode	Test Item	Available Channel	Tested Channel	Channel Bandwidth	Modulation	Mode
-	ERP	26697 to 26783	26697, 26740, 26783	1.4 MHz	QPSK, 16QAM	1 RB / 0 RB Offset
		26705 to 26775	26705, 26740, 26775	3 MHz	QPSK, 16QAM	1 RB / 0 RB Offset
		26715 to 26765	26715, 26740, 26765	5 MHz	QPSK, 16QAM	1 RB / 0 RB Offset
		26740	26740	10 MHz	QPSK, 16QAM	1 RB / 0 RB Offset
-	Modulation Characteristics	26740	26740	10 MHz	QPSK, 16QAM	50 RB / 0 RB Offset
-	Frequency Stability	26697 to 26783	26697, 26783	1.4 MHz	QPSK	1 RB / 0 RB Offset
		26705 to 26775	26705, 26775	3 MHz	QPSK	1 RB / 0 RB Offset
		26715 to 26765	26715, 26765	5 MHz	QPSK	1 RB / 0 RB Offset
		26740	26740	10 MHz	QPSK	1 RB / 0 RB Offset
-	Occupied Bandwidth	26697 to 26783	26697, 26740, 26783	1.4 MHz	QPSK, 16QAM	6 RB / 0 RB Offset
		26705 to 26775	26705, 26740, 26775	3 MHz	QPSK, 16QAM	15 RB / 0 RB Offset
		26715 to 26765	26715, 26740, 26765	5 MHz	QPSK, 16QAM	25 RB / 0 RB Offset
		26740	26740	10 MHz	QPSK, 16QAM	50 RB / 0 RB Offset
-	Emission Mask	26697 to 26783	26697, 26740, 26783	1.4 MHz	QPSK, 16QAM	6 RB / 0 RB Offset
		26705 to 26775	26705, 26740, 26775	3 MHz	QPSK, 16QAM	15 RB / 0 RB Offset
		26715 to 26765	26715, 26740, 26765	5 MHz	QPSK, 16QAM	25 RB / 0 RB Offset
		26740	26740	10 MHz	QPSK, 16QAM	50 RB / 0 RB Offset
-	Conducted Emission	26697 to 26783	26697, 26740, 26783	1.4 MHz	QPSK	1 RB / 0 RB Offset
		26705 to 26775	26705, 26740, 26775	3 MHz	QPSK	1 RB / 0 RB Offset
		26715 to 26765	26715, 26740, 26765	5 MHz	QPSK	1 RB / 0 RB Offset
		26740	26740	10 MHz	QPSK	1 RB / 0 RB Offset
-	Radiated Emission	26697 to 26783	26697, 26740, 26783	1.4 MHz	QPSK	1 RB / 0 RB Offset
		26715 to 26765	26715, 26740, 26765	5 MHz	QPSK	1 RB / 0 RB Offset
		26740	26740	10 MHz	QPSK	1 RB / 0 RB Offset

#### Note:

1. This device was tested under all bandwidths, RB configurations and modulations. The worst case was found in QPSK modulation.
2. For radiated emission above 1 GHz, according to 3GPP 36.521 Section 6.6.3.1.4, choose the lowest, 5 MHz & highest channel bandwidth for final test.

**Test Condition:**

Test Item	Environmental Conditions	Input Power	Tested By
ERP	25 deg. C, 65 % RH	3.85 Vdc	Charles Hsiao
Frequency Stability	25 deg. C, 65 % RH	3.85 Vdc	Vincent Huang
Occupied Bandwidth	25 deg. C, 65 % RH	3.85 Vdc	Vincent Huang
Peak to Average Ratio	25 deg. C, 65 % RH	3.85 Vdc	Vincent Huang
Emission Mask	25 deg. C, 65 % RH	3.85 Vdc	Vincent Huang
Band Edge	25 deg. C, 65 % RH	3.85 Vdc	Vincent Huang
Conducted Emission	25 deg. C, 65 % RH	3.85 Vdc	Vincent Huang
Radiated Emission	25 deg. C, 65 % RH	120 Vac, 60 Hz	Charles Hsiao / Karl Lee

**3.4 EUT Operating Conditions**

The EUT makes a call to the communication simulator. The communication simulator station system controlled a EUT to export maximum output power under transmission mode and specific channel frequency

**3.5 General Description of Applied Standards**

The EUT is a RF Product. According to the specifications of the manufacturer, it must comply with the requirements of the following standards:

**FCC 47 CFR Part 2**

**FCC 47 CFR Part 90**

**KDB 971168 D01 Power Meas License Digital Systems v03r01**

**KDB 971168 D02 Misc Rev Approv License Devices v02r01**

**ANSI/TIA/EIA-603-E 2016**

**ANSI 63.26-2015**

**Note:** All test items have been performed and recorded as per the above standards.

## 4 Test Types and Results

### 4.1 Output Power Measurement

#### 4.1.1 Limits of Output Power Measurement

The maximum output power of the transmitter for mobile stations is 100 watts (20 dBw) ERP.

#### 4.1.2 Test Procedures

##### **EIRP / ERP Measurement:**

- a. All measurements were done at low, middle and high operational frequency range. RBW and VBW is 10 MHz for LTE mode.
- b. Substitution method is used for E.I.R.P measurement. In the semi-anechoic chamber, EUT placed on the 0.8 m (below or equal 1 GHz) and/or 1.5 m (above 1 GHz) height of Turn Table, rotated the table around 360 degrees to search the maximum radiation power and receiver antenna shall be rotated vertical and horizontal polarization and moved height from 1 m to 4 m to find the maximum polar radiated power. The "Read Value" is the spectrum reading the maximum power value.
- c. The substitution horn antenna is substituted for EUT at the same position and signals generator export the CW signal to the substitution antenna via a tx cable. Rotated the Turn Table and moved receiving antenna to find the maximum radiation power. Adjust output power level of S.G to get a Value of spectrum reading equal to "Read Value" of step b. Record the power level of S.G.
- d.  $EIRP = \text{Output power level of S.G} - \text{TX cable loss} + \text{Antenna gain of substitution horn}$ . E.R.P power can be calculated form E.I.R.P power by subtracting the gain of dipole,  $E.R.P \text{ power} = E.I.P.R \text{ power} - 2.15 \text{ dB}$ .

##### **Conducted Power Measurement:**

- a. The EUT was set up for the maximum power with LTE link data modulation and link up with simulator.
- b. Set the EUT to transmit under low, middle and high channel and record the power level shown on simulator.

4.1.3 Test Setup

**EIRP / ERP Measurement:**

**<Radiated Emission below or equal 1 GHz>**

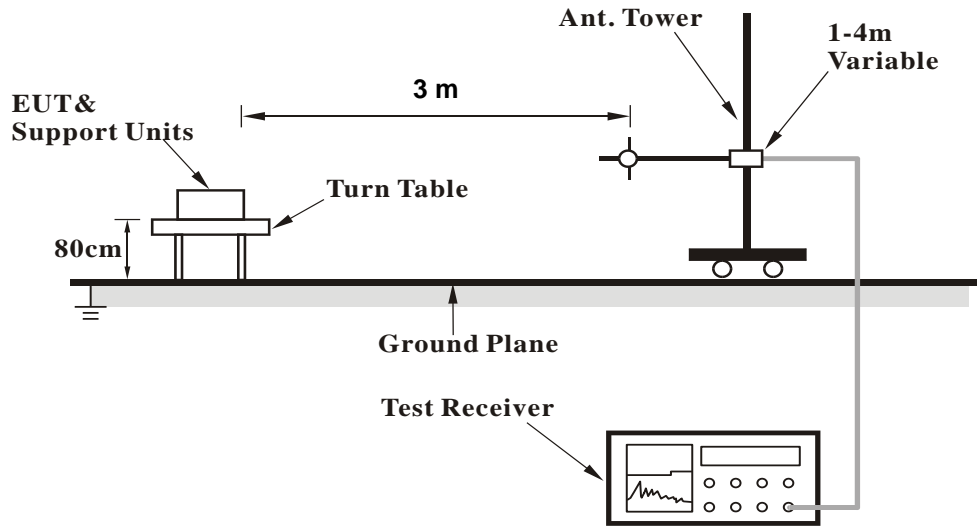

**<Radiated Emission above 1 GHz>**

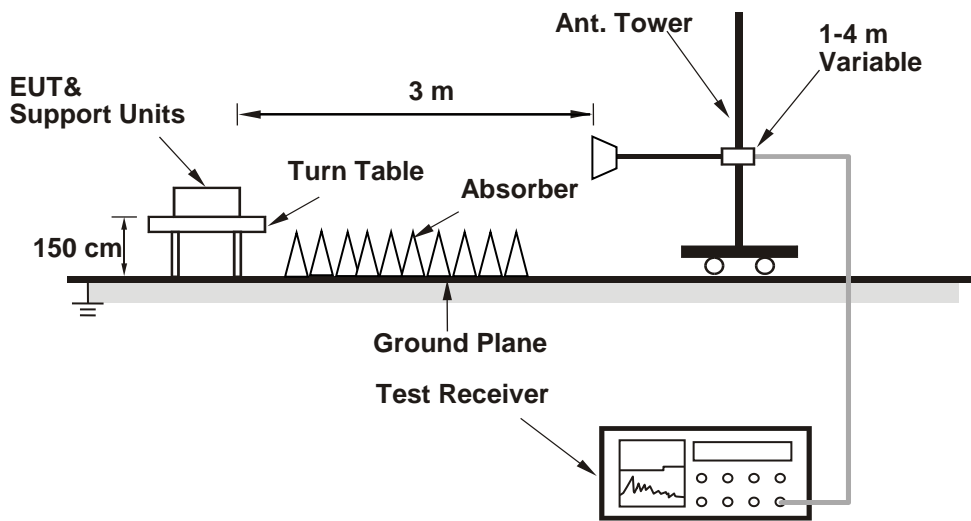

For the actual test configuration, please refer to the attached file (Test Setup Photo).

**Conducted Power Measurement:**



4.1.4 Test Results

Conducted Output Power (dBm)

LTE Band 26																	
BW	MCS Index	RB Size	RB Offset	Mid			3GPP MPR (dB)	BW	MCS Index	RB Size	RB Offset	Low	Mid	High	3GPP MPR (dB)		
				Channel	26740							26715	26740	26765			
				Frequency (MHz)	819.0							816.5	819.0	821.5			
10M	QPSK	1	0		23.30		0	5M	QPSK	1	0	23.16	23.30	23.33	0		
		1	24		22.87		0			1	12	22.88	22.87	22.92	0		
		1	49		23.14		0			1	24	23.11	23.14	23.20	0		
		25	0		22.04		1			12	0	21.94	22.04	22.11	1		
		25	12		21.94		1			12	6	21.96	21.94	22.02	1		
		25	25		22.06		1			12	13	22.02	22.06	22.15	1		
	16QAM	50	0		22.10		1		25	0	21.95	22.10	22.14	1			
		1	0		22.18		1		16QAM	1	0	22.08	22.18	22.25	1		
		1	24		21.70		1			1	12	21.56	21.70	21.74	1		
		1	49		22.00		1			1	24	21.84	22.00	22.02	1		
		25	0		21.08		2			12	0	20.96	21.08	21.13	2		
		25	12		20.97		2			12	6	21.01	20.97	21.06	2		
		25	25		21.11		2			12	13	21.07	21.11	21.17	2		
		50	0		21.01		2			25	0	21.05	21.01	21.07	2		
3M	QPSK	1	0	23.18	23.24	23.24	0	1.4M		QPSK	1	0	23.31	23.29	23.20	0	
		1	7	22.78	22.87	22.90	0		1		2	22.75	22.77	22.89	0		
		1	14	23.05	23.14	23.18	0		1		5	23.07	23.13	23.06	0		
		8	0	22.00	21.90	22.06	1		3		0	23.00	22.96	23.00	0		
		8	3	21.82	21.94	21.99	1		3		1	22.82	22.87	23.01	0		
		8	7	22.02	21.95	22.00	1		3		3	22.95	23.03	23.03	0		
		15	0	22.09	21.98	22.05	1		6		0	21.97	21.96	22.04	1		
		16QAM	1	0	22.25	22.16	22.21		1		16QAM	1	0	22.21	22.07	22.12	1
			1	7	21.60	21.56	21.62		1			1	2	21.59	21.67	21.62	1
	1		14	21.85	22.00	21.91	1		1	5		21.87	21.88	21.92	1		
	8		0	21.10	21.07	21.08	2		3	0		22.05	22.03	22.09	1		
	8		3	20.85	20.94	20.95	2		3	1		21.88	21.86	21.96	1		
	8		7	21.02	21.00	21.08	2		3	3		22.00	22.10	22.07	1		
	15		0	20.96	20.86	20.93	2		6	0		20.89	21.01	21.05	2		

**ERP Power (dBm)**

LTE Band 26							
Channel Bandwidth: 1.4 MHz / QPSK							
Plane	Channel	Frequency (MHz)	Reading (dBm)	Correction Factor (dB)	ERP (dBm)	ERP (mW)	Polarization (H/V)
X	26697	814.7	-9.86	31.208	19.20	83.14	H
	26740	819.0	-9.72	31.3	19.43	87.70	
	26783	823.3	-9.68	31.222	19.39	86.94	
	26697	814.7	-15.18	31.504	14.17	26.15	V
	26740	819.0	-14.57	31.117	14.40	27.52	
	26783	823.3	-15.42	31.922	14.35	27.24	
Channel Bandwidth: 1.4 MHz / 16QAM							
X	26697	814.7	-10.86	31.208	18.20	66.04	H
	26740	819.0	-10.73	31.3	18.42	69.50	
	26783	823.3	-10.69	31.222	18.38	68.90	
	26697	814.7	-16.19	31.504	13.16	20.72	V
	26740	819.0	-15.58	31.117	13.39	21.81	
	26783	823.3	-16.43	31.922	13.34	21.59	

Note: ERP (dBm) = Reading (dBm) + Correction Factor (dB) – 2.15

LTE Band 26							
Channel Bandwidth: 3 MHz / QPSK							
Plane	Channel	Frequency (MHz)	Reading (dBm)	Correction Factor (dB)	ERP (dBm)	ERP (mW)	Polarization (H/V)
X	26705	815.5	-9.82	31.208	19.24	83.91	H
	26740	819.0	-9.68	31.3	19.47	88.51	
	26775	822.5	-9.64	31.222	19.43	87.74	
	26705	815.5	-15.14	31.504	14.21	26.39	V
	26740	819.0	-14.54	31.117	14.43	27.71	
	26775	822.5	-15.38	31.922	14.39	27.49	
Channel Bandwidth: 3 MHz / 16QAM							
X	26705	815.5	-10.82	31.208	18.24	66.65	H
	26740	819.0	-10.69	31.3	18.46	70.15	
	26775	822.5	-10.65	31.222	18.42	69.53	
	26705	815.5	-16.15	31.504	13.20	20.91	V
	26740	819.0	-15.55	31.117	13.42	21.96	
	26775	822.5	-16.39	31.922	13.38	21.79	

Note: ERP (dBm) = Reading (dBm) + Correction Factor (dB) – 2.15

LTE Band 26							
Channel Bandwidth: 5 MHz / QPSK							
Plane	Channel	Frequency (MHz)	Reading (dBm)	Correction Factor (dB)	ERP (dBm)	ERP (mW)	Polarization (H/V)
X	26715	816.5	-9.78	31.208	19.28	84.68	H
	26740	819.0	-9.64	31.3	19.51	89.33	
	26765	821.5	-9.60	31.222	19.47	88.55	
	26715	816.5	-15.10	31.504	14.25	26.63	V
	26740	819.0	-14.50	31.117	14.47	27.97	
	26765	821.5	-15.34	31.922	14.43	27.75	
Channel Bandwidth: 5 MHz / 16QAM							
X	26715	816.5	-10.78	31.208	18.28	67.27	H
	26740	819.0	-10.65	31.3	18.50	70.79	
	26765	821.5	-10.61	31.222	18.46	70.18	
	26715	816.5	-16.11	31.504	13.24	21.11	V
	26740	819.0	-15.51	31.117	13.46	22.17	
	26765	821.5	-16.34	31.922	13.43	22.04	

Note: ERP (dBm) = Reading (dBm) + Correction Factor (dB) – 2.15

LTE Band 26							
Channel Bandwidth: 10 MHz / QPSK							
Plane	Channel	Frequency (MHz)	Reading (dBm)	Correction Factor (dB)	ERP (dBm)	ERP (mW)	Polarization (H/V)
X	26740	819.0	-9.60	31.3	19.55	90.16	H
	26740	819.0	-14.46	31.117	14.51	28.23	V
Channel Bandwidth: 10 MHz / 16QAM							
X	26740	819.0	-10.61	31.3	18.54	71.45	H
	26740	819.0	-15.46	31.117	13.51	22.42	V

Note: ERP (dBm) = Reading (dBm) + Correction Factor (dB) – 2.15

## 4.2 Modulation Characteristics Measurement

### 4.2.1 Limits of Modulation Characteristics

N/A

### 4.2.2 Test Setup



### 4.2.3 Test Procedure

Connect the EUT to Communication Simulator via the antenna connector. The frequency band is set as EUT supported Modulation and Channels, the EUT output is matched with 50 ohm load, the waveform quality and constellation of the EUT was tested.



### 4.2.4 Test Results

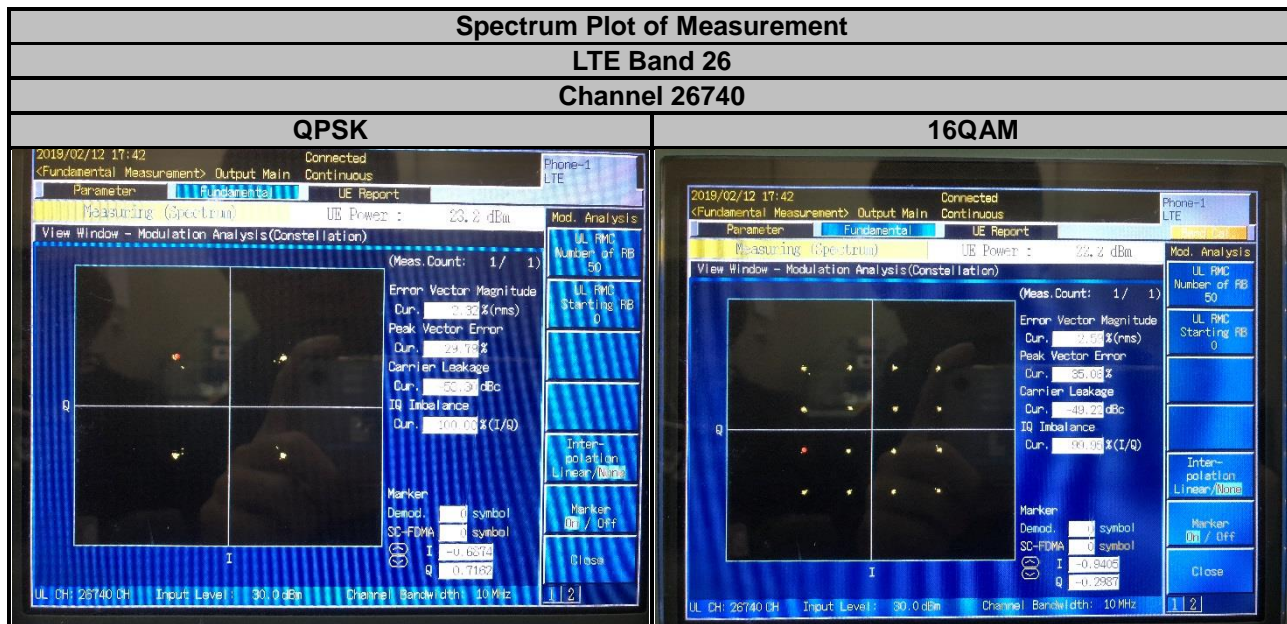

### 4.3 Frequency Stability Measurement

#### 4.3.1 Limits of Frequency Stability Measurement

1.5 ppm is for base and fixed station. 2.5 ppm is for mobile station.

#### 4.3.2 Test Procedure

- a. Device is placed at the oven room. The oven room could control the temperatures and humidity. Power warm up is at least 15 min and power applied should perform before recording frequency error.
- b. EUT is connected the external power supply to control the DC input power. The test voltage range is from minimum to maximum working voltage. Each step shall be record the frequency error rate.
- c. The temperature range step is 10 degrees in this test items. All temperature levels shall be hold the  $\pm 0.5$  °C during the measurement testing. The each temperature step shall be at least 0.5 hours, consider the EUT could be test under the stability condition.

**NOTE:** The frequency error was recorded frequency error from the communication simulator.

#### 4.3.3 Test Setup

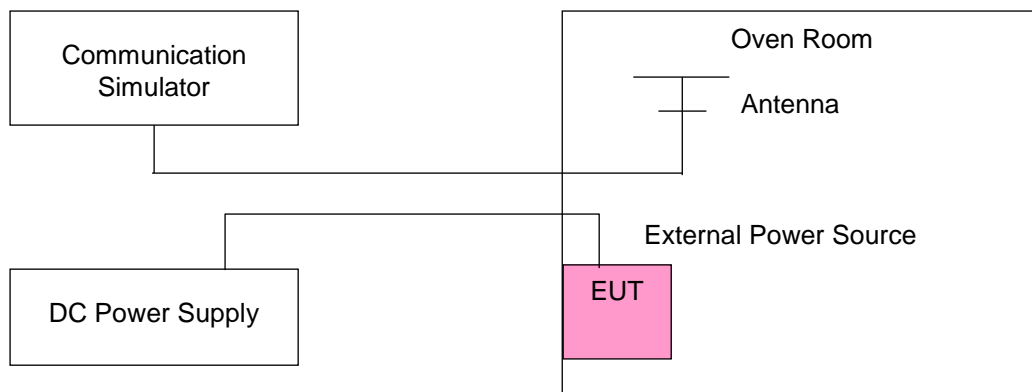

#### 4.3.4 Test Results

##### Frequency Error vs. Voltage

Voltage (Volts)	LTE Band 26				Limit (ppm)
	Channel Bandwidth: 1.4 MHz				
	Low Channel		High Channel		
	Frequency (MHz)	Frequency Error (ppm)	Frequency (MHz)	Frequency Error (ppm)	
3.85	814.700004	0.005	823.300000	0.002	2.5
3.27	814.700001	0.002	823.300000	0.002	2.5
4.43	814.700002	0.003	823.300000	0.003	2.5

**Note:** The applicant defined the normal working voltage of the battery is from 3.27 Vdc to 4.43 Vdc.

##### Frequency Error vs. Temperature

Temp. (°C)	LTE Band 26				Limit (ppm)
	Channel Bandwidth: 1.4 MHz				
	Low Channel		High Channel		
	Frequency (MHz)	Frequency Error (ppm)	Frequency (MHz)	Frequency Error (ppm)	
-30	814.700003	0.004	823.300000	0.004	2.5
-20	814.700002	0.002	823.300000	0.001	2.5
-10	814.700002	0.002	823.300000	0.005	2.5
0	814.700004	0.004	823.300000	0.001	2.5
10	814.700002	0.002	823.300000	0.003	2.5
20	814.699998	-0.003	823.300000	-0.005	2.5
30	814.699997	-0.004	823.300000	-0.001	2.5
40	814.699998	-0.002	823.300000	-0.002	2.5
50	814.699997	-0.004	823.300000	-0.004	2.5
55	814.699996	-0.005	823.300000	-0.003	2.5

Frequency Error vs. Voltage

Voltage (Volts)	LTE Band 26				Limit (ppm)
	Channel Bandwidth: 3 MHz				
	Low Channel		High Channel		
	Frequency (MHz)	Frequency Error (ppm)	Frequency (MHz)	Frequency Error (ppm)	
3.85	815.500002	0.003	822.500000	0.004	2.5
3.27	815.500002	0.003	822.500000	0.001	2.5
4.43	815.500001	0.001	822.500000	0.004	2.5

**Note:** The applicant defined the normal working voltage of the battery is from 3.27 Vdc to 4.43 Vdc.

Frequency Error vs. Temperature

Temp. (°C)	LTE Band 26				Limit (ppm)
	Channel Bandwidth: 3 MHz				
	Low Channel		High Channel		
	Frequency (MHz)	Frequency Error (ppm)	Frequency (MHz)	Frequency Error (ppm)	
-30	815.500004	0.004	822.500000	0.003	2.5
-20	815.500004	0.005	822.500000	0.003	2.5
-10	815.500004	0.004	822.500000	0.003	2.5
0	815.500001	0.001	822.500000	0.003	2.5
10	815.500002	0.002	822.500000	0.001	2.5
20	815.499999	-0.002	822.500000	-0.002	2.5
30	815.499998	-0.002	822.500000	-0.002	2.5
40	815.499998	-0.002	822.500000	-0.003	2.5
50	815.499999	-0.001	822.500000	-0.004	2.5
55	815.499999	-0.001	822.500000	-0.004	2.5

Frequency Error vs. Voltage

Voltage (Volts)	LTE Band 26				Limit (ppm)
	Channel Bandwidth: 5 MHz				
	Low Channel		High Channel		
	Frequency (MHz)	Frequency Error (ppm)	Frequency (MHz)	Frequency Error (ppm)	
3.85	816.500003	0.004	821.500000	0.005	2.5
3.27	816.500004	0.004	821.500000	0.003	2.5
4.43	816.500003	0.003	821.500000	0.003	2.5

**Note:** The applicant defined the normal working voltage of the battery is from 3.27 Vdc to 4.43 Vdc.

Frequency Error vs. Temperature

Temp. (°C)	LTE Band 26				Limit (ppm)
	Channel Bandwidth: 5 MHz				
	Low Channel		High Channel		
	Frequency (MHz)	Frequency Error (ppm)	Frequency (MHz)	Frequency Error (ppm)	
-30	816.500001	0.001	821.500000	0.005	2.5
-20	816.500003	0.004	821.500000	0.002	2.5
-10	816.500002	0.003	821.500000	0.002	2.5
0	816.500001	0.001	821.500000	0.001	2.5
10	816.500004	0.004	821.500000	0.003	2.5
20	816.499999	-0.002	821.500000	-0.005	2.5
30	816.499999	-0.001	821.500000	-0.001	2.5
40	816.499998	-0.002	821.500000	-0.004	2.5
50	816.499998	-0.003	821.500000	-0.003	2.5
55	816.499999	-0.001	821.500000	-0.005	2.5

## Frequency Error vs. Voltage

Voltage (Volts)	LTE Band 26		Limit (ppm)
	Channel Bandwidth: 10 MHz		
	Frequency (MHz)	Frequency Error (ppm)	
3.85	819.000001	0.001	2.5
3.27	819.000004	0.005	2.5
4.43	819.000001	0.002	2.5

**Note:** The applicant defined the normal working voltage of the battery is from 3.27 Vdc to 4.43 Vdc.

## Frequency Error vs. Temperature

Temp. (°C)	LTE Band 26		Limit (ppm)
	Channel Bandwidth: 10 MHz		
	Frequency (MHz)	Frequency Error (ppm)	
-30	819.000001	0.002	2.5
-20	819.000002	0.002	2.5
-10	819.000004	0.005	2.5
0	819.000004	0.005	2.5
10	819.000001	0.001	2.5
20	818.999999	-0.002	2.5
30	818.999998	-0.002	2.5
40	818.999997	-0.004	2.5
50	818.999996	-0.005	2.5
55	818.999996	-0.005	2.5

#### 4.4 Occupied Bandwidth Measurement

##### 4.4.1 Limits of Occupied Bandwidth Measurement

The width of a frequency band such that, below the lower and above the upper frequency limits, the mean powers emitted are each equal to a specified percentage 0.5 % of the total mean power of a given emission.

##### 4.4.2 Test Procedure

The EUT makes a call to the communication simulator. All measurements were done at low, middle and high operational frequency range. The communication simulator station system controlled a EUT to export maximum output power under transmission mode and specific channel frequency. Use OBW measurement function of Spectrum analyzer to measure 99 % occupied bandwidth.

##### 4.4.3 Test Setup

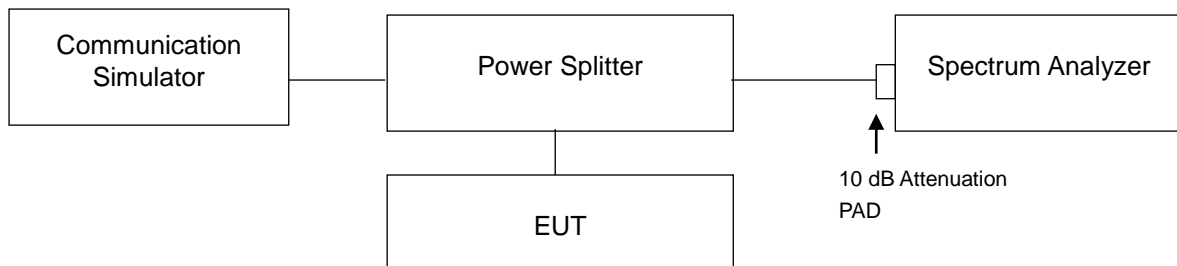

#### 4.4.4 Test Results

LTE Band 26					
Channel Bandwidth: 1.4 MHz					
Channel	Frequency (MHz)	99 % Occupied Bandwidth (MHz)		26 dB Bandwidth (MHz)	
		QPSK	16QAM	QPSK	16QAM
26697	814.7	1.0883	1.0909	1.261	1.253
26740	819.0	1.0884	1.0904	1.255	1.255
26783	823.3	1.0882	1.0922	1.255	1.251
Channel Bandwidth: 3 MHz					
Channel	Frequency (MHz)	99 % Occupied Bandwidth (MHz)		26 dB Bandwidth (MHz)	
		QPSK	16QAM	QPSK	16QAM
26705	815.5	2.7027	2.6978	2.923	2.920
26740	819.0	2.7019	2.6988	2.927	2.927
26775	822.5	2.7043	2.6986	2.933	2.931





LTE Band 26					
Channel Bandwidth: 5 MHz					
Channel	Frequency (MHz)	99 % Occupied Bandwidth (MHz)		26 dB Bandwidth (MHz)	
		QPSK	16QAM	QPSK	16QAM
26715	816.5	4.4930	4.4938	4.844	4.820
26740	819.0	4.4966	4.4990	4.837	4.847
26765	821.5	4.4968	4.4974	4.842	4.833

Channel Bandwidth: 10 MHz					
Channel	Frequency (MHz)	99 % Occupied Bandwidth (MHz)		26 dB Bandwidth (MHz)	
		QPSK	16QAM	QPSK	16QAM
26740	819.0	8.9604	8.9577	9.521	9.532



## 4.5 Emission Mask Measurement

### 4.5.1 Limits of Emission Mask Measurement

According to FCC part 90.691 shall be tested the emission mask. For any frequency removed from the EA licensee's frequency block by up to and including 37.5 kHz, the power of any emission shall be attenuated below the transmitter power (P) in watts by at least  $116 \text{ Log}_{10}(f/6.1)$  decibels or  $50 + 10\text{Log}_{10}(P)$  decibels or 80 decibels, whichever is the lesser attenuation, where f is the frequency removed from the center of the outer channel in the block in kilohertz and where f is greater than 12.5 kHz.

For any frequency removed from the EA licensee's frequency block greater than 37.5 kHz, the power of any emission shall be attenuated below the transmitter power (P) in watts by at least  $43 + 10\text{Log}_{10}(P)$  decibels or 80 decibels, whichever is the lesser attenuation, where f is the frequency removed from the center of the outer channel in the block in kilohertz and where f is greater than 37.5 kHz.

For §90.691(a), RBW=300 Hz for offset less than 37.5 kHz from channel edge and RBW=100 kHz for offsets greater than 37.5 kHz is allowed.

### 4.5.2 Test Setup

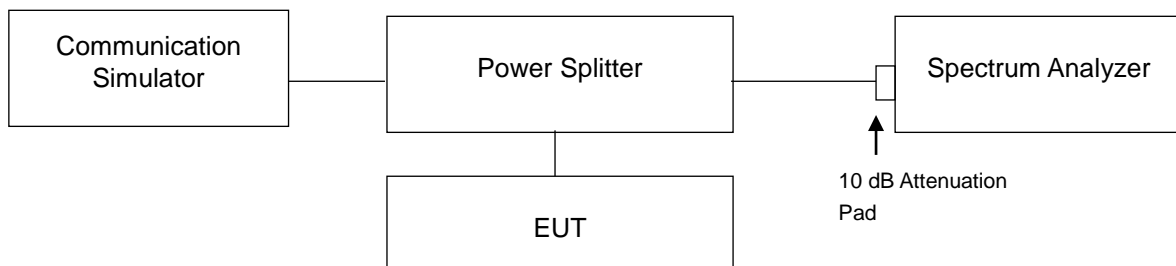

### 4.5.3 Test Procedures

- The measurement used the power splitter via EUT RF power connector between simulation base station and spectrum analyzer.
- Record the test plot.

### 4.5.4 Test Results

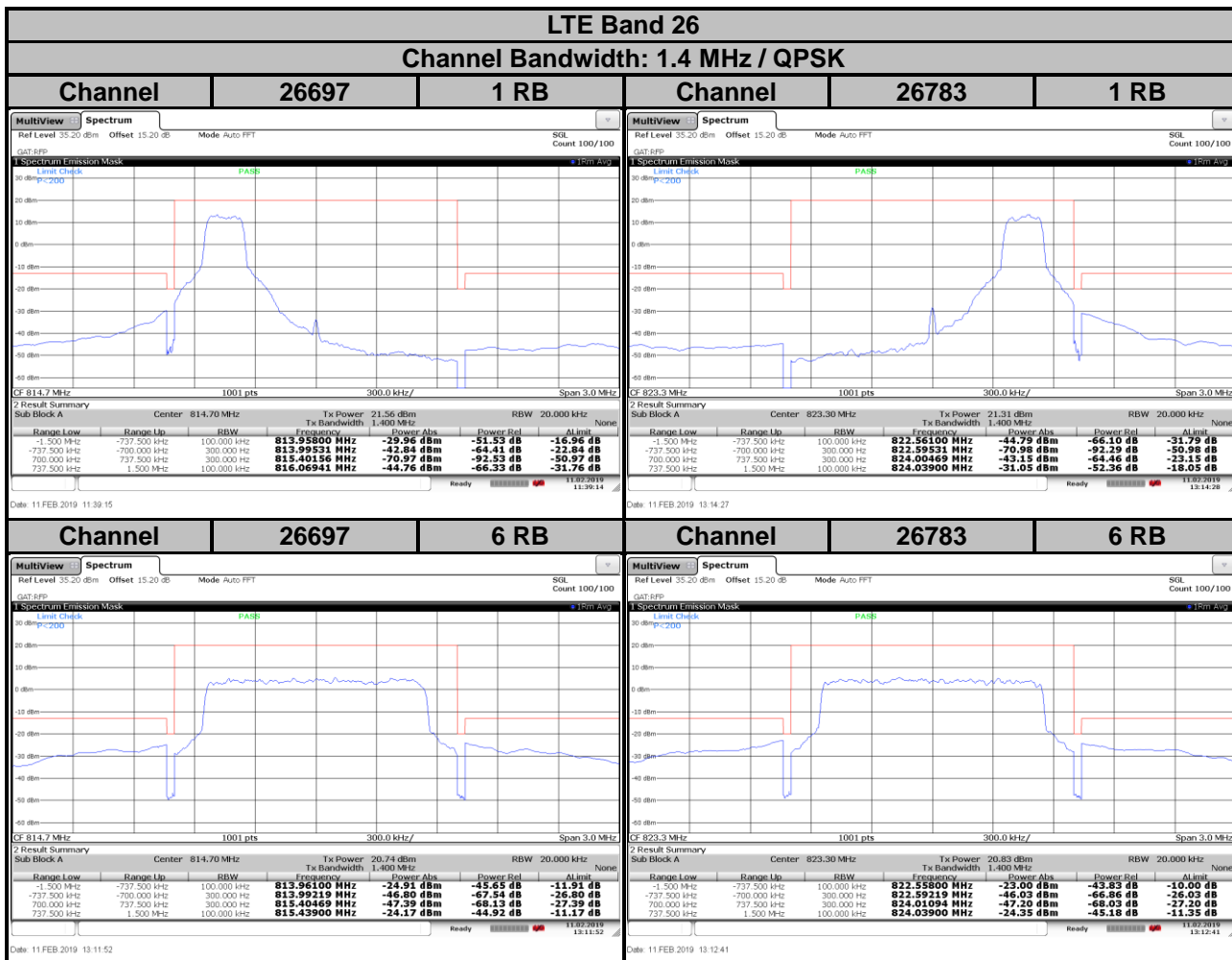

### LTE Band 26

### Channel Bandwidth: 1.4 MHz / 16QAM

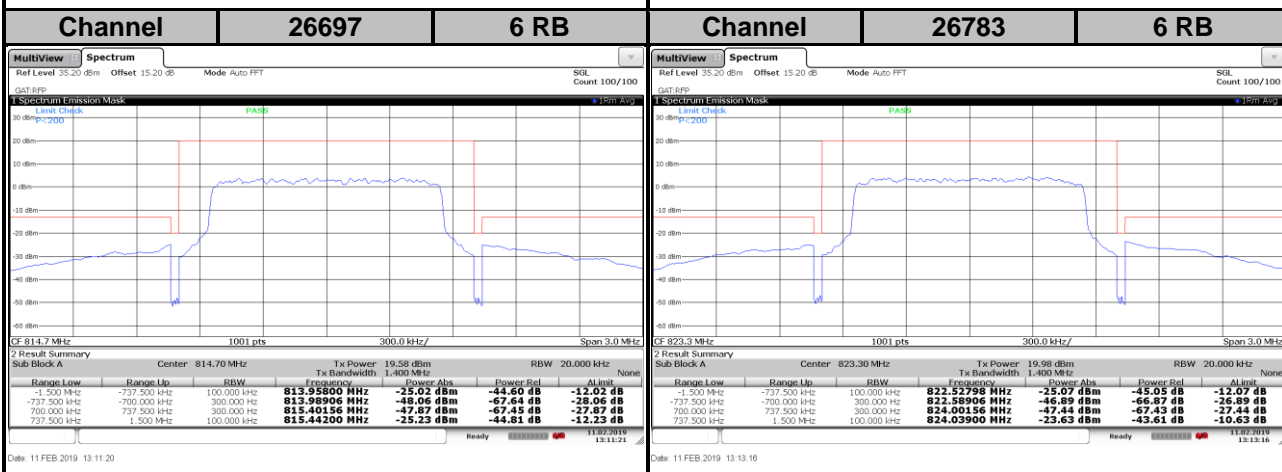
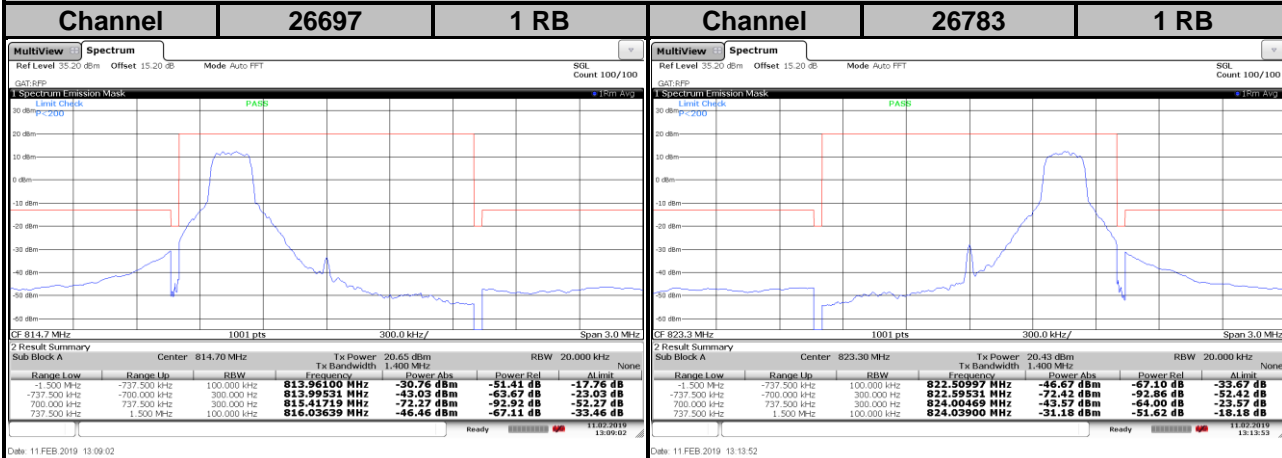

### LTE Band 26

### Channel Bandwidth: 3 MHz / QPSK

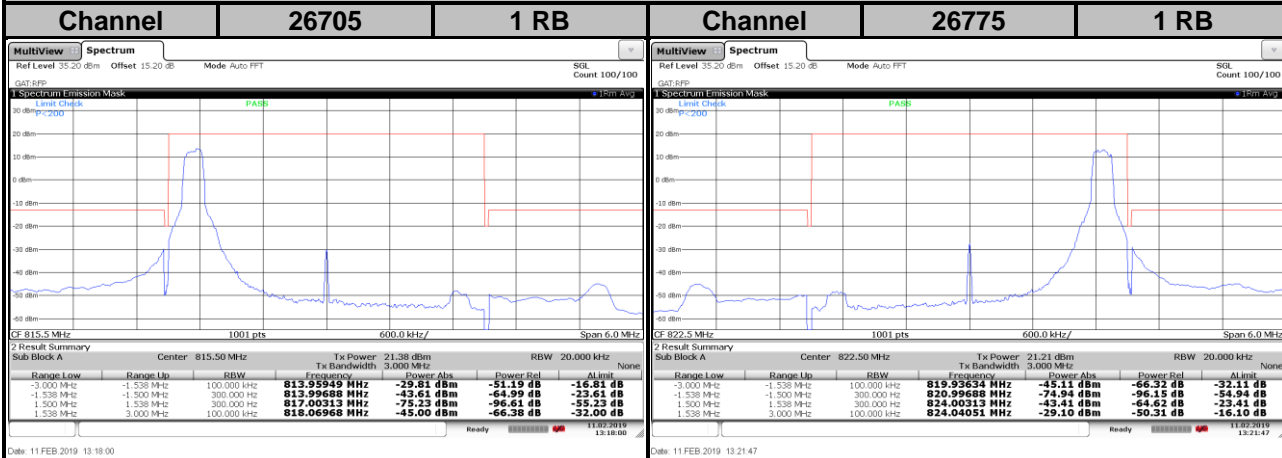

Date: 11 FEB 2019 13:18:00      Date: 11 FEB 2019 13:21:47

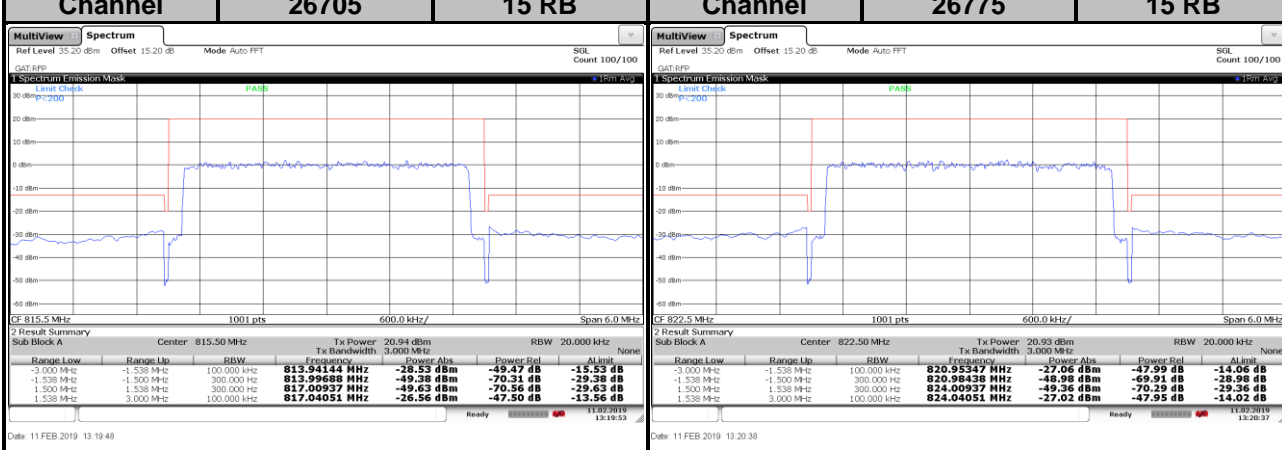

Date: 11 FEB 2019 13:19:48      Date: 11 FEB 2019 13:20:38

### LTE Band 26

Channel Bandwidth: 3 MHz / 16QAM

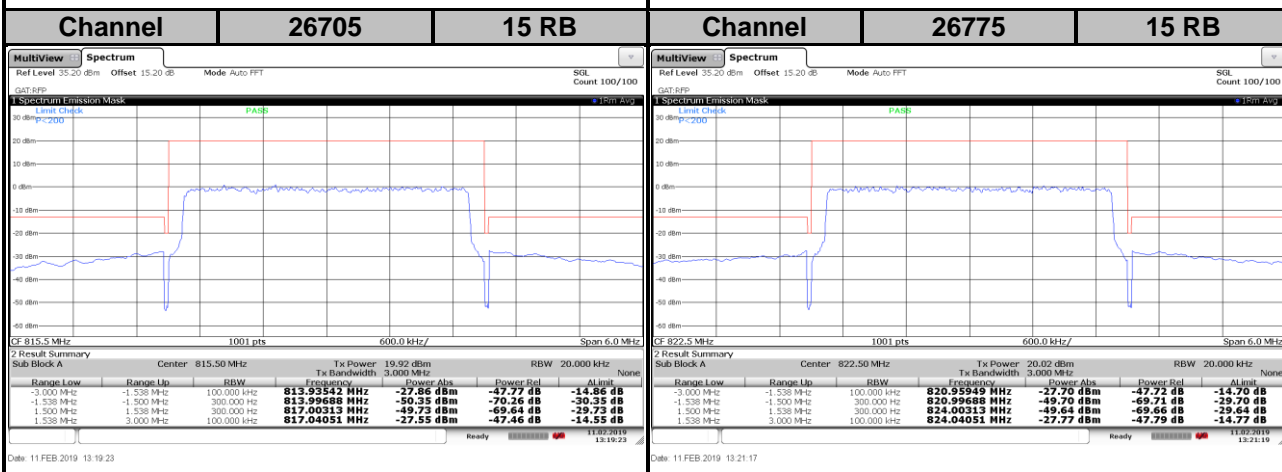
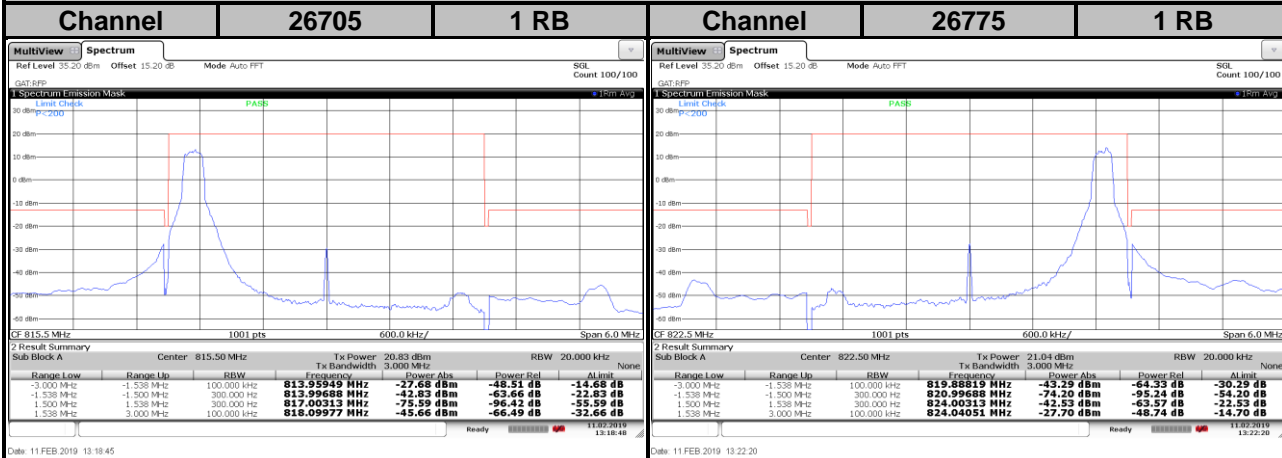

### LTE Band 26

### Channel Bandwidth: 5 MHz / QPSK

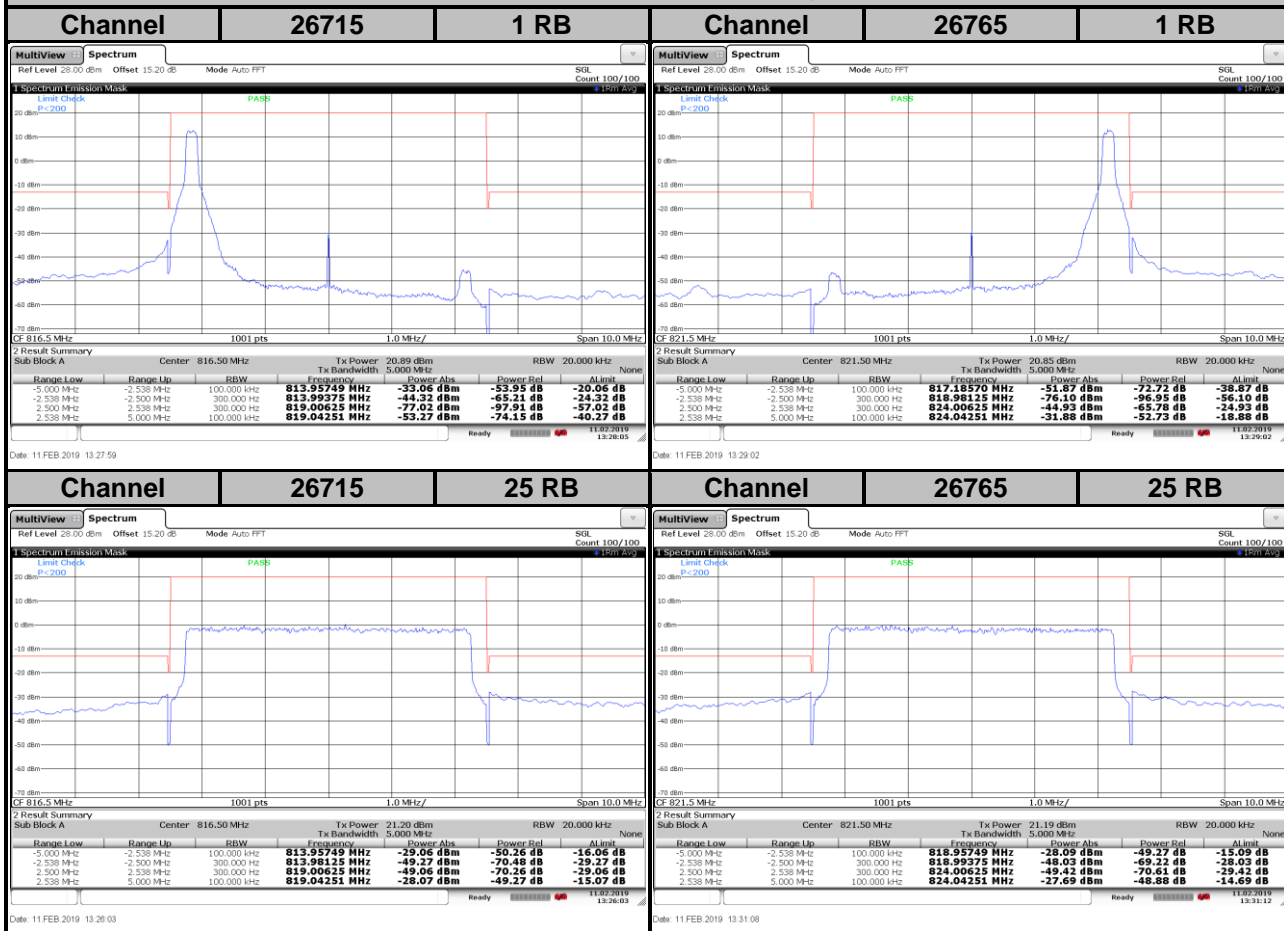

### LTE Band 26

Channel Bandwidth: 5 MHz / 16QAM

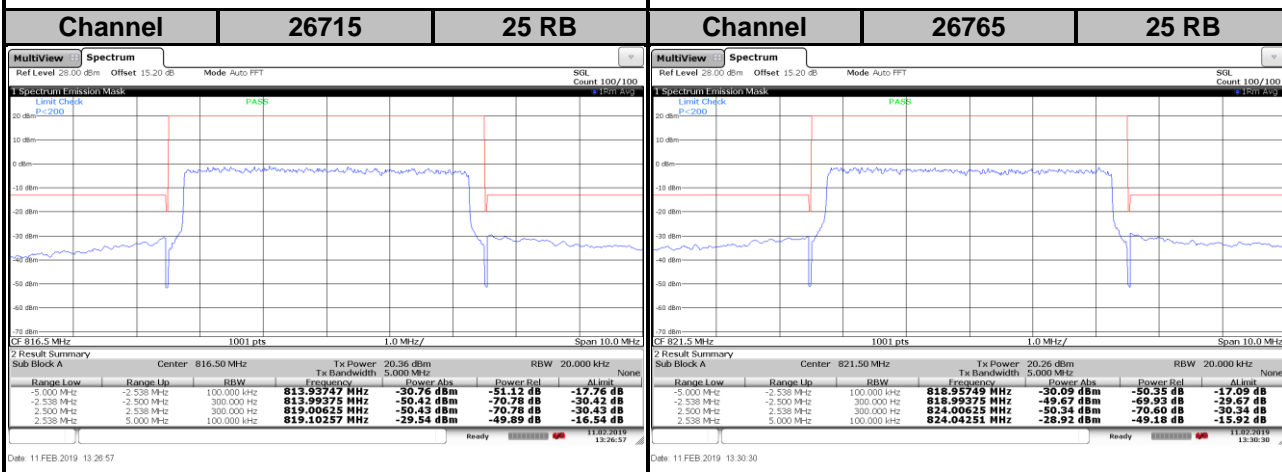
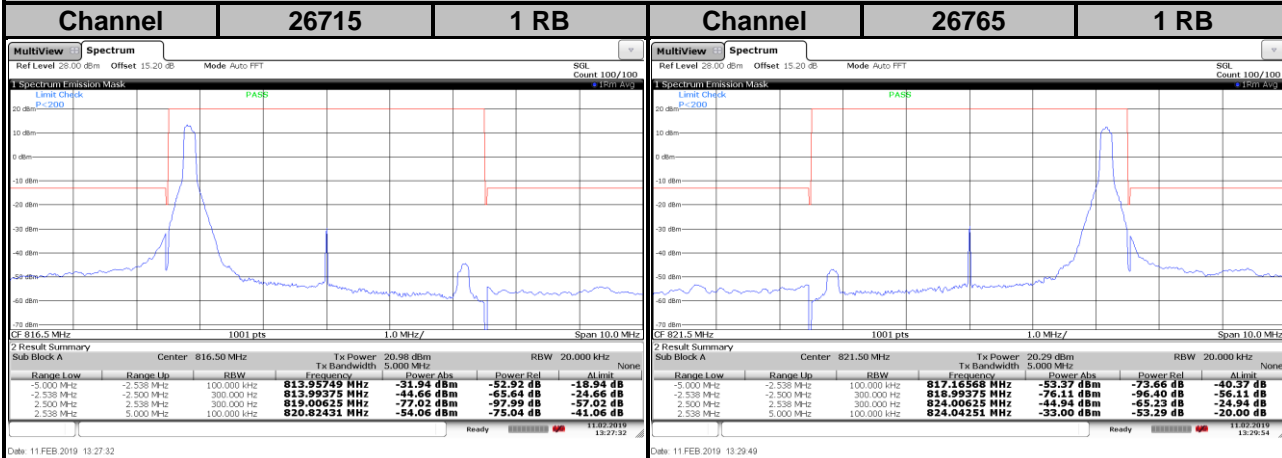



### LTE Band 26

Channel Bandwidth: 10 MHz / QPSK

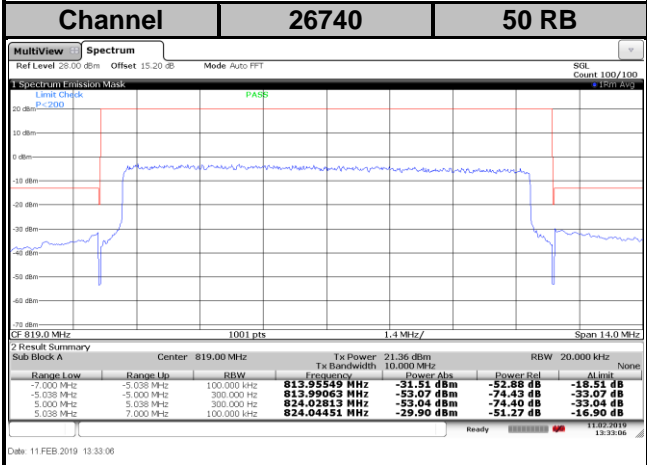
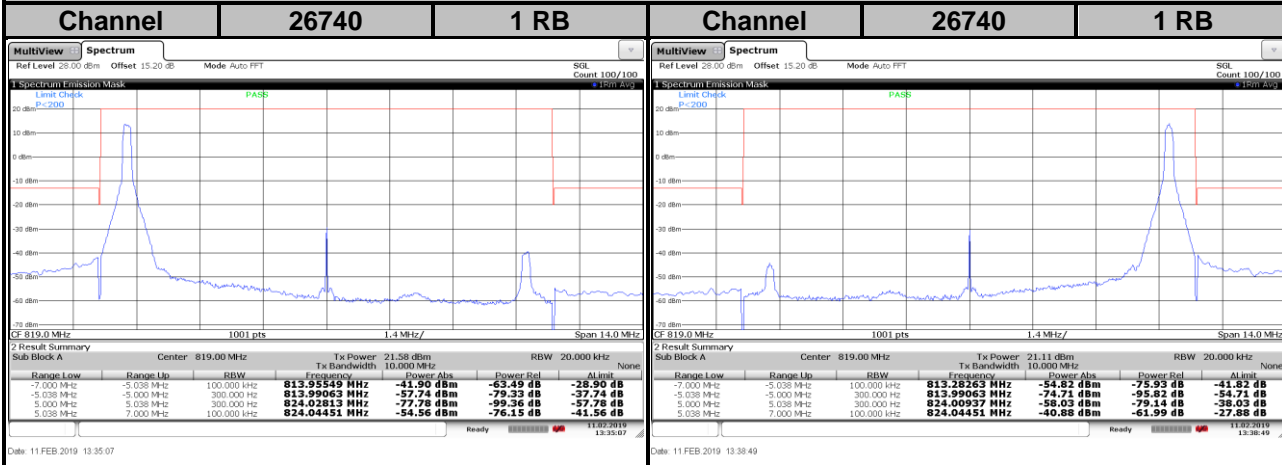

### LTE Band 26

Channel Bandwidth: 10 MHz / 16QAM

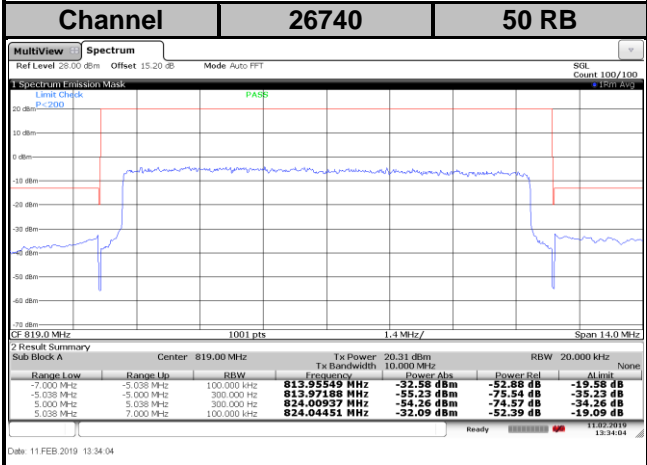
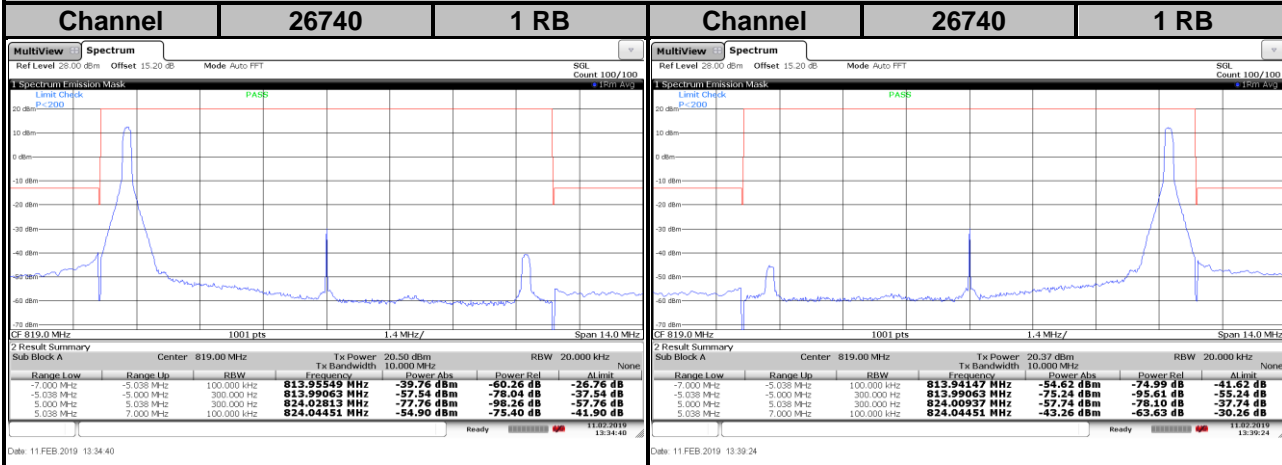

## 4.6 Conducted Spurious Emissions

### 4.6.1 Limits of Conducted Spurious Emissions Measurement

The power of any emission outside a licensee's frequency block shall be attenuated below the transmitter power (P) by at least  $43 + 10 \log_{10}(P)$  dB. The limit of emission is equal to -13 dBm.

### 4.6.2 Test Setup

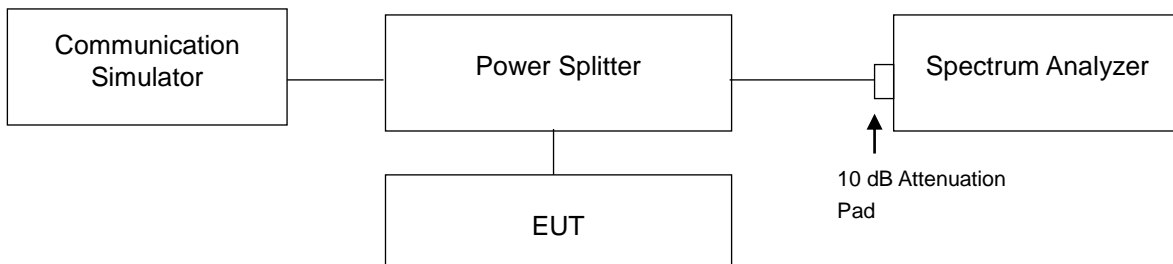

### 4.6.3 Test Procedure

- The EUT makes a phone call to the communication simulator. All measurements were done at low, middle and high operational frequency range.
- Measuring frequency range is from 9 kHz to 1 GHz. 10 dB attenuation pad is connected with spectrum. RBW = 100 kHz and VBW = 300 kHz are used for conducted emission measurement.
- Measuring frequency range is from 1 GHz to 9 GHz. 10 dB attenuation pad is connected with spectrum. RBW = 1 MHz and VBW = 3 MHz are used for conducted emission measurement.

#### 4.6.4 Test Results

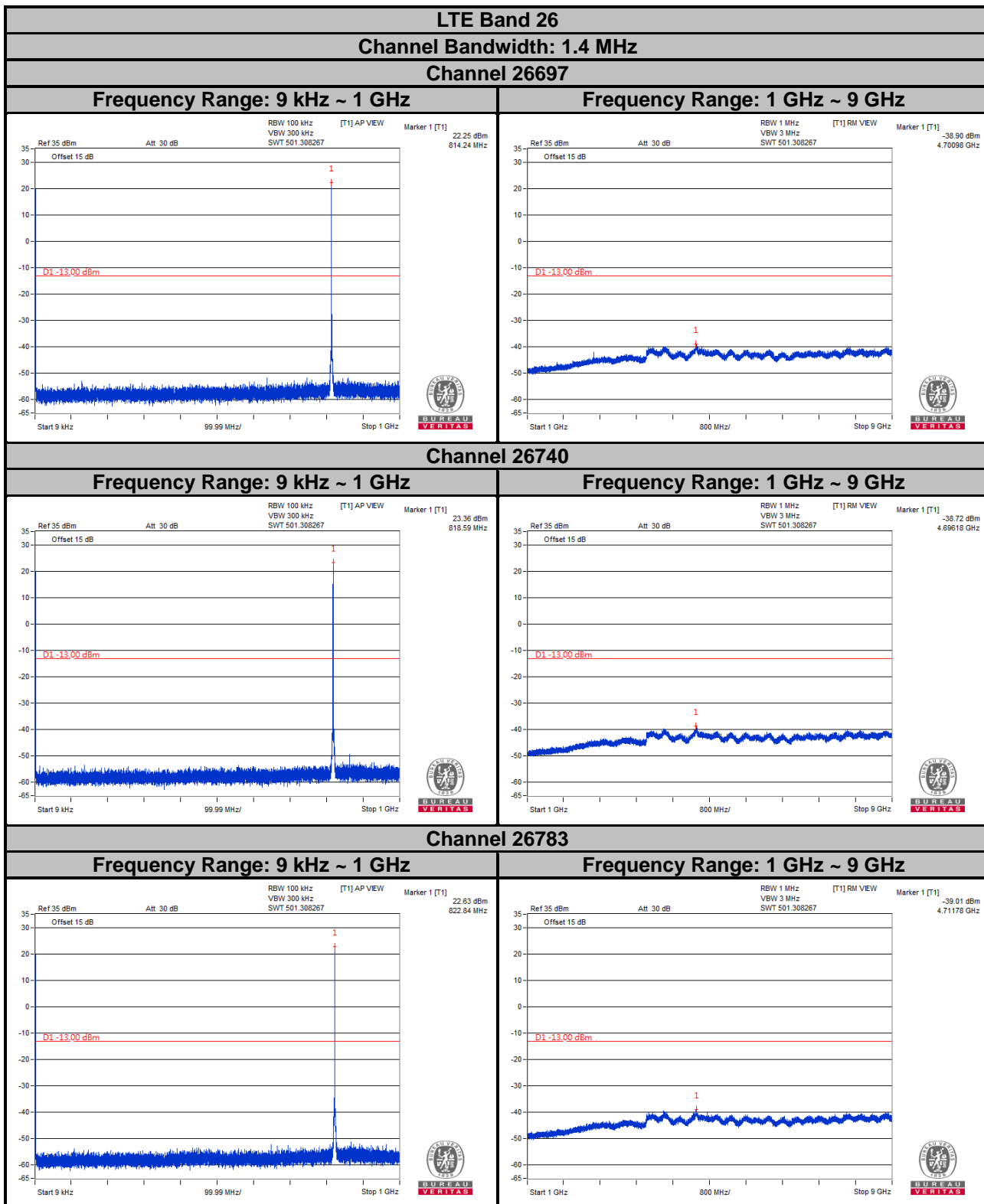

Note: The signal over the limit in 9 kHz is from spectrum analyzer.

**LTE Band 26**  
**Channel Bandwidth: 3 MHz**  
**Channel 26705**

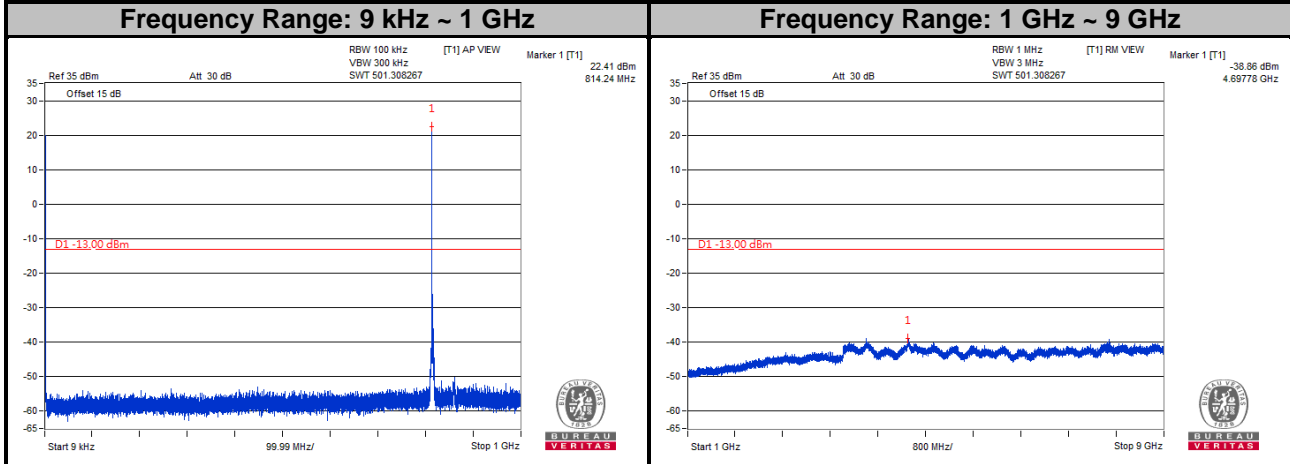

**Channel 26740**

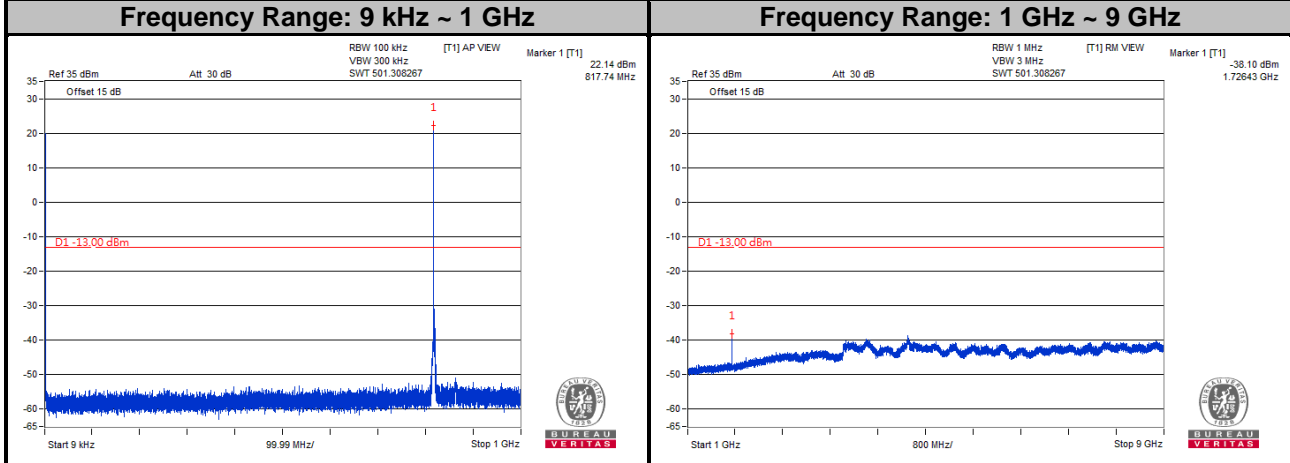

**Channel 26775**

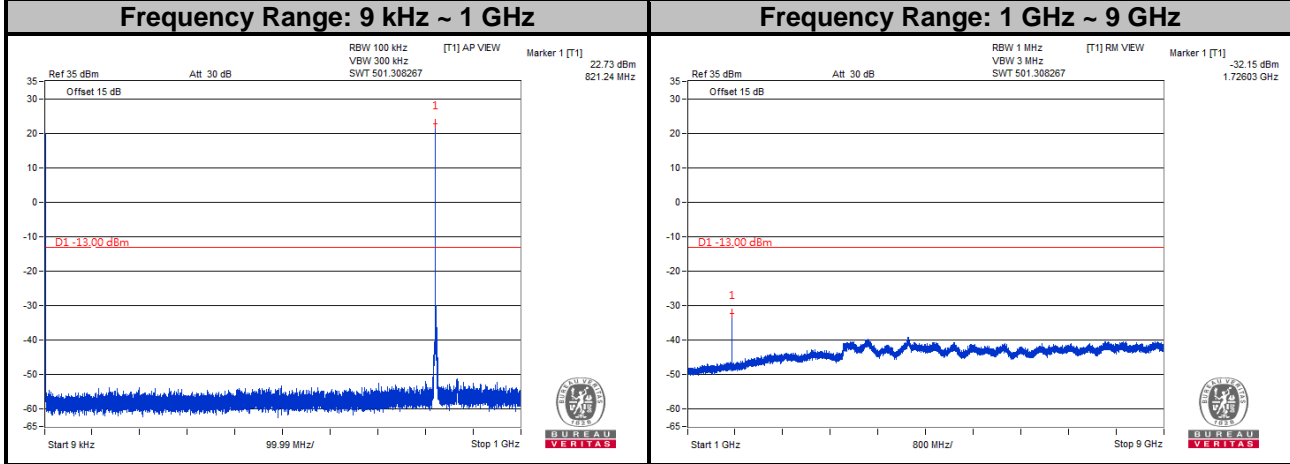

Note: The signal over the limit in 9 kHz is from spectrum analyzer.

**LTE Band 26**  
**Channel Bandwidth: 5 MHz**  
**Channel 26715**

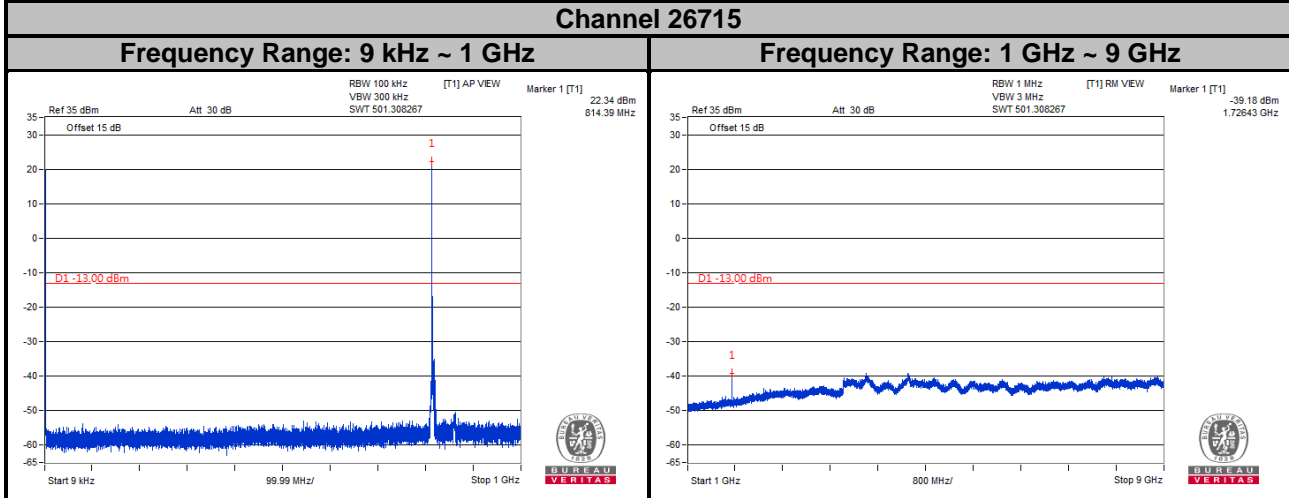

**Channel 26740**

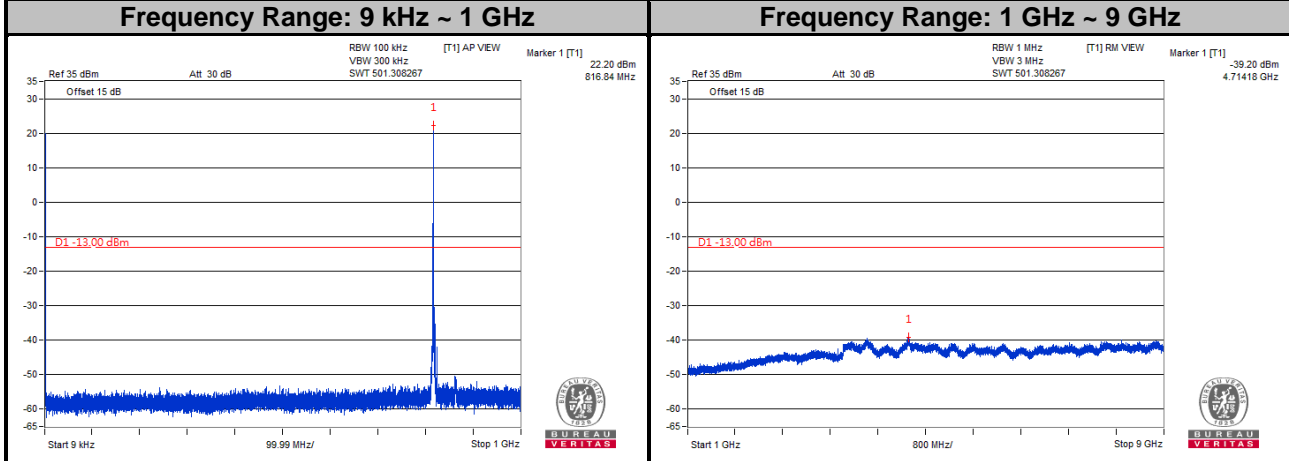

**Channel 26765**

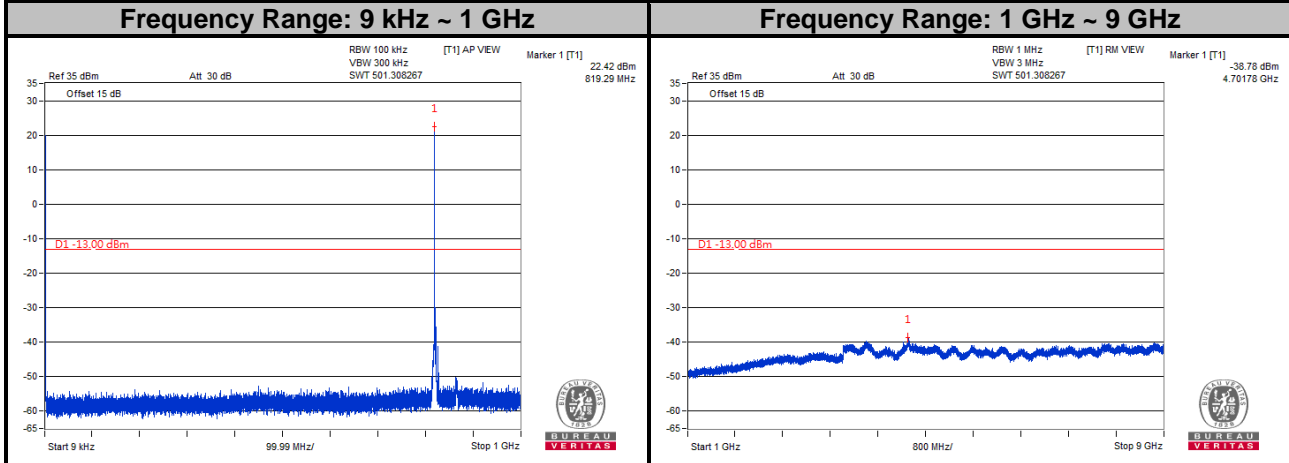

Note: The signal over the limit in 9 kHz is from spectrum analyzer.

LTE Band 26

Channel Bandwidth: 10 MHz

Channel 26740

Frequency Range: 9 kHz ~ 1 GHz

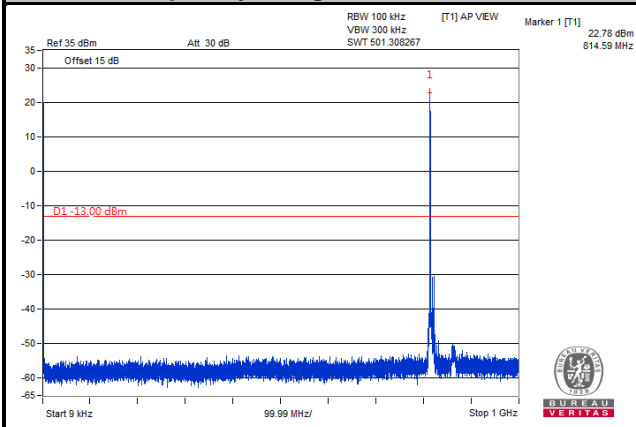

Frequency Range: 1 GHz ~ 9 GHz

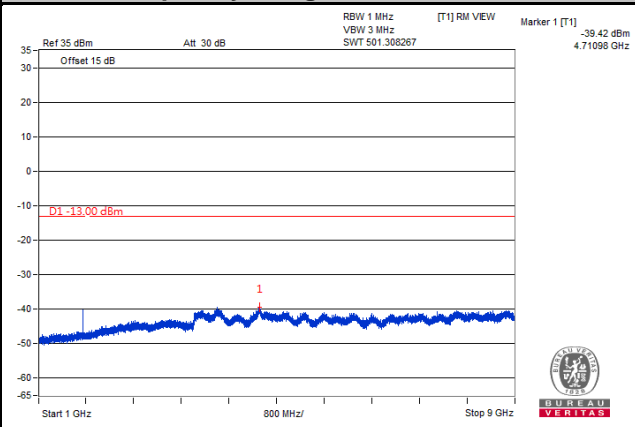

Note: The signal over the limit in 9 kHz is from spectrum analyzer.

## 4.7 Radiated Emission Measurement

### 4.7.1 Limits of Radiated Emission Measurement

The power of any emission outside a licensee's frequency block shall be attenuated below the transmitter power (P) by at least  $43 + 10 \log (P)$  dB. The limit of emission is equal to -13 dBm.

### 4.7.2 Test Procedure

- a. Substitution method is used for E.I.R.P measurement. In the semi-anechoic chamber, EUT placed on the 0.8 m (below or equal 1 GHz) and/or 1.5 m (above 1 GHz) height of Turn Table, rotated the table around 360 degrees to search the maximum radiation power and receiver antenna shall be rotated vertical and horizontal polarization and moved height from 1 m to 4 m to find the maximum polar radiated power. The "Read Value" is the spectrum reading the maximum power value.
- b. The substitution horn antenna is substituted for EUT at the same position and signals generator export the CW signal to the substitution antenna via a TX cable. Rotated the Turn Table and moved receiving antenna to find the maximum radiation power. Adjust output power level of S.G to get a Value of spectrum reading equal to "Read Value" of step a. Record the power level of S.G.
- c.  $EIRP = \text{Output power level of S.G} - \text{TX cable loss} + \text{Antenna gain of substitution horn}$ .
- d. E.R.P power can be calculated form E.I.R.P power by subtracting the gain of dipole,  $E.R.P \text{ power} = E.I.P.R \text{ power} - 2.15 \text{ dB}$ .

**Note:** The resolution bandwidth of spectrum analyzer is 1 MHz and the video bandwidth is 3 MHz.

### 4.7.3 Deviation from Test Standard

No deviation.



4.7.4 Test Setup

<Radiated Emission below or equal 1 GHz>

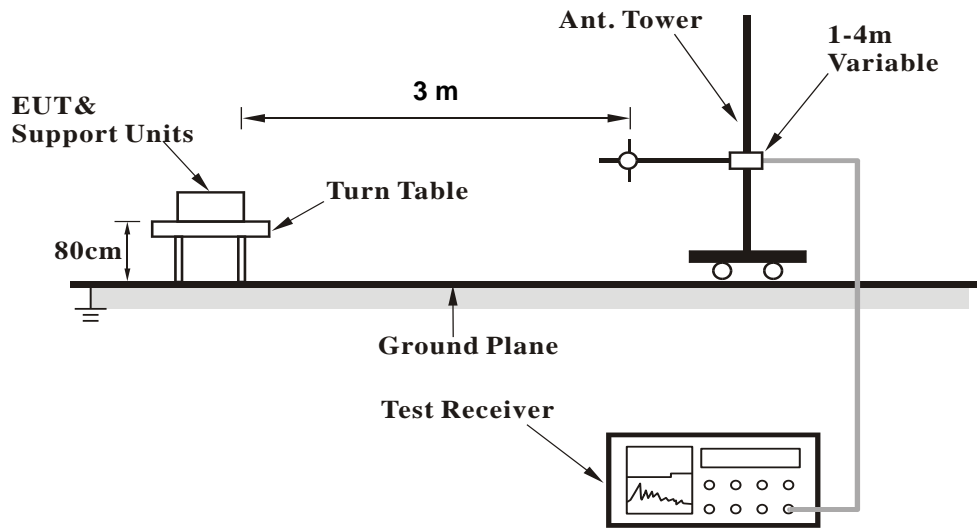

<Radiated Emission above 1 GHz>

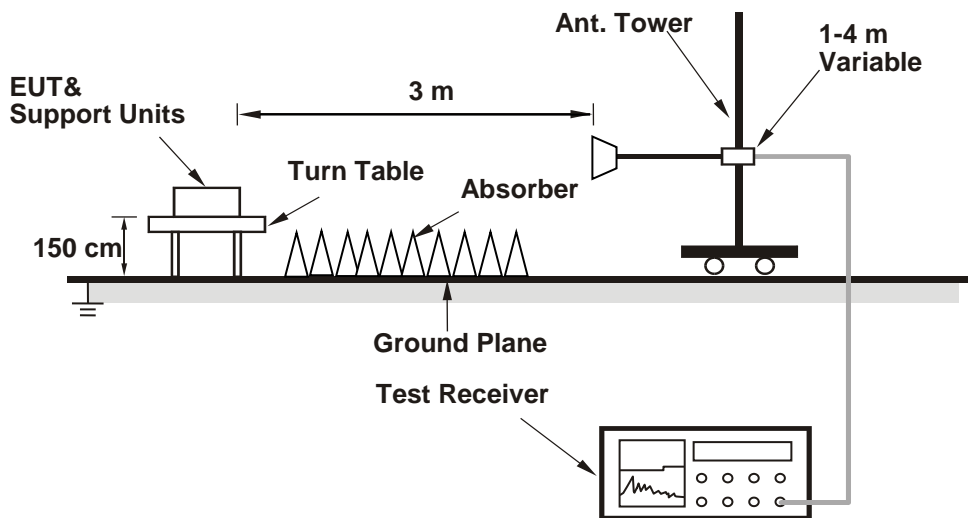

For the actual test configuration, please refer to the attached file (Test Setup Photo).

4.7.5 Test Results

LTE Band 26  
 Channel Bandwidth: 1.4 MHz / QPSK  
 Low Channel



Bureau Veritas Consumer Products Services Ltd., Taoyuan Branch

A D T

Data: 5

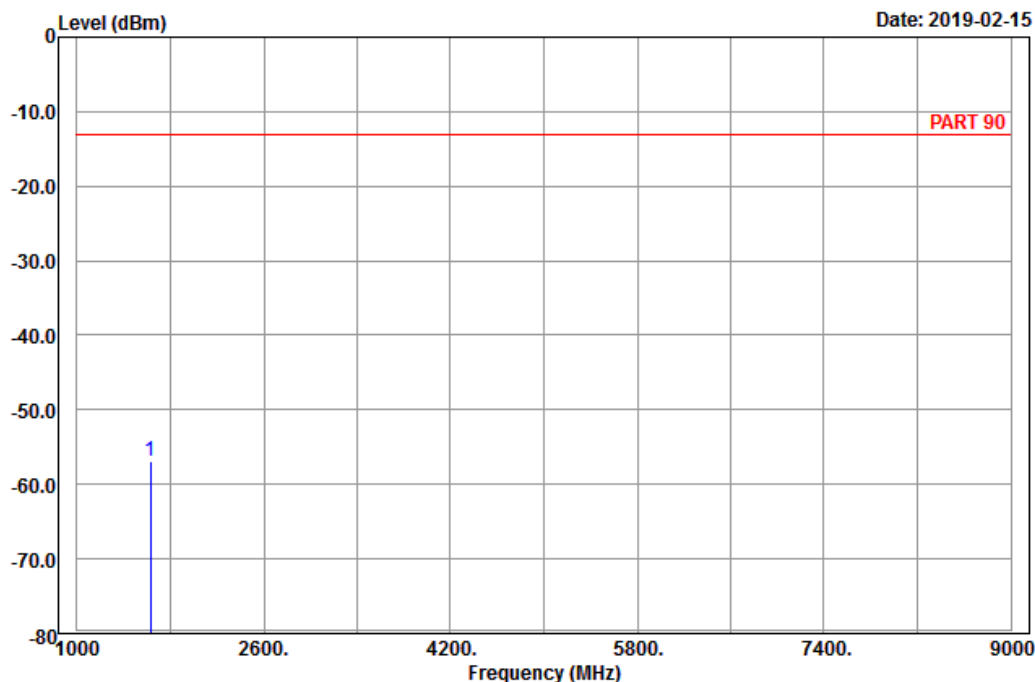

Site : 966 chamber 1  
 Condition: PART 90 Horizontal  
 Remark : LTE\_Band 26\_Link\_CH26697  
 Tested by: Charles Hsiao

Freq	Level	Read Level	Limit Line	Over Limit	Factor	Remark
MHz	dBm	dBm	dBm	dB	dB	
1 pp 1629.40	-56.92	-64.48	-13.00	-43.92	7.56	Peak



Bureau Veritas Consumer Products Services Ltd., Taoyuan Branch

A D T

Data: 6

Date: 2019-02-15

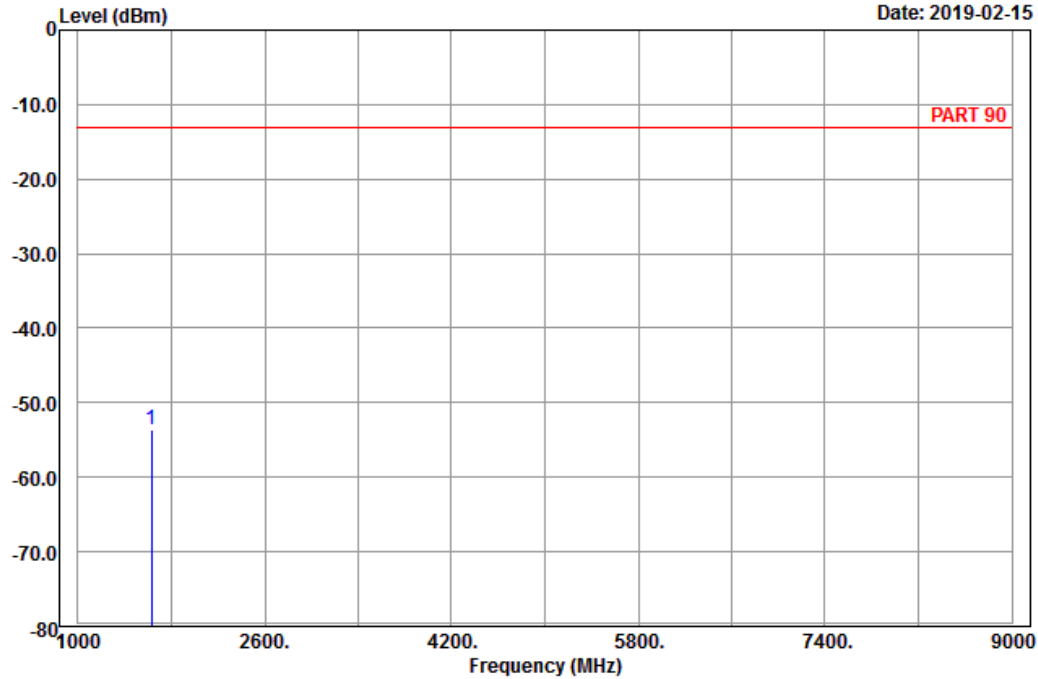

Site : 966 chamber 1  
 Condition: PART 90 Vertical  
 Remark : LTE\_Band 26\_Link\_CH26697  
 Tested by: Charles Hsiao

	Read	Limit	Over			
Freq	Level	Level	Line	Limit	Factor	Remark
MHz	dBm	dBm	dBm	dB	dB	
1 pp 1629.40	-53.70	-61.26	-13.00	-40.70	7.56	Peak

Middle Channel



Bureau Veritas Consumer Products Services Ltd., Taoyuan Branch

A D T

Data: 5

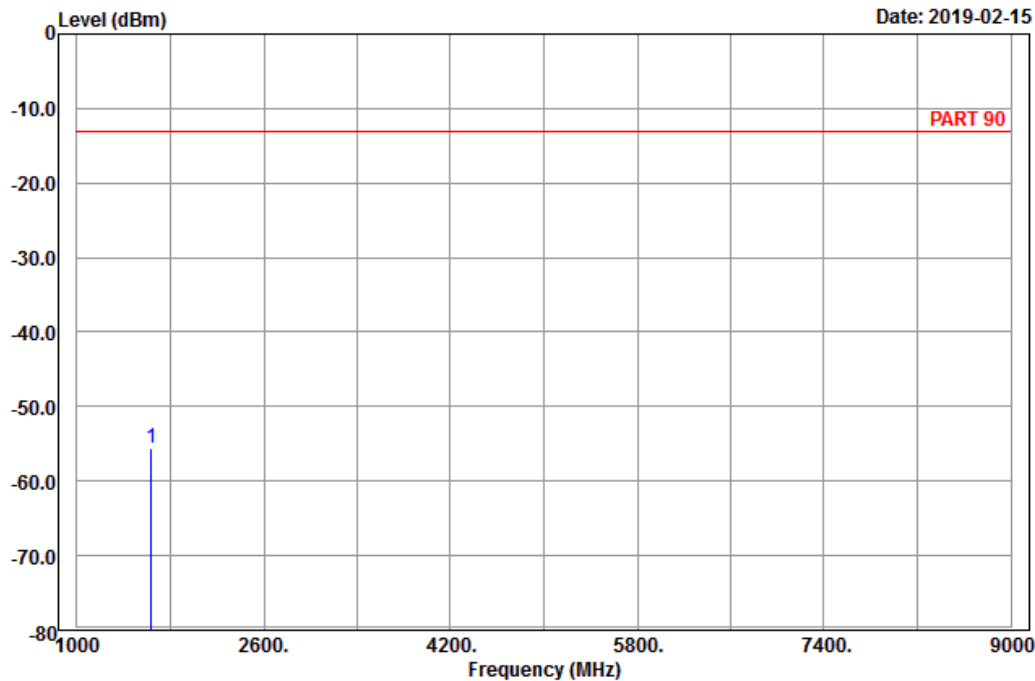

Site : 966 chamber 1  
 Condition: PART 90 Horizontal  
 Remark : LTE\_Band 26\_Link\_CH26740  
 Tested by: Charles Hsiao

	Read	Limit	Over			
Freq	Level	Level	Line	Limit	Factor	Remark
MHz	dBm	dBm	dBm	dB	dB	
1 pp 1638.00	-55.66	-63.22	-13.00	-42.66	7.56	Peak



Bureau Veritas Consumer Products Services Ltd., Taoyuan Branch

A D T

Data: 6

Date: 2019-02-15

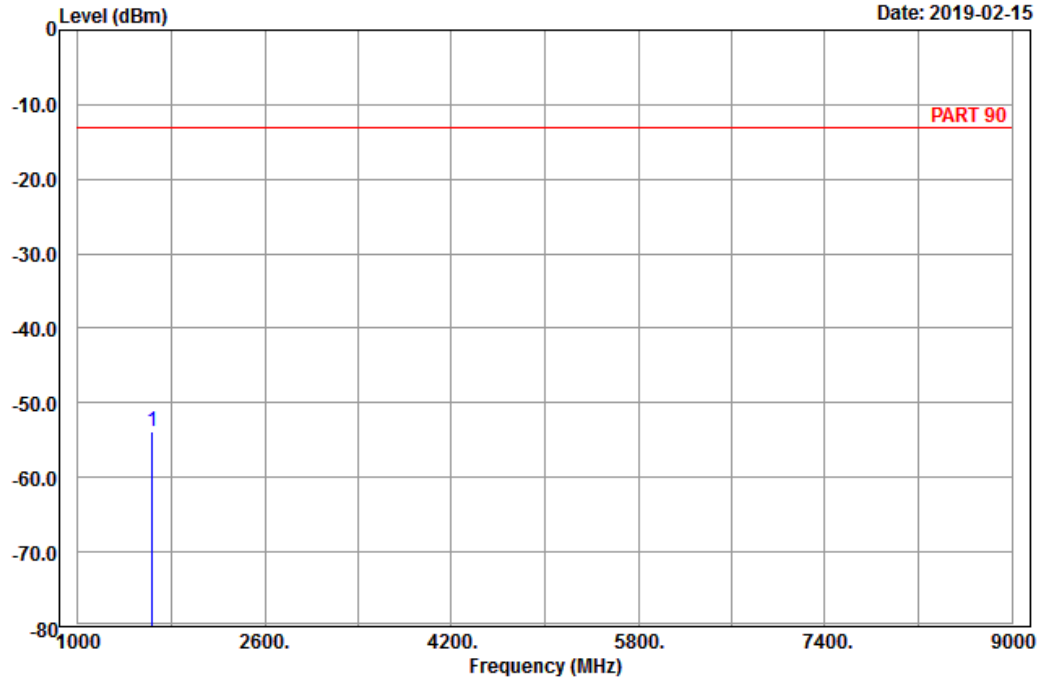

Site : 966 chamber 1  
 Condition: PART 90 Vertical  
 Remark : LTE\_Band 26\_Link\_CH26740  
 Tested by: Charles Hsiao

	Read	Limit	Over			
Freq	Level	Level	Line	Limit	Factor	Remark
MHz	dBm	dBm	dBm	dB	dB	
1 pp 1638.00	-53.78	-61.34	-13.00	-40.78	7.56	Peak

# High Channel



Bureau Veritas Consumer Products Services Ltd., Taoyuan Branch

A D T

Data: 5

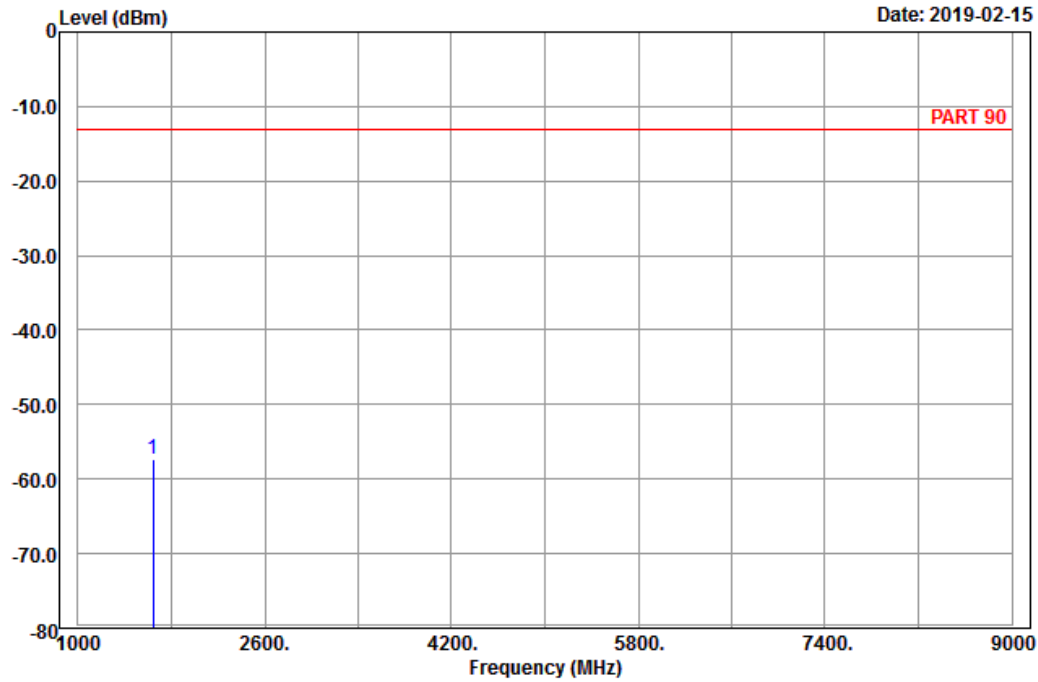

Site : 966 chamber 1  
 Condition: PART 90 Horizontal  
 Remark : LTE\_Band 26\_Link\_CH26783  
 Tested by: Charles Hsiao

	Read	Limit	Over		
Freq	Level	Level	Line	Limit	Factor Remark
MHz	dBm	dBm	dBm	dB	dB
1 pp 1646.60	-57.30	-65.03	-13.00	-44.30	7.73 Peak



Bureau Veritas Consumer Products Services Ltd., Taoyuan Branch

A D T

Data: 6

Date: 2019-02-15

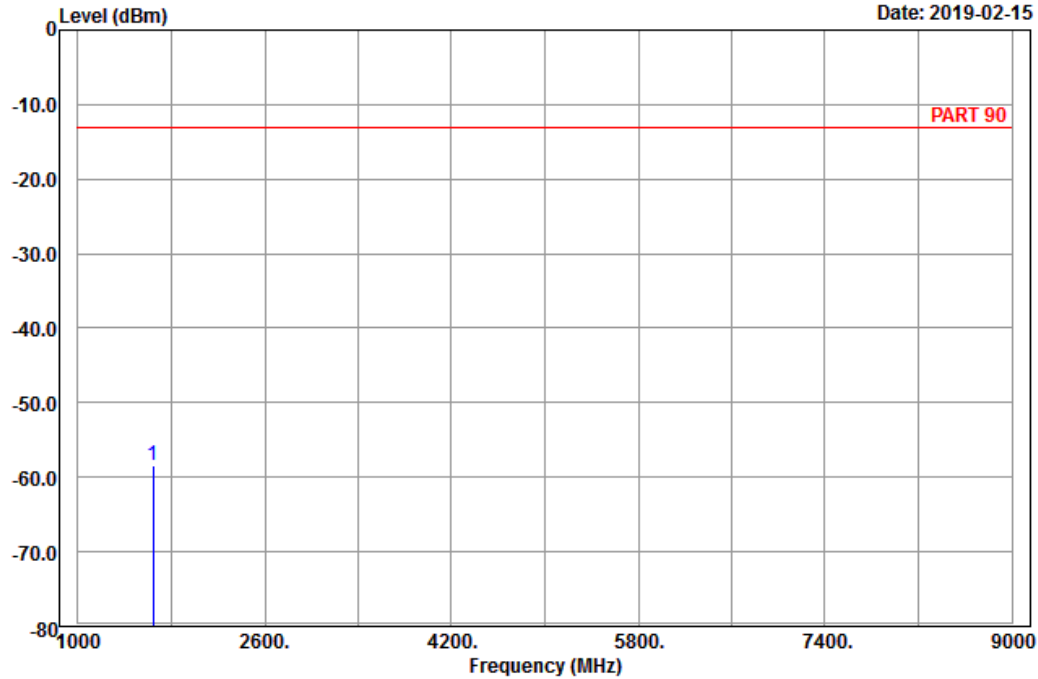

Site : 966 chamber 1  
 Condition: PART 90 Vertical  
 Remark : LTE\_Band 26\_Link\_CH26783  
 Tested by: Charles Hsiao

	Read	Limit	Over			
Freq	Level	Level	Line	Limit	Factor	Remark
MHz	dBm	dBm	dBm	dB	dB	
1 pp 1646.60	-58.33	-66.06	-13.00	-45.33	7.73	Peak

Channel Bandwidth: 5 MHz / QPSK  
Low Channel



Bureau Veritas Consumer Products Services Ltd., Taoyuan Branch

A D T

Data: 5

Date: 2019-02-15

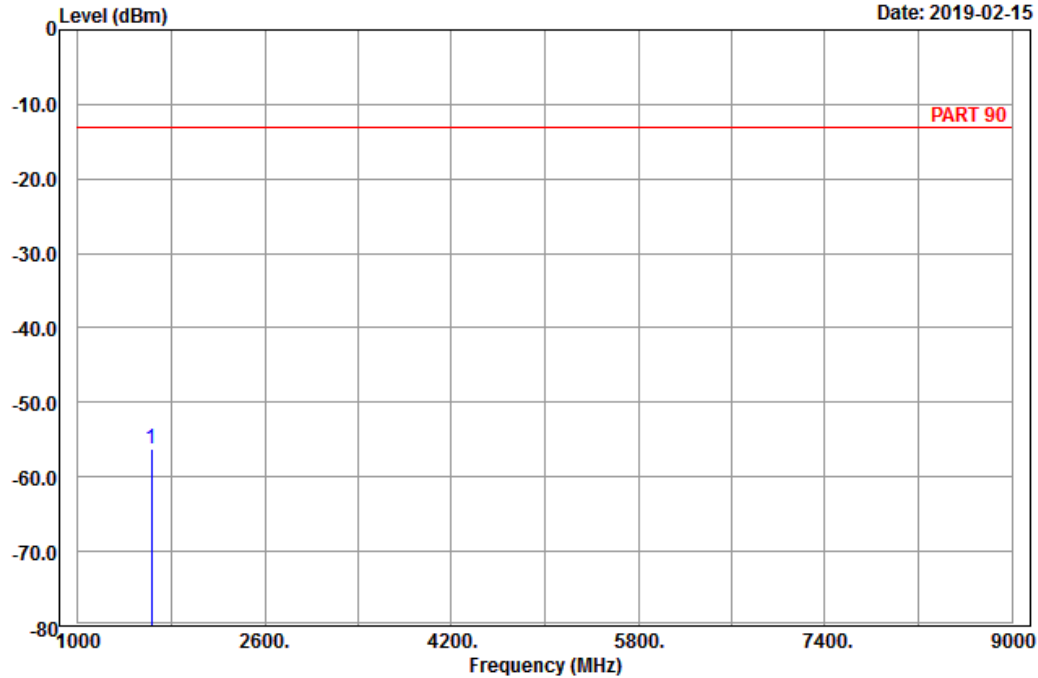

Site : 966 chamber 1  
Condition: PART 90 Horizontal  
Remark : LTE\_Band 26\_Link\_CH26715  
Tested by: Karl Lee

	Freq	Level	Read Level	Limit Line	Over Limit	Factor	Remark
	MHz	dBm	dBm	dBm	dB	dB	
1	pp 1633.00	-56.20	-63.76	-13.00	-43.20	7.56	Peak





Bureau Veritas Consumer Products Services Ltd., Taoyuan Branch

A D T

Data: 6

Date: 2019-02-15

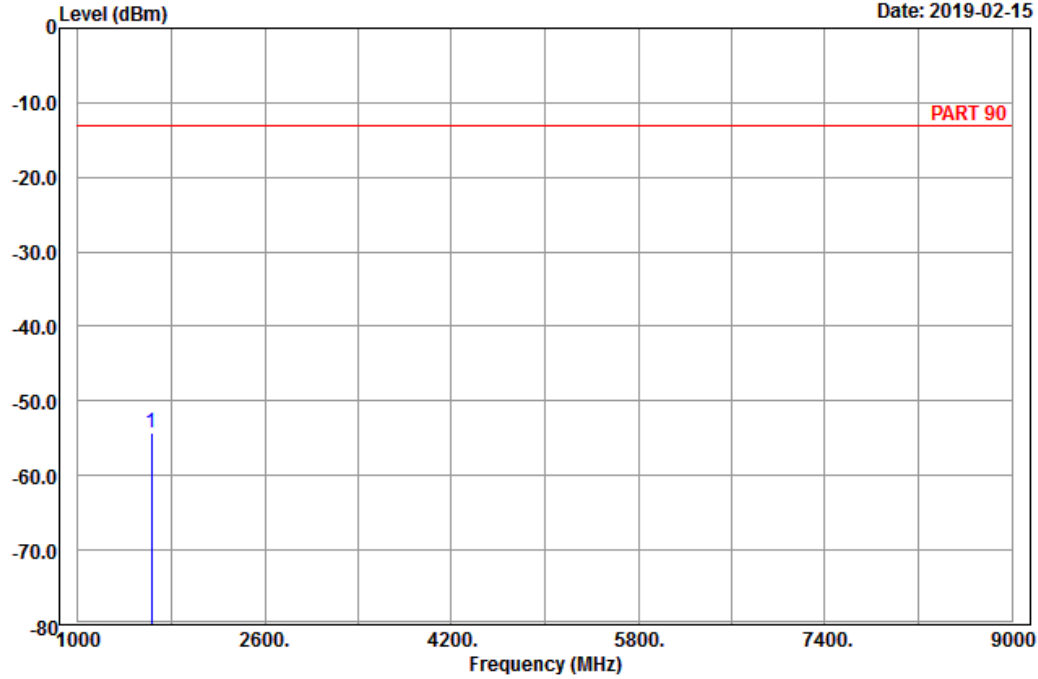

Site : 966 chamber 1  
 Condition: PART 90 Vertical  
 Remark : LTE\_Band 26\_Link\_CH26715  
 Tested by: Karl Lee

	Read	Limit	Over			
Freq	Level	Level	Line	Limit	Factor	Remark
MHz	dBm	dBm	dBm	dB	dB	
1 pp 1633.00	-54.24	-61.80	-13.00	-41.24	7.56	Peak

Middle Channel



Bureau Veritas Consumer Products Services Ltd., Taoyuan Branch

A D T

Data: 5

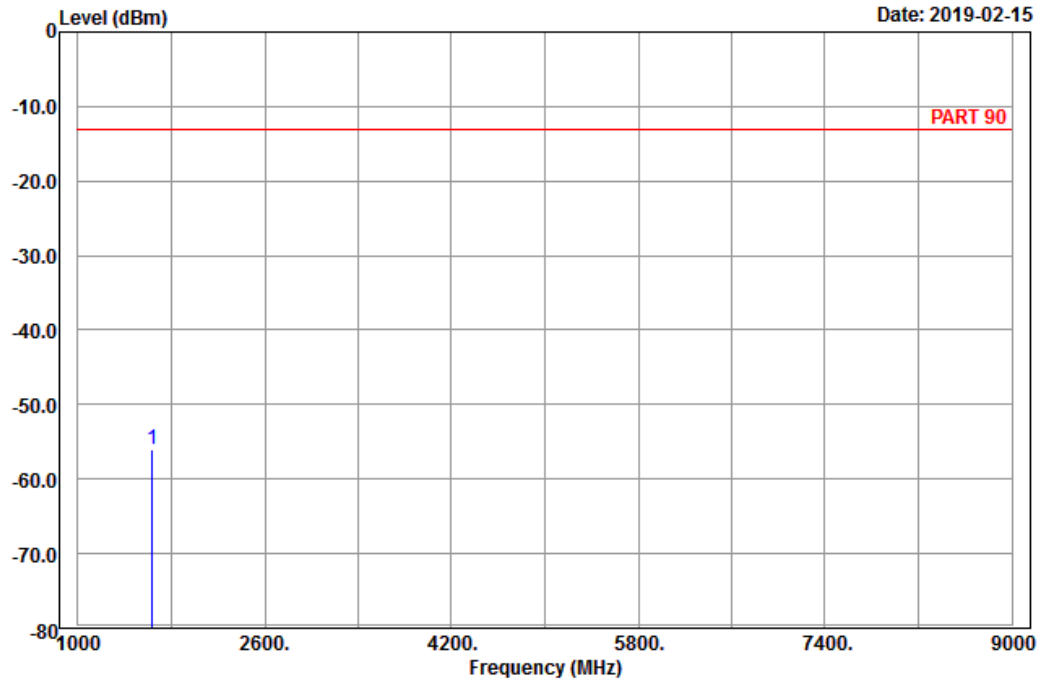

Site : 966 chamber 1  
 Condition: PART 90 Horizontal  
 Remark : LTE\_Band 26\_Link\_CH26740  
 Tested by: Karl Lee

	Freq	Level	Read Level	Limit Line	Over Limit	Factor	Remark
	MHz	dBm	dBm	dBm	dB	dB	
1	pp 1638.00	-56.01	-63.57	-13.00	-43.01	7.56	Peak



Bureau Veritas Consumer Products Services Ltd., Taoyuan Branch

A D T

Data: 6

Date: 2019-02-15

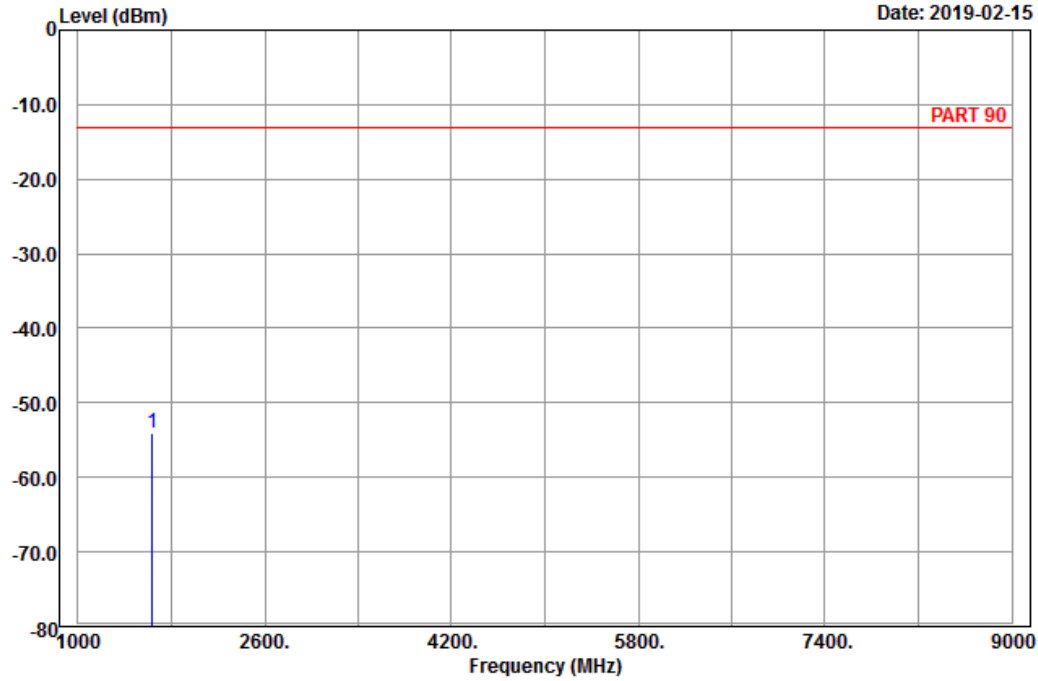

Site : 966 chamber 1  
 Condition: PART 90 Vertical  
 Remark : LTE\_Band 26\_Link\_CH26740  
 Tested by: Karl Lee

	Read	Limit	Over			
Freq	Level	Level	Line	Limit	Factor	Remark
MHz	dBm	dBm	dBm	dB	dB	
1 pp 1638.00	-54.02	-61.58	-13.00	-41.02	7.56	Peak

High Channel



Bureau Veritas Consumer Products Services Ltd., Taoyuan Branch

A D T

Data: 5

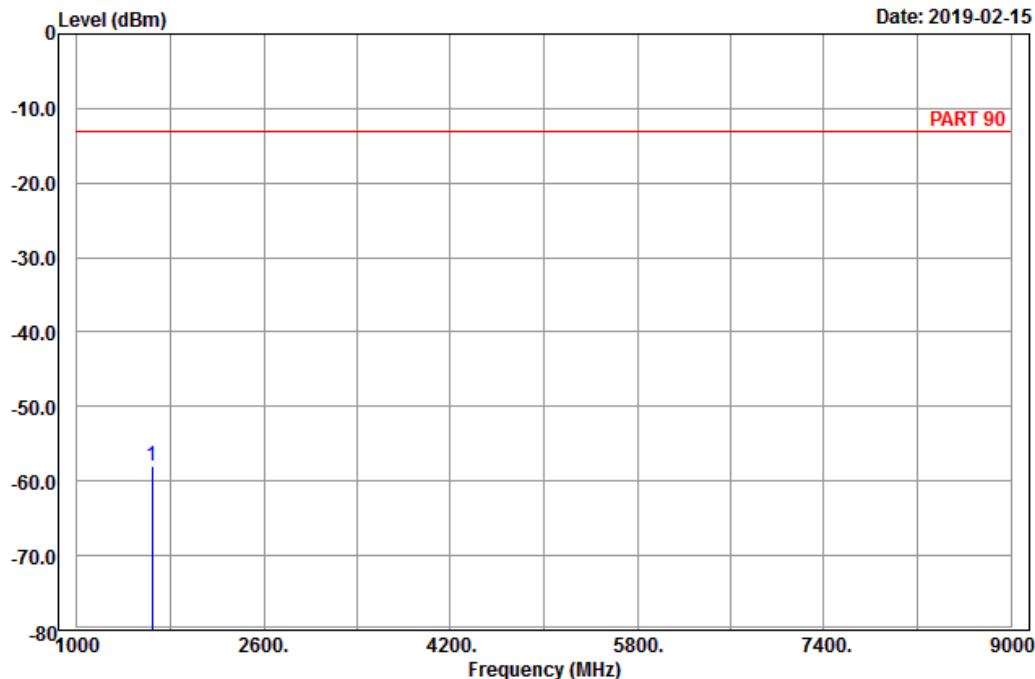

Site : 966 chamber 1  
 Condition: PART 90 Horizontal  
 Remark : LTE\_Band 26\_Link\_CH26765  
 Tested by: Karl Lee

	Freq	Level	Read Level	Limit Line	Over Limit	Factor	Remark
	MHz	dBm	dBm	dBm	dB	dB	
1	pp 1643.00	-58.02	-65.75	-13.00	-45.02	7.73	Peak



Bureau Veritas Consumer Products Services Ltd., Taoyuan Branch

A D T

Data: 6

Date: 2019-02-15

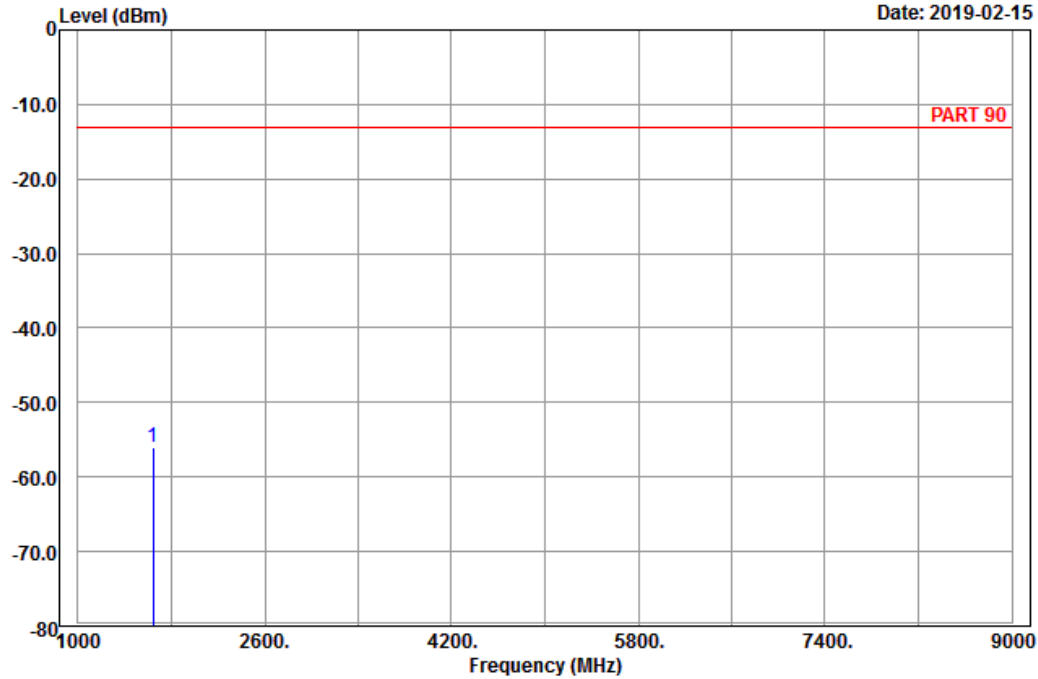

Site : 966 chamber 1  
 Condition: PART 90 Vertical  
 Remark : LTE\_Band 26\_Link\_CH26765  
 Tested by: Karl Lee

	Read	Limit	Over			
Freq	Level	Level	Line	Limit	Factor	Remark
MHz	dBm	dBm	dBm	dB	dB	
1 pp 1643.00	-55.92	-63.65	-13.00	-42.92	7.73	Peak

Channel Bandwidth: 10 MHz / QPSK



Bureau Veritas Consumer Products Services Ltd., Taoyuan Branch

A D T

Data: 9

Date: 2019-02-15

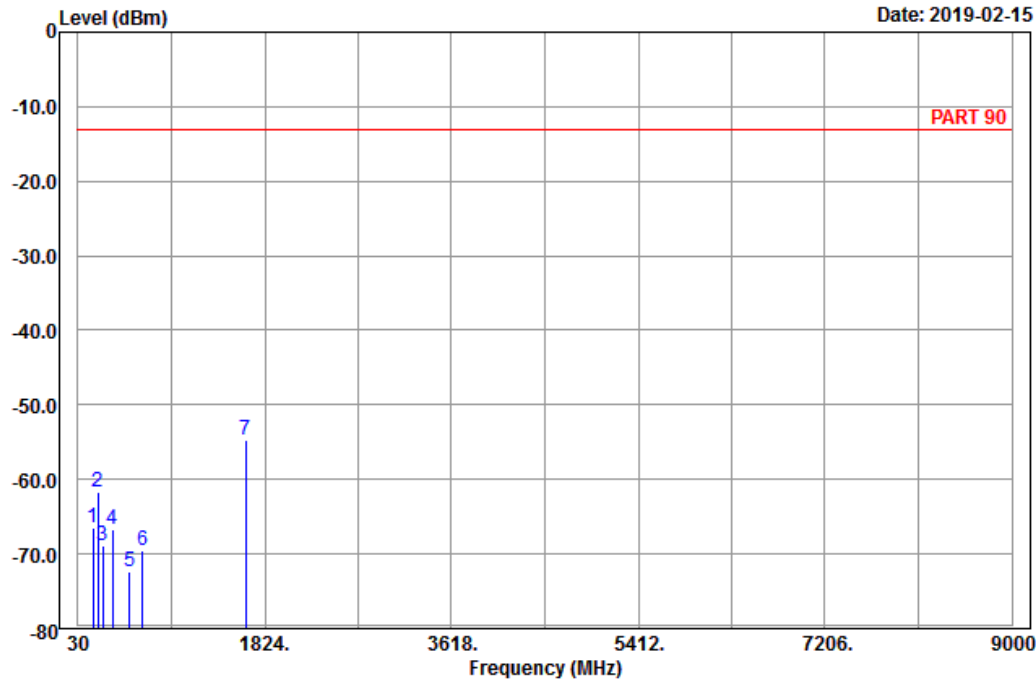

Site : 966 chamber 1  
 Condition: PART 90 Horizontal  
 Remark : LTE\_Band 26\_Link\_CH26740  
 Tested by: Karl Lee

	Read	Limit	Over				
Freq	Level	Level	Line	Limit	Factor	Remark	
MHz	dBm	dBm	dBm	dB	dB		
1	172.56	-66.48	-60.08	-13.00	-53.48	-6.40	Peak
2	219.81	-61.71	-55.80	-13.00	-48.71	-5.91	Peak
3	264.90	-68.79	-63.15	-13.00	-55.79	-5.64	Peak
4	361.60	-66.66	-61.90	-13.00	-53.66	-4.76	Peak
5	524.70	-72.32	-68.81	-13.00	-59.32	-3.51	Peak
6	650.00	-69.50	-69.37	-13.00	-56.50	-0.13	Peak
7 pp	1638.00	-54.66	-62.22	-13.00	-41.66	7.56	Peak



Bureau Veritas Consumer Products Services Ltd., Taoyuan Branch

A D T

Data: 10

Date: 2019-02-15

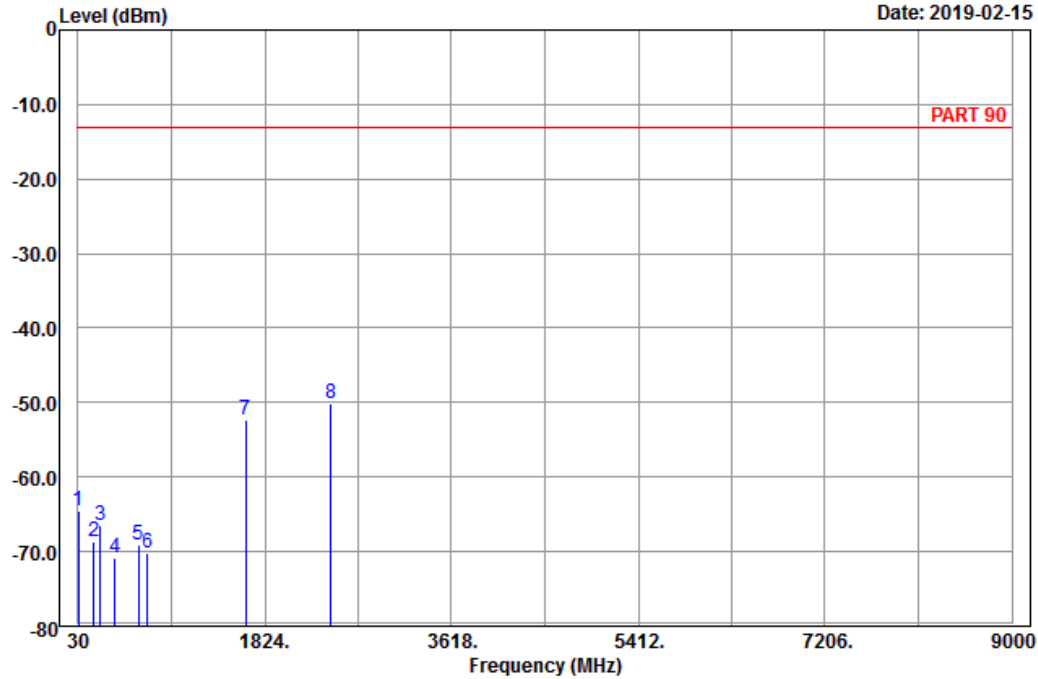

Site : 966 chamber 1  
 Condition: PART 90 Vertical  
 Remark : LTE\_Band 26\_Link\_CH26740  
 Tested by: Karl Lee

	Freq	Level	Read Level	Limit Line	Over Limit	Factor	Remark
	MHz	dBm	dBm	dBm	dB	dB	
1	33.24	-64.62	-53.75	-13.00	-51.62	-10.87	Peak
2	183.63	-68.72	-63.10	-13.00	-55.72	-5.62	Peak
3	246.81	-66.41	-60.86	-13.00	-53.41	-5.55	Peak
4	381.20	-70.93	-67.21	-13.00	-57.93	-3.72	Peak
5	607.30	-69.05	-69.40	-13.00	-56.05	0.35	Peak
6	698.30	-70.12	-69.75	-13.00	-57.12	-0.37	Peak
7	1638.00	-52.27	-59.83	-13.00	-39.27	7.56	Peak
8 pp	2457.00	-50.13	-61.15	-13.00	-37.13	11.02	Peak

## 5 Pictures of Test Arrangements

Please refer to the attached file (Test Setup Photo).



## Appendix – Information of the Testing Laboratories

We, Bureau Veritas Consumer Products Services (H.K.) Ltd., Taoyuan Branch, were founded in 1988 to provide our best service in EMC, Radio, Telecom and Safety consultation. Our laboratories are FCC recognized accredited test firms and accredited according to ISO/IEC 17025.

If you have any comments, please feel free to contact us at the following:

**Lin Kou EMC/RF Lab**

Tel: 886-2-26052180

Fax: 886-2-26051924

**Hsin Chu EMC/RF/Telecom Lab**

Tel: 886-3-6668565

Fax: 886-3-6668323

**Hwa Ya EMC/RF/Safety**

Tel: 886-3-3183232

Fax: 886-3-3270892

**Email:** [service.adt@tw.bureauveritas.com](mailto:service.adt@tw.bureauveritas.com)

**Web Site:** [www.bureauveritas-adt.com](http://www.bureauveritas-adt.com)

The address and road map of all our labs can be found in our web site also.

--- END ---