

FCC Test Report

Report No.: RF170517C30-4

FCC ID: B32CARBON8

Test Model: Carbon 8

Received Date: May 17, 2017

Test Date: May 26, 2017 ~ Jul. 28, 2017

Issued Date: Aug. 14, 2017

Applicant: Verifone, Inc.

Address: 1400 West Stanford Ranch Road Suite 200 Rocklin CA 95765 USA

Issued By: Bureau Veritas Consumer Products Services (H.K.) Ltd., Taoyuan Branch

Lab Address: No. 47-2, 14th Ling, Chia Pau Vil., Lin Kou Dist., New Taipei City, Taiwan (R.O.C)

Test Location (1): No. 19, Hwa Ya 2nd Rd, Wen Hwa Tsuen, Kwei Shan Hsiang, Taoyuan Hsien 333, Taiwan, R.O.C.

Test Location (2): No.215, Sec. 3, Beixin Rd., Xindian Dist., New Taipei City 231, Taiwan, R.O.C



This report is for your exclusive use. Any copying or replication of this report to or for any other person or entity, or use of our name or trademark, is permitted only with our prior written permission. This report sets forth our findings solely with respect to the test samples identified herein. The results set forth in this report are not indicative or representative of the quality or characteristics of the lot from which a test sample was taken or any similar or identical product unless specifically and expressly noted. Our report includes all of the tests requested by you and the results thereof based upon the information that you provided to us. You have 60 days from date of issuance of this report to notify us of any material error or omission caused by our negligence, provided, however, that such notice shall be in writing and shall specifically address the issue you wish to raise. A failure to raise such issue within the prescribed time shall constitute your unqualified acceptance of the completeness of this report, the tests conducted and the correctness of the report contents. Unless specific mention, the uncertainty of measurement has been explicitly taken into account to declare the compliance or non-compliance to the specification. The report must not be used by the client to claim product certification, approval, or endorsement by TAF or any government agencies.

Table of Contents

Release Control Record	4
1 Certificate of Conformity	5
2 Summary of Test Results	6
2.1 Measurement Uncertainty.....	6
2.2 Modification Record	6
3 General Information	7
3.1 General Description of EUT	7
3.2 Description of Test Modes.....	9
3.2.1 Test Mode Applicability and Tested Channel Detail.....	11
3.3 Duty Cycle of Test Signal	13
3.4 Description of Support Units	14
3.4.1 Configuration of System under Test	14
3.5 General Description of Applied Standards.....	14
4 Test Types and Results	15
4.1 Radiated Emission and Bandedge Measurement	15
4.1.1 Limits of Radiated Emission and Bandedge Measurement	15
4.1.2 Limits of Unwanted Emission Out of the Restricted Bands	16
4.1.3 Test Instruments	17
4.1.4 Test Procedures.....	18
4.1.5 Deviation from Test Standard	18
4.1.6 Test Set Up	19
4.1.7 EUT Operating Conditions.....	20
4.1.8 Test Results	21
4.2 Conducted Emission Measurement.....	63
4.2.1 Limits of Conducted Emission Measurement	63
4.2.2 Test Instruments	63
4.2.3 Test Procedures.....	64
4.2.4 Deviation from Test Standard	64
4.2.5 Test Setup.....	64
4.2.6 EUT Operating Conditions.....	64
4.2.7 Test Results	65
4.3 Transmit Power Measurement.....	67
4.3.1 Limits of Transmit Power Measurement	67
4.3.2 Test Setup.....	67
4.3.3 Test Instruments	68
4.3.4 Test Procedure	68
4.3.5 Deviation from Test Standard	68
4.3.6 EUT Operating Conditions.....	68
4.3.7 Test Result	69
4.4 Peak Power Spectral Density Measurement	74
4.4.1 Limits of Peak Power Spectral Density Measurement	74
4.4.2 Test Setup.....	74
4.4.3 Test Instruments	74
4.4.4 Test Procedures.....	74
4.4.5 Deviation from Test Standard	75
4.4.6 EUT Operating Conditions.....	75
4.4.7 Test Results	76
4.5 Frequency Stability	81
4.5.1 Limit of Frequency Stability Measurement	81
4.5.2 Test Setup.....	81
4.5.3 Test Instruments	81
4.5.4 Test Procedure	81
4.5.5 Deviation from Test Standard	81

4.5.6 EUT Operating Condition	81
4.5.7 Test Results	82
4.6 6 dB Bandwidth Measurement.....	83
4.6.1 Limits of 6 dB Bandwidth Measurement.....	83
4.6.2 Test Setup.....	83
4.6.3 Test Instruments	83
4.6.4 Test Procedure	83
4.6.5 Deviation from Test Standard	83
4.6.6 EUT Operating Condition	83
4.6.7 Test Results	84
5 Pictures of Test Arrangements.....	86
Annex A- Radiated Out of Band Emisison (OOBE) Measurement (For U-NII-3 band)	87
Appendix – Information on the Testing Laboratories	88

Release Control Record

Issue No.	Description	Date Issued
RF170517C30-4	Original Release	Aug. 14, 2017

1 Certificate of Conformity

Product: Carbon 8

Brand: Verifone

Test Model: Carbon 8

Sample Status: Identical Prototype

Applicant: Verifone, Inc.

Test Date: May 26, 2017 ~ Jul. 28, 2017

Standards: 47 CFR FCC Part 15, Subpart E (Section 15.407)
ANSI C63.10:2013

The above equipment has been tested by **Bureau Veritas Consumer Products Services (H.K.) Ltd., Taoyuan Branch**, and found compliance with the requirement of the above standards. The test record, data evaluation & Equipment Under Test (EUT) configurations represented herein are true and accurate accounts of the measurements of the sample's EMC characteristics under the conditions specified in this report.

Prepared by : Gina Liu , **Date:** Aug. 14, 2017
Gina Liu / Specialist

Approved by : David Huang , **Date:** Aug. 14, 2017
David Huang / Project Engineer

2 Summary of Test Results

47 CFR FCC Part 15, Subpart E (Section 15.407)			
FCC Clause	Test Item	Result	Remarks
15.407(b)(6)	AC Power Conducted Emissions	Pass	Meet the requirement of limit. Minimum passing margin is -14.32 dB at 18.78115 MHz.
15.407(b) (1/2/3/4(i/ii)/6)	Radiated Emissions & Band Edge Measurement	Pass	Meet the requirement of limit. Minimum passing margin is -3.9 dB at 11650 MHz.
15.407(a)(1/2/3)	Max Average Transmit Power	Pass	Meet the requirement of limit.
15.407(a)(1/2/3)	Peak Power Spectral Density	Pass	Meet the requirement of limit.
15.407(e)	6 dB Bandwidth	Pass	Meet the requirement of limit. (U-NII-3 Band only)
15.407(g)	Frequency Stability	Pass	Meet the requirement of limit.
15.203	Antenna Requirement	Pass	No antenna connector is used.

*For U-NII-3 band compliance with rule part 15.407(b)(4)(i), the OOB test plots were recorded in Annex A.

2.1 Measurement Uncertainty

Where relevant, the following measurement uncertainty levels have been estimated for tests performed on the EUT as specified in CISPR 16-4-2:

Measurement	Frequency	Expanded Uncertainty (k=2) (±)
Conducted Emissions at mains ports	150 kHz ~ 30 MHz	2.44 dB
Radiated Emissions up to 1 GHz	30 MHz ~ 200 MHz	2.0153 dB
	200 MHz ~ 1000 MHz	2.0224 dB
Radiated Emissions above 1 GHz	1 GHz ~ 18 GHz	1.0121 dB
	18 GHz ~ 40 GHz	1.1508 dB

2.2 Modification Record

There were no modifications required for compliance.

3 General Information

3.1 General Description of EUT

Product	Carbon 8
Brand	Verifone
Test Model	Carbon 8
Status of EUT	Identical Prototype
Power Supply Rating	5.0 Vdc (adapter) 3.85Vdc (Li-ion battery)
Modulation Type	256QAM, 64QAM, 16QAM, QPSK, BPSK
Modulation Technology	OFDM
Transfer Rate	802.11a: 54.0/ 48.0/ 36.0/ 24.0/ 18.0/ 12.0/ 9.0/ 6.0 Mbps 802.11n: up to MCS7 802.11ac: up to V9
Operating Frequency	5180 ~ 5240 MHz, 5260 ~ 5320 MHz, 5500 ~ 5700 MHz, 5745 ~ 5825 MHz
Number of Channel	5180 ~ 5240 MHz: 4 for 802.11a, 802.11n (HT20) 2 for 802.11n (HT40) 1 for 802.11ac (VHT80) 5260 ~ 5320 MHz: 4 for 802.11a, 802.11n (HT20) 2 for 802.11n (HT40) 1 for 802.11ac (VHT80) 5500 ~ 5700 MHz: 11 for 802.11a, 802.11n (HT20) 5 for 802.11n (HT40) 2 for 802.11ac (VHT80) 5745 ~ 5825 MHz: 5 for 802.11a, 802.11n (HT20) 2 for 802.11n (HT40) 1 for 802.11ac (VHT80)
Output Power	31.333 mW for 5180 ~ 5240 MHz 31.117 mW for 5260 ~ 5320 MHz 37.844 mW for 5500 ~ 5700 MHz 31.55 mW for 5745 ~ 5825 MHz
Antenna Type	PCB antenna with 1.9 dBi gain (5180 ~ 5240 MHz) PCB antenna with 1.9 dBi gain (5260 ~ 5320 MHz) PCB antenna with 1.8 dBi gain (5500 ~ 5700 MHz) PCB antenna with 1.7 dBi gain (5745 ~ 5825 MHz)
Antenna Connector	N/A
Accessory Device	Refer to Note as below
Data Cable Supplied	Refer to Note as below

Note:

1. The EUT provides one completed transmitter and one receiver.

Modulation Mode	Tx Function
802.11a	1TX
802.11n (HT20)	1TX
802.11n (HT40)	1TX
802.11ac (VHT80)	1TX

* The modulation and bandwidth are similar for 802.11n mode for HT20 / HT40 and 802.11ac mode for HT20 / HT40, therefore investigated worst case to representative mode in test report. (Final test mode refer section 3.2.1)

2. The EUT contains following accessory devices.

Product	Brand	Model	Description
Battery	Verifone	Carbon8	3.85 Vdc, 5190 mAh
BT/WLAN Module	USI	WM-BAC-BM-25	--

3. The above EUT information is declared by manufacturer and for more detailed features description, please refer to the manufacturer's specifications or user's manual.

3.2 Description of Test Modes

For 5180 ~ 5240 MHz

4 channels are provided for 802.11a, 802.11n (HT20):

Channel	Frequency (MHz)	Channel	Frequency (MHz)
36	5180	44	5220
40	5200	48	5240

2 channels are provided for 802.11n (HT40):

Channel	Frequency (MHz)	Channel	Frequency (MHz)
38	5190	46	5230

1 channel is provided for 802.11ac (VHT80):

Channel	Frequency (MHz)
42	5210

For 5260 ~ 5320 MHz

4 channels are provided for 802.11a, 802.11n (HT20):

Channel	Frequency (MHz)	Channel	Frequency (MHz)
52	5260	60	5300
56	5280	64	5320

2 channels are provided for 802.11n (HT40):

Channel	Frequency (MHz)	Channel	Frequency (MHz)
54	5270	62	5310

1 channel is provided for 802.11ac (VHT80):

Channel	Frequency (MHz)
58	5290

For 5500 ~ 5700 MHz

11 channels are provided for 802.11a, 802.11n (HT20):

Channel	Frequency (MHz)	Channel	Frequency (MHz)
100	5500	124	5620
104	5520	128	5640
108	5540	132	5660
112	5560	136	5680
116	5580	140	5700
120	5600		

5 channels are provided for 802.11n (HT40):

Channel	Frequency (MHz)	Channel	Frequency (MHz)
102	5510	126	5630
110	5550	134	5670
118	5590		

2 channels are provided for 802.11ac (VHT80):

Channel	Frequency (MHz)	Channel	Frequency (MHz)
106	5530	122	5610

For 5745 ~ 5825 MHz:

5 channels are provided for 802.11a, 802.11n (HT20):

Channel	Frequency (MHz)	Channel	Frequency (MHz)
149	5745	161	5805
153	5765	165	5825
157	5785		

2 channels are provided for 802.11n (HT40):

Channel	Frequency (MHz)	Channel	Frequency (MHz)
151	5755	159	5795

1 channel is provided for 802.11ac (VHT80):

Channel	Frequency (MHz)
155	5775

3.2.1 Test Mode Applicability and Tested Channel Detail

EUT Configure Mode	Applicable To				Description
	RE \geq 1G	RE $<$ 1G	PLC	APCM	
-	√	√	√	√	-

Where **RE \geq 1G**: Radiated Emission above 1 GHz **RE $<$ 1G**: Radiated Emission below 1 GHz
PLC: Power Line Conducted Emission **APCM**: Antenna Port Conducted Measurement

Note:

1. The EUT had been pre-tested on the positioned of each 3 axis. The worst case was found when positioned on **X-plane**.
2. "-" means no effect.

Radiated Emission Test (Above 1 GHz):

- Pre-Scan has been conducted to determine the worst-case mode from all possible combinations between available modulations, data rates and antenna ports (if EUT with antenna diversity architecture).
- Following channel(s) was (were) selected for the final test as listed below.

EUT Configure Mode	Frequency Band (MHz)	Mode	Available Channel	Tested Channel	Modulation Technology	Modulation Type	Data Rate (Mbps)
-	5180-5240	802.11a	36 to 48	36, 44, 48	OFDM	BPSK	6.0
-		802.11n (HT20)	36 to 48	36, 44, 48	OFDM	BPSK	MCS0
-		802.11n (HT40)	38 to 46	38, 46	OFDM	BPSK	MCS0
-		802.11ac (VHT80)	42	42	OFDM	BPSK	MCS0
-	5260-5320	802.11a	52 to 64	52, 60, 64	OFDM	BPSK	6.0
-		802.11n (HT20)	52 to 64	52, 60, 64	OFDM	BPSK	MCS0
-		802.11n (HT40)	54 to 62	54, 62	OFDM	BPSK	MCS0
-		802.11ac (VHT80)	58	58	OFDM	BPSK	MCS0
-	5500-5700	802.11a	100 to 140	100, 116, 140	OFDM	BPSK	6.0
-		802.11n (HT20)	100 to 140	100, 116, 140	OFDM	BPSK	MCS0
-		802.11n (HT40)	102 to 134	102, 110, 134	OFDM	BPSK	MCS0
-		802.11ac (VHT80)	106 to 122	106, 122	OFDM	BPSK	MCS0
-	5745-5825	802.11a	149 to 165	149, 157, 165	OFDM	BPSK	6.0
-		802.11n (HT20)	149 to 165	149, 157, 165	OFDM	BPSK	MCS0
-		802.11n (HT40)	151 to 159	151, 159	OFDM	BPSK	MCS0
-		802.11ac (VHT80)	155	155	OFDM	BPSK	MCS0

Radiated Emission Test (Below 1 GHz):

- Pre-Scan has been conducted to determine the worst-case mode from all possible combinations between available modulations, data rates and antenna ports (if EUT with antenna diversity architecture).
- Following channel(s) was (were) selected for the final test as listed below.

EUT Configure Mode	Frequency Band (MHz)	Mode	Available Channel	Tested Channel	Modulation Technology	Modulation Type	Data Rate (Mbps)
-	5180-5240	802.11n (HT40)	38 to 46	38	OFDM	BPSK	MCS0
-	5260-5320	802.11n (HT40)	54 to 62	62	OFDM	BPSK	MCS0
-	5500-5700	802.11a	100 to 140	100	OFDM	BPSK	6.0
-	5745-5825	802.11n (HT40)	151 to 159	159	OFDM	BPSK	MCS0

Power Line Conducted Emission Test:

- Pre-Scan has been conducted to determine the worst-case mode from all possible combinations between available modulations, data rates and antenna ports (if EUT with antenna diversity architecture).
- Following channel(s) was (were) selected for the final test as listed below.

EUT Configure Mode	Frequency Band (MHz)	Mode	Available Channel	Tested Channel	Modulation Technology	Modulation Type	Data Rate (Mbps)
-	5745-5825	802.11n (HT20)	149 to 165	165	OFDM	BPSK	MCS0

Antenna Port Conducted Measurement:

- This item includes all test value of each mode, but only includes spectrum plot of worst value of each mode.
- Pre-Scan has been conducted to determine the worst-case mode from all possible combinations between available modulations, data rates and antenna ports (if EUT with antenna diversity architecture).
- Following channel(s) was (were) selected for the final test as listed below.

EUT Configure Mode	Frequency Band (MHz)	Mode	Available Channel	Tested Channel	Modulation Technology	Modulation Type	Data Rate (Mbps)
-	5180-5240	802.11a	36 to 48	36, 44, 48	OFDM	BPSK	6.0
-		802.11n (HT20)	36 to 48	36, 44, 48	OFDM	BPSK	MCS0
-		802.11n (HT40)	38 to 46	38, 46	OFDM	BPSK	MCS0
-		802.11ac (VHT80)	42	42	OFDM	BPSK	MCS0
-	5260-5320	802.11a	52 to 64	52, 60, 64	OFDM	BPSK	6.0
-		802.11n (HT20)	52 to 64	52, 60, 64	OFDM	BPSK	MCS0
-		802.11n (HT40)	54 to 62	54, 62	OFDM	BPSK	MCS0
-		802.11ac (VHT80)	58	58	OFDM	BPSK	MCS0
-	5500-5700	802.11a	100 to 140	100, 116, 140	OFDM	BPSK	6.0
-		802.11n (HT20)	100 to 140	100, 116, 140	OFDM	BPSK	MCS0
-		802.11n (HT40)	102 to 134	102, 110, 134	OFDM	BPSK	MCS0
-		802.11ac (VHT80)	106 to 122	106, 122	OFDM	BPSK	MCS0
-	5745-5825	802.11a	149 to 165	149, 157, 165	OFDM	BPSK	6.0
-		802.11n (HT20)	149 to 165	149, 157, 165	OFDM	BPSK	MCS0
-		802.11n (HT40)	151 to 159	151, 159	OFDM	BPSK	MCS0
-		802.11ac (VHT80)	155	155	OFDM	BPSK	MCS0

Test Condition:

Applicable To	Environmental Conditions	Input Power	Tested by
RE \geq 1G	25 deg. C, 65 % RH	120 Vac, 60 Hz	Karl Lee, Charles Hsiao
RE $<$ 1G	25 deg. C, 65 % RH	120 Vac, 60 Hz	Karl Lee
PLC	25 deg. C, 65 % RH	120 Vac, 60 Hz	Getaz Yang
APCM	25 deg. C, 65 % RH	3.85 Vdc	Anson Lin

3.3 Duty Cycle of Test Signal

MODULATION TYPE: BPSK

802.11a: Duty cycle = $1.423/1.536 = 0.926$, Duty factor = $10 * \log(1/0.926) = 0.33$

802.11n (HT20): Duty cycle = $1.334/1.439 = 0.927$, Duty factor = $10 * \log(1/0.927) = 0.33$

802.11n (HT40): Duty cycle = $0.663/0.767 = 0.864$, Duty factor = $10 * \log(1/0.864) = 0.63$

802.11ac (VHT80): Duty cycle = $0.331/0.446 = 0.742$, Duty factor = $10 * \log(1/0.742) = 1.30$

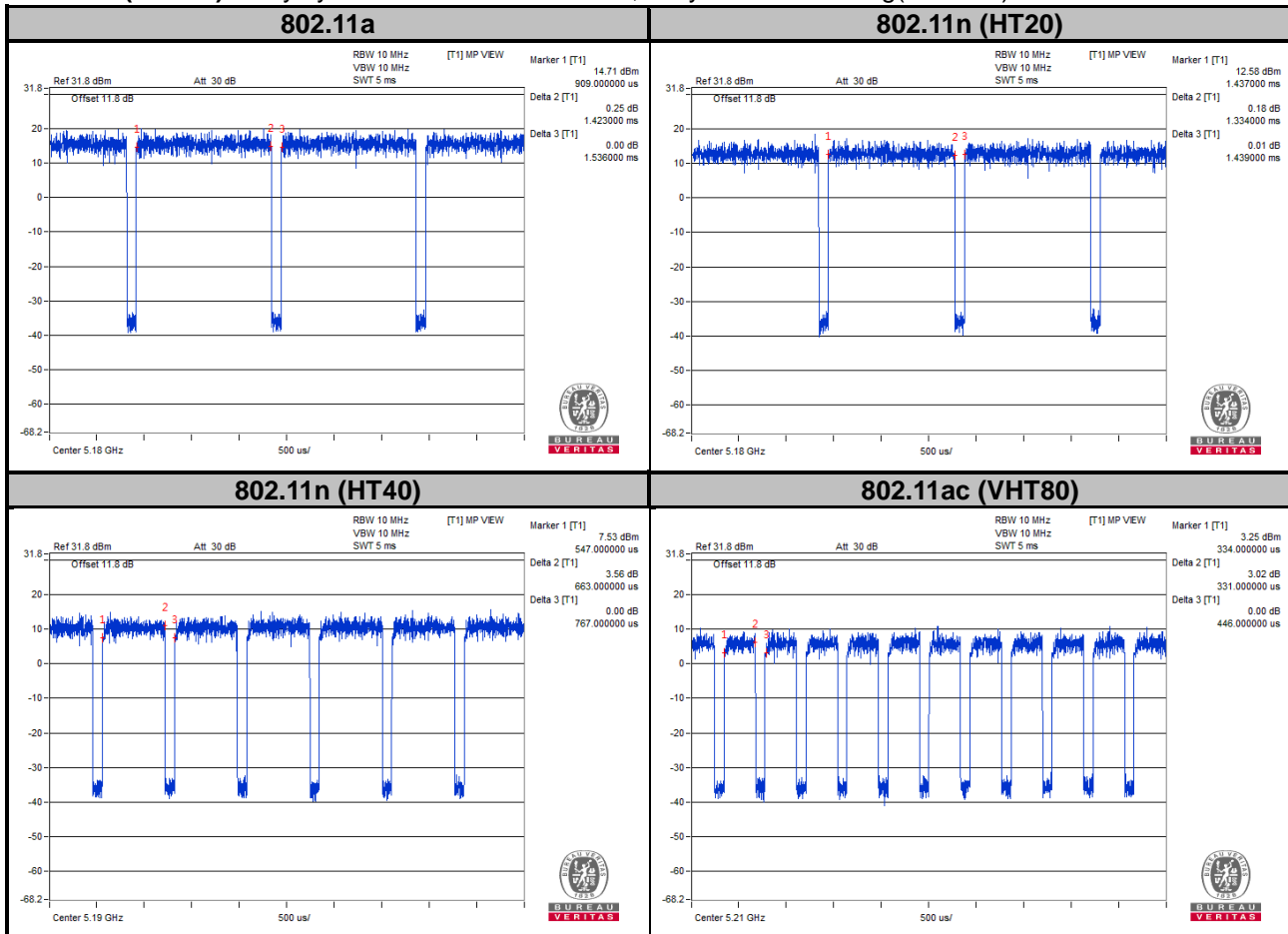

3.4 Description of Support Units

The EUT has been tested as an independent unit together with other necessary accessories or support units. The following support units or accessories were used to form a representative test configuration during the tests.

No.	Product	Brand	Model No.	Serial No.	FCC ID
1.	Adapter	Verifone	N/A	N/A	N/A

No.	Signal Cable Description Of The Above Support Units
1.	N/A

Note:

1. All power cords of the above support units are non-shielded (1.8m).
2. Item 1 was provided by client.

3.4.1 Configuration of System under Test

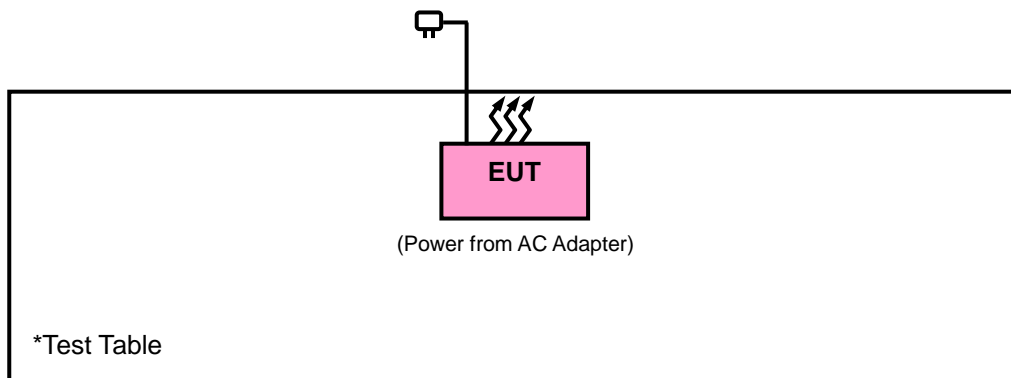

3.5 General Description of Applied Standards

The EUT is a RF Product. According to the specifications of the manufacturer, it must comply with the requirements of the following standards:

FCC Part 15, Subpart E (15.407)

789033 D02 General UNII Test Procedures New Rules v01r04

644545 D01 Guidance for IEEE 802 11ac v01r02

ANSI C63.10-2013

All test items have been performed and recorded as per the above standards.

Note: The EUT has been verified to comply with the requirements of FCC Part 15, Subpart B, Class B (DoC). The test report has been issued separately.

4 Test Types and Results

4.1 Radiated Emission and Bandedge Measurement

4.1.1 Limits of Radiated Emission and Bandedge Measurement

Radiated emissions which fall in the restricted bands must comply with the radiated emission limits specified as below table. Other emissions shall be at least 20 dB below the highest level of the desired power:

Frequencies (MHz)	Field Strength (microvolts/meter)	Measurement Distance (meters)
0.009 ~ 0.490	2400/F (kHz)	300
0.490 ~ 1.705	24000/F (kHz)	30
1.705 ~ 30.0	30	30
30 ~ 88	100	3
88 ~ 216	150	3
216 ~ 960	200	3
Above 960	500	3

Note:

1. The lower limit shall apply at the transition frequencies.
2. Emission level (dBuV/m) = 20 log Emission level (uV/m).
3. For frequencies above 1000 MHz, the field strength limits are based on average detector, however, the peak field strength of any emission shall not exceed the maximum permitted average limits, specified above by more than 20 dB under any condition of modulation.

4.1.2 Limits of Unwanted Emission Out of the Restricted Bands

Applicable To		Limit	
789033 D02 General UNII Test Procedures New Rules v01r04		Field Strength at 3 m	
		PK: 74 (dBµV/m)	AV: 54 (dBµV/m)
Frequency Band	Applicable To	EIRP Limit	Equivalent Field Strength at 3 m
5150~5250 MHz	15.407(b)(1)	PK: -27 (dBm/MHz)	PK: 68.2 (dBµV/m)
5250~5350 MHz	15.407(b)(2)		
5470~5725 MHz	15.407(b)(3)		
5725~5850 MHz	15.407(b)(4)(i)	PK:-27 (dBm/MHz) ^{*1} PK:10 (dBm/MHz) ^{*2} PK:15.6 (dBm/MHz) ^{*3} PK:27 (dBm/MHz) ^{*4}	PK: 68.2 (dBµV/m) ^{*1} PK:105.2 (dBµV/m) ^{*2} PK: 110.8 (dBµV/m) ^{*3} PK:122.2 (dBµV/m) ^{*4}
	15.407(b)(4)(ii)	Emission limits in section 15.247(d)	

^{*1} beyond 75 MHz or more above of the band edge.

^{*2} below the band edge increasing linearly to 10 dBm/MHz at 25 MHz above.

^{*3} below the band edge increasing linearly to a level of 15.6 dBm/MHz at 5 MHz above.

^{*4} from 5 MHz above or below the band edge increasing linearly to a level of 27 dBm/MHz at the band edge.

Note:

The following formula is used to convert the equipment isotropic radiated power (eirp) to field strength:

$$E = \frac{1000000\sqrt{30P}}{3} \mu\text{V/m, where P is the eirp (Watts).}$$

4.1.3 Test Instruments

Description & Manufacturer	Model No.	Serial No.	Date of Calibration	Due Date of Calibration
Test Receiver Agilent Technologies	N9038A	MY52260177	Jul. 05, 2017	Jul. 04, 2018
Spectrum Analyzer ROHDE & SCHWARZ	FSU43	101261	Dec. 13, 2016	Dec. 12, 2017
BILOG Antenna SCHWARZBECK	VULB9168	9168-472	Dec. 16, 2016	Dec. 15, 2017
HORN Antenna ETS-Lindgren	3117	00143293	Dec. 29, 2016	Dec. 28, 2017
HORN Antenna SCHWARZBECK	BBHA 9170	9170-480	Dec. 14, 2016	Dec. 13, 2017
Bluetooth Tester	CBT	100980	Jun. 28, 2017	Jun. 27, 2018
Loop Antenna	EM-6879	269	Aug. 11, 2016	Aug. 10, 2017
Preamplifier Agilent	310N	187226	Jun. 23, 2017	Jun. 22, 2018
Preamplifier Agilent	83017A	MY39501357	Jun. 23, 2017	Jun. 22, 2018
Power Meter Anritsu	ML2495A	1232002	Sep. 08, 2016	Sep. 07, 2017
Power Sensor Anritsu	MA2411B	1207325	Sep. 08, 2016	Sep. 07, 2017
RF signal cable ETS-LINDGREN	5D-FB	Cable-CH1-01(R FC-SMS-100-SM S-120+RFC-SMS -100-SMS-400)	Jun. 24, 2017	Jun. 23, 2018
RF signal cable ETS-LINDGREN	8D-FB	Cable-CH1-02(R FC-SMS-100-SM S-24)	Jun. 24, 2017	Jun. 23, 2018
Software BV ADT	E3 8.130425b	NA	NA	NA
Antenna Tower MF	NA	NA	NA	NA
Turn Table MF	NA	NA	NA	NA
Antenna Tower & Turn Table Controller MF	MF-7802	NA	NA	NA
Temperature & Humidity Chamber	GTH-120-40-CP-A R	MAA1306-019	Sep. 02, 2016	Sep. 01, 2017
DC Power Supply Topward	33010D	807748	Oct. 25, 2016	Oct. 24, 2018
Digital Multimeter Fluke	87-III	70360742	Jul. 01, 2016 Jun. 30, 2017	Jun. 30, 2017 Jun. 29, 2018

- Note: 1. The calibration interval of the above test instruments is 12 / 24 months and the calibrations are traceable to NML/ROC and NIST/USA.
2. The test was performed in HsinTien Chamber 1.
3. The horn antenna and preamplifier (model: 83017A) are used only for the measurement of emission frequency above 1 GHz if tested.
4. The IC Site Registration No. is IC7450I-1.

4.1.4 Test Procedures

- a. The EUT was placed on the top of a rotating table 0.8 meters (for below 1 GHz) / 1.5 meters (for above 1 GHz) above the ground at 3 meter chamber room for test. The table was rotated 360 degrees to determine the position of the highest radiation.
- b. The EUT was set 3 meters away from the interference-receiving antenna, which was mounted on the top of a variable-height antenna tower.
- c. The height of antenna is varied from one meter to four meters above the ground to determine the maximum value of the field strength. Both horizontal and vertical polarizations of the antenna are set to make the measurement.
- d. For each suspected emission, the EUT was arranged to its worst case and then the antenna was tuned to heights from 1 meter to 4 meters and the rotatable table was turned from 0 degrees to 360 degrees to find the maximum reading.
- e. The test-receiver system was set to quasi-peak detect function and specified bandwidth with maximum hold mode when the test frequency is below 1 GHz.
- f. The test-receiver system was set to peak and average detected function and specified bandwidth with maximum hold mode when the test frequency is above 1 GHz. If the peak reading value also meets average limit, measurement with the average detector is unnecessary.

Note:

1. The resolution bandwidth and video bandwidth of test receiver/spectrum analyzer is 120 kHz & 360 kHz for Quasi-peak detection (QP) at frequency below 1 GHz.
2. The resolution bandwidth of test receiver/spectrum analyzer is 1 MHz and the video bandwidth is 3 MHz for Peak detection (PK) at frequency above 1 GHz.
3. The resolution bandwidth of test receiver/spectrum analyzer is 1 MHz and the video bandwidth is 1/T for Average (Duty cycle < 98 %) detection at frequency above 1 GHz.
4. The resolution bandwidth of test receiver/spectrum analyzer is 1 MHz and the video bandwidth is 10 Hz (Duty cycle \geq 98 %) for Average detection (AV) at frequency above 1 GHz.
5. All modes of operation were investigated and the worst-case emissions are reported.

4.1.5 Deviation from Test Standard

No deviation.

4.1.6 Test Set Up

<Radiated emission below 30MHz>

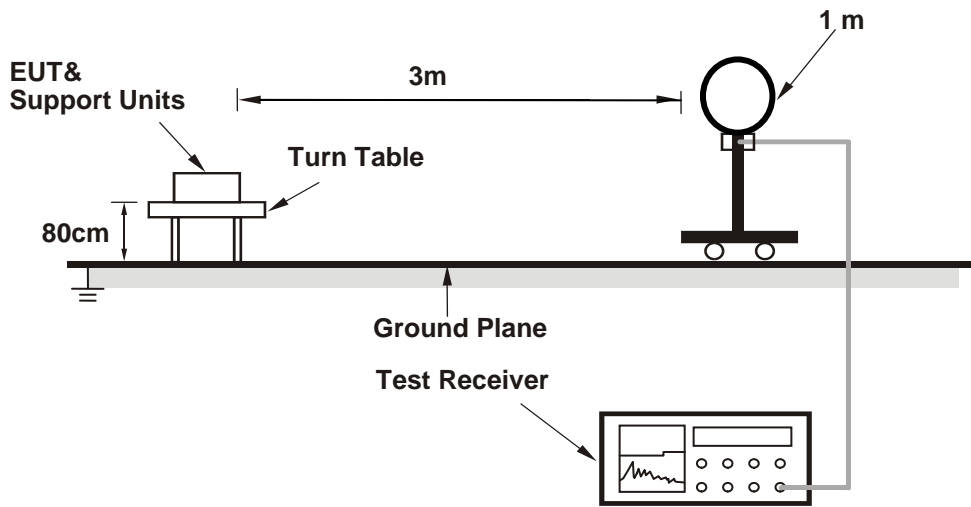

<Frequency Range below 1 GHz>

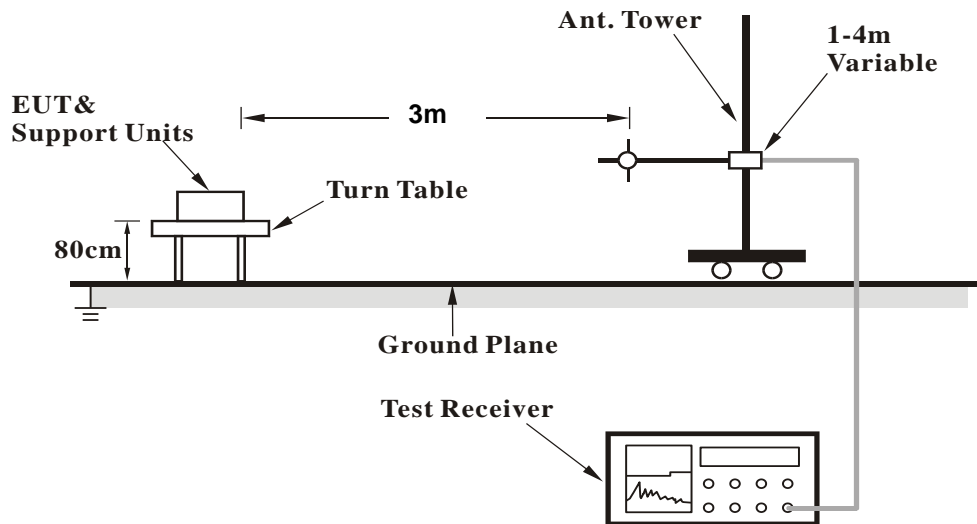

<Frequency Range above 1 GHz>

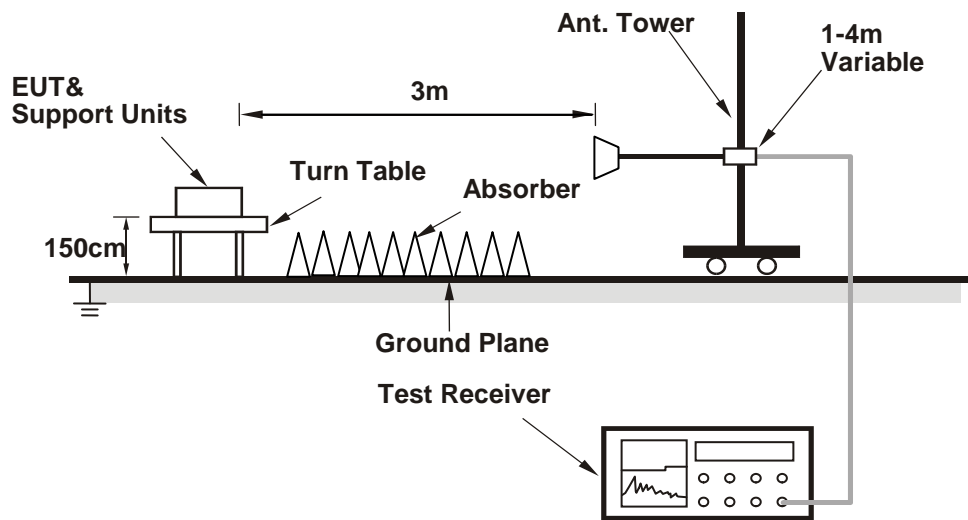

For the actual test configuration, please refer to the attached file (Test Setup Photo).

4.1.7 EUT Operating Conditions

- Placed the EUT on a testing table.
- Use the software to control the EUT under transmission condition continuously at specific channel frequency.

4.1.8 Test Results
 Above 1 GHz Data :
 802.11a

EUT Test Condition		Measurement Detail	
Channel	Channel 36	Frequency Range	1 GHz ~ 40 GHz
Input Power	120 Vac, 60 Hz	Detector Function	Peak (PK) Average (AV)
Environmental Conditions	25 deg. C, 65 % RH	Tested By	Karl Lee

Antenna Polarity & Test Distance: Horizontal at 3 m										
Frequency (MHz)	Emission Level (dBuV/m)	Read Level (dBuV)	Limit (dBuV/m)	Margin (dB)	Antenna Factor (dB/m)	Cable Loss (dB)	Preamp Factor (dB)	Antenna Height (cm)	Table Angle (Degree)	Remark
5148.65	44.72	36.47	54	-9.28	34.12	8.13	34	118	20	Average
5148.65	56.57	48.32	74	-17.43	34.12	8.13	34	118	20	Peak
5180	95.01	86.7			34.15	8.16	34	118	20	Average
5180	102.15	93.84			34.15	8.16	34	118	20	Peak
*10360	56.31	42.01	68.2	-11.89	37.12	12.3	35.12	127	163	Peak

Antenna Polarity & Test Distance: Vertical at 3 m										
Frequency (MHz)	Emission Level (dBuV/m)	Read Level (dBuV)	Limit (dBuV/m)	Margin (dB)	Antenna Factor (dB/m)	Cable Loss (dB)	Preamp Factor (dB)	Antenna Height (cm)	Table Angle (Degree)	Remark
5149.1	45.32	37.07	54	-8.68	34.12	8.13	34	183	2	Average
5149.1	58.08	49.83	74	-15.92	34.12	8.13	34	183	2	Peak
5180	96.4	88.09			34.15	8.16	34	183	2	Average
5180	104.9	96.59			34.15	8.16	34	183	2	Peak
*10360	55.71	41.41	68.2	-12.49	37.12	12.3	35.12	155	270	Peak

Remarks:

- Emission Level = Read Level + Antenna Factor + Cable Loss - Preamp Factor
 Margin value = Emission level – Limit value
- 5180 MHz: Fundamental Frequency
- *: Out of Restricted Band

EUT Test Condition		Measurement Detail	
Channel	Channel 44	Frequency Range	1 GHz ~ 40 GHz
Input Power	120 Vac, 60 Hz	Detector Function	Peak (PK) Average (AV)
Environmental Conditions	25 deg. C, 65 % RH	Tested By	Karl Lee

Antenna Polarity & Test Distance: Horizontal at 3 m										
Frequency (MHz)	Emission Level (dBuV/m)	Read Level (dBuV)	Limit (dBuV/m)	Margin (dB)	Antenna Factor (dB/m)	Cable Loss (dB)	Preamp Factor (dB)	Antenna Height (cm)	Table Angle (Degree)	Remark
5143.7	43.04	34.78	54	-10.96	34.12	8.13	33.99	178	20	Average
5143.7	54.79	46.53	74	-19.21	34.12	8.13	33.99	178	20	Peak
5220	95.05	86.66			34.17	8.22	34	178	20	Average
5220	102.35	93.96			34.17	8.22	34	178	20	Peak
5406.98	43.05	34.33	54	-10.95	34.32	8.44	34.04	178	20	Average
5406.98	54.47	45.75	74	-19.53	34.32	8.44	34.04	178	20	Peak

Antenna Polarity & Test Distance: Vertical at 3 m										
Frequency (MHz)	Emission Level (dBuV/m)	Read Level (dBuV)	Limit (dBuV/m)	Margin (dB)	Antenna Factor (dB/m)	Cable Loss (dB)	Preamp Factor (dB)	Antenna Height (cm)	Table Angle (Degree)	Remark
5012	42.96	34.95	54	-11.04	34.01	7.97	33.97	188	2	Average
5012	53.94	45.93	74	-20.06	34.01	7.97	33.97	188	2	Peak
5220	94.06	85.67			34.17	8.22	34	188	2	Average
5220	101.96	93.57			34.17	8.22	34	188	2	Peak
5418.53	43.25	34.52	54	-10.75	34.33	8.44	34.04	188	2	Average
5418.53	53.4	44.67	74	-20.6	34.33	8.44	34.04	188	2	Peak

Remarks:

- Emission Level = Read Level + Antenna Factor + Cable Loss - Preamp Factor
Margin value = Emission level – Limit value
- 5220 MHz: Fundamental Frequency

EUT Test Condition		Measurement Detail	
Channel	Channel 48	Frequency Range	1 GHz ~ 40 GHz
Input Power	120 Vac, 60 Hz	Detector Function	Peak (PK) Average (AV)
Environmental Conditions	25 deg. C, 65 % RH	Tested By	Karl Lee

Antenna Polarity & Test Distance: Horizontal at 3 m										
Frequency (MHz)	Emission Level (dBuV/m)	Read Level (dBuV)	Limit (dBuV/m)	Margin (dB)	Antenna Factor (dB/m)	Cable Loss (dB)	Preamp Factor (dB)	Antenna Height (cm)	Table Angle (Degree)	Remark
5240	94.93	86.49			34.19	8.26	34.01	118	20	Average
5240	103.18	94.74			34.19	8.26	34.01	118	20	Peak
5357.59	43.09	34.46	54	-10.91	34.28	8.38	34.03	118	20	Average
5357.59	54.14	45.51	74	-19.86	34.28	8.38	34.03	118	20	Peak
*10480	56.84	42.33	68.2	-11.36	37.19	12.53	35.21	192	307	Peak
Antenna Polarity & Test Distance: Vertical at 3 m										
Frequency (MHz)	Emission Level (dBuV/m)	Read Level (dBuV)	Limit (dBuV/m)	Margin (dB)	Antenna Factor (dB/m)	Cable Loss (dB)	Preamp Factor (dB)	Antenna Height (cm)	Table Angle (Degree)	Remark
5240	94.2	85.76			34.19	8.26	34.01	188	2	Average
5240	101.09	92.65			34.19	8.26	34.01	188	2	Peak
5408.52	43.14	34.42	54	-10.86	34.32	8.44	34.04	188	2	Average
5408.52	53.86	45.14	74	-20.14	34.32	8.44	34.04	188	2	Peak
*10480	57.22	42.71	68.2	-10.98	37.19	12.53	35.21	137	164	Peak

Remarks:

- Emission Level = Read Level + Antenna Factor + Cable Loss - Preamp Factor
Margin value = Emission level – Limit value
- 5240 MHz: Fundamental Frequency
- *: Out of Restricted Band

EUT Test Condition		Measurement Detail	
Channel	Channel 52	Frequency Range	1 GHz ~ 40 GHz
Input Power	120 Vac, 60 Hz	Detector Function	Peak (PK) Average (AV)
Environmental Conditions	25 deg. C, 65 % RH	Tested By	Karl Lee

Antenna Polarity & Test Distance: Horizontal at 3 m										
Frequency (MHz)	Emission Level (dBuV/m)	Read Level (dBuV)	Limit (dBuV/m)	Margin (dB)	Antenna Factor (dB/m)	Cable Loss (dB)	Preamp Factor (dB)	Antenna Height (cm)	Table Angle (Degree)	Remark
5147.9	42.95	34.7	54	-11.05	34.12	8.13	34	106	0	Average
5147.9	53.4	45.15	74	-20.6	34.12	8.13	34	106	0	Peak
5260	95.27	86.81			34.21	8.26	34.01	106	0	Average
5260	103.92	95.46			34.21	8.26	34.01	106	0	Peak
*10520	56.59	42	68.2	-11.61	37.21	12.61	35.23	139	325	Peak

Antenna Polarity & Test Distance: Vertical at 3 m										
Frequency (MHz)	Emission Level (dBuV/m)	Read Level (dBuV)	Limit (dBuV/m)	Margin (dB)	Antenna Factor (dB/m)	Cable Loss (dB)	Preamp Factor (dB)	Antenna Height (cm)	Table Angle (Degree)	Remark
5125.25	42.93	34.71	54	-11.07	34.11	8.1	33.99	123	13	Average
5125.25	54.63	46.41	74	-19.37	34.11	8.1	33.99	123	13	Peak
5260	99.06	90.6			34.21	8.26	34.01	123	13	Average
5260	106.62	98.16			34.21	8.26	34.01	123	13	Peak
*10520	58.29	43.7	68.2	-9.91	37.21	12.61	35.23	156	121	Peak

Remarks:

- Emission Level = Read Level + Antenna Factor + Cable Loss - Preamp Factor
Margin value = Emission level – Limit value
- 5260 MHz: Fundamental Frequency
- *: Out of Restricted Band

EUT Test Condition		Measurement Detail	
Channel	Channel 60	Frequency Range	1 GHz ~ 40 GHz
Input Power	120 Vac, 60 Hz	Detector Function	Peak (PK) Average (AV)
Environmental Conditions	25 deg. C, 65 % RH	Tested By	Karl Lee

Antenna Polarity & Test Distance: Horizontal at 3 m										
Frequency (MHz)	Emission Level (dBuV/m)	Read Level (dBuV)	Limit (dBuV/m)	Margin (dB)	Antenna Factor (dB/m)	Cable Loss (dB)	Preamp Factor (dB)	Antenna Height (cm)	Table Angle (Degree)	Remark
5020.25	43.03	35.02	54	-10.97	34.01	7.97	33.97	110	0	Average
5020.25	53.62	45.61	74	-20.38	34.01	7.97	33.97	110	0	Peak
5300	94.86	86.32			34.24	8.32	34.02	110	0	Average
5300	103.41	94.87			34.24	8.32	34.02	110	0	Peak
5438.99	43.18	34.39	54	-10.82	34.35	8.48	34.04	110	0	Average
5438.99	54.24	45.45	74	-19.76	34.35	8.48	34.04	110	0	Peak

Antenna Polarity & Test Distance: Vertical at 3 m										
Frequency (MHz)	Emission Level (dBuV/m)	Read Level (dBuV)	Limit (dBuV/m)	Margin (dB)	Antenna Factor (dB/m)	Cable Loss (dB)	Preamp Factor (dB)	Antenna Height (cm)	Table Angle (Degree)	Remark
5049.2	42.92	34.86	54	-11.08	34.04	8	33.98	123	13	Average
5049.2	54.22	46.16	74	-19.78	34.04	8	33.98	123	13	Peak
5300	99.2	90.66			34.24	8.32	34.02	123	13	Average
5300	106.57	98.03			34.24	8.32	34.02	123	13	Peak
5351.1	43.35	34.72	54	-10.65	34.28	8.38	34.03	123	13	Average
5351.1	54.44	45.81	74	-19.56	34.28	8.38	34.03	123	13	Peak

Remarks:

- Emission Level = Read Level + Antenna Factor + Cable Loss - Preamp Factor
Margin value = Emission level – Limit value
- 5300 MHz: Fundamental Frequency

EUT Test Condition		Measurement Detail	
Channel	Channel 64	Frequency Range	1 GHz ~ 40 GHz
Input Power	120 Vac, 60 Hz	Detector Function	Peak (PK) Average (AV)
Environmental Conditions	25 deg. C, 65 % RH	Tested By	Karl Lee

Antenna Polarity & Test Distance: Horizontal at 3 m										
Frequency (MHz)	Emission Level (dBuV/m)	Read Level (dBuV)	Limit (dBuV/m)	Margin (dB)	Antenna Factor (dB/m)	Cable Loss (dB)	Preamp Factor (dB)	Antenna Height (cm)	Table Angle (Degree)	Remark
5320	94.89	86.31			34.25	8.35	34.02	110	0	Average
5320	103.19	94.61			34.25	8.35	34.02	110	0	Peak
5352.31	44.31	35.68	54	-9.69	34.28	8.38	34.03	110	0	Average
5352.31	58.93	50.3	74	-15.07	34.28	8.38	34.03	110	0	Peak
10640	47.61	32.88	74	-26.39	37.31	12.71	35.29	149	241	Average
10640	56.76	42.03	74	-17.24	37.31	12.71	35.29	149	241	Peak

Antenna Polarity & Test Distance: Vertical at 3 m										
Frequency (MHz)	Emission Level (dBuV/m)	Read Level (dBuV)	Limit (dBuV/m)	Margin (dB)	Antenna Factor (dB/m)	Cable Loss (dB)	Preamp Factor (dB)	Antenna Height (cm)	Table Angle (Degree)	Remark
5320	98.2	89.62			34.25	8.35	34.02	123	13	Average
5320	106.46	97.88			34.25	8.35	34.02	123	13	Peak
5350.66	44.65	36.02	54	-9.35	34.28	8.38	34.03	123	13	Average
5350.66	58.79	50.16	74	-15.21	34.28	8.38	34.03	123	13	Peak
10640	47.62	32.89	74	-26.38	37.31	12.71	35.29	134	255	Average
10640	56.81	42.08	74	-17.19	37.31	12.71	35.29	134	255	Peak

Remarks:

- Emission Level = Read Level + Antenna Factor + Cable Loss - Preamp Factor
Margin value = Emission level – Limit value
- 5320 MHz: Fundamental Frequency

EUT Test Condition		Measurement Detail	
Channel	Channel 100	Frequency Range	1 GHz ~ 40 GHz
Input Power	120 Vac, 60 Hz	Detector Function	Peak (PK) Average (AV)
Environmental Conditions	25 deg. C, 65 % RH	Tested By	Charles Hsiao

Antenna Polarity & Test Distance: Horizontal at 3 m										
Frequency (MHz)	Emission Level (dBuV/m)	Read Level (dBuV)	Limit (dBuV/m)	Margin (dB)	Antenna Factor (dB/m)	Cable Loss (dB)	Preamp Factor (dB)	Antenna Height (cm)	Table Angle (Degree)	Remark
5458.48	45.16	36.34	54	-8.84	34.36	8.51	34.05	200	121	Average
5458.48	56.35	47.53	74	-17.65	34.36	8.51	34.05	200	121	Peak
*5469.2	64.23	55.4	68.2	-3.97	34.37	8.51	34.05	200	121	Peak
5500	98.75	89.83			34.4	8.57	34.05	200	121	Average
5500	105.04	96.12			34.4	8.57	34.05	200	121	Peak
11000	48.71	33.63	54	-5.29	37.6	12.96	35.48	152	263	Average
11000	57.91	42.83	74	-16.09	37.6	12.96	35.48	152	263	Peak
Antenna Polarity & Test Distance: Vertical at 3 m										
Frequency (MHz)	Emission Level (dBuV/m)	Read Level (dBuV)	Limit (dBuV/m)	Margin (dB)	Antenna Factor (dB/m)	Cable Loss (dB)	Preamp Factor (dB)	Antenna Height (cm)	Table Angle (Degree)	Remark
5458.8	45.02	36.2	54	-8.98	34.36	8.51	34.05	106	163	Average
5458.8	57.18	48.36	74	-16.82	34.36	8.51	34.05	106	163	Peak
*5469.2	62.6	53.77	68.2	-5.6	34.37	8.51	34.05	106	163	Peak
5500	96.65	87.73			34.4	8.57	34.05	106	163	Average
5500	103.56	94.64			34.4	8.57	34.05	106	163	Peak
11000	48.07	32.99	54	-5.93	37.6	12.96	35.48	125	164	Average
11000	57.1	42.02	74	-16.9	37.6	12.96	35.48	125	164	Peak

Remarks:

- Emission Level = Read Level + Antenna Factor + Cable Loss - Preamp Factor
Margin value = Emission level – Limit value
- 5500 MHz: Fundamental Frequency
- *: Out of Restricted Band

EUT Test Condition		Measurement Detail	
Channel	Channel 116	Frequency Range	1 GHz ~ 40 GHz
Input Power	120 Vac, 60 Hz	Detector Function	Peak (PK) Average (AV)
Environmental Conditions	25 deg. C, 65 % RH	Tested By	Charles Hsiao

Antenna Polarity & Test Distance: Horizontal at 3 m										
Frequency (MHz)	Emission Level (dBuV/m)	Read Level (dBuV)	Limit (dBuV/m)	Margin (dB)	Antenna Factor (dB/m)	Cable Loss (dB)	Preamp Factor (dB)	Antenna Height (cm)	Table Angle (Degree)	Remark
5443.44	43.11	34.32	54	-10.89	34.35	8.48	34.04	200	121	Average
5443.44	54.28	45.49	74	-19.72	34.35	8.48	34.04	200	121	Peak
*5469.84	52.29	43.46	68.2	-15.91	34.37	8.51	34.05	200	121	Peak
5580	98.24	89.25			34.47	8.6	34.08	200	121	Average
5580	105.62	96.63			34.47	8.6	34.08	200	121	Peak
*5726.04	53.27	44.11	68.2	-14.93	34.62	8.65	34.11	200	121	Peak
Antenna Polarity & Test Distance: Vertical at 3 m										
Frequency (MHz)	Emission Level (dBuV/m)	Read Level (dBuV)	Limit (dBuV/m)	Margin (dB)	Antenna Factor (dB/m)	Cable Loss (dB)	Preamp Factor (dB)	Antenna Height (cm)	Table Angle (Degree)	Remark
5426.64	43.17	34.4	54	-10.83	34.33	8.48	34.04	106	163	Average
5426.64	54.23	45.46	74	-19.77	34.33	8.48	34.04	106	163	Peak
*5468.56	53.73	44.9	68.2	-14.47	34.37	8.51	34.05	106	163	Peak
5580	96.74	87.75			34.47	8.6	34.08	106	163	Average
5580	103.69	94.7			34.47	8.6	34.08	106	163	Peak
*5724.68	53.36	44.2	68.2	-14.84	34.62	8.65	34.11	106	163	Peak

Remarks:

- Emission Level = Read Level + Antenna Factor + Cable Loss - Preamp Factor
Margin value = Emission level – Limit value
- 5580 MHz: Fundamental Frequency
- *: Out of Restricted Band

EUT Test Condition		Measurement Detail	
Channel	Channel 140	Frequency Range	1 GHz ~ 40 GHz
Input Power	120 Vac, 60 Hz	Detector Function	Peak (PK) Average (AV)
Environmental Conditions	25 deg. C, 65 % RH	Tested By	Charles Hsiao

Antenna Polarity & Test Distance: Horizontal at 3 m										
Frequency (MHz)	Emission Level (dBuV/m)	Read Level (dBuV)	Limit (dBuV/m)	Margin (dB)	Antenna Factor (dB/m)	Cable Loss (dB)	Preamp Factor (dB)	Antenna Height (cm)	Table Angle (Degree)	Remark
5700	98.65	89.52			34.59	8.64	34.1	200	121	Average
5700	105.21	96.08			34.59	8.64	34.1	200	121	Peak
*5724.2	60.59	51.43	68.2	-7.61	34.62	8.65	34.11	200	121	Peak
11400	48.13	33.03	54	-5.87	37.84	12.67	35.41	156	121	Average
11400	57.07	41.97	74	-16.93	37.84	12.67	35.41	156	121	Peak

Antenna Polarity & Test Distance: Vertical at 3 m										
Frequency (MHz)	Emission Level (dBuV/m)	Read Level (dBuV)	Limit (dBuV/m)	Margin (dB)	Antenna Factor (dB/m)	Cable Loss (dB)	Preamp Factor (dB)	Antenna Height (cm)	Table Angle (Degree)	Remark
5700	96.74	87.61			34.59	8.64	34.1	101	163	Average
5700	103.11	93.98			34.59	8.64	34.1	101	163	Peak
*5724.36	63.87	54.71	68.2	-4.33	34.62	8.65	34.11	101	163	Peak
11400	47.61	32.51	54	-6.39	37.84	12.67	35.41	126	174	Average
11400	56.71	41.61	74	-17.29	37.84	12.67	35.41	126	174	Peak

Remarks:

- Emission Level = Read Level + Antenna Factor + Cable Loss - Preamp Factor
Margin value = Emission level – Limit value
- 5700 MHz: Fundamental Frequency
- *: Out of Restricted Band

EUT Test Condition		Measurement Detail	
Channel	Channel 149	Frequency Range	1 GHz ~ 40 GHz
Input Power	120 Vac, 60 Hz	Detector Function	Peak (PK) Average (AV)
Environmental Conditions	25 deg. C, 65 % RH	Tested By	Karl Lee

<Spurious Emission>

Antenna Polarity & Test Distance: Horizontal at 3 m										
Frequency (MHz)	Emission Level (dBuV/m)	Read Level (dBuV)	Limit (dBuV/m)	Margin (dB)	Antenna Factor (dB/m)	Cable Loss (dB)	Preamp Factor (dB)	Antenna Height (cm)	Table Angle (Degree)	Remark
5745	96.73	87.54			34.64	8.66	34.11	183	112	Average
5745	103.82	94.63			34.64	8.66	34.11	183	112	Peak
11490	48.62	33.5	54	-5.38	37.89	12.62	35.39	161	205	Average
11490	57.79	42.67	74	-16.21	37.89	12.62	35.39	161	205	Peak
Antenna Polarity & Test Distance: Vertical at 3 m										
Frequency (MHz)	Emission Level (dBuV/m)	Read Level (dBuV)	Limit (dBuV/m)	Margin (dB)	Antenna Factor (dB/m)	Cable Loss (dB)	Preamp Factor (dB)	Antenna Height (cm)	Table Angle (Degree)	Remark
5745	100.31	91.12			34.64	8.66	34.11	127	327	Average
5745	107.3	98.11			34.64	8.66	34.11	127	327	Peak
11490	48.35	33.23	54	-5.65	37.89	12.62	35.39	157	124	Average
11490	57.97	42.85	74	-16.03	37.89	12.62	35.39	157	124	Peak

<Out of Band Emission (OOBE)>

Antenna Polarity & Test Distance: Horizontal at 3 m										
Frequency (MHz)	Emission Level (dBuV/m)	Read Level (dBuV)	Limit (dBuV/m)	Margin (dB)	Antenna Factor (dB/m)	Cable Loss (dB)	Preamp Factor (dB)	Antenna Height (cm)	Table Angle (Degree)	Remark
*5630.2	53.41	44.36	68.2	-14.79	34.52	8.62	34.09	183	112	Peak
*5653.3	50.5	41.4	70.64	-20.14	34.56	8.63	34.09	183	112	Peak
*5922.625	50.94	41.54	69.96	-19.02	34.83	8.73	34.16	183	112	Peak
*5949.925	54.11	44.68	68.2	-14.09	34.85	8.74	34.16	183	112	Peak
Antenna Polarity & Test Distance: Vertical at 3 m										
Frequency (MHz)	Emission Level (dBuV/m)	Read Level (dBuV)	Limit (dBuV/m)	Margin (dB)	Antenna Factor (dB/m)	Cable Loss (dB)	Preamp Factor (dB)	Antenna Height (cm)	Table Angle (Degree)	Remark
*5608.675	55.08	46.05	68.2	-13.12	34.5	8.61	34.08	127	327	Peak
*5651.725	51.47	42.38	69.48	-18.01	34.56	8.62	34.09	127	327	Peak
*5920.525	52.75	43.37	71.51	-18.76	34.81	8.73	34.16	127	327	Peak
*5997.175	54.35	44.86	68.2	-13.85	34.9	8.76	34.17	127	327	Peak

Remarks:

- Emission Level = Read Level + Antenna Factor + Cable Loss - Preamp Factor
Margin value = Emission level – Limit value
- 5745 MHz: Fundamental Frequency
- *: Out of Restricted Band

EUT Test Condition		Measurement Detail	
Channel	Channel 157	Frequency Range	1 GHz ~ 40 GHz
Input Power	120 Vac, 60 Hz	Detector Function	Peak (PK) Average (AV)
Environmental Conditions	25 deg. C, 65 % RH	Tested By	Karl Lee

<Spurious Emission>

Antenna Polarity & Test Distance: Horizontal at 3 m										
Frequency (MHz)	Emission Level (dBuV/m)	Read Level (dBuV)	Limit (dBuV/m)	Margin (dB)	Antenna Factor (dB/m)	Cable Loss (dB)	Preamp Factor (dB)	Antenna Height (cm)	Table Angle (Degree)	Remark
5785	94.6	85.37			34.68	8.68	34.13	183	112	Average
5785	103.32	94.09			34.68	8.68	34.13	183	112	Peak
11570	48.42	33.11	54	-5.58	38	12.68	35.37	193	80	Average
11570	57.53	42.22	74	-16.47	38	12.68	35.37	193	80	Peak
Antenna Polarity & Test Distance: Vertical at 3 m										
Frequency (MHz)	Emission Level (dBuV/m)	Read Level (dBuV)	Limit (dBuV/m)	Margin (dB)	Antenna Factor (dB/m)	Cable Loss (dB)	Preamp Factor (dB)	Antenna Height (cm)	Table Angle (Degree)	Remark
5785	99.88	90.65			34.68	8.68	34.13	127	327	Average
5785	107.92	98.69			34.68	8.68	34.13	127	327	Peak
11570	48.23	32.92	54	-5.77	38	12.68	35.37	166	127	Average
11570	57.01	41.7	74	-16.99	38	12.68	35.37	166	127	Peak

<Out of Band Emission (OOBE)>

Antenna Polarity & Test Distance: Horizontal at 3 m										
Frequency (MHz)	Emission Level (dBuV/m)	Read Level (dBuV)	Limit (dBuV/m)	Margin (dB)	Antenna Factor (dB/m)	Cable Loss (dB)	Preamp Factor (dB)	Antenna Height (cm)	Table Angle (Degree)	Remark
*5637.55	53.61	44.54	68.2	-14.59	34.54	8.62	34.09	183	112	Peak
*5652.25	51.88	42.79	69.86	-17.98	34.56	8.62	34.09	183	112	Peak
*5922.625	50.64	41.24	69.96	-19.32	34.83	8.73	34.16	183	112	Peak
*5992.975	54.46	44.97	68.2	-13.74	34.9	8.76	34.17	183	112	Peak
Antenna Polarity & Test Distance: Vertical at 3 m										
Frequency (MHz)	Emission Level (dBuV/m)	Read Level (dBuV)	Limit (dBuV/m)	Margin (dB)	Antenna Factor (dB/m)	Cable Loss (dB)	Preamp Factor (dB)	Antenna Height (cm)	Table Angle (Degree)	Remark
*5635.45	53.64	44.57	68.2	-14.56	34.54	8.62	34.09	127	327	Peak
*5652.25	51.99	42.9	69.86	-17.87	34.56	8.62	34.09	127	327	Peak
*5921.05	50.93	41.55	71.12	-20.19	34.81	8.73	34.16	127	327	Peak
*6000.325	54.47	44.98	68.2	-13.73	34.9	8.76	34.17	127	327	Peak

Remarks:

- Emission Level = Read Level + Antenna Factor + Cable Loss - Preamp Factor
Margin value = Emission level – Limit value
- 5785 MHz: Fundamental Frequency
- *: Out of Restricted Band

EUT Test Condition		Measurement Detail	
Channel	Channel 165	Frequency Range	1 GHz ~ 40 GHz
Input Power	120 Vac, 60 Hz	Detector Function	Peak (PK) Average (AV)
Environmental Conditions	25 deg. C, 65 % RH	Tested By	Karl Lee

<Spurious Emission>

Antenna Polarity & Test Distance: Horizontal at 3 m										
Frequency (MHz)	Emission Level (dBuV/m)	Read Level (dBuV)	Limit (dBuV/m)	Margin (dB)	Antenna Factor (dB/m)	Cable Loss (dB)	Preamp Factor (dB)	Antenna Height (cm)	Table Angle (Degree)	Remark
5825	96.59	87.3			34.73	8.69	34.13	183	112	Average
5825	103.36	94.07			34.73	8.69	34.13	183	112	Peak
11650	49.12	33.59	54	-4.88	38.09	12.8	35.36	156	243	Average
11650	59.88	44.35	74	-14.12	38.09	12.8	35.36	156	243	Peak
Antenna Polarity & Test Distance: Vertical at 3 m										
Frequency (MHz)	Emission Level (dBuV/m)	Read Level (dBuV)	Limit (dBuV/m)	Margin (dB)	Antenna Factor (dB/m)	Cable Loss (dB)	Preamp Factor (dB)	Antenna Height (cm)	Table Angle (Degree)	Remark
5825	100.85	91.56			34.73	8.69	34.13	127	327	Average
5825	107.6	98.31			34.73	8.69	34.13	127	327	Peak
11650	49.53	34	54	-4.47	38.09	12.8	35.36	195	112	Average
11650	58.82	43.29	74	-15.18	38.09	12.8	35.36	195	112	Peak

<Out of Band Emission (OOBE)>

Antenna Polarity & Test Distance: Horizontal at 3 m										
Frequency (MHz)	Emission Level (dBuV/m)	Read Level (dBuV)	Limit (dBuV/m)	Margin (dB)	Antenna Factor (dB/m)	Cable Loss (dB)	Preamp Factor (dB)	Antenna Height (cm)	Table Angle (Degree)	Remark
*5571.4	54.51	45.52	68.2	-13.69	34.47	8.59	34.07	183	112	Peak
*5652.775	52.21	43.11	70.25	-18.04	34.56	8.63	34.09	183	112	Peak
*5922.625	53.53	44.13	69.96	-16.43	34.83	8.73	34.16	183	112	Peak
*6004	55.59	46.1	68.2	-12.61	34.9	8.76	34.17	183	112	Peak
Antenna Polarity & Test Distance: Vertical at 3 m										
Frequency (MHz)	Emission Level (dBuV/m)	Read Level (dBuV)	Limit (dBuV/m)	Margin (dB)	Antenna Factor (dB/m)	Cable Loss (dB)	Preamp Factor (dB)	Antenna Height (cm)	Table Angle (Degree)	Remark
*5636.5	55.85	46.78	68.2	-12.35	34.54	8.62	34.09	127	327	Peak
*5652.775	53.56	44.46	70.25	-16.69	34.56	8.63	34.09	127	327	Peak
*5922.1	54.39	44.99	70.35	-15.96	34.83	8.73	34.16	127	327	Peak
*5975.125	55.76	46.3	68.2	-12.44	34.88	8.75	34.17	127	327	Peak

Remarks:

- Emission Level = Read Level + Antenna Factor + Cable Loss - Preamp Factor
Margin value = Emission level – Limit value
- 5825 MHz: Fundamental Frequency
- *: Out of Restricted Band

802.11n (HT20)

EUT Test Condition		Measurement Detail	
Channel	Channel 36	Frequency Range	1 GHz ~ 40 GHz
Input Power	120 Vac, 60 Hz	Detector Function	Peak (PK) Average (AV)
Environmental Conditions	25 deg. C, 65 % RH	Tested By	Karl Lee

Antenna Polarity & Test Distance: Horizontal at 3 m

Frequency (MHz)	Emission Level (dBuV/m)	Read Level (dBuV)	Limit (dBuV/m)	Margin (dB)	Antenna Factor (dB/m)	Cable Loss (dB)	Preamp Factor (dB)	Antenna Height (cm)	Table Angle (Degree)	Remark
5108.45	44.01	35.81	54	-9.99	34.09	8.1	33.99	183	2	Average
5108.45	53.72	45.52	74	-20.28	34.09	8.1	33.99	183	2	Peak
5180	93.55	85.24			34.15	8.16	34	183	2	Average
5180	100.73	92.42			34.15	8.16	34	183	2	Peak
10360	55.64	41.34	74	-18.36	37.12	12.3	35.12	124	185	Peak

Antenna Polarity & Test Distance: Vertical at 3 m

Frequency (MHz)	Emission Level (dBuV/m)	Read Level (dBuV)	Limit (dBuV/m)	Margin (dB)	Antenna Factor (dB/m)	Cable Loss (dB)	Preamp Factor (dB)	Antenna Height (cm)	Table Angle (Degree)	Remark
5010.05	43.74	35.73	54	-10.26	34.01	7.97	33.97	118	20	Average
5010.05	54.59	46.58	74	-19.41	34.01	7.97	33.97	118	20	Peak
5180	93.38	85.07			34.15	8.16	34	118	20	Average
5180	101.26	92.95			34.15	8.16	34	118	20	Peak
10360	56.24	41.94	74	-17.76	37.12	12.3	35.12	152	291	Peak

Remarks:

- Emission Level = Read Level + Antenna Factor + Cable Loss - Preamp Factor
Margin value = Emission level – Limit value
- 5180 MHz: Fundamental Frequency

EUT Test Condition		Measurement Detail	
Channel	Channel 44	Frequency Range	1 GHz ~ 40 GHz
Input Power	120 Vac, 60 Hz	Detector Function	Peak (PK) Average (AV)
Environmental Conditions	25 deg. C, 65 % RH	Tested By	Karl Lee

Antenna Polarity & Test Distance: Horizontal at 3 m										
Frequency (MHz)	Emission Level (dBuV/m)	Read Level (dBuV)	Limit (dBuV/m)	Margin (dB)	Antenna Factor (dB/m)	Cable Loss (dB)	Preamp Factor (dB)	Antenna Height (cm)	Table Angle (Degree)	Remark
5132.6	42.92	34.7	54	-11.08	34.11	8.1	33.99	118	20	Average
5132.6	53.69	45.47	74	-20.31	34.11	8.1	33.99	118	20	Peak
5220	93.52	85.13			34.17	8.22	34	118	20	Average
5220	101.87	93.48			34.17	8.22	34	118	20	Peak
5402.14	43.1	34.38	54	-10.9	34.32	8.44	34.04	118	20	Average
5402.14	53.48	44.76	74	-20.52	34.32	8.44	34.04	118	20	Peak

Antenna Polarity & Test Distance: Vertical at 3 m										
Frequency (MHz)	Emission Level (dBuV/m)	Read Level (dBuV)	Limit (dBuV/m)	Margin (dB)	Antenna Factor (dB/m)	Cable Loss (dB)	Preamp Factor (dB)	Antenna Height (cm)	Table Angle (Degree)	Remark
5117.15	43.12	34.92	54	-10.88	34.09	8.1	33.99	183	2	Average
5117.15	53.96	45.76	74	-20.04	34.09	8.1	33.99	183	2	Peak
5220	92.91	84.52			34.17	8.22	34	183	2	Average
5220	100.39	92			34.17	8.22	34	183	2	Peak
5445.48	43.13	34.31	54	-10.87	34.35	8.51	34.04	183	2	Average
5445.48	53.8	44.98	74	-20.2	34.35	8.51	34.04	183	2	Peak

Remarks:

- Emission Level = Read Level + Antenna Factor + Cable Loss - Preamp Factor
Margin value = Emission level – Limit value
- 5220 MHz: Fundamental Frequency

EUT Test Condition		Measurement Detail	
Channel	Channel 48	Frequency Range	1 GHz ~ 40 GHz
Input Power	120 Vac, 60 Hz	Detector Function	Peak (PK) Average (AV)
Environmental Conditions	25 deg. C, 65 % RH	Tested By	Karl Lee

Antenna Polarity & Test Distance: Horizontal at 3 m										
Frequency (MHz)	Emission Level (dBuV/m)	Read Level (dBuV)	Limit (dBuV/m)	Margin (dB)	Antenna Factor (dB/m)	Cable Loss (dB)	Preamp Factor (dB)	Antenna Height (cm)	Table Angle (Degree)	Remark
5240	93.8	85.36			34.19	8.26	34.01	117	20	Average
5240	101	92.56			34.19	8.26	34.01	117	20	Peak
5372.99	43.04	34.37	54	-10.96	34.29	8.41	34.03	117	20	Average
5372.99	53.9	45.23	74	-20.1	34.29	8.41	34.03	117	20	Peak
*10480	56.74	42.23	68.2	-11.46	37.19	12.53	35.21	190	84	Peak
Antenna Polarity & Test Distance: Vertical at 3 m										
Frequency (MHz)	Emission Level (dBuV/m)	Read Level (dBuV)	Limit (dBuV/m)	Margin (dB)	Antenna Factor (dB/m)	Cable Loss (dB)	Preamp Factor (dB)	Antenna Height (cm)	Table Angle (Degree)	Remark
5240	91.78	83.34			34.19	8.26	34.01	183	2	Average
5240	100.07	91.63			34.19	8.26	34.01	183	2	Peak
5431.4	43.03	34.24	54	-10.97	34.35	8.48	34.04	183	2	Average
5431.4	53.53	44.74	74	-20.47	34.35	8.48	34.04	183	2	Peak
*10480	57.34	42.83	68.2	-10.86	37.19	12.53	35.21	142	256	Peak

Remarks:

- Emission Level = Read Level + Antenna Factor + Cable Loss - Preamp Factor
Margin value = Emission level – Limit value
- 5240 MHz: Fundamental Frequency
- *: Out of Restricted Band

EUT Test Condition		Measurement Detail	
Channel	Channel 52	Frequency Range	1 GHz ~ 40 GHz
Input Power	120 Vac, 60 Hz	Detector Function	Peak (PK) Average (AV)
Environmental Conditions	25 deg. C, 65 % RH	Tested By	Karl Lee

Antenna Polarity & Test Distance: Horizontal at 3 m										
Frequency (MHz)	Emission Level (dBuV/m)	Read Level (dBuV)	Limit (dBuV/m)	Margin (dB)	Antenna Factor (dB/m)	Cable Loss (dB)	Preamp Factor (dB)	Antenna Height (cm)	Table Angle (Degree)	Remark
5140.4	42.88	34.62	54	-11.12	34.12	8.13	33.99	110	0	Average
5140.4	53.8	45.54	74	-20.2	34.12	8.13	33.99	110	0	Peak
5260	92.98	84.52			34.21	8.26	34.01	110	0	Average
5260	100.9	92.44			34.21	8.26	34.01	110	0	Peak
*10520	56.75	42.16	68.2	-11.45	37.21	12.61	35.23	173	326	Peak

Antenna Polarity & Test Distance: Vertical at 3 m										
Frequency (MHz)	Emission Level (dBuV/m)	Read Level (dBuV)	Limit (dBuV/m)	Margin (dB)	Antenna Factor (dB/m)	Cable Loss (dB)	Preamp Factor (dB)	Antenna Height (cm)	Table Angle (Degree)	Remark
5127.95	42.87	34.65	54	-11.13	34.11	8.1	33.99	123	14	Average
5127.95	53.53	45.31	74	-20.47	34.11	8.1	33.99	123	14	Peak
5260	96.01	87.55			34.21	8.26	34.01	123	14	Average
5260	103.74	95.28			34.21	8.26	34.01	123	14	Peak
*10520	58.36	43.77	68.2	-9.84	37.21	12.61	35.23	120	185	Peak

Remarks:

- Emission Level = Read Level + Antenna Factor + Cable Loss - Preamp Factor
Margin value = Emission level – Limit value
- 5260 MHz: Fundamental Frequency
- *: Out of Restricted Band

EUT Test Condition		Measurement Detail	
Channel	Channel 60	Frequency Range	1 GHz ~ 40 GHz
Input Power	120 Vac, 60 Hz	Detector Function	Peak (PK) Average (AV)
Environmental Conditions	25 deg. C, 65 % RH	Tested By	Karl Lee

Antenna Polarity & Test Distance: Horizontal at 3 m										
Frequency (MHz)	Emission Level (dBuV/m)	Read Level (dBuV)	Limit (dBuV/m)	Margin (dB)	Antenna Factor (dB/m)	Cable Loss (dB)	Preamp Factor (dB)	Antenna Height (cm)	Table Angle (Degree)	Remark
5126	42.8	34.58	54	-11.2	34.11	8.1	33.99	110	0	Average
5126	53.58	45.36	74	-20.42	34.11	8.1	33.99	110	0	Peak
5300	93.17	84.63			34.24	8.32	34.02	110	0	Average
5300	100.97	92.43			34.24	8.32	34.02	110	0	Peak
5403.68	43.03	34.31	54	-10.97	34.32	8.44	34.04	110	0	Average
5403.68	54.99	46.27	74	-19.01	34.32	8.44	34.04	110	0	Peak

Antenna Polarity & Test Distance: Vertical at 3 m										
Frequency (MHz)	Emission Level (dBuV/m)	Read Level (dBuV)	Limit (dBuV/m)	Margin (dB)	Antenna Factor (dB/m)	Cable Loss (dB)	Preamp Factor (dB)	Antenna Height (cm)	Table Angle (Degree)	Remark
5106.5	43.09	34.92	54	-10.91	34.09	8.07	33.99	123	13	Average
5106.5	53.56	45.39	74	-20.44	34.09	8.07	33.99	123	13	Peak
5300	95.52	86.98			34.24	8.32	34.02	123	13	Average
5300	103.72	95.18			34.24	8.32	34.02	123	13	Peak
5457.69	43.19	34.37	54	-10.81	34.36	8.51	34.05	123	13	Average
5457.69	53.68	44.86	74	-20.32	34.36	8.51	34.05	123	13	Peak

Remarks:

- Emission Level = Read Level + Antenna Factor + Cable Loss - Preamp Factor
Margin value = Emission level – Limit value
- 5300 MHz: Fundamental Frequency

EUT Test Condition		Measurement Detail	
Channel	Channel 64	Frequency Range	1 GHz ~ 40 GHz
Input Power	120 Vac, 60 Hz	Detector Function	Peak (PK) Average (AV)
Environmental Conditions	25 deg. C, 65 % RH	Tested By	Karl Lee

Antenna Polarity & Test Distance: Horizontal at 3 m										
Frequency (MHz)	Emission Level (dBuV/m)	Read Level (dBuV)	Limit (dBuV/m)	Margin (dB)	Antenna Factor (dB/m)	Cable Loss (dB)	Preamp Factor (dB)	Antenna Height (cm)	Table Angle (Degree)	Remark
5320	92.57	83.99			34.25	8.35	34.02	110	0	Average
5320	100.44	91.86			34.25	8.35	34.02	110	0	Peak
5447.68	43.57	34.74	54	-10.43	34.36	8.51	34.04	110	0	Average
5447.68	54.04	45.21	74	-19.96	34.36	8.51	34.04	110	0	Peak
10640	47.15	32.42	74	-26.85	37.31	12.71	35.29	137	212	Average
10640	56.42	41.69	74	-17.58	37.31	12.71	35.29	137	212	Peak

Antenna Polarity & Test Distance: Vertical at 3 m										
Frequency (MHz)	Emission Level (dBuV/m)	Read Level (dBuV)	Limit (dBuV/m)	Margin (dB)	Antenna Factor (dB/m)	Cable Loss (dB)	Preamp Factor (dB)	Antenna Height (cm)	Table Angle (Degree)	Remark
5320	96.33	87.75			34.25	8.35	34.02	123	13	Average
5320	103.58	95			34.25	8.35	34.02	123	13	Peak
5367.93	43.12	34.45	54	-10.88	34.29	8.41	34.03	123	13	Average
5367.93	54.36	45.69	74	-19.64	34.29	8.41	34.03	123	13	Peak
10640	47.24	32.51	74	-26.76	37.31	12.71	35.29	127	119	Average
10640	56.59	41.86	74	-17.41	37.31	12.71	35.29	127	119	Peak

Remarks:

- Emission Level = Read Level + Antenna Factor + Cable Loss - Preamp Factor
Margin value = Emission level – Limit value
- 5320 MHz: Fundamental Frequency

EUT Test Condition		Measurement Detail	
Channel	Channel 100	Frequency Range	1 GHz ~ 40 GHz
Input Power	120 Vac, 60 Hz	Detector Function	Peak (PK) Average (AV)
Environmental Conditions	25 deg. C, 65 % RH	Tested By	Charles Hsiao

Antenna Polarity & Test Distance: Horizontal at 3 m										
Frequency (MHz)	Emission Level (dBuV/m)	Read Level (dBuV)	Limit (dBuV/m)	Margin (dB)	Antenna Factor (dB/m)	Cable Loss (dB)	Preamp Factor (dB)	Antenna Height (cm)	Table Angle (Degree)	Remark
5457.52	43.57	34.75	54	-10.43	34.36	8.51	34.05	200	121	Average
5457.52	53.66	44.84	74	-20.34	34.36	8.51	34.05	200	121	Peak
*5470.48	53.26	44.43	68.2	-14.94	34.37	8.51	34.05	200	121	Peak
5500	95.63	86.71			34.4	8.57	34.05	200	121	Average
5500	102.05	93.13			34.4	8.57	34.05	200	121	Peak
11000	47.42	32.34	54	-6.58	37.6	12.96	35.48	162	327	Average
11000	56.6	41.52	74	-17.4	37.6	12.96	35.48	162	327	Peak
Antenna Polarity & Test Distance: Vertical at 3 m										
Frequency (MHz)	Emission Level (dBuV/m)	Read Level (dBuV)	Limit (dBuV/m)	Margin (dB)	Antenna Factor (dB/m)	Cable Loss (dB)	Preamp Factor (dB)	Antenna Height (cm)	Table Angle (Degree)	Remark
5410	43.46	34.74	54	-10.54	34.32	8.44	34.04	106	163	Average
5410	54.08	45.36	74	-19.92	34.32	8.44	34.04	106	163	Peak
*5470.96	52.98	44.12	68.2	-15.22	34.37	8.54	34.05	106	163	Peak
5500	93.33	84.41			34.4	8.57	34.05	106	163	Average
5500	100.73	91.81			34.4	8.57	34.05	106	163	Peak
11000	47.85	32.77	54	-6.15	37.6	12.96	35.48	154	128	Average
11000	56.93	41.85	74	-17.07	37.6	12.96	35.48	154	128	Peak

Remarks:

- Emission Level = Read Level + Antenna Factor + Cable Loss - Preamp Factor
Margin value = Emission level – Limit value
- 5500 MHz: Fundamental Frequency
- *: Out of Restricted Band

EUT Test Condition		Measurement Detail	
Channel	Channel 116	Frequency Range	1 GHz ~ 40 GHz
Input Power	120 Vac, 60 Hz	Detector Function	Peak (PK) Average (AV)
Environmental Conditions	25 deg. C, 65 % RH	Tested By	Charles Hsiao

Antenna Polarity & Test Distance: Horizontal at 3 m										
Frequency (MHz)	Emission Level (dBuV/m)	Read Level (dBuV)	Limit (dBuV/m)	Margin (dB)	Antenna Factor (dB/m)	Cable Loss (dB)	Preamp Factor (dB)	Antenna Height (cm)	Table Angle (Degree)	Remark
5447.12	43.05	34.22	54	-10.95	34.36	8.51	34.04	200	121	Average
5447.12	53.99	45.16	74	-20.01	34.36	8.51	34.04	200	121	Peak
*5468.08	52.85	44.02	68.2	-15.35	34.37	8.51	34.05	200	121	Peak
5580	95.36	86.37			34.47	8.6	34.08	200	121	Average
5580	102.89	93.9			34.47	8.6	34.08	200	121	Peak
*5725.24	53.38	44.22	68.2	-14.82	34.62	8.65	34.11	200	121	Peak
Antenna Polarity & Test Distance: Vertical at 3 m										
Frequency (MHz)	Emission Level (dBuV/m)	Read Level (dBuV)	Limit (dBuV/m)	Margin (dB)	Antenna Factor (dB/m)	Cable Loss (dB)	Preamp Factor (dB)	Antenna Height (cm)	Table Angle (Degree)	Remark
5458	43.06	34.24	54	-10.94	34.36	8.51	34.05	106	163	Average
5458	54.19	45.37	74	-19.81	34.36	8.51	34.05	106	163	Peak
*5469.84	53.72	44.89	68.2	-14.48	34.37	8.51	34.05	106	163	Peak
5580	93.42	84.43			34.47	8.6	34.08	106	163	Average
5580	100.51	91.52			34.47	8.6	34.08	106	163	Peak
*5724.44	53.31	44.15	68.2	-14.89	34.62	8.65	34.11	106	163	Peak

Remarks:

- Emission Level = Read Level + Antenna Factor + Cable Loss - Preamp Factor
Margin value = Emission level – Limit value
- 5580 MHz: Fundamental Frequency
- *: Out of Restricted Band

EUT Test Condition		Measurement Detail	
Channel	Channel 140	Frequency Range	1 GHz ~ 40 GHz
Input Power	120 Vac, 60 Hz	Detector Function	Peak (PK) Average (AV)
Environmental Conditions	25 deg. C, 65 % RH	Tested By	Charles Hsiao

Antenna Polarity & Test Distance: Horizontal at 3 m										
Frequency (MHz)	Emission Level (dBuV/m)	Read Level (dBuV)	Limit (dBuV/m)	Margin (dB)	Antenna Factor (dB/m)	Cable Loss (dB)	Preamp Factor (dB)	Antenna Height (cm)	Table Angle (Degree)	Remark
5700	95.19	86.06			34.59	8.64	34.1	200	121	Average
5700	102.2	93.07			34.59	8.64	34.1	200	121	Peak
*5724.12	54.68	45.52	68.2	-13.52	34.62	8.65	34.11	200	121	Peak
11400	48.27	33.17	54	-5.73	37.84	12.67	35.41	121	92	Average
11400	57.62	42.52	74	-16.38	37.84	12.67	35.41	121	92	Peak
Antenna Polarity & Test Distance: Vertical at 3 m										
Frequency (MHz)	Emission Level (dBuV/m)	Read Level (dBuV)	Limit (dBuV/m)	Margin (dB)	Antenna Factor (dB/m)	Cable Loss (dB)	Preamp Factor (dB)	Antenna Height (cm)	Table Angle (Degree)	Remark
5700	93.24	84.11			34.59	8.64	34.1	101	163	Average
5700	100.23	91.1			34.59	8.64	34.1	101	163	Peak
*5724.12	54.23	45.07	68.2	-13.97	34.62	8.65	34.11	101	163	Peak
11400	48.34	33.24	54	-5.66	37.84	12.67	35.41	185	146	Average
11400	57.24	42.14	74	-16.76	37.84	12.67	35.41	185	146	Peak

Remarks:

- Emission Level = Read Level + Antenna Factor + Cable Loss - Preamp Factor
Margin value = Emission level – Limit value
- 5700 MHz: Fundamental Frequency
- *: Out of Restricted Band

EUT Test Condition		Measurement Detail	
Channel	Channel 149	Frequency Range	1 GHz ~ 40 GHz
Input Power	120 Vac, 60 Hz	Detector Function	Peak (PK) Average (AV)
Environmental Conditions	25 deg. C, 65 % RH	Tested By	Karl Lee

<Spurious Emission>

Antenna Polarity & Test Distance: Horizontal at 3 m										
Frequency (MHz)	Emission Level (dBuV/m)	Read Level (dBuV)	Limit (dBuV/m)	Margin (dB)	Antenna Factor (dB/m)	Cable Loss (dB)	Preamp Factor (dB)	Antenna Height (cm)	Table Angle (Degree)	Remark
5745	93.64	84.45			34.64	8.66	34.11	183	112	Average
5745	100.6	91.41			34.64	8.66	34.11	183	112	Peak
11490	48.61	33.49	54	-5.39	37.89	12.62	35.39	137	166	Average
11490	57.79	42.67	74	-16.21	37.89	12.62	35.39	137	166	Peak
Antenna Polarity & Test Distance: Vertical at 3 m										
Frequency (MHz)	Emission Level (dBuV/m)	Read Level (dBuV)	Limit (dBuV/m)	Margin (dB)	Antenna Factor (dB/m)	Cable Loss (dB)	Preamp Factor (dB)	Antenna Height (cm)	Table Angle (Degree)	Remark
5745	97.26	88.07			34.64	8.66	34.11	127	327	Average
5745	104.09	94.9			34.64	8.66	34.11	127	327	Peak
11490	48.57	33.45	54	-5.43	37.89	12.62	35.39	126	342	Average
11490	57.85	42.73	74	-16.15	37.89	12.62	35.39	126	342	Peak

<Out of Band Emission (OOBE)>

Antenna Polarity & Test Distance: Horizontal at 3 m										
Frequency (MHz)	Emission Level (dBuV/m)	Read Level (dBuV)	Limit (dBuV/m)	Margin (dB)	Antenna Factor (dB/m)	Cable Loss (dB)	Preamp Factor (dB)	Antenna Height (cm)	Table Angle (Degree)	Remark
*5532.025	54.06	45.12	68.2	-14.14	34.43	8.58	34.07	183	112	Peak
*5651.725	52.3	43.21	69.48	-17.18	34.56	8.62	34.09	183	112	Peak
*5921.05	53.21	43.83	71.12	-17.91	34.81	8.73	34.16	183	112	Peak
*6020.275	55.19	45.68	68.2	-13.01	34.92	8.77	34.18	183	112	Peak
Antenna Polarity & Test Distance: Vertical at 3 m										
Frequency (MHz)	Emission Level (dBuV/m)	Read Level (dBuV)	Limit (dBuV/m)	Margin (dB)	Antenna Factor (dB/m)	Cable Loss (dB)	Preamp Factor (dB)	Antenna Height (cm)	Table Angle (Degree)	Remark
*5608.675	53.94	44.91	68.2	-14.26	34.5	8.61	34.08	127	327	Peak
*5652.25	52.6	43.51	69.86	-17.26	34.56	8.62	34.09	127	327	Peak
*5922.625	53.78	44.38	69.96	-16.18	34.83	8.73	34.16	127	327	Peak
*5975.65	55.71	46.25	68.2	-12.49	34.88	8.75	34.17	127	327	Peak

Remarks:

- Emission Level = Read Level + Antenna Factor + Cable Loss - Preamp Factor
Margin value = Emission level – Limit value
- 5745 MHz: Fundamental Frequency
- *: Out of Restricted Band

EUT Test Condition		Measurement Detail	
Channel	Channel 157	Frequency Range	1 GHz ~ 40 GHz
Input Power	120 Vac, 60 Hz	Detector Function	Peak (PK) Average (AV)
Environmental Conditions	25 deg. C, 65 % RH	Tested By	Karl Lee

<Spurious Emission>

Antenna Polarity & Test Distance: Horizontal at 3 m										
Frequency (MHz)	Emission Level (dBuV/m)	Read Level (dBuV)	Limit (dBuV/m)	Margin (dB)	Antenna Factor (dB/m)	Cable Loss (dB)	Preamp Factor (dB)	Antenna Height (cm)	Table Angle (Degree)	Remark
5785	92.81	83.58			34.68	8.68	34.13	183	112	Average
5785	100.69	91.46			34.68	8.68	34.13	183	112	Peak
11570	48.31	33	54	-5.69	38	12.68	35.37	176	264	Average
11570	57.32	42.01	74	-16.68	38	12.68	35.37	176	264	Peak
Antenna Polarity & Test Distance: Vertical at 3 m										
Frequency (MHz)	Emission Level (dBuV/m)	Read Level (dBuV)	Limit (dBuV/m)	Margin (dB)	Antenna Factor (dB/m)	Cable Loss (dB)	Preamp Factor (dB)	Antenna Height (cm)	Table Angle (Degree)	Remark
5785	95.92	86.69			34.68	8.68	34.13	127	327	Average
5785	103.48	94.25			34.68	8.68	34.13	127	327	Peak
11570	48.13	32.82	54	-5.87	38	12.68	35.37	162	304	Average
11570	57.24	41.93	74	-16.76	38	12.68	35.37	162	304	Peak

<Out of Band Emission (OOBE)>

Antenna Polarity & Test Distance: Horizontal at 3 m										
Frequency (MHz)	Emission Level (dBuV/m)	Read Level (dBuV)	Limit (dBuV/m)	Margin (dB)	Antenna Factor (dB/m)	Cable Loss (dB)	Preamp Factor (dB)	Antenna Height (cm)	Table Angle (Degree)	Remark
*5613.4	53.9	44.87	68.2	-14.3	34.5	8.61	34.08	183	112	Peak
*5651.725	52.69	43.6	69.48	-16.79	34.56	8.62	34.09	183	112	Peak
*5923.15	51.62	42.22	69.57	-17.95	34.83	8.73	34.16	183	112	Peak
*5970.925	54.87	45.42	68.2	-13.33	34.87	8.75	34.17	183	112	Peak
Antenna Polarity & Test Distance: Vertical at 3 m										
Frequency (MHz)	Emission Level (dBuV/m)	Read Level (dBuV)	Limit (dBuV/m)	Margin (dB)	Antenna Factor (dB/m)	Cable Loss (dB)	Preamp Factor (dB)	Antenna Height (cm)	Table Angle (Degree)	Remark
*5614.45	54.55	45.52	68.2	-13.65	34.5	8.61	34.08	127	327	Peak
*5651.725	53.98	44.89	69.48	-15.5	34.56	8.62	34.09	127	327	Peak
*5923.15	53.14	43.74	69.57	-16.43	34.83	8.73	34.16	127	327	Peak
*5977.225	55.51	46.05	68.2	-12.69	34.88	8.75	34.17	127	327	Peak

Remarks:

- Emission Level = Read Level + Antenna Factor + Cable Loss - Preamp Factor
Margin value = Emission level – Limit value
- 5785 MHz: Fundamental Frequency
- *: Out of Restricted Band

EUT Test Condition		Measurement Detail	
Channel	Channel 165	Frequency Range	1 GHz ~ 40 GHz
Input Power	120 Vac, 60 Hz	Detector Function	Peak (PK) Average (AV)
Environmental Conditions	25 deg. C, 65 % RH	Tested By	Karl Lee

<Spurious Emission>

Antenna Polarity & Test Distance: Horizontal at 3 m										
Frequency (MHz)	Emission Level (dBuV/m)	Read Level (dBuV)	Limit (dBuV/m)	Margin (dB)	Antenna Factor (dB/m)	Cable Loss (dB)	Preamp Factor (dB)	Antenna Height (cm)	Table Angle (Degree)	Remark
5825	94.06	84.77			34.73	8.69	34.13	183	112	Average
5825	100.68	91.39			34.73	8.69	34.13	183	112	Peak
11650	50.1	34.57	54	-3.9	38.09	12.8	35.36	143	126	Average
11650	59.55	44.02	74	-14.45	38.09	12.8	35.36	143	126	Peak
Antenna Polarity & Test Distance: Vertical at 3 m										
Frequency (MHz)	Emission Level (dBuV/m)	Read Level (dBuV)	Limit (dBuV/m)	Margin (dB)	Antenna Factor (dB/m)	Cable Loss (dB)	Preamp Factor (dB)	Antenna Height (cm)	Table Angle (Degree)	Remark
5825	96.54	87.25			34.73	8.69	34.13	127	327	Average
5825	103.83	94.54			34.73	8.69	34.13	127	327	Peak
11650	49.51	33.98	54	-4.49	38.09	12.8	35.36	177	116	Average
11650	58.64	43.11	74	-15.36	38.09	12.8	35.36	177	116	Peak

<Out of Band Emission (OOBE)>

Antenna Polarity & Test Distance: Horizontal at 3 m										
Frequency (MHz)	Emission Level (dBuV/m)	Read Level (dBuV)	Limit (dBuV/m)	Margin (dB)	Antenna Factor (dB/m)	Cable Loss (dB)	Preamp Factor (dB)	Antenna Height (cm)	Table Angle (Degree)	Remark
*5582.95	54.25	45.24	68.2	-13.95	34.49	8.6	34.08	183	112	Peak
*5651.2	52.65	43.56	69.09	-16.44	34.56	8.62	34.09	183	112	Peak
*5922.625	52.8	43.4	69.96	-17.16	34.83	8.73	34.16	183	112	Peak
*5985.625	54.59	45.13	68.2	-13.61	34.88	8.75	34.17	183	112	Peak
Antenna Polarity & Test Distance: Vertical at 3 m										
Frequency (MHz)	Emission Level (dBuV/m)	Read Level (dBuV)	Limit (dBuV/m)	Margin (dB)	Antenna Factor (dB/m)	Cable Loss (dB)	Preamp Factor (dB)	Antenna Height (cm)	Table Angle (Degree)	Remark
*5528.35	54.7	45.77	68.2	-13.5	34.42	8.58	34.07	127	327	Peak
*5651.725	51.9	42.81	69.48	-17.58	34.56	8.62	34.09	127	327	Peak
*5922.625	52.06	42.66	69.96	-17.9	34.83	8.73	34.16	127	327	Peak
*5942.575	55	45.57	68.2	-13.2	34.85	8.74	34.16	127	327	Peak

Remarks:

- Emission Level = Read Level + Antenna Factor + Cable Loss - Preamp Factor
Margin value = Emission level – Limit value
- 5825 MHz: Fundamental Frequency
- *: Out of Restricted Band

802.11n (HT40)

EUT Test Condition		Measurement Detail	
Channel	Channel 38	Frequency Range	1 GHz ~ 40 GHz
Input Power	120 Vac, 60 Hz	Detector Function	Peak (PK) Average (AV)
Environmental Conditions	25 deg. C, 65 % RH	Tested By	Karl Lee

Antenna Polarity & Test Distance: Horizontal at 3 m

Frequency (MHz)	Emission Level (dBuV/m)	Read Level (dBuV)	Limit (dBuV/m)	Margin (dB)	Antenna Factor (dB/m)	Cable Loss (dB)	Preamp Factor (dB)	Antenna Height (cm)	Table Angle (Degree)	Remark
5148.5	48.3	40.05	54	-5.7	34.12	8.13	34	183	2	Average
5148.5	57.99	49.74	74	-16.01	34.12	8.13	34	183	2	Peak
5190	91.41	83.07			34.15	8.19	34	183	2	Average
5190	99.12	90.78			34.15	8.19	34	183	2	Peak
5421.28	43.67	34.9	54	-10.33	34.33	8.48	34.04	183	2	Average
5421.28	54.02	45.25	74	-19.98	34.33	8.48	34.04	183	2	Peak

Antenna Polarity & Test Distance: Vertical at 3 m

Frequency (MHz)	Emission Level (dBuV/m)	Read Level (dBuV)	Limit (dBuV/m)	Margin (dB)	Antenna Factor (dB/m)	Cable Loss (dB)	Preamp Factor (dB)	Antenna Height (cm)	Table Angle (Degree)	Remark
5148.95	47.05	38.8	54	-6.95	34.12	8.13	34	178	20	Average
5148.95	56.36	48.11	74	-17.64	34.12	8.13	34	178	20	Peak
5190	90.46	82.12			34.15	8.19	34	178	20	Average
5190	98.3	89.96			34.15	8.19	34	178	20	Peak
5449.66	43.56	34.73	54	-10.44	34.36	8.51	34.04	178	20	Average
5449.66	53.94	45.11	74	-20.06	34.36	8.51	34.04	178	20	Peak

Remarks:

- Emission Level = Read Level + Antenna Factor + Cable Loss - Preamp Factor
Margin value = Emission level – Limit value
- 5190 MHz: Fundamental Frequency

EUT Test Condition		Measurement Detail	
Channel	Channel 46	Frequency Range	1 GHz ~ 40 GHz
Input Power	120 Vac, 60 Hz	Detector Function	Peak (PK) Average (AV)
Environmental Conditions	25 deg. C, 65 % RH	Tested By	Karl Lee

Antenna Polarity & Test Distance: Horizontal at 3 m										
Frequency (MHz)	Emission Level (dBuV/m)	Read Level (dBuV)	Limit (dBuV/m)	Margin (dB)	Antenna Factor (dB/m)	Cable Loss (dB)	Preamp Factor (dB)	Antenna Height (cm)	Table Angle (Degree)	Remark
5085.8	43.15	34.99	54	-10.85	34.07	8.07	33.98	117	20	Average
5085.8	54.55	46.39	74	-19.45	34.07	8.07	33.98	117	20	Peak
5230	91.22	82.82			34.19	8.22	34.01	117	20	Average
5230	99.52	91.12			34.19	8.22	34.01	117	20	Peak
5396.64	43.17	34.45	54	-10.83	34.32	8.44	34.04	117	20	Average
5396.64	53.52	44.8	74	-20.48	34.32	8.44	34.04	117	20	Peak

Antenna Polarity & Test Distance: Vertical at 3 m										
Frequency (MHz)	Emission Level (dBuV/m)	Read Level (dBuV)	Limit (dBuV/m)	Margin (dB)	Antenna Factor (dB/m)	Cable Loss (dB)	Preamp Factor (dB)	Antenna Height (cm)	Table Angle (Degree)	Remark
5074.1	43.01	34.89	54	-10.99	34.07	8.03	33.98	182	2	Average
5074.1	53.65	45.53	74	-20.35	34.07	8.03	33.98	182	2	Peak
5230	89.6	81.2			34.19	8.22	34.01	182	2	Average
5230	98.02	89.62			34.19	8.22	34.01	182	2	Peak
5455.82	43.16	34.34	54	-10.84	34.36	8.51	34.05	182	2	Average
5455.82	54.09	45.27	74	-19.91	34.36	8.51	34.05	182	2	Peak

Remarks:

- Emission Level = Read Level + Antenna Factor + Cable Loss - Preamp Factor
Margin value = Emission level – Limit value
- 5230 MHz: Fundamental Frequency

EUT Test Condition		Measurement Detail	
Channel	Channel 54	Frequency Range	1 GHz ~ 40 GHz
Input Power	120 Vac, 60 Hz	Detector Function	Peak (PK) Average (AV)
Environmental Conditions	25 deg. C, 65 % RH	Tested By	Karl Lee

Antenna Polarity & Test Distance: Horizontal at 3 m										
Frequency (MHz)	Emission Level (dBuV/m)	Read Level (dBuV)	Limit (dBuV/m)	Margin (dB)	Antenna Factor (dB/m)	Cable Loss (dB)	Preamp Factor (dB)	Antenna Height (cm)	Table Angle (Degree)	Remark
5105.3	43.41	35.25	54	-10.59	34.08	8.07	33.99	110	0	Average
5105.3	53.72	45.56	74	-20.28	34.08	8.07	33.99	110	0	Peak
5270	89.73	81.24			34.21	8.29	34.01	110	0	Average
5270	97.15	88.66			34.21	8.29	34.01	110	0	Peak
5446.69	43.62	34.79	54	-10.38	34.36	8.51	34.04	110	0	Average
5446.69	53.53	44.7	74	-20.47	34.36	8.51	34.04	110	0	Peak

Antenna Polarity & Test Distance: Vertical at 3 m										
Frequency (MHz)	Emission Level (dBuV/m)	Read Level (dBuV)	Limit (dBuV/m)	Margin (dB)	Antenna Factor (dB/m)	Cable Loss (dB)	Preamp Factor (dB)	Antenna Height (cm)	Table Angle (Degree)	Remark
5102.3	43.29	35.13	54	-10.71	34.08	8.07	33.99	127	13	Average
5102.3	53.52	45.36	74	-20.48	34.08	8.07	33.99	127	13	Peak
5270	91.96	83.47			34.21	8.29	34.01	127	13	Average
5270	100.49	92			34.21	8.29	34.01	127	13	Peak
5432.83	43.72	34.93	54	-10.28	34.35	8.48	34.04	127	13	Average
5432.83	53.76	44.97	74	-20.24	34.35	8.48	34.04	127	13	Peak

Remarks:

- Emission Level = Read Level + Antenna Factor + Cable Loss - Preamp Factor
Margin value = Emission level – Limit value
- 5270 MHz: Fundamental Frequency

EUT Test Condition		Measurement Detail	
Channel	Channel 62	Frequency Range	1 GHz ~ 40 GHz
Input Power	120 Vac, 60 Hz	Detector Function	Peak (PK) Average (AV)
Environmental Conditions	25 deg. C, 65 % RH	Tested By	Karl Lee

Antenna Polarity & Test Distance: Horizontal at 3 m										
Frequency (MHz)	Emission Level (dBuV/m)	Read Level (dBuV)	Limit (dBuV/m)	Margin (dB)	Antenna Factor (dB/m)	Cable Loss (dB)	Preamp Factor (dB)	Antenna Height (cm)	Table Angle (Degree)	Remark
5067.2	42.91	34.81	54	-11.09	34.05	8.03	33.98	110	0	Average
5067.2	53.61	45.51	74	-20.39	34.05	8.03	33.98	110	0	Peak
5310	89.87	81.32			34.25	8.32	34.02	110	0	Average
5310	97.32	88.77			34.25	8.32	34.02	110	0	Peak
5350.33	45.01	36.38	54	-8.99	34.28	8.38	34.03	110	0	Average
5350.33	55.13	46.5	74	-18.87	34.28	8.38	34.03	110	0	Peak

Antenna Polarity & Test Distance: Vertical at 3 m										
Frequency (MHz)	Emission Level (dBuV/m)	Read Level (dBuV)	Limit (dBuV/m)	Margin (dB)	Antenna Factor (dB/m)	Cable Loss (dB)	Preamp Factor (dB)	Antenna Height (cm)	Table Angle (Degree)	Remark
5149.85	42.89	34.64	54	-11.11	34.12	8.13	34	123	13	Average
5149.85	53.36	45.11	74	-20.64	34.12	8.13	34	123	13	Peak
5310	92.7	84.15			34.25	8.32	34.02	123	13	Average
5310	99.52	90.97			34.25	8.32	34.02	123	13	Peak
5350.66	46.06	37.43	54	-7.94	34.28	8.38	34.03	123	13	Average
5350.66	56.66	48.03	74	-17.34	34.28	8.38	34.03	123	13	Peak

Remarks:

- Emission Level = Read Level + Antenna Factor + Cable Loss - Preamp Factor
Margin value = Emission level – Limit value
- 5310 MHz: Fundamental Frequency

EUT Test Condition		Measurement Detail	
Channel	Channel 102	Frequency Range	1 GHz ~ 40 GHz
Input Power	120 Vac, 60 Hz	Detector Function	Peak (PK) Average (AV)
Environmental Conditions	25 deg. C, 65 % RH	Tested By	Charles Hsiao

Antenna Polarity & Test Distance: Horizontal at 3 m										
Frequency (MHz)	Emission Level (dBuV/m)	Read Level (dBuV)	Limit (dBuV/m)	Margin (dB)	Antenna Factor (dB/m)	Cable Loss (dB)	Preamp Factor (dB)	Antenna Height (cm)	Table Angle (Degree)	Remark
5460	45.15	36.33	54	-8.85	34.36	8.51	34.05	200	121	Average
5460	54.58	45.76	74	-19.42	34.36	8.51	34.05	200	121	Peak
*5470.64	56.98	48.15	68.2	-11.22	34.37	8.51	34.05	200	121	Peak
5510	92.41	83.5			34.4	8.57	34.06	200	121	Average
5510	99.4	90.49			34.4	8.57	34.06	200	121	Peak
*5725.88	52.75	43.59	68.2	-15.45	34.62	8.65	34.11	200	121	Peak

Antenna Polarity & Test Distance: Vertical at 3 m										
Frequency (MHz)	Emission Level (dBuV/m)	Read Level (dBuV)	Limit (dBuV/m)	Margin (dB)	Antenna Factor (dB/m)	Cable Loss (dB)	Preamp Factor (dB)	Antenna Height (cm)	Table Angle (Degree)	Remark
5460	44.64	35.82	54	-9.36	34.36	8.51	34.05	106	163	Average
5460	54.5	45.68	74	-19.5	34.36	8.51	34.05	106	163	Peak
*5470	56.71	47.88	68.2	-11.49	34.37	8.51	34.05	106	163	Peak
5510	90.55	81.64			34.4	8.57	34.06	106	163	Average
5510	97.57	88.66			34.4	8.57	34.06	106	163	Peak
*5725.56	52.68	43.52	68.2	-15.52	34.62	8.65	34.11	106	163	Peak

Remarks:

- Emission Level = Read Level + Antenna Factor + Cable Loss - Preamp Factor
Margin value = Emission level – Limit value
- 5510 MHz: Fundamental Frequency
- *: Out of Restricted Band

EUT Test Condition		Measurement Detail	
Channel	Channel 110	Frequency Range	1 GHz ~ 40 GHz
Input Power	120 Vac, 60 Hz	Detector Function	Peak (PK) Average (AV)
Environmental Conditions	25 deg. C, 65 % RH	Tested By	Charles Hsiao

Antenna Polarity & Test Distance: Horizontal at 3 m										
Frequency (MHz)	Emission Level (dBuV/m)	Read Level (dBuV)	Limit (dBuV/m)	Margin (dB)	Antenna Factor (dB/m)	Cable Loss (dB)	Preamp Factor (dB)	Antenna Height (cm)	Table Angle (Degree)	Remark
5454.8	43.74	34.92	54	-10.26	34.36	8.51	34.05	200	121	Average
5454.8	53.8	44.98	74	-20.2	34.36	8.51	34.05	200	121	Peak
*5470.96	52.13	43.27	68.2	-16.07	34.37	8.54	34.05	200	121	Peak
5550	92.43	83.46			34.45	8.59	34.07	200	121	Average
5550	99.57	90.6			34.45	8.59	34.07	200	121	Peak
*5724.6	52.79	43.63	68.2	-15.41	34.62	8.65	34.11	200	121	Peak

Antenna Polarity & Test Distance: Vertical at 3 m										
Frequency (MHz)	Emission Level (dBuV/m)	Read Level (dBuV)	Limit (dBuV/m)	Margin (dB)	Antenna Factor (dB/m)	Cable Loss (dB)	Preamp Factor (dB)	Antenna Height (cm)	Table Angle (Degree)	Remark
5455.6	43.58	34.76	54	-10.42	34.36	8.51	34.05	106	163	Average
5455.6	53.68	44.86	74	-20.32	34.36	8.51	34.05	106	163	Peak
*5470.48	53.56	44.73	68.2	-14.64	34.37	8.51	34.05	106	163	Peak
5550	90.27	81.3			34.45	8.59	34.07	106	163	Average
5550	97.53	88.56			34.45	8.59	34.07	106	163	Peak
*5725.88	53.57	44.41	68.2	-14.63	34.62	8.65	34.11	106	163	Peak

Remarks:

- Emission Level = Read Level + Antenna Factor + Cable Loss - Preamp Factor
Margin value = Emission level – Limit value
- 5550 MHz: Fundamental Frequency
- *: Out of Restricted Band

EUT Test Condition		Measurement Detail	
Channel	Channel 134	Frequency Range	1 GHz ~ 40 GHz
Input Power	120 Vac, 60 Hz	Detector Function	Peak (PK) Average (AV)
Environmental Conditions	25 deg. C, 65 % RH	Tested By	Charles Hsiao

Antenna Polarity & Test Distance: Horizontal at 3 m										
Frequency (MHz)	Emission Level (dBuV/m)	Read Level (dBuV)	Limit (dBuV/m)	Margin (dB)	Antenna Factor (dB/m)	Cable Loss (dB)	Preamp Factor (dB)	Antenna Height (cm)	Table Angle (Degree)	Remark
5451.6	43.43	34.61	54	-10.57	34.36	8.51	34.05	200	121	Average
5451.6	53.62	44.8	74	-20.38	34.36	8.51	34.05	200	121	Peak
*5468.08	54.26	45.43	68.2	-13.94	34.37	8.51	34.05	200	121	Peak
5670	92.33	83.23			34.57	8.63	34.1	200	121	Average
5670	99.78	90.68			34.57	8.63	34.1	200	121	Peak
*5725.48	54.12	44.96	68.2	-14.08	34.62	8.65	34.11	200	121	Peak
Antenna Polarity & Test Distance: Vertical at 3 m										
Frequency (MHz)	Emission Level (dBuV/m)	Read Level (dBuV)	Limit (dBuV/m)	Margin (dB)	Antenna Factor (dB/m)	Cable Loss (dB)	Preamp Factor (dB)	Antenna Height (cm)	Table Angle (Degree)	Remark
5453.68	43.58	34.76	54	-10.42	34.36	8.51	34.05	102	163	Average
5453.68	53.74	44.92	74	-20.26	34.36	8.51	34.05	102	163	Peak
*5469.84	52.06	43.23	68.2	-16.14	34.37	8.51	34.05	102	163	Peak
5670	90.33	81.23			34.57	8.63	34.1	102	163	Average
5670	97.27	88.17			34.57	8.63	34.1	102	163	Peak
*5724.12	53.18	44.02	68.2	-15.02	34.62	8.65	34.11	102	163	Peak

Remarks:

- Emission Level = Read Level + Antenna Factor + Cable Loss - Preamp Factor
Margin value = Emission level – Limit value
- 5670 MHz: Fundamental Frequency
- *: Out of Restricted Band

EUT Test Condition		Measurement Detail	
Channel	Channel 151	Frequency Range	1 GHz ~ 40 GHz
Input Power	120 Vac, 60 Hz	Detector Function	Peak (PK) Average (AV)
Environmental Conditions	25 deg. C, 65 % RH	Tested By	Karl Lee

<Spurious Emission>

Antenna Polarity & Test Distance: Horizontal at 3 m										
Frequency (MHz)	Emission Level (dBuV/m)	Read Level (dBuV)	Limit (dBuV/m)	Margin (dB)	Antenna Factor (dB/m)	Cable Loss (dB)	Preamp Factor (dB)	Antenna Height (cm)	Table Angle (Degree)	Remark
5755	91.62	82.41			34.66	8.66	34.11	183	112	Average
5755	99	89.79			34.66	8.66	34.11	183	112	Peak
11510	48.76	33.65	54	-5.24	37.9	12.6	35.39	162	304	Average
11510	58.07	42.96	74	-15.93	37.9	12.6	35.39	162	304	Peak

Antenna Polarity & Test Distance: Vertical at 3 m										
Frequency (MHz)	Emission Level (dBuV/m)	Read Level (dBuV)	Limit (dBuV/m)	Margin (dB)	Antenna Factor (dB/m)	Cable Loss (dB)	Preamp Factor (dB)	Antenna Height (cm)	Table Angle (Degree)	Remark
5755	94.66	85.45			34.66	8.66	34.11	127	327	Average
5755	102.3	93.09			34.66	8.66	34.11	127	327	Peak
11510	49.23	34.12	54	-4.77	37.9	12.6	35.39	151	73	Average
11510	58.14	43.03	74	-15.86	37.9	12.6	35.39	151	73	Peak

<Out of Band Emission (OOBE)>

Antenna Polarity & Test Distance: Horizontal at 3 m										
Frequency (MHz)	Emission Level (dBuV/m)	Read Level (dBuV)	Limit (dBuV/m)	Margin (dB)	Antenna Factor (dB/m)	Cable Loss (dB)	Preamp Factor (dB)	Antenna Height (cm)	Table Angle (Degree)	Remark
*5620.225	55.94	46.89	68.2	-12.26	34.52	8.61	34.08	183	112	Peak
*5652.25	52.71	43.62	69.86	-17.15	34.56	8.62	34.09	183	112	Peak
*5922.625	53.09	43.69	69.96	-16.87	34.83	8.73	34.16	183	112	Peak
*6008.725	56.08	46.57	68.2	-12.12	34.92	8.76	34.17	183	112	Peak

Antenna Polarity & Test Distance: Vertical at 3 m										
Frequency (MHz)	Emission Level (dBuV/m)	Read Level (dBuV)	Limit (dBuV/m)	Margin (dB)	Antenna Factor (dB/m)	Cable Loss (dB)	Preamp Factor (dB)	Antenna Height (cm)	Table Angle (Degree)	Remark
*5524.15	55.51	46.57	68.2	-12.69	34.42	8.58	34.06	127	327	Peak
*5651.2	53.78	44.69	69.09	-15.31	34.56	8.62	34.09	127	327	Peak
*5923.675	52.8	43.4	69.18	-16.38	34.83	8.73	34.16	127	327	Peak
*6002.425	56.61	47.12	68.2	-11.59	34.9	8.76	34.17	127	327	Peak

Remarks:

- Emission Level = Read Level + Antenna Factor + Cable Loss - Preamp Factor
Margin value = Emission level – Limit value
- 5755 MHz: Fundamental Frequency
- *: Out of Restricted Band

EUT Test Condition		Measurement Detail	
Channel	Channel 159	Frequency Range	1 GHz ~ 40 GHz
Input Power	120 Vac, 60 Hz	Detector Function	Peak (PK) Average (AV)
Environmental Conditions	25 deg. C, 65 % RH	Tested By	Karl Lee

<Spurious Emission>

Antenna Polarity & Test Distance: Horizontal at 3 m										
Frequency (MHz)	Emission Level (dBuV/m)	Read Level (dBuV)	Limit (dBuV/m)	Margin (dB)	Antenna Factor (dB/m)	Cable Loss (dB)	Preamp Factor (dB)	Antenna Height (cm)	Table Angle (Degree)	Remark
5795	91.95	82.71			34.69	8.68	34.13	183	112	Average
5795	99.01	89.77			34.69	8.68	34.13	183	112	Peak
11590	49.86	34.49	54	-4.14	38.02	12.72	35.37	106	253	Average
11590	58.42	43.05	74	-15.58	38.02	12.72	35.37	106	253	Peak
Antenna Polarity & Test Distance: Vertical at 3 m										
Frequency (MHz)	Emission Level (dBuV/m)	Read Level (dBuV)	Limit (dBuV/m)	Margin (dB)	Antenna Factor (dB/m)	Cable Loss (dB)	Preamp Factor (dB)	Antenna Height (cm)	Table Angle (Degree)	Remark
5795	95.03	85.79			34.69	8.68	34.13	127	327	Average
5795	102.8	93.56			34.69	8.68	34.13	127	327	Peak
11590	48.22	32.85	54	-5.78	38.02	12.72	35.37	183	124	Average
11590	57.38	42.01	74	-16.62	38.02	12.72	35.37	183	124	Peak

<Out of Band Emission (OOBE)>

Antenna Polarity & Test Distance: Horizontal at 3 m										
Frequency (MHz)	Emission Level (dBuV/m)	Read Level (dBuV)	Limit (dBuV/m)	Margin (dB)	Antenna Factor (dB/m)	Cable Loss (dB)	Preamp Factor (dB)	Antenna Height (cm)	Table Angle (Degree)	Remark
*5642.8	54.78	45.71	68.2	-13.42	34.54	8.62	34.09	183	112	Peak
*5652.25	53.2	44.11	69.86	-16.66	34.56	8.62	34.09	183	112	Peak
*5922.625	53.27	43.87	69.96	-16.69	34.83	8.73	34.16	183	112	Peak
*6023.425	55.33	45.82	68.2	-12.87	34.92	8.77	34.18	183	112	Peak
Antenna Polarity & Test Distance: Vertical at 3 m										
Frequency (MHz)	Emission Level (dBuV/m)	Read Level (dBuV)	Limit (dBuV/m)	Margin (dB)	Antenna Factor (dB/m)	Cable Loss (dB)	Preamp Factor (dB)	Antenna Height (cm)	Table Angle (Degree)	Remark
*5593.45	55.5	46.49	68.2	-12.7	34.49	8.6	34.08	127	327	Peak
*5652.25	53.33	44.24	69.86	-16.53	34.56	8.62	34.09	127	327	Peak
*5923.15	53.89	44.49	69.57	-15.68	34.83	8.73	34.16	127	327	Peak
*5955.7	55.22	45.77	68.2	-12.98	34.87	8.74	34.16	127	327	Peak

Remarks:

- Emission Level = Read Level + Antenna Factor + Cable Loss - Preamp Factor
Margin value = Emission level – Limit value
- 5795 MHz: Fundamental Frequency
- *: Out of Restricted Band

802.11ac (VHT80)

EUT Test Condition		Measurement Detail	
Channel	Channel 42	Frequency Range	1 GHz ~ 40 GHz
Input Power	120 Vac, 60 Hz	Detector Function	Peak (PK) Average (AV)
Environmental Conditions	25 deg. C, 65 % RH	Tested By	Karl Lee

Antenna Polarity & Test Distance: Horizontal at 3 m

Frequency (MHz)	Emission Level (dBuV/m)	Read Level (dBuV)	Limit (dBuV/m)	Margin (dB)	Antenna Factor (dB/m)	Cable Loss (dB)	Preamp Factor (dB)	Antenna Height (cm)	Table Angle (Degree)	Remark
5149.1	45.45	37.2	54	-8.55	34.12	8.13	34	118	20	Average
5149.1	56.65	48.4	74	-17.35	34.12	8.13	34	118	20	Peak
5210	88.94	80.58			34.17	8.19	34	118	20	Average
5210	96.24	87.88			34.17	8.19	34	118	20	Peak
5458.46	43.09	34.27	54	-10.91	34.36	8.51	34.05	118	20	Average
5458.46	55.79	46.97	74	-18.21	34.36	8.51	34.05	118	20	Peak

Antenna Polarity & Test Distance: Vertical at 3 m

Frequency (MHz)	Emission Level (dBuV/m)	Read Level (dBuV)	Limit (dBuV/m)	Margin (dB)	Antenna Factor (dB/m)	Cable Loss (dB)	Preamp Factor (dB)	Antenna Height (cm)	Table Angle (Degree)	Remark
5150	44.99	36.74	54	-9.01	34.12	8.13	34	182	2	Average
5150	55.43	47.18	74	-18.57	34.12	8.13	34	182	2	Peak
5210	87.67	79.31			34.17	8.19	34	182	2	Average
5210	95.37	87.01			34.17	8.19	34	182	2	Peak
5441.41	43.15	34.36	54	-10.85	34.35	8.48	34.04	182	2	Average
5441.41	53.67	44.88	74	-20.33	34.35	8.48	34.04	182	2	Peak

Remarks:

- Emission Level = Read Level + Antenna Factor + Cable Loss - Preamp Factor
Margin value = Emission level – Limit value
- 5210 MHz: Fundamental Frequency

EUT Test Condition		Measurement Detail	
Channel	Channel 58	Frequency Range	1 GHz ~ 40 GHz
Input Power	120 Vac, 60 Hz	Detector Function	Peak (PK) Average (AV)
Environmental Conditions	25 deg. C, 65 % RH	Tested By	Karl Lee

Antenna Polarity & Test Distance: Horizontal at 3 m										
Frequency (MHz)	Emission Level (dBuV/m)	Read Level (dBuV)	Limit (dBuV/m)	Margin (dB)	Antenna Factor (dB/m)	Cable Loss (dB)	Preamp Factor (dB)	Antenna Height (cm)	Table Angle (Degree)	Remark
5101.25	43.67	35.51	54	-10.33	34.08	8.07	33.99	110	0	Average
5101.25	53.66	45.5	74	-20.34	34.08	8.07	33.99	110	0	Peak
5290	84.92	76.39	54	30.92	34.23	8.32	34.02	110	0	Average
5290	93.31	84.78			34.23	8.32	34.02	110	0	Peak
5394.99	44.71	35.99			34.32	8.44	34.04	110	0	Average
5394.99	54.02	45.3	74	-19.98	34.32	8.44	34.04	110	0	Peak

Antenna Polarity & Test Distance: Vertical at 3 m										
Frequency (MHz)	Emission Level (dBuV/m)	Read Level (dBuV)	Limit (dBuV/m)	Margin (dB)	Antenna Factor (dB/m)	Cable Loss (dB)	Preamp Factor (dB)	Antenna Height (cm)	Table Angle (Degree)	Remark
5106.8	43.73	35.56	54	-10.27	34.09	8.07	33.99	162	13	Average
5106.8	53.36	45.19	74	-20.64	34.09	8.07	33.99	162	13	Peak
5290	88.14	79.61			34.23	8.32	34.02	162	13	Average
5290	95.48	86.95			34.23	8.32	34.02	162	13	Peak
5437.45	44.42	35.63	54	-9.58	34.35	8.48	34.04	162	13	Average
5437.45	54.23	45.44	74	-19.77	34.35	8.48	34.04	162	13	Peak

Remarks:

- Emission Level = Read Level + Antenna Factor + Cable Loss - Preamp Factor
Margin value = Emission level – Limit value
- 5290 MHz: Fundamental Frequency

EUT Test Condition		Measurement Detail	
Channel	Channel 106	Frequency Range	1 GHz ~ 40 GHz
Input Power	120 Vac, 60 Hz	Detector Function	Peak (PK) Average (AV)
Environmental Conditions	25 deg. C, 65 % RH	Tested By	Charles Hsiao

Antenna Polarity & Test Distance: Horizontal at 3 m										
Frequency (MHz)	Emission Level (dBuV/m)	Read Level (dBuV)	Limit (dBuV/m)	Margin (dB)	Antenna Factor (dB/m)	Cable Loss (dB)	Preamp Factor (dB)	Antenna Height (cm)	Table Angle (Degree)	Remark
5456.4	45.38	36.56	54	-8.62	34.36	8.51	34.05	200	121	Average
5456.4	55.78	46.96	74	-18.22	34.36	8.51	34.05	200	121	Peak
*5469.52	54.94	46.11	68.2	-13.26	34.37	8.51	34.05	200	121	Peak
5530	89.39	80.46			34.42	8.58	34.07	200	121	Average
5530	95.5	86.57			34.42	8.58	34.07	200	121	Peak
*5725.4	54.07	44.91	68.2	-14.13	34.62	8.65	34.11	200	121	Peak

Antenna Polarity & Test Distance: Vertical at 3 m										
Frequency (MHz)	Emission Level (dBuV/m)	Read Level (dBuV)	Limit (dBuV/m)	Margin (dB)	Antenna Factor (dB/m)	Cable Loss (dB)	Preamp Factor (dB)	Antenna Height (cm)	Table Angle (Degree)	Remark
5458.8	45.46	36.64	54	-8.54	34.36	8.51	34.05	106	163	Average
5458.8	55.08	46.26	74	-18.92	34.36	8.51	34.05	106	163	Peak
*5468.08	56.01	47.18	68.2	-12.19	34.37	8.51	34.05	106	163	Peak
5530	87.46	78.53			34.42	8.58	34.07	106	163	Average
5530	93.43	84.5			34.42	8.58	34.07	106	163	Peak
*5726.04	54.42	45.26	68.2	-13.78	34.62	8.65	34.11	106	163	Peak

Remarks:

- Emission Level = Read Level + Antenna Factor + Cable Loss - Preamp Factor
Margin value = Emission level – Limit value
- 5530 MHz: Fundamental Frequency
- *: Out of Restricted Band

EUT Test Condition		Measurement Detail	
Channel	Channel 122	Frequency Range	1 GHz ~ 40 GHz
Input Power	120 Vac, 60 Hz	Detector Function	Peak (PK) Average (AV)
Environmental Conditions	25 deg. C, 65 % RH	Tested By	Charles Hsiao

Antenna Polarity & Test Distance: Horizontal at 3 m										
Frequency (MHz)	Emission Level (dBuV/m)	Read Level (dBuV)	Limit (dBuV/m)	Margin (dB)	Antenna Factor (dB/m)	Cable Loss (dB)	Preamp Factor (dB)	Antenna Height (cm)	Table Angle (Degree)	Remark
5449.2	43.87	35.04	54	-10.13	34.36	8.51	34.04	200	121	Average
5449.2	53.01	44.18	74	-20.99	34.36	8.51	34.04	200	121	Peak
*5468.72	53.09	44.26	68.2	-15.11	34.37	8.51	34.05	200	121	Peak
5610	89.33	80.3			34.5	8.61	34.08	200	121	Average
5610	95.64	86.61			34.5	8.61	34.08	200	121	Peak
*5724.76	53.16	44	68.2	-15.04	34.62	8.65	34.11	200	121	Peak

Antenna Polarity & Test Distance: Vertical at 3 m										
Frequency (MHz)	Emission Level (dBuV/m)	Read Level (dBuV)	Limit (dBuV/m)	Margin (dB)	Antenna Factor (dB/m)	Cable Loss (dB)	Preamp Factor (dB)	Antenna Height (cm)	Table Angle (Degree)	Remark
5445.68	43.75	34.92	54	-10.25	34.36	8.51	34.04	102	163	Average
5445.68	54.88	46.05	74	-19.12	34.36	8.51	34.04	102	163	Peak
*5470.32	52.25	43.42	68.2	-15.95	34.37	8.51	34.05	102	163	Peak
5610	87.41	78.38			34.5	8.61	34.08	102	163	Average
5610	93.06	84.03			34.5	8.61	34.08	102	163	Peak
*5724.28	53.19	44.03	68.2	-15.01	34.62	8.65	34.11	102	163	Peak

Remarks:

- Emission Level = Read Level + Antenna Factor + Cable Loss - Preamp Factor
Margin value = Emission level – Limit value
- 5610 MHz: Fundamental Frequency
- *: Out of Restricted Band

EUT Test Condition		Measurement Detail	
Channel	Channel 155	Frequency Range	1 GHz ~ 40 GHz
Input Power	120 Vac, 60 Hz	Detector Function	Peak (PK) Average (AV)
Environmental Conditions	25 deg. C, 65 % RH	Tested By	Karl Lee

<Spurious Emission>

Antenna Polarity & Test Distance: Horizontal at 3 m										
Frequency (MHz)	Emission Level (dBuV/m)	Read Level (dBuV)	Limit (dBuV/m)	Margin (dB)	Antenna Factor (dB/m)	Cable Loss (dB)	Preamp Factor (dB)	Antenna Height (cm)	Table Angle (Degree)	Remark
5775	87.33	78.1			34.68	8.67	34.12	183	112	Average
5775	94.9	85.67			34.68	8.67	34.12	183	112	Peak
11550	49.31	34.04	54	-4.69	37.97	12.68	35.38	134	125	Average
11550	58.03	42.76	74	-15.97	37.97	12.68	35.38	134	125	Peak
Antenna Polarity & Test Distance: Vertical at 3 m										
Frequency (MHz)	Emission Level (dBuV/m)	Read Level (dBuV)	Limit (dBuV/m)	Margin (dB)	Antenna Factor (dB/m)	Cable Loss (dB)	Preamp Factor (dB)	Antenna Height (cm)	Table Angle (Degree)	Remark
5775	89.53	80.3			34.68	8.67	34.12	147	324	Average
5775	97.35	88.12			34.68	8.67	34.12	147	324	Peak
11550	49.28	34.01	54	-4.72	37.97	12.68	35.38	134	161	Average
11550	58.73	43.46	74	-15.27	37.97	12.68	35.38	134	161	Peak

<Out of Band Emission (OOBE)>

Antenna Polarity & Test Distance: Horizontal at 3 m										
Frequency (MHz)	Emission Level (dBuV/m)	Read Level (dBuV)	Limit (dBuV/m)	Margin (dB)	Antenna Factor (dB/m)	Cable Loss (dB)	Preamp Factor (dB)	Antenna Height (cm)	Table Angle (Degree)	Remark
*5644.9	55.34	46.27	68.2	-12.86	34.54	8.62	34.09	183	112	Peak
*5652.25	53.81	44.72	69.86	-16.05	34.56	8.62	34.09	183	112	Peak
*5922.625	55.32	45.92	69.96	-14.64	34.83	8.73	34.16	183	112	Peak
*5932.075	55.46	46.06	68.2	-12.74	34.83	8.73	34.16	183	112	Peak
Antenna Polarity & Test Distance: Vertical at 3 m										
Frequency (MHz)	Emission Level (dBuV/m)	Read Level (dBuV)	Limit (dBuV/m)	Margin (dB)	Antenna Factor (dB/m)	Cable Loss (dB)	Preamp Factor (dB)	Antenna Height (cm)	Table Angle (Degree)	Remark
*5630.2	54.91	45.86	68.2	-13.29	34.52	8.62	34.09	147	324	Peak
*5652.25	52.74	43.65	69.86	-17.12	34.56	8.62	34.09	147	324	Peak
*5923.675	54	44.6	69.18	-15.18	34.83	8.73	34.16	147	324	Peak
*5929.975	55.95	46.55	68.2	-12.25	34.83	8.73	34.16	147	324	Peak

Remarks:

- Emission Level = Read Level + Antenna Factor + Cable Loss - Preamp Factor
Margin value = Emission level – Limit value
- 5775 MHz: Fundamental Frequency
- *: Out of Restricted Band

9 kHz ~ 30 MHz DATA:

The amplitude of spurious emissions attenuated more than 20 dB below the permissible value is not required to be report.

30 MHz ~ 1 GHz WORST-CASE DATA:

802.11n (HT40)

EUT Test Condition		Measurement Detail	
Channel	Channel 38	Frequency Range	30 MHz ~ 1 GHz
Input Power	120 Vac, 60 Hz	Detector Function	Peak (PK) Quasi-peak (QP)
Environmental Conditions	25 deg. C, 65 % RH	Tested By	Karl Lee

Antenna Polarity & Test Distance: Horizontal at 3 m										
Frequency (MHz)	Emission Level (dBuV/m)	Read Level (dBuV)	Limit (dBuV/m)	Margin (dB)	Antenna Factor (dB/m)	Cable Loss (dB)	Preamp Factor (dB)	Antenna Height (cm)	Table Angle (Degree)	Remark
79.14	27.28	50.12	40	-12.72	8.26	1.11	32.21	145	116	Peak
169.32	19.41	41.04	43.5	-24.09	9.09	1.52	32.24	185	127	Peak
246.81	14.65	32.66	46	-31.35	12.25	1.85	32.11	105	183	Peak
402.2	18.45	33.31	46	-27.55	15.02	2.34	32.22	136	127	Peak
579.3	19.36	31.12	46	-26.64	17.62	2.82	32.2	195	124	Peak
786.5	21.91	30.52	46	-24.09	20.2	3.27	32.08	180	254	Peak
Antenna Polarity & Test Distance: Vertical at 3 m										
Frequency (MHz)	Emission Level (dBuV/m)	Read Level (dBuV)	Limit (dBuV/m)	Margin (dB)	Antenna Factor (dB/m)	Cable Loss (dB)	Preamp Factor (dB)	Antenna Height (cm)	Table Angle (Degree)	Remark
69.42	21.67	42.63	40	-18.33	10.15	1.11	32.22	138	105	Peak
155.01	9.56	31.75	43.5	-33.94	8.56	1.52	32.27	199	165	Peak
207.93	11.59	31.07	43.5	-31.91	11.14	1.65	32.27	171	154	Peak
435.8	16.43	30.74	46	-29.57	15.37	2.49	32.17	150	181	Peak
571.6	18.01	29.9	46	-27.99	17.49	2.82	32.2	163	15	Peak
768.3	22.43	31.32	46	-23.57	20	3.22	32.11	185	137	Peak

Remarks:

1. Emission Level = Read Level + Antenna Factor + Cable Loss - Preamp Factor

Margin value = Emission level – Limit value

802.11n (HT40)

EUT Test Condition		Measurement Detail	
Channel	Channel 62	Frequency Range	30 MHz ~ 1 GHz
Input Power	120 Vac, 60 Hz	Detector Function	Peak (PK) Quasi-peak (QP)
Environmental Conditions	25 deg. C, 65 % RH	Tested By	Karl Lee

Antenna Polarity & Test Distance: Horizontal at 3 m

Frequency (MHz)	Emission Level (dBuV/m)	Read Level (dBuV)	Limit (dBuV/m)	Margin (dB)	Antenna Factor (dB/m)	Cable Loss (dB)	Preamp Factor (dB)	Antenna Height (cm)	Table Angle (Degree)	Remark
96.42	30.84	49.85	43.5	-12.66	11.75	1.28	32.04	175	138	Peak
161.22	16.55	38.52	43.5	-26.95	8.78	1.52	32.27	190	124	Peak
209.82	17.99	37.45	43.5	-25.51	11.15	1.65	32.26	112	165	Peak
405.7	17.43	32.25	46	-28.57	15.06	2.34	32.22	133	157	Peak
645.8	19.4	30.18	46	-26.6	18.38	2.99	32.15	190	123	Peak
839.7	23.46	31.04	46	-22.54	20.89	3.38	31.85	154	127	Peak

Antenna Polarity & Test Distance: Vertical at 3 m

Frequency (MHz)	Emission Level (dBuV/m)	Read Level (dBuV)	Limit (dBuV/m)	Margin (dB)	Antenna Factor (dB/m)	Cable Loss (dB)	Preamp Factor (dB)	Antenna Height (cm)	Table Angle (Degree)	Remark
41.88	31.66	49.36	40	-8.34	13.78	0.74	32.22	124	165	Peak
85.62	24.63	46.29	40	-15.37	9.19	1.11	31.96	171	42	Peak
215.76	11.97	31.28	43.5	-31.53	11.27	1.65	32.23	164	128	Peak
405.7	16.35	31.17	46	-29.65	15.06	2.34	32.22	128	164	Peak
701.1	21.11	30.84	46	-24.89	19.25	3.11	32.09	137	152	Peak
851.6	23.24	30.54	46	-22.76	21.04	3.44	31.78	165	128	Peak

Remarks:

- Emission Level = Read Level + Antenna Factor + Cable Loss - Preamp Factor
Margin value = Emission level – Limit value

802.11a

EUT Test Condition		Measurement Detail	
Channel	Channel 100	Frequency Range	30 MHz ~ 1 GHz
Input Power	120 Vac, 60 Hz	Detector Function	Peak (PK) Quasi-peak (QP)
Environmental Conditions	25 deg. C, 65 % RH	Tested By	Karl Lee

Antenna Polarity & Test Distance: Horizontal at 3 m										
Frequency (MHz)	Emission Level (dBuV/m)	Read Level (dBuV)	Limit (dBuV/m)	Margin (dB)	Antenna Factor (dB/m)	Cable Loss (dB)	Preamp Factor (dB)	Antenna Height (cm)	Table Angle (Degree)	Remark
80.76	27.47	50.35	40	-12.53	8.22	1.11	32.21	149	135	Peak
170.67	21.3	42.87	43.5	-22.2	9.15	1.52	32.24	166	120	Peak
234.39	16.11	34.5	46	-29.89	11.92	1.85	32.16	197	128	Peak
473.6	17.41	31.02	46	-28.59	15.95	2.56	32.12	142	127	Peak
753.6	22.25	31.32	46	-23.75	19.85	3.22	32.14	163	182	Peak
894.3	24.73	31.34	46	-21.27	21.42	3.49	31.52	190	115	Peak

Antenna Polarity & Test Distance: Vertical at 3 m										
Frequency (MHz)	Emission Level (dBuV/m)	Read Level (dBuV)	Limit (dBuV/m)	Margin (dB)	Antenna Factor (dB/m)	Cable Loss (dB)	Preamp Factor (dB)	Antenna Height (cm)	Table Angle (Degree)	Remark
67.26	23.6	43.61	40	-16.4	11.31	0.9	32.22	190	116	Peak
163.38	15.07	36.92	43.5	-28.43	8.89	1.52	32.26	143	176	Peak
221.7	14.05	33.19	46	-31.95	11.42	1.65	32.21	154	102	Peak
454.7	16.34	30.35	46	-29.66	15.64	2.49	32.14	115	127	Peak
614.3	19.36	30.6	46	-26.64	18.07	2.87	32.18	100	118	Peak
782.3	22.01	30.67	46	-23.99	20.16	3.27	32.09	162	135	Peak

Remarks:

- Emission Level = Read Level + Antenna Factor + Cable Loss - Preamp Factor
Margin value = Emission level – Limit value

802.11n (HT40)

EUT Test Condition		Measurement Detail	
Channel	Channel 159	Frequency Range	30 MHz ~ 1 GHz
Input Power	120 Vac, 60 Hz	Detector Function	Peak (PK) Quasi-peak (QP)
Environmental Conditions	25 deg. C, 65 % RH	Tested By	Karl Lee

Antenna Polarity & Test Distance: Horizontal at 3 m

Frequency (MHz)	Emission Level (dBuV/m)	Read Level (dBuV)	Limit (dBuV/m)	Margin (dB)	Antenna Factor (dB/m)	Cable Loss (dB)	Preamp Factor (dB)	Antenna Height (cm)	Table Angle (Degree)	Remark
35.13	16.47	35.88	40	-23.53	12.09	0.74	32.24	134	155	Peak
155.01	15.14	37.33	43.5	-28.36	8.56	1.52	32.27	176	226	Peak
231.96	17.29	35.79	46	-28.71	11.82	1.85	32.17	195	131	Peak
414.8	18.28	32.9	46	-27.72	15.17	2.41	32.2	131	254	Peak
627.6	19.22	30.27	46	-26.78	18.19	2.93	32.17	195	108	Peak
827.1	22.52	30.31	46	-23.48	20.74	3.38	31.91	176	125	Peak

Antenna Polarity & Test Distance: Vertical at 3 m

Frequency (MHz)	Emission Level (dBuV/m)	Read Level (dBuV)	Limit (dBuV/m)	Margin (dB)	Antenna Factor (dB/m)	Cable Loss (dB)	Preamp Factor (dB)	Antenna Height (cm)	Table Angle (Degree)	Remark
79.41	23.33	46.17	40	-16.67	8.26	1.11	32.21	163	132	Peak
148.53	8.16	30.52	43.5	-35.34	8.39	1.52	32.27	197	126	Peak
206.58	11.71	31.2	43.5	-31.79	11.13	1.65	32.27	154	205	Peak
396.6	16.72	31.67	46	-29.28	14.93	2.34	32.22	142	161	Peak
595.4	19.22	30.68	46	-26.78	17.86	2.87	32.19	190	133	Peak
748.7	21.64	30.76	46	-24.36	19.8	3.22	32.14	175	264	Peak

Remarks:

- Emission Level = Read Level + Antenna Factor + Cable Loss - Preamp Factor
Margin value = Emission level – Limit value

4.2 Conducted Emission Measurement

4.2.1 Limits of Conducted Emission Measurement

Frequency (MHz)	Conducted Limit (dBuV)	
	Quasi-peak	Average
0.15 - 0.5	66 - 56	56 - 46
0.50 - 5.0	56	46
5.0 - 30.0	60	50

Note: 1. The lower limit shall apply at the transition frequencies.

2. The limit decreases in line with the logarithm of the frequency in the range of 0.15 to 0.50 MHz.

4.2.2 Test Instruments

Description & Manufacturer	Model No.	Serial No.	Date Of Calibration	Due Date Of Calibration
Test Receiver ROHDE & SCHWARZ	ESCI	100613	Nov. 21, 2016	Nov. 20, 2017
RF signal cable (with 10dB PAD) Woken	5D-FB	Cable-cond1-01	Dec. 22, 2016	Dec. 21, 2017
LISN ROHDE & SCHWARZ (EUT)	ESH3-Z5	835239/001	Mar. 10, 2017	Mar. 09, 2018
LISN ROHDE & SCHWARZ (Peripheral)	ENV216	101196	Apr. 20, 2017	Apr. 19, 2018
Software ADT	BV ADT_Cond_ V7.3.7.3	NA	NA	NA

- Note:**
1. The calibration interval of the above test instruments is 12 months and the calibrations are traceable to NML/ROC and NIST/USA.
 2. The test was performed in HwaYa Shielded Room 1.
 3. The VCCI Site Registration No. is C-2040.

4.2.3 Test Procedures

- a. The EUT was placed 0.4 meters from the conducting wall of the shielded room with EUT being connected to the power mains through a line impedance stabilization network (LISN). Other support units were connected to the power mains through another LISN. The two LISNs provide 50 ohm/ 50uH of coupling impedance for the measuring instrument.
- b. Both lines of the power mains connected to the EUT were checked for maximum conducted interference.
- c. The frequency range from 150 kHz to 30 MHz was searched. Emission levels under (Limit -20 dB) was not recorded.

Note: All modes of operation were investigated and the worst-case emissions are reported.

4.2.4 Deviation from Test Standard

No deviation.

4.2.5 Test Setup

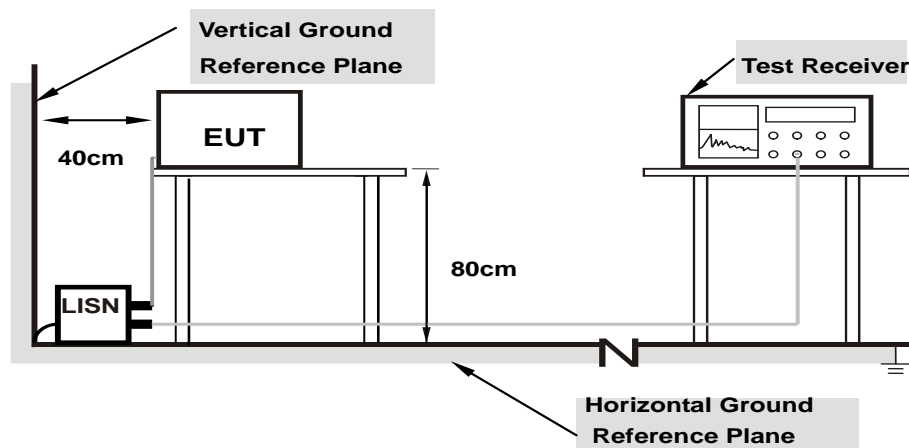

- Note:**
1. Support units were connected to second LISN.
 2. Both of LISNs (AMN) are 80 cm from EUT and at least 80 from other units and other metal planes

For the actual test configuration, please refer to the attached file (Test Setup Photo).

4.2.6 EUT Operating Conditions

- a. Placed the EUT on a testing table.
- b. Use the software to control the EUT under transmission condition continuously at specific channel frequency.

4.2.7 Test Results

Frequency Range	150kHz ~ 30MHz	Detector Function & Resolution Bandwidth	Quasi-Peak (QP) / Average (AV), 9kHz
Input Power	120Vac, 60Hz	Environmental Conditions	25°C, 65%RH
Tested by	Getaz Yang	Test Date	2017/7/29

Phase Of Power : Line (L)										
No	Frequency (MHz)	Correction Factor (dB)	Reading Value (dBuV)		Emission Level (dBuV)		Limit (dBuV)		Margin (dB)	
			Q.P.	AV.	Q.P.	AV.	Q.P.	AV.	Q.P.	AV.
1	0.15782	10.35	34.09	20.90	44.44	31.25	65.58	55.58	-21.14	-24.33
2	0.21256	10.37	28.91	16.77	39.28	27.14	63.10	53.10	-23.82	-25.96
3	0.53709	10.40	20.11	14.71	30.51	25.11	56.00	46.00	-25.49	-20.89
4	12.99826	10.98	20.37	18.04	31.35	29.02	60.00	50.00	-28.65	-20.98
5	15.88775	11.13	24.92	23.99	36.05	35.12	60.00	50.00	-23.95	-14.88
6	20.22394	11.37	24.87	19.81	36.24	31.18	60.00	50.00	-23.76	-18.82

Remarks:

1. Q.P. and AV. are abbreviations of quasi-peak and average individually.
2. The emission levels of other frequencies were very low against the limit.
3. Margin value = Emission level – Limit value
4. Correction factor = Insertion loss + Cable loss
5. Emission Level = Correction Factor + Reading Value

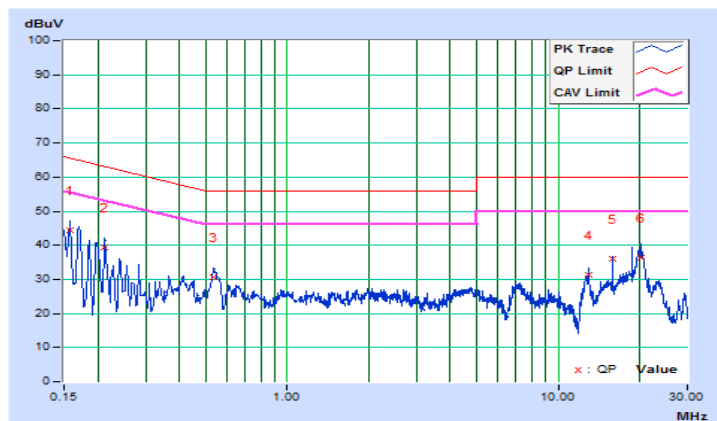

Frequency Range	150kHz ~ 30MHz	Detector Function & Resolution Bandwidth	Quasi-Peak (QP) / Average (AV), 9kHz
Input Power	120Vac, 60Hz	Environmental Conditions	25°C, 65%RH
Tested by	Getaz Yang	Test Date	2017/7/29

Phase Of Power : Neutral (N)										
No	Frequency (MHz)	Correction Factor (dB)	Reading Value (dBuV)		Emission Level (dBuV)		Limit (dBuV)		Margin (dB)	
			Q.P.	AV.	Q.P.	AV.	Q.P.	AV.	Q.P.	AV.
1	0.16173	10.11	34.11	21.23	44.22	31.34	65.37	55.37	-21.15	-24.03
2	0.20458	10.14	28.44	16.04	38.58	26.18	63.42	53.42	-24.84	-27.24
3	0.56866	10.16	22.08	16.87	32.24	27.03	56.00	46.00	-23.76	-18.97
4	0.72477	10.17	7.38	3.10	17.55	13.27	56.00	46.00	-38.45	-32.73
5	15.88775	10.79	24.28	24.07	35.07	34.86	60.00	50.00	-24.93	-15.14
6	18.78115	10.92	26.10	24.76	37.02	35.68	60.00	50.00	-22.98	-14.32

Remarks:

1. Q.P. and AV. are abbreviations of quasi-peak and average individually.
2. The emission levels of other frequencies were very low against the limit.
3. Margin value = Emission level – Limit value
4. Correction factor = Insertion loss + Cable loss
5. Emission Level = Correction Factor + Reading Value

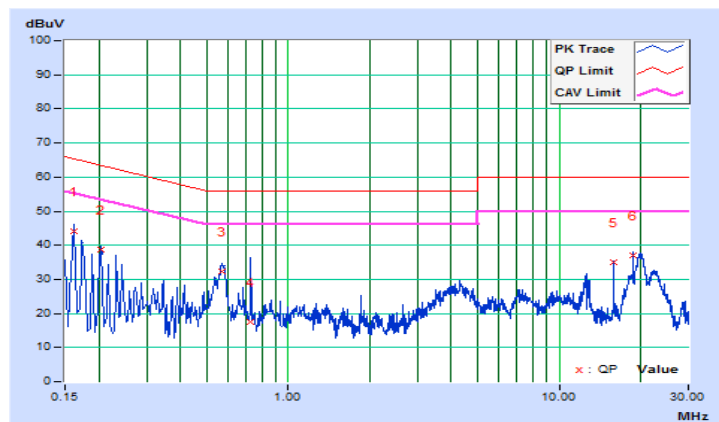

4.3 Transmit Power Measurement

4.3.1 Limits of Transmit Power Measurement

Operation Band	EUT Category	Limit
U-NII-1	Outdoor Access Point	1 Watt (30 dBm) (Max. e.i.r.p \leq 125 mW (21 dBm) at any elevation angle above 30 degrees as measured from the horizon)
	Fixed point-to-point Access Point	1 Watt (30 dBm)
	Indoor Access Point	1 Watt (30 dBm)
	√ Mobile and Portable client device	250 mW (24 dBm)
U-NII-2A	√	250 mW (24 dBm) or 11 dBm+10 log B*
U-NII-2C	√	250 mW (24 dBm) or 11 dBm+10 log B*
U-NII-3	√	1 Watt (30 dBm)

*B is the 26 dB emission bandwidth in megahertz

4.3.2 Test Setup

<Power Output Measurement>

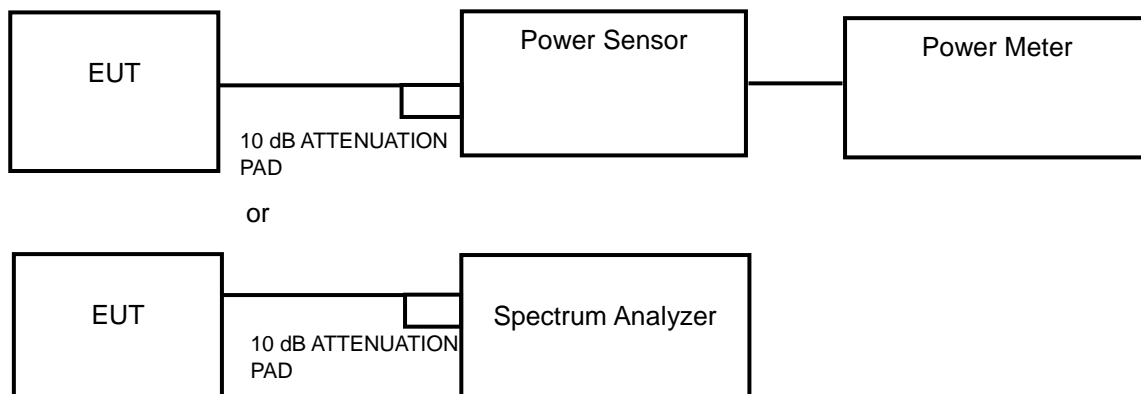

<26 dB Bandwidth>

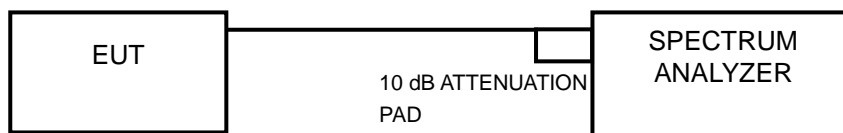

4.3.3 Test Instruments

Refer to section 4.1.2 to get information of above instrument.

4.3.4 Test Procedure

Average Power Measurement

<802.11a, 802.11n (HT20), 802.11n (HT40)>

Method PM is used to perform output power measurement, trigger and gating function of wide band power meter is enabled to measure max output power of TX on burst. Duty factor is not added to measured value.

<802.11ac (VHT80)>

Method SA-1 is used to perform output power measurement, trigger and gating function of spectrum analyzer is enabled to measure max output power of TX on burst. Duty factor is not added to measured value.

26 dB Bandwidth

- 1) Set RBW = approximately 1 % of the emission bandwidth.
- 2) Set the VBW > RBW.
- 3) Detector = Peak.
- 4) Trace mode = max hold.
- 5) Measure the maximum width of the emission that is 26 dB down from the peak of the emission. Compare this with the RBW setting of the analyzer. Readjust RBW and repeat measurement as needed until the RBW/EBW ratio is approximately 1 %.

4.3.5 Deviation from Test Standard

No deviation.

4.3.6 EUT Operating Conditions

The software provided by client to enable the EUT under transmission condition continuously at lowest, middle and highest channel frequencies individually.

4.3.7 Test Result

Power Output:

802.11a

Channel	Frequency (MHz)	Maximum Conducted Power (mW)	Maximum Conducted Power (dBm)	Power Limit (dBm)	Pass / Fail
36	5180	31.333	14.96	24	Pass
44	5220	31.261	14.95	24	Pass
48	5240	30.339	14.82	24	Pass
52	5260	31.117	14.93	24	Pass
60	5300	29.242	14.66	24	Pass
64	5320	28.054	14.48	24	Pass
100	5500	37.844	15.78	24	Pass
116	5580	36.813	15.66	24	Pass
140	5700	32.285	15.09	24	Pass
149	5745	31.55	14.99	30	Pass
157	5785	31.261	14.95	30	Pass
165	5825	31.046	14.92	30	Pass

Note:

For U-NII-2A, U-NII-2C Band:

1. $11 \text{ dBm} + 10\log(21.41) = 24.31\text{dBm} > 24 \text{ dBm}$.
2. $11 \text{ dBm} + 10\log(21.47) = 24.32\text{dBm} > 24 \text{ dBm}$.
3. $11 \text{ dBm} + 10\log(21.49) = 24.32\text{dBm} > 24 \text{ dBm}$.
4. $11 \text{ dBm} + 10\log(21.50) = 24.32\text{dBm} > 24 \text{ dBm}$.
5. $11 \text{ dBm} + 10\log(21.55) = 24.33\text{dBm} > 24 \text{ dBm}$.
6. $11 \text{ dBm} + 10\log(21.63) = 24.35\text{dBm} > 24 \text{ dBm}$.

802.11n (HT20)

Channel	Frequency (MHz)	Maximum Conducted Power (mW)	Maximum Conducted Power (dBm)	Power Limit (dBm)	Pass / Fail
36	5180	19.099	12.81	24	Pass
44	5220	17.989	12.55	24	Pass
48	5240	17.906	12.53	24	Pass
52	5260	17.539	12.44	24	Pass
60	5300	16.827	12.26	24	Pass
64	5320	18.072	12.57	24	Pass
100	5500	19.011	12.79	24	Pass
116	5580	17.338	12.39	24	Pass
140	5700	16.144	12.08	24	Pass
149	5745	14.555	11.63	30	Pass
157	5785	13.677	11.36	30	Pass
165	5825	13.996	11.46	30	Pass

Note:

For U-NII-2A, U-NII-2C Band:

1. $11 \text{ dBm} + 10\log(21.95) = 24.41\text{dBm} > 24 \text{ dBm}$.
2. $11 \text{ dBm} + 10\log(21.73) = 24.37\text{dBm} > 24 \text{ dBm}$.
3. $11 \text{ dBm} + 10\log(21.87) = 24.40\text{dBm} > 24 \text{ dBm}$.
4. $11 \text{ dBm} + 10\log(21.91) = 24.41\text{dBm} > 24 \text{ dBm}$.
5. $11 \text{ dBm} + 10\log(21.99) = 24.42\text{dBm} > 24 \text{ dBm}$.
6. $11 \text{ dBm} + 10\log(21.85) = 24.39\text{dBm} > 24 \text{ dBm}$.

802.11n (HT40)

Channel	Frequency (MHz)	Maximum Conducted Power (mW)	Maximum Conducted Power (dBm)	Power Limit (dBm)	Pass / Fail
38	5190	18.45	12.66	24	Pass
46	5230	18.072	12.57	24	Pass
54	5270	17.418	12.41	24	Pass
62	5310	18.155	12.59	24	Pass
102	5510	18.155	12.59	24	Pass
110	5550	17.579	12.45	24	Pass
134	5670	16.181	12.09	24	Pass
151	5755	16.331	12.13	30	Pass
159	5795	15.101	11.79	30	Pass

Note:

For U-NII-2A, U-NII-2C Band:

1. $11 \text{ dBm} + 10\log (41.34) = 27.16\text{dBm} > 24 \text{ dBm}$.
2. $11 \text{ dBm} + 10\log (41.45) = 27.18\text{dBm} > 24 \text{ dBm}$.
3. $11 \text{ dBm} + 10\log (41.30) = 27.16\text{dBm} > 24 \text{ dBm}$.
4. $11 \text{ dBm} + 10\log (41.33) = 27.16\text{dBm} > 24 \text{ dBm}$.
5. $11 \text{ dBm} + 10\log (41.23) = 27.15\text{dBm} > 24 \text{ dBm}$.

802.11ac (VHT80)

Channel	Frequency (MHz)	Maximum Conducted Power (mW)	Maximum Conducted Power (dBm)	Power Limit (dBm)	Pass / Fail
42	5210	8.222	9.15	24	Pass
58	5290	9.247	9.66	24	Pass
106	5530	12.023	10.80	24	Pass
122	5610	9.863	9.94	24	Pass
155	5775	7.852	8.95	30	Pass

Note:

For U-NII-2A, U-NII-2C Band:

1. $11 \text{ dBm} + 10\log (81.90) = 30.13\text{dBm} > 24 \text{ dBm}$.
2. $11 \text{ dBm} + 10\log (81.97) = 30.14\text{dBm} > 24 \text{ dBm}$.
3. $11 \text{ dBm} + 10\log (81.94) = 30.13\text{dBm} > 24 \text{ dBm}$.

26 dB Bandwidth:
802.11a

Channel	Frequency (MHz)	26 dBc Bandwidth (MHz)
36	5180	21.42
44	5220	21.45
48	5240	21.61
52	5260	21.41
60	5300	21.47
64	5320	21.49
100	5500	21.50
116	5580	21.55
140	5700	21.63

802.11n (HT20)

Channel	Frequency (MHz)	26 dBc Bandwidth (MHz)
36	5180	21.73
44	5220	21.88
48	5240	21.97
52	5260	21.95
60	5300	21.73
64	5320	21.87
100	5500	21.91
116	5580	21.99
140	5700	21.85

802.11n (HT40)

Channel	Frequency (MHz)	26 dBc Bandwidth (MHz)
38	5190	41.27
46	5230	41.41
54	5270	41.34
62	5310	41.45
102	5510	41.30
110	5550	41.33
134	5670	41.23

802.11ac (VHT80)

Channel	Frequency (MHz)	26 dBc Bandwidth (MHz)
42	5210	81.85
58	5290	81.90
106	5530	81.97
122	5610	81.94

Spectrum Plot of Worst Value

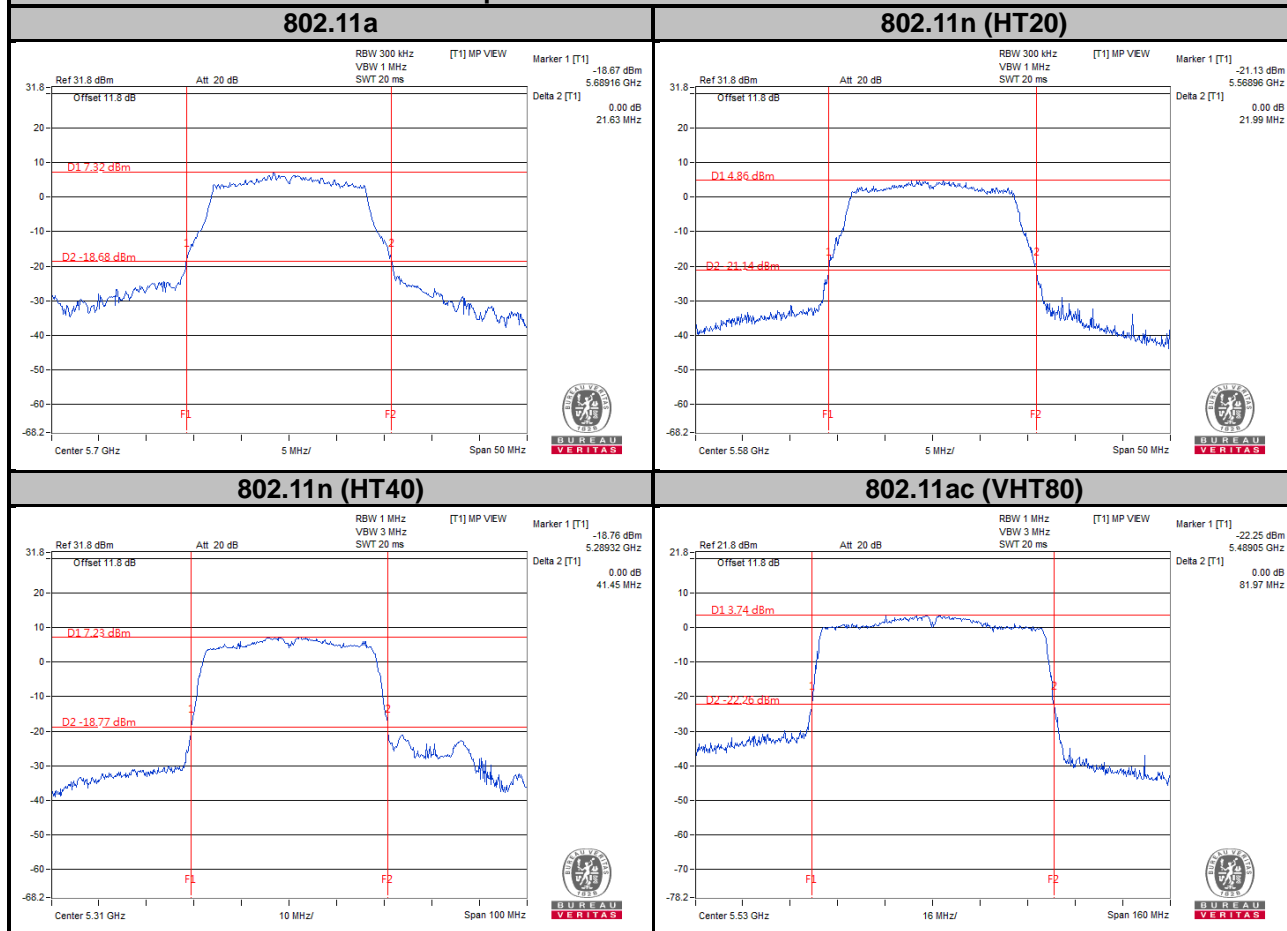

4.4 Peak Power Spectral Density Measurement

4.4.1 Limits of Peak Power Spectral Density Measurement

Operation Band	EUT Category		Limit
U-NII-1		Outdoor Access Point	17 dBm/MHz
		Fixed point-to-point Access Point	
		Indoor Access Point	
	√	Mobile and Portable client device	11 dBm/MHz
U-NII-2A		√	11 dBm/MHz
U-NII-2C		√	11 dBm/MHz
U-NII-3		√	30 dBm/500 kHz

4.4.2 Test Setup

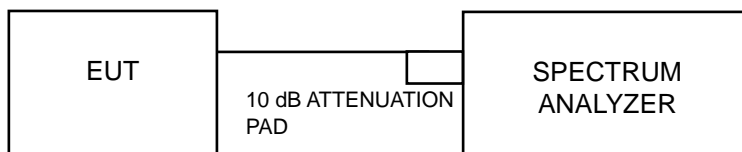

4.4.3 Test Instruments

Refer to section 4.1.3 to get information of above instrument.

4.4.4 Test Procedures

For U-NII-1, U-NII-2A, U-NII-2C band:

Using method SA-2

1. Set span to encompass the entire emission bandwidth (EBW) of the signal.
2. Set RBW = 1 MHz, Set VBW \geq 3 RBW, Detector = RMS
3. Sweep time = auto, trigger set to "free run".
4. Trace average at least 100 traces in power averaging mode.
5. Record the max value and add 10 log (1/duty cycle)

※For U-NII-3 band:

1. Set span to encompass the entire emission bandwidth (EBW) of the signal.
2. Set RBW = 500 kHz, Set VBW \geq 3 RBW, Detector = RMS
3. Use the peak marker function to determine the maximum power level in any 500 kHz band segment within the fundamental EBW.
4. Sweep time = auto, trigger set to "free run".
5. Trace average at least 100 traces in power averaging mode.
6. Record the max value and add 10 log (1/duty cycle)

4.4.5 Deviation from Test Standard

No deviation.

4.4.6 EUT Operating Conditions

The software provided by client to enable the EUT under transmission condition continuously at lowest, middle and highest channel frequencies individually.

4.4.7 Test Results

802.11a

Channel	Frequency (MHz)	PSD w/o Duty Factor (dBm/MHz)	Duty Factor (dB)	PSD with Duty Factor (dBm/MHz)	Maximum Limit (dBm/MHz)	Pass / Fail
36	5180	3.07	0.33	3.40	11	Pass
44	5220	3.00	0.33	3.33	11	Pass
48	5240	3.14	0.33	3.47	11	Pass
52	5260	2.99	0.33	3.32	11	Pass
60	5300	2.68	0.33	3.01	11	Pass
64	5320	2.52	0.33	2.85	11	Pass
100	5500	3.83	0.33	4.16	11	Pass
116	5580	3.51	0.33	3.84	11	Pass
140	5700	3.27	0.33	3.60	11	Pass

Note: Refer to section 3.3 for duty cycle spectrum plot.

802.11n (HT20)

Channel	Frequency (MHz)	PSD w/o Duty Factor (dBm/MHz)	Duty Factor (dB)	PSD with Duty Factor (dBm/MHz)	Maximum Limit (dBm/MHz)	Pass / Fail
36	5180	0.46	0.33	0.79	11	Pass
44	5220	0.40	0.33	0.73	11	Pass
48	5240	0.11	0.33	0.44	11	Pass
52	5260	0.19	0.33	0.52	11	Pass
60	5300	0.02	0.33	0.35	11	Pass
64	5320	0.11	0.33	0.44	11	Pass
100	5500	0.39	0.33	0.72	11	Pass
116	5580	0.00	0.33	0.33	11	Pass
140	5700	-0.40	0.33	-0.07	11	Pass

Note: Refer to section 3.3 for duty cycle spectrum plot.

802.11n (HT40)

Channel	Frequency (MHz)	PSD w/o Duty Factor (dBm/MHz)	Duty Factor (dB)	PSD with Duty Factor (dBm/MHz)	Maximum Limit (dBm/MHz)	Pass / Fail
38	5190	-2.60	0.63	-1.97	11	Pass
46	5230	-2.76	0.63	-2.12	11	Pass
54	5270	-2.72	0.63	-2.08	11	Pass
62	5310	-2.36	0.63	-1.73	11	Pass
102	5510	-2.56	0.63	-1.93	11	Pass
110	5550	-2.87	0.63	-2.24	11	Pass
134	5670	-3.29	0.63	-2.66	11	Pass

Note: Refer to section 3.3 for duty cycle spectrum plot.

802.11ac (VHT80)

Channel	Frequency (MHz)	PSD w/o Duty Factor (dBm/MHz)	Duty Factor (dB)	PSD with Duty Factor (dBm/MHz)	Maximum Limit (dBm/MHz)	Pass / Fail
42	5210	-9.01	1.30	-7.71	11	Pass
58	5290	-8.40	1.30	-7.11	11	Pass
106	5530	-7.54	1.30	-6.24	11	Pass
122	5610	-8.36	1.30	-7.06	11	Pass

Note: Refer to section 3.3 for duty cycle spectrum plot.

Spectrum Plot of Worst Value

802.11a

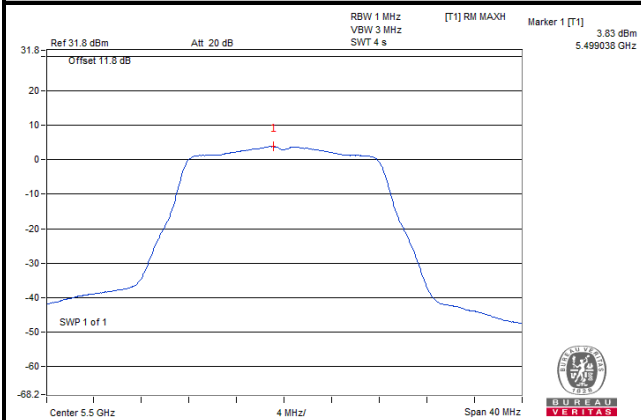

802.11n (HT20)

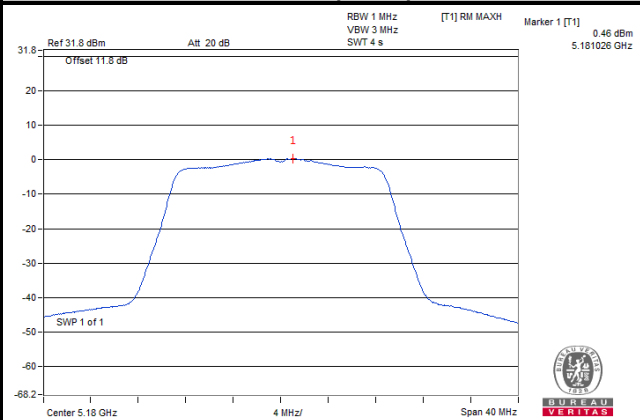

802.11n (HT40)

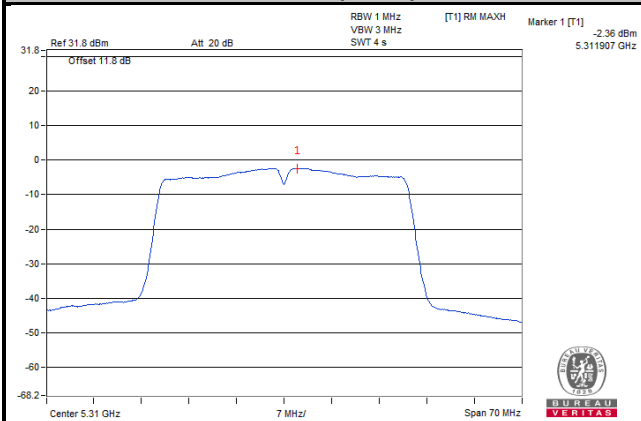

802.11ac (VHT80)

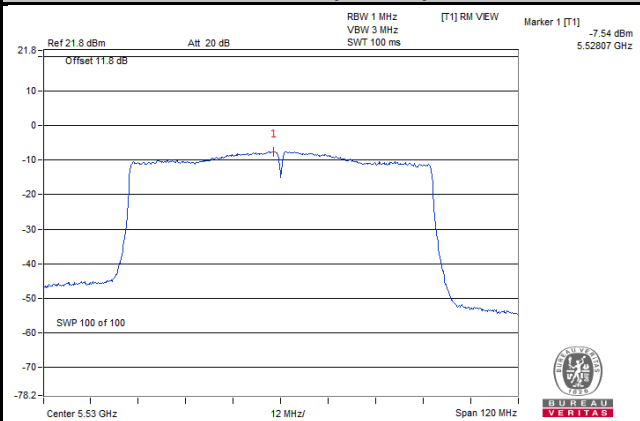

For U-NII-3 Band

802.11a

Channel	Frequency (MHz)	PSD w/o Duty Factor (dBm/500 kHz)	Duty Factor (dB)	PSD with Duty Factor (dBm/500 kHz)	Limit (dBm/500 kHz)	Pass / Fail
149	5745	0.19	0.33	0.52	30	Pass
157	5785	0.18	0.33	0.51	30	Pass
165	5825	0.00	0.33	0.33	30	Pass

Note: Refer to section 3.3 for duty cycle spectrum plot.

802.11n (HT20)

Channel	Frequency (MHz)	PSD w/o Duty Factor (dBm/500 kHz)	Duty Factor (dB)	PSD with Duty Factor (dBm/500 kHz)	Limit (dBm/500 kHz)	Pass / Fail
149	5745	-3.37	0.33	-3.04	30	Pass
157	5785	-3.52	0.33	-3.19	30	Pass
165	5825	-3.50	0.33	-3.17	30	Pass

Note: Refer to section 3.3 for duty cycle spectrum plot.

802.11n (HT40)

Channel	Frequency (MHz)	PSD w/o Duty Factor (dBm/500 kHz)	Duty Factor (dB)	PSD with Duty Factor (dBm/500 kHz)	Limit (dBm/500 kHz)	Pass / Fail
151	5755	-6.49	0.63	-5.86	30	Pass
159	5795	-6.63	0.63	-6.00	30	Pass

Note: Refer to section 3.3 for duty cycle spectrum plot.

802.11ac (VHT80)

Channel	Frequency (MHz)	PSD w/o Duty Factor (dBm/500 kHz)	Duty Factor (dB)	PSD with Duty Factor (dBm/500 kHz)	Limit (dBm/500 kHz)	Pass / Fail
155	5775	-11.62	1.30	-10.32	30	Pass

Note: Refer to section 3.3 for duty cycle spectrum plot.

Spectrum Plot of Worst Value

802.11a

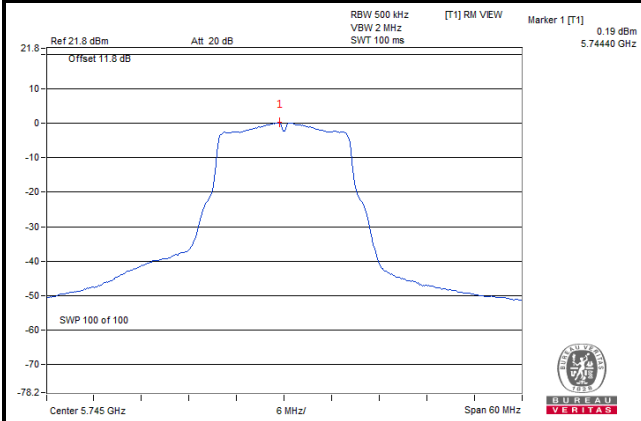

802.11n (HT20)

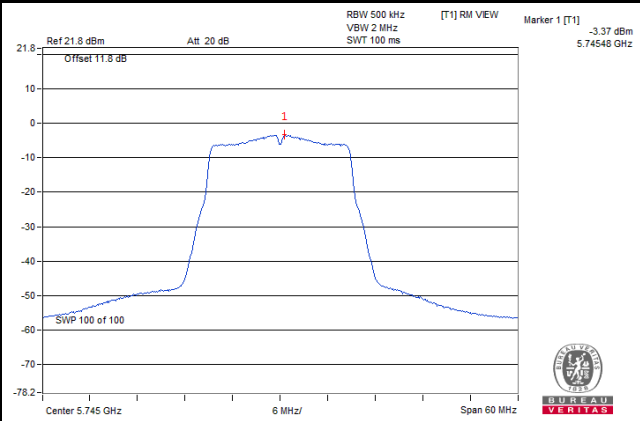

802.11n (HT40)

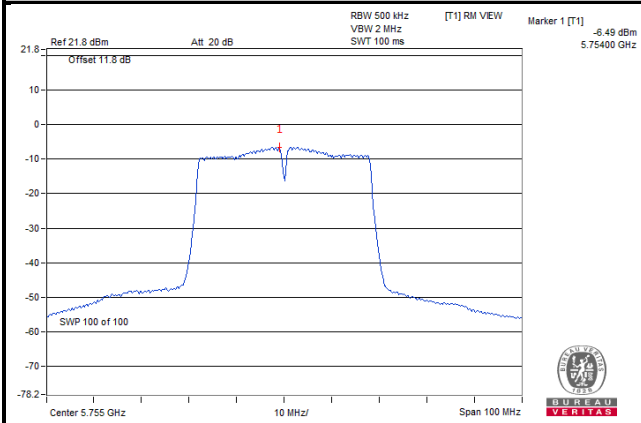

802.11ac (VHT80)

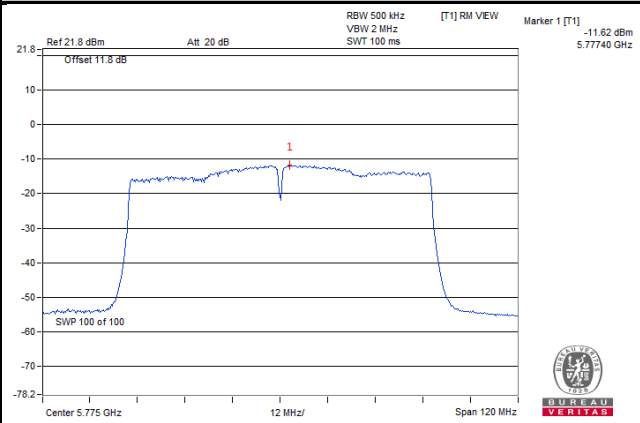

4.5 Frequency Stability

4.5.1 Limit of Frequency Stability Measurement

The frequency of the carrier signal shall be maintained within band of operation.

4.5.2 Test Setup

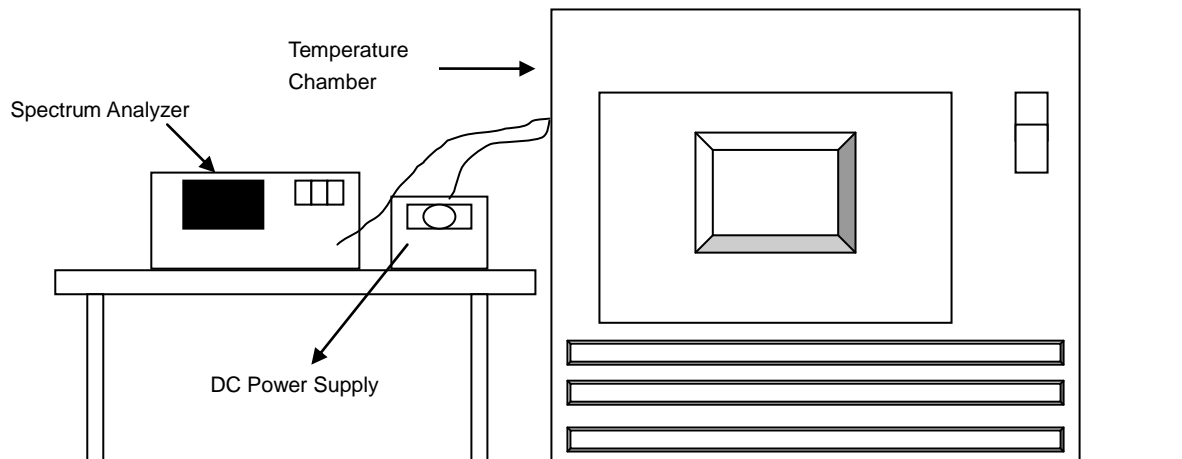

4.5.3 Test Instruments

Refer to section 4.1.3 to get information of above instrument.

4.5.4 Test Procedure

- To ensure emission at the band edge is maintained within the authorized band, those values shall be measured by radiation emissions at upper and lower frequency points, and finally compensated by frequency deviation as procedures below.
- The EUT was operated at the maximum output power, and connected to the spectrum analyzer, which is set to maximum hold function and peak detector. The peak value of the power envelope was measured and noted. The upper and lower frequency points were respectively measured relatively 10 dB lower than the measured peak value.
- The frequency deviation was calculated by adding the upper frequency point and the lower frequency point divided by two. Those detailed values of frequency deviation are provided in table below.

4.5.5 Deviation from Test Standard

No deviation.

4.5.6 EUT Operating Condition

Set the EUT transmit at un-modulation mode to test frequency stability.

4.5.7 Test Results

Frequency Stability Versus Temp.									
Operating Frequency: 5320 MHz									
Temp. (°C)	Power Supply (Vdc)	0 Minute		2 Minute		5 Minute		10 Minute	
		Measured Frequency (MHz)	Frequency Drift (ppm)	Measured Frequency (MHz)	Frequency Drift (ppm)	Measured Frequency (MHz)	Frequency Drift (ppm)	Measured Frequency (MHz)	Frequency Drift (ppm)
50	3.74	5179.9833	-0.00032	5179.9835	-0.00032	5179.9822	-0.00034	5179.9818	-0.00035
40	3.74	5179.9794	-0.00040	5179.9801	-0.00038	5179.9797	-0.00039	5179.981	-0.00037
30	3.74	5179.9811	-0.00036	5179.9801	-0.00038	5179.9795	-0.00040	5179.9781	-0.00042
20	3.74	5179.9873	-0.00025	5179.9885	-0.00022	5179.9873	-0.00025	5179.9863	-0.00026
10	3.74	5179.9845	-0.00030	5179.9865	-0.00026	5179.9879	-0.00023	5179.986	-0.00027
0	3.74	5180.0224	0.00043	5180.0256	0.00049	5180.0248	0.00048	5180.0266	0.00051
-10	3.74	5179.998	-0.00004	5179.9978	-0.00004	5179.9968	-0.00006	5180.0003	0.00001
-20	3.74	5180.0204	0.00039	5180.0219	0.00042	5180.0231	0.00045	5180.02	0.00039
-30	3.74	5179.9832	-0.00032	5179.985	-0.00029	5179.9866	-0.00026	5179.9848	-0.00029

Frequency Stability Versus Temp.									
Operating Frequency: 5320 MHz									
Temp. (°C)	Power Supply (Vdc)	0 Minute		2 Minute		5 Minute		10 Minute	
		Measured Frequency (MHz)	Frequency Drift (ppm)	Measured Frequency (MHz)	Frequency Drift (ppm)	Measured Frequency (MHz)	Frequency Drift (ppm)	Measured Frequency (MHz)	Frequency Drift (ppm)
20	4.301	5179.9878	-0.00024	5179.9888	-0.00022	5179.9879	-0.00023	5179.9871	-0.00025
	3.74	5179.9873	-0.00025	5179.9885	-0.00022	5179.9873	-0.00025	5179.9863	-0.00026
	3.179	5179.9876	-0.00024	5179.9879	-0.00023	5179.9876	-0.00024	5179.9859	-0.00027

4.6 6 dB Bandwidth Measurement

4.6.1 Limits of 6 dB Bandwidth Measurement

The minimum of 6 dB Bandwidth Measurement is 0.5 MHz.

4.6.2 Test Setup

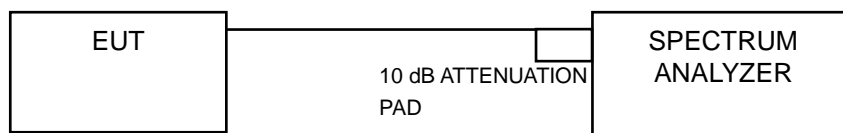

4.6.3 Test Instruments

Refer to section 4.1.3 to get information of above instrument.

4.6.4 Test Procedure

MEASUREMENT PROCEDURE REF

- Set resolution bandwidth (RBW) = 100 kHz
- Set the video bandwidth (VBW) $\geq 3 \times$ RBW, Detector = Peak.
- Trace mode = max hold.
- Sweep = auto couple.
- Measure the maximum width of the emission that is constrained by the frequencies associated with the two amplitude points (upper and lower) that are attenuated by 6 dB relative to the maximum level measured in the fundamental emission

4.6.5 Deviation from Test Standard

No deviation.

4.6.6 EUT Operating Condition

The software provided by client to enable the EUT under transmission condition continuously at lowest, middle and highest channel frequencies individually.

4.6.7 Test Results

802.11a

Channel	Frequency (MHz)	6 dB Bandwidth (MHz)	Minimum Limit (MHz)	Pass / Fail
149	5745	16.36	0.5	Pass
157	5785	16.38	0.5	Pass
165	5825	16.39	0.5	Pass

802.11n (HT20)

Channel	Frequency (MHz)	6 dB Bandwidth (MHz)	Minimum Limit (MHz)	Pass / Fail
149	5745	17.57	0.5	Pass
157	5785	17.56	0.5	Pass
165	5825	17.60	0.5	Pass

802.11n (HT40)

Channel	Frequency (MHz)	6 dB Bandwidth (MHz)	Minimum Limit (MHz)	Pass / Fail
151	5755	36.09	0.5	Pass
159	5795	35.82	0.5	Pass

802.11ac (VHT80)

Channel	Frequency (MHz)	6 dB Bandwidth (MHz)	Minimum Limit (MHz)	Pass / Fail
155	5775	75.66	0.5	Pass

Spectrum Plot of Worst Value

802.11a

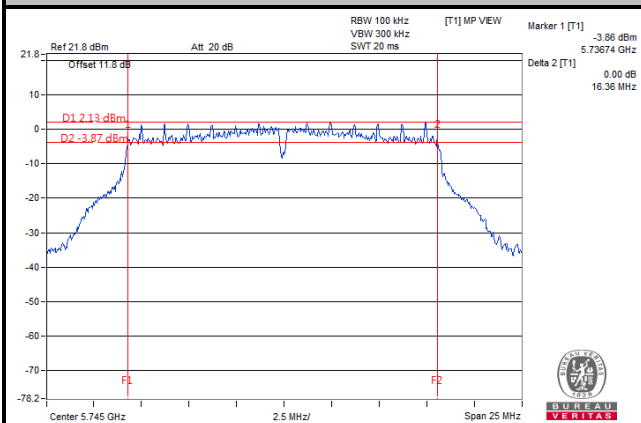

802.11n (HT20)

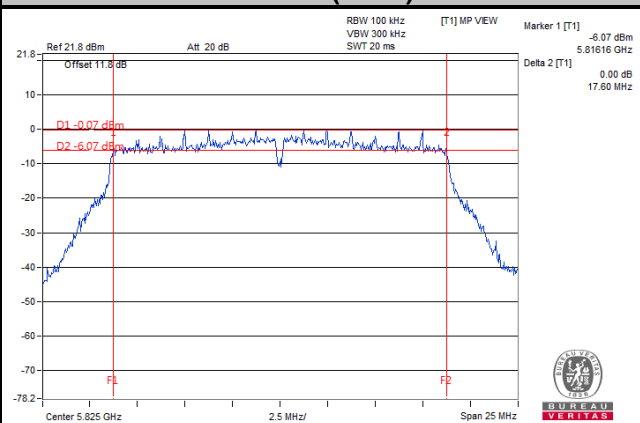

802.11n (HT40)

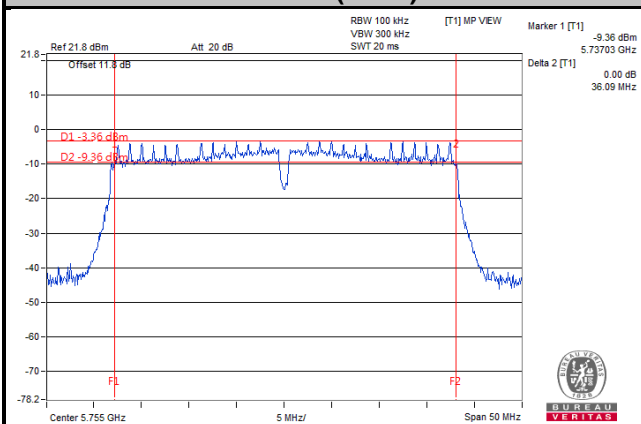

802.11ac (VHT80)

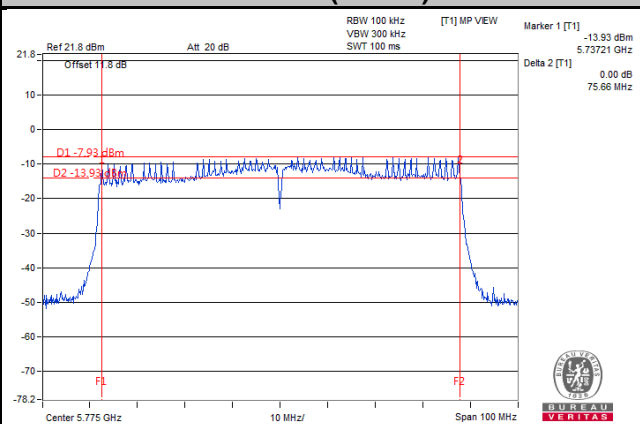

5 Pictures of Test Arrangements

Please refer to the attached file (Test Setup Photo).

Annex A- Radiated Out of Band Emisison (OOBE) Measurement (For U-NII-3 band)
802.11a

Ch 149	
Horizontal	Vertical
Ch 157	
Horizontal	Vertical
Ch 165	
Horizontal	Vertical

802.11n (HT20)

Ch 149	
Horizontal	Vertical
Ch 157	
Horizontal	Vertical
Ch 165	
Horizontal	Vertical

802.11n (HT40)

Ch 151	
Horizontal	Vertical
Ch 159	
Horizontal	Vertical

802.11ac (VHT80)

Ch 155	
Horizontal	Vertical

Appendix – Information on the Testing Laboratories

We, Bureau Veritas Consumer Products Services (H.K.) Ltd., Taoyuan Branch, were founded in 1988 to provide our best service in EMC, Radio, Telecom and Safety consultation. Our laboratories are accredited and approved according to ISO/IEC 17025.

If you have any comments, please feel free to contact us at the following:

Linko EMC/RF Lab

Tel: 886-2-26052180

Fax: 886-2-26051924

Hsin Chu EMC/RF/Telecom Lab

Tel: 886-3-6668565

Fax: 886-3-6668323

Hwa Ya EMC/RF/Safety

Tel: 886-3-3183232

Fax: 886-3-3270892

Email: service.adt@tw.bureauveritas.com

Web Site: www.bureauveritas-adt.com

The address and road map of all our labs can be found in our web site also.

--- END ---