



FCC RF Test Report

APPLICANT : Verifone, Inc.
EQUIPMENT : Point of Sales Terminal
BRAND NAME : Verifone
MODEL NAME : C680 3G-BT-WiFi
FCC ID : B32C6803GBTW
STANDARD : FCC Part 15 Subpart C §15.225
CLASSIFICATION : (DXX) Low Power Communication Device Transmitter

The testing was completed on Oct. 17, 2016. We, SPORTON INTERNATIONAL INC., would like to declare that the tested sample has been evaluated in accordance with the test procedures and has been in compliance with the applicable technical standards.

The test results in this report apply exclusively to the tested model / sample. Without written approval of SPORTON INTERNATIONAL INC., the test report shall not be reproduced except in full.

Reviewed by: Joseph Lin / Supervisor

Approved by: Jones Tsai / Manager



SPORTON INTERNATIONAL INC.

No. 52, Hwa Ya 1st Rd., Hwa Ya Technology Park, Kwei-Shan District, Tao Yuan City, Taiwan, R.O.C.



TABLE OF CONTENTS

SUMMARY OF THE TEST RESULT4

1. GENERAL INFORMATION.....5

1.1 Applicant..... 5

1.2 Manufacturer 5

1.3 Product Feature of Equipment Under Test 5

1.4 Product Specification of Equipment Under Test 6

1.5 Modification of EUT 6

1.6 Testing Location 7

1.7 Applicable Standards..... 7

2. TEST CONFIGURATION OF EQUIPMENT UNDER TEST8

2.1 Descriptions of Test Mode 8

2.2 Connection Diagram of Test System 9

2.3 Table for Supporting Units 10

2.4 EUT Operation Test Setup 10

3. TEST RESULTS.....11

3.1 AC Power Line Conducted Emissions Measurement 11

3.2 20dB and 99% OBW Spectrum Bandwidth Measurement..... 13

3.3 Frequency Stability Measurement 14

3.4 Field Strength of Fundamental Emissions and Mask Measurement..... 15

3.5 Radiated Emissions Measurement 17

3.6 Antenna Requirements..... 20

4. LIST OF MEASURING EQUIPMENT21

APPENDIX A. TEST RESULTS OF CONDUCTED EMISSION TEST

APPENDIX B. TEST RESULTS OF CONDUCTED TEST ITEMS

B1. Test Result of 20dB Spectrum Bandwidth

B2. Test Result of Frequency Stability

APPENDIX C. TEST RESULTS OF RADIATED TEST ITEMS

C1. Test Result of Field Strength of Fundamental Emissions

C2. Results of Radiated Emissions (9 kHz~30MHz)

C3. Results of Radiated Emissions (30MHz~1GHz)

APPENDIX D. SETUP PHOTOGRAPHS



REVISION HISTORY

REPORT NO.	VERSION	DESCRIPTION	ISSUED DATE
FR692114D	Rev. 01	Initial issue of report	Oct. 24, 2016



SUMMARY OF THE TEST RESULT

Applied Standard: 47 CFR FCC Part 15 Subpart C				
Part	FCC Rule	Description of Test	Result	Under Limit
3.1	15.207	AC Power Line Conducted Emissions	Complies	11.30 dB at 27.118MHz
3.2	15.215(c)	20dB Spectrum Bandwidth	Complies	-
	-	99% OBW Spectrum Bandwidth	Complies	-
3.3	15.225(e)	Frequency Stability	Complies	-
3.4	15.225(a)(b)(c)	Field Strength of Fundamental Emissions	Complies	73.61 dB at 13.560 MHz
3.5	15.225(d)	Radiated Emissions	Complies	3.39 dB at
	15.209			41.07 MHz
3.6	15.203	Antenna Requirements	Complies	-

Test Items	Uncertainty	Remark
AC Power Line Conducted Emissions	±2.7dB	Confidence levels of 95%
Radiated Emissions (30MHz~1000MHz)	±5.7dB	Confidence levels of 95%



1. GENERAL INFORMATION

1.1 Applicant

Verifone, Inc.

1400 West Stanford Ranch Road, Suite 100, 150 & 200, Rocklin CA 95765 USA

1.2 Manufacturer

Inventec Appliances (Pudong) Corporation

Building 1 - 3, No.789 Pu Xing Road, Caohejing Export Processing Zone, Shanghai, P.R.C.

1.3 Product Feature of Equipment Under Test

Product Feature	
Equipment	Point of Sales Terminal
Brand Name	Verifone
Model Name	C680 3G-BT-WiFi
FCC ID	B32C6803GBTW
EUT supports Radios application	GSM/EGPRS/WCDMA/HSPA/RFID WLAN 11b/g/n HT20 WLAN 11a/n HT20/HT40 Bluetooth BR/EDR/LE
EUT Stage	Identical Prototype

Remark: The above EUT's information was declared by manufacturer. Please refer to the specifications or user's manual for more detailed description.

Specification of Accessory		
AC Adapter 1	Brand Name	Verifone, Inc.
	Manufacturer	Elementech
	Model Name	A111-3050223U
	Power Rating	Input : 100-240 V AC 50/60Hz, 0.5A Output: 5.0V DC 2.2A
	Power Cord	1.8meter, non-shielded cable, without ferrite core
AC Adapter 2	Brand Name	Verifone, Inc.
	Manufacturer	PHIHONG
	Model Name	AM11A-050A-R
	Power Rating	Input : 100-240 V AC 50/60Hz, 0.5A Output: 5.0V DC 2.2A
	Power Cord	1.8meter, non-shielded cable, without ferrite core
Battery 1	Brand Name	Verifone, Inc.
	Manufacturer	Palladium Energy Inc.
	Model Name	BPK260-001
Battery 2	Brand Name	Verifone, Inc.
	Manufacturer	Panasonic Corporation
	Model Name	BPK260-001



1.4 Product Specification of Equipment Under Test

Standards-related Product Specification	
Tx/Rx Frequency Range	13.553 ~ 13.567MHz
Channel Number	1
20dBW	2.64 KHz
99%OBW	2.24 KHz
Antenna Type	Bobbin Antenna
Type of Modulation	ASK

Remark:

1. The above EUT's information was declared by manufacturer. Please refer to the specifications or user's manual for more detailed description.
2. All the test items were performed with Adapter 1 and Battery 1.

1.5 Modification of EUT

No modifications are made to the EUT during all test items.



1.6 Testing Location

Sporton Lab is accredited to ISO 17025 by Taiwan Accreditation Foundation (TAF code : 1190) and the FCC designation No. TW1022 under the FCC 2.948(e) by Mutual Recognition Agreement (MRA) in FCC Test.

Test Site	SPORTON INTERNATIONAL INC.		
Test Site Location	No. 52, Hwa Ya 1 st Rd., Hwa Ya Technology Park, Kwei-Shan District, Tao Yuan City, Taiwan, R.O.C. TEL: +886-3-3273456 / FAX: +886-3-3284978		
Test Site No.	Sporton Site No.		
	TH02-HY	CO05-HY	03CH07-HY
Test Engineer	William Liao	Kai-Chun Chu	Derreck Chen
Temperature°C	22~24	24~25	25~27
Relative Humidity%	53~55	45~46	48~50

Note: The test site complies with ANSI C63.4 2014 requirement.

1.7 Applicable Standards

According to the specifications of the manufacturer, the EUT must comply with the requirements of the following standards:

- ♦ FCC Part 15 Subpart C §15.225
- ♦ ANSI C63.10-2013



2. TEST CONFIGURATION OF EQUIPMENT UNDER TEST

2.1 Descriptions of Test Mode

Investigation has been done on all the possible configurations for searching the worst cases.

The following table is a list of the test modes shown in this test report.

Test Items	
AC Power Line Conducted Emissions	Field Strength of Fundamental Emissions
20dB Spectrum Bandwidth	Frequency Stability
Radiated Emissions 9kHz~30MHz	Radiated Emissions 30MHz~1GHz

The worst type (type A) was recorded in this report. Pre-scanned tests, X, Y, Z in three orthogonal panels to determine the final configuration (Z plane as worst plane) from all possible combinations.

2.2 Connection Diagram of Test System

<AC Conducted Emissions>

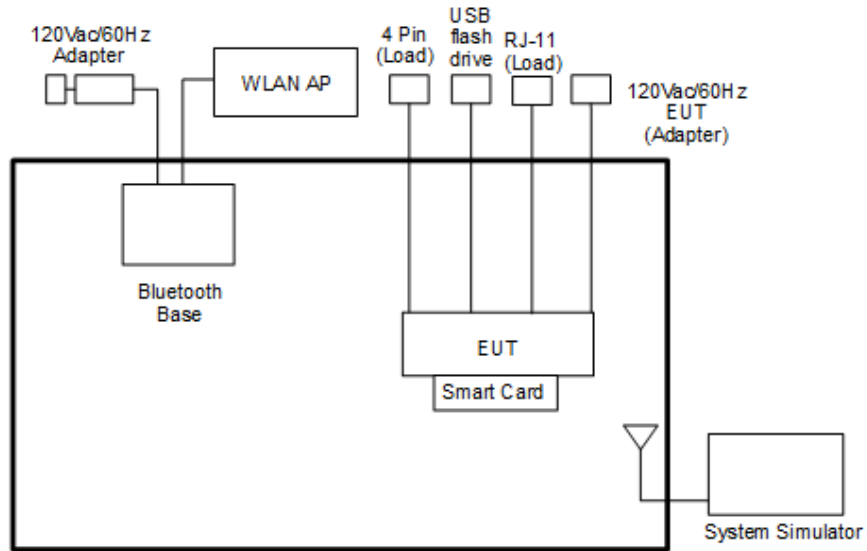

< For Fundamental Emissions and Mask and Radiated Emissions Measurement >

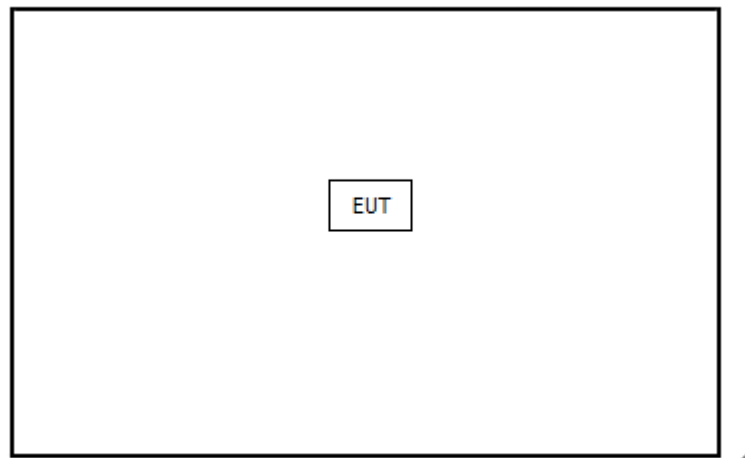



2.3 Table for Supporting Units

Support Unit	Manufacturer	Model	FCC ID
Base Station	Anritsu	MT8820C	N/A
Bluetooth Base	VeriFone	VX680-B-BTC	B32VX680-B-BTC
SD Card	SanDisk	MicroSD HC	FCC DoC
USB flash drive	Transcend	N/A	N/A
Smart Card	N/A	N/A	N/A

2.4 EUT Operation Test Setup

The EUT was programmed to be in continuously transmitting mode.

The ancillary equipment, NFC card, is used to make the EUT (NFC) continuously transmit at 13.56MHz and is placed around 3 cm gap to the EUT.



3. TEST RESULTS

3.1 AC Power Line Conducted Emissions Measurement

3.1.1 Limit of AC Conducted Emission

For equipment that is designed to be connected to the public utility (AC) power line, the radio frequency voltage that is conducted back onto the AC power line on any frequency or frequencies within the band 150 kHz to 30 MHz shall not exceed the limits in the following table.

Frequency of Emission (MHz)	Conducted Limit (dB μ V)	
	Quasi-Peak	Average
0.15-0.5	66 to 56*	56 to 46*
0.5-5	56	46
5-30	60	50

*Decreases with the logarithm of the frequency.

For terminal test result, the testing follows FCC KDB 174176.

3.1.2 Measuring Instruments

See list of measuring instruments of this test report.

3.1.3 Test Procedures

1. The EUT was placed 0.4 meter from the conducting wall of the shielding room, and it was kept at least 80 centimeters from any other grounded conducting surface.
2. Connect EUT to the power mains through a line impedance stabilization network (LISN).
3. All the support units are connecting to the other LISN.
4. The LISN provides 50 ohm coupling impedance for the measuring instrument.
5. The FCC states that a 50 ohm, 50 microhenry LISN should be used.
6. Both sides of AC line were checked for maximum conducted interference.
7. The frequency range from 150 kHz to 30 MHz was searched.
8. Set the test-receiver system to Peak Detect Function and specified bandwidth (IF Bandwidth = 9kHz) with Maximum Hold Mode. Then measurement is also conducted by Average Detector and Quasi-Peak Detector Function respectively.

3.1.4 Test setup

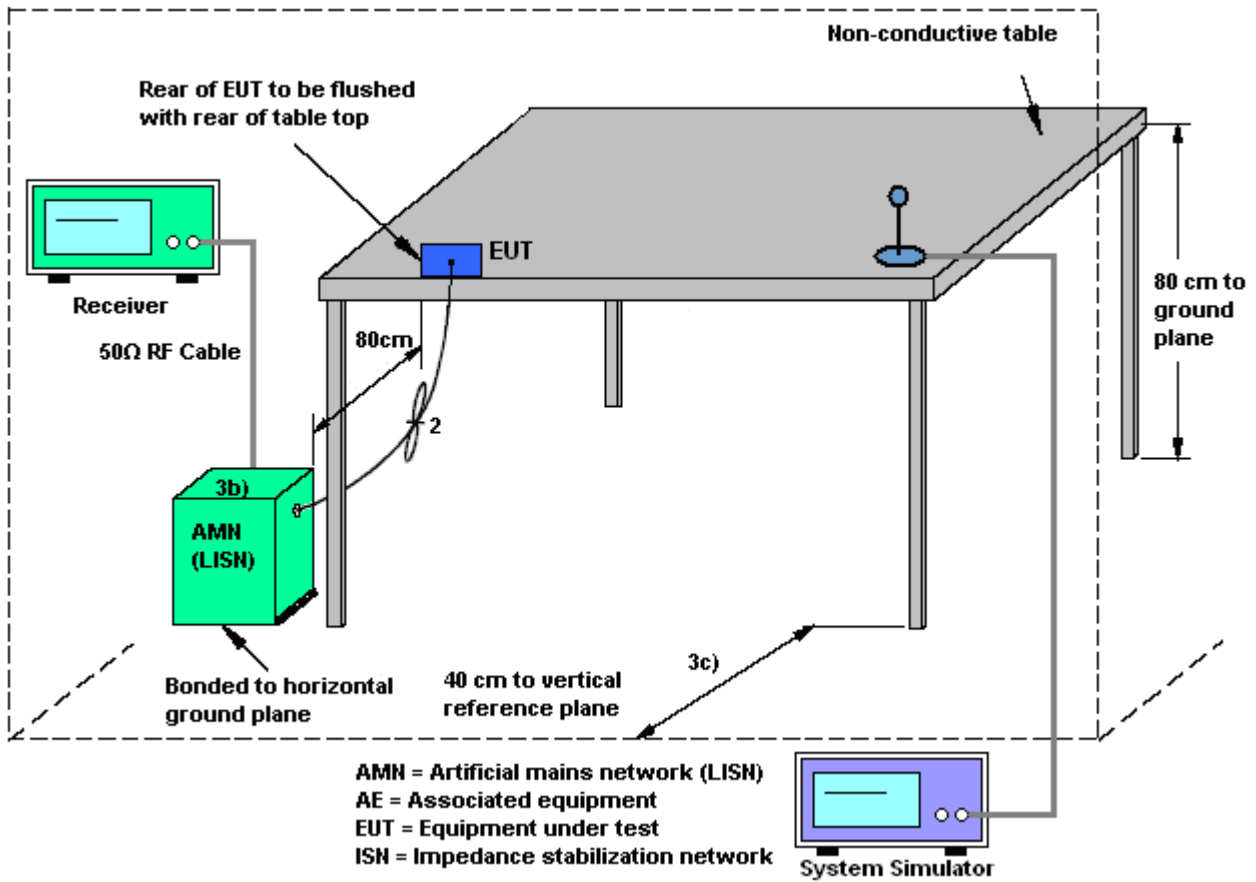

3.1.5 Test Result of AC Conducted Emission

Please refer to Appendix A.

3.2 20dB and 99% OBW Spectrum Bandwidth Measurement

3.2.1 Limit

Intentional radiators must be designed to ensure that the 20dB and 99% emission bandwidth in the specific band 13.553~13.567MHz.

3.2.2 Measuring Instruments

See list of measuring instruments of this test report.

3.2.3 Test Procedures

1. The spectrum analyzer connected via a receive antenna placed near the EUT in peak Max hold mode.
2. The resolution bandwidth of 1 kHz and the video bandwidth of 3 kHz were used.
3. Measured the spectrum width with power higher than 20dB below carrier.
4. Measured the 99% OBW.

3.2.4 Test Setup



3.2.5 Test Result of Conducted Test Items

Please refer to Appendix B.

3.3 Frequency Stability Measurement

3.3.1 Limit

The frequency tolerance of the carrier signal shall be maintained within +/- 0.01% (100ppm) of the operating frequency over a temperature variation of -20 degrees to +50 degrees C at normal supply voltage, and for a variation in the primary supply voltage from 85% to 115% of the rated supply voltage at a temperature of 20 degrees C. For battery operated equipment, the equipment tests shall be performed using a new battery.

3.3.2 Measuring Instruments

See list of measuring instruments of this test report.

3.3.3 Test Procedures

1. The spectrum analyzer connected via a receive antenna placed near the EUT.
2. EUT have transmitted signal and fixed channelize.
3. Set the spectrum analyzer span to view the entire emissions bandwidth.
4. Set RBW = 1 kHz, VBW = 3 kHz with peak detector and maxhold settings.
5. The f_c is declaring of channel frequency. Then the frequency error formula is $(f_c - f) / f_c \times 10^6$ ppm and the limit is less than ± 100 ppm.
6. Extreme temperature rule is -20°C~50°C.

3.3.4 Test Setup

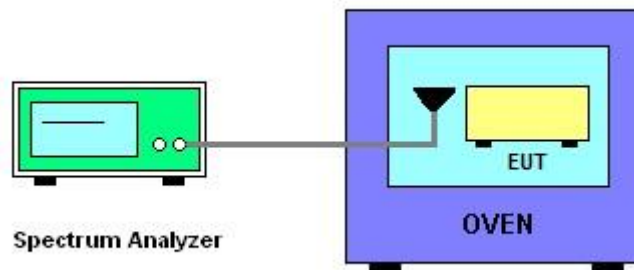

3.3.5 Test Result of Conducted Test Items

Please refer to Appendix B.



3.4 Field Strength of Fundamental Emissions and Mask Measurement

3.4.1 Limit

Rules and specifications	FCC CFR 47 Part 15 section 15.225			
Description	Compliance with the spectrum mask is tested with RBW set to 9kHz.			
Freq. of Emission (MHz)	Field Strength (μV/m) at 30m	Field Strength (dBμV/m) at 30m	Field Strength (dBμV/m) at 10m	Field Strength (dBμV/m) at 3m
1.705~13.110	30	29.5	48.58	69.5
13.110~13.410	106	40.5	59.58	80.5
13.410~13.553	334	50.5	69.58	90.5
13.553~13.567	15848	84.0	103.08	124.0
13.567~13.710	334	50.5	69.58	90.5
13.710~14.010	106	40.5	59.58	80.5
14.010~30.000	30	29.5	48.58	69.5

3.4.2 Measuring Instruments

See list of measuring instruments of this test report.

3.4.3 Test Procedures

1. Configure the EUT according to ANSI C63.10. The EUT was placed on the top of the turntable 0.8 meter above ground. The phase center of the loop receiving antenna mounted antenna tower was placed 3 meters far away from the turntable.
2. Power on the EUT and all the supporting units. The turntable was rotated by 360 degrees to determine the position of the highest radiation.
3. The height of the receiving antenna was fixed at one meter above ground to find the maximum emissions field strength.
4. For Fundamental emissions, use the receiver to measure QP reading.

5. When the radiated emissions limits are expressed in terms of the average value of the emissions, and pulsed operation is employed, the measurement field strength shall be determined by averaging over one complete pulse train, including blanking intervals, as long as the pulse train does not exceed 0.1 seconds. As an alternative (provided the transmitter operates for longer than 0.1 seconds) or in cases where the pulse train exceeds 0.1 seconds, the measured field strength shall be determined from the average absolute voltage during a 0.1 second interval during which the field strength is at its maximum value.
6. Compliance with the spectrum mask is tested with RBW set to 9kHz.
Note: Emission level (dB μ V/m) = 20 log Emission level (μ V/m).

3.4.4 Test Setup

For radiated emissions below 30MHz

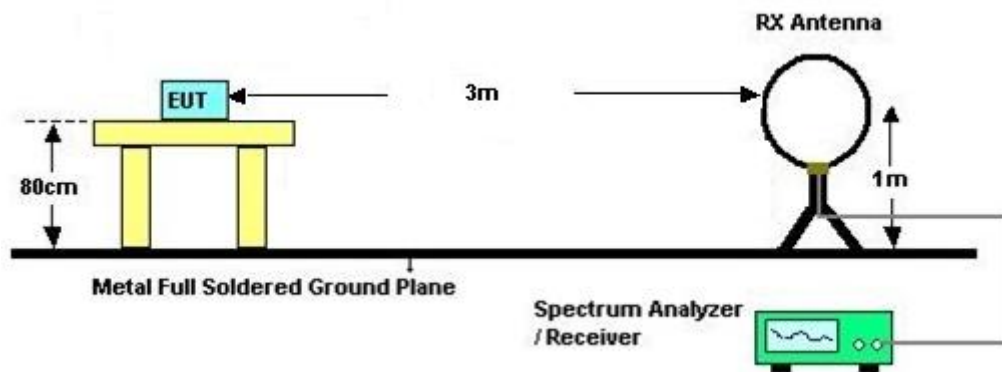

3.4.5 Test Result of Field Strength of Fundamental Emissions and Mask

Please refer to Appendix C.



3.5 Radiated Emissions Measurement

3.5.1 Limit

The field strength of any emissions which appear outside of 13.110 ~14.010MHz band shall not exceed the general radiated emissions limits.

Frequencies (MHz)	Field Strength (µV/m)	Measurement Distance (meters)
0.009~0.490	2400/F(kHz)	300
0.490~1.705	24000/F(kHz)	30
1.705~30.0	30	30
30~88	100	3
88~216	150	3
216~960	200	3
Above 960	500	3

3.5.2 Measuring Instruments

See list of measuring instruments of this test report.

3.5.3 Measuring Instrument Setting

The following table is the setting of receiver.

Receiver Parameter	Setting
Attenuation	Auto
Frequency Range: 9kHz~150kHz	RBW 200Hz for QP
Frequency Range: 150kHz~30MHz	RBW 9kHz for QP
Frequency Range: 30MHz~1000MHz	RBW 120kHz for Peak

Note: The emission limits shown in the above table are based on measurements employing a CISPR quasi-peak detector except for the frequency bands 9-90 kHz, 110-490 kHz. Radiated emission limits in these two bands are based on measurements employing an average detector.



3.5.4 Test Procedures

1. Configure the EUT according to ANSI C63.10. The EUT was placed on the top of the turntable 0.8 meter above ground. The phase center of the receiving antenna mounted on the top of a height-variable antenna tower was placed 3 meters far away from the turntable.
1. Power on the EUT and all the supporting units. The turntable was rotated by 360 degrees to determine the position of the highest radiation.
2. The height of the broadband receiving antenna was varied between one meter and four meters above ground to find the maximum emissions field strength of both horizontal and vertical polarization.
3. For each suspected emissions, the antenna tower was scan (from 1 M to 4 M) and then the turntable was rotated (from 0 degree to 360 degrees) to find the maximum reading.
4. Set the test-receiver system to Peak or CISPR quasi-peak Detect Function with specified bandwidth under Maximum Hold Mode.
5. When the radiated emissions limits are expressed in terms of the average value of the emissions, and pulsed operation is employed, the measurement field strength shall be determined by averaging over one complete pulse train, including blanking intervals, as long as the pulse train does not exceed 0.1 seconds. As an alternative (provided the transmitter operates for longer than 0.1 seconds) or in cases where the pulse train exceeds 0.1 seconds, the measured field strength shall be determined from the average absolute voltage during a 0.1 second interval during which the field strength is at its maximum value.
6. In case the emission is lower than 30MHz, loop antenna has to be used for measurement and the recorded data should be QP measured by receiver. Antenna Requirements

3.5.5 Test Setup

For radiated emissions below 30MHz

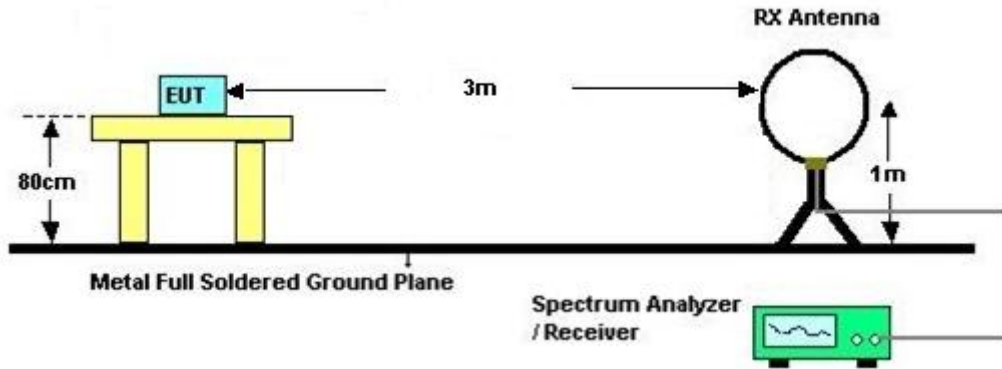

For radiated emissions above 30MHz

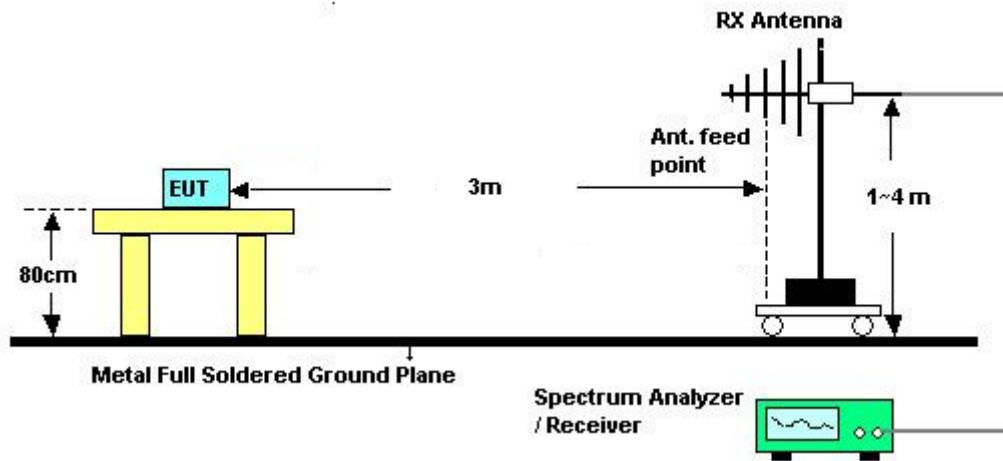

3.5.6 Test Result of Radiated Emissions Measurement

Please refer to Appendix C.



3.6 Antenna Requirements

3.6.1 Standard Applicable

Except for special regulations, the Low-power Radio-frequency Devices must not be equipped with any jacket for installing an antenna with extension cable. An intentional radiator shall be designed to ensure that no antenna other than that furnished by the responsible party shall be used with the device. The use of a permanently attached antenna or of an antenna that uses a unique coupling to the intentional radiator shall be considered sufficient to comply with the provisions of this Section. The manufacturer may design the unit so that the user can replace a broken antenna, but the use of a standard antenna jack or electrical connector is prohibited.

The use of a permanently attached antenna or of an antenna that uses a unique coupling to the intentional radiator shall be considered sufficient to comply with the FCC rule.

3.6.2 Antenna Anti-Replacement Construction

An embedded-in antenna design is used.



4. LIST OF MEASURING EQUIPMENT

Instrument	Manufacturer	Model No.	Serial No.	Characteristics	Calibration Date	Test Date	Due Date	Remark
AC Power Source	AC POWER	AFC-500W	F104070011	50Hz~60Hz	Dec. 02, 2015	Oct. 07, 2016	Dec. 01, 2016	Conducted (TH03-HY)
Spectrum Analyzer	Rohde & Schwarz	FSP30	101329	9kHz~30GHz	Jun. 27, 2016	Oct. 07, 2016	Jun. 26, 2017	Conducted (TH03-HY)
Temperature Chamber	ESPEC	SU-641	92013721	-30°C ~70°C	Nov. 20, 2015	Oct. 07, 2016	Nov. 19, 2016	Conducted (TH03-HY)
AC Power Source	ChainTek	APC-1000W	N/A	N/A	N/A	Oct. 02, 2016 ~ Oct. 17, 2016	N/A	Conduction (CO05-HY)
EMI Test Receiver	Rohde & Schwarz	ESCI 7	100724	9kHz~7GHz	Aug. 30, 2016	Oct. 02, 2016 ~ Oct. 17, 2016	Aug. 29, 2017	Conduction (CO05-HY)
LISN	Rohde & Schwarz	ENV216	100080	9kHz~30MHz	Dec. 02, 2015	Oct. 02, 2016 ~ Oct. 17, 2016	Dec. 01, 2016	Conduction (CO05-HY)
LISN	Rohde & Schwarz	ENV216	100081	9kHz~30MHz	Dec. 14, 2015	Oct. 02, 2016 ~ Oct. 17, 2016	Dec. 13, 2016	Conduction (CO05-HY)
Bilog Antenna	TESEQ	CBL 6111D&00800 N1D01N-06	35419&03	30MHz to 1GHz	Jan. 13, 2016	Oct. 08, 2016	Jan. 12, 2017	Radiation (03CH07-HY)
EMI Test Receiver	Keysight	N9038A(MXE)	MY54130085	20Hz ~ 8.4GHz	Nov. 04, 2015	Oct. 08, 2016	Nov. 03, 2016	Radiation (03CH07-HY)
Loop Antenna	Rohde & Schwarz	HFH2-Z2	100315	9 kHz~30 MHz	Sep. 02, 2015	Oct. 08, 2016	Sep. 01, 2017	Radiation (03CH07-HY)
Preamplifier	COM-POWER	PA-103A	161241	10MHz-1GHz	Mar. 18, 2016	Oct. 08, 2016	Mar. 17, 2017	Radiation (03CH07-HY)
Spectrum Analyzer	Agilent	N9010A	MY53470118	10Hz~44GHz	Feb. 27, 2016	Oct. 08, 2016	Feb. 26, 2017	Radiation (03CH07-HY)
Antenna Mast	Max-Full	MFA520BS	N/A	1m~4m	N/A	Oct. 08, 2016	N/A	Radiation (03CH07-HY)
Turn Table	ChainTek	Chaintek 3000	N/A	0~360 Degree	N/A	Oct. 08, 2016	N/A	Radiation (03CH07-HY)

Appendix A. Test Results of Conducted Emission Test

<Original Test Result>

Test Mode :	NFC Tx	Test Voltage :	120Vac / 60Hz
Function Type :	GSM1900 Idle + Bluetooth Idle + Smart Card Reader + Magnetic Card Reader + RFID Tx + Battery 1 + Adapter + RS-232/4-Pin Cable (Load) + RS-232/RJ11 Cable (Load) + Printer + SAM Card + Micro SD Card + Primary Micro-USB Port (Cable Load) + Secondary Micro-USB Port (Data Link with USB Storage Device)		

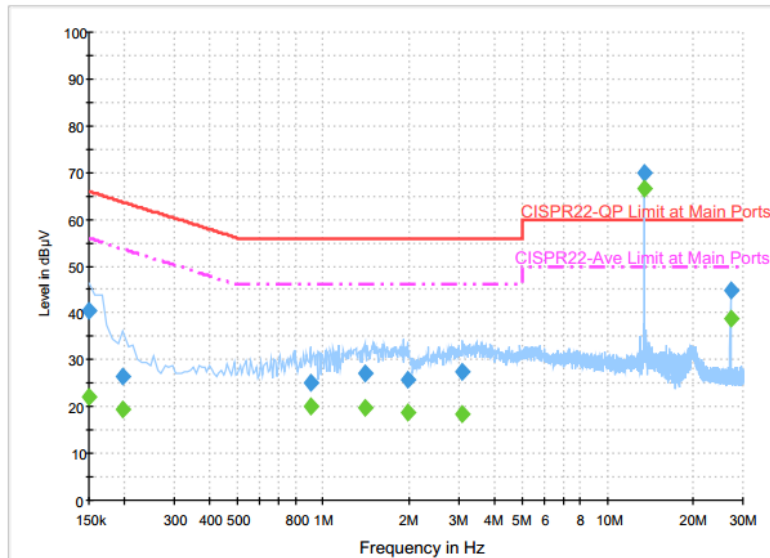

Final Result : Quasi-Peak

Frequency (MHz)	Quasi-Peak (dBµV)	Filter	Line	Corr. (dB)	Margin (dB)	Limit (dBµV)
0.150000	40.4	Off	L1	19.6	25.6	66.0
0.198000	26.5	Off	L1	19.6	37.2	63.7
0.902000	25.1	Off	L1	19.7	30.9	56.0
1.406000	27.0	Off	L1	19.7	29.0	56.0
1.982000	25.8	Off	L1	19.7	30.2	56.0
3.094000	27.3	Off	L1	19.6	28.7	56.0
13.558000	69.8	Off	L1	20.3	-9.8	60.0
27.118000	44.7	Off	L1	21.0	15.3	60.0

Final Result : Average

Frequency (MHz)	Average (dBµV)	Filter	Line	Corr. (dB)	Margin (dB)	Limit (dBµV)
0.150000	22.1	Off	L1	19.6	33.9	56.0
0.198000	19.4	Off	L1	19.6	34.3	53.7
0.902000	19.9	Off	L1	19.7	26.1	46.0
1.406000	19.6	Off	L1	19.7	26.4	46.0
1.982000	18.8	Off	L1	19.7	27.2	46.0
3.094000	18.4	Off	L1	19.6	27.6	46.0
13.558000	66.7	Off	L1	20.3	-16.7	50.0
27.118000	38.7	Off	L1	21.0	11.3	50.0



Test Mode :	NFC Tx	Test Voltage :	120Vac / 60Hz
Function Type :	GSM1900 Idle + Smart Card Reader + Magnetic Card Reader + RFID Off + Battery 1 + Adapter + RS-232/4-Pin Cable (Load) + RS-232/RJ11 Cable (Load) + Printer + SAM Card + Micro SD Card + Primary Micro-USB Port (Cable Load) + Secondary Micro-USB Port (Data Link with USB Storage Device)		

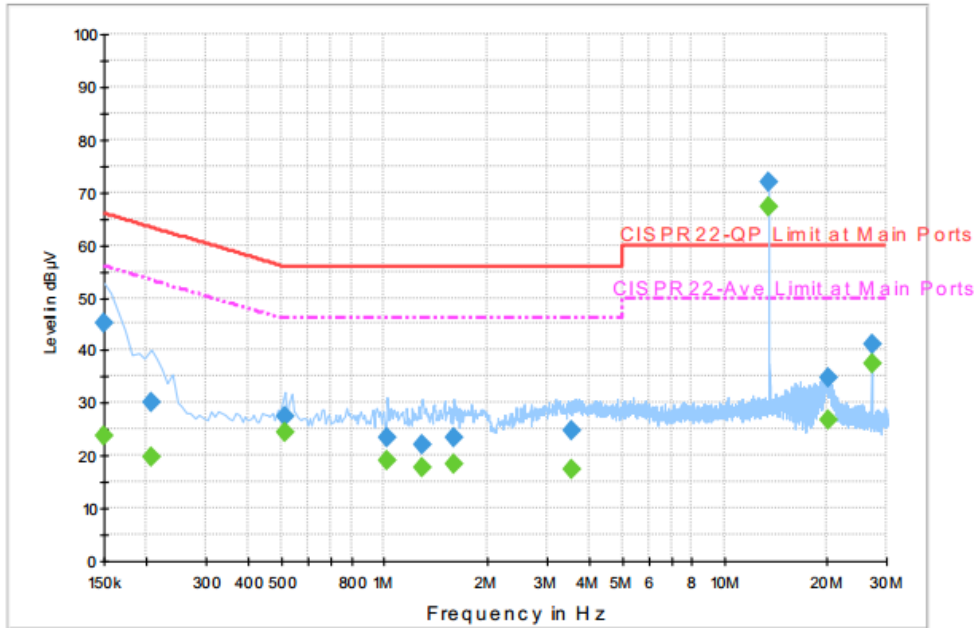

Final Result : Quasi-Peak

Frequency (MHz)	Quasi-Peak (dBµV)	Filter	Line	Corr. (dB)	Margin (dB)	Limit (dBµV)
0.150000	45.3	Off	N	19.6	20.7	66.0
0.206000	30.2	Off	N	19.6	33.2	63.4
0.510000	27.6	Off	N	19.6	28.4	56.0
1.022000	23.4	Off	N	19.6	32.6	56.0
1.294000	22.1	Off	N	19.6	33.9	56.0
1.598000	23.4	Off	N	19.7	32.6	56.0
3.574000	24.8	Off	N	19.7	31.2	56.0
13.558000	72.0	Off	N	20.4	-12.0	60.0
20.174000	34.6	Off	N	20.8	25.4	60.0
27.118000	41.3	Off	N	21.2	18.7	60.0



Test Mode :	NFC Tx	Test Voltage :	120Vac / 60Hz
Function Type :	GSM1900 Idle + Smart Card Reader + Magnetic Card Reader + RFID Off + Battery 1 + Adapter + RS-232/4-Pin Cable (Load) + RS-232/RJ11 Cable (Load) + Printer + SAM Card + Micro SD Card + Primary Micro-USB Port (Cable Load) + Secondary Micro-USB Port (Data Link with USB Storage Device)		

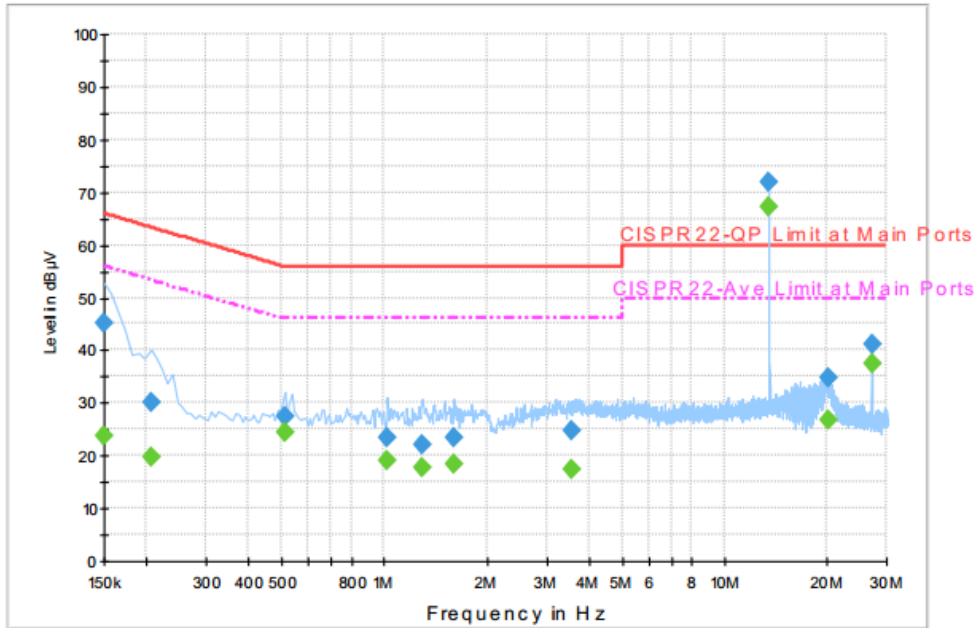

Final Result : Average

Frequency (MHz)	Average (dBµV)	Filter	Line	Corr. (dB)	Margin (dB)	Limit (dBµV)
0.150000	23.6	Off	N	19.6	32.4	56.0
0.206000	19.6	Off	N	19.6	33.8	53.4
0.510000	24.4	Off	N	19.6	21.6	46.0
1.022000	19.0	Off	N	19.6	27.0	46.0
1.294000	17.8	Off	N	19.6	28.2	46.0
1.598000	18.5	Off	N	19.7	27.5	46.0
3.574000	17.3	Off	N	19.7	28.7	46.0
13.558000	67.2	Off	N	20.4	-17.2	50.0
20.174000	26.6	Off	N	20.8	23.4	50.0
27.118000	37.5	Off	N	21.2	12.5	50.0

(1) with antenna

Remark: 13.558MHz is the NFC RF fundamental signal.

(2) with dummy load

Remark: Only the fundamental NFC signal needs to be retested per C63.4.



<Terminal Test Result>

Test Mode :	NFC Tx	Test Voltage :	120Vac / 60Hz
Function Type :	GSM1900 Idle + Smart Card Reader + Magnetic Card Reader + RFID Tx + Battery 1 + Adapter + RS-232/4-Pin Cable (Load) + RS-232/RJ11 Cable (Load) + Printer + SAM Card + Micro SD Card + Primary Micro-USB Port (Cable Load) + Secondary Micro-USB Port (Data Link with USB Storage Device)		

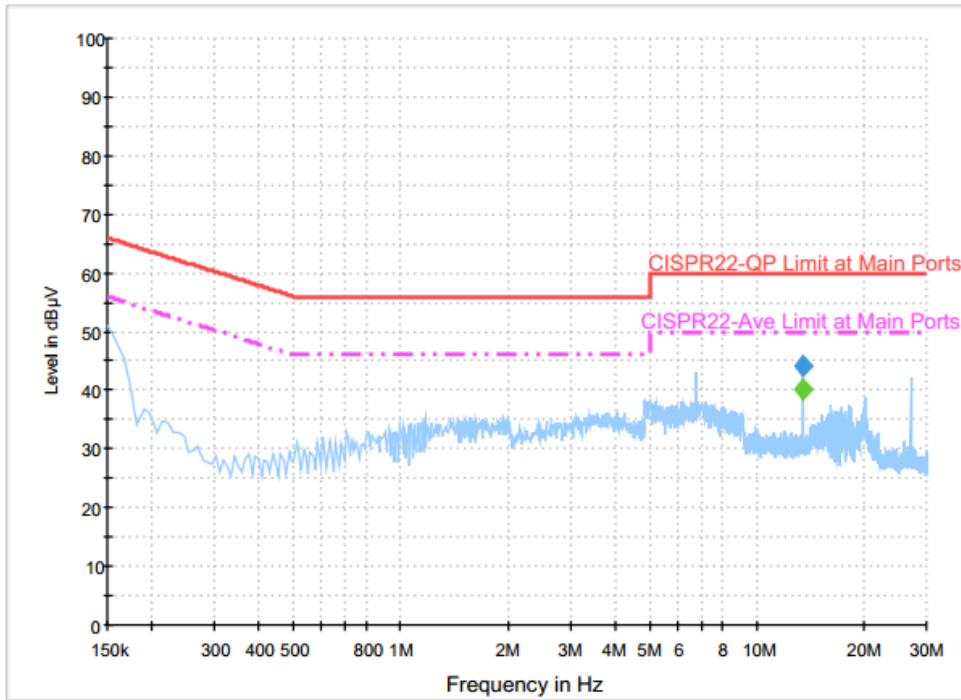

Final Result : Quasi-Peak

Frequency (MHz)	Quasi-Peak (dBµV)	Filter	Line	Corr. (dB)	Margin (dB)	Limit (dBµV)
13.558000	44.1	Off	L1	20.3	15.9	60.0

Final Result : Average

Frequency (MHz)	Average (dBµV)	Filter	Line	Corr. (dB)	Margin (dB)	Limit (dBµV)
13.558000	40.1	Off	L1	20.3	9.9	50.0



Test Mode :	NFC Tx	Test Voltage :	120Vac / 60Hz
Function Type :	GSM1900 Idle + Smart Card Reader + Magnetic Card Reader + RFID Off + Battery 1 + Adapter + RS-232/4-Pin Cable (Load) + RS-232/RJ11 Cable (Load) + Printer + SAM Card + Micro SD Card + Primary Micro-USB Port (Cable Load) + Secondary Micro-USB Port (Data Link with USB Storage Device)		

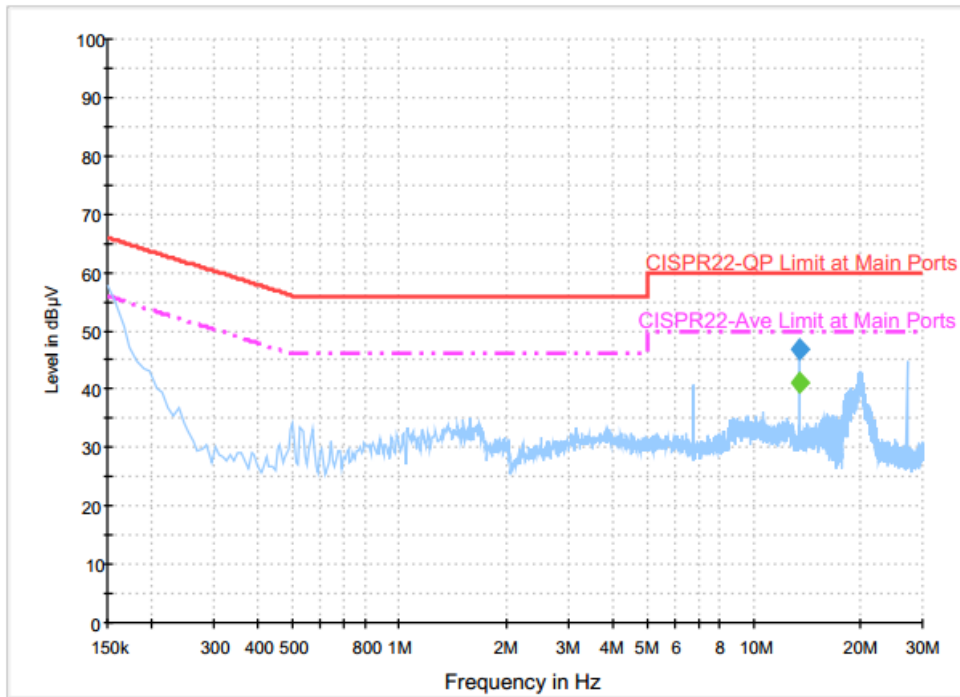

Final Result : Quasi-Peak

Frequency (MHz)	Quasi-Peak (dBµV)	Filter	Line	Corr. (dB)	Margin (dB)	Limit (dBµV)
13.558000	46.7	Off	N	20.4	13.3	60.0

Final Result : Average

Frequency (MHz)	Average (dBµV)	Filter	Line	Corr. (dB)	Margin (dB)	Limit (dBµV)
13.558000	41.3	Off	N	20.4	8.7	50.0



Appendix B. Test Results of Conducted Test Items

B1. Test Result of 20dB Spectrum Bandwidth

Test mode	NFC Tx	Test Frequency (MHz)	13.56
<p>Ref 20 dBm +Att 30 dB SWT 20 ms +BBW 1 kHz Marker 1 [T1] -0.93 dBm +VBW 3 kHz 13.559860000 MHz ndB [T1] 20.00 dB BW 2.64000000 kHz Temp 1 [T1] dBm -20.80 dBm 13.558500000 MHz Temp 2 [T1] dBm -21.09 dBm 13.561140000 MHz</p> <p>Date: 7.OCT.2016 11:27:10</p>		<p>Ref 20 dBm +Att 30 dB SWT 20 ms +RBW 1 kHz Marker 1 [T1] -0.93 dBm +VBW 3 kHz 13.560940000 MHz OBW 2.24000000 kHz Temp 1 [T1] dBm -21.55 dBm 13.558700000 MHz Temp 2 [T1] dBm -21.22 dBm 13.560940000 MHz</p> <p>Date: 7.OCT.2016 11:27:26</p>	
20dB Bandwidth (kHz)	2.640	99% OccupiedBW(kHz)	2.240
Frequency range (MHz)	$f_L > 13.553$	13.55850	Test Result
	$f_H < 13.567$	13.56114	Complies



B2. Test Result of Frequency Stability

Voltage vs. Frequency Stability		Temperature vs. Frequency Stability		
Voltage (Vac)	Measurement Frequency (MHz)	Temperature (°C)	Time	Measurement Frequency (MHz)
4.2	13.559880	-20	0	13.559880
			2	13.559880
			5	13.559880
			10	13.559880
3.7	13.559880	-10	0	13.559880
			2	13.559880
			5	13.559880
			10	13.559880
3.3	13.559880	0	0	13.559880
			2	13.559880
			5	13.559880
			10	13.559880
		10	0	13.559880
			2	13.559880
			5	13.559880
			10	13.559880
		20	0	13.559820
			2	13.559820
			5	13.559820
			10	13.559820
		30	0	13.559820
			2	13.559820
			5	13.559820
			10	13.559820
		40	0	13.559820
			2	13.559820
			5	13.559820
			10	13.559820



Voltage vs. Frequency Stability		Temperature vs. Frequency Stability		
Voltage (Vac)	Measurement Frequency (MHz)	Temperature (°C)	Time	Measurement Frequency (MHz)
		50	0	13.559820
			2	13.559820
			5	13.559820
			10	13.559820
Max.Deviation (MHz)	-0.000120	Max.Deviation (MHz)		-0.000180
Max.Deviation (ppm)	-8.8496	Max.Deviation (ppm)		-13.2743
Limit	FS < ±100 ppm	Limit		FS < ±100 ppm
Test Result	PASS	Test Result		PASS



Appendix C. Test Results of Radiated Test Items

C1. Test Result of Field Strength of Fundamental Emissions

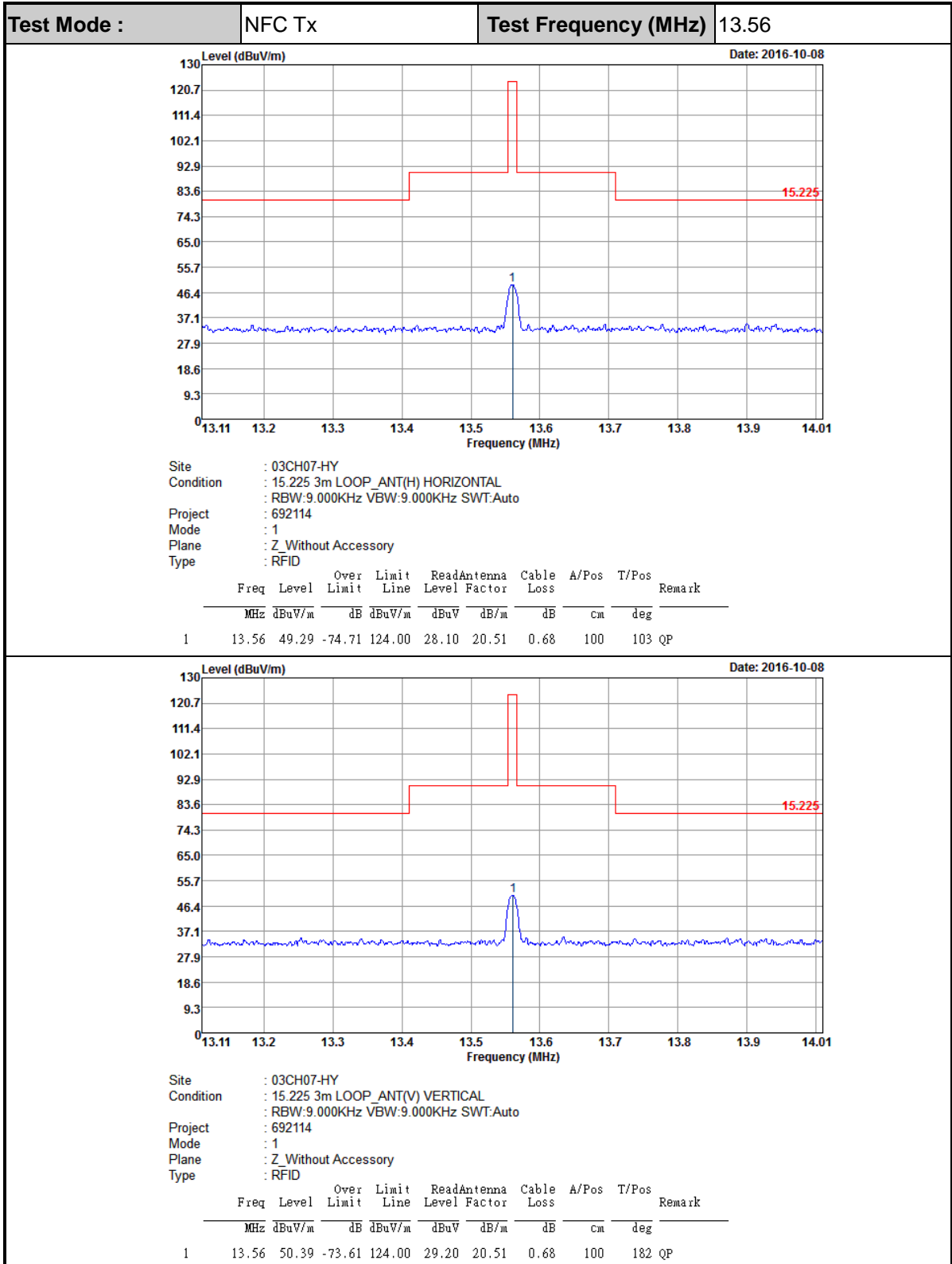



C2. Results of Radiated Spurious Emissions (9 kHz~30MHz)

Test Mode :	NFC Tx	Polarization :	Horizontal
--------------------	--------	-----------------------	------------

Frequency (MHz)	Level (dBμV/m)	Over Limit (dB)	Limit Line (dBμV/m)	Read Level (dBμV)	Antenna Factor (dB)	Cable Loss (dB)	Ant Pos (cm)	Table Pos (deg)	Remark
0.00982	41.89	-85.88	127.77	18.31	22.9	0.68	-	-	Average
0.06042	35.08	-76.9	111.98	15.4	19	0.68	-	-	Average
0.09326	30.81	-77.4	108.21	11.33	18.8	0.68	-	-	QP
0.1152	29.75	-76.63	106.38	10.28	18.79	0.68	-	-	Average
0.15238	43.67	-60.28	103.95	24.22	18.77	0.68	-	-	Average
2.172	37.01	-32.49	69.5	17.43	18.9	0.68	-	-	QP
8.68	33.82	-35.68	69.5	13.55	19.59	0.68	-	-	QP
13.56	49.22	-20.28	69.5	28.03	20.51	0.68	-	-	QP
24.73	36.98	-32.52	69.5	13.83	22.08	1.07	-	-	QP
25.43	37.87	-31.63	69.5	14.67	22.13	1.07	100	0	QP

Test Mode :	NFC Tx	Polarization :	Vertical
--------------------	--------	-----------------------	----------

Frequency (MHz)	Level (dBμV/m)	Over Limit (dB)	Limit Line (dBμV/m)	Read Level (dBμV)	Antenna Factor (dB)	Cable Loss (dB)	Ant Pos (cm)	Table Pos (deg)	Remark
0.00982	40.69	-87.08	127.77	17.11	22.9	0.68	-	-	Average
0.06087	34.72	-77.2	111.92	15.04	19	0.68	-	-	Average
0.09496	30.55	-77.5	108.05	11.07	18.8	0.68	-	-	QP
0.12484	29.61	-76.07	105.68	10.14	18.79	0.68	-	-	Average
0.15068	43.09	-60.95	104.04	23.64	18.77	0.68	-	-	Average
2.405	36.81	-32.69	69.5	17.23	18.9	0.68	-	-	QP
8.272	33.46	-36.04	69.5	13.25	19.53	0.68	-	-	QP
13.56	50.33	-19.17	69.5	29.14	20.51	0.68	-	-	QP
24.982	37.37	-32.13	69.5	14.2	22.1	1.07	-	-	QP
28.67	38.4	-31.1	69.5	15.01	22.32	1.07	100	0	QP

Note:

- 13.56 MHz is fundamental signal which can be ignored.
- The amplitude of spurious emissions which are attenuated by more than 20dB below the permissible value has no need to be reported.
- Distance extrapolation factor = 40 log (specific distance / test distance) (dB);
- Limit line = specific limits (dBμV) + distance extrapolation factor.



C3. Results of Radiated Spurious Emissions (30MHz~1GHz)

Test Mode :	NFC Tx	Polarization :	Horizontal
-------------	--------	----------------	------------

Frequency (MHz)	Level (dBμV/m)	Over Limit (dB)	Limit Line (dBμV/m)	Read Level (dBμV)	Antenna Factor (dB)	Cable Loss (dB)	Preamp Factor (dB)	Ant Pos (cm)	Table Pos (deg)	Remark
41.07	36.61	-3.39	40	47.19	19.84	1.07	31.49	100	232	Peak
46.2	31.01	-8.99	40	44.73	16.77	1.07	31.56	-	-	Peak
54.84	33.73	-6.27	40	50.7	13.55	1.07	31.59	-	-	Peak
862.8	32.21	-13.79	46	29.82	28.78	4.17	30.56	-	-	Peak
924.4	32.95	-13.05	46	29.78	29.59	4.12	30.54	-	-	Peak
972	35.47	-18.53	54	31.69	30.24	4.07	30.53	-	-	Peak

Test Mode :	NFC Tx	Polarization :	Vertical
-------------	--------	----------------	----------

Frequency (MHz)	Level (dBμV/m)	Over Limit (dB)	Limit Line (dBμV/m)	Read Level (dBμV)	Antenna Factor (dB)	Cable Loss (dB)	Preamp Factor (dB)	Ant Pos (cm)	Table Pos (deg)	Remark
40.8	35.57	-4.43	40	46.15	19.84	1.07	31.49	100	196	Peak
54.03	31.46	-8.54	40	48.12	13.86	1.07	31.59	-	-	Peak
67.8	25.65	-14.35	40	43.38	12.56	1.28	31.57	-	-	Peak
839	32.73	-13.27	46	30.72	28.48	4.1	30.57	-	-	Peak
915.3	33.2	-12.8	46	30.24	29.38	4.12	30.54	-	-	Peak
946.8	34.09	-11.91	46	30.42	30.13	4.07	30.53	-	-	Peak

Note:

1. The amplitude of spurious emissions which are attenuated by more than 20dB below the permissible value has no need to be reported.
2. Emission level (dBμV/m) = 20 log Emission level (μV/m).
3. Corrected Reading: Antenna Factor + Cable Loss + Read Level - Preamp Factor= Level.