



# FCC RF Test Report

**APPLICANT** : Verifone, Inc.  
**EQUIPMENT** : Point of Sales Terminal  
**BRAND NAME** : Verifone  
**MODEL NAME** : C680 3G-BT-WiFi  
**FCC ID** : B32C6803GBTW  
**STANDARD** : FCC Part 15 Subpart C §15.247  
**CLASSIFICATION** : (DTS) Digital Transmission System

The product was received on Sep. 21, 2016 and testing was completed on Oct. 17, 2016. We, SPORTON INTERNATIONAL INC., would like to declare that the tested sample has been evaluated in accordance with the test procedures and has been in compliance with the applicable technical standards.

The test results in this report apply exclusively to the tested model / sample. Without written approval of SPORTON INTERNATIONAL INC., the test report shall not be reproduced except in full.

Reviewed by: Joseph Lin / Supervisor

Approved by: Jones Tsai / Manager



## **SPORTON INTERNATIONAL INC.**

**No. 52, Hwa Ya 1<sup>st</sup> Rd., Hwa Ya Technology Park, Kwei-Shan District, Tao Yuan City, Taiwan, R.O.C.**

**SPORTON INTERNATIONAL INC.**

TEL : 886-3-327-3456

FAX : 886-3-328-4978

FCC ID : B32C6803GBTW

Page Number : 1 of 39

Report Issued Date : Oct. 24, 2016

Report Version : Rev. 01

Report Template No.: BU5-FR15CWL Version 1.3



# TABLE OF CONTENTS

**REVISION HISTORY ..... 3**

**SUMMARY OF TEST RESULT ..... 4**

**1 GENERAL DESCRIPTION ..... 5**

    1.1 Applicant ..... 5

    1.2 Manufacturer ..... 5

    1.3 Product Feature of Equipment Under Test ..... 5

    1.4 Product Specification of Equipment Under Test ..... 6

    1.5 Modification of EUT ..... 7

    1.6 Testing Location ..... 7

    1.7 Applicable Standards ..... 8

**2 TEST CONFIGURATION OF EQUIPMENT UNDER TEST ..... 9**

    2.1 Carrier Frequency and Channel ..... 9

    2.2 Test Mode ..... 10

    2.3 Connection Diagram of Test System ..... 11

    2.4 Support Unit used in test configuration and system ..... 12

    2.5 EUT Operation Test Setup ..... 12

    2.6 Measurement Results Explanation Example ..... 13

**3 TEST RESULT ..... 14**

    3.1 6dB and 99% Bandwidth Measurement ..... 14

    3.2 Output Power Measurement ..... 16

    3.3 Power Spectral Density Measurement ..... 17

    3.4 Conducted Band Edges and Spurious Emission Measurement ..... 19

    3.5 Radiated Band Edges and Spurious Emission Measurement ..... 29

    3.6 AC Conducted Emission Measurement ..... 33

    3.7 Antenna Requirements ..... 37

**4 LIST OF MEASURING EQUIPMENT ..... 38**

**5 UNCERTAINTY OF EVALUATION ..... 39**

**APPENDIX A. CONDUCTED TEST RESULTS**

**APPENDIX B. RADIATED SPURIOUS EMISSION**

**APPENDIX C. RADIATED SPURIOUS EMISSION PLOTS**

**APPENDIX D. DUTY CYCLE PLOTS**

**APPENDIX E. SETUP PHOTOGRAPHS**



### REVISION HISTORY

REPORT NO.	VERSION	DESCRIPTION	ISSUED DATE
FR692114C	Rev. 01	Initial issue of report	Oct. 24, 2016



### SUMMARY OF TEST RESULT

Report Section	FCC Rule	Description	Limit	Result	Remark
3.1	15.247(a)(2)	6dB Bandwidth	$\geq 0.5\text{MHz}$	Pass	-
3.1	-	99% Bandwidth	-	Pass	-
3.2	15.247(b)	Power Output Measurement	$\leq 30\text{dBm}$	Pass	-
3.3	15.247(e)	Power Spectral Density	$\leq 8\text{dBm}/3\text{kHz}$	Pass	-
3.4	15.247(d)	Conducted Band Edges	$\leq 20\text{dBc}$	Pass	-
		Conducted Spurious Emission		Pass	-
3.5	15.247(d)	Radiated Band Edges and Radiated Spurious Emission	15.209(a) & 15.247(d)	Pass	Under limit 5.70 dB at 2483.960 MHz
3.6	15.207	AC Conducted Emission	15.207(a)	Pass	Under limit 19.30 dB at 0.518 MHz
3.7	15.203 & 15.247(b)	Antenna Requirement	N/A	Pass	-



# 1 General Description

## 1.1 Applicant

**Verifone, Inc.**

1400 West Stanford Ranch Road, Suite 100, 150 & 200, Rocklin CA 95765 USA

## 1.2 Manufacturer

**Inventec Appliances (Pudong) Corporation**

Building 1 - 3, No. 789 Pu Xing Road, Caohejing Export Processing Zone, Shanghai, P.R.C.

## 1.3 Product Feature of Equipment Under Test

Product Feature	
<b>Equipment</b>	Point of Sales Terminal
<b>Brand Name</b>	Verifone
<b>Model Name</b>	C680 3G-BT-WiFi
<b>FCC ID</b>	B32C6803GBTW
<b>EUT supports Radios application</b>	GSM/EGPRS/WCDMA/HSPA/RFID WLAN 11b/g/n HT20 WLAN 11a/n HT20/HT40 Bluetooth BR/EDR/LE
<b>EUT Stage</b>	Identical Prototype

**Remark:** The above EUT's information was declared by manufacturer. Please refer to the specifications or user's manual for more detailed description.



Specification of Accessory		
AC Adapter 1	Brand Name	Verifone, Inc.
	Manufacturer	Elementech
	Model Name	A111-3050223U
	Power Rating	Input : 100-240 V AC 50/60Hz, 0.5A Output: 5.0V DC 2.2A
	Power Cord	1.8meter, non-shielded cable, without ferrite core
AC Adapter 2	Brand Name	Verifone, Inc.
	Manufacturer	PHIHONG
	Model Name	AM11A-050A-R
	Power Rating	Input : 100-240 V AC 50/60Hz, 0.5A Output: 5.0V DC 2.2A
	Power Cord	1.8meter, non-shielded cable, without ferrite core
Battery 1	Brand Name	Verifone, Inc.
	Manufacturer	Palladium Energy Inc.
	Model Name	BPK260-001
Battery 2	Brand Name	Verifone, Inc.
	Manufacturer	Panasonic Corporation
	Model Name	BPK260-001

### 1.4 Product Specification of Equipment Under Test

Standards-related Product Specification	
Tx/Rx Channel Frequency Range	2412 MHz ~ 2462 MHz
Maximum (Peak) Output Power to antenna	802.11b : 12.50 dBm (0.0178 W) 802.11g : 20.77 dBm (0.1194 W) 802.11n HT20 : 20.66 dBm (0.1164 W)
99% Occupied Bandwidth	802.11b : 12.25MHz 802.11g : 17.15MHz 802.11n HT20 : 18.00MHz
Antenna Type / Gain	PIFA Antenna type with gain 2.96 dBi
Type of Modulation	802.11b : DSSS (DBPSK / DQPSK / CCK) 802.11g/n : OFDM (BPSK / QPSK / 16QAM / 64QAM)



### 1.5 Modification of EUT

No modifications are made to the EUT during all test items.

### 1.6 Testing Location

Sporton Lab is accredited to ISO 17025 by Taiwan Accreditation Foundation (TAF code : 1190) and the FCC designation No. TW1022 under the FCC 2.948(e) by Mutual Recognition Agreement (MRA) in FCC Test.

<b>Test Site</b>	SPORTON INTERNATIONAL INC.	
<b>Test Site Location</b>	No. 52, Hwa Ya 1 <sup>st</sup> Rd., Hwa Ya Technology Park, Kwei-Shan District, Tao Yuan City, Taiwan, R.O.C. TEL: +886-3-327-3456 FAX: +886-3-328-4978	
<b>Test Site No.</b>	<b>Sporton Site No.</b>	
	TH05-HY	CO05-HY

**Note:** The test site complies with ANSI C63.4 2014 requirement.

<b>Test Site</b>	SPORTON INTERNATIONAL INC.	
<b>Test Site Location</b>	No.58, Aly. 75, Ln. 564, Wenhua 3rd Rd. Guishan Dist, Taoyuan City, Taiwan (R.O.C.) TEL: +886-3-327-0868 FAX: +886-3-327-0855	
<b>Test Site No.</b>	<b>Sporton Site No.</b>	
	03CH11-HY	

**Note:** The test site complies with ANSI C63.4 2014 requirement.



## 1.7 Applicable Standards

According to the specifications of the manufacturer, the EUT must comply with the requirements of the following standards:

- ♦ FCC Part 15 Subpart C §15.247
- ♦ FCC KDB Publication No. 558074 D01 DTS Meas. Guidance v03r05
- ♦ ANSI C63.10-2013

### **Remark:**

1. All test items were verified and recorded according to the standards and without any deviation during the test.
2. This EUT has also been tested and complied with the requirements of FCC Part 15, Subpart B, recorded in a separate test report.





## 2 Test Configuration of Equipment Under Test

The EUT has been associated with peripherals and configuration operated in a manner tended to maximize its emission characteristics in a typical application. Frequency range investigated: conducted emission (150 kHz to 30 MHz) and radiated emission (9 kHz to the 10th harmonic of the highest fundamental frequency or to 40 GHz, whichever is lower). For radiated measurement, pre-scanned in three orthogonal panels, X, Y, Z. The worst cases (Z plane) were recorded in this report.

### 2.1 Carrier Frequency and Channel

Frequency Band	Channel	Freq. (MHz)	Channel	Freq. (MHz)
2400-2483.5 MHz	1	2412	7	2442
	2	2417	8	2447
	3	2422	9	2452
	4	2427	10	2457
	5	2432	11	2462
	6	2437	-	-



## 2.2 Test Mode

Final test mode of conducted test items and radiated spurious emissions are considering the modulation and worse data rates as below table.

Modulation	Data Rate
802.11b	1 Mbps
802.11g	6 Mbps
802.11n HT20	MCS0

Test Cases	
<b>AC Conducted Emission</b>	Mode 1 : GSM1900 Idle + Bluetooth Link + Smart Card Reader + Magnetic Card Reader + RFID Tx + Battery 1 + Charging from Adapter 1 + RS-232/4-Pin Cable (Load) + RS-232/RJ11 Cable (Load) + Printer + SAM Card + Micro SD Card + Primary Micro-USB Port (Cable Load) + Secondary Micro-USB Port (Data Link with USB Storage Device) Mode 2 : GSM1900 Idle + WLAN (2.4GHz) Link + Smart Card Reader + Magnetic Card Reader + RFID Tx + Battery 1 + Charging from Adapter 1 + RS-232/4-Pin Cable (Load) + RS-232/RJ11 Cable (Load) + Printer + SAM Card + Micro SD Card + Primary Micro-USB Port (Cable Load) + Secondary Micro-USB Port (Data Link with USB Storage Device)
<b>Remark:</b> 1. The worst case of conducted emission is mode 1; only the test data of it was reported. 2. All the Radiated test items were performed with Adapter 1 and Battery 1.	

## 2.3 Connection Diagram of Test System

<WLAN Tx Mode>

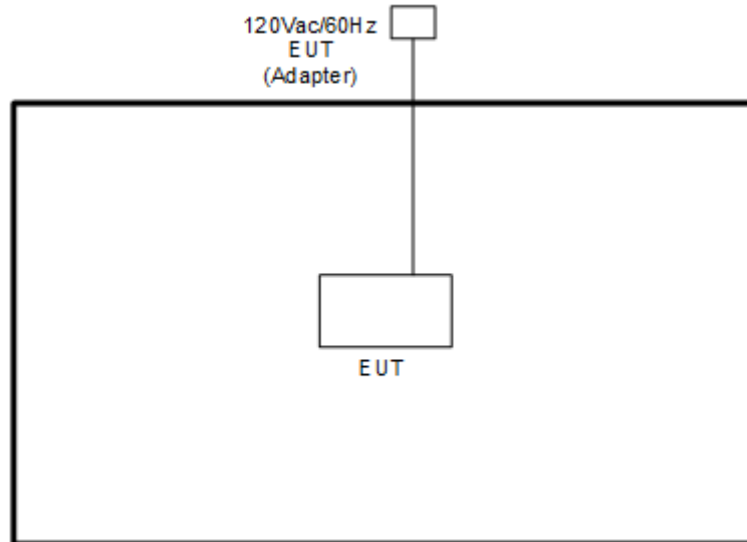

<EUT in Bluetooth Mode>

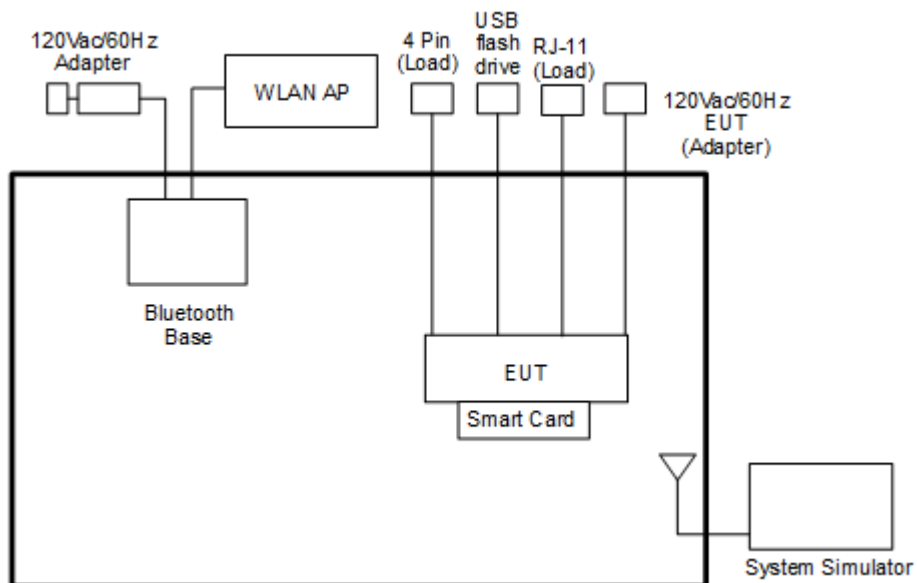

<EUT in WLAN Mode>

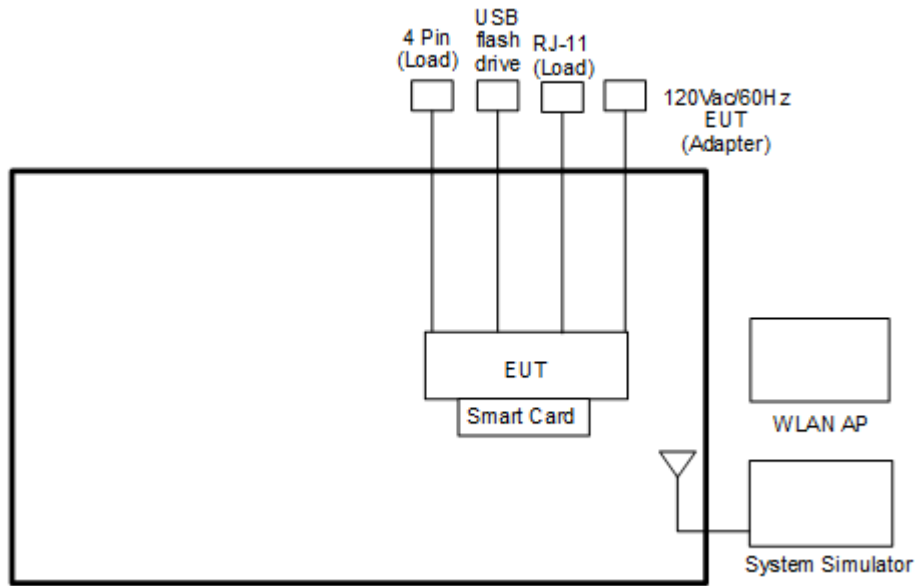

## 2.4 Support Unit used in test configuration and system

Item	Equipment	Trade Name	Model Name	FCC ID	Data Cable	Power Cord
1.	System Simulator	Anritsu	MT8820C	N/A	N/A	Unshielded, 1.8 m
2.	WLAN AP	ASUS	RT-AC66U	MSQ-RTAC66U	N/A	Unshielded, 1.8 m
3.	Bluetooth Base	VariFone	VX680-B-BTC	B32VX680-B-BTC	N/A	N/A
4.	SD Card	SanDisk	MicroSD HC	FCC DoC	N/A	N/A
5.	USB flash drive	Transcend	N/A	N/A	N/A	N/A
6.	Smart Card	N/A	N/A	N/A	N/A	N/A

## 2.5 EUT Operation Test Setup

The programmed RF utility installed in EUT to provide channel selection, power level, data rate and the application type. RF Utility can send transmitting signal for all testing. The RF output power selection is for the setting of RF output power expected by the customer and is going to be fixed on the firmware of the final end product.



## 2.6 Measurement Results Explanation Example

For all conducted test items:

The offset level is set in the spectrum analyzer to compensate the RF cable loss and attenuator factor between EUT conducted output port and spectrum analyzer. With the offset compensation, the spectrum analyzer reading level is exactly the EUT RF output level.

Example :

The spectrum analyzer offset is derived from RF cable loss and attenuator factor.

*Offset = RF cable loss + attenuator factor.*

Following shows an offset computation example with cable loss 4.2 dB and 10dB attenuator.

$$\begin{aligned} \text{Offset(dB)} &= \text{RF cable loss(dB)} + \text{attenuator factor(dB)}. \\ &= 4.2 + 10 = 14.2 \text{ (dB)} \end{aligned}$$

### 3 Test Result

#### 3.1 6dB and 99% Bandwidth Measurement

##### 3.1.1 Limit of 6dB and 99% Bandwidth

The minimum 6 dB bandwidth shall be at least 500 kHz.

##### 3.1.2 Measuring Instruments

The measuring equipment is listed in the section 4 of this test report.

##### 3.1.3 Test Procedures

1. The testing follows FCC KDB Publication No. 558074 DTS D01 Meas. Guidance v03r05.
2. The RF output of EUT was connected to the spectrum analyzer by RF cable and attenuator. The path loss was compensated to the results for each measurement.
3. Set to the maximum power setting and enable the EUT transmit continuously.
4. Make the measurement with the spectrum analyzer's resolution bandwidth (RBW) = 100 kHz. Set the Video bandwidth (VBW) = 300 kHz. In order to make an accurate measurement. The 6 dB bandwidth must be greater than 500 kHz.
5. For 99% Bandwidth Measurement, the spectrum analyzer's resolution bandwidth (RBW) = 1MHz and set the Video bandwidth (VBW) = 3MHz.
6. Measure and record the results in the test report.

##### 3.1.4 Test Setup





### 3.1.5 Test Result of 6dB and 99% Occupied Bandwidth

Please refer to Appendix A.

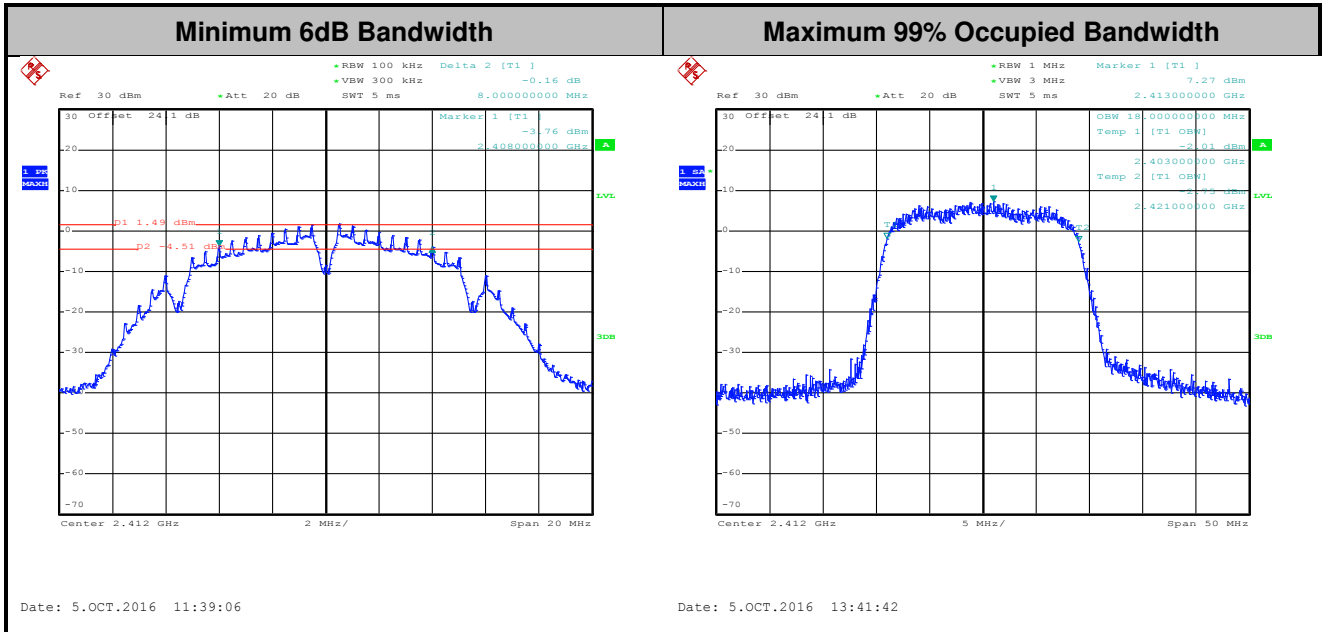

Note : The occupied channel bandwidth is maintained within the band of operation for all of the modulations.

## 3.2 Output Power Measurement

### 3.2.1 Limit of Output Power

For systems using digital modulation in the 2400-2483.5MHz, the limit for peak output power is 30dBm. If transmitting antenna of directional gain greater than 6dBi are used the peak output power from the intentional radiator shall be reduced below the above stated value by the amount in dB that the directional gain of the antenna exceeds 6 dBi. In case of point-to-point operation, the limit has to be reduced by 1dB for every 3dB that the directional gain of the antenna exceeds 6dBi.

### 3.2.2 Measuring Instruments

The measuring equipment is listed in the section 4 of this test report.

### 3.2.3 Test Procedures

1. The testing follows the Measurement Procedure of FCC KDB No. 558074 DTS D01 Meas. Guidance v03r05 section 9.1.2 PKPM1 Peak power meter method.
2. The RF output of EUT was connected to the power meter by RF cable and attenuator. The path loss was compensated to the results for each measurement.
3. Set to the maximum power setting and enable the EUT transmit continuously.
4. Measure the conducted output power and record the results in the test report.

### 3.2.4 Test Setup

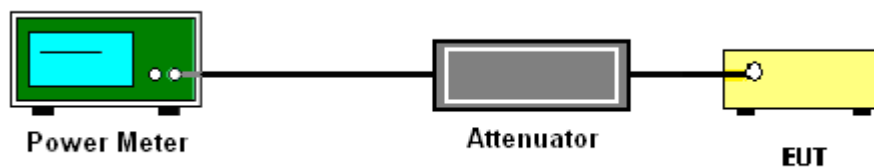

### 3.2.5 Test Result of Peak Output Power

Please refer to Appendix A.

### 3.2.6 Test Result of Average output Power (Reporting Only)

Please refer to Appendix A.



### 3.3 Power Spectral Density Measurement

#### 3.3.1 Limit of Power Spectral Density

The peak power spectral density shall not be greater than 8dBm in any 3kHz band at any time interval of continuous transmission.

#### 3.3.2 Measuring Instruments

The measuring equipment is listed in the section 4 of this test report.

#### 3.3.3 Test Procedures

1. The testing follows Measurement Procedure 10.2 Method PKPSD of FCC KDB Publication No. 558074 D01 DTS Meas. Guidance v03r05
2. The RF output of EUT was connected to the spectrum analyzer by RF cable and attenuator. The path loss was compensated to the results for each measurement.
3. Set to the maximum power setting and enable the EUT transmit continuously.
4. Make the measurement with the spectrum analyzer's resolution bandwidth (RBW) = 3 kHz. Video bandwidth VBW = 10 kHz In order to make an accurate measurement, set the span to 1.5 times DTS Channel Bandwidth. (6dB BW)
5. Detector = peak, Sweep time = auto couple, Trace mode = max hold, Allow trace to fully stabilize. Use the peak marker function to determine the maximum power level.
6. Measure and record the results in the test report.

#### 3.3.4 Test Setup

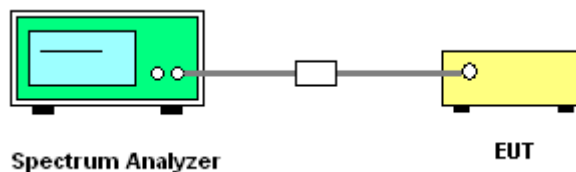



### 3.3.5 Test Result of Power Spectral Density

Please refer to Appendix A.

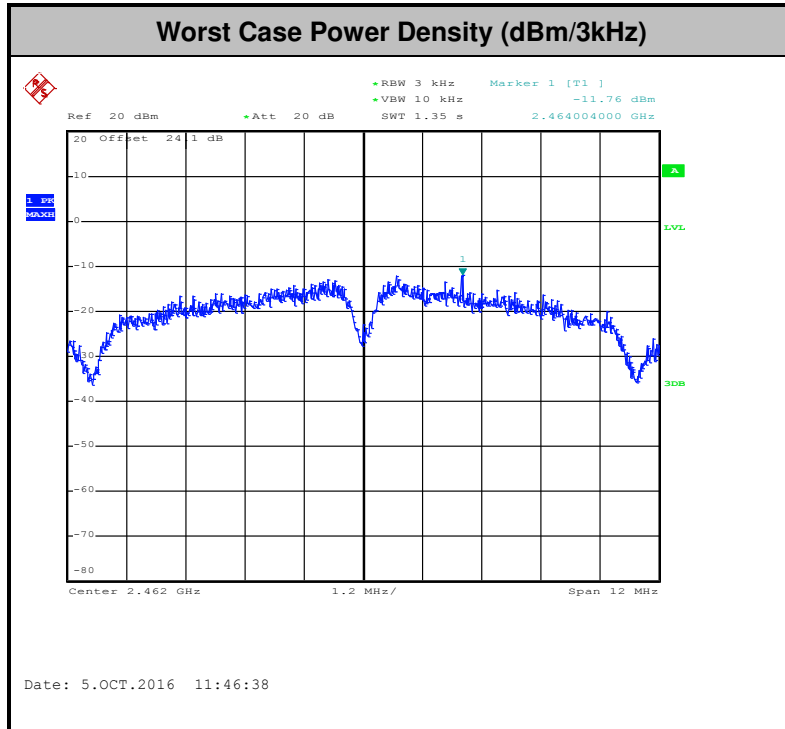

## 3.4 Conducted Band Edges and Spurious Emission Measurement

### 3.4.1 Limit of Conducted Band Edges and Spurious Emission Measurement

In any 100 kHz bandwidth outside of the authorized frequency band, the emissions which fall in the non-restricted bands shall be attenuated at least 20 dB / 30dB relative to the maximum PSD level in 100 kHz by RF conducted measurement and radiated emissions which fall in the restricted bands, as defined in Section 15.205(a), must also comply with the radiated emission limits specified in Section 15.209(a).

### 3.4.2 Measuring Instruments

The measuring equipment is listed in the section 4 of this test report.

### 3.4.3 Test Procedures

1. The testing follows FCC KDB Publication No. 558074 D01 DTS Meas. Guidance v03r05.
2. The RF output of EUT was connected to the spectrum analyzer by RF cable and attenuator. The path loss was compensated to the results for each measurement.
3. Set to the maximum power setting and enable the EUT transmit continuously.
4. Set RBW = 100 kHz, VBW=300 kHz, Peak Detector. Unwanted Emissions measured in any 100 kHz bandwidth outside of the authorized frequency band shall be attenuated by at least 20 dB relative to the maximum in-band peak PSD level in 100 kHz when maximum peak conducted output power procedure is used. If the transmitter complies with the conducted power limits based on the use of RMS averaging over a time interval, the attenuation required under this paragraph shall be 30 dB instead of 20 dB per 15.247(d).
5. Measure and record the results in the test report.
6. The RF fundamental frequency should be excluded against the limit line in the operating frequency band.

### 3.4.4 Test Setup

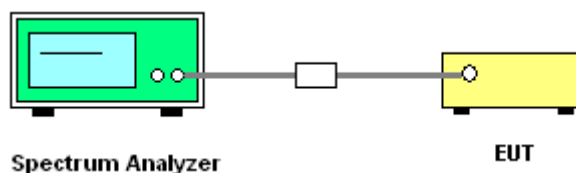



### 3.4.5 Test Result of Conducted Band Edges and Spurious Emission

Test Mode :	802.11b	Temperature :	21~25°C
Test Band :	2.4GHz Low	Relative Humidity :	51~54%
Test Channel :	01	Test Engineer :	AC Chang

#### WLAN 802.11b Channel 01

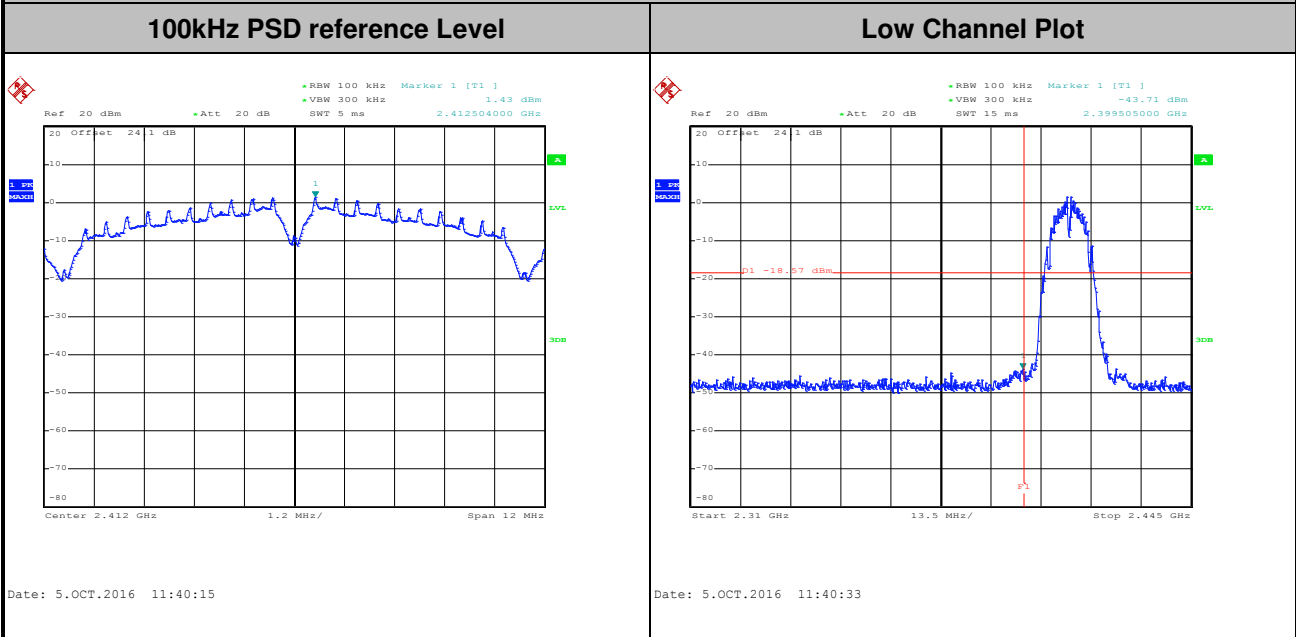

#### Spurious Emission 30MHz~3GHz      Spurious Emission 2GHz~25GHz

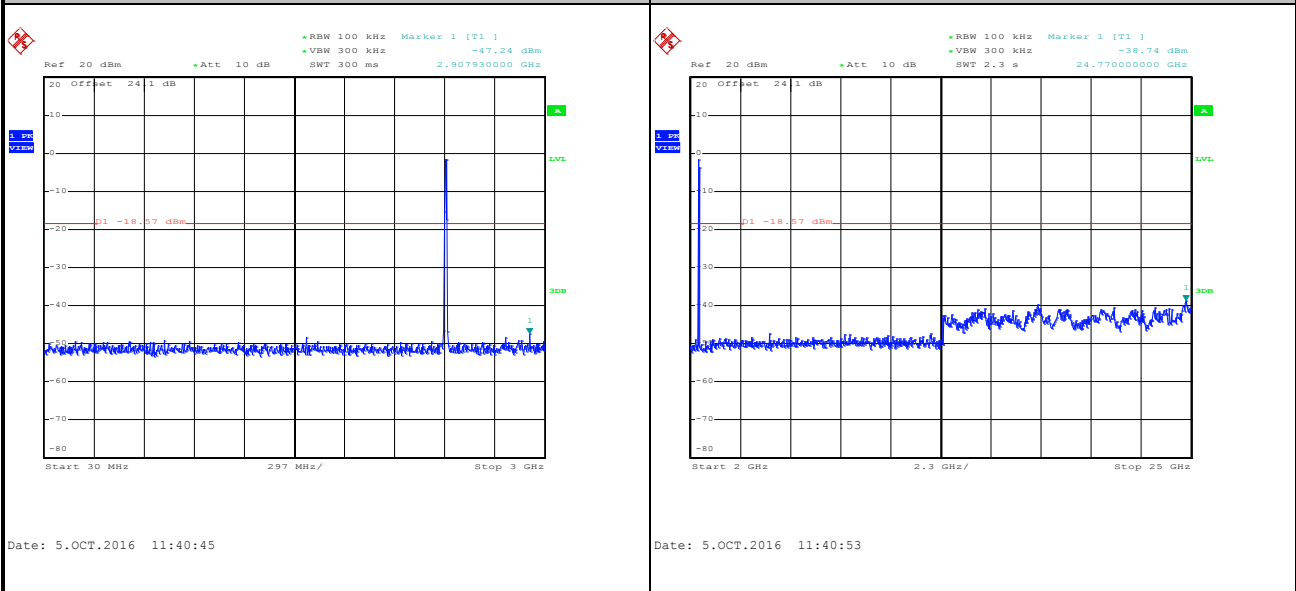



Test Mode :	802.11b	Temperature :	21~25°C
Test Band :	2.4GHz Mid	Relative Humidity :	51~54%
Test Channel :	06	Test Engineer :	AC Chang

WLAN 802.11b Channel 06

100kHz PSD reference Level

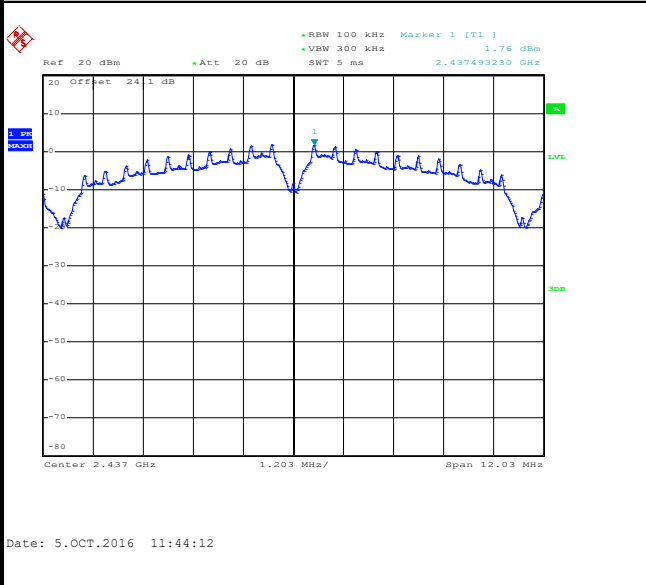

Spurious Emission 30MHz~3GHz

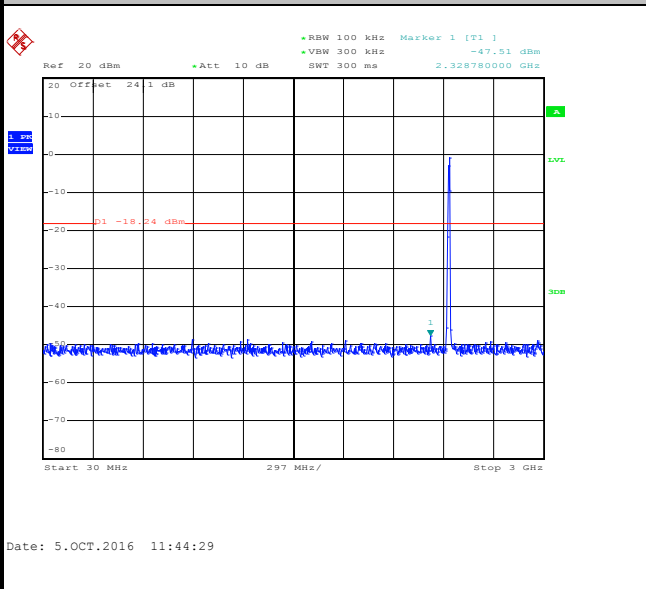

Spurious Emission 2GHz~25GHz

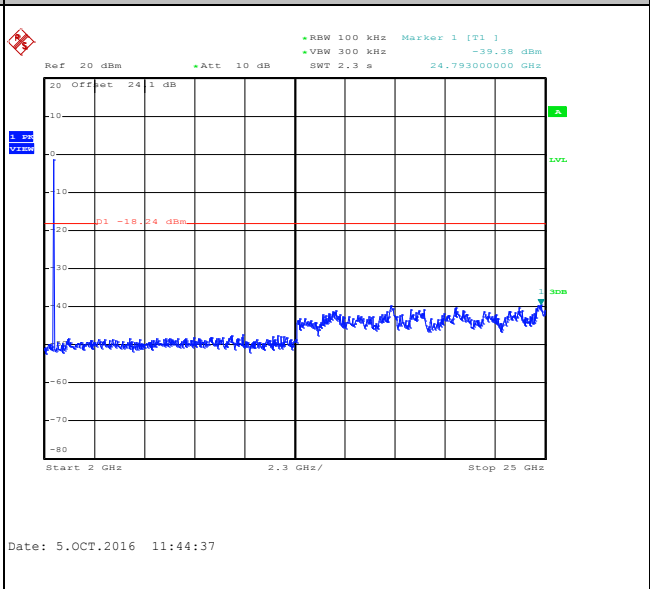



Test Mode :	802.11b	Temperature :	21~25°C
Test Band :	2.4GHz High	Relative Humidity :	51~54%
Test Channel :	11	Test Engineer :	AC Chang

WLAN 802.11b Channel 11

100kHz PSD reference Level

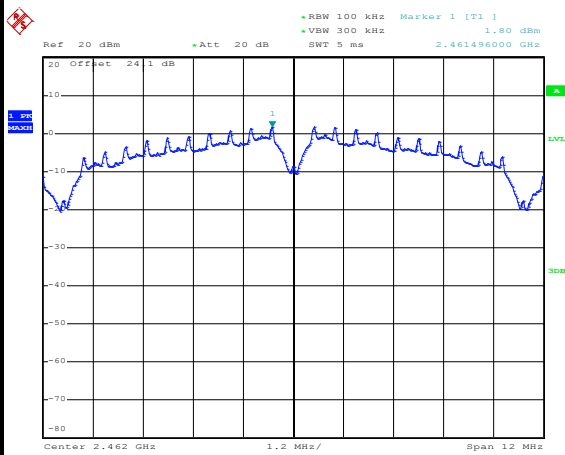

Date: 5.OCT.2016 11:47:11

High Channel Plot

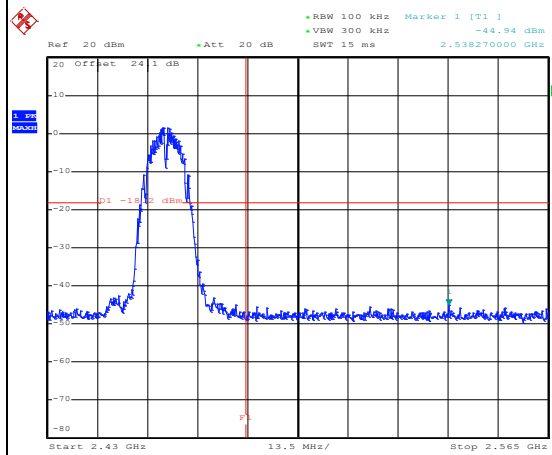

Date: 5.OCT.2016 11:48:10

Spurious Emission 30MHz~3GHz

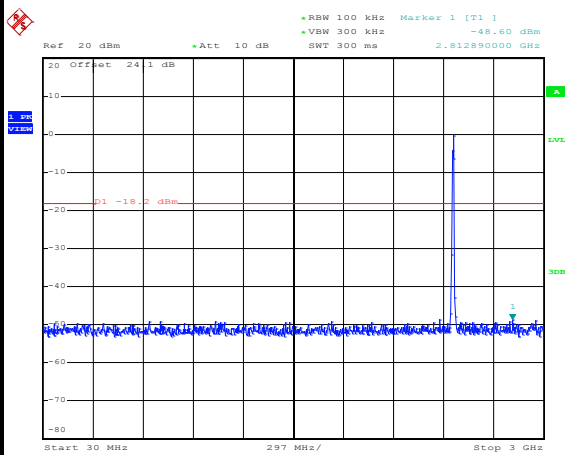

Date: 5.OCT.2016 11:48:52

Spurious Emission 2GHz~25GHz

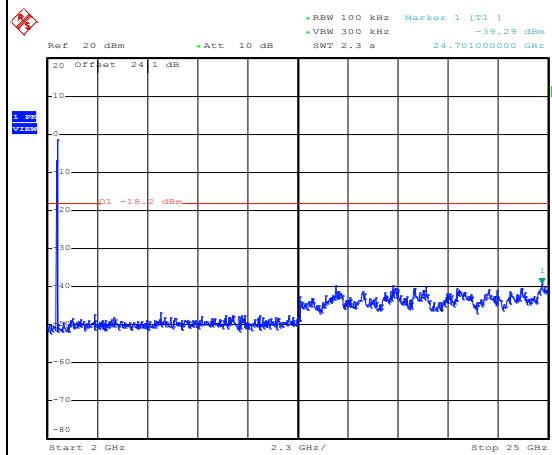

Date: 5.OCT.2016 11:49:00



Test Mode :	802.11g	Temperature :	21~25°C
Test Band :	2.4GHz Low	Relative Humidity :	51~54%
Test Channel :	01	Test Engineer :	AC Chang

WLAN 802.11g Channel 01

100kHz PSD reference Level

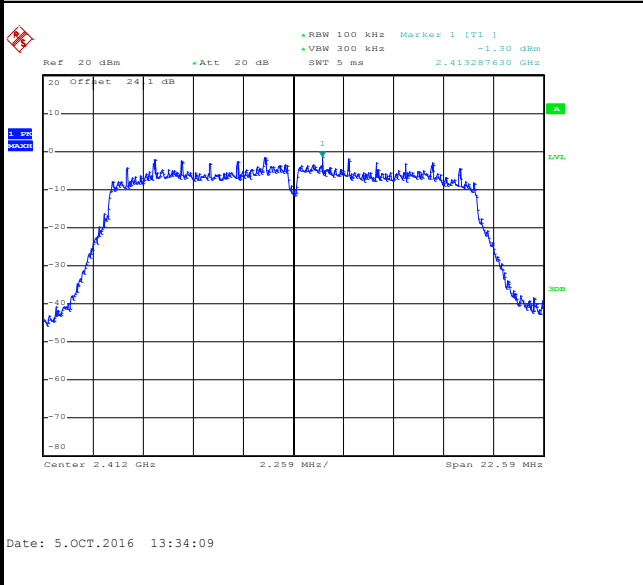

Low Channel Plot

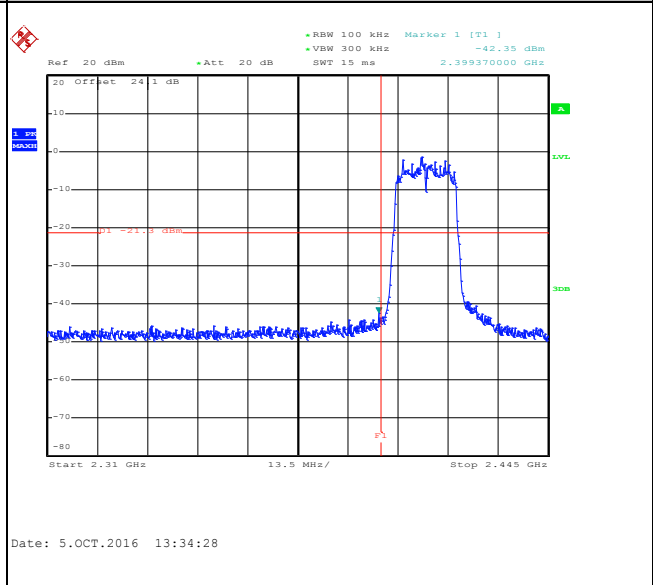

Spurious Emission 30MHz~3GHz

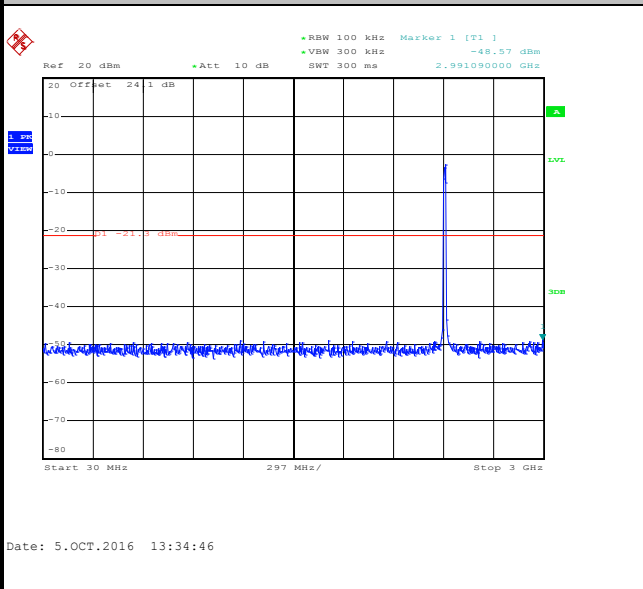

Spurious Emission 2GHz~25GHz

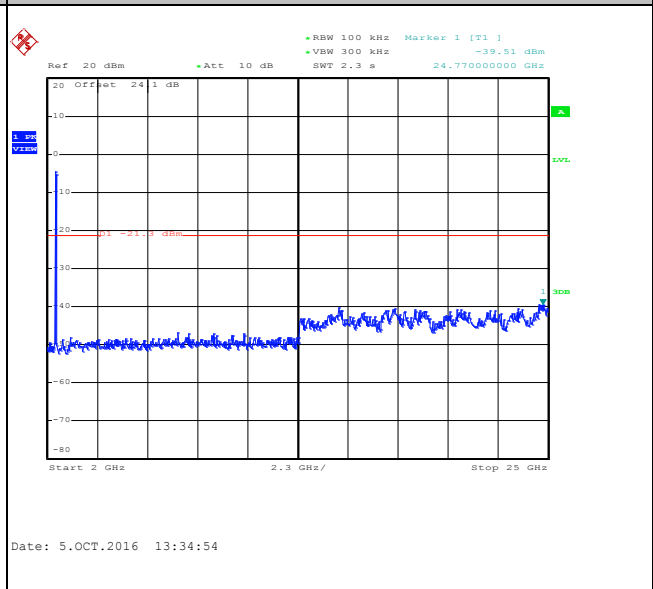



Test Mode :	802.11g	Temperature :	21~25°C
Test Band :	2.4GHz Mid	Relative Humidity :	51~54%
Test Channel :	06	Test Engineer :	AC Chang

WLAN 802.11g Channel 06

100kHz PSD reference Level

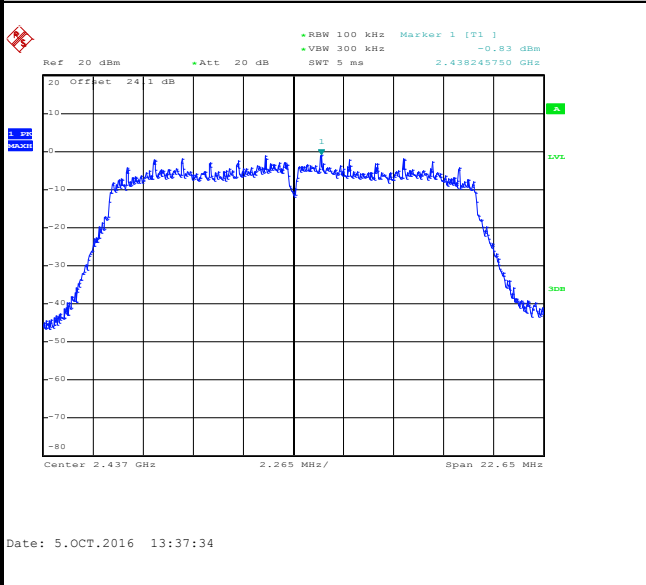

Spurious Emission 30MHz~3GHz

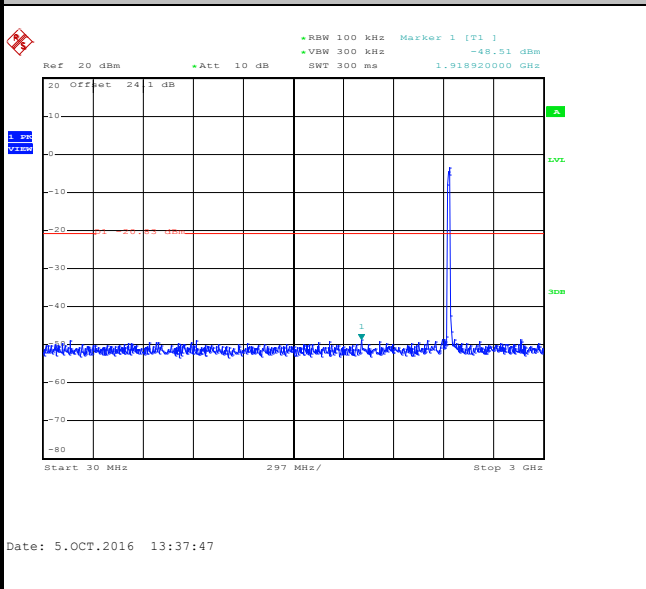

Spurious Emission 2GHz~25GHz

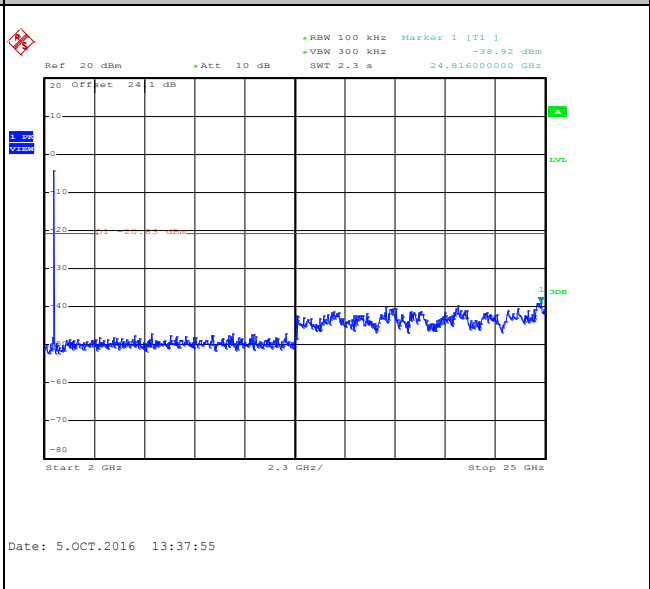





Test Mode :	802.11g	Temperature :	21~25°C
Test Band :	2.4GHz High	Relative Humidity :	51~54%
Test Channel :	11	Test Engineer :	AC Chang

WLAN 802.11g Channel 11

100kHz PSD reference Level

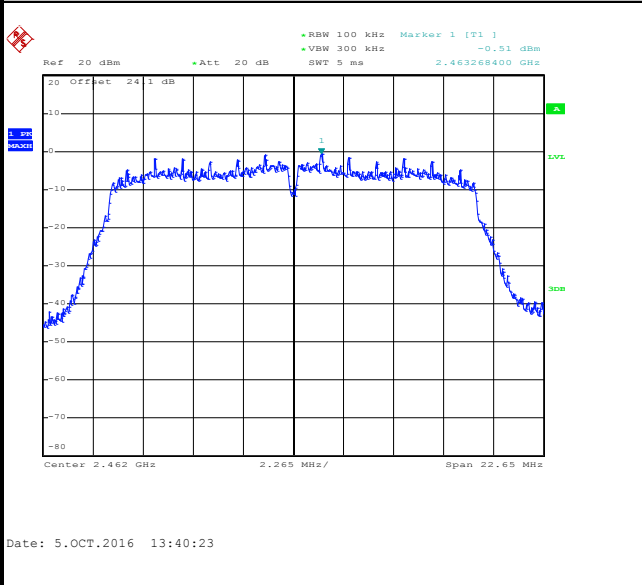

High Channel Plot

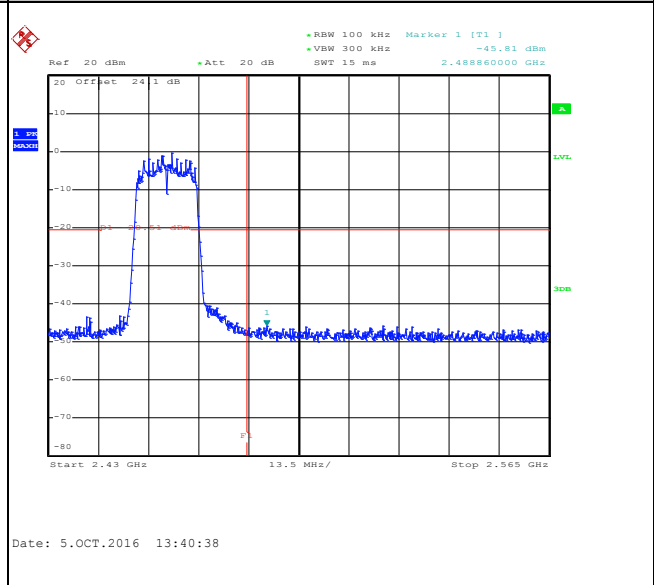

Spurious Emission 30MHz~3GHz

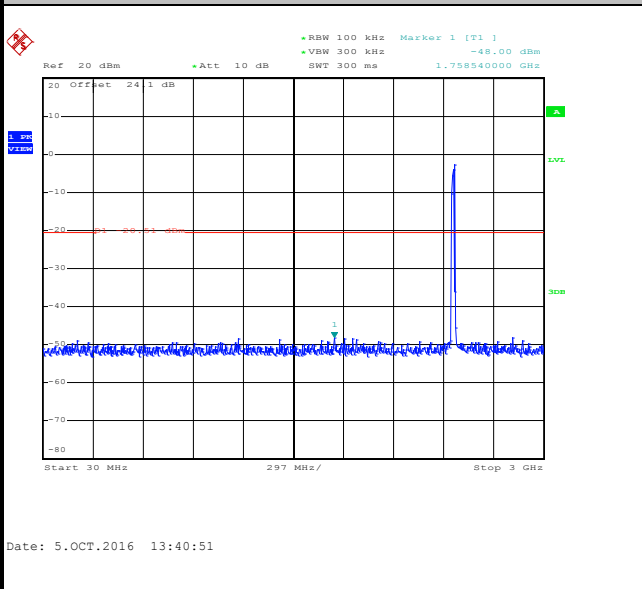

Spurious Emission 2GHz~25GHz

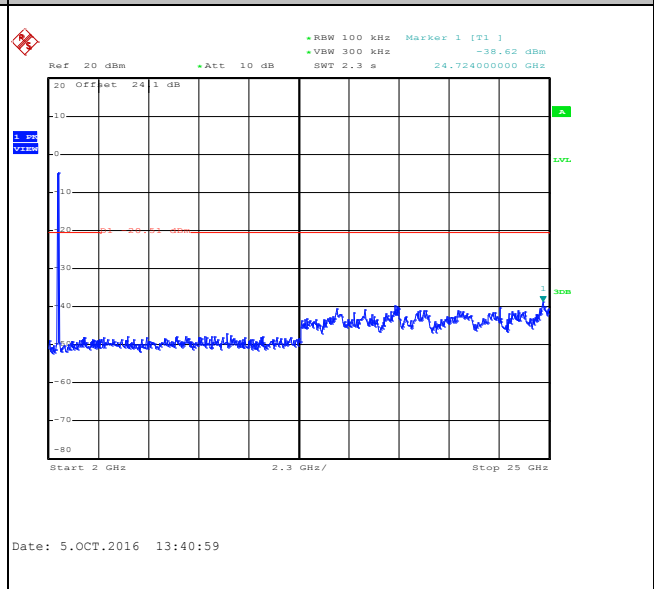



Test Mode :	802.11n HT20	Temperature :	21~25°C
Test Band :	2.4GHz Low	Relative Humidity :	51~54%
Test Channel :	01	Test Engineer :	AC Chang

WLAN 802.11n HT20 Channel 01

100kHz PSD reference Level

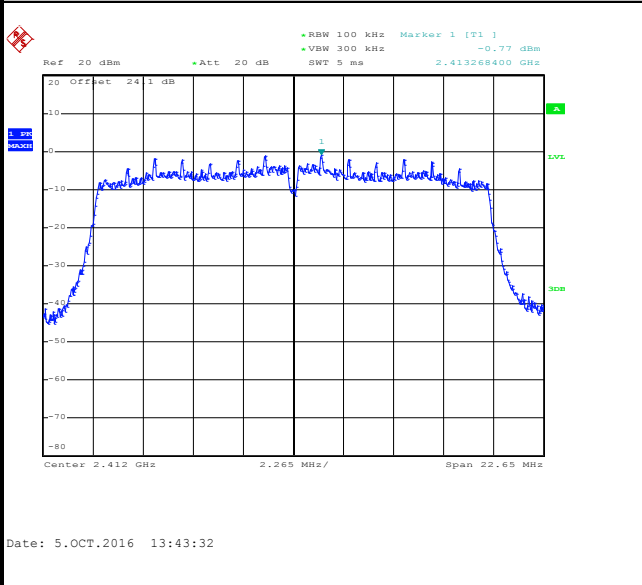

Low Channel Plot

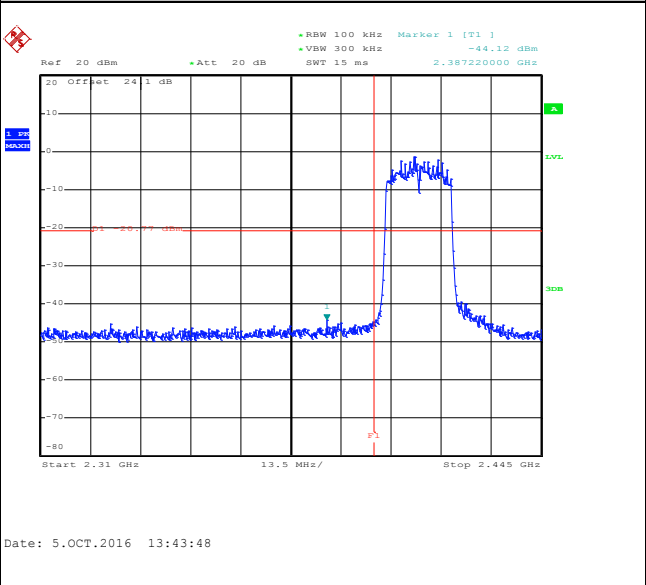

Spurious Emission 30MHz~3GHz

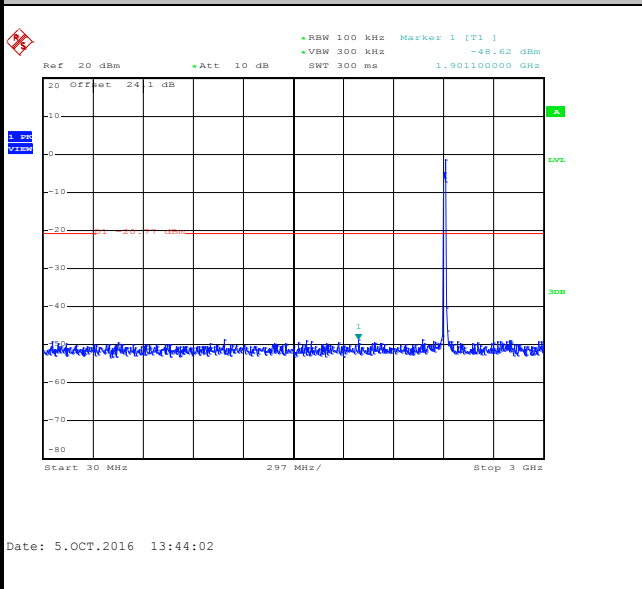

Spurious Emission 2GHz~25GHz

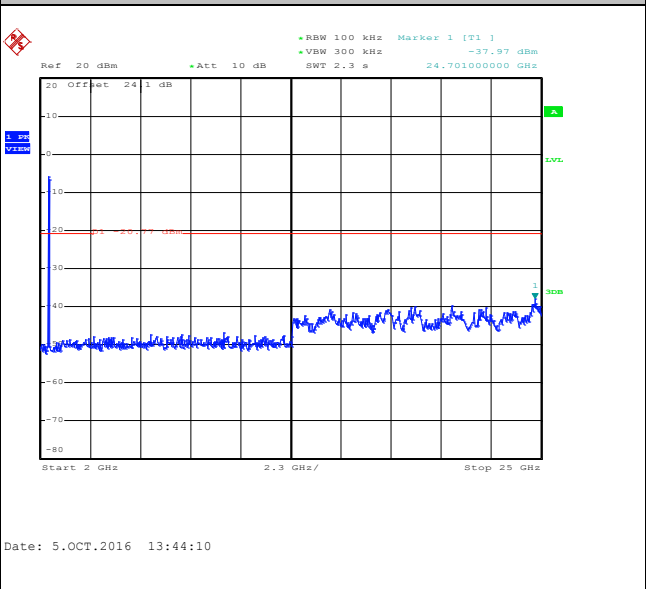



Test Mode :	802.11n HT20	Temperature :	21~25°C
Test Band :	2.4GHz Mid	Relative Humidity :	51~54%
Test Channel :	06	Test Engineer :	AC Chang

WLAN 802.11n HT20 Channel 06

100kHz PSD reference Level

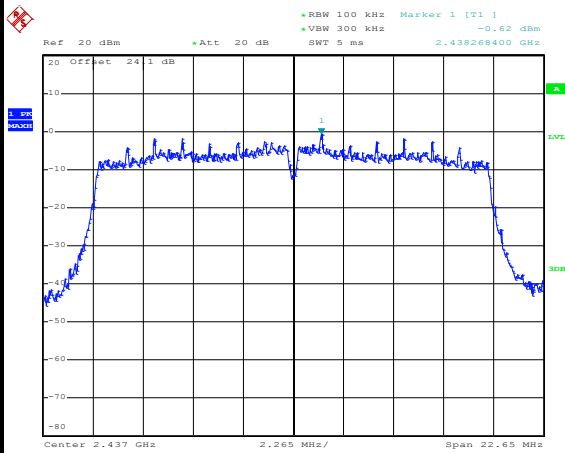

Date: 5.OCT.2016 13:46:34

Spurious Emission 30MHz~3GHz

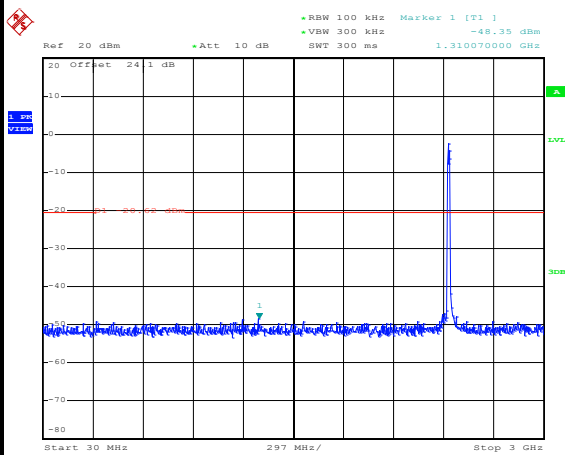

Date: 5.OCT.2016 13:46:56

Spurious Emission 2GHz~25GHz

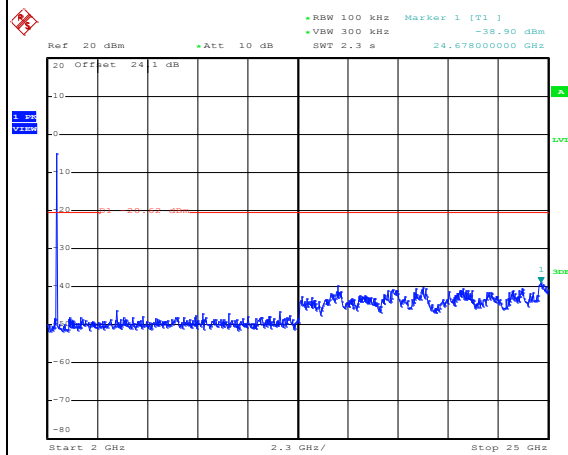

Date: 5.OCT.2016 13:47:05



Test Mode :	802.11n HT20	Temperature :	21~25°C
Test Band :	2.4GHz High	Relative Humidity :	51~54%
Test Channel :	11	Test Engineer :	AC Chang

WLAN 802.11n HT20 Channel 11

100kHz PSD reference Level

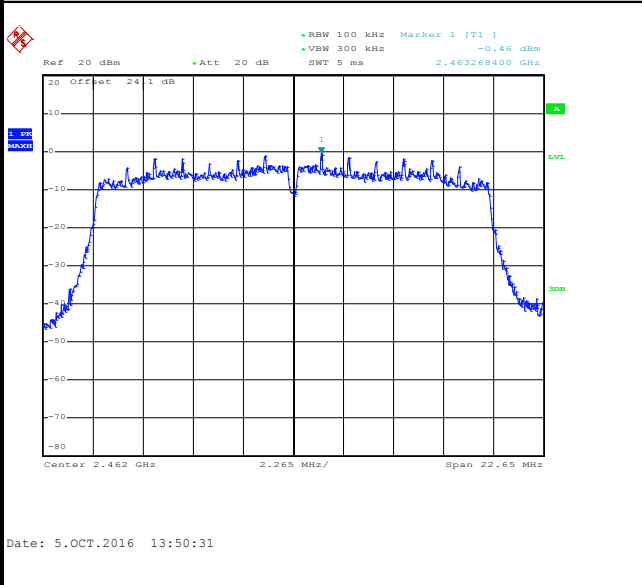

High Channel Plot

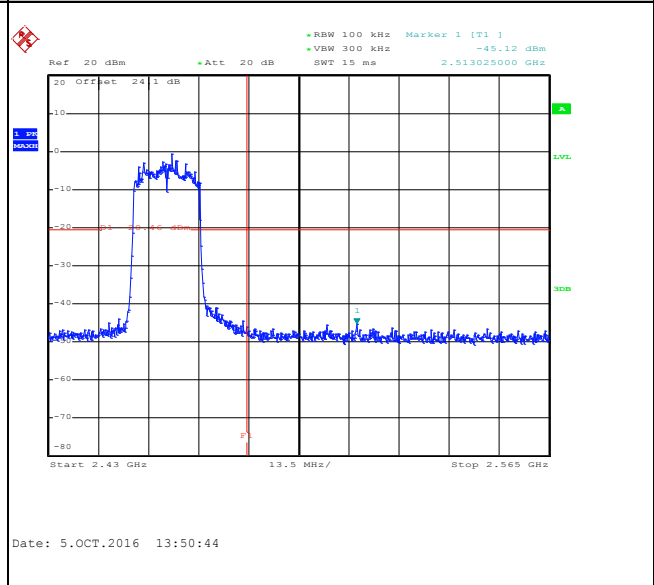

Spurious Emission 30MHz~3GHz

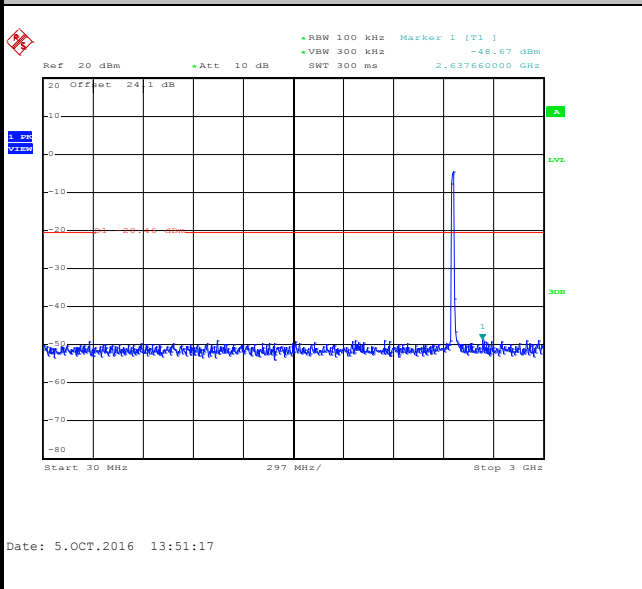

Spurious Emission 2GHz~25GHz

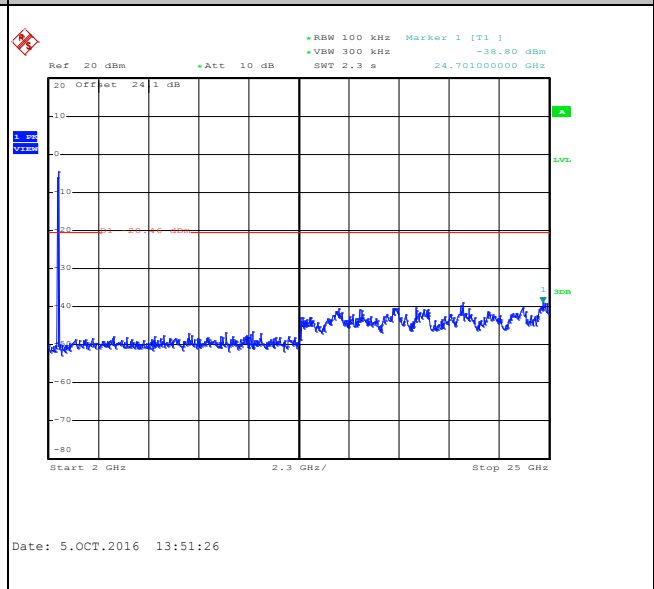



### 3.5 Radiated Band Edges and Spurious Emission Measurement

#### 3.5.1 Limit of Radiated band edge and Spurious Emission Measurement

In any 100 kHz bandwidth outside the intentional radiator frequency band, all harmonics/spurious must be at least 20 dB below the highest emission level within the authorized band. If the output power of this device was measured by spectrum analyzer, the attenuation under this paragraph shall be 30 dB instead of 20 dB. In addition, radiated emissions which fall in the restricted bands must also comply with the FCC section 15.209 limits as below.

Frequency (MHz)	Field Strength (microvolts/meter)	Measurement Distance (meters)
0.009 – 0.490	2400/F(kHz)	300
0.490 – 1.705	24000/F(kHz)	30
1.705 – 30.0	30	30
30 – 88	100	3
88 – 216	150	3
216 - 960	200	3
Above 960	500	3

#### 3.5.2 Measuring Instruments

The measuring equipment is listed in the section 4 of this test report.



### 3.5.3 Test Procedures

1. The testing follows FCC KDB Publication No. 558074 D01 DTS Meas. Guidance v03r05.
2. The EUT was arranged to its worst case and then tune the antenna tower (from 1 m to 4 m) and turntable (from 0 degree to 360 degrees) to find the maximum reading. A pre-amp and a high pass filter are used for the test in order to get better signal level.
3. The EUT was placed on a turntable with 0.8 meter for frequency below 1GHz and 1.5 meter for frequency above 1GHz respectively above ground.
4. The EUT was set 3 meters from the interference receiving antenna, which was mounted on the top of a variable height antenna tower.
5. Corrected Reading: Antenna Factor + Cable Loss + Read Level - Preamp Factor = Level
6. For measurement below 1GHz, If the emission level of the EUT measured by the peak detector is 3 dB lower than the applicable limit, the peak emission level will be reported. Otherwise, the emission measurement will be repeated using the quasi-peak detector and reported.
7. Use the following spectrum analyzer settings:
  - (1) Span shall wide enough to fully capture the emission being measured;
  - (2) Set RBW=100 kHz for  $f < 1$  GHz; VBW  $\geq$  RBW; Sweep = auto; Detector function = peak; Trace = max hold;
  - (3) Set RBW = 1 MHz, VBW= 3MHz for  $f \geq 1$  GHz for peak measurement.  
For average measurement:
    - VBW = 10 Hz, when duty cycle is no less than 98 percent.
    - VBW  $\geq 1/T$ , when duty cycle is less than 98 percent where T is the minimum transmission duration over which the transmitter is on and is transmitting at its maximum power control level for the tested mode of operation.

### 3.5.4 Test Setup

For radiated emissions below 30MHz

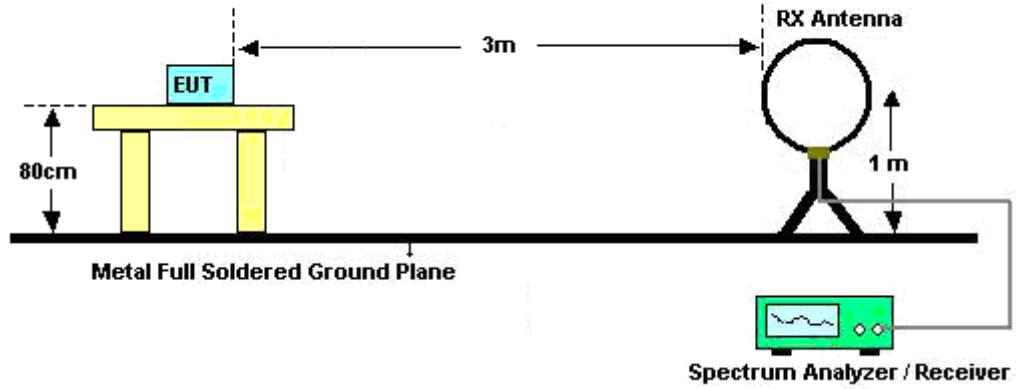

For radiated emissions from 30MHz to 1GHz

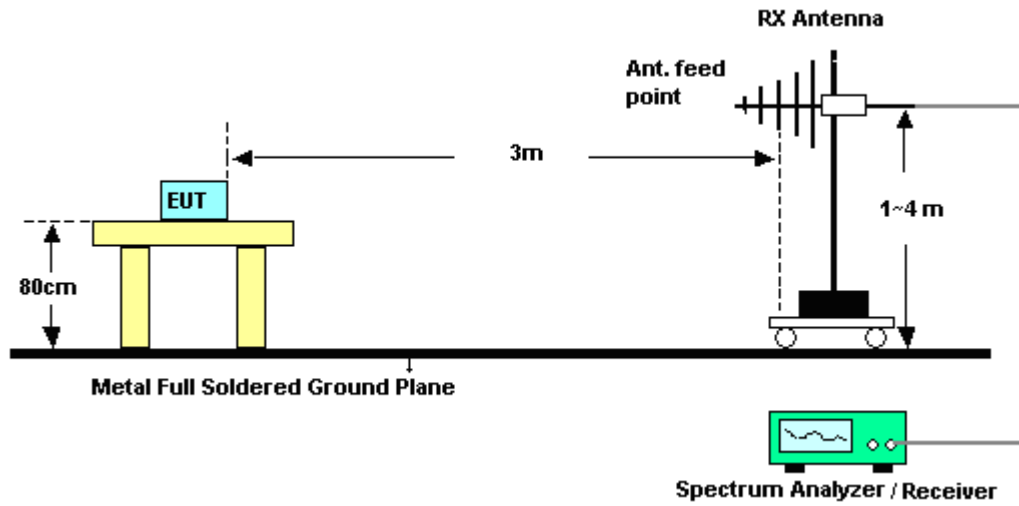

For radiated emissions above 1GHz

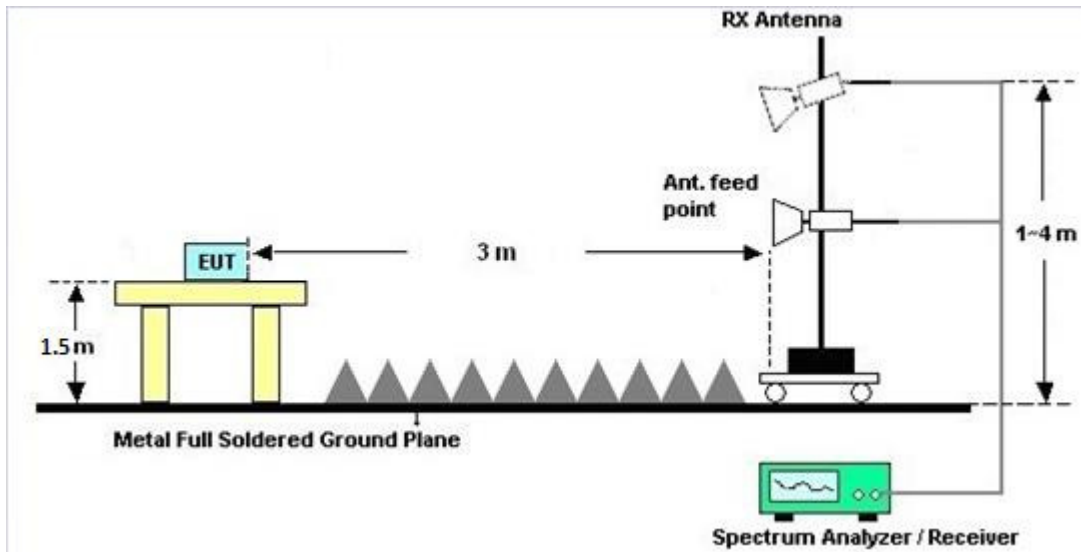

### 3.5.5 Test Results of Radiated Spurious Emissions (9kHz ~ 30MHz)

The low frequency, which started from 9 kHz to 30MHz, was pre-scanned and the result which was 20dB lower than the limit line per 15.31(o) was not reported.

### 3.5.6 Test Result of Radiated Spurious at Band Edges

Please refer to Appendix B and C.

### 3.5.7 Duty Cycle

Please refer to Appendix D.

### 3.5.8 Test Result of Radiated Spurious Emission (30MHz ~ 10<sup>th</sup> Harmonic)

Please refer to Appendix B and C.





### 3.6 AC Conducted Emission Measurement

#### 3.6.1 Limit of AC Conducted Emission

For equipment that is designed to be connected to the public utility (AC) power line, the radio frequency voltage that is conducted back onto the AC power line on any frequency or frequencies within the band 150 kHz to 30 MHz shall not exceed the limits in the following table.

Frequency of Emission (MHz)	Conducted Limit (dB $\mu$ V)	
	Quasi-Peak	Average
0.15-0.5	66 to 56*	56 to 46*
0.5-5	56	46
5-30	60	50

\*Decreases with the logarithm of the frequency.

#### 3.6.2 Measuring Instruments

The measuring equipment is listed in the section 4 of this test report.

#### 3.6.3 Test Procedures

1. The EUT was placed 0.4 meter from the conducting wall of the shielding room, and it was kept at least 80 centimeters from any other grounded conducting surface.
2. Connect EUT to the power mains through a line impedance stabilization network (LISN).
3. All the support units are connecting to the other LISN.
4. The LISN provides 50 ohm coupling impedance for the measuring instrument.
5. The FCC states that a 50 ohm, 50 microhenry LISN should be used.
6. Both sides of AC line were checked for maximum conducted interference.
7. The frequency range from 150 kHz to 30 MHz was searched.
8. Set the test-receiver system to Peak Detect Function and specified bandwidth (IF bandwidth = 9kHz) with Maximum Hold Mode.

### 3.6.4 Test Setup

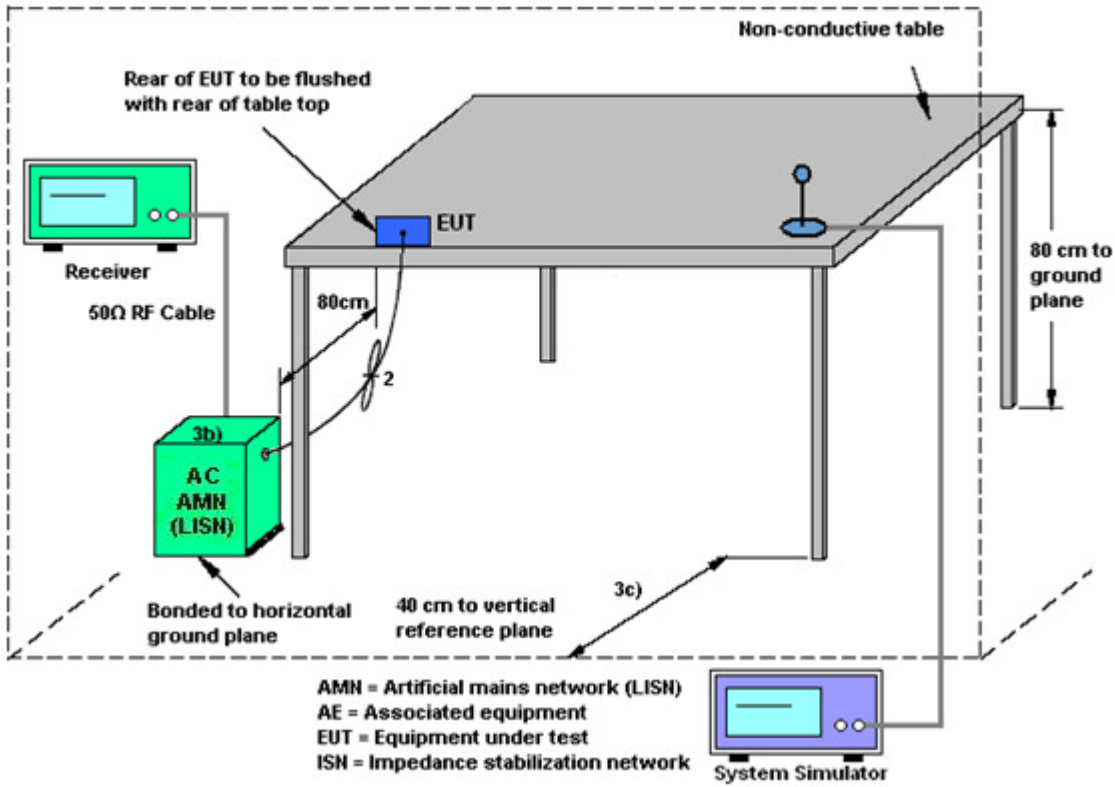



3.6.5 Test Result of AC Conducted Emission

Test Mode :	Mode 1	Temperature :	24~25°C
Test Engineer :	Kai-Chun Chu	Relative Humidity :	45~46%
Test Voltage :	120Vac / 60Hz	Phase :	Line
Function Type :	GSM1900 Idle + Bluetooth Link + Smart Card Reader + Magnetic Card Reader + RFID Tx + Battery 1 + Charging from Adapter 1 + RS-232/4-Pin Cable (Load) + RS-232/RJ11 Cable (Load) + Printer + SAM Card + Micro SD Card + Primary Micro-USB Port (Cable Load) + Secondary Micro-USB Port (Data Link with USB Storage Device)		

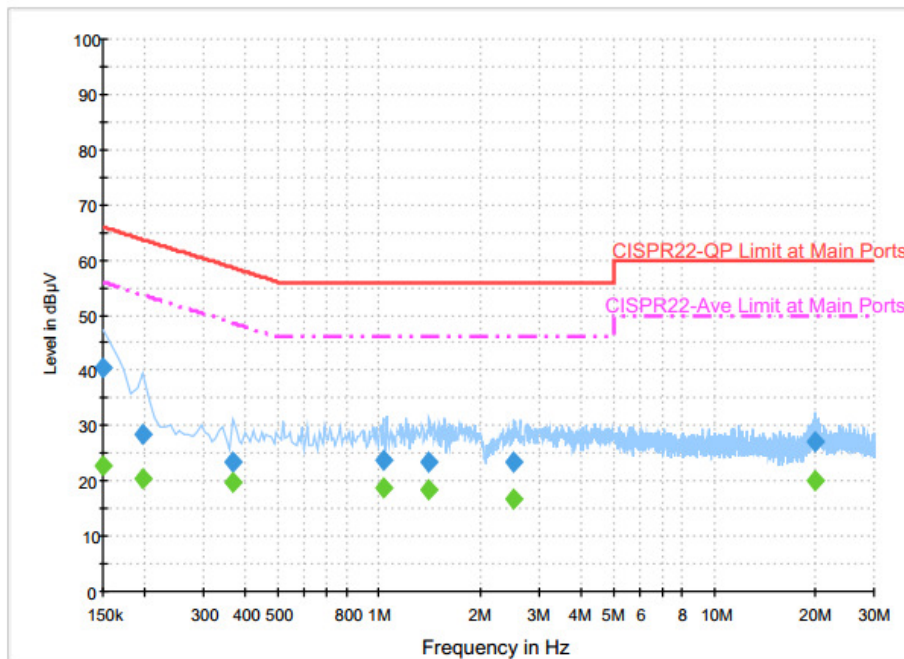

Final Result : Quasi-Peak

Frequency (MHz)	Quasi-Peak (dBµV)	Filter	Line	Corr. (dB)	Margin (dB)	Limit (dBµV)
0.150000	40.4	Off	L1	19.6	25.6	66.0
0.198000	28.3	Off	L1	19.6	35.4	63.7
0.366000	23.6	Off	L1	19.6	35.0	58.6
1.030000	23.8	Off	L1	19.7	32.2	56.0
1.414000	23.3	Off	L1	19.7	32.7	56.0
2.534000	23.5	Off	L1	19.2	32.5	56.0
19.982000	26.9	Off	L1	20.7	33.1	60.0

Final Result : Average

Frequency (MHz)	Average (dBµV)	Filter	Line	Corr. (dB)	Margin (dB)	Limit (dBµV)
0.150000	22.7	Off	L1	19.6	33.3	56.0
0.198000	20.5	Off	L1	19.6	33.2	53.7
0.366000	19.7	Off	L1	19.6	28.9	48.6
1.030000	18.9	Off	L1	19.7	27.1	46.0
1.414000	18.5	Off	L1	19.7	27.5	46.0
2.534000	16.8	Off	L1	19.2	29.2	46.0
19.982000	20.0	Off	L1	20.7	30.0	50.0



Test Mode :	Mode 1	Temperature :	24~25°C
Test Engineer :	Kai-Chun Chu	Relative Humidity :	45~46%
Test Voltage :	120Vac / 60Hz	Phase :	Neutral
Function Type :	GSM1900 Idle + Bluetooth Link + Smart Card Reader + Magnetic Card Reader + RFID Tx + Battery 1 + Charging from Adapter 1 + RS-232/4-Pin Cable (Load) + RS-232/RJ11 Cable (Load) + Printer + SAM Card + Micro SD Card + Primary Micro-USB Port (Cable Load) + Secondary Micro-USB Port (Data Link with USB Storage Device)		

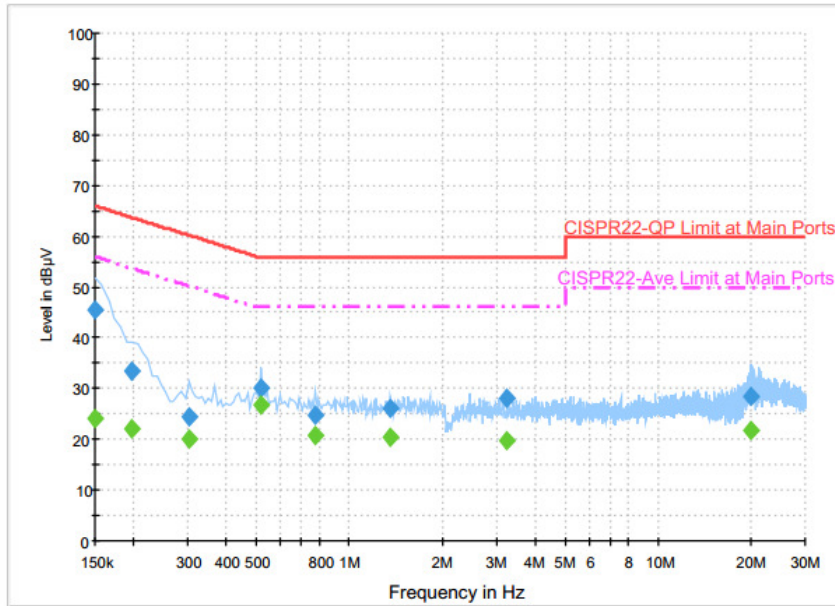

**Final Result : Quasi-Peak**

Frequency (MHz)	Quasi-Peak (dBµV)	Filter	Line	Corr. (dB)	Margin (dB)	Limit (dBµV)
0.150000	45.3	Off	N	19.6	20.7	66.0
0.198000	33.6	Off	N	19.6	30.1	63.7
0.302000	24.5	Off	N	19.6	35.7	60.2
0.518000	30.0	Off	N	19.6	26.0	56.0
0.774000	24.9	Off	N	19.6	31.1	56.0
1.358000	26.2	Off	N	19.7	29.8	56.0
3.238000	28.0	Off	N	19.7	28.0	56.0
20.086000	28.5	Off	N	20.8	31.5	60.0

**Final Result : Average**

Frequency (MHz)	Average (dBµV)	Filter	Line	Corr. (dB)	Margin (dB)	Limit (dBµV)
0.150000	24.2	Off	N	19.6	31.8	56.0
0.198000	22.0	Off	N	19.6	31.7	53.7
0.302000	20.2	Off	N	19.6	30.0	50.2
0.518000	26.7	Off	N	19.6	19.3	46.0
0.774000	20.6	Off	N	19.6	25.4	46.0
1.358000	20.3	Off	N	19.7	25.7	46.0
3.238000	19.8	Off	N	19.7	26.2	46.0
20.086000	21.7	Off	N	20.8	28.3	50.0



## **3.7 Antenna Requirements**

### **3.7.1 Standard Applicable**

If directional gain of transmitting antennas is greater than 6dBi, the power shall be reduced by the same level in dB comparing to gain minus 6dBi. For the fixed point-to-point operation, the power shall be reduced by one dB for every 3 dB that the directional gain of the antenna exceeds 6 dBi. The use of a permanently attached antenna or of an antenna that uses a unique coupling to the intentional radiator shall be considered sufficient to comply with the FCC rule.

### **3.7.2 Antenna Anti-Replacement Construction**

An embedded-in antenna design is used.

### **3.7.3 Antenna Gain**

The antenna peak gain of EUT is less than 6 dBi. Therefore, it is not necessary to reduce maximum peak output power limit.



## 4 List of Measuring Equipment

Instrument	Manufacturer	Model No.	Serial No.	Characteristics	Calibration Date	Test Date	Due Date	Remark
Power Meter	Anritsu	ML2495A	1132003	300MHz~40GHz	Aug. 04, 2016	Oct. 03, 2016 ~ Oct. 05, 2016	Aug. 03, 2017	Conducted (TH05-HY)
Power Sensor	Anritsu	MA2411B	1126017	300MHz~40GHz	Aug. 04, 2016	Oct. 03, 2016 ~ Oct. 05, 2016	Aug. 03, 2017	Conducted (TH05-HY)
Spectrum Analyzer	Rohde & Schwarz	FSP40	100057	9kHz-40GHz	Nov. 23, 2015	Oct. 03, 2016 ~ Oct. 05, 2016	Nov. 22, 2016	Conducted (TH05-HY)
AC Power Source	ChainTek	APC-1000W	N/A	N/A	N/A	Oct. 12, 2016	N/A	Conduction (CO05-HY)
EMI Test Receiver	Rohde & Schwarz	ESCI 7	100724	9kHz~7GHz	Aug. 30, 2016	Oct. 12, 2016	Aug. 29, 2017	Conduction (CO05-HY)
LISN	Rohde & Schwarz	ENV216	100080	9kHz~30MHz	Dec. 02, 2015	Oct. 12, 2016	Dec. 01, 2016	Conduction (CO05-HY)
LISN	Rohde & Schwarz	ENV216	100081	9kHz~30MHz	Dec. 14, 2015	Oct. 12, 2016	Dec. 13, 2016	Conduction (CO05-HY)
Amplifier	SONOMA	310N	187312	9kHz~1GHz	Nov. 20, 2015	Oct. 13, 2016 ~ Oct. 17, 2016	Nov. 19, 2016	Radiation (03CH11-HY)
Loop Antenna	Rohde & Schwarz	HFH2-Z2	100315	9 kHz~30 MHz	Sep. 02, 2015	Oct. 13, 2016 ~ Oct. 17, 2016	Sep. 01, 2017	Radiation (03CH11-HY)
Bilog Antenna	TESEQ	CBL 6111D	35414	30MHz~1GHz	Nov. 17, 2015	Oct. 13, 2016 ~ Oct. 17, 2016	Nov. 16, 2016	Radiation (03CH11-HY)
Horn Antenna	SCHWARZBECK	BBHA 9120 D	9120D-152 2	1GHz ~ 18GHz	Mar. 30, 2016	Oct. 13, 2016 ~ Oct. 17, 2016	Mar. 31, 2017	Radiation (03CH11-HY)
Preamplifier	Keysight	83017A	MY532700 80	1GHz~26.5GHz	Nov. 19, 2015	Oct. 13, 2016 ~ Oct. 17, 2016	Nov. 18, 2016	Radiation (03CH11-HY)
Spectrum Analyzer	Keysight	N9010A	MY523502 76	10Hz ~ 44GHz	Mar. 21, 2016	Oct. 13, 2016 ~ Oct. 17, 2016	Mar. 20, 2017	Radiation (03CH11-HY)
Antenna Mast	EMEC	AM-BS-4500-B	N/A	1~4m	N/A	Oct. 13, 2016 ~ Oct. 17, 2016	N/A	Radiation (03CH11-HY)
Turn Table	EMEC	TT 2000	N/A	0~360 Degree	N/A	Oct. 13, 2016 ~ Oct. 17, 2016	N/A	Radiation (03CH11-HY)
Preamplifier	MITEQ	TTA0204	1872107	2GHz~40GHz	Feb. 15, 2016	Oct. 13, 2016 ~ Oct. 17, 2016	Feb. 14, 2017	Radiation (03CH11-HY)
Signal Generator	Rohde & Schwarz	SMF100A	101107	100kHz~40GHz	May 19, 2016	Oct. 13, 2016 ~ Oct. 17, 2016	May 18, 2017	Radiation (03CH11-HY)
SHF-EHF Horn Antenna	SCHWARZBECK	BBHA 9170	BBHA9170 584	18GHz- 40GHz	Nov. 02, 2015	Oct. 13, 2016 ~ Oct. 17, 2016	Nov. 01, 2016	Radiation (03CH11-HY)



## 5 Uncertainty of Evaluation

### Uncertainty of Conducted Emission Measurement (150kHz ~ 30MHz)

Measuring Uncertainty for a Level of Confidence of 95% ( $U = 2Uc(y)$ )	2.7
---	-----

### Uncertainty of Radiated Emission Measurement (30 MHz ~ 1000 MHz)

Measuring Uncertainty for a Level of Confidence of 95% ( $U = 2Uc(y)$ )	5.2
---	-----

### Uncertainty of Radiated Emission Measurement (1000 MHz ~ 18000 MHz)

Measuring Uncertainty for a Level of Confidence of 95% ( $U = 2Uc(y)$ )	5.5
---	-----

### Uncertainty of Radiated Emission Measurement (18000 MHz ~ 40000 MHz)

Measuring Uncertainty for a Level of Confidence of 95% ( $U = 2Uc(y)$ )	5.2
---	-----



## **Appendix A. Conducted Test Results**