



FCC RF Test Report

APPLICANT : Verifone, Inc.
EQUIPMENT : Point of Sales Terminal
BRAND NAME : Verifone
MODEL NAME : C680 3G-BT-WiFi
FCC ID : B32C6803GBTW
STANDARD : FCC Part 15 Subpart C §15.247
CLASSIFICATION : (DTS) Digital Transmission System

The product was received on Sep. 21, 2016 and testing was completed on Oct. 12, 2016. We, SPORTON INTERNATIONAL INC., would like to declare that the tested sample has been evaluated in accordance with the test procedures and has been in compliance with the applicable technical standards.

The test results in this report apply exclusively to the tested model / sample. Without written approval of SPORTON INTERNATIONAL INC., the test report shall not be reproduced except in full.

Reviewed by: Joseph Lin / Supervisor

Approved by: Jones Tsai / Manager



SPORTON INTERNATIONAL INC.

No. 52, Hwa Ya 1st Rd., Hwa Ya Technology Park, Kwei-Shan District, Tao Yuan City, Taiwan, R.O.C.

SPORTON INTERNATIONAL INC.

TEL : 886-3-327-3456

FAX : 886-3-328-4978

FCC ID : B32C6803GBTW

Page Number : 1 of 40

Report Issued Date : Oct. 24, 2016

Report Version : Rev. 01

Report Template No.: BU5-FR15CBT4.0 Version 1.3



TABLE OF CONTENTS

SUMMARY OF TEST RESULT 4

1 GENERAL DESCRIPTION..... 5

 1.1 Applicant 5

 1.2 Manufacturer 5

 1.3 Product Feature of Equipment Under Test..... 5

 1.4 Product Specification of Equipment Under Test..... 6

 1.5 Modification of EUT 7

 1.6 Testing Location 7

 1.7 Applicable Standards..... 8

2 TEST CONFIGURATION OF EQUIPMENT UNDER TEST..... 9

 2.1 Descriptions of Test Mode 9

 2.2 Test Mode 10

 2.3 Connection Diagram of Test System 11

 2.4 Support Unit used in test configuration and system 12

 2.5 EUT Operation Test Setup 12

 2.6 Measurement Results Explanation Example..... 13

3 TEST RESULT 14

 3.1 6dB and 99% Bandwidth Measurement 14

 3.2 Peak Output Power Measurement 19

 3.3 Power Spectral Density Measurement 20

 3.4 Conducted Band Edges and Spurious Emission Measurement 25

 3.5 Radiated Band Edges and Spurious Emission Measurement 30

 3.6 AC Conducted Emission Measurement..... 34

 3.7 Antenna Requirements 38

4 LIST OF MEASURING EQUIPMENT..... 39

5 UNCERTAINTY OF EVALUATION..... 40

APPENDIX A. CONDUCTED TEST RESULTS

APPENDIX B. RADIATED SPURIOUS EMISSION

APPENDIX C. RADIATED SPURIOUS EMISSION PLOTS

APPENDIX D. DUTY CYCLE PLOTS

APPENDIX E. SETUP PHOTOGRAPHS



SUMMARY OF TEST RESULT

Report Section	FCC Rule	Description	Limit	Result	Remark
3.1	15.247(a)(2)	6dB Bandwidth	$\geq 0.5\text{MHz}$	Pass	-
3.1	-	99% Bandwidth	-	Pass	-
3.2	15.247(b)(3)	Peak Output Power	$\leq 30\text{dBm}$	Pass	-
3.3	15.247(e)	Power Spectral Density	$\leq 8\text{dBm}/3\text{kHz}$	Pass	-
3.4	15.247(d)	Conducted Band Edges and Spurious Emission	$\leq 20\text{dBc}$	Pass	-
3.5	15.247(d)	Radiated Band Edges and Spurious Emission	15.209(a) & 15.247(d)	Pass	Under limit 10.02 dB at 40.260 MHz
3.6	15.207	AC Conducted Emission	15.207(a)	Pass	Under limit 19.30 dB at 0.518 MHz
3.7	15.203 & 15.247(b)	Antenna Requirement	N/A	Pass	-



1 General Description

1.1 Applicant

Verifone, Inc.

1400 West Stanford Ranch Road, Suite 100, 150 & 200, Rocklin CA 95765 USA

1.2 Manufacturer

Inventec Appliances (Pudong) Corporation

Building 1 - 3, No. 789 Pu Xing Road, Caohejing Export Processing Zone, Shanghai, P.R.C.

1.3 Product Feature of Equipment Under Test

Product Feature	
Equipment	Point of Sales Terminal
Brand Name	Verifone
Model Name	C680 3G-BT-WiFi
FCC ID	B32C6803GBTW
EUT supports Radios application	GSM/EGPRS/WCDMA/HSPA/RFID WLAN 11b/g/n HT20 WLAN 11a/n HT20/HT40 Bluetooth BR/EDR/LE
EUT Stage	Identical Prototype

Remark: The above EUT's information was declared by manufacturer. Please refer to the specifications or user's manual for more detailed description.



Specification of Accessory		
AC Adapter 1	Brand Name	Verifone, Inc.
	Manufacturer	Elementech
	Model Name	A111-3050223U
	Power Rating	Input : 100-240 V AC 50/60Hz, 0.5A Output: 5.0V DC 2.2A
	Power Cord	1.8meter, non-shielded cable, without ferrite core
AC Adapter 2	Brand Name	Verifone, Inc.
	Manufacturer	PHIHONG
	Model Name	AM11A-050A-R
	Power Rating	Input : 100-240 V AC 50/60Hz, 0.5A Output: 5.0V DC 2.2A
	Power Cord	1.8meter, non-shielded cable, without ferrite core
Battery 1	Brand Name	Verifone, Inc.
	Manufacturer	Palladium Energy Inc.
	Model Name	BPK260-001
Battery 2	Brand Name	Verifone, Inc.
	Manufacturer	Panasonic Corporation
	Model Name	BPK260-001

1.4 Product Specification of Equipment Under Test

Standards-related Product Specification	
Tx/Rx Frequency Range	2402 MHz ~ 2480 MHz
Number of Channels	40
Carrier Frequency of Each Channel	40 Channel(37 hopping + 3 advertising channel)
Maximum Output Power to Antenna	4.14 dBm (0.0026 W)
99% Occupied Bandwidth	1.058MHz
Antenna Type / Gain	PIFA Antenna type with gain 2.96 dBi
Type of Modulation	Bluetooth LE : GFSK



1.5 Modification of EUT

No modifications are made to the EUT during all test items.

1.6 Testing Location

Sporton Lab is accredited to ISO 17025 by Taiwan Accreditation Foundation (TAF code : 1190) and the FCC designation No. TW1022 under the FCC 2.948(e) by Mutual Recognition Agreement (MRA) in FCC Test.

Test Site	SPORTON INTERNATIONAL INC.	
Test Site Location	No. 52, Hwa Ya 1 st Rd., Hwa Ya Technology Park, Kwei-Shan District, Tao Yuan City, Taiwan, R.O.C. TEL: +886-3-327-3456 FAX: +886-3-328-4978	
Test Site No.	Sporton Site No.	
	TH02-HY	CO05-HY

Note: The test site complies with ANSI C63.4 2014 requirement.

Test Site	SPORTON INTERNATIONAL INC.	
Test Site Location	No.58, Aly. 75, Ln. 564, Wenhua 3rd Rd. Guishan Dist, Taoyuan City, Taiwan (R.O.C.) TEL: +886-3-327-0868 FAX: +886-3-327-0855	
Test Site No.	Sporton Site No.	
	03CH10-HY	

Note: The test site complies with ANSI C63.4 2014 requirement.



1.7 Applicable Standards

According to the specifications of the manufacturer, the EUT must comply with the requirements of the following standards:

- ♦ FCC Part 15 Subpart C §15.247
- ♦ FCC KDB Publication No. 558074 D01 DTS Meas. Guidance v03r05
- ♦ ANSI C63.10-2013

Remark:

1. All test items were verified and recorded according to the standards and without any deviation during the test.
2. This EUT has also been tested and complied with the requirements of FCC Part 15, Subpart B, recorded in a separate test report.



2 Test Configuration of Equipment Under Test

2.1 Descriptions of Test Mode

The RF output power was recorded in the following table:

Channel	Frequency	Bluetooth – LE RF Output Power	
		Data Rate / Modulation	
		GFSK	
		1Mbps	
Ch00	2402MHz	4.14	dBm
Ch19	2440MHz	3.63	dBm
Ch39	2480MHz	3.55	dBm

- a. The EUT has been associated with peripherals and configuration operated in a manner tended to maximize its emission characteristics in a typical application. Frequency range investigated: conduction (150 kHz to 30 MHz), radiation (9 kHz to the 10th harmonic of the highest fundamental frequency or to 40 GHz, whichever is lower). Pre-scanned tests, X, Y, Z in three orthogonal panels to determine the final configuration (Z plane as worst plane) from all possible combinations.

- b. AC power line Conducted Emission was tested under maximum output power.



2.2 Test Mode

The following summary table is showing all test modes to demonstrate in compliance with the standard.

Summary table of Test Cases	
Test Item	Data Rate / Modulation
	Bluetooth – LE / GFSK
Conducted TCs	Mode 1: Bluetooth Tx CH00_2402 MHz_1Mbps Mode 2: Bluetooth Tx CH19_2440 MHz_1Mbps Mode 3: Bluetooth Tx CH39_2480 MHz_1Mbps
Radiated TCs	Mode 1: Bluetooth Tx CH00_2402 MHz_1Mbps Mode 2: Bluetooth Tx CH19_2440 MHz_1Mbps Mode 3: Bluetooth Tx CH39_2480 MHz_1Mbps
AC Conducted Emission	Mode 1 : GSM1900 Idle + Bluetooth Link + Smart Card Reader + Magnetic Card Reader + RFID Tx + Battery 1 + Charging from Adapter 1 + RS-232/4-Pin Cable (Load) + RS-232/RJ11 Cable (Load) + Printer + SAM Card + Micro SD Card + Primary Micro-USB Port (Cable Load) + Secondary Micro-USB Port (Data Link with USB Storage Device) Mode 2 : GSM1900 Idle + WLAN (2.4GHz) Link + Smart Card Reader + Magnetic Card Reader + RFID Tx + Battery 1 + Charging from Adapter 1 + RS-232/4-Pin Cable (Load) + RS-232/RJ11 Cable (Load) + Printer + SAM Card + Micro SD Card + Primary Micro-USB Port (Cable Load) + Secondary Micro-USB Port (Data Link with USB Storage Device)
Remark:	
<ol style="list-style-type: none"> The worst case of conducted emission is mode 1; only the test data of it was reported. All the Radiated test items were performed with Adapter 1 and Battery 1. 	

2.3 Connection Diagram of Test System

<Bluetooth – LE Tx Mode>

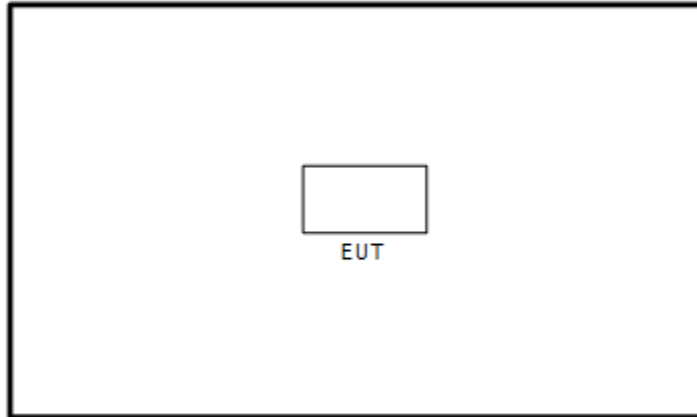

<EUT in Bluetooth Mode>

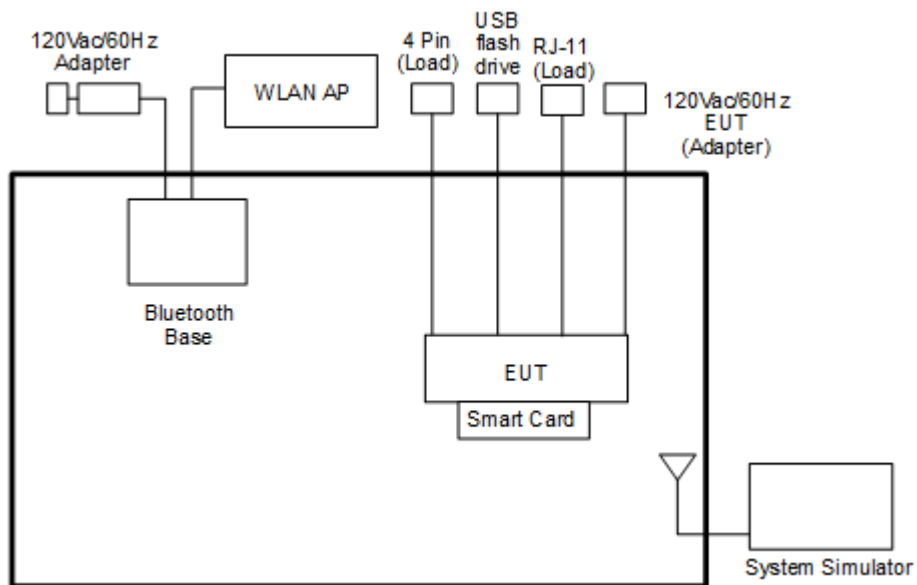

<EUT in WLAN Mode>

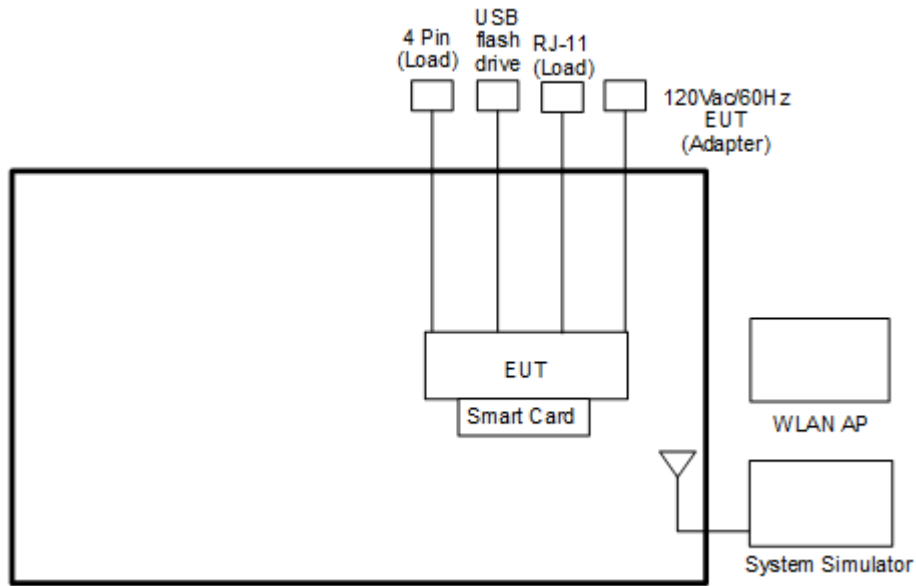

2.4 Support Unit used in test configuration and system

Item	Equipment	Trade Name	Model Name	FCC ID	Data Cable	Power Cord
1.	System Simulator	Anritsu	MT8820C	N/A	N/A	Unshielded, 1.8 m
2.	WLAN AP	ASUS	RT-AC66U	MSQ-RTAC66U	N/A	Unshielded, 1.8 m
3.	Bluetooth Base	VariFone	VX680-B-BTC	B32VX680-B-BTC	N/A	N/A
4.	SD Card	SanDisk	MicroSD HC	FCC DoC	N/A	N/A
5.	USB flash drive	Transcend	N/A	N/A	N/A	N/A
6.	Smart Card	N/A	N/A	N/A	N/A	N/A

2.5 EUT Operation Test Setup

For Bluetooth function, programmed RF utility installed in the notebook make the EUT provide functions like channel selection and power level for continuous transmitting and receiving signals.



2.6 Measurement Results Explanation Example

For all conducted test items:

The offset level is set in the spectrum analyzer to compensate the RF cable loss and attenuator factor between EUT conducted output port and spectrum analyzer. With the offset compensation, the spectrum analyzer reading level is exactly the EUT RF output level.

Example :

The spectrum analyzer offset is derived from RF cable loss and attenuator factor.

Offset = RF cable loss + attenuator factor.

Following shows an offset computation example with cable loss 4.2 dB and 10dB attenuator.

$$\begin{aligned} \text{Offset(dB)} &= \text{RF cable loss(dB)} + \text{attenuator factor(dB)}. \\ &= 4.2 + 10 = 14.2 \text{ (dB)} \end{aligned}$$

3 Test Result

3.1 6dB and 99% Bandwidth Measurement

3.1.1 Limit of 6dB and 99% Bandwidth

The minimum 6 dB bandwidth shall be at least 500 kHz.

3.1.2 Measuring Instruments

The section 4.0 of List of Measuring Equipment of this test report is used for test.

3.1.3 Test Procedures

1. The testing follows FCC KDB Publication No. 558074 D01 DTS Meas. Guidance v03r05.
2. The RF output of EUT was connected to the spectrum analyzer by RF cable and attenuator. The path loss was compensated to the results for each measurement.
3. Set to the maximum power setting and enable the EUT transmit continuously.
4. Make the measurement with the spectrum analyzer's resolution bandwidth (RBW) = 100 kHz. Set the Video bandwidth (VBW) = 300 kHz. In order to make an accurate measurement. The 6 dB bandwidth must be greater than 500 kHz.
5. For 99% Bandwidth Measurement, the spectrum analyzer's resolution bandwidth (RBW) is set 30kHz and set the Video bandwidth (VBW) = 100kHz.
6. Measure and record the results in the test report.

3.1.4 Test Setup





3.1.5 Test Result of 6dB Bandwidth

Test data refer to Appendix A.

6 dB Bandwidth Plot on Channel 00

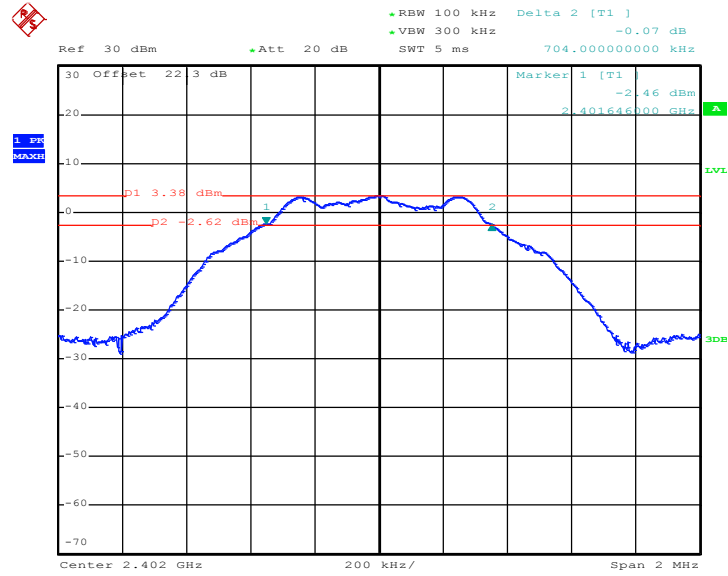

Date: 5.OCT.2016 23:48:49



6 dB Bandwidth Plot on Channel 19

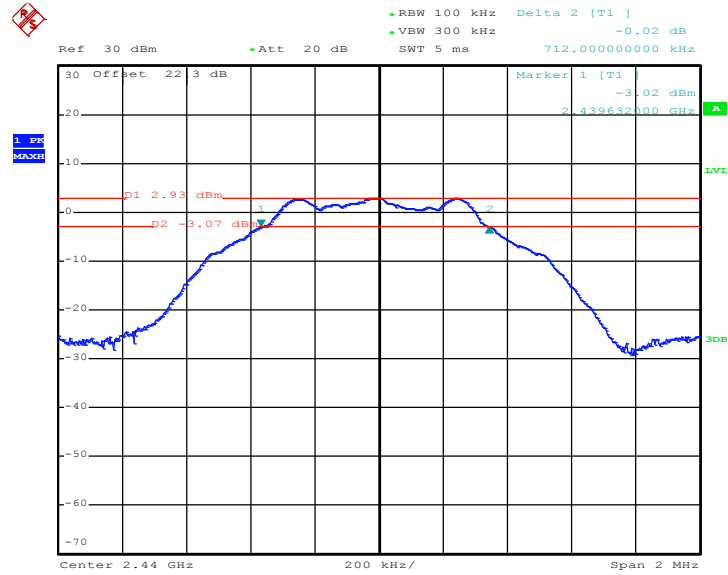

Date: 5.OCT.2016 23:59:28

6 dB Bandwidth Plot on Channel 39

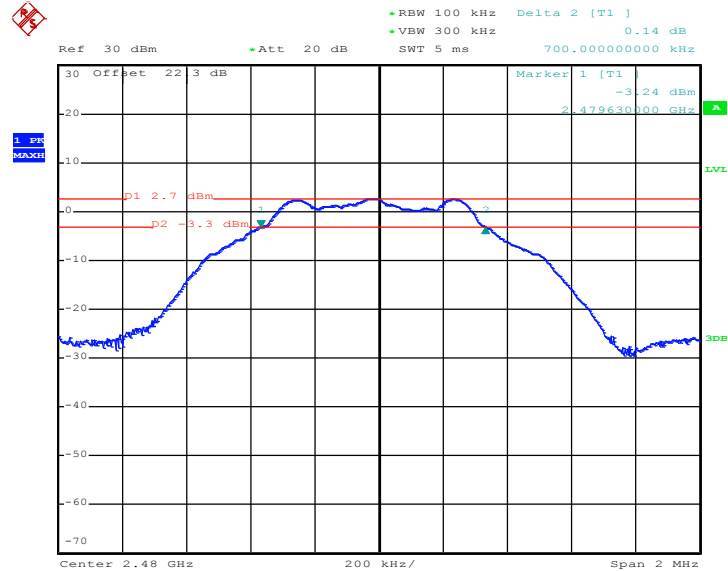

Date: 6.OCT.2016 00:02:17



3.1.6 Test Result of 99% Occupied Bandwidth

Test data refer to Appendix A.

99% Bandwidth Plot on Channel 00

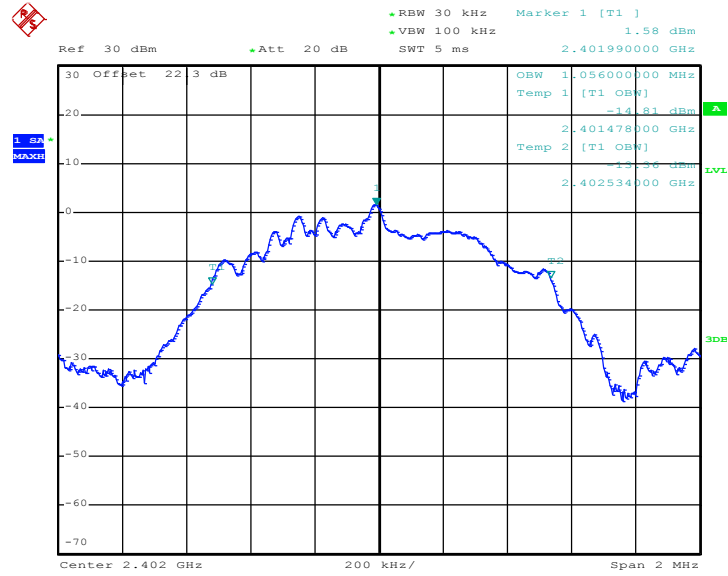

Date: 5.OCT.2016 23:50:20



99% Occupied Bandwidth Plot on Channel 19

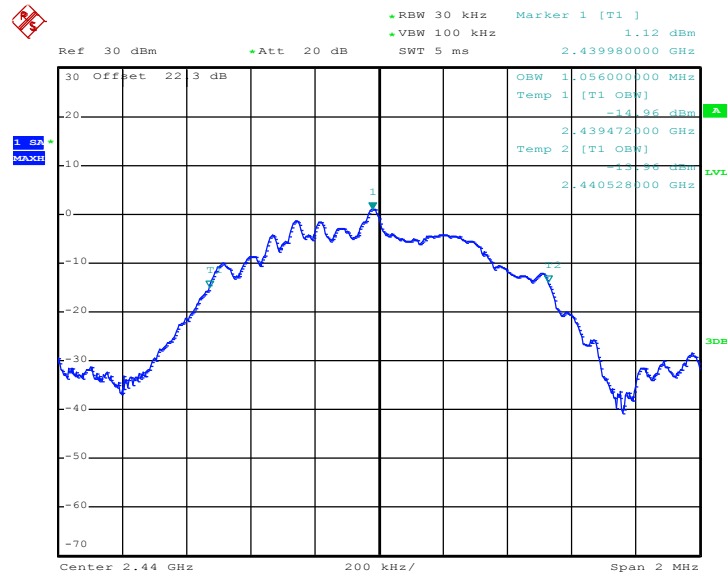

Date: 6.OCT.2016 00:01:06

99% Occupied Bandwidth Plot on Channel 39

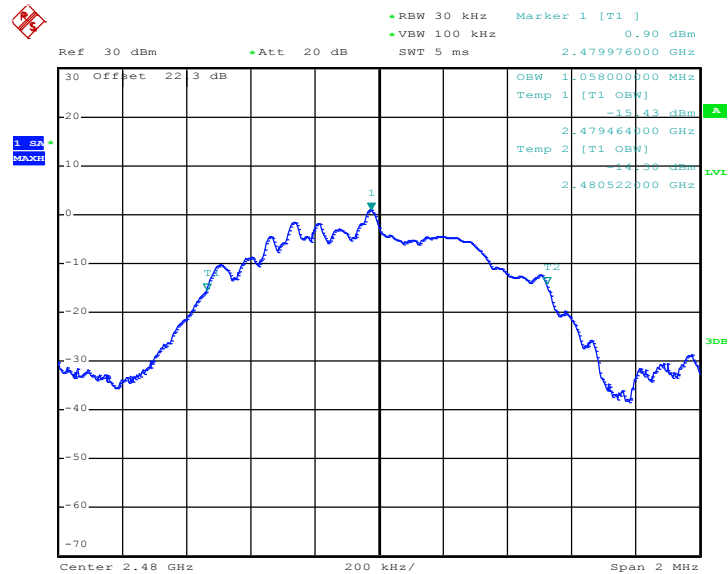

Date: 6.OCT.2016 00:04:18

Note: The occupied channel bandwidth is maintained within the band of operation for all of the modulations.

3.2 Peak Output Power Measurement

3.2.1 Limit of Peak Output Power

For systems using digital modulation in the 2400-2483.5MHz, the limit for peak output power is 30dBm. If transmitting antenna of directional gain greater than 6dBi is used, the peak output power from the intentional radiator shall be reduced below the above stated value by the amount in dB that the directional gain of the antenna exceeds 6 dBi. In case of point-to-point operation, the limit has to be reduced by 1dB for every 3dB that the directional gain of the antenna exceeds 6dBi.

3.2.2 Measuring Instruments

The section 4.0 of List of Measuring Equipment of this test report is used for test.

3.2.3 Test Procedures

1. The testing follows the Measurement Procedure of FCC KDB No. 558074 DTS D01 Meas. Guidance v03r05 section 9.1.2 PKPM1 Peak power meter method.
2. The RF output of EUT was connected to the power meter by RF cable and attenuator. The path loss was compensated to the results for each measurement.
3. Set to the maximum power setting and enable the EUT transmit continuously.
4. Measure the conducted output power and record the results in the test report.

3.2.4 Test Setup

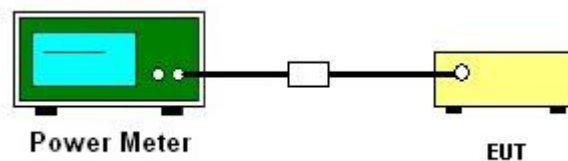

3.2.5 Test Result of Peak Output Power

Test data refers to Appendix A.

3.3 Power Spectral Density Measurement

3.3.1 Limit of Power Spectral Density

The peak power spectral density shall not be greater than 8dBm in any 3kHz band at any time interval of continuous transmission.

3.3.2 Measuring Instruments

The section 4.0 of List of Measuring Equipment of this test report is used for test.

3.3.3 Test Procedures

1. The testing follows Measurement Procedure 10.2 Method PKPSD of FCC KDB Publication No. 558074 D01 DTS Meas. Guidance v03r05
2. The RF output of EUT was connected to the spectrum analyzer by RF cable and attenuator. The path loss was compensated to the results for each measurement.
3. Set to the maximum power setting and enable the EUT transmit continuously.
4. Make the measurement with the spectrum analyzer's resolution bandwidth (RBW) = 3 kHz. Video bandwidth VBW = 10 kHz In order to make an accurate measurement, set the span to 1.5 times DTS Channel Bandwidth. (6dB BW)
5. Detector = peak, Sweep time = auto couple, Trace mode = max hold, Allow trace to fully stabilize. Use the peak marker function to determine the maximum power level.
6. Measure and record the results in the test report.
7. The Measured power density (dBm)/ 100kHz is a reference level and used as 20dBc down limit line for Conducted Band Edges and Conducted Spurious Emission.

3.3.4 Test Setup





3.3.5 Test Result of Power Spectral Density

Test data refers to Appendix A.

3.3.6 Test Result of Power Spectral Density Plots (100kHz)

PSD 100kHz Plot on Channel 00

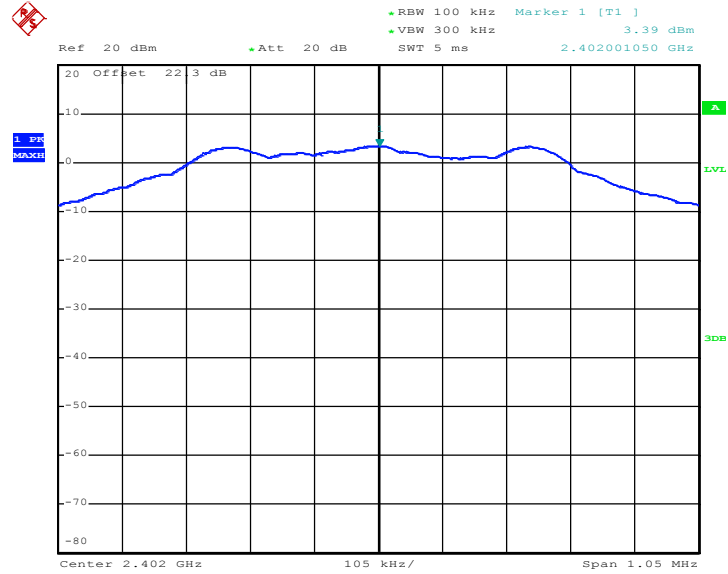

Date: 5.OCT.2016 23:49:25



PSD 100kHz Plot on Channel 19

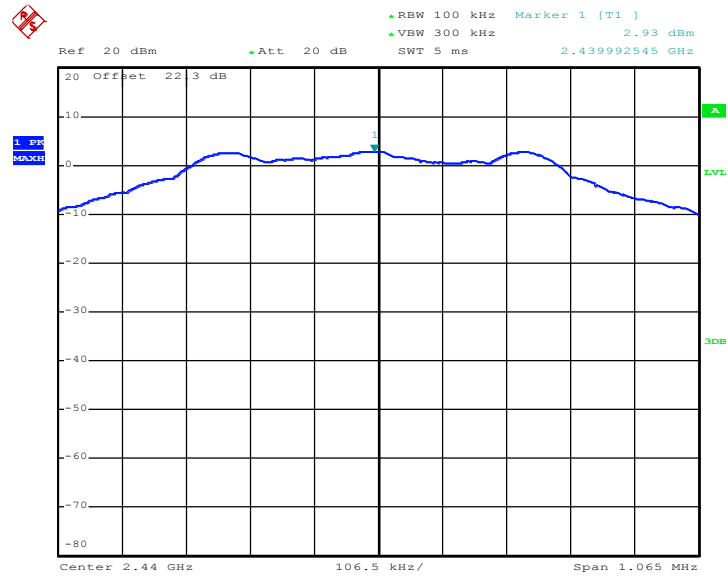

Date: 5.OCT.2016 23:59:53

PSD 100kHz Plot on Channel 39

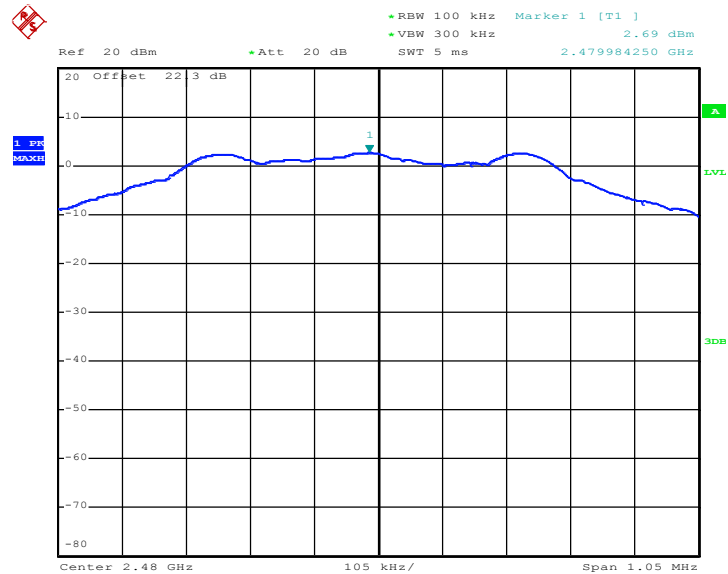

Date: 6.OCT.2016 00:02:48



3.3.7 Test Result of Power Spectral Density Plots (3kHz)

PSD 3kHz Plot on Channel 00

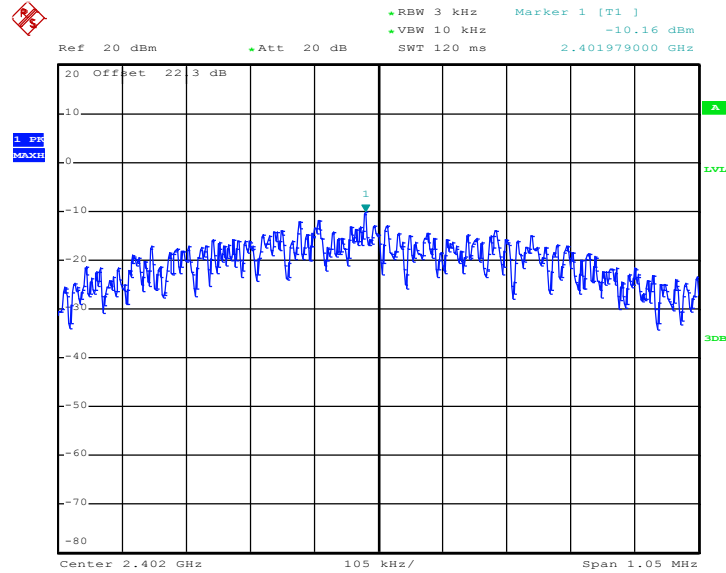

Date: 5.OCT.2016 23:49:07



PSD 3kHz Plot on Channel 19

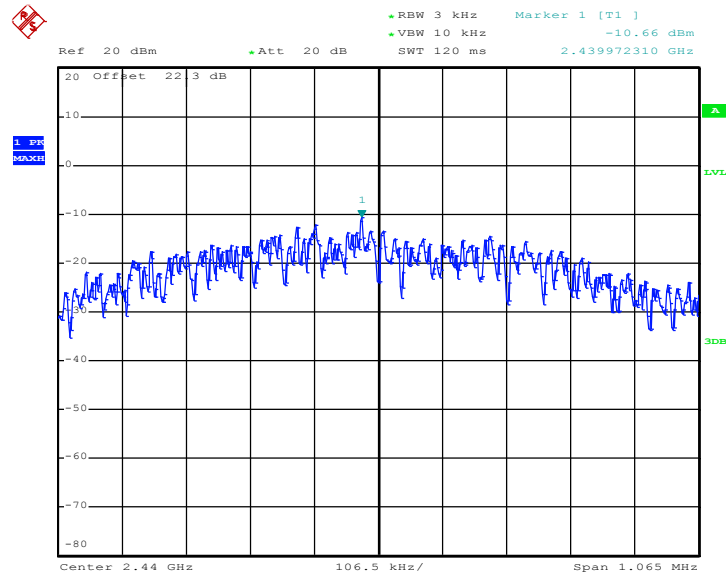

Date: 5.OCT.2016 23:59:38

PSD 3kHz Plot on Channel 39

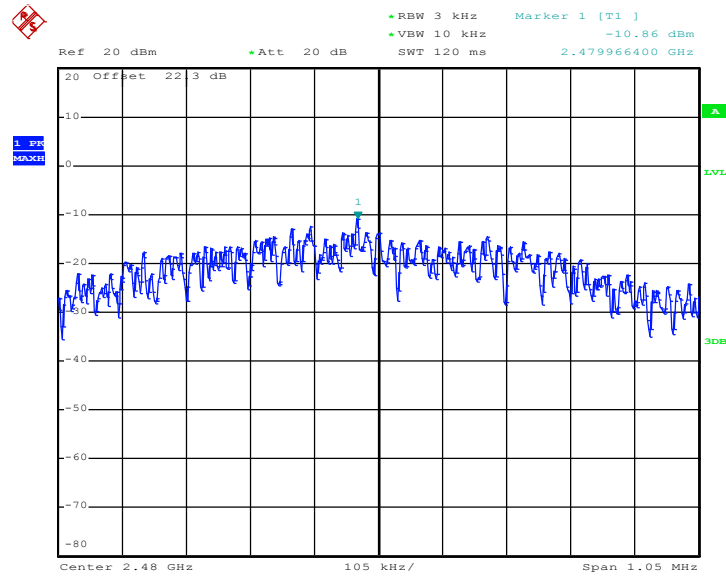

Date: 6.OCT.2016 00:02:34

3.4 Conducted Band Edges and Spurious Emission Measurement

3.4.1 Limit of Conducted Band Edges and Spurious Emission

All harmonics/spurious must be at least 20 dB down from the highest emission level within the authorized band.

3.4.2 Measuring Instruments

The section 4.0 of List of Measuring Equipment of this test report is used for test.

3.4.3 Test Procedure

1. The testing follows FCC KDB Publication No. 558074 D01 DTS Meas. Guidance v03r05.
2. The RF output of EUT was connected to the spectrum analyzer by RF cable and attenuator. The path loss was compensated to the results for each measurement.
3. Set to the maximum power setting and enable the EUT transmit continuously.
4. Set RBW = 100 kHz, VBW=300 kHz, Peak Detector. Unwanted Emissions measured in any 100 kHz bandwidth outside of the authorized frequency band shall be attenuated by at least 20 dB relative to the maximum in-band peak PSD level in 100 kHz when maximum peak conducted output power procedure is used. If the transmitter complies with the conducted power limits based on the use of RMS averaging over a time interval, the attenuation required under this paragraph shall be 30 dB instead of 20 dB per 15.247(d).
5. Measure and record the results in the test report.
6. The RF fundamental frequency should be excluded against the limit line in the operating frequency band.

3.4.4 Test Setup





3.4.5 Test Result of Conducted Band Edges Plots

Low Band Edge Plot on Channel 00

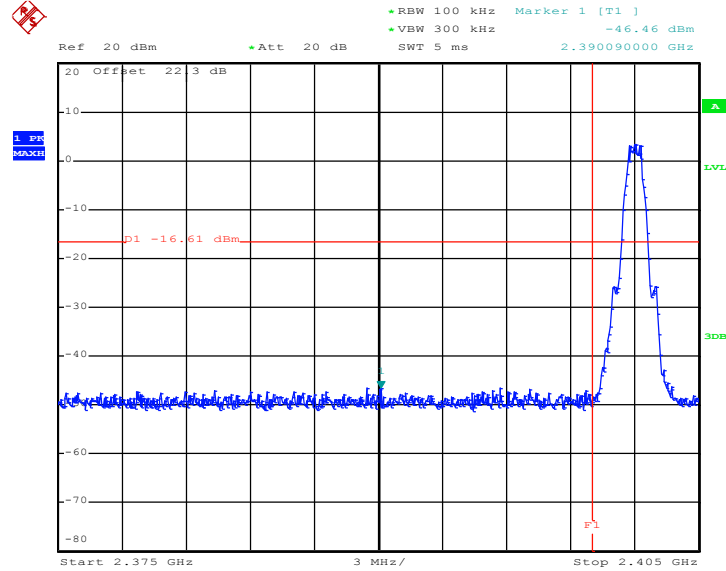

Date: 5.OCT.2016 23:49:38

High Band Edge Plot on Channel 39

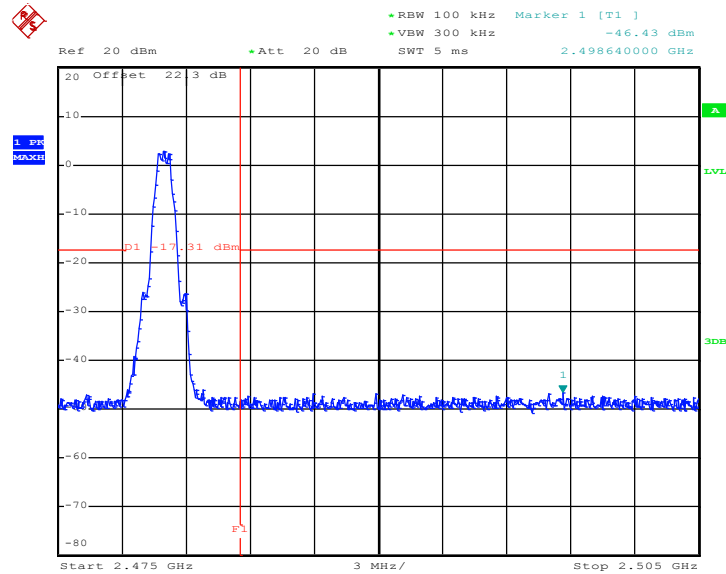

Date: 6.OCT.2016 00:03:09



3.4.6 Test Result of Conducted Spurious Emission Plots

Conducted Spurious Emission Plot on Bluetooth LE 1Mbps GFSK Channel 00

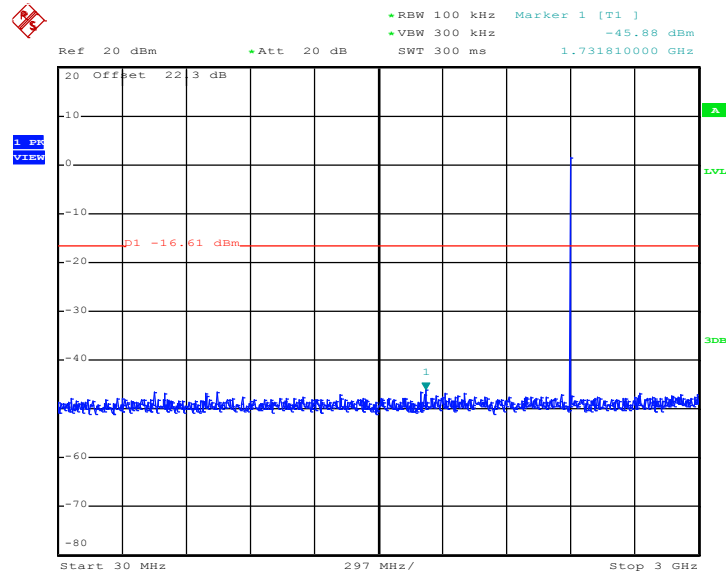

Date: 5.OCT.2016 23:49:50

Conducted Spurious Emission Plot on Bluetooth LE 1Mbps GFSK Channel 00

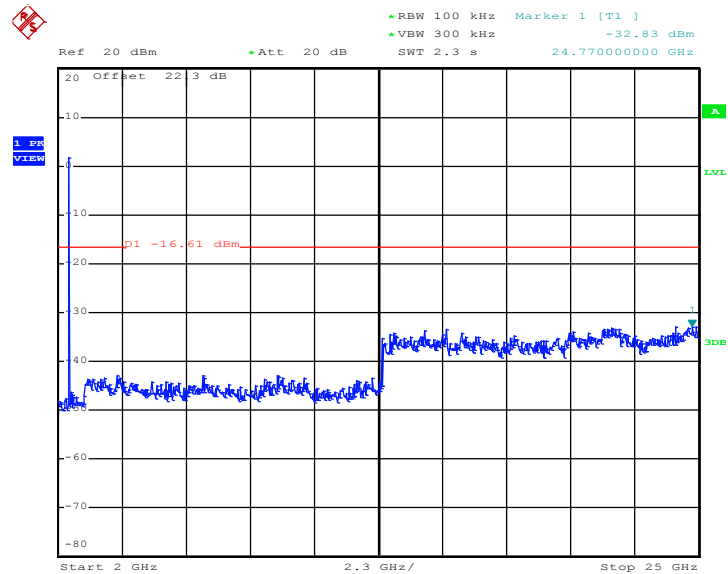

Date: 5.OCT.2016 23:49:59



Conducted Spurious Emission Plot on Bluetooth LE 1Mbps GFSK Channel 19

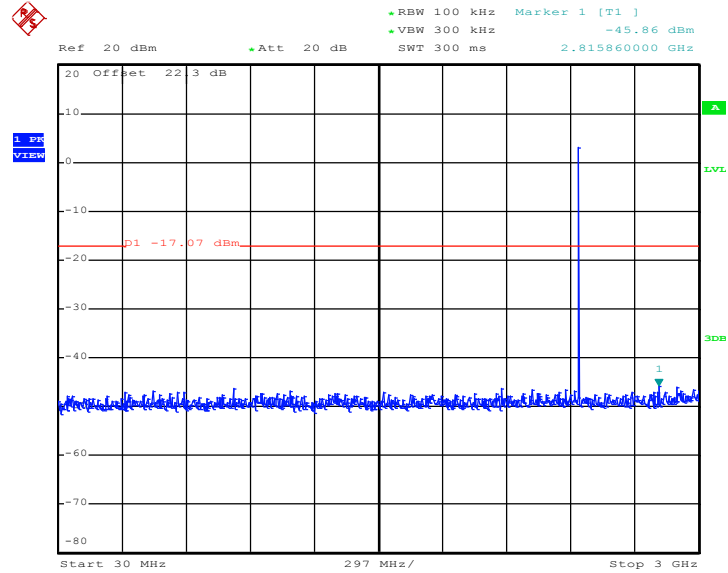

Date: 6.OCT.2016 00:00:29

Conducted Spurious Emission Plot on Bluetooth LE 1Mbps GFSK Channel 19

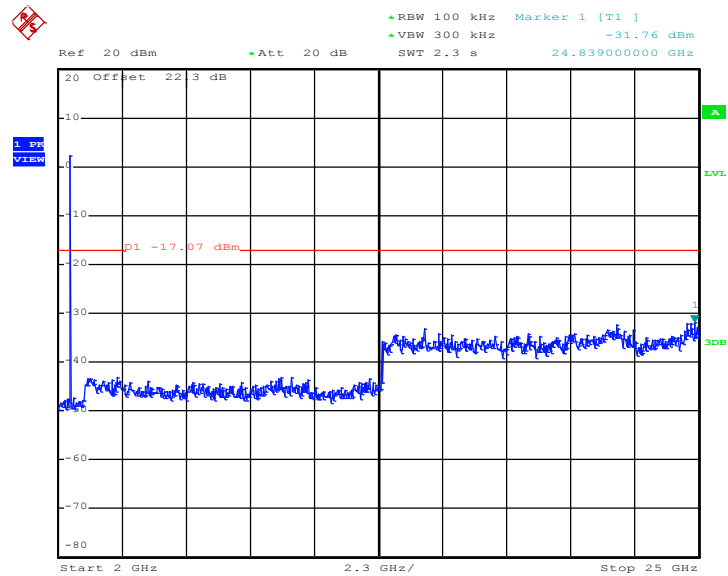

Date: 6.OCT.2016 00:00:38



Conducted Spurious Emission Plot on Bluetooth LE 1Mbps GFSK Channel 39

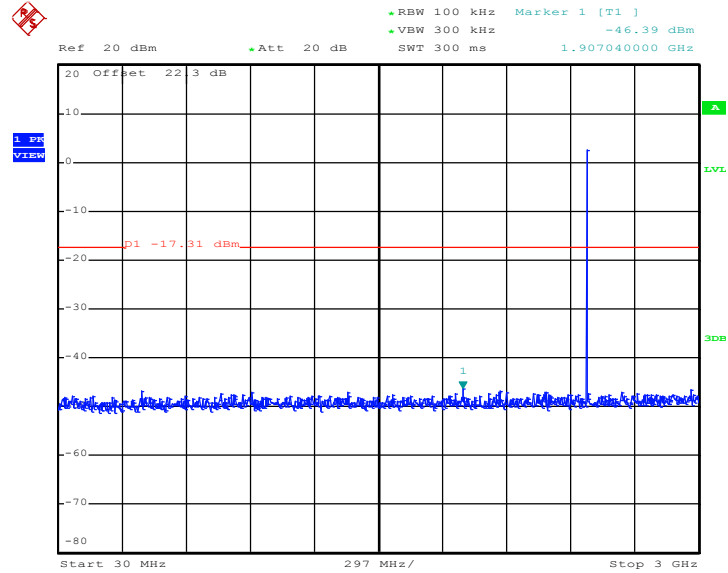

Date: 6.OCT.2016 00:03:20

Conducted Spurious Emission Plot on Bluetooth LE 1Mbps GFSK Channel 39

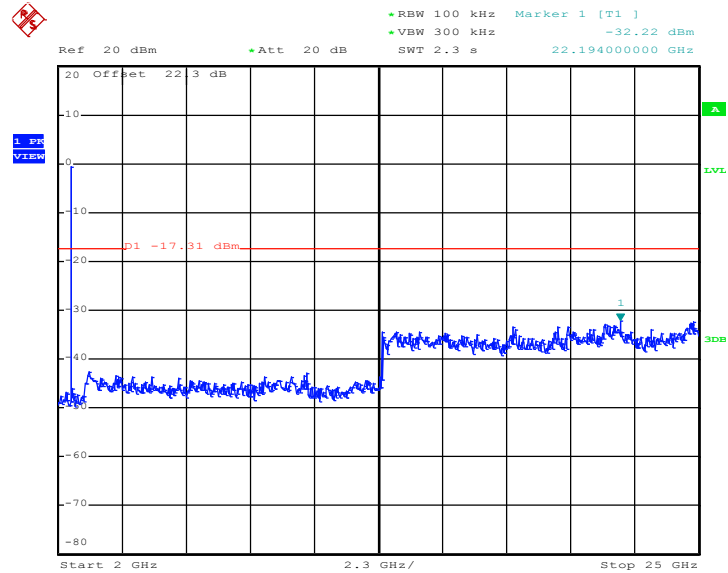

Date: 6.OCT.2016 00:03:29



3.5 Radiated Band Edges and Spurious Emission Measurement

3.5.1 Limit of Radiated Band Edges and Spurious Emission

In any 100 kHz bandwidth outside the intentional radiator frequency band, all harmonics/spurious must be at least 20 dB below the highest emission level within the authorized band. If the output power of this device was measured by spectrum analyzer, the attenuation under this paragraph shall be 30 dB instead of 20 dB. In addition, radiated emissions which fall in the restricted bands must also comply with the FCC section 15.209 limits as below.

Frequency (MHz)	Field Strength (microvolts/meter)	Measurement Distance (meters)
0.009 – 0.490	2400/F(kHz)	300
0.490 – 1.705	24000/F(kHz)	30
1.705 – 30.0	30	30
30 – 88	100	3
88 – 216	150	3
216 - 960	200	3
Above 960	500	3

3.5.2 Measuring Instruments

The section 4.0 of List of Measuring Equipment of this test report is used for test.



3.5.3 Test Procedures

1. The testing follows FCC KDB Publication No. 558074 D01 DTS Meas. Guidance v03r05.
2. The EUT was arranged to its worst case and then tune the antenna tower (from 1 m to 4 m) and turntable (from 0 degree to 360 degrees) to find the maximum reading. A pre-amp and a high pass filter are used for the test in order to get better signal level.
3. The EUT was placed on a turntable with 0.8 meter for frequency below 1GHz and 1.5 meter for frequency above 1GHz respectively above ground.
4. The EUT was set 3 meters from the interference receiving antenna, which was mounted on the top of a variable height antenna tower.
5. Corrected Reading: Antenna Factor + Cable Loss + Read Level - Preamp Factor = Level
6. For measurement below 1GHz, If the emission level of the EUT measured by the peak detector is 3 dB lower than the applicable limit, the peak emission level will be reported. Otherwise, the emission measurement will be repeated using the quasi-peak detector and reported.
7. Use the following spectrum analyzer settings:
 - (1) Span shall wide enough to fully capture the emission being measured;
 - (2) Set RBW=100 kHz for $f < 1$ GHz; VBW \geq RBW; Sweep = auto; Detector function = peak; Trace = max hold;
 - (3) Set RBW = 1 MHz, VBW= 3MHz for $f \geq 1$ GHz for peak measurement.
For average measurement:
 - VBW = 10 Hz, when duty cycle is no less than 98 percent.
 - VBW $\geq 1/T$, when duty cycle is less than 98 percent where T is the minimum transmission duration over which the transmitter is on and is transmitting at its maximum power control level for the tested mode of operation.

3.5.4 Test Setup

For radiated emissions below 30MHz

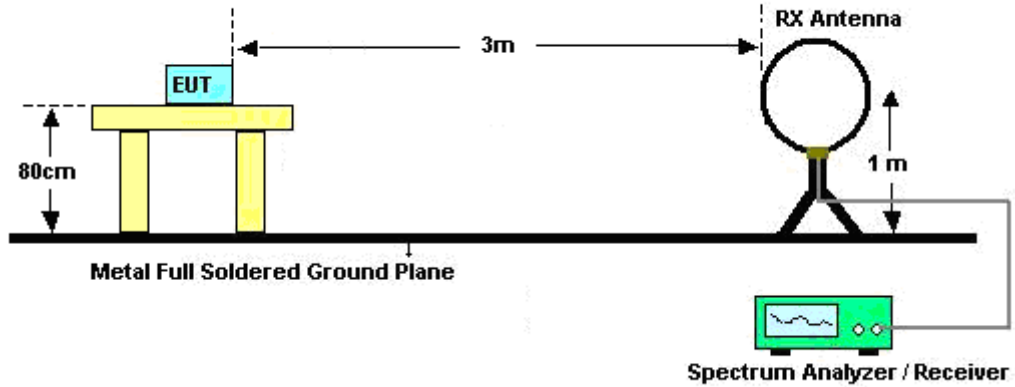

For radiated emissions from 30MHz to 1GHz

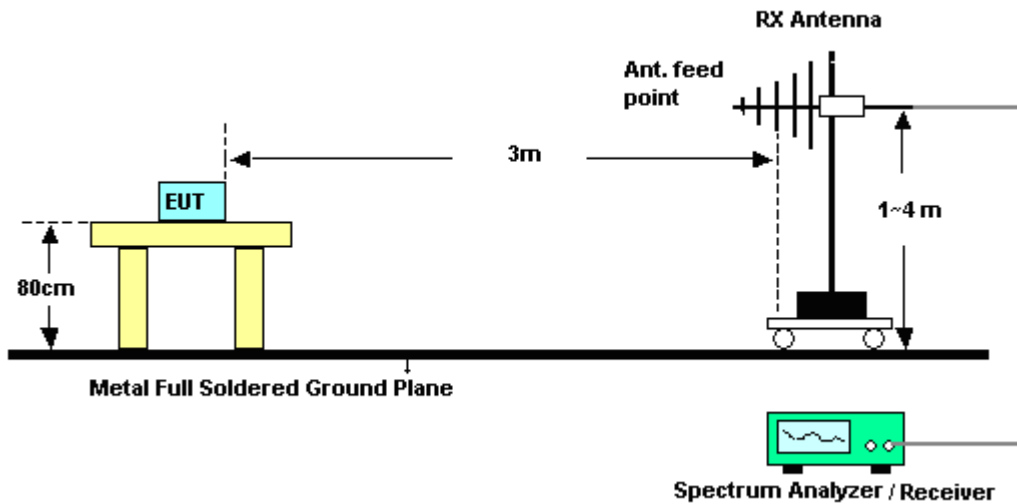

For radiated emissions above 1GHz

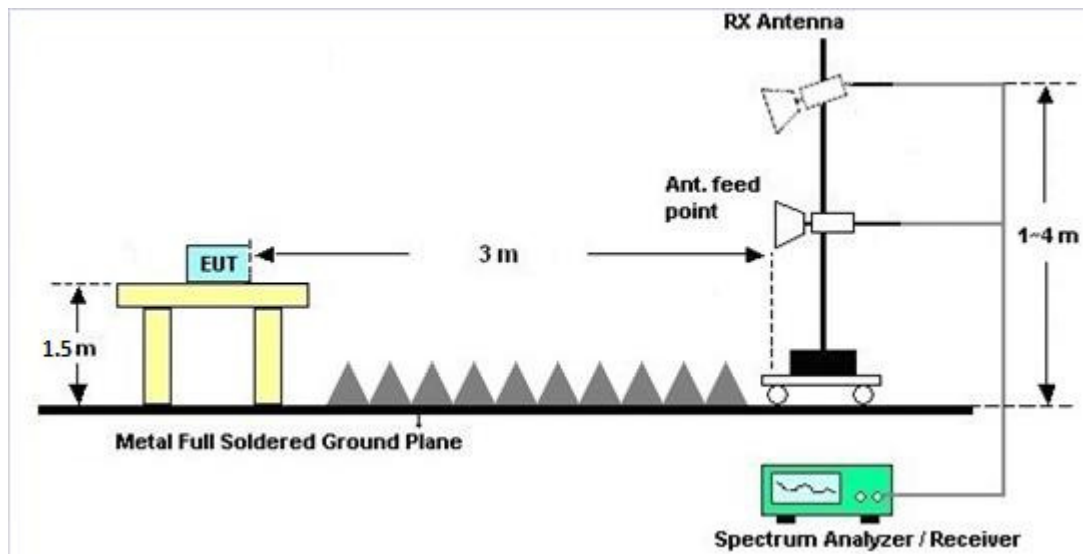

3.5.5 Test Results of Radiated Spurious Emissions (9 kHz ~ 30 MHz)

The low frequency, which started from 9 kHz to 30MHz, was pre-scanned and the result which was 20dB lower than the limit line per 15.31(o) was not reported.

3.5.6 Test Result of Radiated Spurious at Band Edges

Please refer to Appendix B and C.

3.5.7 Duty Cycle

Please refer to Appendix D.

3.5.8 Test Result of Radiated Spurious Emission (30MHz ~ 10th Harmonic)

Please refer to Appendix B and C.



3.6 AC Conducted Emission Measurement

3.6.1 Limit of AC Conducted Emission

For equipment that is designed to be connected to the public utility (AC) power line, the radio frequency voltage that is conducted back onto the AC power line on any frequency or frequencies within the band 150 kHz to 30 MHz shall not exceed the limits in the following table.

Frequency of emission (MHz)	Conducted limit (dB μ V)	
	Quasi-peak	Average
0.15-0.5	66 to 56*	56 to 46*
0.5-5	56	46
5-30	60	50

*Decreases with the logarithm of the frequency.

3.6.2 Measuring Instruments

The section 4.0 of List of Measuring Equipment of this test report is used for test.

3.6.3 Test Procedures

1. The EUT was placed 0.4 meter from the conducting wall of the shielding room was kept at least 80 centimeters from any other grounded conducting surface.
2. Connect EUT to the power mains through a line impedance stabilization network (LISN).
3. All the support units are connecting to the other LISN.
4. The LISN provides 50 ohm coupling impedance for the measuring instrument.
5. The FCC states that a 50 ohm, 50 microhenry LISN should be used.
6. Both sides of AC line were checked for maximum conducted interference.
7. The frequency range from 150 kHz to 30 MHz was searched.
8. Set the test-receiver system to Peak Detect Function and specified bandwidth (IF Bandwidth = 9kHz) with Maximum Hold Mode. Then measurement is also conducted by Average Detector and Quasi-Peak Detector Function respectively.

3.6.4 Test Setup

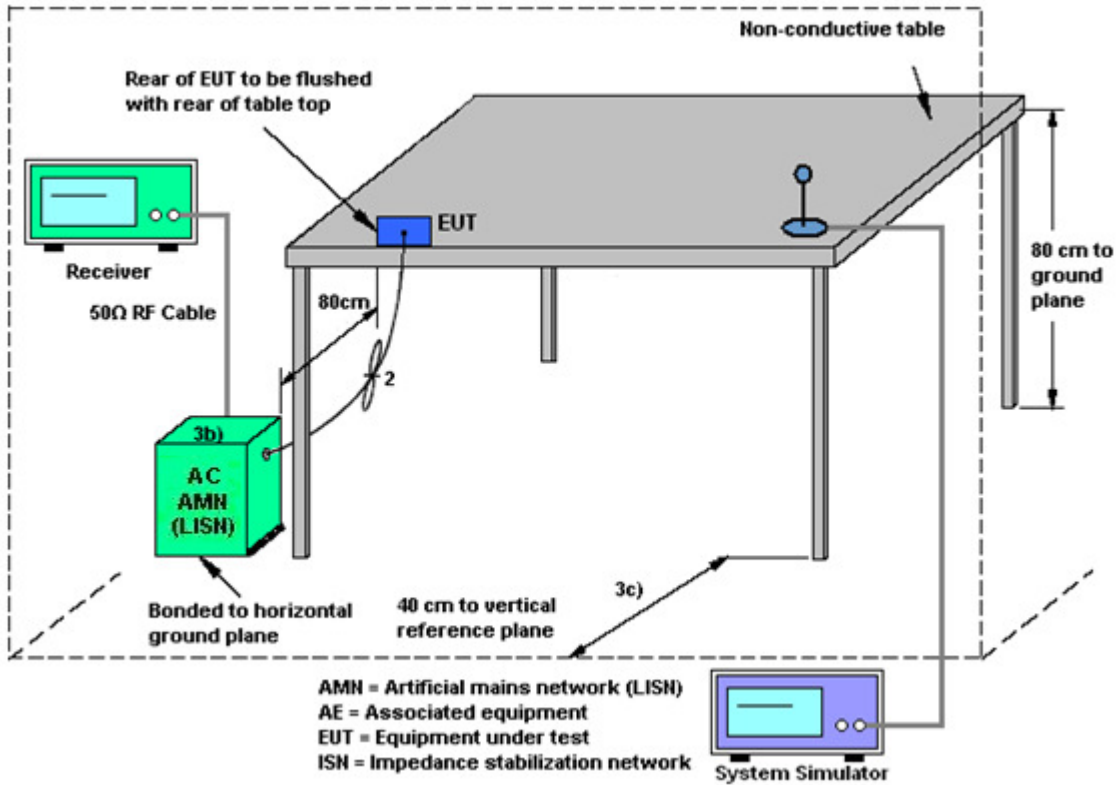



3.6.5 Test Result of AC Conducted Emission

Test Mode :	Mode 1	Temperature :	24~25°C
Test Engineer :	Kai-Chun Chu	Relative Humidity :	45~46%
Test Voltage :	120Vac / 60Hz	Phase :	Line
Function Type :	GSM1900 Idle + Bluetooth Link + Smart Card Reader + Magnetic Card Reader + RFID Tx + Battery 1 + Charging from Adapter 1 + RS-232/4-Pin Cable (Load) + RS-232/RJ11 Cable (Load) + Printer + SAM Card + Micro SD Card + Primary Micro-USB Port (Cable Load) + Secondary Micro-USB Port (Data Link with USB Storage Device)		

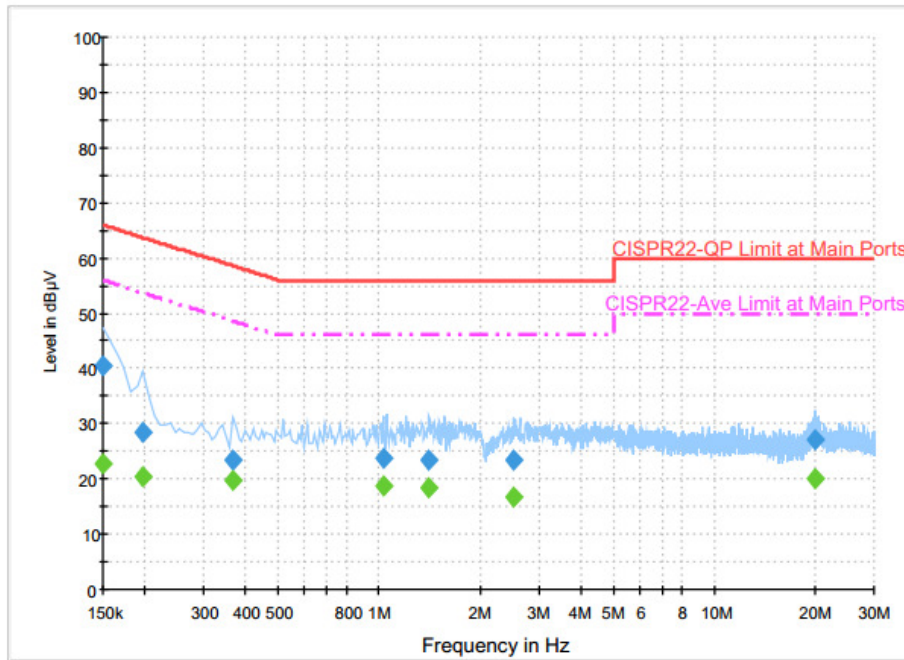

Final Result : Quasi-Peak

Frequency (MHz)	Quasi-Peak (dBµV)	Filter	Line	Corr. (dB)	Margin (dB)	Limit (dBµV)
0.150000	40.4	Off	L1	19.6	25.6	66.0
0.198000	28.3	Off	L1	19.6	35.4	63.7
0.366000	23.6	Off	L1	19.6	35.0	58.6
1.030000	23.8	Off	L1	19.7	32.2	56.0
1.414000	23.3	Off	L1	19.7	32.7	56.0
2.534000	23.5	Off	L1	19.2	32.5	56.0
19.982000	26.9	Off	L1	20.7	33.1	60.0

Final Result : Average

Frequency (MHz)	Average (dBµV)	Filter	Line	Corr. (dB)	Margin (dB)	Limit (dBµV)
0.150000	22.7	Off	L1	19.6	33.3	56.0
0.198000	20.5	Off	L1	19.6	33.2	53.7
0.366000	19.7	Off	L1	19.6	28.9	48.6
1.030000	18.9	Off	L1	19.7	27.1	46.0
1.414000	18.5	Off	L1	19.7	27.5	46.0
2.534000	16.8	Off	L1	19.2	29.2	46.0
19.982000	20.0	Off	L1	20.7	30.0	50.0



Test Mode :	Mode 1	Temperature :	24~25°C
Test Engineer :	Kai-Chun Chu	Relative Humidity :	45~46%
Test Voltage :	120Vac / 60Hz	Phase :	Neutral
Function Type :	GSM1900 Idle + Bluetooth Link + Smart Card Reader + Magnetic Card Reader + RFID Tx + Battery 1 + Charging from Adapter 1 + RS-232/4-Pin Cable (Load) + RS-232/RJ11 Cable (Load) + Printer + SAM Card + Micro SD Card + Primary Micro-USB Port (Cable Load) + Secondary Micro-USB Port (Data Link with USB Storage Device)		

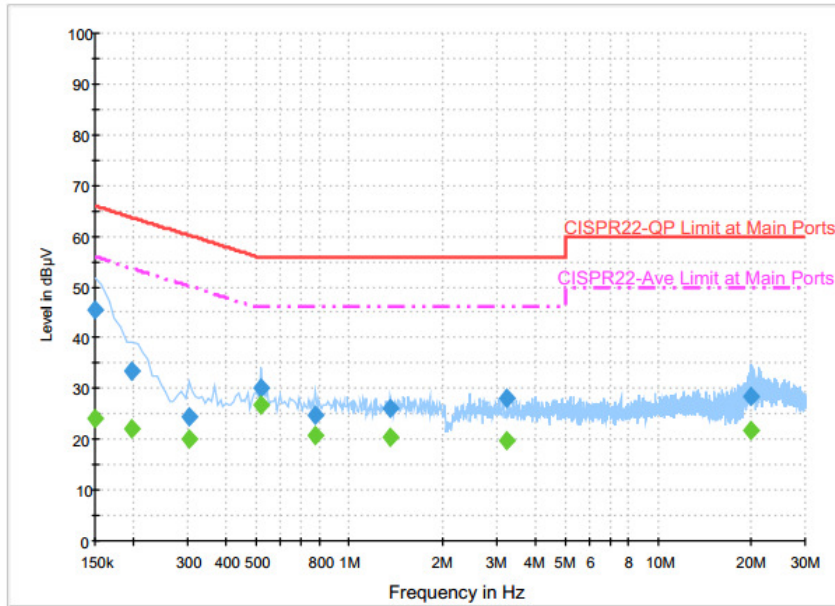

Final Result : Quasi-Peak

Frequency (MHz)	Quasi-Peak (dBµV)	Filter	Line	Corr. (dB)	Margin (dB)	Limit (dBµV)
0.150000	45.3	Off	N	19.6	20.7	66.0
0.198000	33.6	Off	N	19.6	30.1	63.7
0.302000	24.5	Off	N	19.6	35.7	60.2
0.518000	30.0	Off	N	19.6	26.0	56.0
0.774000	24.9	Off	N	19.6	31.1	56.0
1.358000	26.2	Off	N	19.7	29.8	56.0
3.238000	28.0	Off	N	19.7	28.0	56.0
20.086000	28.5	Off	N	20.8	31.5	60.0

Final Result : Average

Frequency (MHz)	Average (dBµV)	Filter	Line	Corr. (dB)	Margin (dB)	Limit (dBµV)
0.150000	24.2	Off	N	19.6	31.8	56.0
0.198000	22.0	Off	N	19.6	31.7	53.7
0.302000	20.2	Off	N	19.6	30.0	50.2
0.518000	26.7	Off	N	19.6	19.3	46.0
0.774000	20.6	Off	N	19.6	25.4	46.0
1.358000	20.3	Off	N	19.7	25.7	46.0
3.238000	19.8	Off	N	19.7	26.2	46.0
20.086000	21.7	Off	N	20.8	28.3	50.0



3.7 Antenna Requirements

3.7.1 Standard Applicable

If directional gain of transmitting antennas is greater than 6dBi, the power shall be reduced by the same level in dB comparing to gain minus 6dBi. The use of a permanently attached antenna or of an antenna that uses a unique coupling to the intentional radiator shall be considered sufficient to comply with the FCC rule.

3.7.2 Antenna Anti-Replacement Construction

An embedded-in antenna design is used.

3.7.3 Antenna Gain

The antenna peak gain of EUT is less than 6 dBi. Therefore, it is not necessary to reduce maximum peak output power limit.



4 List of Measuring Equipment

Instrument	Manufacturer	Model No.	Serial No.	Characteristics	Calibration Date	Test Date	Due Date	Remark
Power Meter	Agilent	E4416A	GB412923 44	300MHz~40GHz	Jan. 08, 2016	Oct. 05, 2016 ~ Oct. 06, 2016	Jan. 07, 2017	Conducted (TH02-HY)
Power Sensor	Agilent	E9327A	US404415 48	300MHz~40GHz	Jan. 07, 2016	Oct. 05, 2016 ~ Oct. 06, 2016	Jan. 06, 2017	Conducted (TH02-HY)
Spectrum Analyzer	Rohde & Schwarz	FSP40	100055	9kHz~40GHz	Jun. 17, 2016	Oct. 05, 2016 ~ Oct. 06, 2016	Jun. 16, 2017	Conducted (TH02-HY)
Loop Antenna	Rohde & Schwarz	HFH2-Z2	100315	9 kHz~30 MHz	Sep. 02, 2015	Oct. 07, 2016	Sep. 01, 2017	Radiation (03CH10-HY)
Amplifier	SONOMA	310N	187311	9kHz~1GHz	Nov. 16, 2015	Oct. 07, 2016	Nov. 15, 2016	Radiation (03CH10-HY)
Bilog Antenna	TESEQ	CBL 6111D&00800 N1D01N-06	35413&02	30MHz~1GHz	Jan. 13, 2016	Oct. 07, 2016	Jan. 12, 2017	Radiation (03CH10-HY)
Horn Antenna	SCHWARZBE CK	BBHA 9120 D	9120D-132 5	1GHz ~ 18GHz	Sep. 30, 2016	Oct. 07, 2016	Sep. 29, 2017	Radiation (03CH10-HY)
Preamplifier	Keysight	83017A	MY532700 78	1GHz~26.5GHz	Nov. 13, 2015	Oct. 07, 2016	Nov. 12, 2016	Radiation (03CH10-HY)
Preamplifier	MITEQ	AMF-7D-00101 800-30-10P	1902246	1GHz~18GHz	Nov. 16, 2015	Oct. 07, 2016	Nov. 15, 2016	Radiation (03CH10-HY)
Spectrum Analyzer	Keysight	N9010A	MY542004 85	10Hz ~ 44GHz	Oct. 15, 2015	Oct. 07, 2016	Oct. 14, 2016	Radiation (03CH10-HY)
Antenna Mast	EMEC	AM-BS-4500-B	N/A	1~4m	N/A	Oct. 07, 2016	N/A	Radiation (03CH10-HY)
Turn Table	EMEC	TT 2200	N/A	0~360 Degree	N/A	Oct. 07, 2016	N/A	Radiation (03CH10-HY)
Preamplifier	MITEQ	JS44-1800400 0-33-8P	1840917	18GHz ~ 40GHz	Jun. 14, 2016	Oct. 07, 2016	Jun. 13, 2017	Radiation (03CH10-HY)
SHF-EHF Horn Antenna	SCHWARZBE CK	BBHA 9170	BBHA9170 584	18GHz- 40GHz	Nov. 02, 2015	Oct. 07, 2016	Nov. 01, 2016	Radiation (03CH10-HY)
EMI Test Receiver	Agilent	N9038A(MXE)	MY532900 53	20Hz to 26.5GHz	Jan. 20, 2016	Oct. 07, 2016	Jan. 19, 2017	Radiation (03CH10-HY)
AC Power Source	ChainTek	APC-1000W	N/A	N/A	N/A	Oct. 12, 2016	N/A	Conduction (CO05-HY)
EMI Test Receiver	Rohde & Schwarz	ESCI 7	100724	9kHz~7GHz	Aug. 30, 2016	Oct. 12, 2016	Aug. 29, 2017	Conduction (CO05-HY)
LISN	Rohde & Schwarz	ENV216	100080	9kHz~30MHz	Dec. 02, 2015	Oct. 12, 2016	Dec. 01, 2016	Conduction (CO05-HY)
LISN	Rohde & Schwarz	ENV216	100081	9kHz~30MHz	Dec. 14, 2015	Oct. 12, 2016	Dec. 13, 2016	Conduction (CO05-HY)



5 Uncertainty of Evaluation

Uncertainty of Conducted Emission Measurement (150 kHz ~ 30 MHz)

Measuring Uncertainty for a Level of Confidence of 95% ($U = 2Uc(y)$)	2.7
---	-----

Uncertainty of Radiated Emission Measurement (30 MHz ~ 1000 MHz)

Measuring Uncertainty for a Level of Confidence of 95% ($U = 2Uc(y)$)	5.6
---	-----

Uncertainty of Radiated Emission Measurement (1000 MHz ~ 18000 MHz)

Measuring Uncertainty for a Level of Confidence of 95% ($U = 2Uc(y)$)	5.9
---	-----

Uncertainty of Radiated Emission Measurement (18000 MHz ~ 40000 MHz)

Measuring Uncertainty for a Level of Confidence of 95% ($U = 2Uc(y)$)	5.2
---	-----



Appendix A. Conducted Test Results