

HF-LPB100

Low Power Wi-Fi Module User Manual

V 1.9



Overview of Characteristic

- ✧ Support IEEE802.11b/g/n Wireless Standards
- ✧ Based on Self-developed High Cost Effective MCU
- ✧ Ultra-Low-Power for Battery Applications with Excellent Power Save Scheme
- ✧ Support UART/SPI/PWM/GPIO Data Communication Interface
- ✧ Support Work As STA/AP/AP+STA Mode
- ✧ Support Smart Link Function (APP program provide)
- ✧ Support Wireless and Remote Firmware Upgrade Function
- ✧ Support WPS Function
- ✧ Support Multi-TCP Link (5 Channel) Application
- ✧ Support Internal/External(I-PEX/SMA) Antenna Option
- ✧ Single +3.3V Power Supply
- ✧ Smallest Size: 23.1mm x 32.8mm x (3.45±0.3)mm
- ✧ FCC/CE/TELEC Certificated

TABLE OF CONTENTS

LIST OF FIGURES	6
LIST OF TABLES	7
HISTORY	8
1. PRODUCT OVERVIEW	9
1.1. General Description	9
1.1.1 Device Features.....	9
1.1.2 Device Parameters	10
1.1.3 Key Application	10
1.2. Hardware Introduction	11
1.2.1. Pins Definition	11
1.2.2. Electrical Characteristics	13
1.2.3. Mechanical Size.....	14
1.2.4. On-board PCB Antenna.....	15
1.2.5. External Antenna	15
1.2.6. Evaluation Kit.....	16
1.2.7. Order Information.....	17
1.3. Typical Application	18
1.3.1. Hardware Typical Application	18
2. FUNCTIONAL DESCRIPTION	20
2.1. Wireless Networking	20
2.1.1. Basic Wireless Network Based On AP (Infrastructure)	20
2.1.2. Wireless Network Based On AP+STA.....	20
2.2. Work Mode : Transparent Transmission Mode	21
2.3. UART Frame Scheme	22
2.3.1. UART Free-Frame	22
2.3.2. UART Auto-Frame	22
2.4. Encryption	23
2.5. Parameters Configuration	23
2.6. Firmware Update	23
2.7. GPIO/PWM Function	24
2.8. SOCKET B Function	24
2.9. Multi-TCP Link Connection	25
3. OPERATION GUIDELINE	26
3.1. Configuration via Web Accessing	26
3.1.1. Open Web Management Interface	26
3.1.2. System Page.....	27
3.1.3. Work Mode Page	27
3.1.4. STA Setting Page	27
3.1.5. AP Setting Page	28
3.1.6. Other Setting Page	28
3.1.7. Account Management Page	29

3.1.8.	Upgrade Software Page	29
3.1.9.	Restart Page	30
3.1.10.	Restore Page	30
3.1.11.	Internal Webpage	31
3.2.	HF-LPB100 Usage Introduction	31
3.2.1.	Software Debug Tools	31
3.2.2.	Network Connection	32
3.2.3.	Default Parameter Setting	32
3.2.4.	Module Debug	32
3.3.	Typical Application Examples	34
3.3.1.	Wireless Control Application	34
3.3.2.	Remote Management Application	34
3.3.3.	Transparent Serial Port Application	35
4.	AT+INSTRUCTION INTRODUCTION	36
4.1.	Configuration Mode	36
4.1.1.	Switch to Configuration Mode	36
4.2.	AT+Instruction Set Overview	37
4.2.1.	Instruction Syntax Format	37
4.2.2.	AT+Instruction Set	38
4.2.2.1.	AT+E	40
4.2.2.2.	AT+WMODE	40
4.2.2.3.	AT+ENTM	41
4.2.2.4.	AT+TMODE	41
4.2.2.5.	AT+MID	41
4.2.2.6.	AT+VER	42
4.2.2.7.	AT+LVER	42
4.2.2.8.	AT+FWSZ	42
4.2.2.9.	AT+RELD	42
4.2.2.10.	AT+FCLR	42
4.2.2.11.	AT+Z	43
4.2.2.12.	AT+H	43
4.2.2.13.	AT+CFGTF	43
4.2.2.14.	AT+UART	43
4.2.2.15.	AT+UARTF	44
4.2.2.16.	AT+UARTFT	44
4.2.2.17.	AT+UARTFL	44
4.2.2.18.	AT+UARTTE	44
4.2.2.19.	AT+SEND	45
4.2.2.20.	AT+RECV	45
4.2.2.21.	AT+PING	45
4.2.2.22.	AT+NETP	46
4.2.2.23.	AT+MAXSK	46
4.2.2.24.	AT+TCPLK	46
4.2.2.25.	AT+TCPTO	47

4.2.2.26.	AT+TCPDIS.....	47
4.2.2.27.	AT+SOCKB	47
4.2.2.28.	AT+TCPDISB	48
4.2.2.29.	AT+TCPTOB	48
4.2.2.30.	AT+TCPLKB	49
4.2.2.31.	AT+SNDB	49
4.2.2.32.	AT+RCVB	49
4.2.2.33.	AT+WSSSID.....	49
4.2.2.34.	AT+WSKEY	50
4.2.2.35.	AT+WANN	50
4.2.2.36.	AT+WSMAC	51
4.2.2.37.	AT+WSLK.....	51
4.2.2.38.	AT+WSLQ	51
4.2.2.39.	AT+WSCAN.....	51
4.2.2.40.	AT+WSDNS.....	52
4.2.2.41.	AT+LANN	52
4.2.2.42.	AT+WAP	52
4.2.2.43.	AT+WAKEY	53
4.2.2.44.	AT+WAMAC	53
4.2.2.45.	AT+WADHCP	53
4.2.2.46.	AT+WADMN	54
4.2.2.47.	AT+WALK.....	54
4.2.2.48.	AT+WALKIND.....	54
4.2.2.49.	AT+PLANG	54
4.2.2.50.	AT+UPURL.....	55
4.2.2.51.	AT+UPFILE	55
4.2.2.52.	AT+LOGSW.....	55
4.2.2.53.	AT+LOGPORT	56
4.2.2.54.	AT+UPST	56
4.2.2.55.	AT+WEBU	56
4.2.2.56.	AT+MSLP	57
4.2.2.57.	AT+NTPRF	57
4.2.2.58.	AT+NTPEN.....	57
4.2.2.59.	AT+NTPTM.....	57
4.2.2.60.	AT+NTPSER	58
4.2.2.61.	AT+WRMID	58
4.2.2.62.	AT+RLDEN.....	58
4.2.2.63.	AT+ASWD	58
4.2.2.64.	AT+MDCH	59
4.2.2.65.	AT+TXPWR.....	59
4.2.2.66.	AT+SMTLK.....	59
4.2.2.67.	AT+SMTLKVER.....	60
4.2.2.68.	AT+WPS.....	60
4.2.2.69.	AT+WPSBTNEN.....	60

4.2.2.70.	AT+LPTIO.....	61
4.2.2.71.	AT+WIFI	61
4.2.2.72.	AT+SMEM	62
5.	PACKAGE INFORMATION	63
5.1.	Recommended Reflow Profile	63
5.2.	Device Handling Instruction (Module IC SMT Preparation).....	63
5.3.	Shipping Information	64
APPENDIX A: HW REFERENCE DESIGN		65
APPENDIX B: CONTROL GPIO/PWM FUNCTION WITH NETWORK COMMANDS.....		66
B.1	Network Command	66
B.2	Hexadecimal Network Command.....	69
APPENDIX C: HTTP PROTOCOL TRANSFER.....		72
C.1.	HTTP AT command.....	72
C.1.1.	AT+HTTTPURL.....	72
C.1.2.	AT+HTTTPTP	72
C.1.3.	AT+HTTTPPH.....	72
C.1.4.	AT+HTTTPCN.....	73
C.1.5.	AT+HTTTPUA.....	73
C.1.6.	AT+HTTTPDT	73
C.2.	HTTP Example.....	73
C.3.	Sending HTTP Raw Data in Throughput Mode(Recommend).....	74
C.4.	Sending HTTP Request By AT Command.....	75
APPENDIX D:REFERENCES		77
D.1.	High-Flying Mass Production Tool.....	77
D.2.	SmartLink APP V3 Config Tool.....	77
D.2.1.	SmartLink APP V4 Config Tool(For LPB100U only)	77
D.3.	EVK Quick Start Guide	77
D.4.	SDK Download	77
APPENDIX E: CONTACT INFORMATION		78

LIST OF FIGURES

Figure 1.	HF-LPB100 View	11
Figure 2.	HF-LPB100 Pins Map.....	11
Figure 3.	HF-LPB100 Mechanical Dimension	14
Figure 4.	HF-LPB100 PCB Symbol Size	14
Figure 5.	Suggested Module Placement Region.....	15
Figure 6.	HF-LPB100 Evaluation Kit.....	16
Figure 7.	HF-LPB100 Order Information	17
Figure 8.	HF-LPB100 Hardware Typical Application	18
Figure 9.	HF-LPB100 Basic Wireless Network Structure	20
Figure 10.	HF-LPB100 AP+STA Network Structure	21
Figure 11.	Socket B function demo.....	25
Figure 12.	Multi-TCP Link Data Transmission Structure	25
Figure 13.	Open Web Management page.....	26
Figure 14.	System Web Page	27
Figure 15.	Work Mode Page	27
Figure 16.	STA Setting Page	28
Figure 17.	AP Setting Page	28
Figure 18.	Other Setting Page	29
Figure 19.	Account Page.....	29
Figure 20.	Upgrade SW page	30
Figure 21.	Restart Page.....	30
Figure 22.	Restore Page.....	31
Figure 23.	Internal Webpage	31
Figure 24.	STA Interface Debug Connection.....	32
Figure 25.	AP Interface Debug Connection	32
Figure 26.	“CommTools” Serial Debug Tools	32
Figure 27.	“TCPUDPDbg” Tools Create Connection	33
Figure 28.	“TCPUDPDbg” Tools Setting	33
Figure 29.	“TCPUDPDbg” Tools Connection	33
Figure 30.	Wireless Control Application.....	34
Figure 31.	Remote Management Application.....	34
Figure 32.	Transparent Serial Port Application.....	35
Figure 33.	HF-LPB100 Default UART Port Parameters	36
Figure 34.	Switch to Configuration Mode.....	36
Figure 35.	”AT+H” Instruction for Help	37
Figure 36.	Reflow Soldering Profile	63
Figure 37.	Shipping Information.....	64

LIST OF TABLES

Table 1	HF-LPB100 Module Technical Specifications	10
Table 2	HF-LPB100 Pins Definition.....	11
Table 3	HF-LPB100 External Antenna Parameters	15
Table 4	HF-LPB100 Evaluation Kit Interface Description	16
Table 7	HF-LPB100 GPIO/PWM Pin Mapping Table.....	24
Table 8	HF-LPB100 Web Access Default Setting.....	26
Table 9	Error Code Description.....	38
Table 10	AT+Instruction Set List	38
Table 11	Reflow Soldering Parameter	63

HISTORY

- Ed. V1.0** 08-01-2013 First Version.
- Ed. V1.1** 09-10-2013 Update AT command.
- Ed. V1.2** 10-10-2013 Update AT command. Update PWM/GPIO function. Add HTTP protocol demo. Add auto-frame function.
- Ed. V1.3** 10-18-2013 Update module view, add nReload Pin wireless upgrade and config description, add nLink Pin wireless upgrade indication description.
- Ed. V1.4** 12-02-2013 Update AT command, add AT+WALK, AT+WALKIND, AT+WPS,AT+WPSBTN, AT+FWSZ, add HF-LPB100-SMA type.
- Ed. V1.5** 01-02-2014. Update AT command, add AT+SMTLK、 AT+LPTIO.
- Ed. V1.51** 01-22-2014. Update Shipping information.
- Ed. V1.6** 05-10-2014. Update GPIO description. Update SDK download. Add “AT+UDPLCPT”, “AT+NTPSER” command. Update Shipping information.
- Ed. V1.7** 09-25-2014. Correct module height size. Add AT+WIFI, AT+SMEM command. Modify AT+RECV command. Modify AT+UARTTE, AT+TCPTOB, AT+FWSZ command description. Delete AT+UDPLCPT, AT+CFGWR, AT+CFGFR, AT+CFGRD command. Delete uart baud rate 300, 921600.
- Ed. V1.8** 02-26-2015. Delete 600 baud rate. Correct module peak current. Add HTTP test example. Correct AT+WADHCP、 AT+WSKEY、 AT+NTPTM、 AT+WAP command description. Add AT+SMTLKVER(LPB100U). Modify company address.
- Ed. V1.9** 07-20-2015. Delete the reserved function description(PWR pin function description and so on). Modify the module label. Add 3 more PWM Channel.

1. PRODUCT OVERVIEW

1.1. General Description

The HF-LPB100 is a fully self-contained small form-factor, single stream, 802.11b/g/n Wi-Fi module, which provide a wireless interface to any equipment with a Serial/SPI interface for data transfer. HF-LPB100 integrate MAC, baseband processor, RF transceiver with power amplifier in hardware and all Wi-Fi protocol and configuration functionality and networking stack, in embedded firmware to make a fully self-contained 802.11b/g/n Wi-Fi solution for a variety of applications.

The HF-LPB100 employs the world's lowest power consumption embedded architecture. It has been optimized for all kinds of client applications in the home automation, smart grid, handheld device, personal medical application and industrial control that have lower data rates, and transmit or receive data on an infrequent basis.

The HF-LPB100 integrates all Wi-Fi functionality into a low-profile, 23.1x32.8x 2.7mm SMT module package that can be easily mounted on main PCB with application specific circuits. Also, module provides built-in antenna, external antenna option.

1.1.1 Device Features

- Single stream Wi-Fi @ 2.4 GHz with support for WEP security mode as well as WPA/WPA2
- Based on Self-developed High Cost Performance MCU
- Ultra-low-power operation with all kinds of power-save modes.
- Includes all the protocol and configuration functions for Wi-Fi connectivity.
- Support STA/AP/AP+STA Mode
- Support Smart Link Function
- Support Wireless and Remote Firmware Upgrade Function
- Support Max 8 Channel PWM/GPIO Output
- Integrated pcb antenna, antenna connector options.
- Compact surface mount module 23.1mm x 32.8mm x (3.45±0.3)mm.
- Full IPv4 stack.
- Low power RTOS and drivers.
- CE/FCC/TELEC Certified.
- RoHS compliant.
- Single supply – 3.3V operation.

1.1.2 Device Parameters

Table 1 HF-LPB100 Module Technical Specifications

Class	Item	Parameters	
Wireless Parameters	Certification	FCC/CE	
	Wireless standard	802.11 b/g/n	
	Frequency range	2.412GHz-2.484GHz	
	Transmit Power		802.11b +17dBm (@11Mbps)
			802.11g +22dBm (@54Mbps)
			802.11n +22dBm (@HT20 MCS7)
	Receiver Sensitivity		802.11b: -93 dBm (@11Mbps ,CCK)
		802.11g: -85 dBm (@54Mbps, OFDM)	
		802.11n: -82 dBm (@HT20, MCS7)	
Antenna Option		External:I-PEX Connector or SMA connector	
		Internal:On-board PCB antenna	
Hardware Parameters	Data Interface	UART	
		SPI, PWM, GPIO	
	Operating Voltage	2.8~3.6V	
	Operating Current	Peak [Continuous TX]: ~300mA Normal [WiFi ON/OFF, DTIM=100ms]: Average. ~12mA, Peak: 300mA	
	Operating Temp.	-40°C - 85°C	
	Storage Temp.	-45°C - 125°C	
Dimensions and Size	23.1mm×32.8mm×(3.45±0.3)mm		
Software Parameters	Network Type	STA /AP/STA+AP	
	Security Mechanisms	WEP/WPA-PSK/WPA2-PSK	
	Encryption	WEP64/WEP128/TKIP/AES	
	Update Firmware	Local Wireless, Remote	
	Customization	Web Page Upgrade Support SDK for application develop	
	Network Protocol	IPv4, TCP/UDP/HTTP	
	User Configuration	AT+instruction set. Android/ iOS Smart Link APP tools	

1.1.3 Key Application

- Remote equipment monitoring
- Asset tracking and telemetry
- Security
- Industrial sensors and controls
- Home automation
- Medical devices

1.2. Hardware Introduction

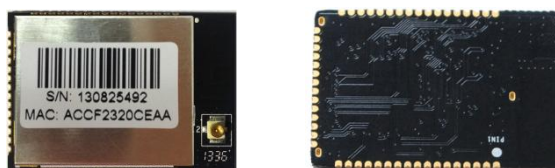

Figure 1. HF-LPB100 View

1.2.1. Pins Definition

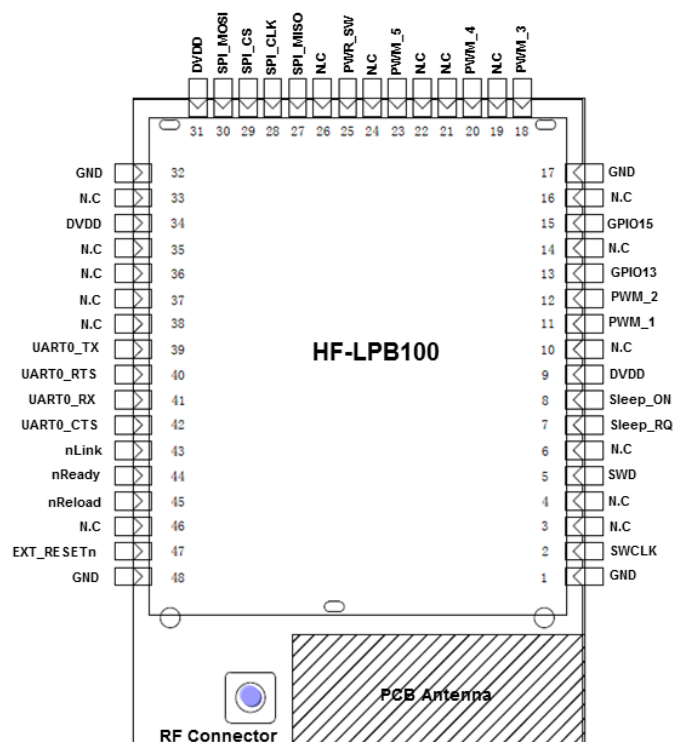

Figure 2. HF-LPB100 Pins Map

Table 2 HF-LPB100 Pins Definition

Pin	Description	Net Name	Signal Type	Comments
1,17,32,48	Ground	GND	Power	
2	Debug Pin	SWCLK	I, PD	Debug functional pin, No connect if not use.
3		NC		
4		NC		
5	Debug Pin	SWD	I/O,PU	
6		N.C		No connect
7	GPIO/AD	Sleep_RQ	I.PU	GPIO7, No connect if not use.
8	GPIO/AD	Sleep_ON	O	GPIO8, No connect if not use.

Pin	Description	Net Name	Signal Type	Comments
9	+3.3V Power	DVDD	Power	
10		N.C		No connect
11	PWM/GPIO/AD	PWM_1	I/O	GPIO11, No connect if not use.
12	PWM/GPIO/AD	PWM_2	I/O	GPIO12, No connect if not use.
13	GPIO	GPIO13	I/O	GPIO13, No connect if not use.
14		N.C		No connect
15	WPS/GPIO	GPIO15	I/O	GPIO15, WPS Function Pin.
16		N.C		No connect
18	PWM/GPIO	PWM_3	I/O	GPIO18, No connect if not use.
19		N.C		No connect
20	PWM/GPIO	PWM_4	I/O	GPIO20, No connect if not use.
21		N.C		No connect
22		N.C		No connect
23	PWM/GPIO/AD	PWM_5	I/O	GPIO23, No connect if not use.
24		N.C		No connect
25	Power Control Switch	PWR_SW	I,PU	Leave it no connect
26		N.C		No connect
27	SPI Interface/AD/PWM	SPI_MISO	I	GPIO27, No connect if not use.
28	SPI Interface/PWM	SPI_CLK	I/O	GPIO28, No connect if not use.
29	SPI Interface/AD	SPI_CS	I/O	GPIO29, No connect if not use.
30	SPI Interface/PWM	SPI_MOSI	O	GPIO30, No connect if not use.
31	+3.3V Power	DVDD	Power	
33		N.C		No connect
34	+3.3 Power	DVDD	Power	
35		N.C		No connect
36		N.C		No connect
37		N.C		No connect
38		N.C		No connect
39	UART0	UART0_TX	O	GPIO39, No connect if not use.
40	UART0	UART0_RTS	I/O	GPIO40, No connect if not use.
41	UART0	UART0_RX	I	GPIO41, No connect if not use.
42	UART0	UART0_CTS	I/O	GPIO42, No connect if not use.
43	Wi-Fi Status	nLink	O	Detailed functions see <Notes>
44	Module Boot Up Indicator	nReady	O	“0” – Boot-up OK; “1” – Boot-up No OK; No connect if not use.;
45	Multi-Function	nReload	I,PU	Detailed functions see <Notes>
46		N.C		No connect
47	Module Reset	EXT_RESETn	I,PU	“Low” effective reset input.

<Notes>

nReload Pin (Button) function:

1. When this pin is set to “low” during module boot up, the module will enter wireless firmware and config upgrade mode. This mode is used for customer manufacture. (See Appendix D to download software tools for customer batch configuration and upgrade firmware during mass production)
2. After module is powered up, short press this button (“Low” <= 2s) to make the module go into “Smart Link “ config mode, waiting for APP to set password and other information. (See Appendix D to download SmartLink APP)
3. After module is powered up, long press this button (“Low” >= 4s) to make the module recover to factory setting.

High-Flying strongly suggest customer fan out this pin to connector or button for “Manufacture” and “ Smart Link” application.

nLink Pin (LED) function:

1. At wireless firmware and config upgrade mode , this LED used to indicate configure and upgrade status.
2. At “Smart Link “ config mode, this LED used to indicate APP to finish setting.
3. At normal mode, it’s Wi-Fi link status indicator

High-Flying strongly suggest customer fan out this pin to LED.

1.2.2. Electrical Characteristics

Absolute Maximum Ratings:

Parameter	Condition	Min.	Typ.	Max.	Unit
Storage temperature range		-45		125	°C
Maximum soldering temperature	IPC/JEDEC J-STD-020			260	°C
Supply voltage		0		3.8	V
Voltage on any I/O pin		0		3.3	V
ESD (Human Body Model HBM)	TAMB=25°C			2	KV
ESD (Charged Device Model, CDM)	TAMB=25°C			1	KV

Power Supply & Power Consumption:

Parameter	Condition	Min.	Typ.	Max.	Unit
Operating Supply voltage		2.8	3.3	3.8	V
Supply current, peak	Continuous Tx		300		mA
Supply current, IEEE PS	DTIM=100ms		12		mA
Output high voltage	Sourcing 6mA	2.8			V
Output low voltage	Sinking 6mA			0.2	V
Input high voltage		2.2			V
Input low voltage				0.8	V
GPIO Input pull-up resistor			200		kΩ
GPIO Input pull-down resistor			200		kΩ

1.2.3. Mechanical Size

HF-LPB100 modules physical size (Unit: mm) as follows:

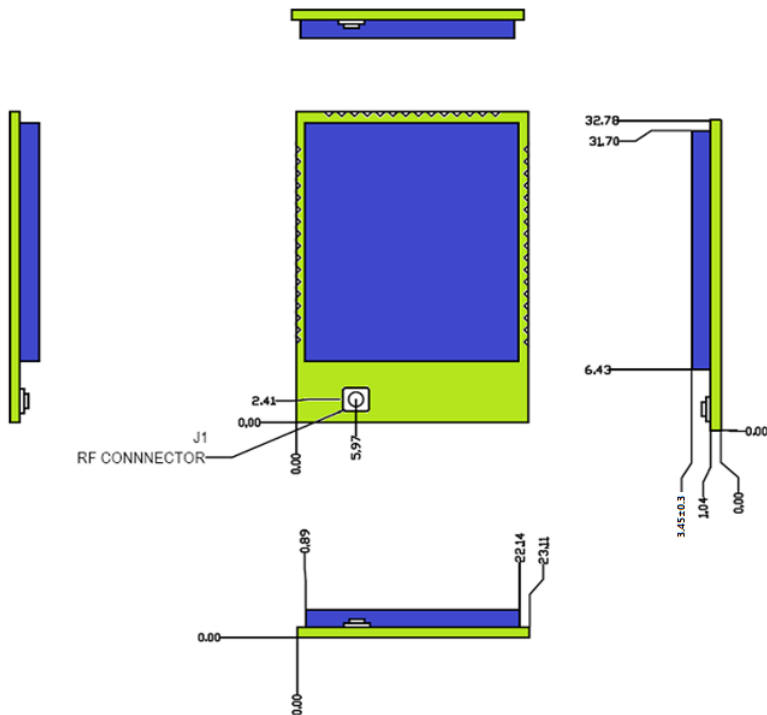

Figure 3. HF-LPB100 Mechanical Dimension

HF-LPB100 Module PCB symbol size (mm) as follows:

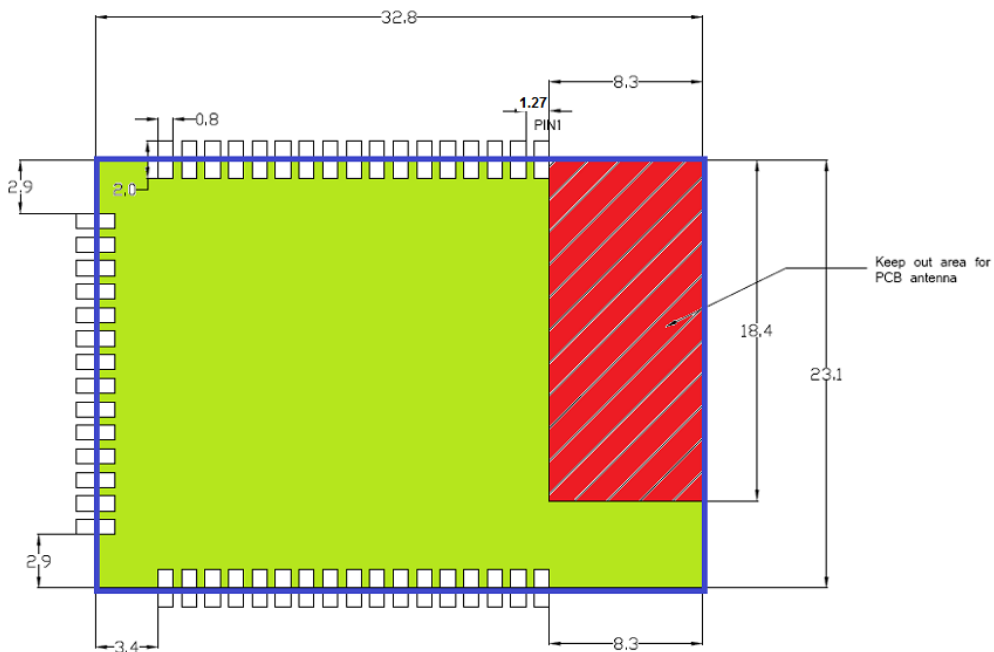

Figure 4. HF-LPB100 PCB Symbol Size

1.2.4. On-board PCB Antenna

HF-LPB100 module support internal on-board PCB antenna option. When customer select internal antenna, you shall comply with following antenna design rules and module location suggestions:

- For customer PCB, RED color region (8.3x18.4mm) can't put componet or paste GND net;
- Antenna must away from metal or high components at least 10mm;
- Antenna can't be shielded by any metal enclosure;

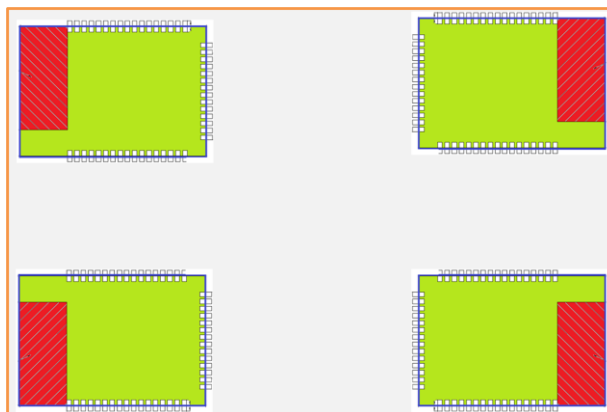

Figure 5. Suggested Module Placement Region

High-Flying suggest HF-LPB100 module better locate in following region at customer board, which to reduce the effect to antenna and wireless signal, and better consult High-Flying technical people when you structure your module placement and PCB layout.

1.2.5. External Antenna

HF-LPB100 module supports internal antenna and external antenna(I-PEX or SMA) option for user dedicated application.

If user select external antenna, HF-LPB100 modules must be connected to the 2.4G antenna according to IEEE 802.11b/g/n standards.

The antenna parameters required as follows:

Table 3 HF-LPB100 External Antenna Parameters

Item	Parameters
Frequency range	2.4~2.5GHz
Impedance	50 Ohm
VSWR	2 (Max)
Return Loss	-10dB (Max)
Connector Type	I-PEX or populate directly

1.2.6. Evaluation Kit

High-Flying provides the evaluation kit to promote user to familiar the product and develop the detailed application. The evaluation kit shown as below, user can connect to HF-LPB100 module with the RS-232 UART, RS485, USB (Internal USB to UART converter) or Wireless port to configure the parameters, manage the module or do the some functional tests.

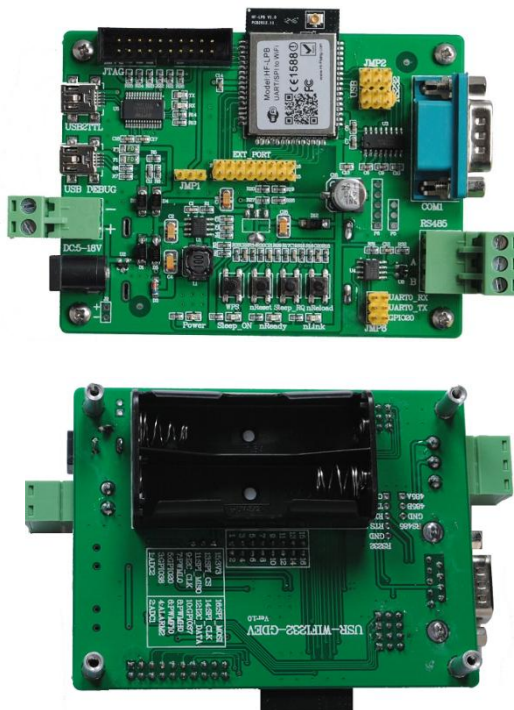

Figure 6. HF-LPB100 Evaluation Kit

Notes: User need download USB to UART port driver from High-Flying web or contact with technical support people for more detail.

The external interface description for evaluation kit as follows:

Table 4 HF-LPB100 Evaluation Kit Interface Description

Function	Name	Description
External Interface	COM1	Main data/command RS-232 interface
	RS485	Main data/command RS-485 interface
	JTAG	JTAG data debug interface (Not for user use)
	USB2TTL	UART to USB debug interface. (For PC without RS232, need load driver). Can be Power input.
	USB DEBUG	USB2.0 data interface. (Reserved)
	DC Jack	DC jack for power in, 5~18V input.
	DC5-18V	DC jack for power in, 5~18V input.
	BAT	2 Li-Battery Power Supply.
	EXT PORT	HF-LPB100 GPIO function extend interface connector

Function	Name	Description
External Interface	JMP1,JMP2	Reserved , No Jumper required.
	JMP3	4Pin USB or RS232 Jumper. Left jump select USB.
	JMP6	3Pin RS485 Jumper. No jump selects RS232.
LED	Power	3.3V Power Indicator
	nLink	nLink -WiFi LINK Indicator See 1.2.1
	nReady	nReady – Module Bootup Ready Indicator On (“low”)- Module bootup OK; Off (“high”)- Mouule botup failed; Twinkle- Remote Upgrade Ongoing;
Button	nReset	Used to reset the module.
	nReload	Restore factory default configuration after push this pin more than 4s. See 1.2.1
	WPS	WPS Button

1.2.7. Order Information

Base on customer detailed requirement, HF-LPB100 series modules provide different variants and physical type for detailed application.

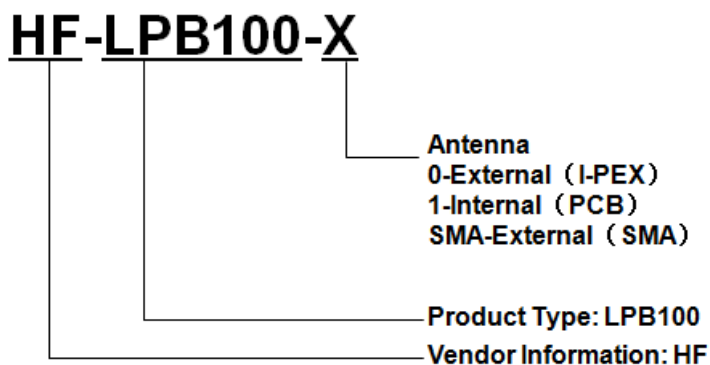

Figure 7. HF-LPB100 Order Information

1.3. Typical Application

1.3.1. Hardware Typical Application

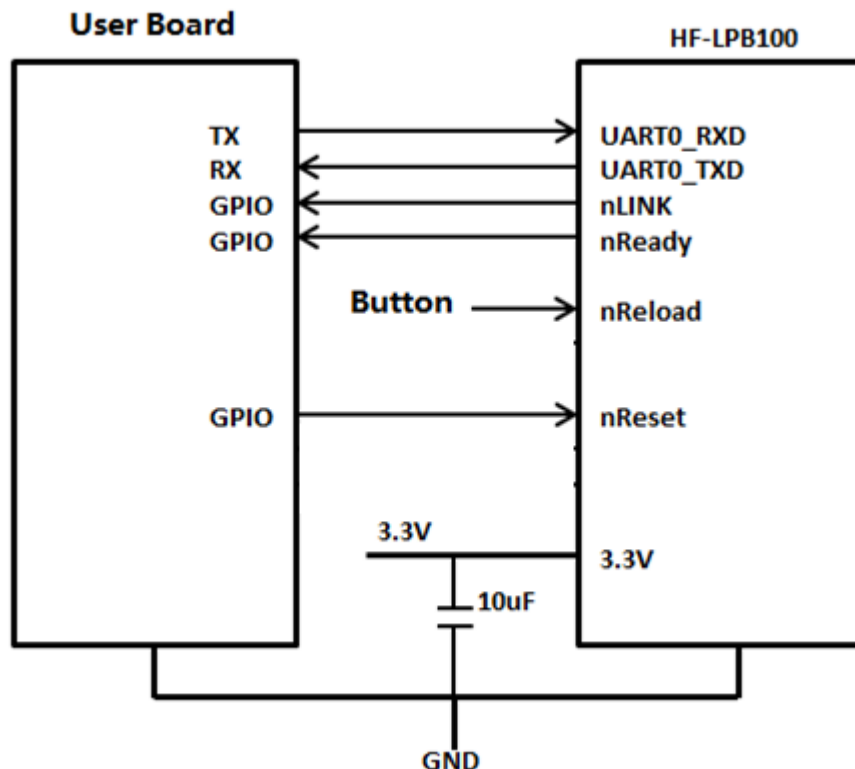

Figure 8. HF-LPB100 Hardware Typical Application

Notes:

nReset- Module hardware reset signal. Input. Logics “0” effective.

There is pull-up resistor internal and no external pull-up required. When module power up or some issue happened, MCU need assert nRST signal “0” at least 10ms, then set” 1” to keep module fully reset.

nLink- Module WiFi connection status indication. Output.

(This pin is recommend to connect to LED, indicate status when the module in wireless upgrade mode)

When module connects to AP (AP associated), this pin will output “0”. This signal used to judge if module already at WiFi connection status. There is pull-up resistor internal and no external pull-up required. If nLink function not required, can leave this pin open.

nReady- Module boot up ready signal. Output. Logics “0” effective.

The module will output “0” after normal boot up. This signal used to judge if module finish boot up and ready for application or working at normal mode. If nReady function not required, can leave this pin open.

nReload- Module restore to factory default configuration. Input. Logics “0” effective.

(This pin is recommend to connect to button, is used to enter wireless upgrade mode)

User can de-assert nReload signal “0” more than 4s through button or MCU pin, then release, module will restore to factory default configuration and re-start boot up process.. If nReload function not required, can leave this pin open.

UART0_TXD/RXD- UART port data transmit and receive signal.

2. FUNCTIONAL DESCRIPTION

2.1. Wireless Networking

HF-LPB100 module can be configured as both wireless STA and AP base on network type. Logically there are two interfaces in HF-LPB100. One is for STA, and another is for AP. When HF-LPB100 works as AP, other STA equipments are able to connect to HF-LPB100 module directly. Wireless Networking with HF-LPB100 is very flexible.

Notes:

AP: that is the wireless Access Point, the founder of a wireless network and the centre of the network nodes. The wireless router we use at home or in office may be an AP.

STA: short for Station, each terminal connects to a wireless network (such as laptops, PDA and other networking devices) can be called with a STA device.

2.1.1. Basic Wireless Network Based On AP (Infrastructure)

Infrastructure: it's also called basic network. It built by AP and many STAs which join in. The characters of network of this type are that AP is the centre, and all communication between STAs is transmitted through the AP. The figure following shows such type of networking.



Figure 9. HF-LPB100 Basic Wireless Network Structure

2.1.2. Wireless Network Based On AP+STA

HF-LPB100 module support AP+STA network mode, means module support one AP interface and one STA interface at the same time, as following figure,

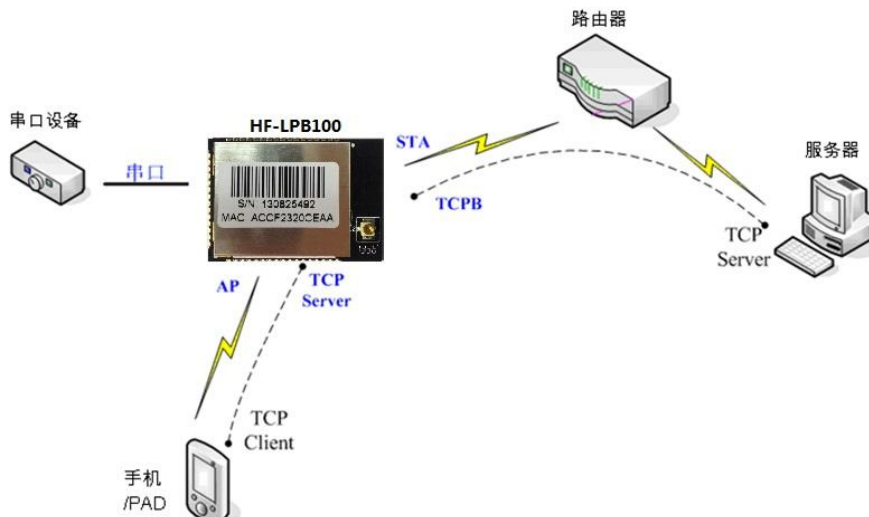

Figure 10. HF-LPB100 AP+STA Network Structure

When module enables AP+STA function, Module’s STA interface can connect with router and connect to TCP server in the network. At the same time, module’s AP interface is also active and permit phone/PAD to connect through TCPB, then phone/PAD can control user device and setting the module parameters,

The advantage of AP+STA mode is:

- Users can easily setting and track user device through Phone/PAD and not change the original network setting.
- Users can easily setting module’s parameters through WiFi when module works as STA mode.

2.2. Work Mode : Transparent Transmission Mode

HF-LPB100 module support serial interface transparent transmission mode. The benefit of this mode is achieves a plug and play serial data port, and reduces user complexity furthest. In this mode, user should only configure the necessary parameters. After power on, module can automatically connect to the default wireless network and server.

As in this mode, the module’s serial port always work in the transparent transmission mode, so users only need to think of it as a virtual serial cable, and send and receive data as using a simple serial. In other words, the serial cable of users’ original serial devices is directly replaced with the module; user devices can be easy for wireless data transmission without any changes.

The transparent transmission mode can fully compatible with user’s original software platform and reduce the software development effort for integrate wireless data transmission.

The parameters which need to configure include:

- **Wireless Network Parameters**
 - Wireless Network Name (SSID)
 - Security Mode
 - Encryption Key

- **TCP/UDP Linking Parameters**
 - Protocol Type
 - Link Type (Server or Client)
 - Target Port ID Number
 - Target Port IP Address
- **Serial Port Parameters**
 - Baud Rate
 - Data Bit
 - Parity (Check) Bit
 - Stop Bit
 - Hardware Flow Control

2.3. UART Frame Scheme

2.3.1. UART Free-Frame

HF-LPB100 support UART free-frame function. If user select open this function, module will check the intervals between any two bytes when receiving UART data. If this interval time exceeds defined value (50ms default), HF-LPB100 will think it as the end of one frame and transfer this free-frame to WiFi port, or HF-LPB100 will receive UART data until 1000 bytes, then transfer 1000 bytes frame to WiFi port.

HF-LPB100's default interval time is 50ms. (If the UART data interval is less than 300ms, the data may be packaged into one fragment) User can also set this interval to fast through AT command. The UART data may be divided as fragment.

Through AT command: AT+UARTTE=fast/normal, We recommend to use just normal parameter.

2.3.2. UART Auto-Frame

HF-LPB100 support UART auto-frame function. If user select open this function and setting auto-frame trigger length and auto-frame trigger time parameters, then module will auto framing the data which received from UART port and transmitting to the network as pre-defined data structure.

- **Auto-frame trigger length:** The fixed data length that module used to transmitting to the network.
- **Auto-frame trigger time:** After the trigger time, if UART port received data can't reach auto-frame trigger length, then module will transmitting available data to the network and bypass the auto-frame trigger length condition.

Detailed UART auto-frame function can refer to AT+instruction set "UARTF/UARTFT/UARTFL" introduction.

2.4. Encryption

Encryption is a method of scrambling a message that makes it unreadable to unwanted parties, adding a degree of secure communications. There are different protocols for providing encryption, and the HF-LPB100 module supports following:

- ◆ WEP
- ◆ WPA-PSK/TKIP
- ◆ WPA-PSK/AES
- ◆ WPA2-PSK/TKIP
- ◆ WPA2-PSK/AES

2.5. Parameters Configuration

HF-LPB100 module supports two methods to configuration parameters: **Web Accessing** and **AT+instruction set**.

Web accessing means users can configure parameters through Web browser. When HF-LPB100 module connected to wireless network, parameters configuration is done on a PC connected to the same wireless network.

AT+instruction set configuration means user configure parameters through serial interface command. Refer to “AT+instruction set” chapter for more detail.

2.6. Firmware Update

HF-LPB100 module supports two on-line upgrade methods:

- Webpage Wi-Fi Upgrade
- Remote Upgrade

Webpage based Wi-Fi upgrade, please refer to 3.1.8 firmware upgrade page, user can upload firmware file from PC to HF-LPB100.

HF-LPB100 module also support upgrade from remote HTTP server, keep module connects to AP router before execute remote HTTP upgrade. Remote upgrade have two methods: **Direct Download and Upgrade, Configure File Based Upgrade**.

◆ Configure File Based Upgrade

AT+UPURL command to set the remote directory which the configuration file located, such as AT+UPURL=http://www.hi-flying.com/admin/down/

Notes: The last '/' can't be remove

AT+UPFILE command to set the configuration file name, such as AT+UPFILE=config.txt

AT+UPST command to start remote Application upgrade. After execute this command, the module will firstly download configuration file (“config.txt”), then download the upgrade file base on the URL address listed in the configure file.

General “config.txt” file format as following example:

[URL]=<http://10.10.100.100:80/lpb.bin>

[URL]= the URL address of Application.

◆ **Direct Download and Upgrade**

AT+UPURL command to set the remote directory and file name, such as:

AT+UPURL=http://www.hi-flying.com/admin/down/lpb.bin

After execute this command, the module will directly download the “lpb.bin” file from remote directory and start upgrade Application.

Notes: please contact with high-flying technical people before upgrade firmware, or maybe damage the module and can't work again.

2.7. GPIO/PWM Function

HF-LPB100 module can provide many GPIOs, which include max 6 PWM/GPIO control pins. User devices can read/write GPIO/PWM pins status.

Table 7 HF-LPB100 GPIO/PWM Pin Mapping Table

GPIO	Configured Function	Description	Default Setting	Type
GPIO11	PWM/GPIO Channel	PWM_1	GPIO11	I/O
GPIO12	PWM/GPIO Channel	PWM_2	GPIO12	I/O
GPIO15	GPIO Channel	GPIO15	GPIO15	I/O
GPIO18	PWM/GPIO Channel	PWM_3	GPIO18	I/O
GPIO20	PWM/GPIO Channel	PWM_4	GPIO20	I/O
GPIO23	GPIO Channel	PWM_5	GPIO23	I/O

When module works at PWM mode, PC and other devices can setup connection (TCP/UDP) through WiFi, then read/write GPIO/PWM information through command data.

- GPIO n OUT 0, Set GPIO n as output and output ‘0’, Response GPIO OK or GPIO NOK;
- GPIO n OUT 1, Set GPIO n as output and output ‘1’, Response GPIO OK or GPIO NOK;
- GPIO n GET, Read GPIO n pin status, Response +ok=1 or GPIO NOK
- GPIO n SET, Save GPIO n set, Response GPIO OK or GPIO NOK
- PWM n frequency duty, Set PWM n Channel output, Response GPIO OK or GPIO NOK
- PWM n GET, Read PWM n Channel set, Response +ok=frequency duty or PWM NOK
- PWM n SET, Save PWM n Channel set, Response PWM OK or PWM NOK

Notes: Please refer to Appendix B for details to use GPIO/PWM.

2.8. SOCKET B Function

HF-LPB100 support double socket communication, the socket B function is disabled by default.

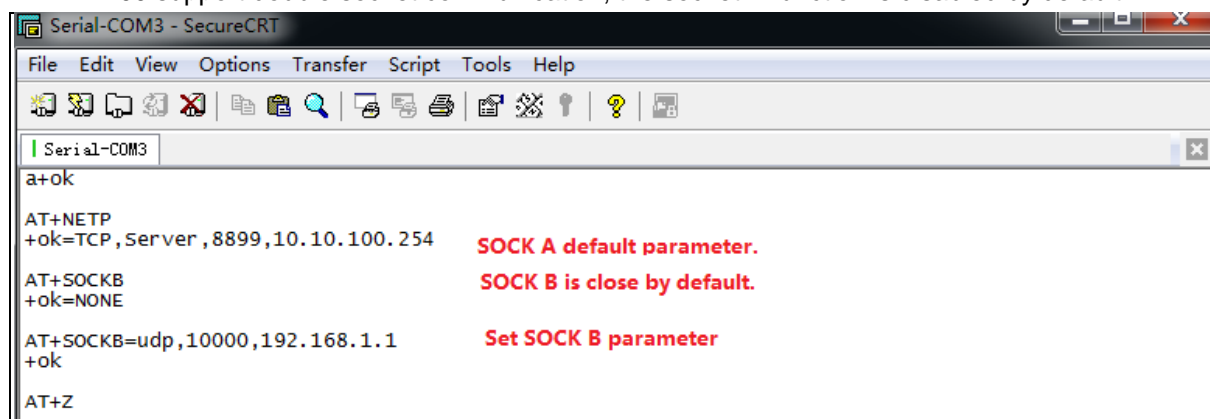

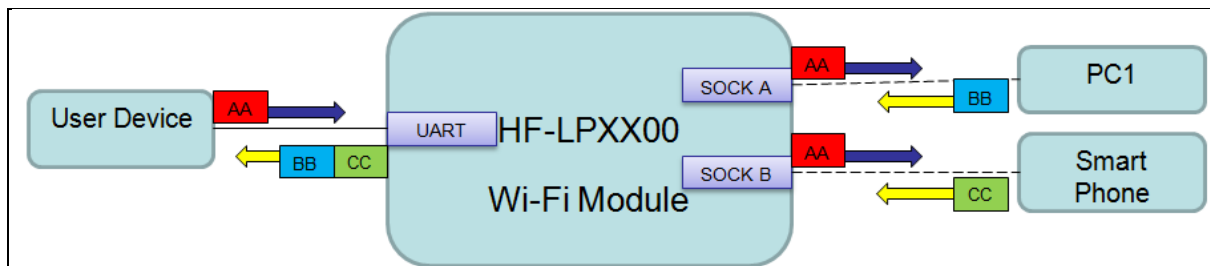

Figure 11. Socket B function demo

2.9. Multi-TCP Link Connection

When HF-LPB100 module SOCK A configured as TCP Server, it supports Multi-TCP link connection, and maximum 5 TCP clients permitted to connect to HF-LPB100 module. User can realize multi-TCP link connection at each work mode.

Multi-TCP link connection will work as following structure:

Upstream: All dates from different TCP connection or client will be transmitted to the serial port as a sequence.

Downstream: All data from serial port (user) will be replicate and broadcast to every TCP connection or client.

Detailed multi-TCP link data transmission structure as following figure:

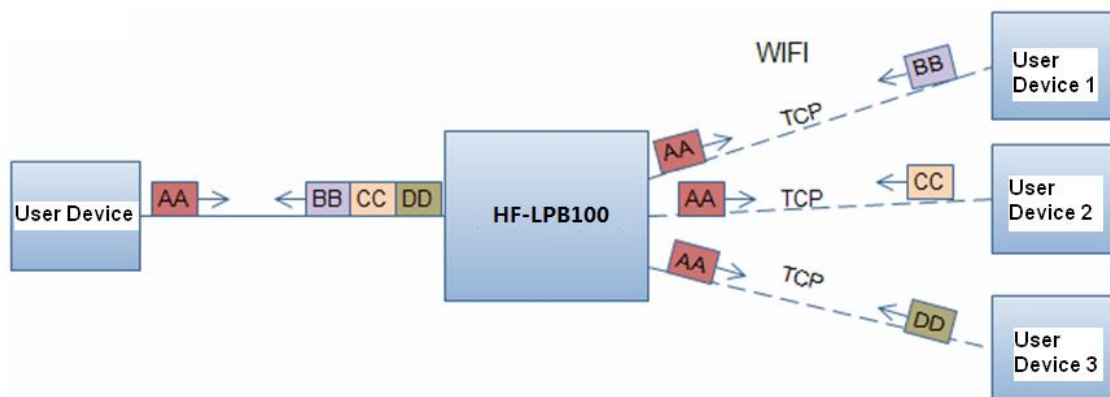

Figure 12. Multi-TCP Link Data Transmission Structure

3. OPERATION GUIDELINE

3.1. Configuration via Web Accessing

When first use HF-LPB100 modules, user may need some configuration. User can connect to HF-LPB100 module’s wireless interface with following default setting information and configure the module through laptop.

Table 8 HF-LPB100 Web Access Default Setting

Parameters	Default Setting
SSID	HF-LPB100
IP Address	10.10.100.254
Subnet Mask	255.255.255.0
User Name	admin
Password	admin

3.1.1. Open Web Management Interface

There is internal webpage and external webpage in modules. The external webpage is for web management. The internal webpage is only for upgrading.

- Step 1: Connect laptop to SSID “HF-LPB100” of HF-LPB100 module via wireless LAN card;
- Step 2: After wireless connection OK. Open Wen browser and access “<http://10.10.100.254>”;
- Step 3: Then input user name and password in the page as following and click “OK” button.



Figure 13. Open Web Management page

The HF-LPB100 web management page support English and Chinese language. User can select language environment at the top right corner and click “Apply” button.

The main menu include nine pages: “System”, “Work Mode”, “STA Setting”, “AP Setting”, “Other Setting”, “Account”, “Upgrade SW”, “Restart”, “Restore”.

3.1.2. System Page

At this page, user can check current device's important information and status such as: device ID (MID), software version, wireless work mode and related Wi-Fi parameters.



Figure 14. System Web Page

3.1.3. Work Mode Page

HF-LPB100 module can works at AP mode to simplify user's configuration, can also works at STA to connect remote server through AP router. Also, it can configure at AP+STA mode which provide very flexible application for customers.

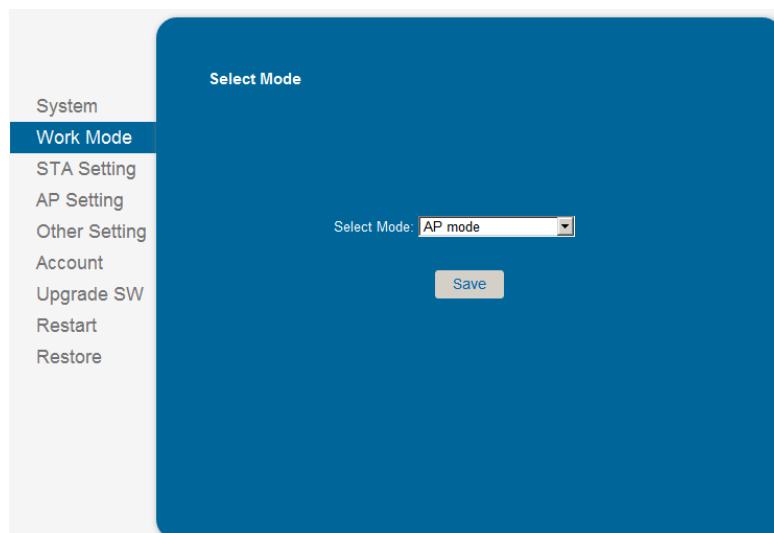

Figure 15. Work Mode Page

3.1.4. STA Setting Page

User can push “Scan” button to auto search Wi-Fi AP router nearby, and can connect with associate AP through some settings. Please note the encryption information input here must be fully same with Wi-Fi AP router’s configuration, and then it can link with AP correctly.



Figure 16. STA Setting Page

3.1.5. AP Setting Page

When user select module works at AP and AP+STA mode, then need setting this page and provide wireless and network parameters. Most of the system support DHCP to achieve IP address, so we suggest to “Enable” DHCP server in most applications.

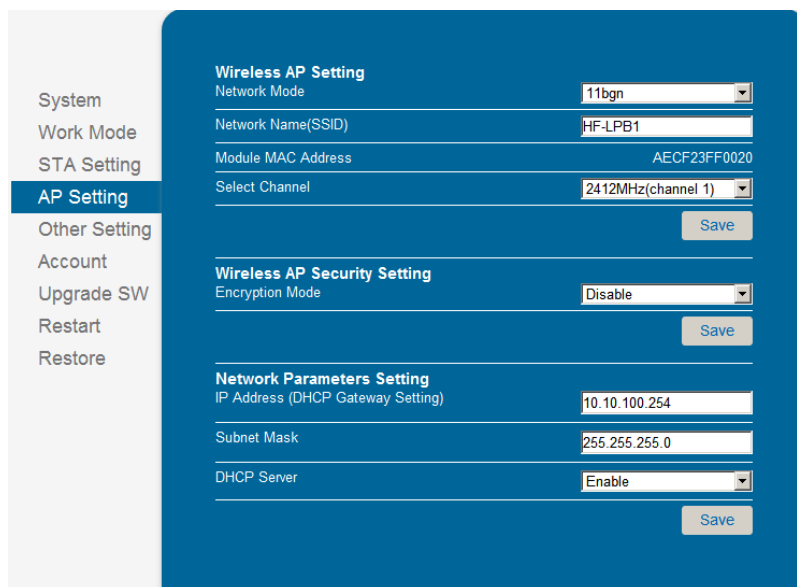

Figure 17. AP Setting Page

3.1.6. Other Setting Page

HF-LPB100 usually works at data transparent transmission mode. At this mode, the user device which connected with HF-LPB100 will connect and communicate with remote PC or server. At this page, user need setting serial port communication parameters and defines TCP related protocol parameters.

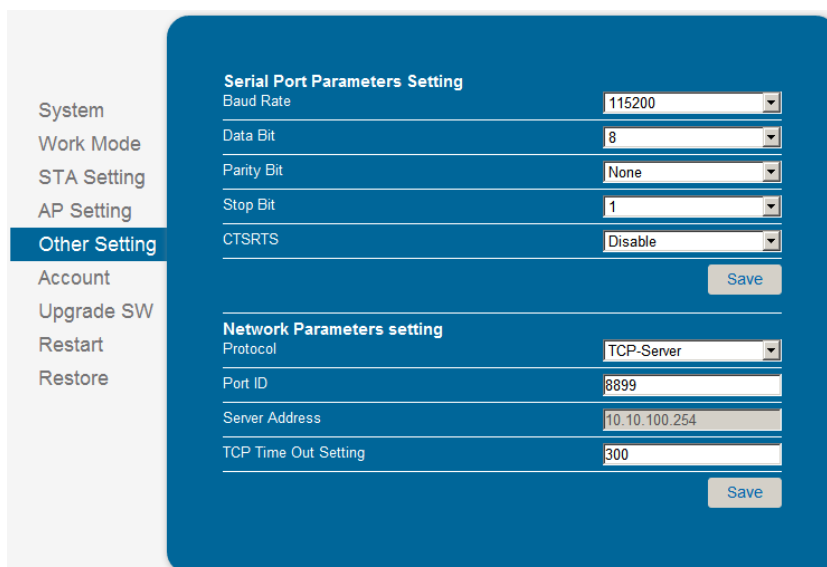

Figure 18. Other Setting Page

3.1.7. Account Management Page

This page set web server’s user name and password.

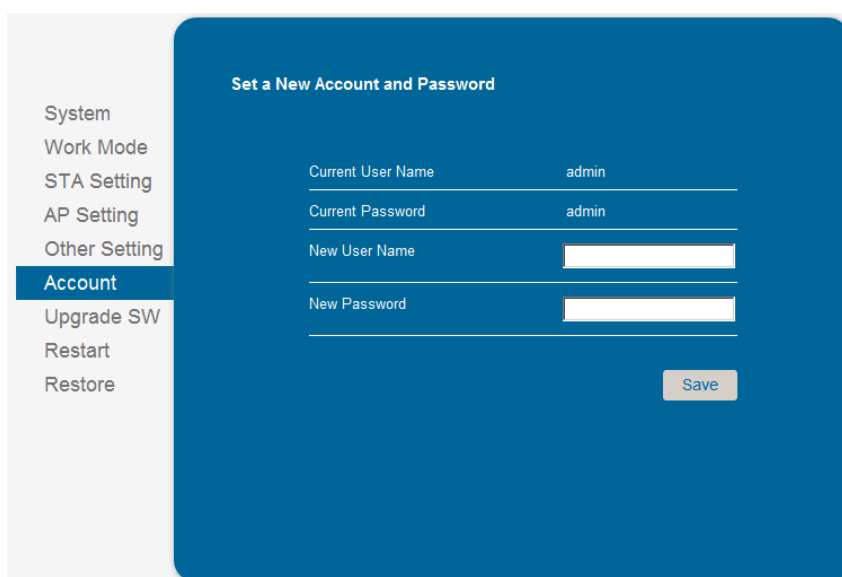

Figure 19. Account Page

3.1.8. Upgrade Software Page

User can upgrade new software (firmware) version through Wi-Fi.

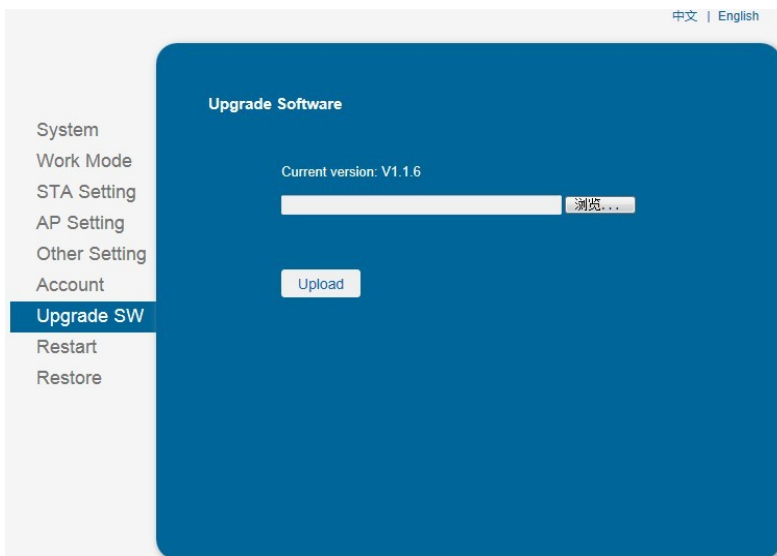

Figure 20. Upgrade SW page

3.1.9. Restart Page

Most of the setting and configuration can only effective after system restart. User shall restart after finish all setting.

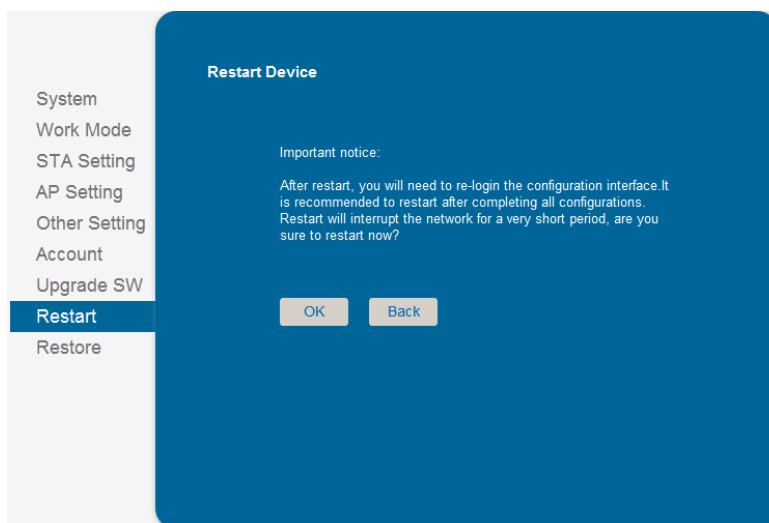

Figure 21. Restart Page

3.1.10. Restore Page

After module restore factory default setting, all user configuration profile will lose.

User can access <http://10.10.100.254> to set again, and user name and password is “admin”. HF-LPB100 will restore to AP mode for factory default setting.

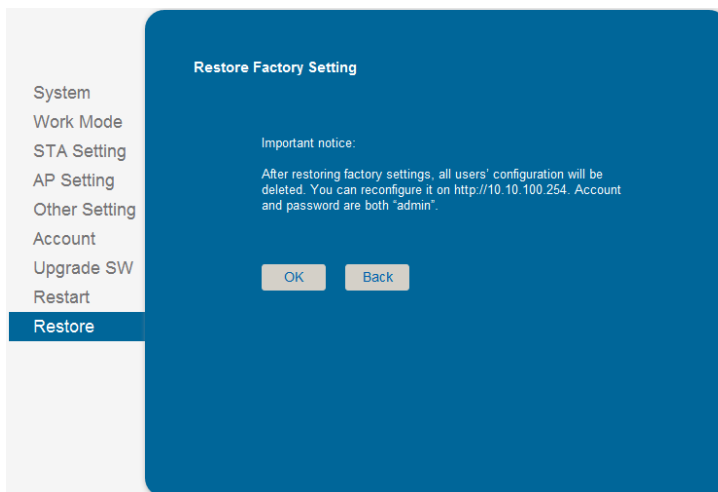

Figure 22. Restore Page

3.1.11. Internal Webpage

After wireless connection is OK. Open Wen browser and access “<http://10.10.100.254/iweb.html>”; It is for upgrading application and external webpage. Please contact High-Flying if need support on custimization for external webpage.





Figure 23. Internal Webpage

3.2. HF-LPB100 Usage Introduction

3.2.1. Software Debug Tools

High-Flying use two common software tools debugging and applying HF-LPB100 module. (User can also select other tools used to debug serial port).

- Serial Debugging Software: ComTools  **ComTools.exe**
- Ethernet Debugging Software: TCPUDPDbg  **TCPUDPDbg.exe**

3.2.2. Network Connection

User can select two methods to connect HF-LPB100 module base on dedicated application.

- **Use HF-LPB100 STA interface.** HF-LPB100 and debug PC2 connect to a wireless AP, another PC1 (or user device) connect to HF-LPB100 module with serial port:



Figure 24. STA Interface Debug Connection

- **Use HF-LPB100 AP interface.** Debug PC2 connect to HF-LPB100 through wireless connection, another PC1 (or user device) connect to HF-LPB100 module with serial port.



Figure 25. AP Interface Debug Connection

3.2.3. Default Parameter Setting

- Default SSID: HF-LPB100;
- Deault security mode: open,none;
- User UART parameter setting:115200,8,1,None;
- Default network parameter setting:TCP,Server,8899,10.10.100.254;
- Module IP address: dhcp,0.0.0.0,0.0.0.0,0.0.0.0;

3.2.4. Module Debug

PC1 open “CommTools” program, setting the same serial port parameters with HF-LPB100 module and open serial port connection.

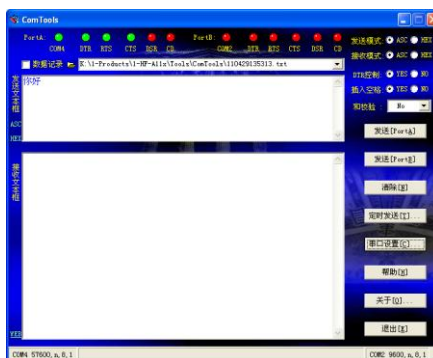

Figure 26. “CommTools” Serial Debug Tools

PC2 open “TCPUDPDbg” program, and create a new connection. If HF-LPB100 configured as Server mode, “TCPUDPDbg” Tools shall create “Client” mode connection. Or otherwise, create a “Server” mode connection.

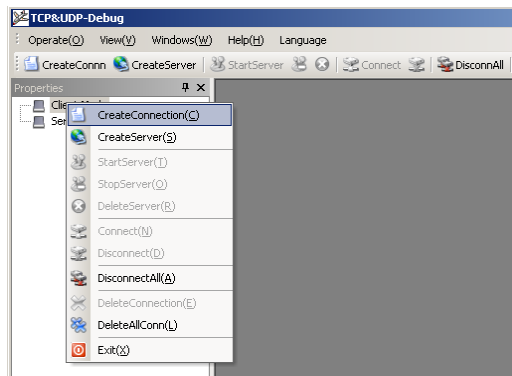

Figure 27. “TCPUDPDbg” Tools Create Connection

Then setting the TCP/UDP connection parameters. Default as following:

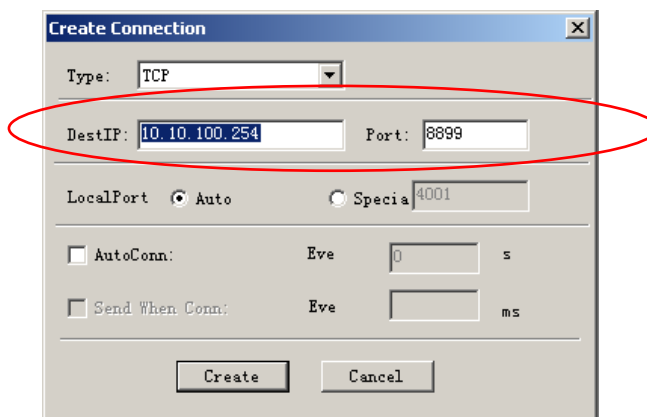

Figure 28. “TCPUDPDbg” Tools Setting

Then, click “Create” button to create a connection.

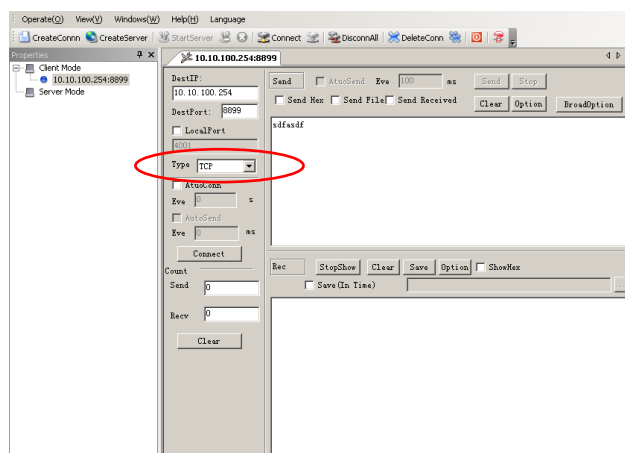

Figure 29. “TCPUDPDbg” Tools Connection

Now, in transparent transmission mode, data can be transferred from “CommTools” program to “TCPUDPDbg” program, or in reverse. You can see data in receiver side will keep same as in sender side.

3.3. Typical Application Examples

3.3.1. Wireless Control Application



Figure 30. Wireless Control Application

For this wireless control application, HF-LPB100 works as AP mode. Module’s serial port connects to user device. So, control agent (Smart phone for this example) can manage and control the user device through the wireless connection with HF-LPB100 module.

3.3.2. Remote Management Application

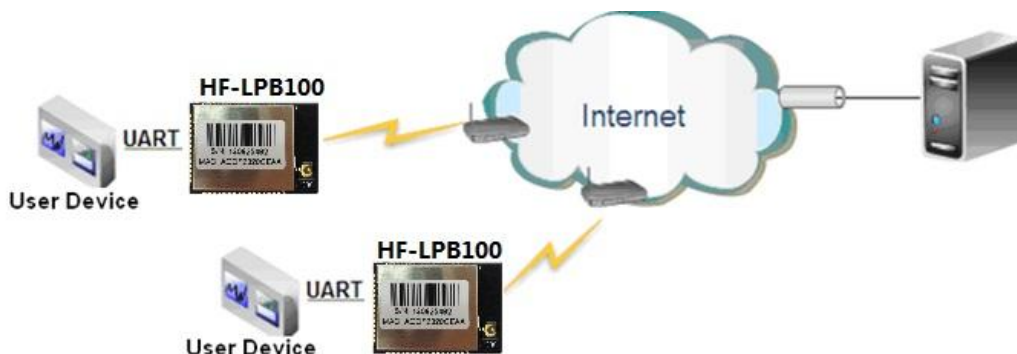

Figure 31. Remote Management Application

For this remote management application, HF-LPB100 works as STA mode and connects to Internet through wireless AP. Module configured as TCP Client and communicates with remote TCP server at Internet. Module’s serial port connects to user device.

So, user device’s data or sampling information can send to remote TCP server for storage or processing. Also remote TCP server can send command to control and manage the user device through the wireless network.

3.3.3. Transparent Serial Port Application

For this transparent serial port application, two HF-LPB100 modules connect as below figures to build up a transparent serial port connection. One HF-LPB100 works as AP mode, another HF-LPB100 works as STA mode. Make the STA device connects to AP.



Figure 32. Transparent Serial Port Application

4. AT+INSTRUCTION INTRODUCTION

4.1. Configuration Mode

When HF-LPB100 power up, it will default works as transparent transmission mode, then user can switch to configuration mode by serial port command. HF-LPB100 UART default parameters setting as below figure,

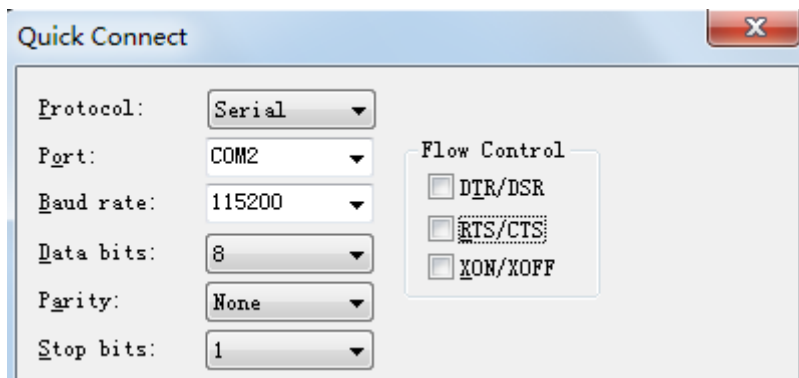

Figure 33. HF-LPB100 Default UART Port Parameters

In configuration mode, user can setting the module through AT+instruction set, which cover all web page setting function.

4.1.1. Switch to Configuration Mode

Two steps to finish switching from transparent transmission mode to configuration mode.

- **UART input “+++”, after module receive “+++”, and feedback “a” as confirmation.**
- **UART input “a”, after module receive “a” and feedback “+ok” to go into AT+instruction set configuration mode.**

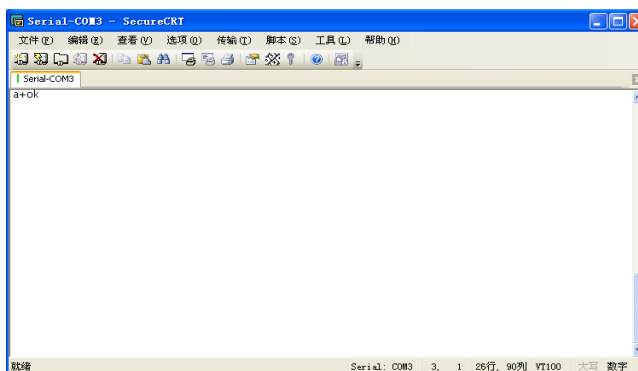
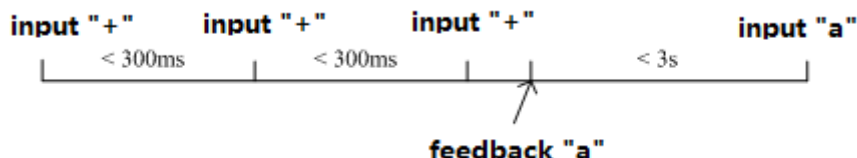

Figure 34. Switch to Configuration Mode

Notes:

1. When user input “+++” (No “Enter” key required), the UART port will display feedback information “a”, and not display input information”+++” as above UART display.

2. Any other input or wrong step to UART port will cause the module still works as original mode (transparent transmission).
3. “+++” and “a” should be input in a certain period of time to make the module switch to configuration mode. Like the following sequence.



4.2. AT+Instruction Set Overview

User can input AT+Instruction through hyper terminal or other serial debug terminal, also can program the AT+Instruction to script. User can also input “AT+H” to list all AT+Instruction and description to start.

```

AT+H
+ok

AT+: NONE command, reply "+ok".
AT+ASWD: Set/Query wiFi configuration code.
AT+E: Echo ON/Off, to turn on/off command line echo function.
AT+ENTM: Goto Through Mode.
AT+NETP: Set/Get the Net Protocol Parameters.
AT+UART: Set/Get the UART Parameters.
AT+UARTF: Enable/disable UART AutoFrame function.
AT+UARTFT: Set/Get time of UART AutoFrame.
AT+UARTFL: Set/Get frame length of UART AutoFrame.
AT+UARTTE: Set/Query UART free-frame triggerf time between two byte.
AT+PING: General PING command.
AT+WAP: Set/Get the AP parameters.
AT+WKEY: Set/Get the Security Parameters of WIFI AP Mode.
AT+WMODE: Set/Get the WIFI Operation Mode (AP or STA).
AT+WKEY: Set/Get the Security Parameters of WIFI STA Mode.
AT+WSSID: Set/Get the AP's SSID of WIFI STA Mode.
AT+WSLK: Get Link Status of the Module (only for STA Mode).
AT+WSQL: Get Link Quality of the Module (only for STA Mode).
AT+WSCAN: Get The AP site Survey (only for STA Mode).
AT+WEBU: Set/Get the Login Parameters of WEB page.
AT+TCPK: Get The state of TCP link.
AT+TCPTO: Set/Get TCP time out.
AT+TCPDIS: Connect/Dis-connect the TCP Client link
AT+RECV: Recv data from UART
AT+SEND: Send data to UART
AT+WANN: Set/Get The WAN setting if in STA mode.
AT+LANN: Set/Get The LAN setting if in ADHOC mode.
AT+RELD: Reload the default setting and reboot.
AT+RLDEN: Put on/off the GPIO12.
AT+Z: Reset the Module.
AT+MID: Get The Module ID.
AT+VER: Get application version.
AT+H: Help.
    
```

Figure 35. "AT+H" Instruction for Help

4.2.1. Instruction Syntax Format

AT+Instruction protocol is based on the instruction of ASCII command style, the description of syntax format as follow.

- **Format Description**
 - < >: Means the parts must be included
 - []: Means the optional part
- **Command Message**

AT+<CMD>[op][para-1,para-2,para-3,para-4...]<CR>

- AT+: Prefix of command message;
- CMD: Command string;
- [op]: Symbol of command operator,
 - ◆ “=” : The command requires parameters input;
 - ◆ “NULL”: Query the current command parameters setting;
- [para-n]: Parameters input for setting if required;
- <CR>: “Enter” Key, it’s 0x0a or 0x0d in ASCII;

Notes: When input AT+Instruction, “AT+<CMD>” character will display capital letter automatic and other parts will not change as you input.

➤ **Response Message**

+<RSP>[op] [para-1,para-2,para-3,para-4...]<CR><LF><CR><LF>

- +: Prefix of response message;
- RSP: Response string;
 - ◆ “ok” : Success
 - ◆ “ERR”: Failure
- [op] : =
- [para-n]: Parameters if query command or Error code when error happened;
- <CR>: ASCII 0x0d;
- <LF>: ASCII 0x0a;

➤ **Error Code**

Table 9 Error Code Description

Error Code	Description
-1	Invalid Command Format
-2	Invalid Command
-3	Invalid Operation Symbol
-4	Invalid Parameter
-5	Operation Not Permitted

4.2.2. AT+Instruction Set

Table 10 AT+Instruction Set List

Instruction	Description
<null>	NULL
Management Instruction Set	
E	Open/Close show back function
WMODE	Set/Query Wi-Fi work mode (AP/STA/APSTA)
ENTM	Set module into transparent transition mode
TMODE	Set/Query module data transfer mode

Instruction	Description
MID	Query module ID information
VER	Query module software version information
LVER	Query module detailed software version
FWSZ	Query Wi-Fi driver size
RELD	Restore to factory default setting
FCLR	Erase factory setting
Z	Re-start module
H	Help
Configure Parameters Instruction Set	
CFGTF	Copy User Parameters to Factory Default Parameters
UART Instruction Set	
UART	Set/Query serial port parameters
UARTFT	Open/Close UART auto-frame function
UARTFT	Set/Query UART auto-frame trigger time
UARTFL	Set/Query UART auto-frame trigger length
UARTTE	Set/Query UART free-frame trigger time between two bytes
Command Mode Set	
SEND	Send Data at Command Mode
RECV	Receive Data at Command Mode
Network Instruction Set	
PING	Network "Ping" Instruction
NETP	Set/Query network protocol parameters
MAXSK	Set/Query TCP Client connection number
TCPLK	Query if TCP link already build-up
TCPTO	Set/Query TCP timeout
TCPDIS	Open/Close TCP link
SOCKB	Set/Query SOCKB parameters
TCPDISB	Open/Close SOCKB TCP link
TCPTOB	Set/Query SOCKB TCP timeout
TCPLKB	Query if SOCKB TCP link already build-up
SNDB	Send data to SOCKB in Command Mode
RCVB	Receive data from SOCKB in Command Mode
Wi-Fi STA Instruction Set (Effective when module works as STA)	
WSKEY	Set/Query STA security parameters
WSSID	Set/Query associated AP SSID parameters
WANN	Set/Query STA's network parameters
WSMAC	Set/Query STA's MAC address
WSLK	Query STA Wi-Fi link status
WSLQ	Query STA Wi-Fi signal strength
WSCAN	Scan AP
WSDNS	Set/Query STA's Static DNS server address
Wi-Fi AP Instruction Set (Effective when module works as AP)	
LANN	Set/Query AP's network parameters
WAP	Set/Query AP Wi-Fi parameters
WAKEY	Set/Query AP security parameters
WAMAC	Set/Query AP MAC address
WADHCP	Set/Query AP DHCP Server status
WADMN	Set/Query AP webpage domain name
WALK	Query MAC address of STA device connecting to module AP

Instruction	Description
WALKIND	Enable/Disable indication of connection status.
Webpage Management Instruction Set	
PLANG	Set/Query Webpage Language Option
WEBU	Set/Query Webpage User name and Code
Remote Upgrade Instruction Set	
UPURL	Set/Query remote upgrade URL address
UPFILE	Set/Query remote upgrade configure file name
LOGSW	Open/Close remote upgrade log
LOGPORT	Set/Query UDP port of remote upgrade log
UPST	Start remote Application upgrade
Power Management Instruction Set	
MSLP	Set/Query deep sleep/standby mode parameters
Network Time Set	
NTPRF	Set/Query time calibration interval
NTPEN	Enable/Disable time calibration function
NTPTM	Query time
NTPSER	Set/Query NTP server IP
Others Instruction Set	
WRMID	Set module ID
RLDEN	Set/Query GPIO45 status
ASWD	Set/Query WiFi configuration code
MDCH	Set Wi-Fi Auto Switch Function
TXPWR	Set/Query Wi-Fi Transmit Power
SMTLK	Start SmartLink function
SMTLKVER	Set/Query SmartLink version
WPS	Start WPS function
WPSTNEN	Enable/Disable GPIO 15 WPS function
LPTIO	nRead/nLink/WPS function mapping
WIFI	Enable/Disable Wi-Fi
SMEM	Query RAM status

4.2.2.1. AT+E

- Function: Open/Close show back function;
- Format:
 - ◆ Set Operation

```
AT+E=<status><CR>
+ok<CR><LF><CR><LF>
```

- Parameters:
 - ◆ status: Echo status
 - ◇ on: Open echo
 - ◇ off: Close echo

When HF-LPB100 module firstly switch from transparent transmission to configuration mode, show back status is open, input “AT+E” to close show back function, input“AT+E” again to open show back function.

4.2.2.2. AT+WMODE

- Function: Set/Query Wi-Fi work mode. Setting is valid after reset;
- Format:

- ◆ Query Operation

AT+WMODE<CR>

+ok=<mode><CR><LF><CR><LF>

- ◆ Set Operation

AT+WMODE=<mode><CR>

+ok<CR><LF><CR><LF>

- Parameters:

- ◆ mode:Wi-Fi work mode
 - ◇ AP
 - ◇ STA
 - ◇ APSTA

4.2.2.3. AT+ENTM

- Function: Set module into transparent transmission mode;
- Format:

AT+ENTM<CR>

+ok<CR><LF><CR><LF>

When operate this command, module switch from configuration mode to transparent transmission mode.

4.2.2.4. AT+TMODE

- Function: Set/Query module data transfer mode. Setting is valid after reset.
- Format:

- ◆ Query Operation

AT+TMODE<CR>

+ok=<tmode><CR><LF><CR><LF>

- ◆ Set Operation

AT+TMODE=<tmode><CR>

+ok<CR><LF><CR><LF>

- Parameters:

- ◆ tmode: data transfer mode, include:
 - ◇ throughput: throughput mode
 - ◇ cmd: command mode
 - ◇ pwm: PWM/GPIO mode

4.2.2.5. AT+MID

- Function: Query module ID information;
- Format:

- ◆ Query Operation

AT+MID<CR>

+ok=<module_id><CR><LF><CR><LF>

- Parameters:

- ◆ module_id: Module ID information;
 - ◇ HF-LPB100;

Notes: User can set this parameter through AT+WRMID.

4.2.2.6. AT+VER

- Function: Query module software version information;
 - Format:
 - ◆ Query Operation
- ```
AT+VER<CR>
+ok=<ver><CR><LF><CR><LF>
```
- Parameters:
    - ◆ ver: Module software version information;

#### 4.2.2.7. AT+LVER

- Function: Query module detailed software version information;
  - Format:
    - ◆ Query Operation
- ```
AT+LVER<CR>
+ok=<ver><CR><LF><CR><LF>
```
- Parameters:
 - ◆ ver: Module software detailed version information;

4.2.2.8. AT+FWSZ

- Function: Query Wi-Fi driver size;
 - Format:
 - ◆ Query Operation
- ```
AT+FWSZ<CR>
+ok=<size,version><CR><LF><CR><LF>
```
- Parametewrs:
    - ◆ size: Wi-Fi driver size.(Byte)
    - ◆ version: Wi-Fi driver version

#### 4.2.2.9. AT+RELD

- Function: module restore to factory default setting;
  - Format:
    - ◆ Set Operation
- ```
AT+RELD<CR>
+ok=rebooting...<CR><LF><CR><LF>
```

When operate this command, module will restore to factory default setting and reboot.

4.2.2.10. AT+FCLR

- Function: Erase factory setting;
 - Format:
 - ◆ Query Operation
- ```
AT+FCLR<CR>
+ok=<status><CR><LF><CR><LF>
```

## 4.2.2.11. AT+Z

- Function: Re-start module;
- Format:

**AT+Z<CR>**

## 4.2.2.12. AT+H

- Function: Help;
- Format:
  - ◆ Query Operation

**AT+H<CR>**

**+ok=<command help><CR><LF><CR><LF>**

- Parameters:
  - ◆ command help: command introduction;

## 4.2.2.13. AT+CFGTF

- Function: Copy User Parameters to Factory Default Parameters;
- Format:
  - ◆ Query Operation

**AT+CFGTF<CR>**

**+ok=<status><CR><LF><CR><LF>**

- Parameters:
  - ◆ status: feedback operation status;

## 4.2.2.14. AT+UART

- Function: Set/Query serial port parameters. Setting is valid after reset.
- Format:
  - ◆ Query Operation

**AT+UART<CR>**

**+ok=<baudrate,data\_bits,stop\_bit,parity><CR><LF><CR><LF>**

- ◆ Set Operation

**AT+UART=<baudrate,data\_bits,stop\_bit,parity><CR>**

**+ok<CR><LF><CR><LF>**

- Parameters:
  - ◆ baudrate:
    - ◇ 600,1200,1800,2400,4800,9600,19200,38400,57600,115200,230400,380400,460800
  - ◆ data\_bits:
    - ◇ 8
  - ◆ stop\_bits:
    - ◇ 1,2
  - ◆ parity:
    - ◇ NONE
    - ◇ EVEN
    - ◇ ODD

- ◆ Flowctrl: (CTSRTS)
  - ◇ NFC: No hardware flow control
  - ◇ FC: hardware flow control

#### 4.2.2.15. AT+UARTF

- Function: Open/Close UART auto-frame function;
- Format:
  - ◆ Query Operation
 

```
AT+UARTF<CR>
```

```
+ok=<para><CR><LF><CR><LF>
```
  - ◆ Set Operation
 

```
AT+UARTF=<para ><CR>
```

```
+ok<CR><LF><CR><LF>
```
- Parameters:
  - ◆ para:
    - ◇ disable - Close auto-frame function;
    - ◇ enable - Open auto-frame function;

#### 4.2.2.16. AT+UARTFT

- Function: Set/Query UART auto-frame trigger time;
- Format:
  - ◆ Query Operation
 

```
AT+UARTFT<CR>
```

```
+ok=<time><CR><LF><CR><LF>
```
  - ◆ Set Operation
 

```
AT+UARTFT=<time ><CR>
```

```
+ok<CR><LF><CR><LF>
```
- Parameters:
  - ◆ time: Range 100 ~10000; Unit: ms. Auto-frame trigger time

#### 4.2.2.17. AT+UARTFL

- Function: Set/Query UART auto-frame trigger length;
- Format:
  - ◆ Query Operation
 

```
AT+UARTFL<CR>
```

```
+ok=<len><CR><LF><CR><LF>
```
  - ◆ Set Operation
 

```
AT+UARTFL=<len ><CR>
```

```
+ok<CR><LF><CR><LF>
```
- Parameters:
  - ◆ len: Range 8 ~1000; Unit: Byte. Auto-frame trigger length;

#### 4.2.2.18. AT+UARTTE

- Function: Set/Query UART free-frame trigger time between two bytes;
- Format:

- ◆ Query Operation

**AT+UARTTE<CR>**

**+ok=<mode><CR><LF><CR><LF>**

- ◆ Set Operation

**AT+UARTTE=<mode><CR>**

**+ok<CR><LF><CR><LF>**

- Parameters:

- ◆ mode:

- ◇ fast: No free-frame trigger time, the uart data may be break into two fragment
- ◇ normal: free-frame trigger time between two bytes is 50ms;

#### 4.2.2.19. AT+SEND

- Function: Send Data to SOCKA at Command Mode.

- Format:

**AT+SEND=<data\_lenth><CR>**

**+ok<CR><LF><CR><LF>**

- Parameters:

- ◆ data\_lenth: Lenth of send data. Range: 0~1000 Byte

The UART port will wait 3 seconds for input after this command is sent OK. The data received from UART port is sent to SOCKA. If the interval of two bytes is more than 10ms, the data will be sent instantly.

#### 4.2.2.20. AT+RECV

- Function: Receive Data from SOCKA at Command Mode.

- Format:

**AT+RECV=<data\_lenth,timeout><CR>**

**+ok=< data\_lenth, data\_content><CR><LF><CR><LF>**

- Parameters:

- ◆ data\_lenth: Lenth of receive data. Range: 0~1000 Byte
- ◆ timeout: wait for timeout, 0~10 sec
- ◆ data\_content: contents of receive data.

If not receive any data in 3 second, then feedback +ok=0.

#### 4.2.2.21. AT+PING

- Function: Network "PING" Instruction.

- Format:

- ◆ Set Operation

**AT+PING=<IP\_address ><CR>**

**+ok=<sta><CR><LF><CR><LF>**

- Parameters:

- ◆ sta: feedback result
  - ◇ Success
  - ◇ Timeout
  - ◇ Unknown host

## 4.2.2.22. AT+NETP

- Function: Set/Query network protocol parameters, Setting is valid after reset.

- Format:

- ◆ Query Operation

**AT+NETP<CR>**

**+ok=<protocol,CS,port,IP><CR><LF><CR><LF>**

- ◆ Set Operation

**AT+NETP=<protocol,CS,port,IP><CR>**

**+ok<CR><LF><CR><LF>**

- Parameters:

- ◆ protocol:

- ◇ TCP

- ◇ UDP

- ◆ CS: Network mode:

- ◇ SERVER

- ◇ CLIENT

- ◆ Port: protocol port ID: Decimal digit and less than 65535

- ◆ IP: Server's IP address when module set as client

If set as UDP SERVER, the module will save the IP address and port of the latest UDP packet received. The data will be sent to the saved IP address and port. If the module hasn't saved any IP address and port when power up. The data will be sent to the IP address and port which is set by this command.

If set as UDP,CLIENT, the data will always be sent to the IP address and port set by this command.

## 4.2.2.23. AT+MAXSK

- Function:Set/ Query TCP Client connection number.

- Format:

- ◆ Query Operation

**AT+MAXSK<CR>**

**+ok=<num><CR><LF><CR><LF>**

- ◆ Set Operation

**AT+MAXSK=<num><CR>**

**+ok<CR><LF><CR><LF>**

- Parameters:

- ◆ num: TCP Client connection number. Range: 1~5. 5 is the default value it means when the module work in TCP server , it accepts max 5 TCP client connect to it.

## 4.2.2.24. AT+TCPLK

- Function: Query if TCP link already build-up;

- Format:

**AT+TCPLK<CR>**

**+ok=<sta><CR><LF><CR><LF>**

- Parameters:

- ◆ sta.: if module already setup TCP link;
  - ◇ on: TCP link setup;
  - ◇ off: TCP link not setup;

#### 4.2.2.25. AT+TCPTO

- Function: Set/Query TCP timeout; Setting is valid after reset.

- Format:

- ◆ Query Operation

**AT+TCPTO<CR>**

**+ok=<time><CR><LF><CR><LF>**

- ◆ Set Operation

**AT+TCPTO=<time ><CR>**

**+ok<CR><LF><CR><LF>**

- Parameters:

- ◆ time: TCP timeout time.

- ◇ ≤ 600, (600s);
- ◇ ≥ 0, (0 means no timeout);
- ◇ Default, 300s;

Module begin to count time when TCP channel don't receive any data, clecherar time counter when TCP channel receive any data. If the time counter reaches the TCPTO, the tcp channel will be break. If the module work in TCP Client, it will connect the TCP server instantly and when the module work in TCP Server, the TCP client device should make the connection itself.

#### 4.2.2.26. AT+TCPDIS

- Function: Open/Close TCP link;

- Format:

- ◆ Query Opera

**AT+TCPDIS<CR>**

**+ok=<sta><CR><LF><CR><LF>**

- ◆ Set Operation

**AT+TCPDIS =<on/off><CR>**

**+ok<CR><LF><CR><LF>**

- Parameters:

When query, sta.: Feedback if TCP Client can be link,

- ◇ On, TCP link close
- ◇ off, TCP link on

When setting, "off" means close TCP link. After finish this command, module disconnect TCP link and not connect again. "On" means open TCP link. After finish this command, module re-connect TCP server right away.

#### 4.2.2.27. AT+SOCKB

- Function: Set/Query SOCKB parameters. Setting is valid after reset.

- Format:

- ◆ Query Operation

**AT+SOCKB<CR>**

**+ok=<protocol,port,IP><CR><LF><CR><LF>**

- ◆ Set Operation

**AT+SOCKB=<protocol,port,IP><CR>**

**+ok<CR><LF><CR><LF>**

- Parameters:

- ◆ Protocol: Protocol type:

- ◇ TCP: Only for TCP Client
- ◇ UDP: UDP Client
- ◇ UDPS: UDP Server

- ◆ Port: Protocol Port in decimal, less than 65535

- ◆ IP: Destination IP address, domain name is support

If set as UDP SERVER, the module will save the IP address and port of the latest UDP packet received. The data will be sent to the saved IP address and port. If the module hasn't saved any IP address and port when power up. The data will be sent to the IP address and port which is set by this command.

If set as UDP,CLIENT, the data will always be sent to the IP address and port set by this command.

#### 4.2.2.28. AT+TCPDISB

- Function: Open/Close SOCKB connection

- Format:

- ◆ Query Operation

**AT+TCPDISB<CR>**

**+ok=<sta><CR><LF><CR><LF>**

- ◆ Set Operation

**AT+TCPDISB =<on/off><CR>**

**+ok<CR><LF><CR><LF>**

- Parameters:

When setting, "off" means close TCP link. After finish this command, module disconnect TCP link and not connect again. "On" means open TCP link. After finish this command, module re-connect TCP server right away.

#### 4.2.2.29. AT+TCPTOB

- Function: Set/Query Operation SOCKB TCP timeout. Setting is valid after reset.

- Format:

- ◆ Query Operation

**AT+TCPTOB<CR>**

**+ok=<time><CR><LF><CR><LF>**

- ◆ Set Operation

**AT+TCPTOB=<time ><CR>**

**+ok<CR><LF><CR><LF>**

- Parameters



- ◆ Time: TCP timeout
  - ◇ ≤ 600:600s
  - ◇ ≥ 0:0 means no timeout
  - ◇ Default:300s

If the SOCKB TCP don't receive any data from TCP server for TCP tmeout setting, the module will break and reconnect the TCP server. If it receive data from server, the timeout counter will be clear.

#### 4.2.2.30. AT+TCPLKB

- Function:Query SOCKB connection status
- Format:

**AT+TCPLKB<CR>**

**+ok=<sta><CR><LF><CR><LF>**

- Parameters:
  - ◆ sta.: SOCKB connection status
    - ◇ on: TCP connected
    - ◇ off: TCP disconnected

#### 4.2.2.31. AT+SNDB

- Function: Send datas to SOCKB at Command Mode
- Format:

**AT+SNDB=<data\_lenth ><CR>**

**+ok<CR><LF><CR><LF>**

- Parameters:
  - ◆ data\_lenth: Lenth of send data. Range: 0~1000 Byte

The UART port will wait 3 seconds for input after this command is sent OK. The data received from UART port is sent to SOCKB. If the interval of two bytes is more than 10ms, the data will be sent instantly.

#### 4.2.2.32. AT+RCVB

- Function: Receive datas from SOCKB at Command Mode
- Format:

**AT+RCVB=<data\_lenth><CR>**

**+ok=< data\_lenth, data\_content><CR><LF><CR><LF>**

- Parameters:
  - ◆ data\_lenth: Lenth of receive data. Range: 0~1000 Byte
  - ◆ data\_content: contents of receive data.

If not receive any data in 3 second, then feedback +ok=0.

#### 4.2.2.33. AT+WSSSID

- Function: Set/Query Wi-Fi associated AP SSID parameters. Setting is valid after reset.
- Format:
  - ◆ Query Operation

**AT+WSSSID<CR>**

**+ok=<ap's ssid><CR><LF><CR><LF>**

- ◆ Set Operation

```
AT+WSSSID=<ap's ssid ><CR>
```

```
+ok<CR><LF><CR><LF>
```

- Parameters:
  - ◆ ap's ssid: AP's SSID (Within 32 character);

#### 4.2.2.34. AT+WSKEY

- Function: Set/Query STA security parameters. Setting is valid after reset.
- Format:
  - ◆ Query Operation

```
AT+WSKEY<CR>
```

```
+ok=<auth,encry,key><CR><LF><CR><LF>
```

- ◆ Set Operation

```
AT+WSKEY=< auth,encry,key><CR>
```

```
+ok<CR><LF><CR><LF>
```

- Parameters:
  - ◆ auth: Authentication mode
    - ◇ OPEN
    - ◇ SHARED
    - ◇ WPAPSK
    - ◇ WPA2PSK
  - ◆ encry:Encryption algorithm
    - ◇ NONE: When "auth=OPEN", effective
    - ◇ WEP-H: When "auth=OPEN" or "SHARED", effective, in HEX format
    - ◇ WEP-A: When "auth=OPEN" or "SHARED", effective, in ASCII format
    - ◇ TKIP: When "auth= WPAPSK" or "WPA2PSK", effective
    - ◇ AES: When "auth= WPAPSK" "WPA2PSK", effective
  - ◆ key: password. When encry is WEP-H, password is in HEX format, password length is 10 or 26. When encry is WEP-A, password is in ASCII format, password length is 5 or 13. When encry is TKIP or AES, password is in ASCII code, password length shall be less than 64 and greater than 8.

#### 4.2.2.35. AT+WANN

- Function: Set/Query STA network setting. Setting is valid after reset.
- Format:
  - ◆ Query Operation

```
AT+WANN<CR>
```

```
+ok=<mode,address,mask,gateway><CR><LF><CR><LF>
```

- ◆ Set Operation

```
AT+WANN=< mode,address,mask,gateway ><CR>
```

```
+ok<CR><LF><CR><LF>
```

- Parameters:
  - ◆ mode: STA's IP network setting
    - ◇ static: Static IP

- ◇ DHCP: Dynamic IP
- ◆ address: STA IP address;
- ◆ mask: STA subnet mask;
- ◆ gateway: STA gateway address;

#### 4.2.2.36. AT+WSMAC

- Function: Set/Query STA MAC address parameters. Setting is valid after reset.
- Format:
  - ◆ Query Operation
  - AT+WSMAC<CR>**
  - +ok=<mac\_address><CR><LF><CR><LF>**
  - ◆ Set Operation
  - AT+WSMAC=<code,mac\_address><CR>**
  - +ok<CR><LF><CR><LF>**
- Parameters:
  - ◆ code: security code
    - ◇ 8888 (default value)
  - ◆ Mac\_address: STA MAC address, such as ACCF23FF1234

#### 4.2.2.37. AT+WSLK

- Function: Query STA WiFi link status
- Format:
  - ◆ Query Operation
  - AT+WSLK<CR>**
  - +ok=<ret><CR><LF><CR><LF>**
- Parameters:
  - ◆ ret
    - ◇ "Disconnected", if no WiFi connection;
    - ◇ "AP' SSID (AP's MAC" ) , if WiFi connection available;

#### 4.2.2.38. AT+WSLQ

- Function: Query STA WiFi signal strength;
- Format:
  - ◆ Query Operation
  - AT+WSLQ<CR>**
  - +ok=<ret><CR><LF><CR><LF>**
- Parameters:
  - ◆ ret
    - ◇ "Disconnected", if no WiFi connection;
    - ◇ "AP's WiFi signal strength" , if WiFi connection available;

#### 4.2.2.39. AT+WSCAN

- Function: Scan AP;
- Format:
  - AT+WSCAN<CR>**

**+ok=<ap\_site><CR><LF><CR><LF>**

- Parameters:
  - ◆ ap\_site: AP searched;

#### 4.2.2.40. AT+WSDNS

- Function: Set/Query STA static DNS server address;
- Format:
  - ◆ Query Operation

**AT+WSDNS<CR>**

**+ok=<address><CR><LF><CR><LF>**

- ◆ Set Operation

**AT+WSDNS =<address><CR>**

**+ok<CR><LF><CR><LF>**

- Parameters:
  - ◆ address: STA's DNS server address; Effective right away.

#### 4.2.2.41. AT+LANN

- Function: Set/Query AP's network parameters. Setting is valid after reset.
- Format:
  - ◆ Query Operation

**AT+LANN<CR>**

**+ok=<ipaddress,mask><CR><LF><CR><LF>**

- ◆ Set Operation

**AT+LANN=< ipaddress,mask><CR>**

**+ok<CR><LF><CR><LF>**

- Parameters:
  - ◆ ipaddress: AP's IP address;
  - ◆ mask: AP's net mask;

#### 4.2.2.42. AT+WAP

- Function: Set/Query AP Wi-Fi parameters. Setting is valid after reset.
- Format:
  - ◆ Query Operation

**AT+WAP<CR>**

**+ok=<wifi\_mode,ssid,channel><CR><LF><CR><LF>**

- ◆ Set Operation

**AT+WAP =<wifi\_mode,ssid,channel><CR>**

**+ok<CR><LF><CR><LF>**

- Parameters:
  - ◆ wifi\_mode: Wi-Fi mode, include:
    - ◇ 11B
    - ◇ 11BG
    - ◇ 11BGN (Default Value)
  - ◆ ssid:SSID at AP mode, the maximum length is 32.

- ◆ channel: Wi-Fi channel selection:
  - ◇ AUTO;(Default CH1)
  - ◇ CH1~CH11;

#### 4.2.2.43. AT+WAKEY

- Function: Set/Query AP Wi-Fi security parameters. Setting is valid after reset.
- Format:
  - ◆ Query Operation
 

```
AT+WAKEY<CR>
```

```
+ok=<auth,encry,key><CR><LF><CR><LF>
```
  - ◆ Set Operation
 

```
AT+WAKEY=< auth,encry,key><CR>
```

```
+ok<CR><LF><CR><LF>
```
- Parameters:
  - ◆ auth: include
    - ◇ OPEN
    - ◇ WPA2PSK
  - ◆ Encry: include
    - ◇ NONE: When “auth=OPEN” available;
    - ◇ AES: When “auth=WPA2PSK” available;
  - ◆ key: security code, ASCII code, smaller than 64bit and bigger than 8 bit;

#### 4.2.2.44. AT+WAMAC

- Function: Query AP MAC address parameters;
- Format:
  - ◆ Query Operation
 

```
AT+WAMAC<CR>
```

```
+ok=<mac_address><CR><LF><CR><LF>
```
- Parameters:
  - ◆ mac\_address:AP's MAC address;

Note: Module AP mode's MAC address is related to STA mode's MAC address. If user need change to others, please contact with high-flying technical people.

#### 4.2.2.45. AT+WADHCP

- Function: Set/Query AP DHCP server status; Setting is valid after reset.
- Format:
  - ◆ Query Operation
 

```
AT+WADHCP<CR>
```

```
+ok=<status>,<ip1>,<ip2><CR><LF><CR><LF>
```
  - ◆ Set Operation
 

```
AT+WADHCP=<status>[,ip1,ip2]<CR>
```

```
+ok<CR><LF><CR><LF>
```
- Parameters:
  - ◆ status:AP's DHCP server function status:

- ✧ on:DHCP Server Open;
- ✧ off:DHCP Server Close:
- ◆ ip1: DHCP allocate IP start value.
- ◆ ip2: DHCP allocate IP end value.

#### 4.2.2.46. AT+WADMN

- Function: Set/Query AP webpage domain name;
- Format:
  - ◆ Query Operation
 

```
AT+WADMN<CR>
```

```
+ok=<domain_name><CR><LF><CR><LF>
```
  - ◆ Set Operation
 

```
AT+WADMN=<domain_name><CR>
```

```
+ok<CR><LF><CR><LF>
```
- Parameters:
  - ◆ Domain\_name: Webpage domain name (within 20 characters, can't all numbers).

#### 4.2.2.47. AT+WALK

- Function: Query MAC address of STA device connecting to module AP
- Format:
  - ◆ Query Operation
 

```
AT+WALK<CR>
```

```
+ok=<status> <CR><LF><CR><LF>
```
- Parameters:
  - ◆ status: MAC address of STA device connecting to module AP.
    - ✧ No Connection: No STA device connecting to module AP;

#### 4.2.2.48. AT+WALKIND

- Function: Enable/Disable indication of module AP connection status.
- Format:
  - ◆ Query Operation
 

```
AT+WALKIND<CR>
```

```
+ok=<status> <CR><LF><CR><LF>
```
  - ◆ Set Operation
 

```
AT+WALKIND=<status><CR>
```

```
+ok<CR><LF><CR><LF>
```
- Parameters:
  - ◆ status: indication of module AP connection status.
    - ✧ on: Enable nLink indication function. When STA device connecting to module AP, nLink output Low, otherwise output High.
    - ✧ off: Disable nLink indication function. **(default mode)**.

#### 4.2.2.49. AT+PLANG

- Function: Set/Query webpage language option;
- Format:

- ◆ Query Operation

**AT+PLANG<CR>**

**+ok=<language> <CR><LF><CR><LF>**

- ◆ Set Operation

**AT+PLANG=<language> <CR>**

**+ok<CR><LF><CR><LF>**

- Parameters:

- ◆ language: webpage's language
  - ◇ CN: Chinese Version (Default);
  - ◇ EN: English Version;

#### 4.2.2.50. AT+UPURL

- Function: Set/ Query remote upgrade URL address;

- Format:

- ◆ Query Operation

**AT+UPURL<CR>**

**+ok=<url> <CR><LF><CR><LF>**

- ◆ Set Operation

**AT+UPURL=<url,filename> <CR>**

**+ok<CR><LF><CR><LF>**

- Parameters:

- ◆ url: the upgrade file url address; the last charter shall be "/" (within 20 characters).
- ◆ filename: the upgrade file name, it's optional and not saved parameter. If provide this file name here, the module will start upgrade right away;

#### 4.2.2.51. AT+UPFILE

- Function: Set/ Query remote upgrade configure file name;

- Format:

- ◆ Query Operation

**AT+UPFILE<CR>**

**+ok=<filename> <CR><LF><CR><LF>**

- ◆ Set Operation

**AT+UPFILE=<filename> <CR>**

**+ok<CR><LF><CR><LF>**

- Parameters:

- ◆ filename: the upgrade configure file name (within 20 characters).

#### 4.2.2.52. AT+LOGSW

- Function: Open/Close remote upgrade logfile

- Format:

- ◆ Query Operation

**AT+LOGSW<CR>**

**+ok=<status><CR><LF><CR><LF>**

- ◆ Set Operation

**AT+LOGSW=<status><CR>**

**+ok<CR><LF><CR><LF>**

- Parameters:
  - ◆ status:
    - ✧ on: Open. The UART Port will print some upgrade status when upgrading. the log file will be sent to UDP Port after successfully
    - ✧ off: Close.

#### 4.2.2.53. AT+LOGPORT

- Function: Set/Query remote upgrade UDP port of log file.
- Format:

- ◆ Query Operation

**AT+LOGPORT<CR>**

**+ok=<port><CR><LF><CR><LF>**

- ◆ Set Operation:

**AT+LOGPORT =<port><CR>**

**+ok<CR><LF><CR><LF>**

- Parameters:
  - ✧ port: The remote upgrade UDP port of log file.

#### 4.2.2.54. AT+UPST

- Function: Start remote upgrade;
- Format:
  - ◆ Query Operation

**AT+UPST<CR>**

**+ok=<log> <CR><LF><CR><LF>**

- Parameters:
  - ◆ log: feedback the status of remote upgrade;

**Note:** After execute this command, the HF-LPB100 will automatic start upgrade base on the setting of UPURL, UPFILE command contents;

#### 4.2.2.55. AT+WEBU

- Function: Set/ Query webpage user name and password; Setting is valid after reset.
- Format:
  - ◆ Query Operation

**AT+WEBU<CR>**

**+ok=<username,password> <CR><LF><CR><LF>**

- ◆ Set Operation

**AT+WEBU=<username,password><CR>**

**+ok<CR><LF><CR><LF>**

- Parameters:
  - ◆ username: User Name, within 15 characters, not support empty.
  - ◆ password: password, within 15 characters, support empty.



## 4.2.2.56. AT+MSLP

- Function: Set/Query deep sleep/standby mode parameters;
- Format:

- ◆ Query Operation

**AT+MSLP<CR>**

**+ok=<ret><CR><LF><CR><LF>**

- ◆ Set Operation

**AT+MSLP=<mode><CR><LF><CR><LF>**

- Parameters:
  - ◆ ret:
    - ◇ normal: normal mode (100ms interval)
  - ◆ mode:
    - ◇ normal: normal mode (100ms interval)
    - ◇ standby: WiFi shut down mode.**(Reserved)**

## 4.2.2.57. AT+NTPRF

- Function: Set /Query time calibration interval
- Format:

- ◆ Query Operation

**AT+NTPRF<CR>**

**+ok=<num><CR><LF><CR><LF>**

- ◆ Set Operation

**AT+NTPRF=<num><CR>**

**+ok<CR><LF><CR><LF>**

- Parameters:
  - ◆ num: time calibration interval, range:0~720, default:30 minutes, 10 minutes for each step, set 0 means no time calibration automatically.

## 4.2.2.58. AT+NTPEN

- Function: Enable/Disable time calibration function. Setting is valid after reset.
- Format:

- ◆ Query Operation

**AT+NTPEN<CR>**

**+ok=<status><CR><LF><CR><LF>**

- ◆ Set Operation

**AT+NTPEN=<status><CR>**

**+ok<CR><LF><CR><LF>**

- Parameters:
  - ◆ status: status of time calibration
    - on: Enable time calibration
    - off: Disable time calibration

## 4.2.2.59. AT+NTPTM

- Function: Query network time,time zone is GMT+8 by default.

- Format:
  - ◆ Query Operation
 

```
AT+NTPTM<CR>
+ok=<time><CR><LF><CR><LF>
```
- Parameters:
  - ◆ time: network time, for example: 2013-10-9 16:10:42 Wed, if it shows Not Available means that the time calibration function is not enabled or the module doesn't connect to the internet.

#### 4.2.2.60. AT+NTPSER

- Function: Set/Query NTP server IP address..
- Format:
  - ◆ Query Operation
 

```
AT+NTPSER<CR>
+ok=<ipaddress><CR><LF><CR><LF>
```
  - ◆ Set Operation
 

```
AT+NTPSER=<ipaddress><CR>
+ok<CR><LF><CR><LF>
```
- Parameters:
  - ◆ ipaddress: NTP network server IP address, 61.164.36.105(default value).

#### 4.2.2.61. AT+WRMID

- Function: Set module ID;
- Format:
  - ◆ Set Operation
 

```
AT+WRMID=<wrmid> <CR><LF><CR><LF>
```
- Parameters:
  - ◆ wrmid: set module's ID (within 20 characters).

#### 4.2.2.62. AT+RLDEN

- Function: Set/Query nReload Pin function status
- Format:
  - ◆ Query Operation
 

```
AT+RLDEN<CR>
+ok=<status><CR><LF><CR><LF>
```
  - ◆ Set Operation
 

```
AT+RLDEN=<status><CR>
+ok<CR><LF><CR><LF>
```
- Parameters:
  - ◆ status: The status of module's nReload pin function
    - ◇ on: nReload pin function is enabled.
    - ◇ off: nReload pin function is disabled

#### 4.2.2.63. AT+ASWD

- Function: Set/Query WiFi Configuration Password;

- Format:
  - ◆ Query Operation
 

```
AT+ASWD<CR>
```

```
+ok=<aswd> <CR><LF><CR><LF>
```
  - ◆ Set Operation
 

```
AT+ASWD=<aswd> <CR><LF><CR><LF>
```
- Parameters:
  - ◆ aswd: WiFi Configuration Password (within 20 characters).

#### 4.2.2.64. AT+MDCH

- Function: Set Wi-Fi Auto Switch Function. Setting is valid after reset.
- Format:
  - ◆ Query Operation
 

```
AT+MDCH<CR>
```

```
+ok=<mode> <CR><LF><CR><LF>
```
  - ◆ Set Operation
 

```
AT+MDCH=<mode> <CR><LF><CR><LF>
```
- Parameters:
  - ◆ mode: Wi-Fi Auto Switch Mode
    - ◇ off: Disable Wi-Fi auto switch.
    - ◇ on: Enable Wi-Fi auto switch. When the module(STA mode) fail to connect to router, it will switch to AP mode itself in one minute.
    - ◇ auto: Enable Wi-Fi auto detect function. The module will reset itself when encounter any abnormal. The default time interval is 10 minutes. **(default mode)**
    - ◇ 3-120: unit: minute. Set the time interval to reset itself when abnormal.

#### 4.2.2.65. AT+TXPWR

- Function: Set/Query Wi-Fi Transmit Power, Real Transmit Power=Default Transmit Power(16dBm) – [Setting Value] \* 0.5dBm. Setting is valid after reset.
- Format:
  - ◆ Query Operation
 

```
AT+TXPWR <CR>
```

```
+ok=<num><CR><LF><CR><LF>
```
  - ◆ Set Operation
 

```
AT+TXPWR=<num><CR>
```

```
+ok<CR><LF><CR><LF>
```
- Parameters:
  - ◆ num: [Setting Value]. The default is 0, it can be sent from 0 ~ 24. If set to 24, the module transmit power will be at a minimum of 4dBm. Reboot to make this setting change valid. It will not restore to default if reload the module.

#### 4.2.2.66. AT+SMTLK

- Function: Start SmartLink function

- Format:
  - ◆ Query Operation

**AT+SMTLK<CR>**

SmartLink is a One-Key config function. Config the module connecting to router easily. After start SmartLink function , the module work in SmartLink status and nLink LED is fast flashing waiting for APP to push information. See the Appendix for more details.

#### 4.2.2.67. AT+SMTLKVER

- Function: Set/Query SmartLink config version(for LPB100U only)
- Format:
  - ◆ Query Operation

**AT+SMTLKVER <CR>**

**+ok=<status><CR><LF><CR><LF>**

- ◆ Set Operation

**AT+SMTLKVER=<ver><CR>**

**+ok<CR><LF><CR><LF>**

- Parameters:
  - ◆ status: SmartLink config version。
    - SMTLK 3.0: SmartLink V3 version, sniffer mode.
    - SMTLK 4.0: SmartLink V4 version, sonic mode
  - ◆ ver: **3-** Use SmartLink V3 version, sniffer mode, **4-** SmartLink V4 version, sonic mode. The corresponding APP can be downloaded from our website. See appendix D for details.

#### 4.2.2.68. AT+WPS

- Function: Start WPS function
- Format:
  - ◆ Query Operation

**AT+WPS<CR>**

**+ok=<status> <CR><LF><CR><LF>**

- Parameters:
  - ◆ status: WPS status. The module will reboot and work in STA mode connecting to specific router when WPS communication is OK.
    - ◇ WPS Scan Failed: WPS communication is failed.

Note: The router WPS function must be open first then enable module WPS Scan function. The module will quit WPS scan status if there is no WPS router in 5 seconds. If the router's WPS is enabled, the module will reboot and enter WPS mode without reply +ok.

#### 4.2.2.69. AT+WPSBTNEN

- Function: Enable/Disable WPS function.
- Format:
  - ◆ Query Operation

**AT+WPSBTNEN<CR>**

**+ok=<status> <CR><LF><CR><LF>**

◆ Set Operation

**AT+WPSBTNEN =<status><CR>**

**+ok<CR><LF><CR><LF>**

■ Parameters:

◆ status:

- ✧ on: Enable WPS function
- ✧ off: Disable WPS function.

Note: The router WPS function must be open first then enable module WPS Scan function. The module will quit WPS scan status if there is no WPS router in 5 seconds.

#### 4.2.2.70. AT+LPTIO

- Function: nReady,nLink, WPS function mapping. Setting is valid after reset.

■ Format:

◆ Query Operation

**AT+LPTIO<CR>**

**+ok=<status> <CR><LF><CR><LF>**

◆ Set Operation

**AT+LPTIO =<status><CR>**

**+ok<CR><LF><CR><LF>**

■ Parameters:

◆ status: nReady,nLink, WPS function mapping.

- ✧ off/lpb100: nReady,nLink, WPS function are mapping to HF-LPB100 corresponding pin.(Pin44, Pin43, Pin15)
- ✧ on/lpt100: nReady,nLink, WPS function are mapping to HF-LPT100 corresponding pin.(Pin9, Pin10, Pin8)
- ✧ lpt200: nReady,nLink, WPS function are mapping to HF-LPT200 corresponding pin.(Pin11, Pin13, Pin14)

#### 4.2.2.71. AT+WIFI

- Function: Enable/Disable Wi-Fi Command, need to update to V1.0.05 firmware to use this command..

■ Format:

◆ Query Operation

**AT+WIFI<CR>**

**+ok=<status> <CR><LF><CR><LF>**

◆ Set Operation

**AT+WIFI =<status><CR>**

**+ok<CR><LF><CR><LF>**

■ Parameters:

◆ status: Wi-Fi status.

- ✧ UP(boot default status): Enable Wi-Fi Chip
- ✧ DOWN: Disable Wi-Fi Chip

Note: Some Wi-Fi status change command(AT+WMODE and so on)need to reboot before valid. But may use this command only to reboot the Wi-Fi Chip to make the corresponding command valid.This is AT+WIFI=DOWN and then AT+WIFI=UP.

#### 4.2.2.72. AT+SMEM

- Function: Query the RAM status.
- Format:
  - ◆ Query Operation

**AT+SMEM<CR>**

**+ok=<status> <CR><LF><CR><LF>**

- Parameters:
  - ◆ status: The RAM status.

# 5. PACKAGE INFORMATION

## 5.1. Recommended Reflow Profile

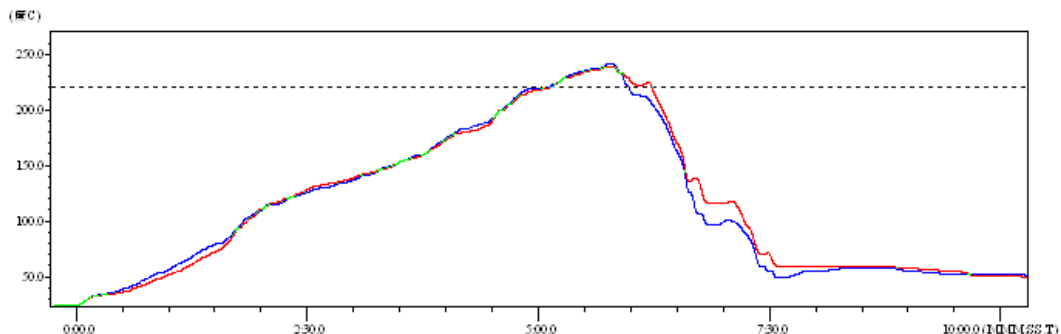

Figure 36. Reflow Soldering Profile

Table 11 Reflow Soldering Parameter

| NO. | Item        | Temperature (Degree) | Time(Sec) |
|-----|-------------|----------------------|-----------|
| 1   | Reflow Time | Time of above 220    | 35~55 sec |
| 2   | Peak-Temp   | 260 max              |           |

- Note:** 1. Recommend to supply N2 for reflow oven.  
 2. N2 atmosphere during reflow (O2<300ppm)

## 5.2. Device Handling Instruction (Module IC SMT Preparation)

- Shelf life in sealed bag: 12 months, at <30°C and <60% relative humidity (RH)
- After bag is opened, devices that will be re-baked required after last baked with window time 168 hours.
- Recommend to oven bake with N2 supplied
- Recommend end to reflow oven with N2 supplied
- Baked required with 24 hours at 125±5°C before rework process
- Recommend to store at ≤ 10% RH with vacuum packing
- If SMT process needs twice reflow:

- (1) Top side SMT and reflow □ □ (2) Bottom side SMT and reflow

Case 1: Wifi module mounted on top side. Need to bake when bottom side process over 168 hours window time, no need to bake within 168 hours

Case 2: Wifi module mounted on bottom side, follow normal bake rule before process

**Note:** Window time means from last bake end to next reflow start that has 168 hours space.

### 5.3. Shipping Information

#### TAPE

Size: 340\*340\*70 mm



#### BOX

Size: 340\*340\*350 mm (inside)



Figure 37. Shipping Information

**Note:**

1 tape = 500pcs

1 box = 5 tapes = 5 \* 500 pcs = 2500pcs



# APPENDIX A: HW REFERENCE DESIGN

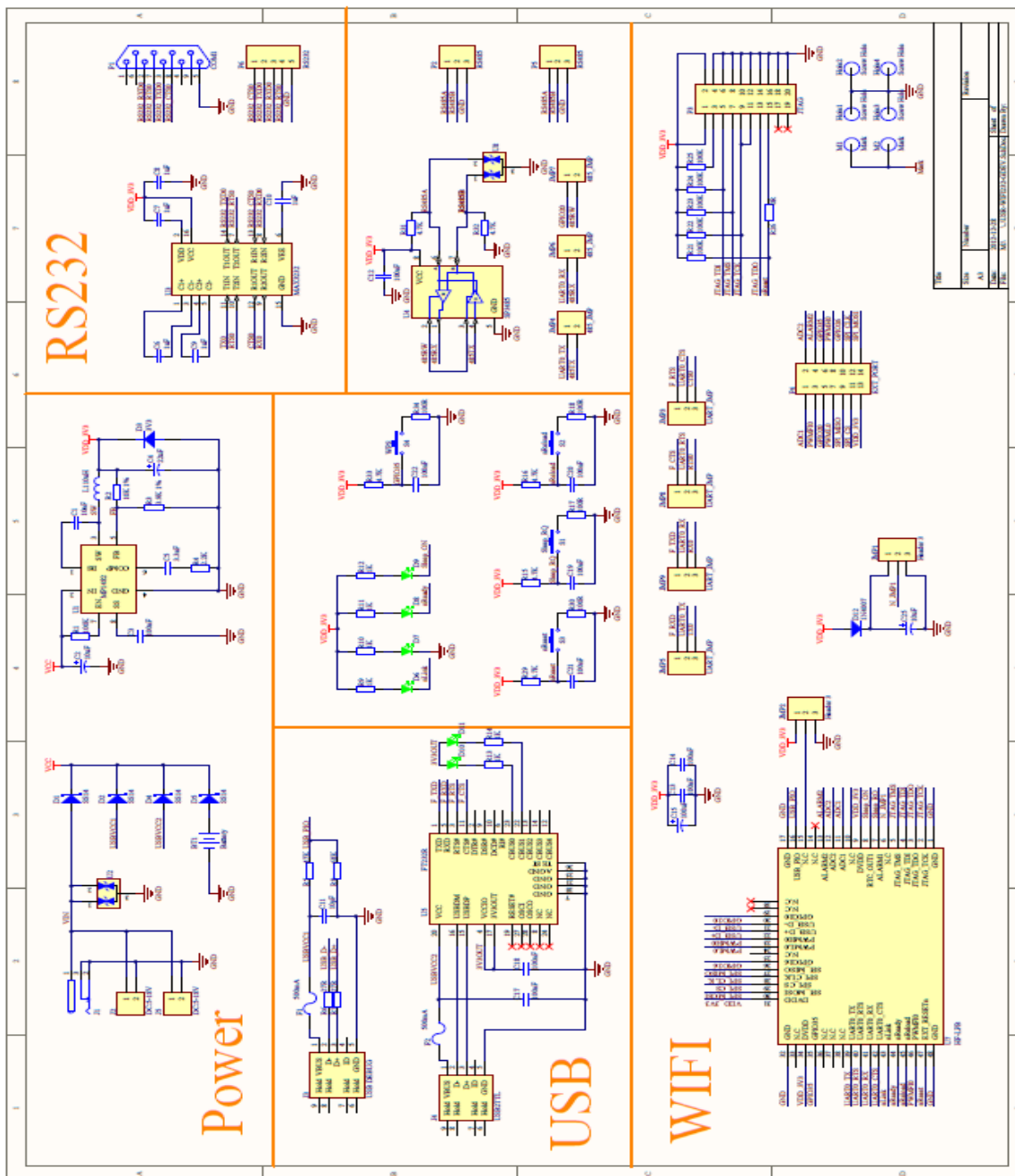

Detailed HF-LPB100 Evaluation Board design source files, pls access High-Flying web download page or contact with High-Flying technical support people to acquire.

# APPENDIX B: CONTROL GPIO/PWM FUNCTION WITH NETWORK COMMANDS

Send command data to control module's GPIO, PWM port after make network connection with TCP or UDP protocol. The status of GPIO won't be changed if the module is reset

## B.1 Network Command

### B.1.1 GPIO <channel> OUT <value>

- Function: Set GPIO Channel value temporarily.
- Parameters:
  - ◆ channel:GPIO Channel number, it can be 11、12、15、18、20、23(GPIO Pin number)
  - ◆ value:GPIO Channel value,1(high voltage), 0(low voltage)
- Return Data:
  - ◆ GPIO OK: Command successful
  - ◆ GPIO NOK: Command failed

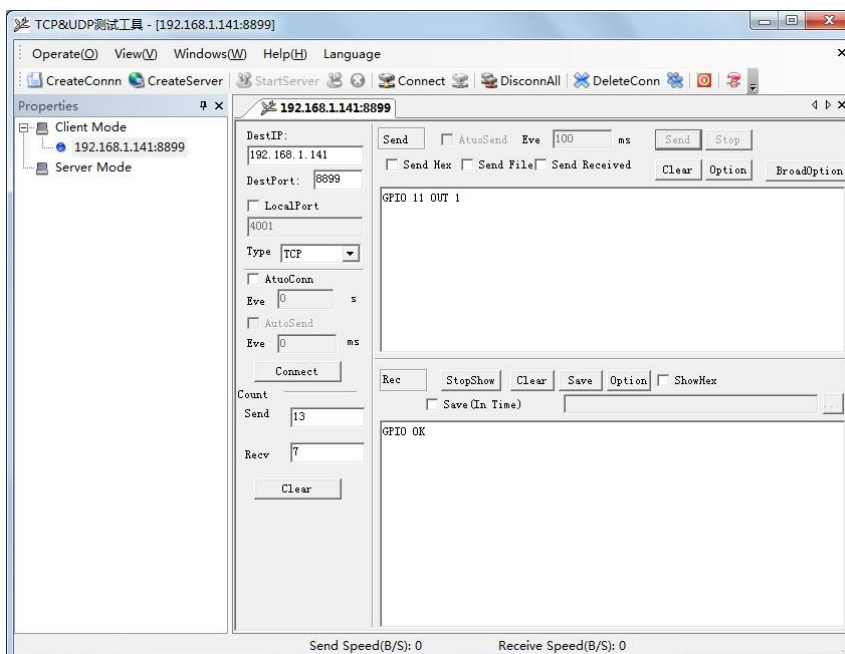

### B.1.2 GPIO <channel> GET

- Function: Query GPIO Channel value
- Parameters:
  - ◆ channel: GPIO Channel number,it can be 11、12、15、18、20、23(GPIO Pin number)
- Return Data:
  - ◆ +ok=<value>
    - value:GPIO Channel value
  - ◆ GPIO NOK: Command failed

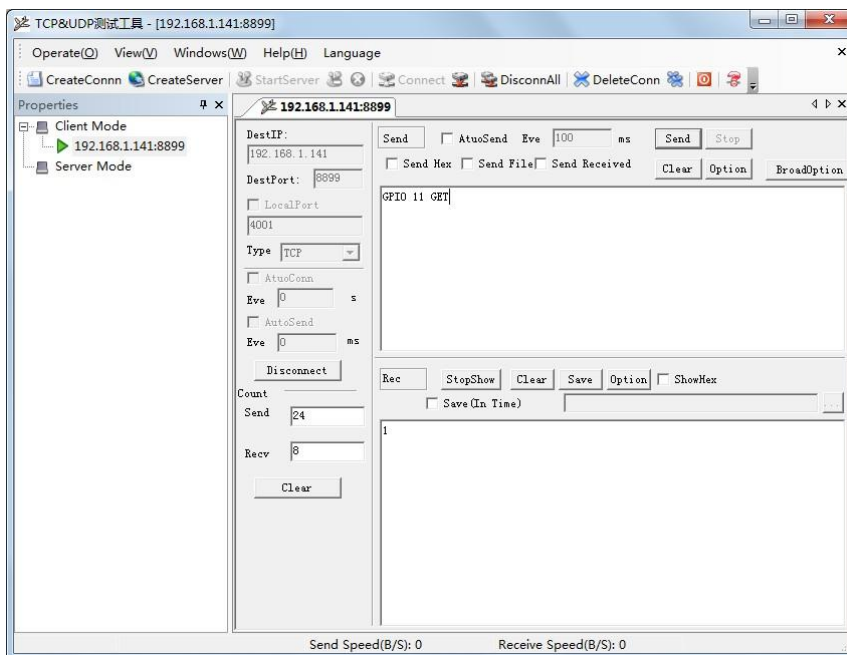

### B.1.3 GPIO <channel> SET

- Function: Save GPIO Channel setting
- Parameters:
  - ◆ channel:GPIO Channel number,it can be 11、12、15、18、20、23(GPIO Pin number)
- Return Data:
  - ◆ GPIO OK: Command successful
  - ◆ GPIO NOK: Command failed

### B.1.4 PWM <channel frequency duty>

- Function: Set PWM Channel output temporarily
- Parameters:
  - ◆ channel:PWM Channel number, it can be 11、12、18、20(GPIO Pin number)
  - ◆ frequency:PWM Channel frequency, it can be 500~60000
  - ◆ duty:PWM Channel duty, it can be 0~100.
- Return Data:
  - ◆ PWM OK: Command successful
  - ◆ PWM NOK: Command failed

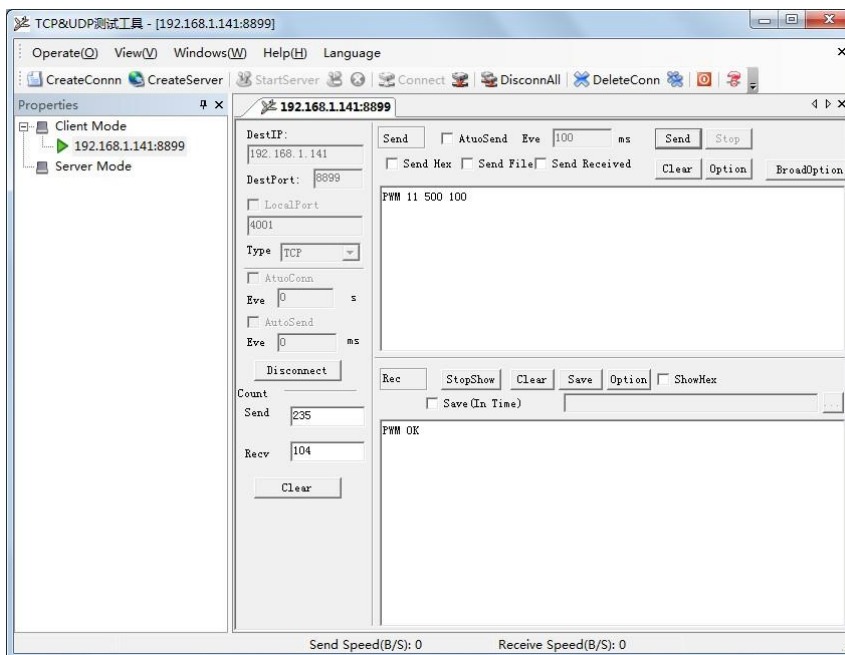

### B.1.5 PWM <channel> GET

- Function: Query PWM Channel output
- Parameters:
  - ◆ channel: PWM Channel number, it can be 11、12、18、20(GPIO Pin number)
- Return Data:
  - ◆ +ok=<frequency duty>
    - frequency: PWM Channel frequency
    - duty: PWM Channel duty
  - ◆ PWM NOK: Command failed

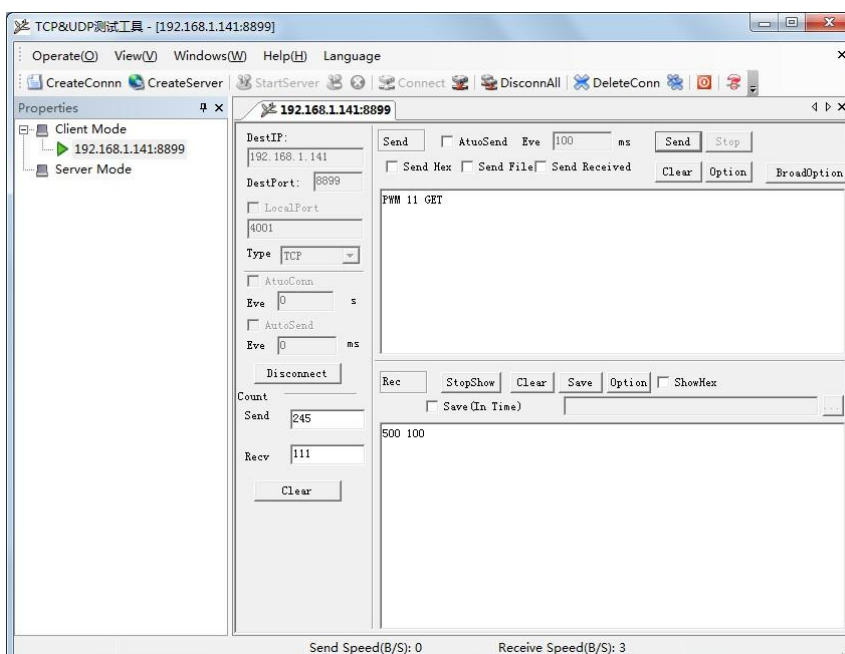

### B.1.6 PWM <channel> SET

- Function: Save PWM Channel setting
- Parameters:
  - ◆ channel: PWM Channel number, it can be 11、12、18、20(GPIO Pin number)
- Return Data:
  - ◆ PWM OK: Command successful
  - ◆ PWM NOK: Command failed

## B.2 Hexadecimal Network Command

Send hexadecimal data to fastly read module's port status.

### B.2.1 Read all GPIO Channel

- Send Data **【0a】** :
- Return Data: **【8a <value>】**
  - ◆ value: bit0、bit1 represent GPIO15、GPIO23 value.

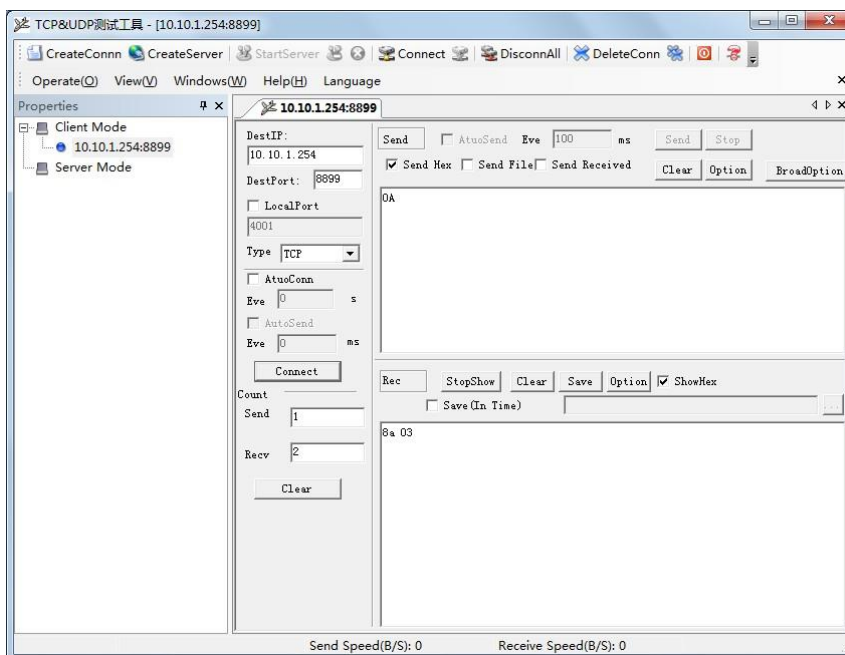

### B.2.2 Reverse GPIO Channel value

- Send Data **【03 <channel>】** :
  - ◆ channel: GPIO Channel number, it can be 01、02(GPIO15、GPIO23)
- Return Data: **【83 <channel value>】**
  - ◆ channel: GPIO Channel number, it can be 01、02(GPIO15、GPIO23)
  - ◆ value: GPIO Channel value, 0 or 1

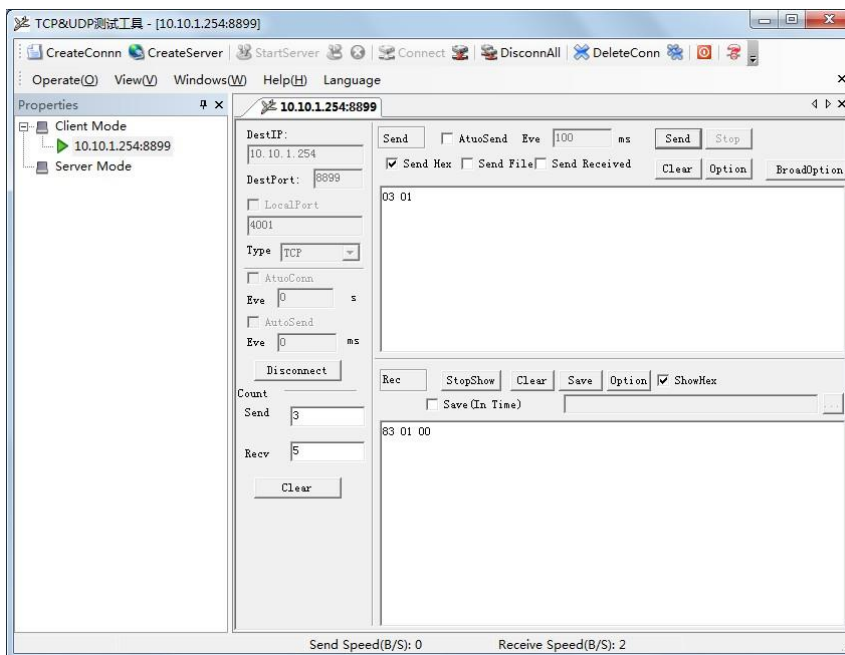

### B.2.3 Read All PWM Channel Frequency

- Send Data: **【30】** :
- Return Data: **【b0 <value1 value2 value3 value4 value5 value6 value7 value8>】**
  - ◆ value1: High byte of PWM Channel 0(GPIO11) frequency
  - ◆ value2: Low byte of PWM Channel 0(GPIO11) frequency
  - ◆ value3: High byte of PWM Channel 1(GPIO12) frequency
  - ◆ value4: Low byte of PWM Channel 1(GPIO12) frequency
  - ◆ value5: High byte of PWM Channel 2(GPIO18) frequency
  - ◆ value6: Low byte of PWM Channel 2(GPIO18) frequency
  - ◆ value7: High byte of PWM Channel 3(GPIO20) frequency
  - ◆ value8: Low byte of PWM Channel 3(GPIO20) frequency

### B.2.4 Write PWM Channel Frequency

- Send Data: **【32 <channel value1 value2】** :
  - ◆ channel: PWM Channel number
  - ◆ value1: High byte of PWM Channel frequency
  - ◆ value2: Low byte of PWM Channel frequency
- Return Data: **【b2 <channel value1 value2>】**
  - ◆ Channel: PWM Channel number
  - ◆ value1: High byte of PWM Channel frequency
  - ◆ value2: Low byte of PWM Channel frequency

### B.2.5 Read All PWM Channel Duty

- Send Data: **【20】** :
- Return Data: **【a0 <value1 value2 value3 value4>】**
  - ◆ value1: Duty of PWM Channel 0
  - ◆ value2: Duty of PWM Channel 1
  - ◆ value3: Duty of PWM Channel 2

- ◆ value4: Duty of PWM Channel 3

#### B.2.6 Write All PWM Channel Duty

- Send Data: **【24 <value1 value2 value3>】** :
- Return Data: **【a4 <value1 value2 value3>】**
  - ◆ value1: Duty of PWM Channel 0
  - ◆ value2: Duty of PWM Channel 1
  - ◆ value3: Duty of PWM Channel 2

#### B.2.6 Write PWM Channel Duty

- Send Data: **【22 <channel value1>】** :
  - ◆ channel:PWM Channel number
  - ◆ value1: Duty of PWM Channel
- Return Data: **【a2 <channel value1>】**
  - ◆ Channel:PWM Channel number
  - ◆ value1: Duty of PWM Channel

#### B.2.7 Save Present GPIO,PWM Setting

- Send Data: **【7a】** :
- Return Data: **【fa】**

#### B.2.8 Assert All GPIO Channel Low

- Send Data: **【04】** :
- Return Data: **【84 00】**

#### B.2.9 Assert All GPIO Channel High

- Send Data: **【05】** :
- Return Data: **【85 01】**

#### B.2.10 Read Resources of module

- Send Data: **【7e】** :
- Return Data: **【fe <value1 value2 value3>】**
  - ◆ value1: Module's GPIO output pin number .
  - ◆ value2:Module's GPIO input pin number
  - ◆ value3:Module's PWM pin number

## APPENDIX C: HTTP PROTOCOL TRANSFER

HF-LPB100 module support http data transfer in command mode. If any detailed HTTP protocol, contact us and we may support customization.

### C.1. HTTP AT command

#### C.1.1. AT+HTTPURL

- Function: Set /Query HTTP server IP address and Port Number.
- Format:
  - ◆ Query Operation  
`AT+HTTPURL<CR>`  
`+ok=<IP,Port><CR><LF><CR><LF>`
  - ◆ Set Operation  
`AT+HTTPURL=<IP,Port><CR>`  
`+ok<CR><LF><CR><LF>`
- Parameters:
  - ◆ IP: IP address.
  - ◆ Port: Port number.

#### C.1.2. AT+HTTPTP

- Function: Set /Query HTTP request type
- Format:
  - ◆ Query Operation  
`AT+HTTPTP<CR>`  
`+ok=<Type><CR><LF><CR><LF>`
  - ◆ Set Operation  
`AT+HTTPTP=<Type><CR>`  
`+ok<CR><LF><CR><LF>`
- Parameters:
  - ◆ Type: GET(default) or POST.

#### C.1.3. AT+HTTTPH

- Function: Set/Query HTTP protocol header path.
- Format:
  - ◆ Query Operation  
`AT+HTTTPH<CR>`  
`+ok=<Path><CR><LF><CR><LF>`
  - ◆ Set Operation  
`AT+HTTTPH=<Path><CR>`  
`+ok<CR><LF><CR><LF>`
- Parameters:



- ◆ Path: Max length is 50 bytes.

#### C.1.4. AT+HTTPCN

- Function: Set/Query Connection of HTTP protocol header

- Format:

- ◆ Query Operation

**AT+HTTPCN<CR>**

**+ok=<Connection><CR><LF><CR><LF>**

- ◆ Set Operation

**AT+HTTPCN=<Connection><CR>**

**+ok<CR><LF><CR><LF>**

- Parameters:

- ◆ Connection: Max length is 20 bytes.

#### C.1.5. AT+HTTPUA

- Function: Set/Query User-Agent of HTTP protocol header.

- Format:

- ◆ Query Operation

**AT+HTTPUA<CR>**

**+ok=<Parameter><CR><LF><CR><LF>**

- ◆ Set Operation

**AT+HTTPUA=<Parameter><CR>**

**+ok<CR><LF><CR><LF>**

- Parameters:

- ◆ Parameter: Max length is 20 bytes.

#### C.1.6. AT+HTTPDT

- Function: Send HTTP request or data.

- Format:

- ◆ Set Operation

**AT+HTTPDT=<Data><CR>**

**+ok<CR><LF><CR><LF>**

- Parameters:

- ◆ Data: HTTP request data, send AT+HTTPDT directly if no data to be sent.

## C.2. HTTP Example

HTTP parameter settings are as follows:

|                           |                                  |
|---------------------------|----------------------------------|
| AT+HTTPURL=192.168.1.1,80 | Set HTTP server address and port |
| AT+HTTPPT=POST            | Set HTTP request type            |
| AT+HTTPPH=/abcd           | Set HTTP protocol header path    |
| AT+HTTPCN= keep-alive     | Set HTTP Connection area         |
| AT+HTTPUA= lwip1.3.2      | Set HTTP User-Agent area         |

If send “AT+HTTPD”, the data packet will be sent as the following instance including the two new line:

```
POST /abcd HTTP/1.1
Connection:keep-alive
User-Agent:lwp1.3.2
Content-Length:0
Host:192.168.0.127:8999
```

If send AT+HTTPD=abcd, the data packet will be sent as the following instance:

```
POST /abcd HTTP/1.1
Connection:keep-alive
User-Agent:lwp1.3.2
Content-Length:4
Host:192.168.0.127:8999
```

abcd

The data received from HTTP server will be output to serial port and end with “+ok”.

If the module hasn't received data from HTTP server for 5 second, it will cut the TCP link with HTTP server.

### C.3. Sending HTTP Raw Data in Throughput Mode(Recommend)

Step 1、 Configure HTTP server information

```
AT+NETP=tcp,client,80,testnewjava.gotoip4.com
+ok
```

Step 2、 Configure module connecting to router AP and reboot.

```
AT+WSSSID=Tenda_GYH
+ok

AT+WSKEY=wpa2psk,aes,12345678
+ok

AT+WMODE=sta
+ok

AT+Z
```

Step 3、 Sending HTTP raw data via UART, end the data with<CR><LF><CR><LF>



### C.4. Sending HTTP Request By AT Command

Step 1、Configure HTTP AT command. SOCKB must set as None.

```

AT+HTTTPURL
+ok=testnewjava.gotoip4.com,80

AT+HTTTPTP
+ok=GET

AT+HTTTPPH
+ok=/bbb.html

AT+HTTTPCN
+ok=Keep-Alive

AT+HTTTPUA
+ok=lwip1.3.2

AT+SOCKB
+ok=NONE

```

Step 2. Configure module connecting to router AP and reboot.

```
AT+WSSSID=Tenda_GYH
+ok

AT+WSKEY=wpa2psk,aes,12345678
+ok

AT+WMODE=sta
+ok

AT+Z
```

Step 3. Send HTTP request

```
AT+HTTPDPT
HTTP/1.1 200 OK
Server: nginx
Date: Fri, 27 Feb 2015 07:12:11 GMT
Content-Type: text/html
Transfer-Encoding: chunked
Connection: keep-alive
X-Powered-By-360wzB: wangzhan.360.cn
Accept-Ranges: bytes
ETag: w/"63-1425006844000"
Last-Modified: Fri, 27 Feb 2015 03:14:04 GMT
Vary: Accept-Encoding,User-Agent

3f
<html>
<body>
<h1>bbbbbb</h1>

中国

</body>
</html>
0
+ok
```

## APPENDIX D: REFERENCES

### D.1. High-Flying Mass Production Tool

Download Address: [http://www.hi-flying.com/download\\_detail\\_dc/&downloadsId=07bc0a59-0a0d-4fb4-a5e5-c3403f09ab08&comp\\_stats=comp-FrontDownloads\\_list01-dc.html](http://www.hi-flying.com/download_detail_dc/&downloadsId=07bc0a59-0a0d-4fb4-a5e5-c3403f09ab08&comp_stats=comp-FrontDownloads_list01-dc.html)

### D.2. SmartLink APP V3 Config Tool

IOS Platform : [http://www.hi-flying.com/download\\_detail\\_dc/&downloadsId=5cc0c241-77b4-48c1-bf9c-2ad2954b3b50&comp\\_stats=comp-FrontDownloads\\_list01-dc.html](http://www.hi-flying.com/download_detail_dc/&downloadsId=5cc0c241-77b4-48c1-bf9c-2ad2954b3b50&comp_stats=comp-FrontDownloads_list01-dc.html)

Android Platform: [http://www.hi-flying.com/download\\_detail\\_dc/&downloadsId=9a0d0290-477e-4184-8636-18510eaed6b1&comp\\_stats=comp-FrontDownloads\\_list01-dc.html](http://www.hi-flying.com/download_detail_dc/&downloadsId=9a0d0290-477e-4184-8636-18510eaed6b1&comp_stats=comp-FrontDownloads_list01-dc.html)

#### D.2.1. SmartLink APP V4 Config Tool(For LPB100U only)

Android/IOS Platform : [http://www.hi-flying.com/download\\_detail\\_dc/&downloadsId=7b35fdc4-b649-4e23-87b9-a3324ae76b43.html](http://www.hi-flying.com/download_detail_dc/&downloadsId=7b35fdc4-b649-4e23-87b9-a3324ae76b43.html)

### D.3. EVK Quick Start Guide

Download Address: [http://www.hi-flying.com/download\\_detail\\_dc/&downloadsId=b545c662-4ec7-49a4-aea4-e0997f062a62&comp\\_stats=comp-FrontDownloads\\_list01-dc.html](http://www.hi-flying.com/download_detail_dc/&downloadsId=b545c662-4ec7-49a4-aea4-e0997f062a62&comp_stats=comp-FrontDownloads_list01-dc.html)

### D.4. SDK Download

Download Address: [http://www.hi-flying.com/download\\_detail\\_sdk/&downloadsId=8dd69136-6e5c-4bac-9b2d-9a1c381450a6.html](http://www.hi-flying.com/download_detail_sdk/&downloadsId=8dd69136-6e5c-4bac-9b2d-9a1c381450a6.html)

## APPENDIX E: CONTACT INFORMATION

---

**Address:** [Room 1002,Building 1,No.3000,Longdong Avenue,Pudong New Area,Shanghai,China,201203](#)

**Web:** [www.hi-flying.com](http://www.hi-flying.com)

**Service Online:** [400-189-3108/18616078755](tel:400-189-3108/18616078755)

**Sales Contact:** [sales@hi-flying.com](mailto:sales@hi-flying.com)

---

For more information about High-Flying modules, applications, and solutions, please visit our web site  
<http://www.hi-flying.com/en/>

**<END OF DOCUMENT>**

## FCC STATEMENT

1. This device complies with Part 15 of the FCC Rules. Operation is subject to the following two conditions:

- (1) This device may not cause harmful interference.
- (2) This device must accept any interference received, including interference that may cause undesired operation.

2. Changes or modifications not expressly approved by the party responsible for compliance could void the user's authority to operate the equipment.

NOTE: This equipment has been tested and found to comply with the limits for a Class B digital device, pursuant to Part 15 of the FCC Rules. These limits are designed to provide reasonable protection against harmful interference in a residential installation.

This equipment generates uses and can radiate radio frequency energy and, if not installed and used in accordance with the instructions, may cause harmful interference to radio communications.

However, there is no guarantee that interference will not occur in a particular installation. If this equipment does cause harmful interference to radio or television reception, which can be determined by turning the equipment off and on, the user is encouraged to try to correct the interference by one or more of the following measures:

Reorient or relocate the receiving antenna.

Increase the separation between the equipment and receiver.

Connect the equipment into an outlet on a circuit different from that to which the receiver is connected.

Consult the dealer or an experienced radio/TV technician for help.

## FCC Radiation Exposure Statement

This equipment complies with FCC radiation exposure limits set forth for an uncontrolled environment. For a "Portable" application, this equipment should be installed and operated with a minimum distance of 12.7cm between the radiator and your body. For a "Mobile" application, this equipment should be installed and operated with a minimum distance of 20cm between the radiator and your body.

**FCC INFORMATION (additional)****OEM INTEGRATION INSTRUCTIONS:**

This module has been approved for use in two configurations:

- A. Mobile Configuration (The module must be installed in the host equipment such that a minimum distance of 20 cm is maintained between the antenna and user)
- B. Portable Configuration (The module must be installed in the host equipment such that a minimum of 12.7 cm is maintained between the antenna and user)

This device is intended only for OEM integrators under the following conditions:

1. The module must be installed in the host equipment such that specified minimum distance is maintained between the antenna and user (20cm for “Mobile” application, 12.7cm for “Portable” application)
2. The transmitter module may not be co-located with any other transmitter or antenna.
3. The module shall be only used with the external antenna(s) that has been originally tested and certified with this module

As long as 3 conditions above are met, further transmitter test will not be required. However, the OEM integrator is still responsible for testing their end-product for any additional compliance requirements required with this module installed.

**Validity of using the module certification:**

In the event that these conditions cannot be met (for example certain laptop configurations or co-location with another transmitter), then the FCC authorization for this module in combination with the host equipment is no longer considered valid and the FCC ID of the module cannot be used on the final product. In these circumstances, the OEM integrator will be responsible for re-evaluating the end product (including the transmitter) and obtaining a separate FCC authorization.

**End product labeling:**

This transmitter module is authorized only for use in device where the antenna may be installed such that 12.7 cm may be maintained between the antenna and users. The final end product must be labeled in a visible area with the following: “Contains FCC ID: AZYHF-LPB100”.

**Information that must be placed in the end user manual:**

For a “Portable” application, maintain a minimum separation distance of 12.7cm or more from all persons during operation. For “Mobile” application, maintain a minimum separation distance of 20cm or more from all persons during operation. Installations requiring less distance, or installations using antennas with gain greater than that with which this was Certified will require additional testing/approvals.



---

© Copyright High-Flying, May, 2011

The information disclosed herein is proprietary to High-Flying and is not to be used by or disclosed to unauthorized persons without the written consent of High-Flying. The recipient of this document shall respect the security status of the information.

The master of this document is stored on an electronic database and is "write-protected" and may be altered only by authorized persons at High-Flying. Viewing of the master document electronically on electronic database ensures access to the current issue. Any other copies must be regarded as uncontrolled copies.