



# FCC Report

**Application Purpose** : Original grant  
**Applicant Name:** : Shenzhen KOHO Technology Co., Ltd  
**FCC ID** : AZQPT360  
**Equipment Type** : Panoramic Camera  
**Model Name** : PT360, KX360, X360  
**Report Number** : FCC16104089A-2  
**Standard(S)** : FCC Part 15 Subpart B  
**Date Of Receipt** : October 28, 2016  
**Date Of Issue** : November 14, 2016

**Test By** :   
\_\_\_\_\_  
(Daisy Qin)

**Reviewed By** :   
\_\_\_\_\_  
(Sol Qin)

**Authorized by** :   
\_\_\_\_\_  
(Michal Ling)

**Prepared by** : **QTC Certification & Testing Co., Ltd.**  
2nd Floor,Bl Building,Fengyeyuan Industrial Plant,,  
Liuxian 2st. Road, Xin'an Street, Bao'an  
District,,Shenzhen,518000  
**Registration Number: 588523**

**REPORT REVISE RECORD**

<b>Report Version</b>	<b>Revise Time</b>	<b>Issued Date</b>	<b>Valid Version</b>	<b>Notes</b>
V1.0	/	November 14, 2016	Valid	Original Report

<b>Table of Contents</b>	<b>Page</b>
<b>1. GENERAL INFORMATION</b>	<b>4</b>
<b>2. TEST DESCRIPTION</b>	<b>6</b>
2.1 MEASUREMENT UNCERTAINTY	6
2.2 DESCRIPTION OF TEST MODES	7
2.3 CONFIGURATION OF SYSTEM UNDER TEST	8
2.4 DESCRIPTION OF SUPPORT UNITS (CONDUCTED MODE)	9
<b>3. SUMMARY OF TEST RESULTS</b>	<b>10</b>
<b>4. MEASUREMENT INSTRUMENTS</b>	<b>11</b>
<b>5. EMC EMISSION TEST</b>	<b>12</b>
5.1 CONDUCTED EMISSION MEASUREMENT	12
5.1.1 POWER LINE CONDUCTED EMISSION LIMITS	12
5.1.2 TEST PROCEDURE	13
5.1.3 DEVIATION FROM TEST STANDARD	13
5.1.4 TEST SETUP	13
5.1.5 EUT OPERATING CONDITIONS	13
5.1.6 TEST RESULTS	14
5.2 RADIATED EMISSION MEASUREMENT	18
5.2.1 RADIATED EMISSION LIMITS	18
5.2.2 TEST PROCEDURE	18
5.2.3 DEVIATION FROM TEST STANDARD	19
5.2.4 TEST SETUP	20
5.2.5 EUT OPERATING CONDITIONS	20
5.2.5.1 TEST RESULTS (BETWEEN 30M – 1000 MHZ)	21
5.2.5.2 TEST RESULTS (1GHZ TO 6GHZ)	25
5.2.5.3 ADDITIONAL TEST RESULTS FOR INTENTIONAL EMISSIONS (1GHZ TO 24GHZ)	26
<b>6. EUT TEST PHOTO</b>	<b>27</b>
<b>7. PHOTOGRAPHS OF EUT</b>	<b>29</b>

## 1. GENERAL INFORMATION

Test Model	PT360, KX360, X360
Applicant	Shenzhen KOHO Technology Co., Ltd
Address	Building3,Jin Yuda industrial Park,shangliao,Shajin,Baoan,Shenzhen
Manufacturer	Shenzhen Kanghai Electronics Co.,Ltd
Address	Shenzhen Baoan District Shajing Street 107 State Road jinyudaindustrial park(I,II,3)3 2 nd Floor,3rd Floor,A
Equipment Type	Panoramic Camera
Brand Name	<b>PROTIS KOHO</b>
Hardware	IT_X6_V13
Software	20160918V06
Battery information:	Li-ion Battery Voltage: 3.7V Capacity: 1100mA
Adapter Information:	N/A
Data of receipt	November 28, 2016
Date of test	October 28, 2016, to November 08, 2016
Deviation	None
Condition of Test Sample	Normal

### Model Difference

Production name	Trade name	Model no.	Description
Panoramic Camera	PROTIS	PT360	Model name is not the same Trademark not the same color is not the same
Panoramic Camera	KOHO	KX360	
Panoramic Camera	PROTIS	X360	

**We hereby certify that:**

The above equipment was tested by QTC Certification & Testing Co., Ltd.

2nd Floor, BI Building, Fengyeyuan Industrial Plant, Liuxian 2st. Road, Xin'an Street, Bao'an District, Shenzhen, 518000

Registration Number: 588523

The data evaluation, test procedures, and equipment configurations shown in this report were made in accordance with the procedures given in ANSI C 63.4:2014. The sample tested as described in this report is in compliance with the FCC Rules Part 15 Subpart B.

The test results of this report relate only to the tested sample identified in this report.

## 2. TEST DESCRIPTION

### 2.1 MEASUREMENT UNCERTAINTY

The reported uncertainty of measurement  $y \pm U$ , where expanded uncertainty  $U$  is based on a standard uncertainty multiplied by a coverage factor of  $k=2$ , providing a level of confidence of approximately **95** %.

No.	Item	Uncertainty
1	Conducted Emission Test	$\pm 3.2\text{dB}$
2	RF power, conducted	$\pm 0.16\text{dB}$
3	Spurious emissions, conducted	$\pm 0.21\text{dB}$
4	All emissions, radiated(<1G)	$\pm 4.7\text{dB}$
5	All emissions, radiated(>1G)	$\pm 4.7\text{dB}$
6	Temperature	$\pm 0.5^\circ\text{C}$
7	Humidity	$\pm 2\%$

## 2.2 DESCRIPTION OF TEST MODES

To investigate the maximum EMI emission characteristics generates from EUT, the test system was pre-scanning tested base on the consideration of following EUT operation mode or test configuration mode which possible have effect on EMI emission level. Each of these EUT operation mode(s) or test configuration mode(s) mentioned above was evaluated respectively.

Pretest Mode	Description
Mode 1	Video Recording
Mode 2	Exchange data with computer
Mode 3	WIFI Transmit 802.11b CH Mid

For Conducted Emission	
Final Test Mode	Test with Keyboard and Mouse
Mode 1	Video Recording
Mode 2	Exchange data with computer

For Radiated Emission	
Final Test Mode	Test with Keyboard and Mouse
Mode 1	Video Recording
Mode 2	Exchange data with computer
Mode 3	WIFI Transmit 802.11b CH Mid

**2.3 CONFIGURATION OF SYSTEM UNDER TEST**

Mode 1&2:

Mode 1



(EUT: Panoramic Camera)

Mode 2

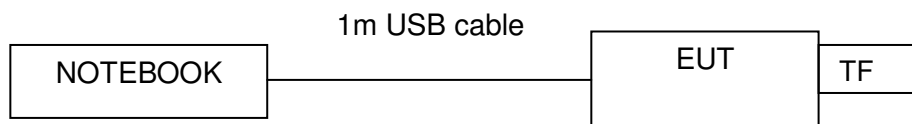

(EUT: Panoramic Camera)

I/O Port of EUT			
I/O Port Type	Q'TY	Cable	Tested with
Power	1	1m USB cable, unshielded	1
Earphone	1	1m cable, unshielded	1



**2.4 DESCRIPTION OF SUPPORT UNITS (CONDUCTED MODE)**

The EUT has been tested as an independent unit together with other necessary accessories or support units. The following support units or accessories were used to form a representative test configuration during the tests.

Item	Equipment	Mfr/Brand	Model/Type No.	Series No.	Note
1	USB Cable	/	N/A	/	1m The shielding
2	The notebook	ThinkPad	ThinkPadE450		

**Note:**

- (1) The support equipment was authorized by Declaration of Confirmation.
- (2) For detachable type I/O cable should be specified the length in cm in 『Length』 column.

### 3. SUMMARY OF TEST RESULTS

Test procedures according to the technical standards:

<b>FCC Part15 , Subpart B</b>			
Standard Section	Test Item	Judgment	Remark
15.107	CONDUCTED EMISSION	PASS	
15.109	RADIATED EMISSION	PASS	

**NOTE:**

(1) "N/A" denotes test is not applicable in this test report.

**4. MEASUREMENT INSTRUMENTS**

Kind of Equipment	Manufacturer	Type No.	Serial No.	Last Calibrated	Calibrated until
ESCI Test Receiver	R&S	ESCI	100005	08/19/2016	08/18/2017
LISN	AFJ	LS16	16010222119	08/19/2016	08/18/2017
LISN(EUT)	Mestec	AN3016	04/10040	08/19/2016	08/18/2017
pre-amplifier	CDSI	PAP-1G18-38	--	08/19/2016	08/18/2017
System Controller	CT	SC100	-	08/19/2016	08/18/2017
Bi-log Antenna	Chase	CBL6111C	2576	08/19/2016	08/18/2017
Spectrum analyzer	R&S	FSU26	200409	08/19/2016	08/18/2017
Horn Antenna	SCHWARZBECK	9120D	1141	08/19/2016	08/18/2017
Bi-log Antenna	SCHWARZBECK	VULB9163	9163/340	08/19/2016	08/18/2017
Pre Amplifier	H.P.	HP8447E	2945A02715	10/13/2016	10/12/2017
9*6*6 Anechoic	--	--	--	08/21/2016	08/20/2017

## 5. EMC EMISSION TEST

### 5.1 CONDUCTED EMISSION MEASUREMENT

#### 5.1.1 POWER LINE CONDUCTED EMISSION Limits (Frequency Range 150KHz-30MHz)

FREQUENCY (MHz)	Class A (dBuV)		Class B (dBuV)		Standard
	Quasi-peak	Average	Quasi-peak	Average	
0.15 -0.5	79.00	66.00	66 - 56 *	56 - 46 *	FCC
0.50 -5.0	73.00	60.00	56.00	46.00	FCC
5.0 -30.0	73.00	60.00	60.00	50.00	FCC

Note:

- (1) The tighter limit applies at the band edges.
- (2) The limit of " \* " marked band means the limitation decreases linearly with the logarithm of the frequency in the range.

The following table is the setting of the receiver

Receiver Parameters	Setting
Attenuation	10 dB
Start Frequency	0.15 MHz
Stop Frequency	30 MHz
IF Bandwidth	9 kHz

### 5.1.2 TEST PROCEDURE

- The EUT was placed 0.4 meters from the horizontal ground plane with EUT being connected to the power mains through a line impedance stabilization network (LISN). All other support equipments powered from additional LISN(s). The LISN provide 50 Ohm/ 50uH of coupling impedance for the measuring instrument.
- Interconnecting cables that hang closer than 40 cm to the ground plane shall be folded back and forth in the center forming a bundle 30 to 40 cm long.
- I/O cables that are not connected to a peripheral shall be bundled in the center. The end of the cable may be terminated, if required, using the correct terminating impedance. The overall length shall not exceed 1 m.
- LISN at least 80 cm from nearest part of EUT chassis.
- For the actual test configuration, please refer to the related Item –EUT Test Photos.

### 5.1.3 DEVIATION FROM TEST STANDARD

No deviation

### 5.1.4 TEST SETUP

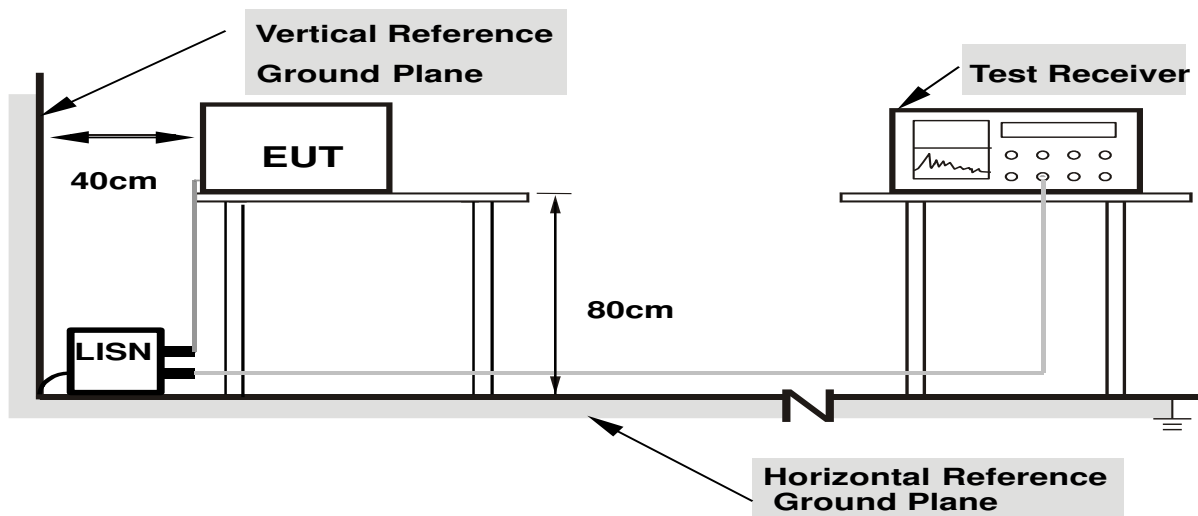

- Note: 1.Support units were connected to second LISN.  
2.Both of LISNs (AMN) are 80 cm from EUT and at least 80 from other units and other metal planes**

### 5.1.5 EUT OPERATING CONDITIONS

The EUT was configured for testing in a typical fashion (as a customer would normally use it). The EUT has been programmed to continuously transmit during test. This operating condition was tested and used to collect the included data.

### 5.1.6 TEST RESULTS

EUT	Panoramic Camera	Model Name	PT360, KX360, X360
Temperature	26 °C	Relative Humidity	54%
Pressure	1010hPa	Phase	L
Test Date	October 31, 2016	Test Mode	Mode 1

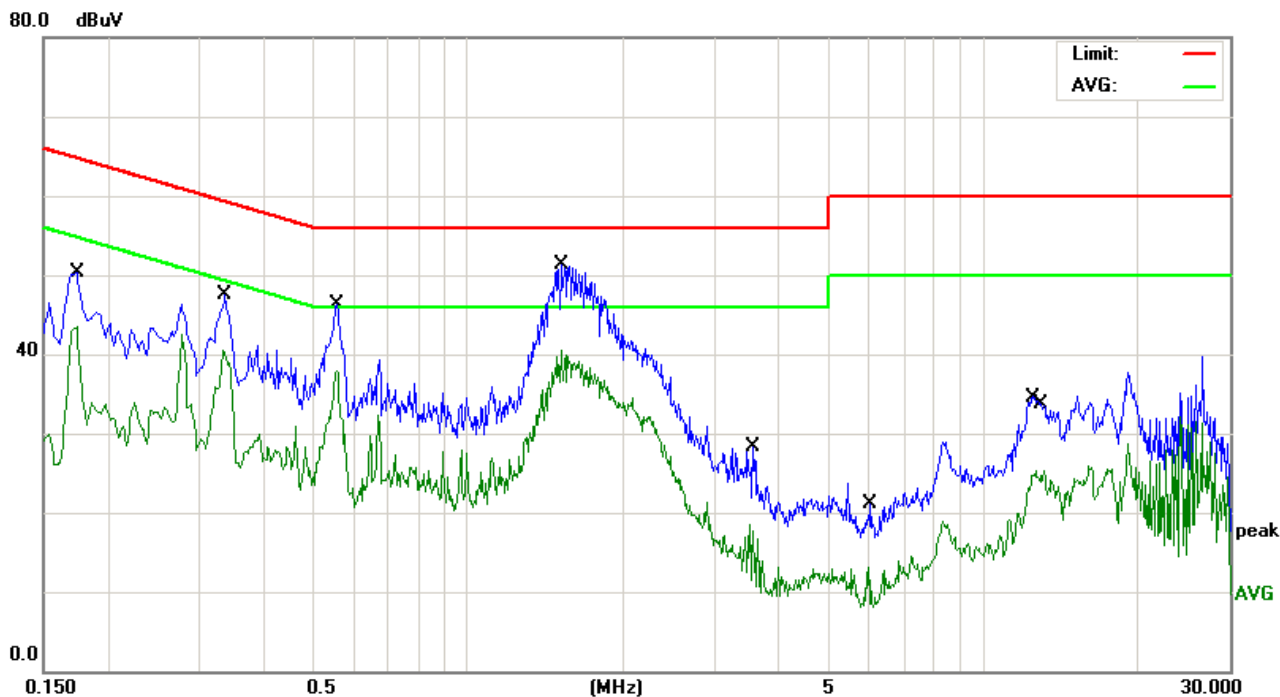

No.	Mk.	Freq. MHz	Reading Level dBuV	Correct Factor dB	Measure- ment dBuV	Limit dBuV	Over dB	Detector
1		0.1740	39.81	10.44	50.25	64.76	-14.51	QP
2		0.1740	33.05	10.44	43.49	54.76	-11.27	AVG
3		0.3339	30.01	10.42	40.43	49.35	-8.92	AVG
4		0.3379	37.01	10.42	47.43	59.25	-11.82	QP
5		0.5580	36.01	10.39	46.40	56.00	-9.60	QP
6		0.5580	27.44	10.39	37.83	46.00	-8.17	AVG
7		1.5140	30.14	10.31	40.45	46.00	-5.55	AVG
8	*	1.5260	40.94	10.31	51.25	56.00	-4.75	QP
9		3.5820	18.14	10.26	28.40	56.00	-27.60	QP
10		5.9780	2.90	10.22	13.12	50.00	-36.88	AVG
11		12.4819	24.43	10.17	34.60	60.00	-25.40	QP
12		13.1140	15.21	10.17	25.38	50.00	-24.62	AVG

EUT	Panoramic Camera	Model Name	PT360, KX360, X360
Temperature	26 °C	Relative Humidity	54%
Pressure	1010hPa	Phase	N
Test Date	October 31, 2016	Test Mode	Mode 1

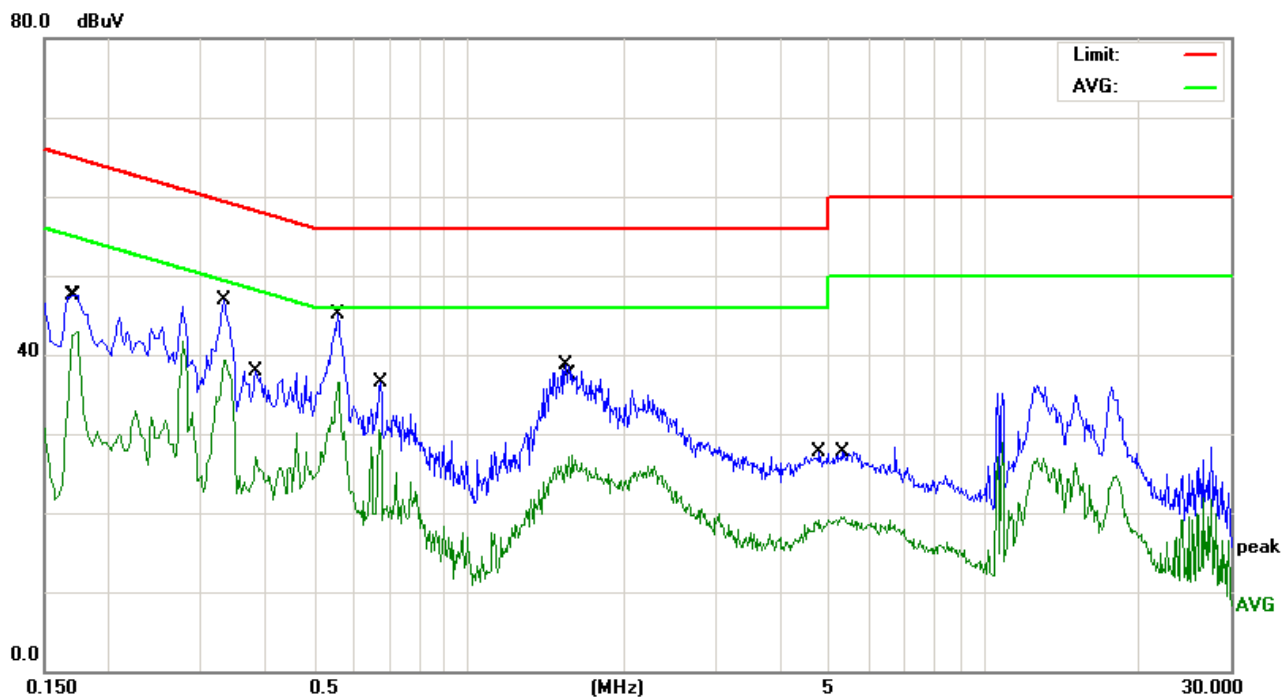

No.	Mk.	Freq. MHz	Reading Level dBuV	Correct Factor dB	Measure- ment dBuV	Limit dBuV	Over dB	Detector
1		0.1712	36.99	10.44	47.43	64.90	-17.47	QP
2		0.1740	32.54	10.44	42.98	54.76	-11.78	AVG
3		0.3339	36.51	10.42	46.93	59.35	-12.42	QP
4	*	0.3339	28.88	10.42	39.30	49.35	-10.05	AVG
5		0.3860	27.57	10.41	37.98	58.15	-20.17	QP
6		0.3860	16.70	10.41	27.11	48.15	-21.04	AVG
7		0.5580	34.66	10.39	45.05	56.00	-10.95	QP
8		0.6700	20.10	10.38	30.48	46.00	-15.52	AVG
9		1.5380	28.30	10.31	38.61	56.00	-17.39	QP
10		1.5859	17.01	10.31	27.32	46.00	-18.68	AVG
11		4.7940	17.53	10.23	27.76	56.00	-28.24	QP
12		5.3500	9.29	10.23	19.52	50.00	-30.48	AVG

EUT	Panoramic Camera	Model Name	
Temperature	26 °C	Relative Humidity	54%
Pressure	1010hPa	Phase	L
Test Date	October 31, 2016	Test Mode	Mode 2

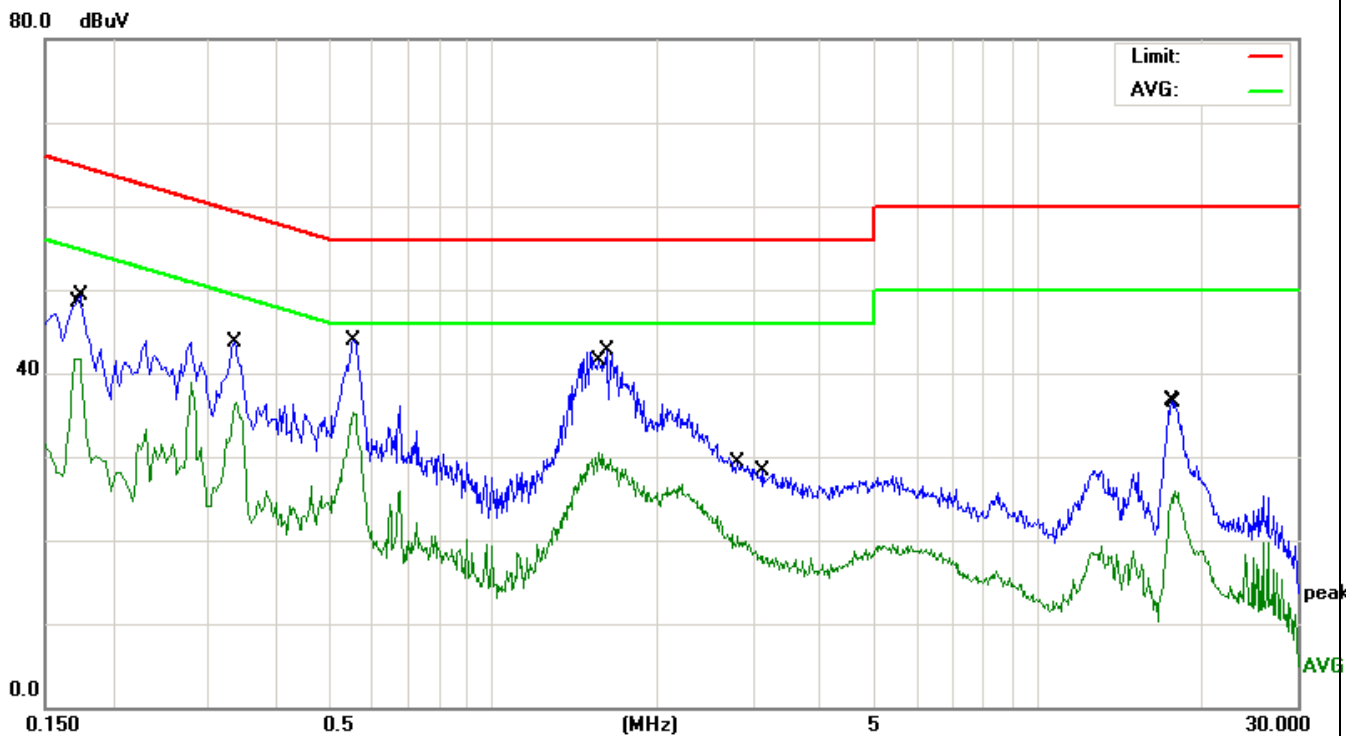

No.	Mk.	Freq. MHz	Reading Level dBuV	Correct Factor dB	Measure- ment dBuV	Limit dBuV	Over dB	Detector
1		0.1700	31.28	10.44	41.72	54.96	-13.24	AVG
2		0.1740	38.79	10.44	49.23	64.76	-15.53	QP
3		0.3339	33.36	10.42	43.78	59.35	-15.57	QP
4		0.3379	26.14	10.42	36.56	49.25	-12.69	AVG
5		0.5540	33.57	10.39	43.96	56.00	-12.04	QP
6	*	0.5540	24.94	10.39	35.33	46.00	-10.67	AVG
7		1.5620	20.25	10.31	30.56	46.00	-15.44	AVG
8		1.6140	32.46	10.31	42.77	56.00	-13.23	QP
9		2.8220	10.16	10.27	20.43	46.00	-25.57	AVG
10		3.1300	17.98	10.27	28.25	56.00	-27.75	QP
11		17.6060	26.67	10.13	36.80	60.00	-23.20	QP
12		17.8819	15.72	10.13	25.85	50.00	-24.15	AVG



EUT	Panoramic Camera	Model Name	PT360, KX360, X360
Temperature	26 °C	Relative Humidity	54%
Pressure	1010hPa	Phase	N
Test Date	October 31, 2016	Test Mode	Mode 2

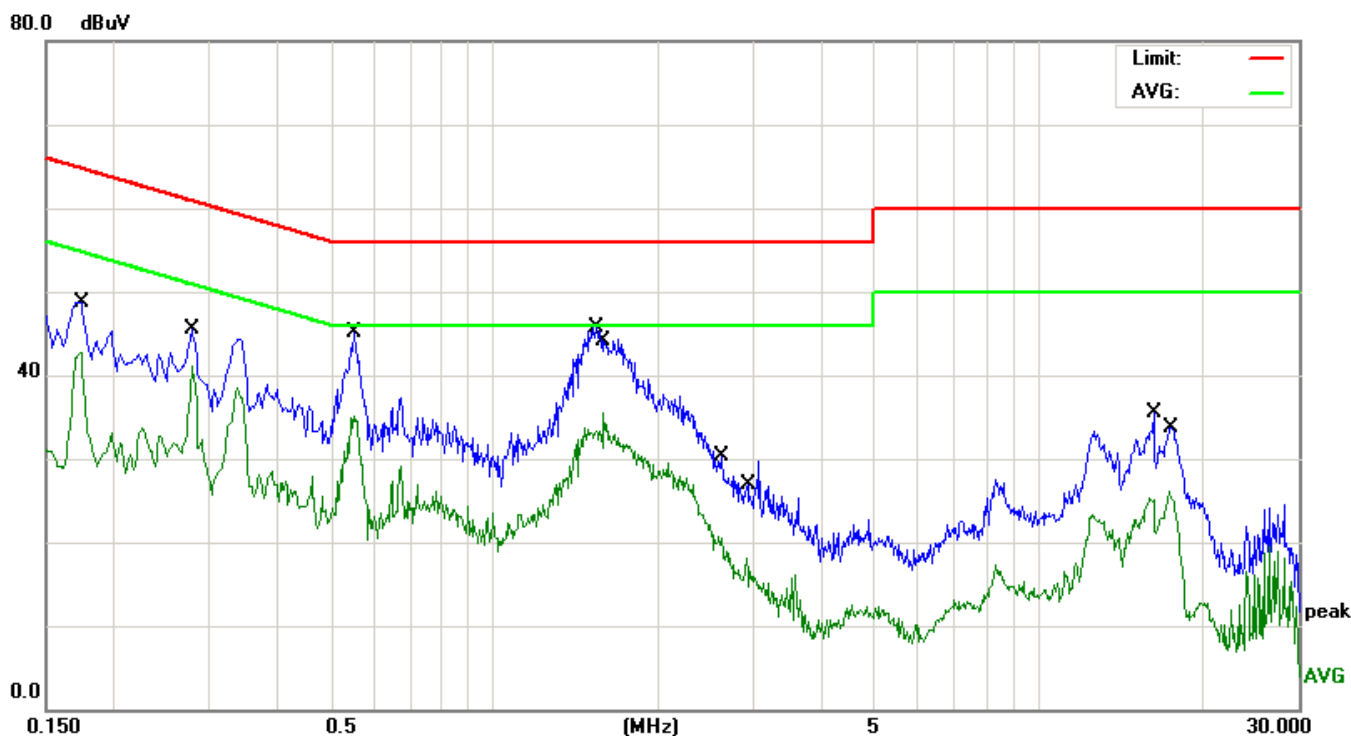

No.	Mk.	Freq. MHz	Reading Level dBuV	Correct Factor dB	Measure- ment dBuV	Limit dBuV	Over dB	Detector
1		0.1740	38.35	10.44	48.79	64.76	-15.97	QP
2		0.1740	32.35	10.44	42.79	54.76	-11.97	AVG
3		0.2779	35.00	10.43	45.43	60.88	-15.45	QP
4	*	0.2779	30.60	10.43	41.03	50.88	-9.85	AVG
5		0.5540	34.78	10.39	45.17	56.00	-10.83	QP
6		0.5540	24.81	10.39	35.20	46.00	-10.80	AVG
7		1.5420	35.47	10.31	45.78	56.00	-10.22	QP
8		1.5859	25.22	10.31	35.53	46.00	-10.47	AVG
9		2.6099	20.08	10.28	30.36	56.00	-25.64	QP
10		2.9060	7.81	10.27	18.08	46.00	-27.92	AVG
11		16.2820	25.44	10.14	35.58	60.00	-24.42	QP
12		17.3540	16.02	10.14	26.16	50.00	-23.84	AVG

## 5.2 RADIATED EMISSION MEASUREMENT

### 5.2.1 RADIATED EMISSION LIMITS (Frequency Range 9kHz-1000MHz)

The field strength of radiated emissions from unintentional radiators at a distance of 3 meters shall not exceed the following values :

Frequencies (MHz)	Field Strength (micorvolts/meter)	Measurement Distance (meters)
0.009~0.490	2400/F(KHz)	300
0.490~1.705	24000/F(KHz)	30
1.705~30.0	30	30
30~88	100	3
88~216	150	3
216~960	200	3
Above 960	500	3

### LIMITS OF RADIATED EMISSION MEASUREMENT (Above 1000MHz)

FREQUENCY (MHz)	Limit (dBuV/m) (at 3M)	
	PEAK	AVERAGE
Above 1000	74	54

Notes:

- (1) The limit for radiated test was performed according to FCC PART 15C.
- (2) The tighter limit applies at the band edges.
- (3) Emission level (dBuV/m)=20log Emission level (uV/m).

Spectrum Parameter	Setting
Attenuation	Auto
Start Frequency	1000 MHz
Stop Frequency	10th carrier harmonic
RB / VB (emission in restricted band)	1 MHz / 1 MHz for Peak, 1 MHz / 1Hz for Average

Receiver Parameter	Setting
Attenuation	Auto
Start ~ Stop Frequency	9kHz~150kHz / RB 200Hz for QP
Start ~ Stop Frequency	150kHz~30MHz / RB 9kHz for QP
Start ~ Stop Frequency	30MHz~1000MHz / RB 120kHz for QP

### 5.2.2 TEST PROCEDURE

- a. The measuring distance of at 3 m shall be used for measurements at frequency up to 1GHz. For frequencies above 1GHz, any suitable measuring distance may be used.

- b. The EUT was placed on the top of a rotating table 0.8 meters above the ground at a 3 meter open area test site. The table was rotated 360 degrees to determine the position of the highest radiation.
- c. The height of the equipment or of the substitution antenna shall be 0.8 m; the height of the test antenna shall vary between 1 m to 4 m. Both horizontal and vertical polarizations of the antenna are set to make the measurement.
- d. The initial step in collecting conducted emission data is a spectrum analyzer peak detector mode pre-scanning the measurement frequency range. Significant peaks are then marked and then Quasi Peak detector mode re-measured.
- e. If the Peak Mode measured value compliance with and lower than Quasi Peak Mode Limit, the EUT shall be deemed to meet QP Limits and then no additional QP Mode measurement performed.
- f. For the actual test configuration, please refer to the related Item –EUT Test Photos.

Note:

***Both horizontal and vertical antenna polarities were tested and performed pretest to three orthogonal axis. The worst case emissions were reported***

### **5.2.3 DEVIATION FROM TEST STANDARD**

No deviation

## 5.2.4 TEST SETUP

### (A) Radiated Emission Test-Up Frequency 30MHz~1GHz

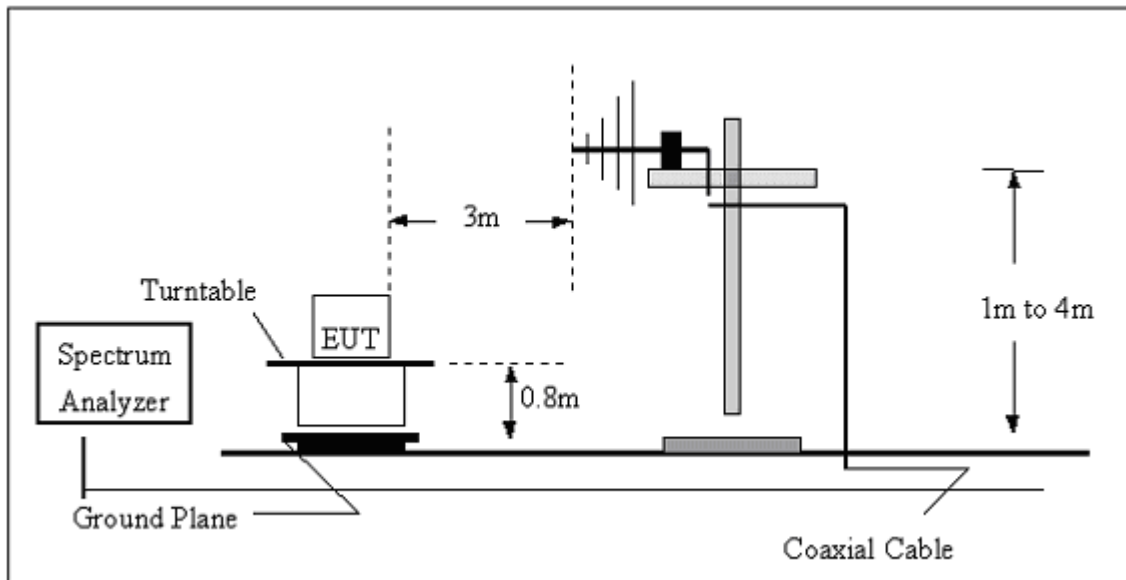

### (B) Radiated Emission Test-Up Frequency Above 1GHz

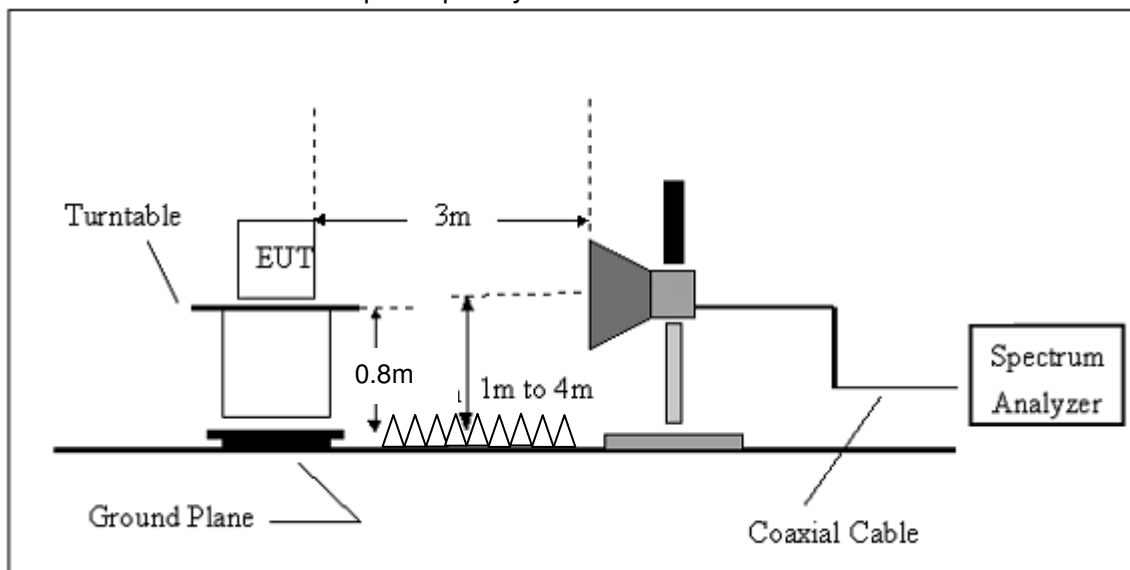

## 5.2.5 EUT OPERATING CONDITIONS

The EUT tested system was configured as the statements of 2.4 Unless otherwise a special operating condition is specified in the follows during the testing.

5.2.5.1 TEST RESULTS (BETWEEN 30M – 1000 MHZ)

EUT	Panoramic Camera	Model Name	PT360, KX360, X360
Temperature	20 °C	Relative Humidity	48%
Pressure	1010 hPa	Polarization :	Horizontal
Test Mode	Mode 1	Test Date	October 31, 2016

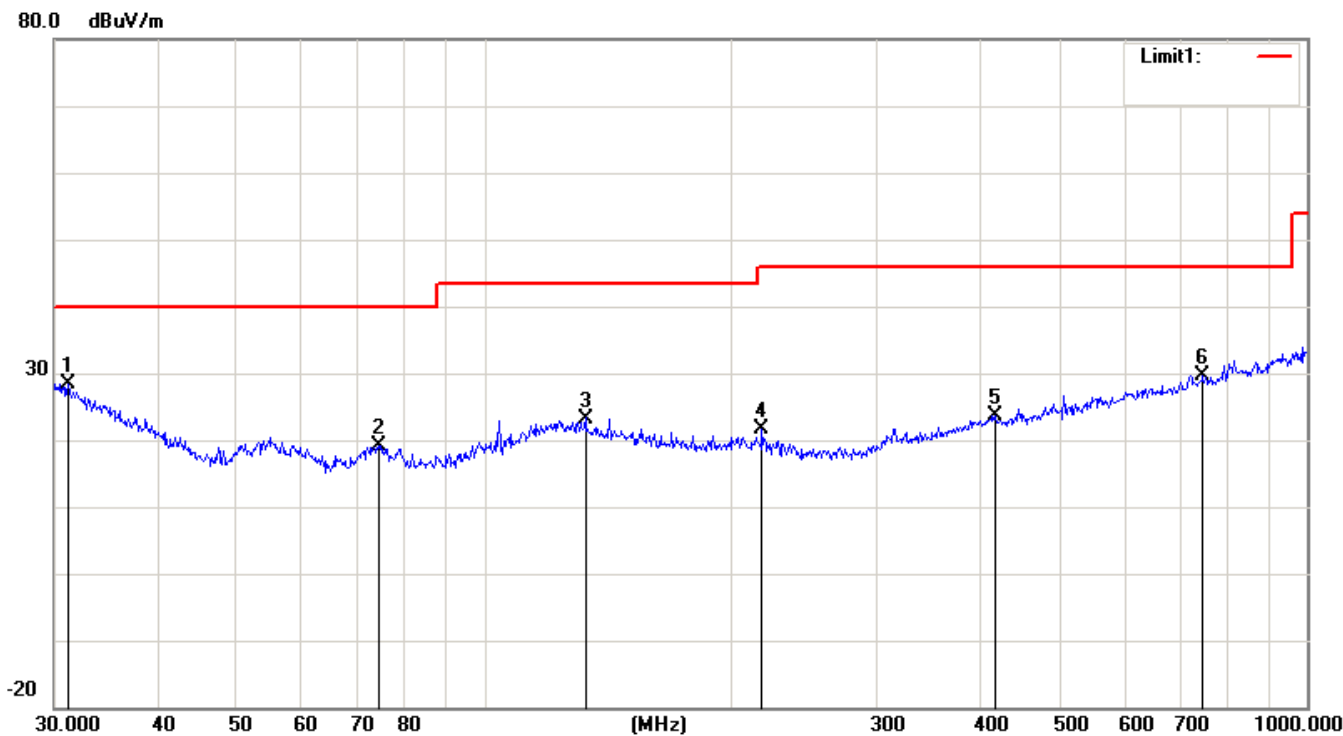

No.	Mk.	Freq. MHz	Reading Level dBuV	Correct Factor dB	Measure- ment dBuV/m	Limit dBuV/m	Over dB	Detector
1	*	31.1798	25.73	2.70	28.43	40.00	-11.57	QP
2		74.3955	26.76	-7.57	19.19	40.00	-20.81	QP
3		132.6850	25.89	-2.64	23.25	43.50	-20.25	QP
4		217.5443	26.95	-5.44	21.51	46.00	-24.49	QP
5		417.6411	25.87	-2.28	23.59	46.00	-22.41	QP
6		747.4825	25.93	3.65	29.58	46.00	-16.42	QP

EUT	Panoramic Camera	Model Name	PT360, KX360, X360
Temperature	20 °C	Relative Humidity	48%
Pressure	1010 hPa	Polarization :	Vertical
Test Mode	Mode 1	Test Date	October 31, 2016

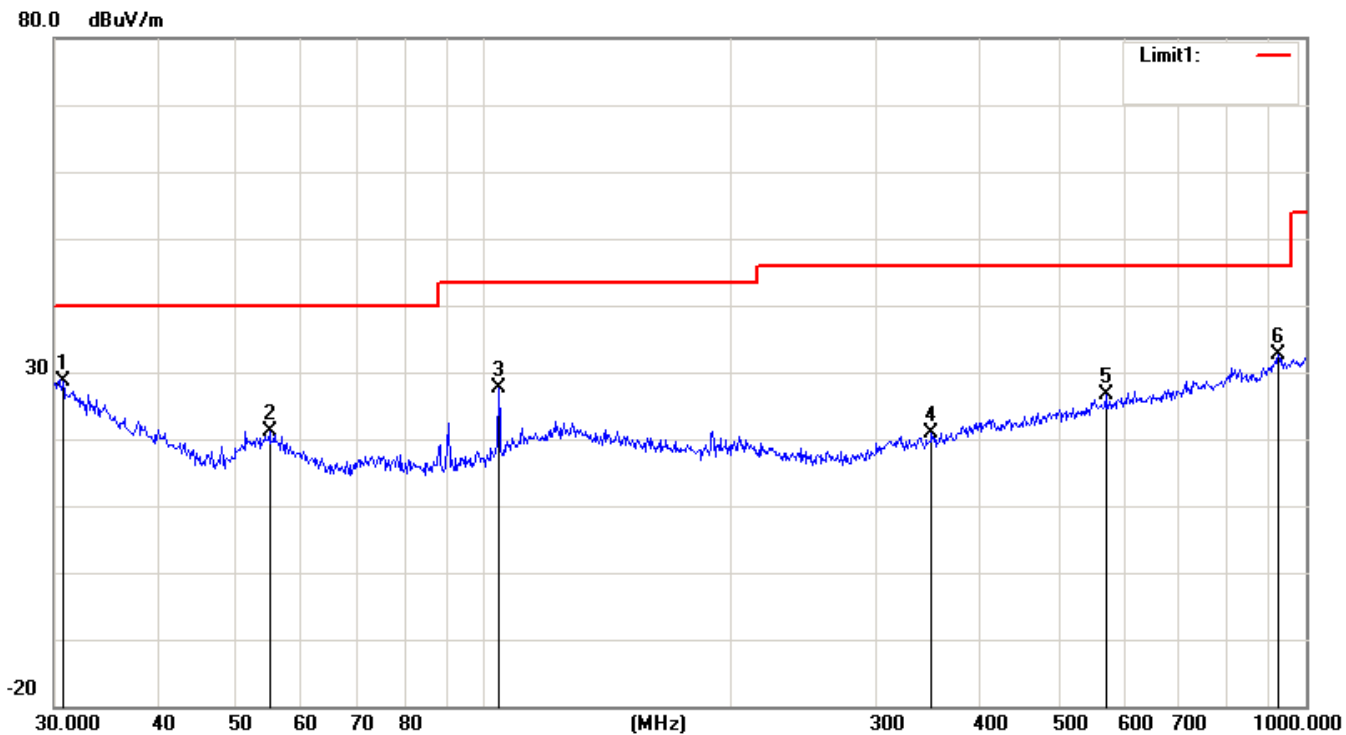

No.	Mk.	Freq. MHz	Reading Level dBuV	Correct Factor dB	Measure- ment dBuV/m	Limit dBuV/m	Over dB	Detector
1	*	30.7455	25.71	2.99	28.70	40.00	-11.30	QP
2		54.8348	30.53	-9.48	21.05	40.00	-18.95	QP
3		104.1701	32.69	-5.18	27.51	43.50	-15.99	QP
4		350.4768	24.99	-4.22	20.77	46.00	-25.23	QP
5		570.6100	26.25	0.49	26.74	46.00	-19.26	QP
6		925.7563	25.80	6.79	32.59	46.00	-13.41	QP

EUT	Panoramic Camera	Model Name	PT360, KX360, X360
Temperature	20 °C	Relative Humidity	48%
Pressure	1010 hPa	Polarization :	Horizontal
Test Mode	Mode 2	Test Date	October 31, 2016

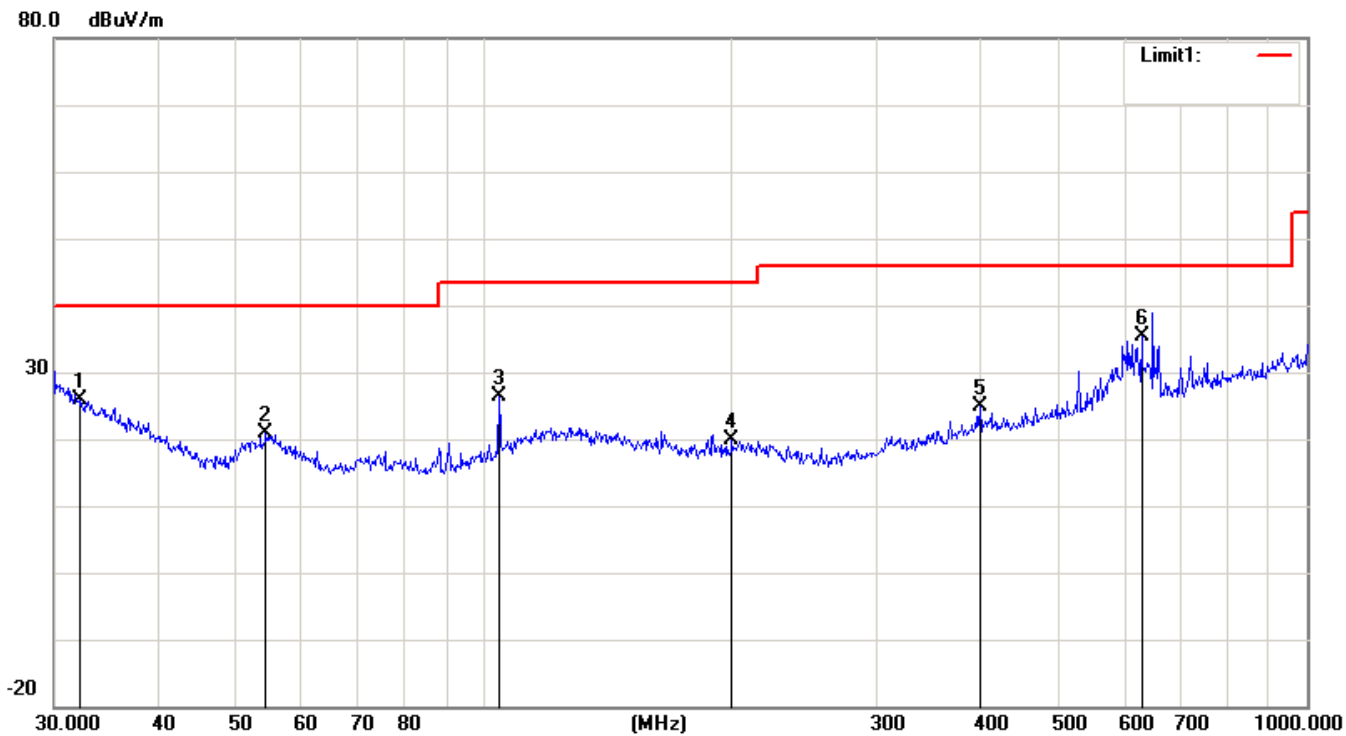

No.	Mk.	Freq. MHz	Reading Level dBuV	Correct Factor dB	Measure- ment dBuV/m	Limit dBuV/m	Over dB	Detector
1		32.1795	23.81	2.03	25.84	40.00	-14.16	QP
2		54.2610	30.21	-9.43	20.78	40.00	-19.22	QP
3		104.1701	31.65	-5.18	26.47	43.50	-17.03	QP
4		199.9856	24.71	-4.82	19.89	43.50	-23.61	QP
5		400.4319	27.16	-2.36	24.80	46.00	-21.20	QP
6	*	629.4772	34.18	1.30	35.48	46.00	-10.52	QP

EUT	Panoramic Camera	Model Name	PT360, KX360, X360
Temperature	20 °C	Relative Humidity	48%
Pressure	1010 hPa	Polarization :	Vertical
Test Mode	Mode 2	Test Date	October 31, 2016

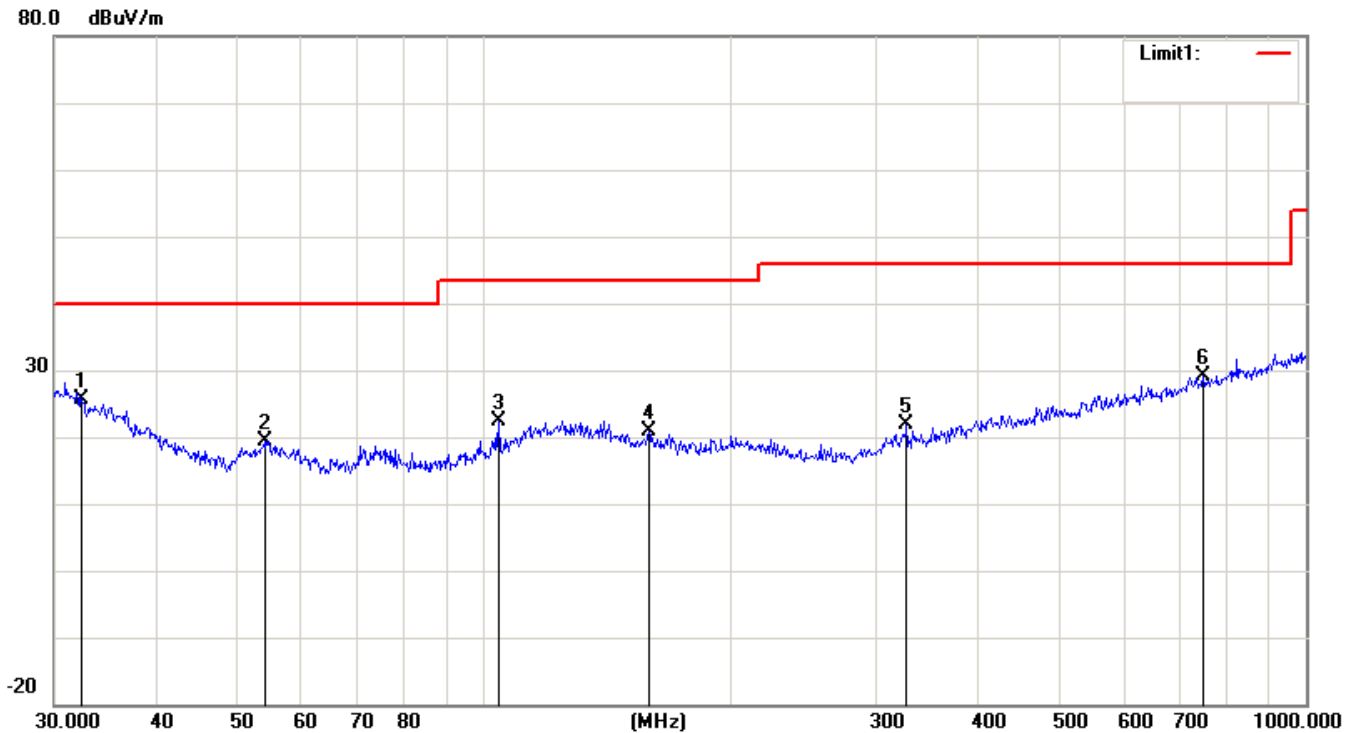

No.	Mk.	Freq. MHz	Reading Level dBuV	Correct Factor dB	Measure- ment dBuV/m	Limit dBuV/m	Over dB	Detector
1	*	32.4059	23.68	1.87	25.55	40.00	-14.45	QP
2		54.0711	28.89	-9.41	19.48	40.00	-20.52	QP
3		104.1701	27.67	-5.18	22.49	43.50	-21.01	QP
4		158.6677	25.21	-4.30	20.91	43.50	-22.59	QP
5		326.7395	26.62	-4.68	21.94	46.00	-24.06	QP
6		750.1083	25.34	3.71	29.05	46.00	-16.95	QP



### 5.2.5.2 TEST RESULTS (1GHZ TO 6GHZ)

EUT	Panoramic Camera	Model Name	W3
Temperature	20 °C	Relative Humidity	48%
Pressure	1010 hPa	Test Mode	Mode 1
Test Date	October 08,2016		

Freq. (MHz)	Ant. Pol.	Emission Level(dBuV)		Limit 3m(dBuV/m)		Over(dB)	
		PK	AV	PK	AV	PK	AV
1632.45	V	58.54	41.84	74	54	-15.46	-12.16
2829.27	V	58.27	40.14	74	54	-15.73	-13.86
1684.52	H	59.26	40.49	74	54	-14.74	-13.51
2831.6	H	58.62	39.62	74	54	-15.38	-14.38

**Remark:**

All emissions not reported were more than 20dB below the specified limit or in the noise floor.

Factor = Antenna Factor + Cable Loss – Pre-amplifier.

All the x/y/z orientation has been investigated, and only worst case is presented in this report.

EUT	Panoramic Camera	Model Name	W3
Temperature	20 °C	Relative Humidity	48%
Pressure	1010 hPa	Test Mode	Mode 2
Test Date	October 08,2016		

Freq. (MHz)	Ant. Pol.	Emission Level(dBuV)		Limit 3m(dBuV/m)		Over(dB)	
		PK	AV	PK	AV	PK	AV
1583.35	V	60.70	41.11	74	54	-13.30	-12.89
2641.52	V	59.88	39.98	74	54	-14.12	-14.02
1628.42	H	58.22	39.05	74	54	-15.78	-14.95
2810.39	H	58.04	39.04	74	54	-15.96	-14.96

**Remark:**

All emissions not reported were more than 20dB below the specified limit or in the noise floor.

Factor = Antenna Factor + Cable Loss – Pre-amplifier.

All the x/y/z orientation has been investigated, and only worst case is presented in this report.

**5.2.5.3 ADDITIONAL TEST RESULTS FOR INTENTIONAL EMISSIONS (1GHZ TO 25GHZ)**

EUT	Panoramic Camera	Model Name	W3
Temperature	20 °C	Relative Humidity	48%
Pressure	1010 hPa	Test Mode	Mode 3

Freq. (MHz)	Ant. Pol.	Emission Level(dBuV)		Limit 3m(dBuV/m)		Over(dB)	
		PK	AV	PK	AV	PK	AV
4882	V	59.62	40.65	74	54	-14.38	-13.35
7323	V	58.77	40.29	74	54	-15.23	-13.71
4882	H	59.77	40.92	74	54	-14.23	-13.08
7323	H	58.98	39.98	74	54	-15.02	-14.02

**Remark:**

All emissions not reported were more than 20dB below the specified limit or in the noise floor.  
All the x/y/z orientation has been investigated, and only worst case is presented in this report.

## 6. EUT TEST PHOTO

CONDUCTED EMISSION TEST



RADIATED EMISSION TEST

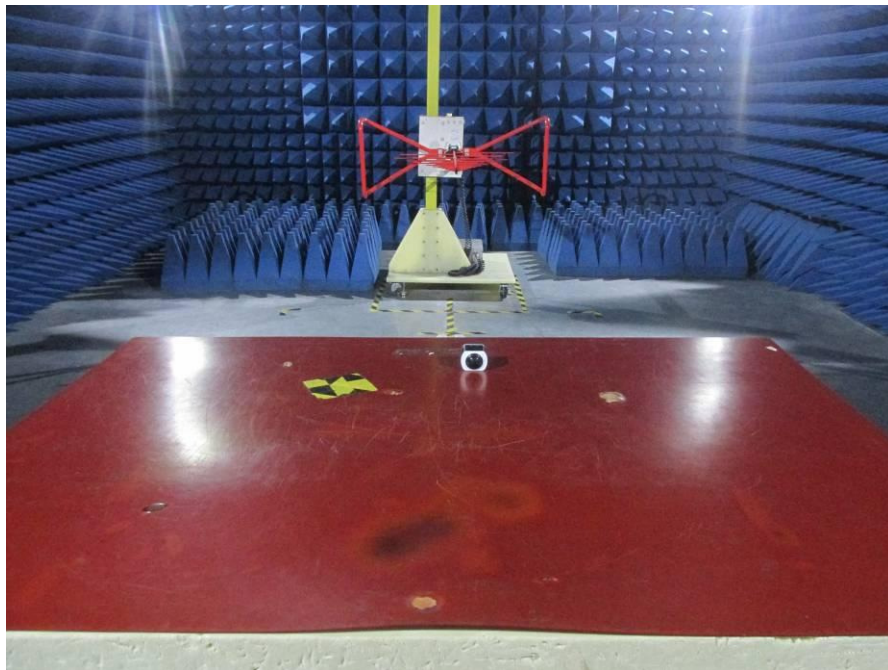

RADIATED EMISSION TEST

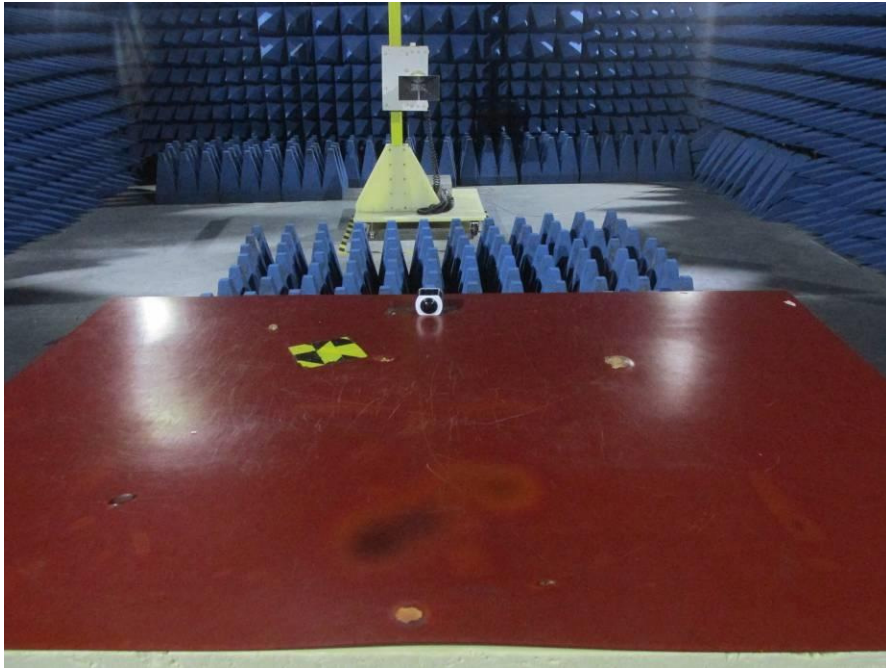

RADIATED EMISSION TEST

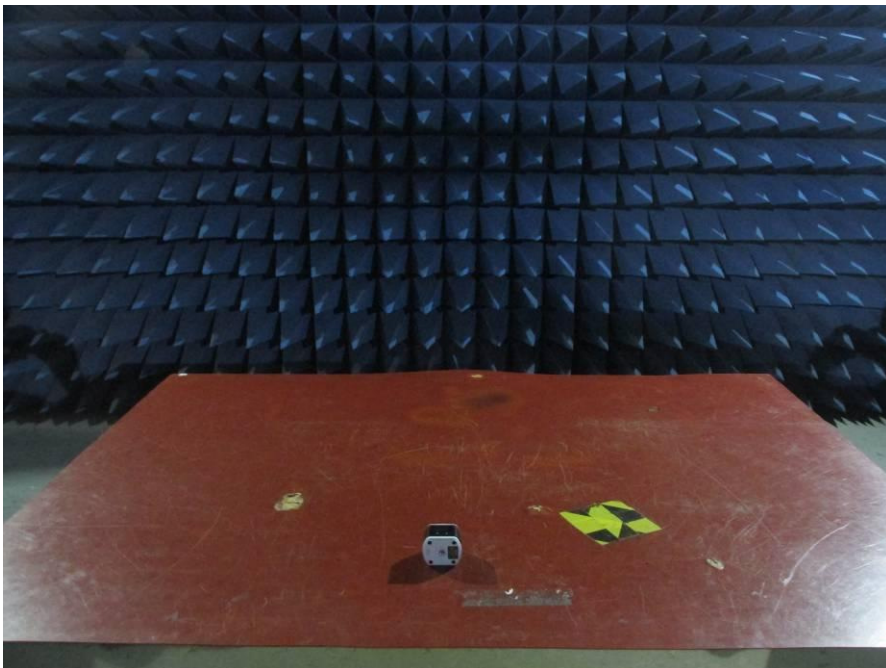

## 7. PHOTOGRAPHS OF EUT

Appearance photograph of EUT



Appearance photograph of EUT



Appearance photograph of EUT



Appearance photograph of EUT



Appearance photograph of EUT



Appearance photograph of EUT



Appearance photograph of EUT



Appearance photograph of EUT





Internal photograph of EUT



Internal photograph of EUT



Internal photograph of EUT



Internal photograph of EUT



Internal photograph of EUT

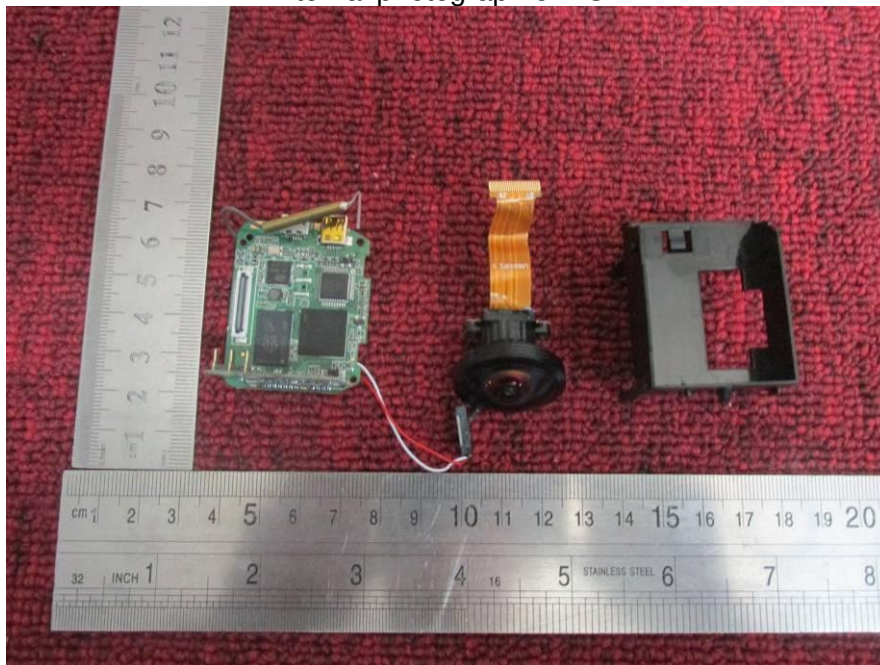

Internal photograph of EUT

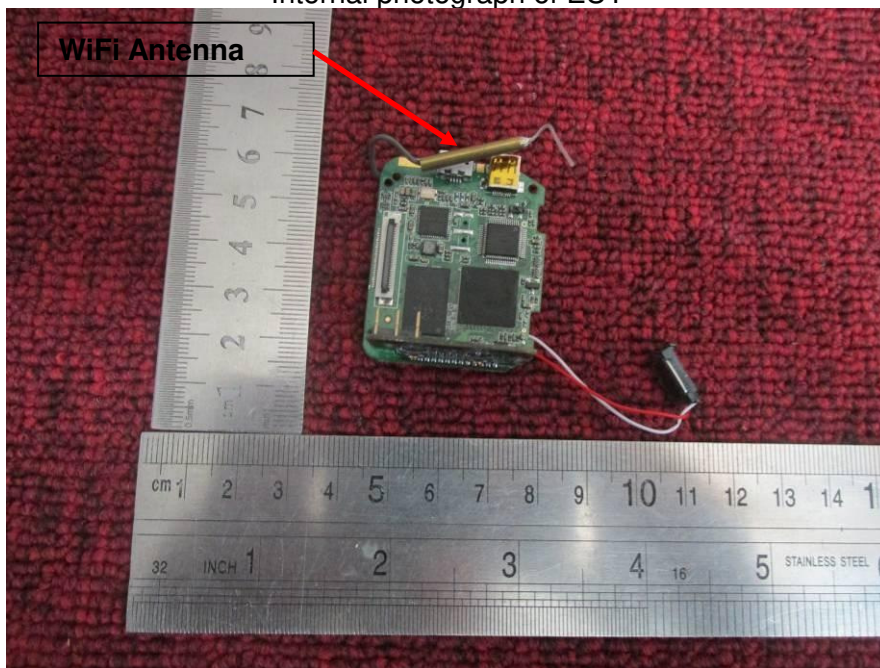

Internal photograph of EUT

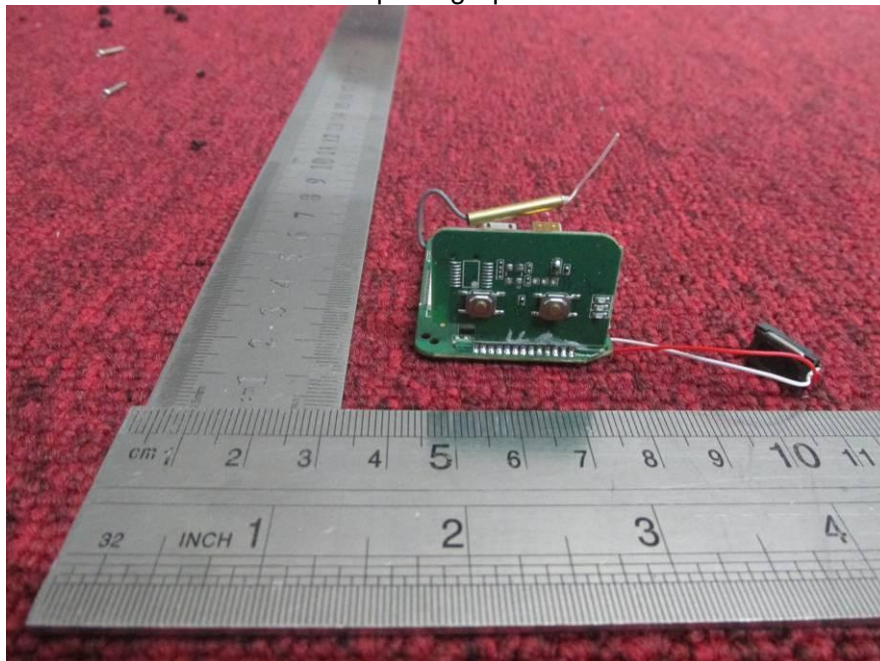

Internal photograph of EUT

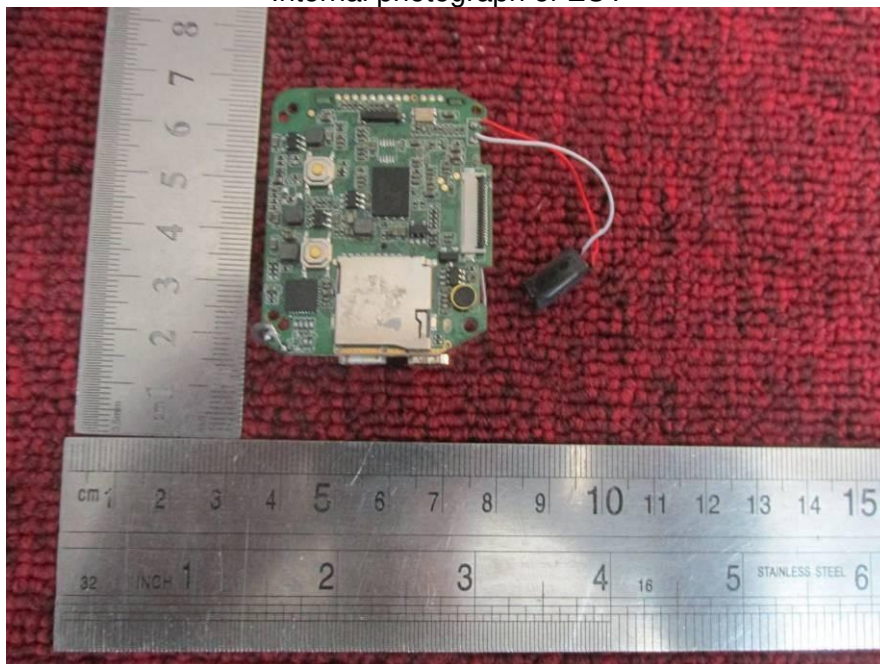

Internal photograph of EUT

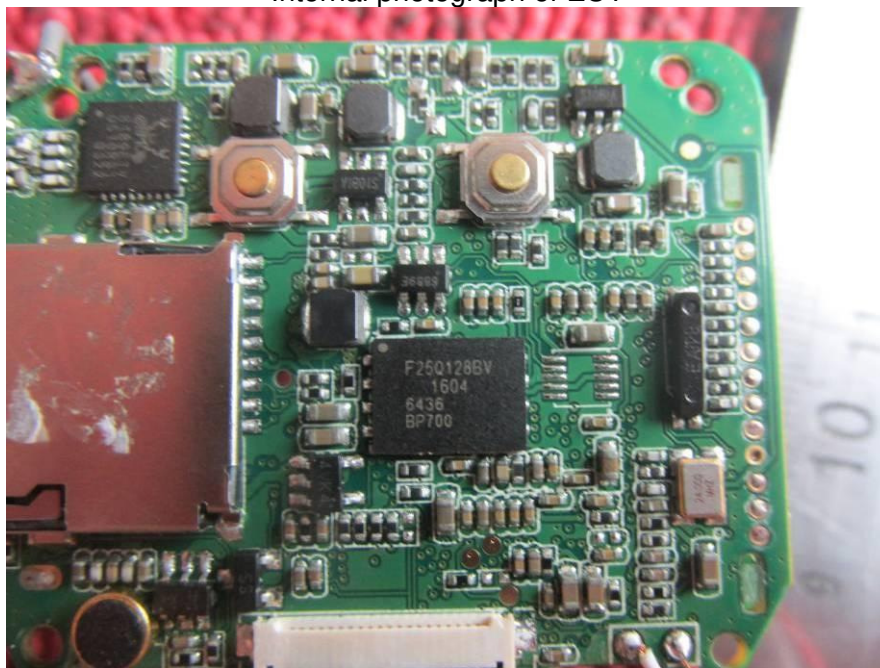

Internal photograph of EUT



Internal photograph of EUT

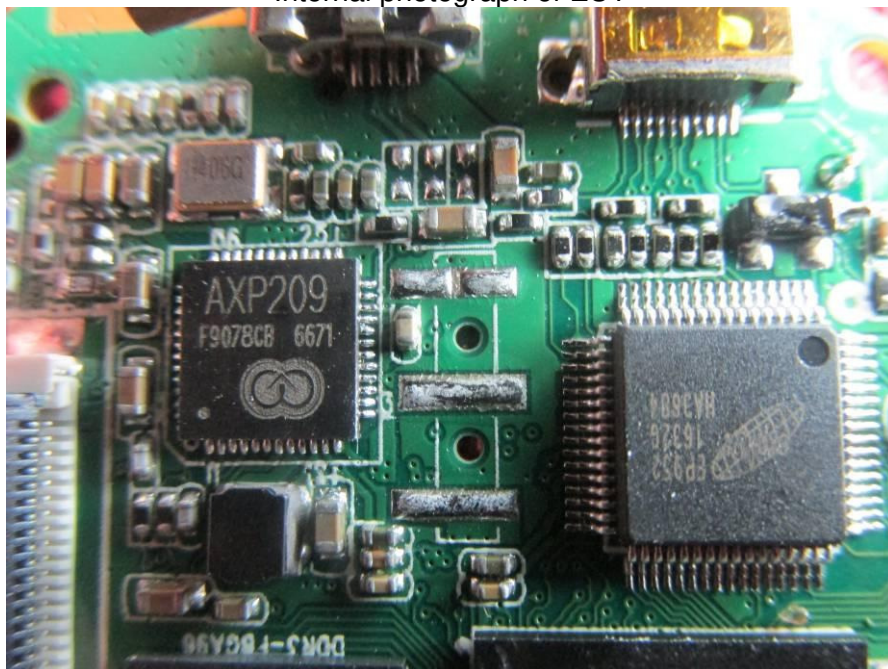

Internal photograph of EUT



---END OF REPORT---