

FCC Test Report

FCC ID:AZQPT1190

Product : Media Recorder
Trade Name : N/A
Model Number : PT1190
Serial Model : PT1188 , KR02 , DVD2802
Report No. : ISOT16110162F

Prepared for

Shenzhen KOHO Technology Co., Ltd
Building3,Jin Yuda Industrial Park , ShangLiao ,Shajin ,Baoan ,Shenzhen,
China

Prepared by

Shenzhen ISOTek Standards Technical Services Co.,Ltd.
13/F, HuaFengRui Building, XinHu Rd., XiXiang, Bao'an
District,Shenzhen,China
Tel.: +86-755- 23087278 Fax.: +86-755-23087178
[Http://www.ISOTek.com.cn](http://www.ISOTek.com.cn)

TEST RESULT CERTIFICATION

Applicant's name : Shenzhen KOHO Technology Co., Ltd
 Address : Building3,Jin Yuda Industrial Park , ShangLiao ,Shajin ,Baoan ,
 Shenzhen, China
Manufacturer's Name : Shenzhen KOHO Technology Co., Ltd
 Address : Building3,Jin Yuda Industrial Park , ShangLiao ,Shajin ,Baoan ,
 Shenzhen, China

Product description

Product name : Media Recorder
 Model and/or type reference : PT1190
 Standards : FCC Part15B:2016
 ANSI C63.4:2014

This device described above has been tested by Shenzhen ISOTek, and the test results show that the equipment under test (EUT) is in compliance with Part 15 of FCC Rules. And it is applicable only to the tested sample identified in the report.

This report shall not be reproduced except in full, without the written approval of Shenzhen ISOTek, this document may be altered or revised by Shenzhen ISOTek, personal only, and shall be noted in the revision of the document.

Date of Test :
 Date (s) of performance of tests : 04 Nov. 2016 ~24 Nov. 2016
 Date of Issue..... : 24 Nov. 2016
 Test Result..... : **Pass**

Compiled by:

Lisa Huang

 Lisa Huang/ Project Engineer

Approved by:

Richard Chen

 Richard Chen/ Manager

Table of Contents	Page
1 . TEST SUMMARY	4
1.1 TEST FACILITY	5
1.2 MEASUREMENT UNCERTAINTY	5
2 . GENERAL INFORMATION	6
2.1 GENERAL DESCRIPTION OF EUT	6
2.2 DESCRIPTION OF TEST SETUP	7
2.3 DESCRIPTION TEST PERIPHERAL AND EUT PERIPHERAL	8
2.4 MEASUREMENT INSTRUMENTS LIST	9
3 . EMC EMISSION TEST	10
3.1 CONDUCTED EMISSION MEASUREMENT	10
3.1.1 POWER LINE CONDUCTED EMISSION	10
3.1.2 TEST PROCEDURE	11
3.1.3 TEST SETUP	11
3.1.4 EUT OPERATING CONDITIONS	11
3.1.5 TEST RESULTS	12
3.2 RADIATED EMISSION MEASUREMENT	24
3.2.1 LIMITS OF RADIATED EMISSION MEASUREMENT	24
3.2.2 TEST PROCEDURE	24
3.2.3 TEST SETUP	25
3.2.4 EUT OPERATING CONDITIONS	26
3.2.5 TEST RESULTS	27
3.2.6 TEST RESULTS(1000~6000MHz)	39

1. TEST SUMMARY

Test procedures according to the technical standards:

EMC Emission				
Standard	Test Item	Limit	Judgment	Remark
FCC Part15.107	Conducted Emission	Class B	PASS	
FCC Part15.109	Radiated Emission	Class B	PASS	

1.1 TEST FACILITY

Shenzhen ISOTek Standards Technical Services Co.,Ltd.

Add.: 13/F, HuaFengRui Building, XinHu Rd., XiXiang, Bao'an District,Shenzhen,China

FCC Registration No.: 918037; IC Registration Number:20400-1

1.2 MEASUREMENT UNCERTAINTY

The reported uncertainty of measurement $y \pm U$, where expanded uncertainty U is based on a standard uncertainty multiplied by a coverage factor of $k=2$, providing a level of confidence of approximately **95** %.

A. Conducted Measurement :

Method	Measurement Frequency Range	U , (dB)	NOTE
ANSI	150 KHz ~ 30MHz	3.2	

B. Radiated Measurement :

Method	Measurement Frequency Range	U , (dB)	NOTE
ANSI	30MHz ~ 1000MHz	4.7	
	1GHz ~12.4GHz	5.0	

2. GENERAL INFORMATION

2.1 GENERAL DESCRIPTION OF EUT

Equipment	Media Recorder	
Model Name	PT1190	
Serial Model	PT1188 , KR02 , DVD2802	
Model Difference	All the names are the same circuit, except the model names.	
Product Description	Connecting I/O port:	USB, HDMI,AV IN,DC IN,
	Crystal oscillator	12MHz; 24MHz,32.768kHz, 14.31818MHz
	highest operating frequency	120MHz
	Hardware Version	HVDR_MB_PCB_V1.0
	Software Version	fiber_a31st-eng 4.4.2 KOT49H 20150302test-keys
	Serial Number	KH15000001
Power Source	DC Voltage	
Adapter	Input: AC 100V-240V, 50/60Hz, 0.6A MAX	
	Output: DC 5V, 3A	
Battery	N/A	

2.1.1 DESCRIPTION OF TEST MODES

To investigate the maximum EMI emission characteristics generates from EUT, the test system was pre-scanning tested base on the consideration of following EUT operation mode or test configuration mode which possible have effect on EMI emission level. Each of these EUT operation mode(s) or test configuration mode(s) mentioned above was evaluated respectively.

For Conducted Test	
Final Test Mode	Description
Mode 1	AV IN recording to DISC
Mode 2	USB Playing
Mode 3	DVD Playing
Mode 4	Card Playing
Mode 5	CARD recording to DISC
Mode 6	USB recording to DISC

For Radiated Test	
Final Test Mode	Description
Mode 1	Recording
Mode 2	USB Playing
Mode 3	DVD Playing
Mode 4	Card Playing
Mode 5	CARD recording to DISC
Mode 6	USB recording to DISC

2.2 DESCRIPTION OF TEST SETUP

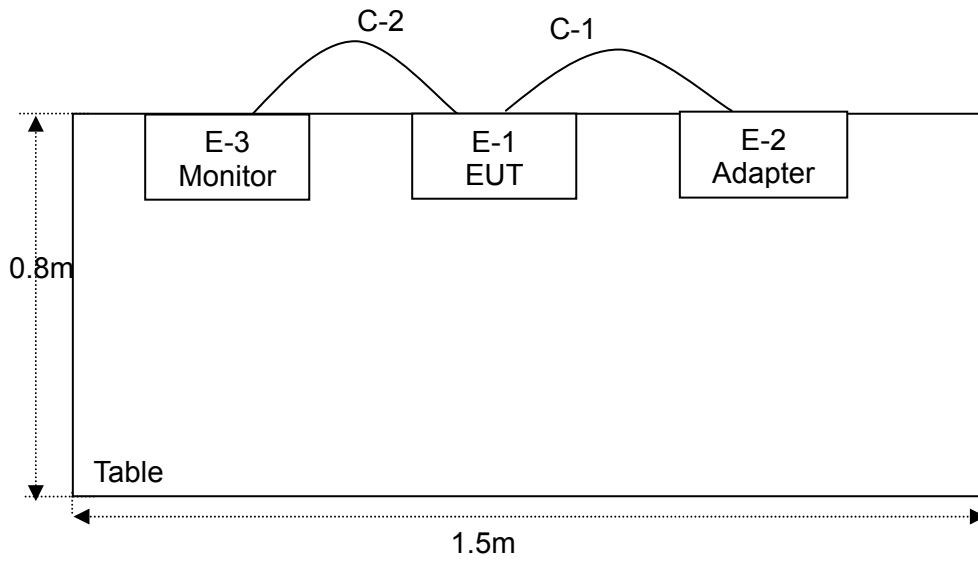

2.3 DESCRIPTION TEST PERIPHERAL AND EUT PERIPHERAL

The EUT has been tested as an independent unit together with other necessary accessories or support units. The following support units or accessories were used to form a representative test configuration during the tests.

Item	Equipment	Brand	Model/Type No.	Series No.	Note
E-1	Media Recorder	N/A	PT1190	N/A	EUT
E-2	Adapter	N/A	KH0503000UW	N/A	
E-3	Monitor	DELL	IN2020MB	cn-0y6mhx-74261	

Item	Shielded Type	Ferrite Core	Length	Note
C-1	NO	NO	1.2m	
C-2	NO	NO	1.0m	

Note:

- (1) The support equipment was authorized by Declaration of Confirmation.
- (2) For detachable type I/O cable should be specified the length in cm in 『Length』 column.
- (3) “YES” means “shielded” “with core”; “NO” means “unshielded” “without core”.

2.4 MEASUREMENT INSTRUMENTS LIST

2.4.1 CONDUCTED TEST SITE

Item	Kind of Equipment	Manufacturer	Type No.	Serial No.	Last calibration	Calibrated until	Calibration period
1	LISN	messtec	AN3019	NO.1	Jul. 06, 2016	Jul. 05, 2017	1 year
2	LISN	SCHWARZBECK	NNLK 8129	8126466	Jul. 06, 2016	Jul. 05, 2017	1 year
3	Pulse Limiter	SCHWARZBECK	VTSD9596F	9618	Jul. 06, 2016	Jul. 05, 2017	1 year
4	Coaxial Switch	Schwarzbeck	CX - 210	6200983704	Jul. 06, 2016	Jul. 05, 2017	1 year
5	Test Cable	ATM	C01	8926	Jul. 06, 2016	Jul. 05, 2017	1 year
6	Test Cable	ATM	C02	8924	Jul. 06, 2016	Jul. 05, 2017	1 year
7	Test Cable	ATM	C03	8931	Jul. 06, 2016	Jul. 05, 2017	1 year
8	EMI Test Receiver	R&S	ESCI	100843	Jul. 06, 2016	Jul. 05, 2017	1 year
9	Passive Voltage Probe	ESH2-Z3	R&S	100196	Jul. 06, 2016	Jul. 05, 2017	1 year
10	Absorbing Clamp	R&S	MDS-21	100423	Jul. 06, 2016	Jul. 05, 2017	1 year

2.4.2 RADIATED TEST SITE

Item	Kind of Equipment	Manufacturer	Type No.	Serial No.	Last calibration	Calibrated until	Calibration period
1	Bilog Antenna	Schwarzbeck	VULB 9168	VULB9168 - 438	Jul. 06, 2016	Jul. 05, 2017	1 year
2	Test Cable	ATM	R-01	8933	Jul. 06, 2016	Jul. 05, 2017	1 year
3	Test Cable	ATM	R-02	8935	Jul. 06, 2016	Jul. 05, 2017	1 year
4	EMI Test Receiver	R&S	ESCI	101165	Jul. 06, 2016	Jul. 05, 2017	1 year
5	Antenna Mast	EM	SC100_1	N/A	N/A	N/A	N/A
6	Turn Table	EM	SC100	060531	N/A	N/A	N/A
7	50Ω Switch	Anritsu Corp	MP59B	6200983705	Jul. 06, 2016	Jul. 05, 2017	1 year
8	Spectrum Analyzer	Aglient	E4446A	US44300451	Jul. 06, 2016	Jul. 05, 2017	1 year
9	Horn Antenna	EMCO	EM-AH-10180	2011071402	Jul. 06, 2016	Jul. 05, 2017	1 year
10	Amplifier	Schwarzbeck	BBV9743	9743 - 019	Jul. 06, 2016	Jul. 05, 2017	1 year

3. EMC EMISSION TEST

3.1 CONDUCTED EMISSION MEASUREMENT

3.1.1 POWER LINE CONDUCTED EMISSION (Frequency Range 150KHz-30MHz)

FREQUENCY (MHz)	Class A (dBuV)		Class B (dBuV)	
	Quasi-peak	Average	Quasi-peak	Average
0.15 -0.5	79.00	66.00	66 - 56 *	56 - 46 *
0.50 -5.0	73.00	60.00	56.00	46.00
5.0 -30.0	73.00	60.00	60.00	50.00

Note:

- (1) The tighter limit applies at the band edges.
- (2) The limit of " * " marked band means the limitation decreases linearly with the logarithm of the frequency in the range.

The following table is the setting of the receiver

Receiver Parameters	Setting
Attenuation	10 dB
Start Frequency	0.15 MHz
Stop Frequency	30 MHz
IF Bandwidth	9 kHz

3.1.2 TEST PROCEDURE

- a. The EUT was placed 0.8 meters from the horizontal ground plane with EUT being connected to the power mains through a line impedance stabilization network (LISN). All other support equipments powered from additional LISN(s). The LISN provide 50 Ohm/ 50uH of coupling impedance for the measuring instrument.
- b. Interconnecting cables that hang closer than 40 cm to the ground plane shall be folded back and forth in the center forming a bundle 30 to 40 cm long.
- c. I/O cables that are not connected to a peripheral shall be bundled in the center. The end of the cable may be terminated, if required, using the correct terminating impedance. The overall length shall not exceed 1 m.
- d. LISN at least 80 cm from nearest part of EUT chassis.
- e. For the actual test configuration, please refer to the related Item –EUT Test Photos.

3.1.3 TEST SETUP

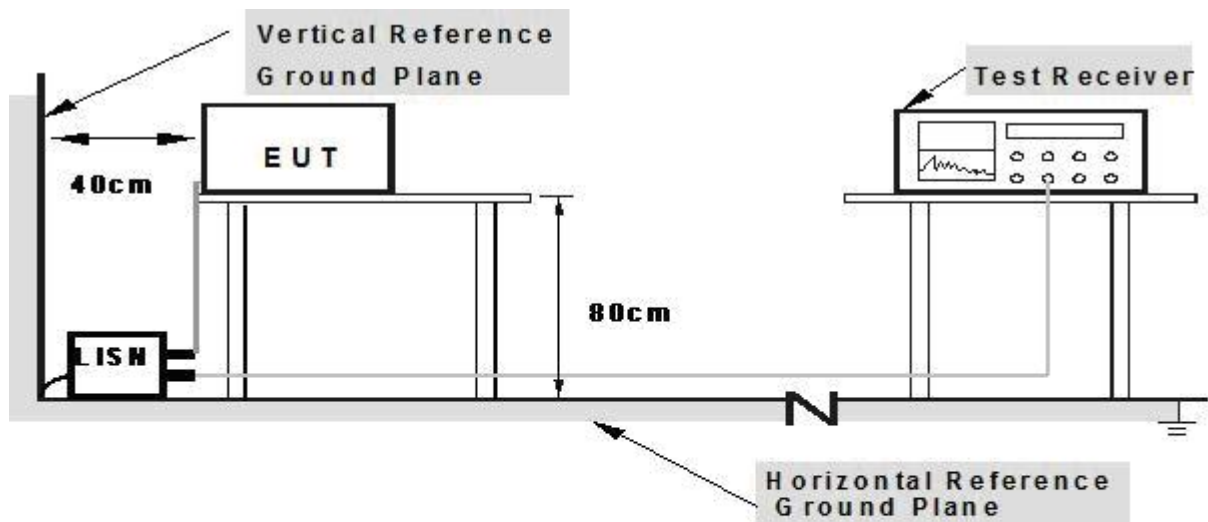

Note: 1. Support units were connected to second LISN.

2. Both of LISNs (AMH) are 80 cm from EUT and at least 80 cm from other units and other metal planes

3.1.4 EUT OPERATING CONDITIONS

The EUT tested system was configured as the statements of 2.3 Unless otherwise a special operating condition is specified in the follows during the testing.

3.1.5 TEST RESULTS

EUT :	Media Recorder	Model Name. :	PT1190
Temperature :	26 °C	Relative HuMedia Recorderity :	54%
Pressure :	1010hPa	Test Date :	2016-11-17
Test Mode :	Mode 1	Phase :	L
Test Voltage :	AC 120V/60Hz		

Freq. (MHz)	Reading (dBμV)	Factor (dB)	Measurement (dBμV)	Limit (dBμV)	Over (dB)	Detector
0.1900	47.34	9.50	56.84	64.03	-7.19	QP
0.1900	25.15	9.50	34.65	54.03	-19.38	AVG
0.8540	23.64	9.45	33.09	56.00	-22.91	QP
0.8540	13.63	9.45	23.08	46.00	-22.92	AVG
4.7220	23.98	9.44	33.42	56.00	-22.58	QP
4.7220	11.74	9.44	21.18	46.00	-24.82	AVG
13.2620	25.63	9.68	35.31	60.00	-24.69	QP
13.2620	15.31	9.68	24.99	50.00	-25.01	AVG
21.6180	32.34	9.81	42.15	60.00	-17.85	QP
21.6180	18.46	9.81	28.27	50.00	-21.73	AVG
27.3540	41.16	9.91	51.07	60.00	-8.93	QP
27.3540	24.01	9.91	33.92	50.00	-16.08	AVG

Remark:

Factor = Insertion Loss + Cable Loss.

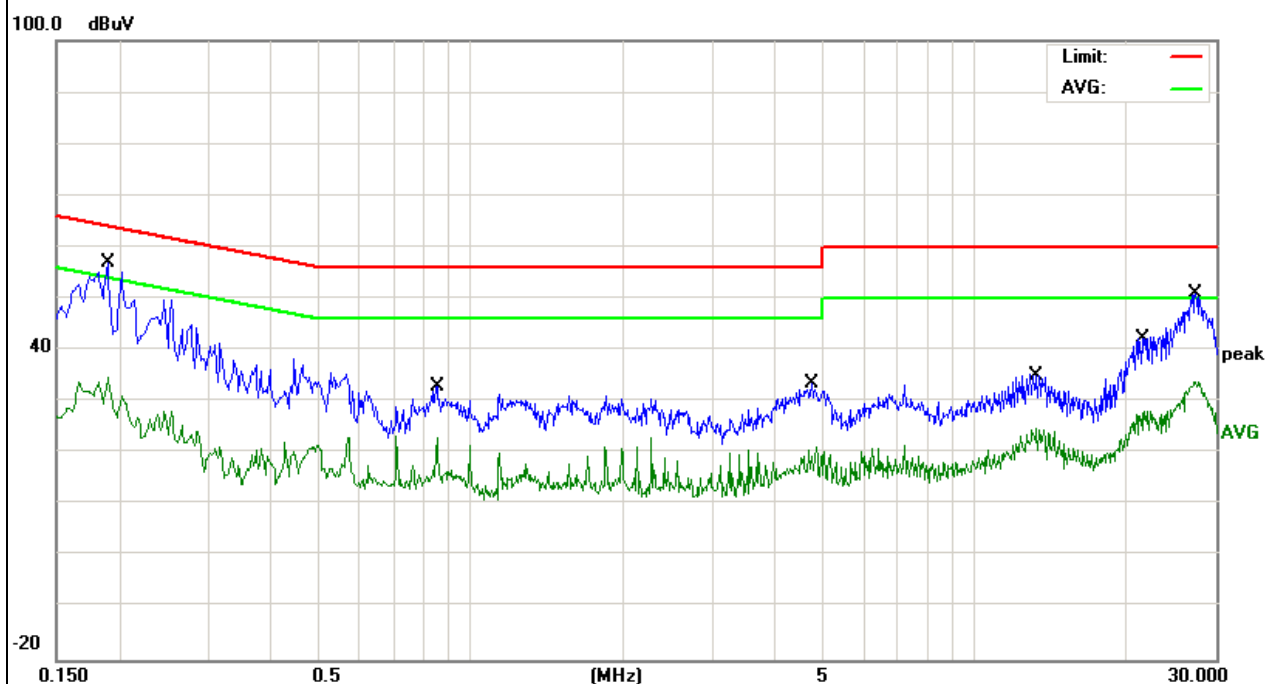

EUT :	Media Recorder	Model Name. :	PT1190
Temperature :	26 °C	Relative Humidity :	54%
Pressure :	1010hPa	Test Date :	2016-11-17
Test Mode :	Mode 1	Phase :	N
Test Voltage :	AC 120V/60Hz		

Freq. (MHz)	Reading (dB μ V)	Factor (dB)	Measurement (dB μ V)	Limit (dB μ V)	Over (dB)	Detector
0.1620	47.68	9.60	57.28	65.36	-8.08	QP
0.1620	25.13	9.60	34.73	55.36	-20.63	AVG
0.2580	40.07	9.46	49.53	61.49	-11.96	QP
0.2580	20.02	9.46	29.48	51.49	-22.01	AVG
0.8540	23.08	9.45	32.53	56.00	-23.47	QP
0.8540	14.66	9.45	24.11	46.00	-21.89	AVG
4.5180	22.86	9.44	32.30	56.00	-23.70	QP
4.5180	10.14	9.44	19.58	46.00	-26.42	AVG
12.8100	27.46	9.67	37.13	60.00	-22.87	QP
12.8100	15.51	9.67	25.18	50.00	-24.82	AVG
27.5500	40.39	9.91	50.30	60.00	-9.70	QP
27.5500	24.06	9.91	33.97	50.00	-16.03	AVG

Remark:

Factor = Insertion Loss + Cable Loss.

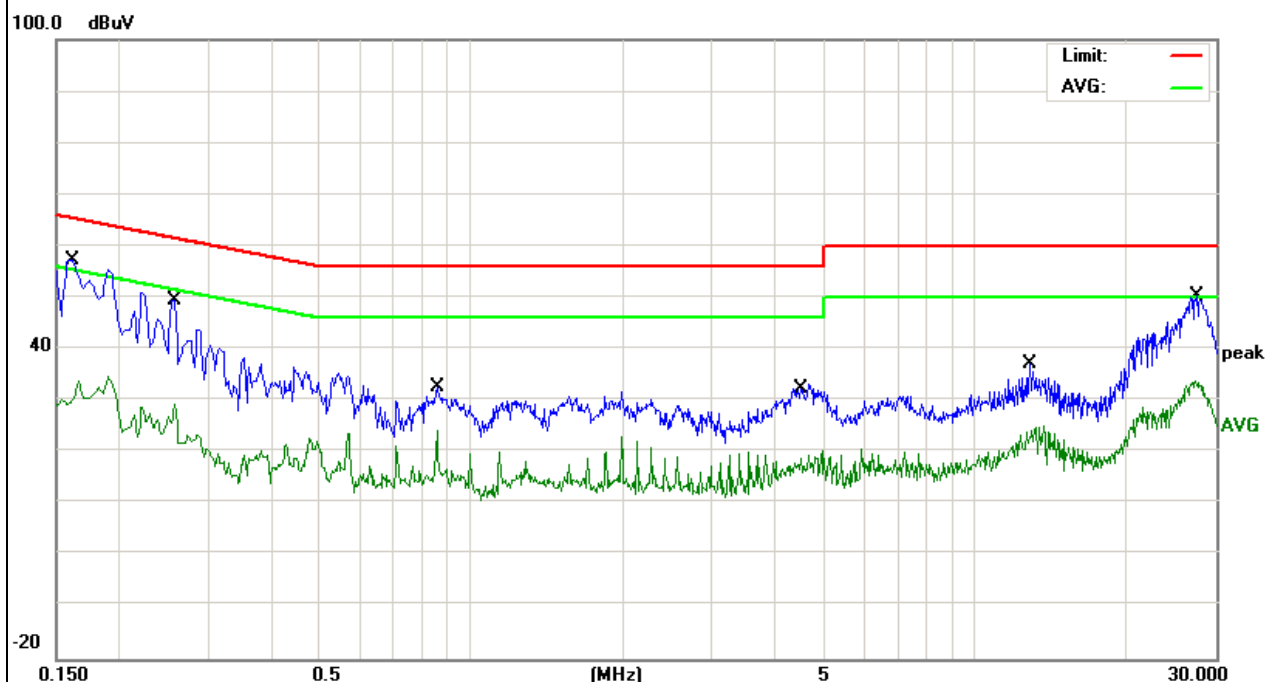

EUT :	Media Recorder	Model Name. :	PT1190
Temperature :	26 °C	Relative Humidity :	54%
Pressure :	1010hPa	Test Date :	2016-11-17
Test Mode :	Mode 2	Phase :	L
Test Voltage :	AC 120V/60Hz		

Freq. (MHz)	Reading (dBμV)	Factor (dB)	Measurement (dBμV)	Limit (dBμV)	Over (dB)	Detector
0.1900	46.08	9.50	55.58	64.03	-8.45	QP
0.1900	25.58	9.50	35.08	54.03	-18.95	AVG
0.2700	38.79	9.46	48.25	61.12	-12.87	QP
0.2700	16.67	9.46	26.13	51.12	-24.99	AVG
1.2900	21.19	9.46	30.65	56.00	-25.35	QP
1.2900	12.87	9.46	22.33	46.00	-23.67	AVG
4.9739	26.29	9.44	35.73	56.00	-20.27	QP
4.9739	15.21	9.44	24.65	46.00	-21.35	AVG
7.2619	27.97	9.47	37.44	60.00	-22.56	QP
7.2619	19.03	9.47	28.50	50.00	-21.50	AVG
27.5500	40.13	9.91	50.04	60.00	-9.96	QP
27.5500	23.06	9.91	32.97	50.00	-17.03	AVG

Remark:

Factor = Insertion Loss + Cable Loss.

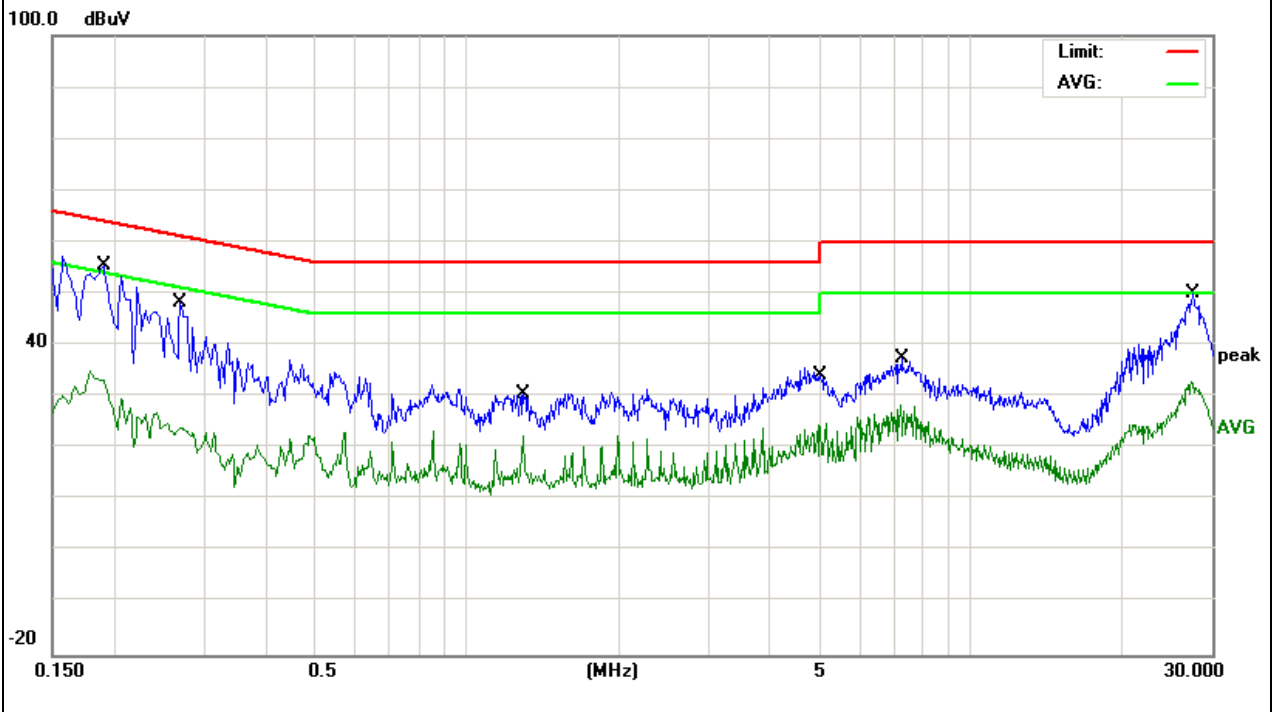

EUT :	Media Recorder	Model Name. :	PT1190
Temperature :	26 °C	Relative Humidity :	54%
Pressure :	1010hPa	Test Date :	2016-11-17
Test Mode :	Mode 2	Phase :	N
Test Voltage :	AC 120V/60Hz		

Freq. (MHz)	Reading (dB μ V)	Factor (dB)	Measurement (dB μ V)	Limit (dB μ V)	Over (dB)	Detector
0.1721	46.85	9.57	56.42	64.96	-8.54	QP
0.1832	26.36	9.53	35.89	54.39	-18.50	AVG
0.5722	36.38	9.46	45.84	56.00	-10.16	QP
0.5722	28.73	9.46	38.19	46.00	-7.81	AVG
0.8533	29.18	9.45	38.63	56.00	-17.37	QP
0.8538	27.97	9.45	37.42	46.00	-8.58	AVG
4.8335	9.88	9.44	19.32	46.00	-26.68	QP
4.9339	22.28	9.44	31.72	56.00	-24.28	AVG
10.3617	21.99	9.63	31.62	60.00	-28.38	QP
11.2417	8.83	9.64	18.47	50.00	-31.53	AVG
28.1980	33.82	9.92	43.74	60.00	-16.26	QP
28.3660	17.47	9.92	27.39	50.00	-22.61	AVG

Remark:

Factor = Insertion Loss + Cable Loss.

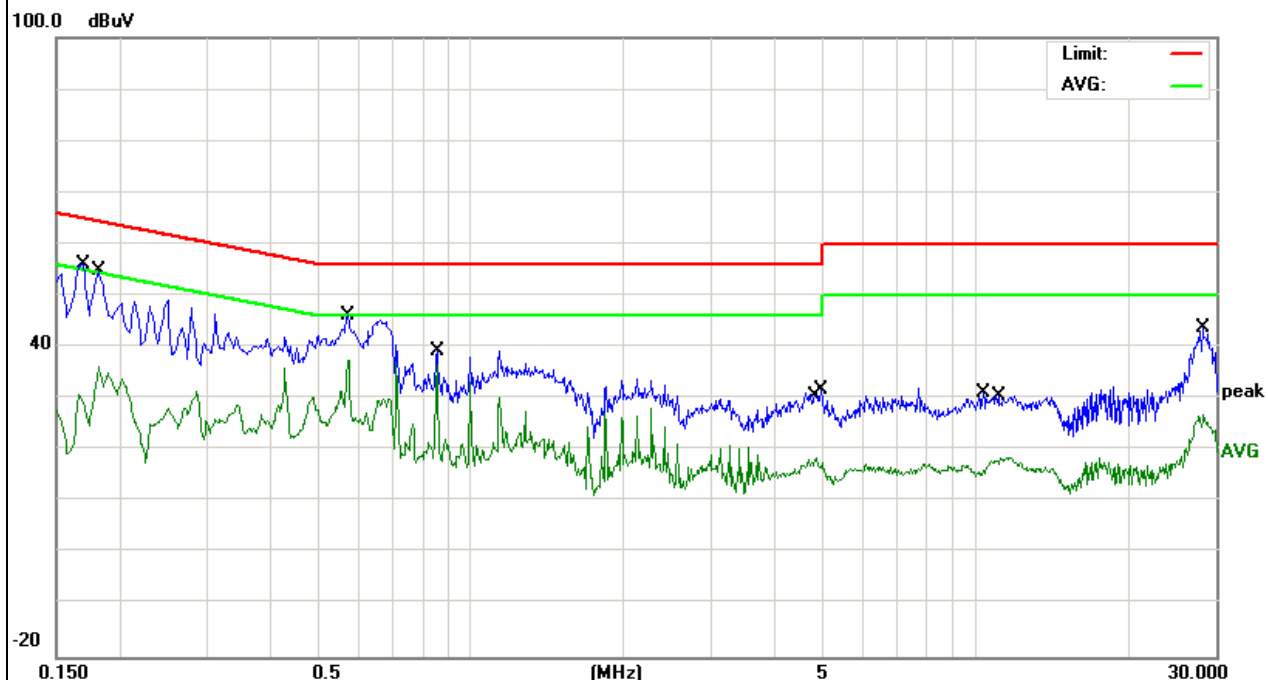

EUT :	Media Recorder	Model Name. :	PT1190
Temperature :	26 °C	Relative Humidity :	54%
Pressure :	1010hPa	Test Date :	2016-11-17
Test Mode :	Mode 3	Phase :	L
Test Voltage :	AC 120V/60Hz		

Freq. (MHz)	Reading (dBμV)	Factor (dB)	Measurement (dBμV)	Limit (dBμV)	Over (dB)	Detector
0.1700	48.92	9.57	58.49	64.96	-6.47	QP
0.1700	20.80	9.57	30.37	54.96	-24.59	AVG
0.5699	34.33	9.46	43.79	56.00	-12.21	QP
0.5699	30.91	9.46	40.37	46.00	-5.63	AVG
0.8539	32.43	9.45	41.88	56.00	-14.12	QP
0.8539	28.48	9.45	37.93	46.00	-8.07	AVG
1.9899	28.61	9.46	38.07	56.00	-17.93	QP
1.9899	24.32	9.46	33.78	46.00	-12.22	AVG
4.8338	25.70	9.44	35.14	56.00	-20.86	QP
4.8338	17.79	9.44	27.23	46.00	-18.77	AVG
27.8339	39.32	9.91	49.23	60.00	-10.77	QP
27.8339	23.49	9.91	33.40	50.00	-16.60	AVG

Remark:

Factor = Insertion Loss + Cable Loss.

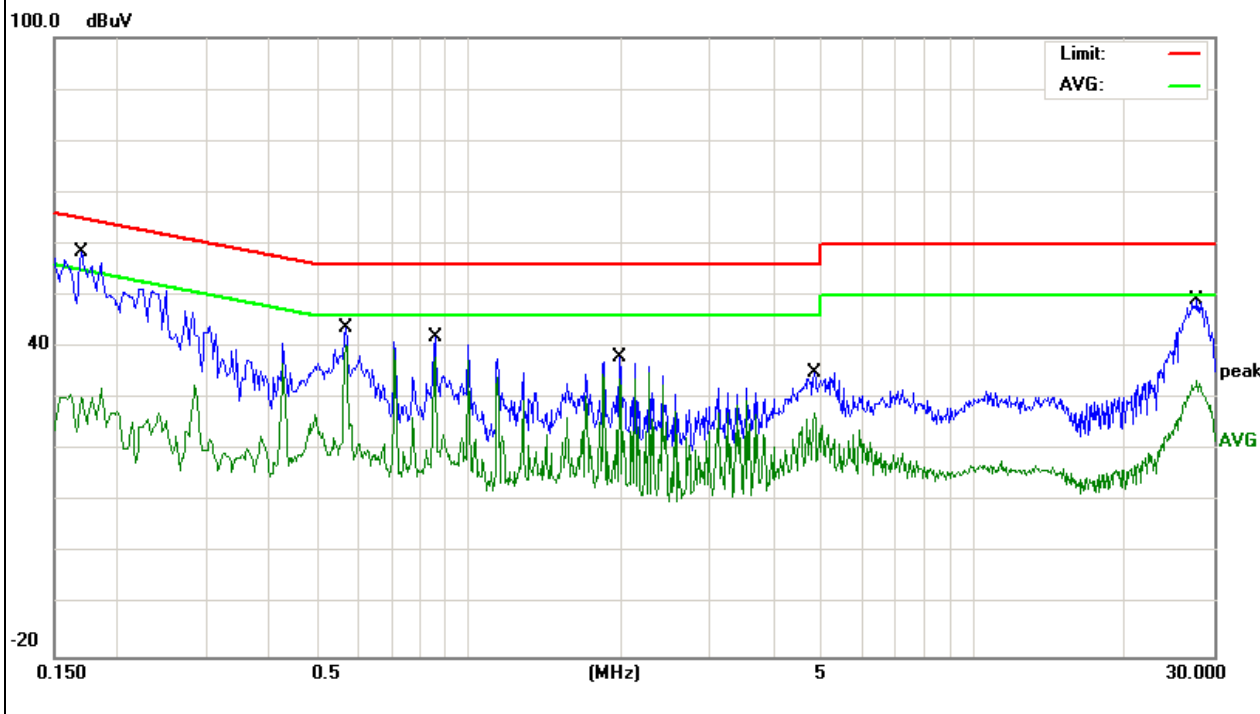

EUT :	Media Recorder	Model Name. :	PT1190
Temperature :	26 °C	Relative Humidity :	54%
Pressure :	1010hPa	Test Date :	2016-11-17
Test Mode :	Mode 3	Phase :	N
Test Voltage :	AC 120V/60Hz		

Freq. (MHz)	Reading (dBμV)	Factor (dB)	Measurement (dBμV)	Limit (dBμV)	Over (dB)	Detector
0.1620	21.67	9.60	31.27	55.36	-24.09	QP
0.1700	49.42	9.57	58.99	64.96	-5.97	AVG
0.5700	31.83	9.46	41.29	56.00	-14.71	QP
0.5700	28.41	9.46	37.87	46.00	-8.13	AVG
0.8540	31.92	9.46	41.38	56.00	-14.62	QP
0.8540	27.97	9.46	37.43	46.00	-8.57	AVG
1.9900	25.61	9.46	35.07	56.00	-20.93	QP
1.9900	21.32	9.46	30.78	46.00	-15.22	AVG
7.6420	21.64	9.50	31.14	60.00	-28.86	QP
7.7100	8.53	9.50	18.03	50.00	-31.97	AVG
27.8340	37.82	9.91	47.73	60.00	-12.27	QP
27.8340	21.99	9.91	31.90	50.00	-18.10	AVG

Remark:

Factor = Insertion Loss + Cable Loss.

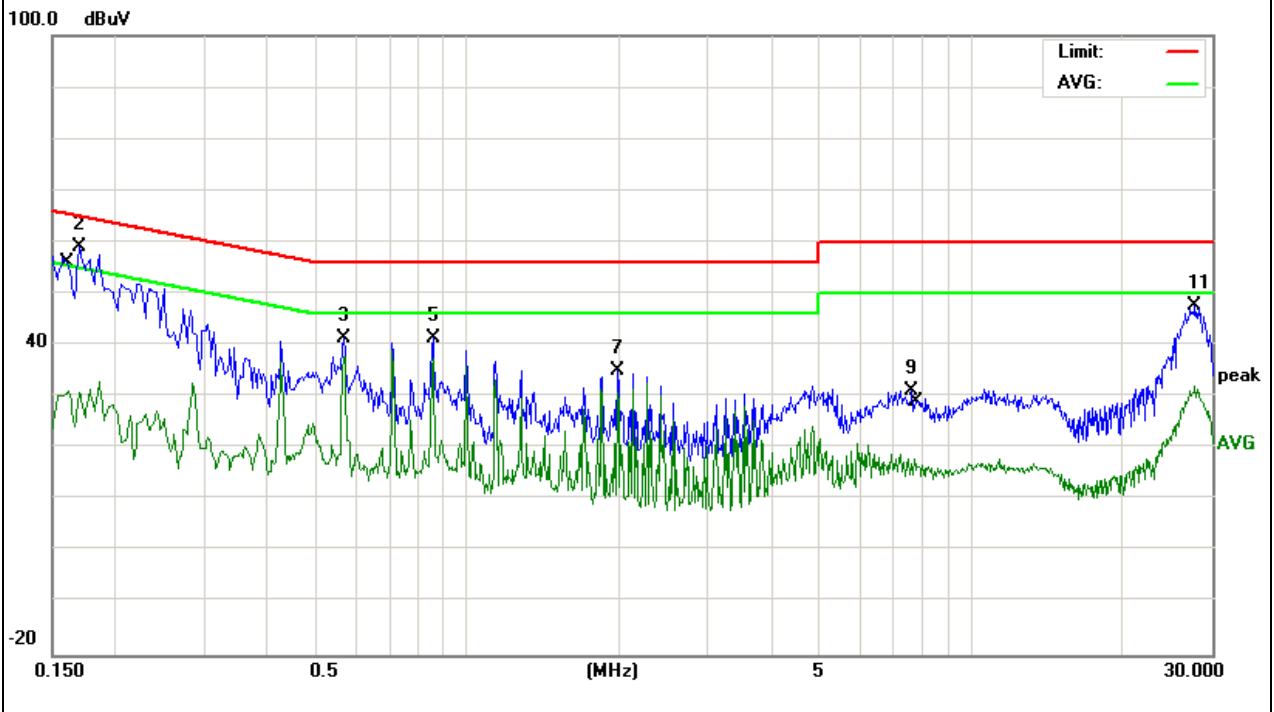

EUT :	Media Recorder	Model Name. :	PT1190
Temperature :	26 °C	Relative Humidity :	54%
Pressure :	1010hPa	Test Date :	2016-11-17
Test Mode :	Mode 4	Phase :	L
Test Voltage :	AC 120V/60Hz		

Freq. (MHz)	Reading (dBμV)	Factor (dB)	Measurement (dBμV)	Limit (dBμV)	Over (dB)	Detector
0.1900	46.21	9.50	55.71	64.03	-8.32	QP
0.1900	24.67	9.50	34.17	54.03	-19.86	AVG
0.8540	23.68	9.45	33.13	56.00	-22.87	QP
0.8540	13.38	9.45	22.83	46.00	-23.17	AVG
1.9900	21.74	9.46	31.20	56.00	-24.80	QP
1.9900	13.26	9.46	22.72	46.00	-23.28	AVG
4.7179	23.47	9.44	32.91	56.00	-23.09	QP
4.7179	11.38	9.44	20.82	46.00	-25.18	AVG
13.6259	26.13	9.69	35.82	60.00	-24.18	QP
13.6259	15.52	9.69	25.21	50.00	-24.79	AVG
27.7060	40.46	9.91	50.37	60.00	-9.63	QP
27.7060	24.06	9.91	33.97	50.00	-16.03	AVG

Remark:

Factor = Insertion Loss + Cable Loss.

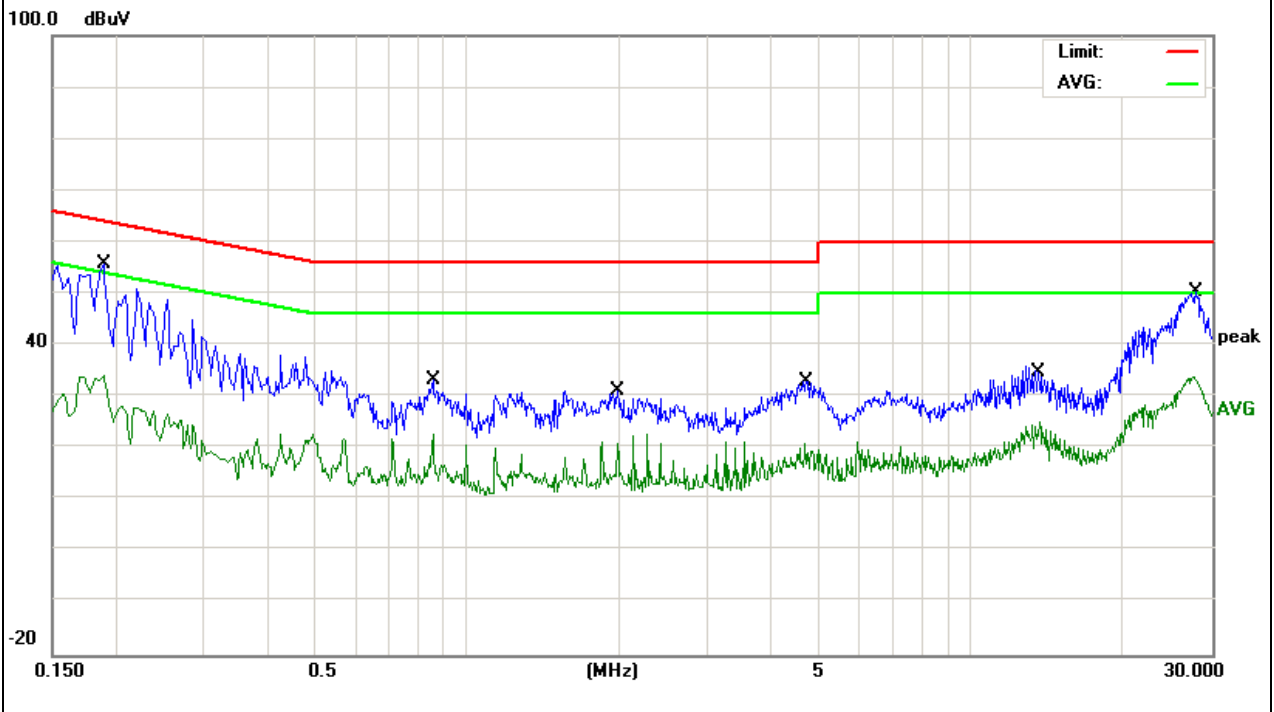

EUT :	Media Recorder	Model Name. :	PT1190
Temperature :	26 °C	Relative Humidity :	54%
Pressure :	1010hPa	Test Date :	2016-11-17
Test Mode :	Mode 4	Phase :	N
Test Voltage :	AC 120V/60Hz		

Freq. (MHz)	Reading (dBμV)	Factor (dB)	Measurement (dBμV)	Limit (dBμV)	Over (dB)	Detector
0.1860	47.11	9.52	56.63	64.21	-7.58	QP
0.1860	24.31	9.52	33.83	54.21	-20.38	AVG
0.8540	23.22	9.45	32.67	56.00	-23.33	QP
0.8540	12.97	9.45	22.42	46.00	-23.58	AVG
1.9900	21.89	9.46	31.35	56.00	-24.65	QP
1.9900	12.63	9.46	22.09	46.00	-23.91	AVG
4.7259	24.33	9.44	33.77	56.00	-22.23	QP
4.7259	10.87	9.44	20.31	46.00	-25.69	AVG
13.1899	26.19	9.68	35.87	60.00	-24.13	QP
13.1899	15.23	9.68	24.91	50.00	-25.09	AVG
27.7340	41.04	9.91	50.95	60.00	-9.05	QP
27.7340	24.03	9.91	33.94	50.00	-16.06	AVG

Remark:

Factor = Insertion Loss + Cable Loss.

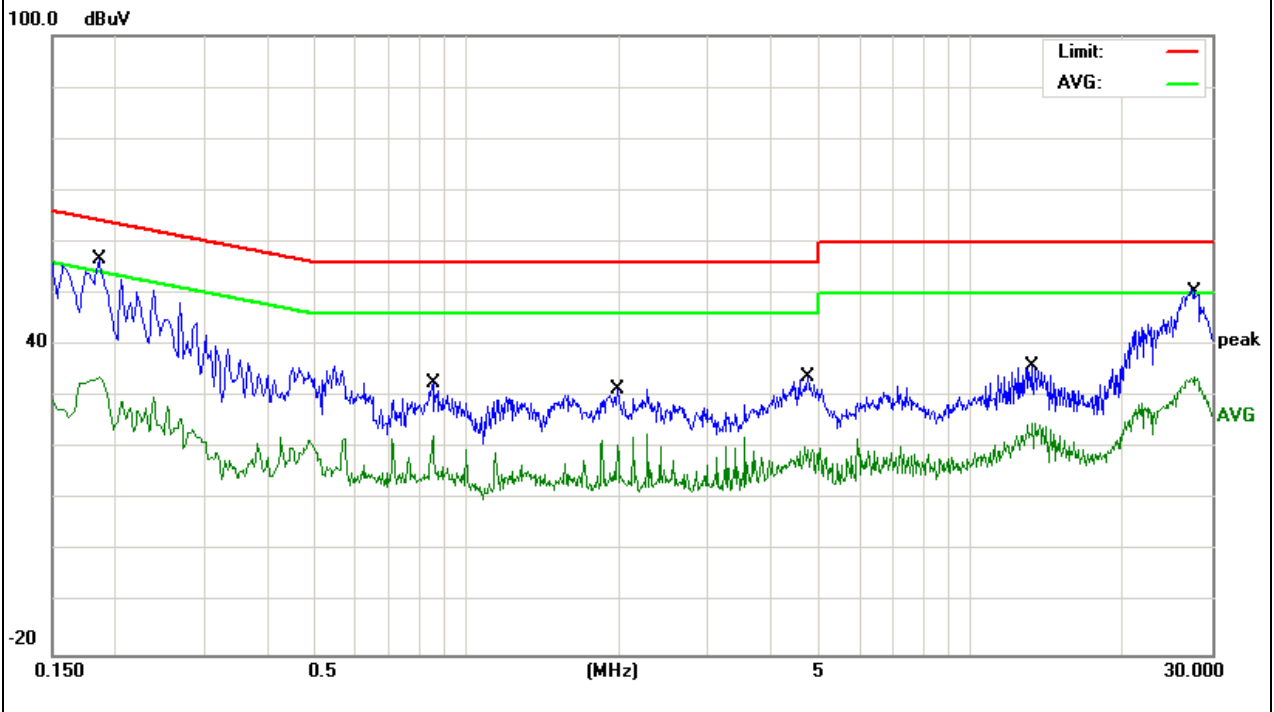

EUT :	Media Recorder	Model Name. :	PT1190
Temperature :	26 °C	Relative Humidity :	54%
Pressure :	1010hPa	Test Date :	2016-11-17
Test Mode :	Mode 5	Phase :	L
Test Voltage :	AC 120V/60Hz		

Freq. (MHz)	Reading (dBμV)	Factor (dB)	Measurement (dBμV)	Limit (dBμV)	Over (dB)	Detector
0.1900	46.08	9.50	55.58	64.03	-8.45	QP
0.1900	25.58	9.50	35.08	54.03	-18.95	AVG
0.2700	38.79	9.46	48.25	61.12	-12.87	QP
0.2700	16.67	9.46	26.13	51.12	-24.99	AVG
1.2900	21.19	9.46	30.65	56.00	-25.35	QP
1.2900	12.87	9.46	22.33	46.00	-23.67	AVG
4.9739	26.29	9.44	35.73	56.00	-20.27	QP
4.9739	15.21	9.44	24.65	46.00	-21.35	AVG
7.2619	27.97	9.47	37.44	60.00	-22.56	QP
7.2619	19.03	9.47	28.50	50.00	-21.50	AVG
27.5500	40.13	9.91	50.04	60.00	-9.96	QP
27.5500	23.06	9.91	32.97	50.00	-17.03	AVG

Remark:

Factor = Insertion Loss + Cable Loss.

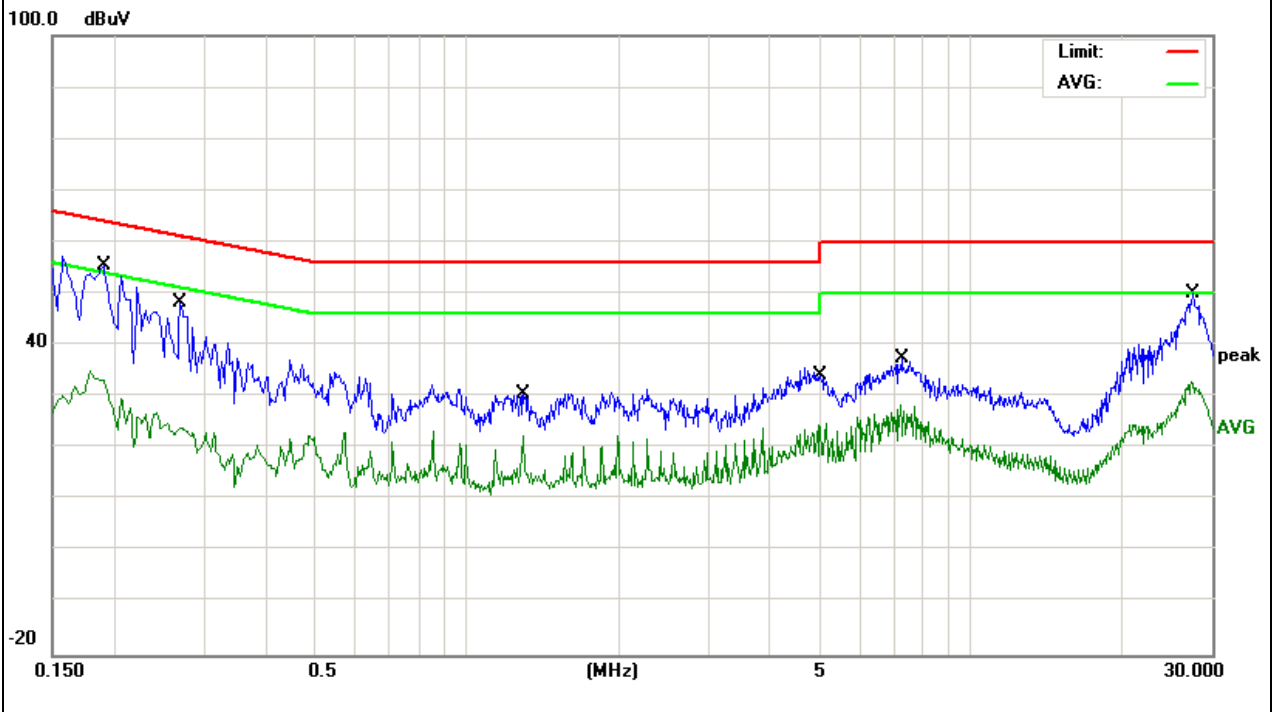

EUT :	Media Recorder	Model Name. :	PT1190
Temperature :	26 °C	Relative Humidity :	54%
Pressure :	1010hPa	Test Date :	2016-11-17
Test Mode :	Mode 5	Phase :	N
Test Voltage :	AC 120V/60Hz		

Freq. (MHz)	Reading (dBμV)	Factor (dB)	Measurement (dBμV)	Limit (dBμV)	Over (dB)	Detector
0.1620	47.54	9.60	57.14	65.36	-8.22	QP
0.1620	22.71	9.60	32.31	55.36	-23.05	AVG
0.8540	23.44	9.45	32.89	56.00	-23.11	QP
0.8540	12.95	9.45	22.40	46.00	-23.60	AVG
2.2740	23.71	9.45	33.16	56.00	-22.84	QP
2.2740	14.19	9.45	23.64	46.00	-22.36	AVG
4.6898	25.43	9.44	34.87	56.00	-21.13	QP
4.6898	15.07	9.44	24.51	46.00	-21.49	AVG
7.4699	28.83	9.48	38.31	60.00	-21.69	QP
7.4699	18.72	9.48	28.20	50.00	-21.80	AVG
27.5340	39.01	9.91	48.92	60.00	-11.08	QP
27.5340	22.92	9.91	32.83	50.00	-17.17	AVG

Remark:

Factor = Insertion Loss + Cable Loss.

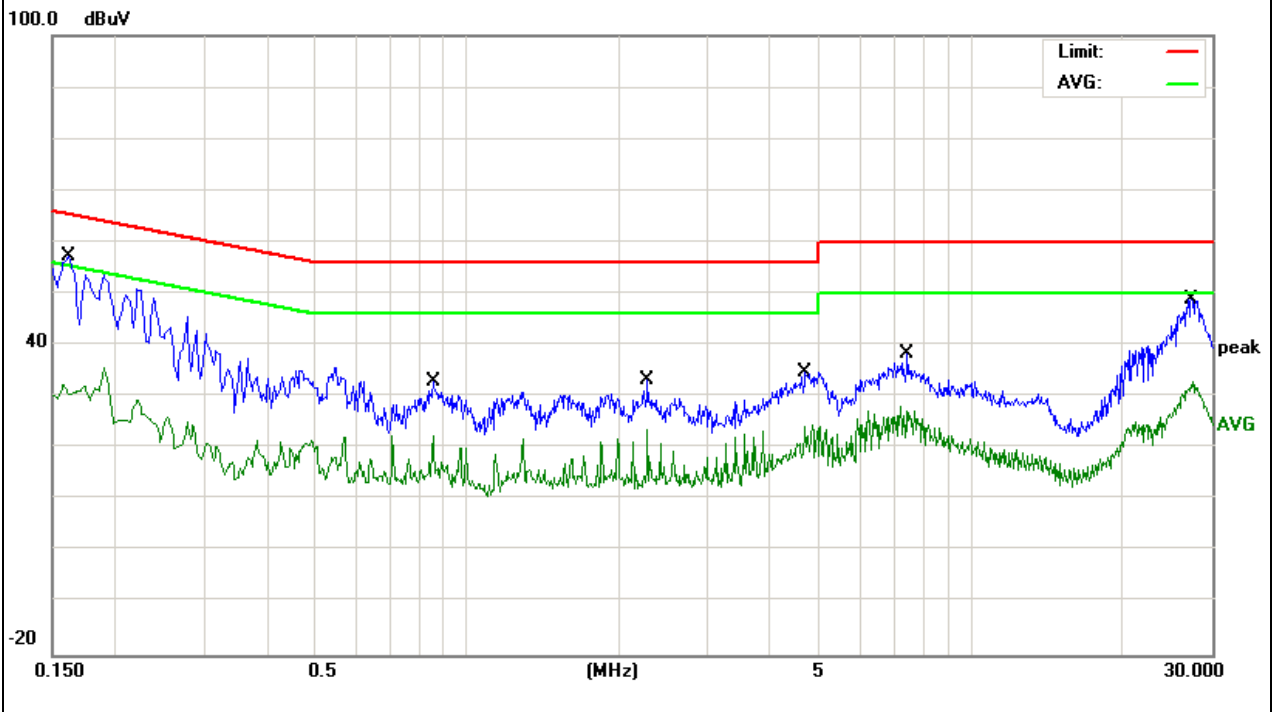

EUT :	Media Recorder	Model Name. :	PT1190
Temperature :	26 °C	Relative Humidity :	54%
Pressure :	1010hPa	Test Date :	2016-11-17
Test Mode :	Mode 6	Phase :	L
Test Voltage :	AC 120V/60Hz		

Freq. (MHz)	Reading (dBμV)	Factor (dB)	Measurement (dBμV)	Limit (dBμV)	Over (dB)	Detector
0.1859	46.97	9.52	56.49	64.21	-7.72	QP
0.1859	27.54	9.52	37.06	54.21	-17.15	AVG
0.5699	27.45	9.46	36.91	56.00	-19.09	QP
0.5699	13.30	9.46	22.76	46.00	-23.24	AVG
1.5660	21.18	9.46	30.64	56.00	-25.36	QP
1.5660	7.65	9.46	17.11	46.00	-28.89	AVG
4.6578	23.79	9.44	33.23	56.00	-22.77	QP
4.6578	12.32	9.44	21.76	46.00	-24.24	AVG
12.8058	26.37	9.67	36.04	60.00	-23.96	QP
12.8059	15.35	9.67	25.02	50.00	-24.98	AVG
26.9579	40.75	9.90	50.65	60.00	-9.35	QP
26.9579	23.69	9.90	33.59	50.00	-16.41	AVG

Remark:

Factor = Insertion Loss + Cable Loss.

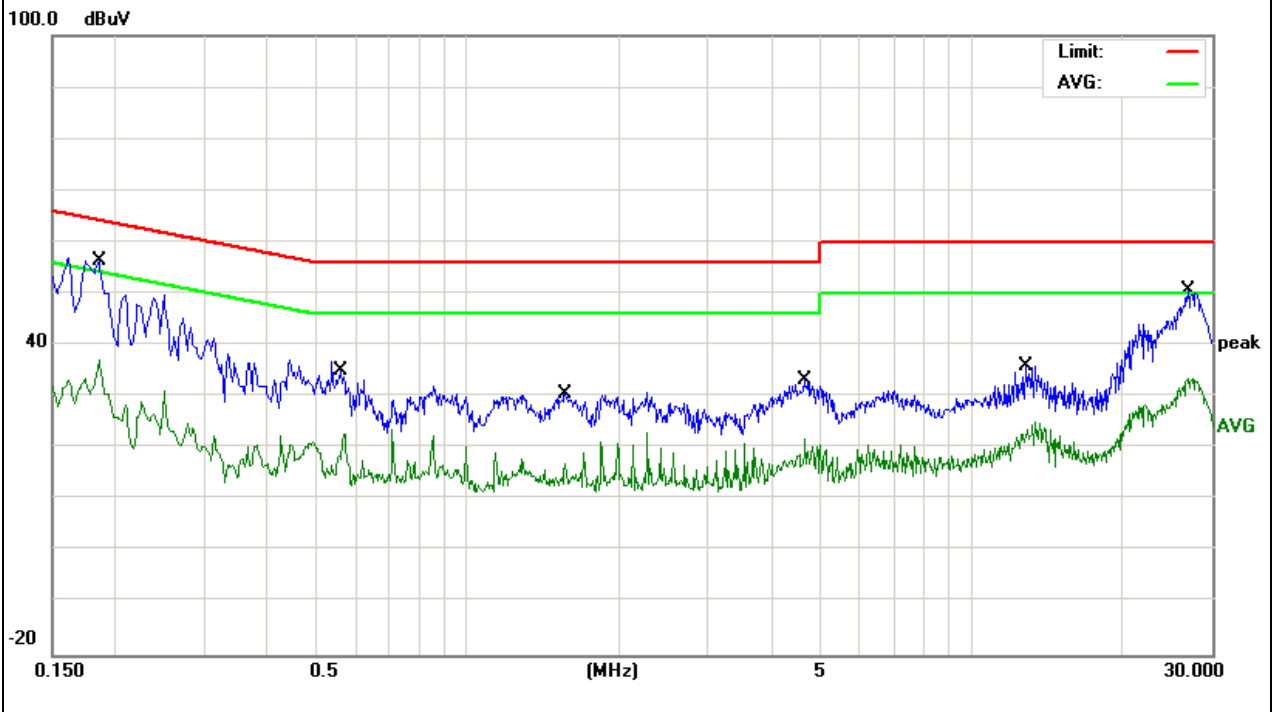

EUT :	Media Recorder	Model Name. :	PT1190
Temperature :	26 °C	Relative Humidity :	54%
Pressure :	1010hPa	Test Date :	2016-11-17
Test Mode :	Mode 6	Phase :	N
Test Voltage :	AC 120V/60Hz		

Freq. (MHz)	Reading (dB μ V)	Factor (dB)	Measurement (dB μ V)	Limit (dB μ V)	Over (dB)	Detector
0.1796	46.67	9.54	56.21	64.50	-8.29	QP
0.1796	24.48	9.54	34.02	54.50	-20.48	AVG
0.8540	23.47	9.45	32.92	56.00	-23.08	QP
0.8540	14.40	9.45	23.85	46.00	-22.15	AVG
1.8460	22.37	9.46	31.83	56.00	-24.17	QP
1.8460	11.88	9.46	21.34	46.00	-24.66	AVG
4.4059	23.76	9.44	33.20	56.00	-22.80	QP
4.4059	10.45	9.44	19.89	46.00	-26.11	AVG
12.9619	26.61	9.68	36.29	60.00	-23.71	QP
12.9619	14.62	9.68	24.30	50.00	-25.70	AVG
27.3340	40.90	9.91	50.81	60.00	-9.19	QP
27.3340	24.08	9.91	33.99	50.00	-16.01	AVG

Remark:

Factor = Insertion Loss + Cable Loss.

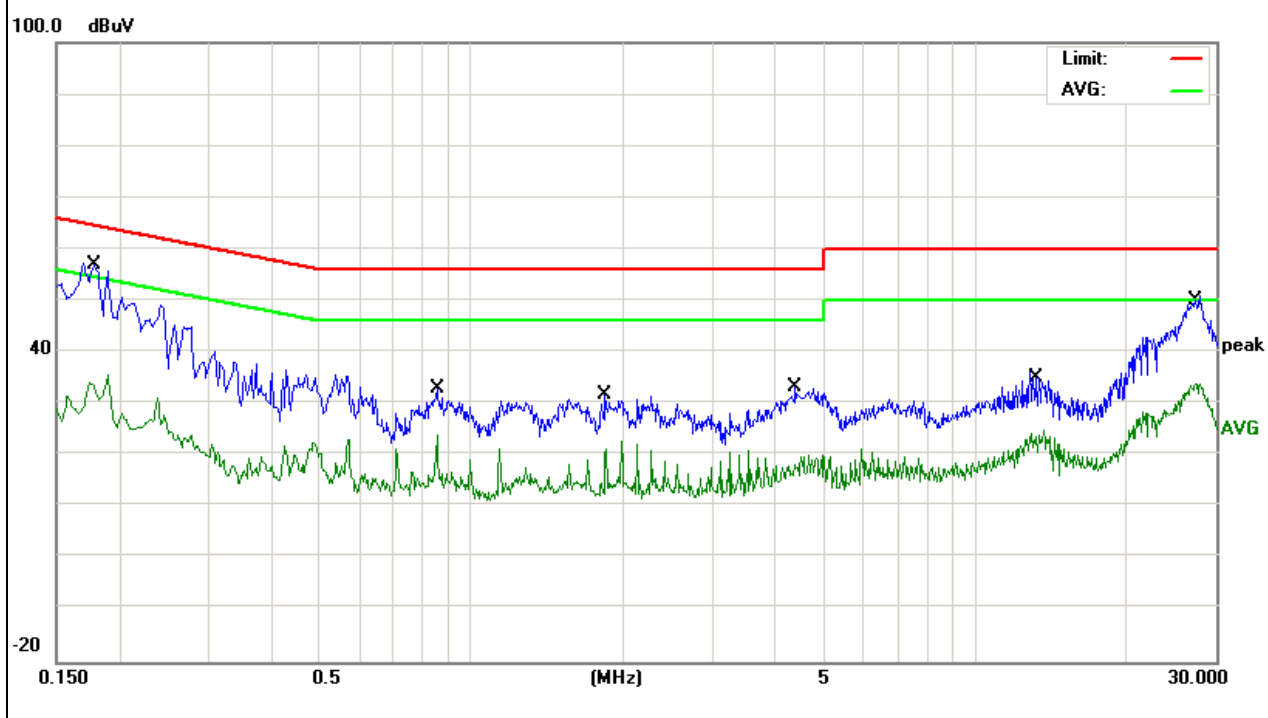

3.2 RADIATED EMISSION MEASUREMENT

3.2.1 LIMITS OF RADIATED EMISSION MEASUREMENT

FREQUENCY (MHz)	Class A (at 10m)	Class B (at 3m)
	dBuV/m	dBuV/m
30 ~ 88	39.0	40.0
88 ~ 216	43.5	43.5
216 ~ 960	46.5	46.0
Above 960	49.5	54.0

Notes:

- (1) The limit for radiated test was performed according to as following:
FCC PART 15B /ICES-003.
- (2) The tighter limit applies at the band edges.
- (3) Emission level (dBuV/m)=20log Emission level (uV/m).

3.2.2 TEST PROCEDURE

Test Arrangement for Radiated Emissions up to 1 GHz

- a. The EUT was placed on the top of a rotating table 0.8 meters above the ground at an accredited test facility. The table was rotated 360 degrees to determine the position of the highest radiation.
- b. The EUT was set 3 meters away from the interference-receiving antenna, which was mounted on the top of a variable-height antenna tower.
- c. The antenna is a broadband antenna, and its height is varied from one meter to four meters above the ground to determine the maximum value of the field strength. Both horizontal and vertical polarizations of the antenna are set to make the measurement.
- d. For each suspected emission, the EUT was arranged to its worst case and then the antenna was tuned to heights from 1 meter to 4 meters and the rotatable table was turned from 0 degrees to 360 degrees to find the maximum reading.
- e. The test-receiver system was set to quasi-peak detect function and specified bandwidth with maximum hold mode when the test frequency is below 1 GHz.

Frequency Band (MHz)	Function	Resolution bandwidth	Video Bandwidth
30~1000	QP	120kHz	300kHz

Test Arrangement for Radiated Emissions above 1 GHz.

- a. The EUT was placed on the top of a rotating table 0.8 meters above the ground at an accredited chamber room. The table was rotated 360 degrees to determine the position of the highest radiation.
- b. The EUT was set 3 meters away from the interference-receiving antenna, which was mounted on the top of a variable-height antenna tower.
- c. The height of antenna can be varied from one meter to four meters, the height of adjustment depends on the EUT height and the antenna 3dB beamwidth both, to detect the maximum value of the field strength.Both horizontal and vertical polarizations of the antenna are set to make the measurement.
- d. For each suspected emission, the EUT was arranged to its worst case and then the antenna

was tuned to heights and the rotatable table was turned from 0 degrees to 360 degrees to find the maximum reading.

- e. The spectrum analyzer system was set to peak and average detect function and specified bandwidth with maximum hold mode when the test frequency is above 1 GHz

Frequency Band (MHz)	Function	Resolution bandwidth	Video Bandwidth
Above 1000	Peak	1 MHz	3 MHz
	Average	1 MHz	10 Hz

3.2.3 TEST SETUP

(A) Radiated Emission Test Set-Up Frequency Below 1 GHz

For Radiated Emission 30~1000MHz

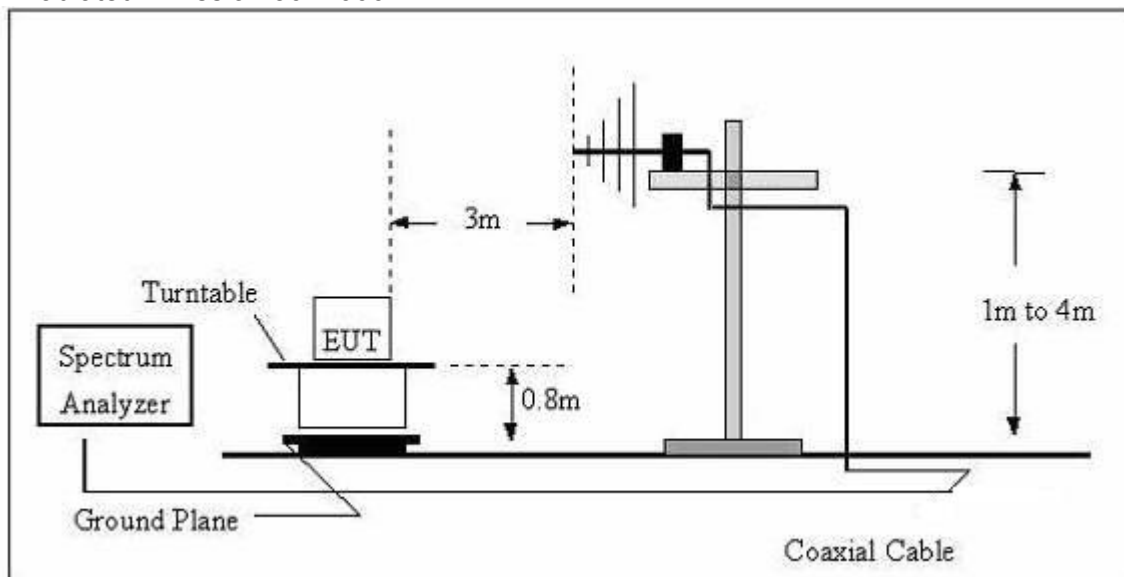

(B) Radiated Emission Test Set-Up Frequency Above 1GHz

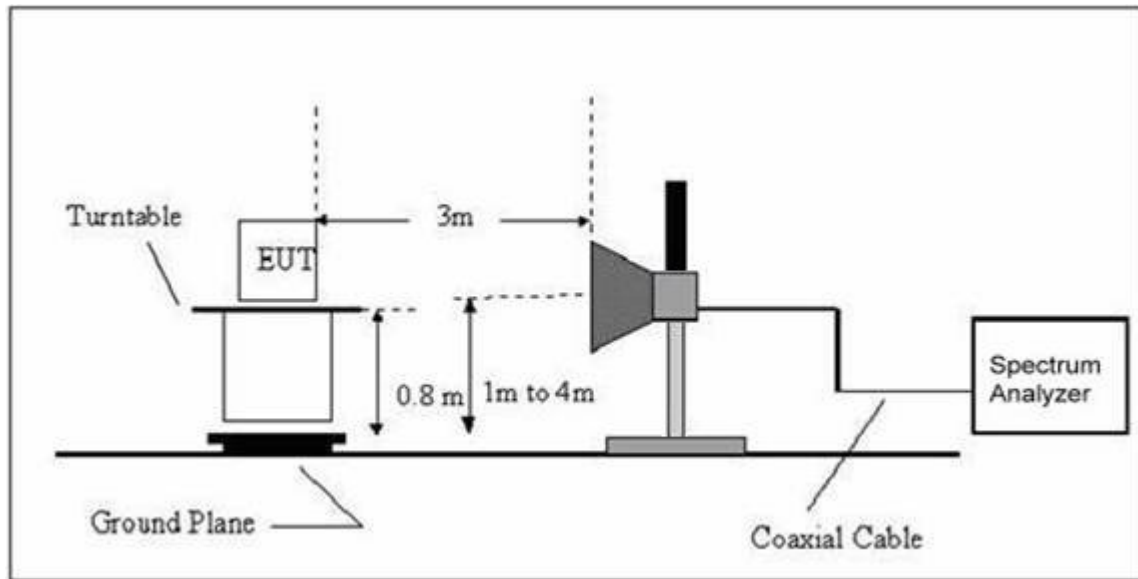

3.2.4 EUT OPERATING CONDITIONS

The EUT tested system was configured as the statements of **2.3** Unless otherwise a special operating condition is specified in the follows during the testing.

3.2.5 TEST RESULTS

TEST RESULTS (30~1000 MHz)

EUT :	Media Recorder	Model Name :	PT1190
Temperature :	24 °C	Relative HuMedia Recorderity :	54%
Pressure :	1010 hPa	Test Date :	2016-11-18
Test Mode :	Mode 1	Polarization :	Horizontal
Test Power :	AC 120V/60Hz		

Freq. (MHz)	Reading (dBµV/m)	Factor (dB)	Measurement (dBµV/m)	Limit (dBµV/m)	Over (dB)	Detector
60.9176	24.57	7.63	32.2	40	-7.8	QP
199.2855	24.42	10.78	35.2	43.5	-8.3	QP
213.7632	25.29	11.71	37	43.5	-6.5	QP
323.3204	16.96	15.12	32.08	46	-13.92	QP
382.5878	25.28	17.59	42.87	46	-3.13	QP
578.6698	18.27	21.95	40.22	46	-5.78	QP

Remark:

Factor = Antenna Factor + Cable Loss.

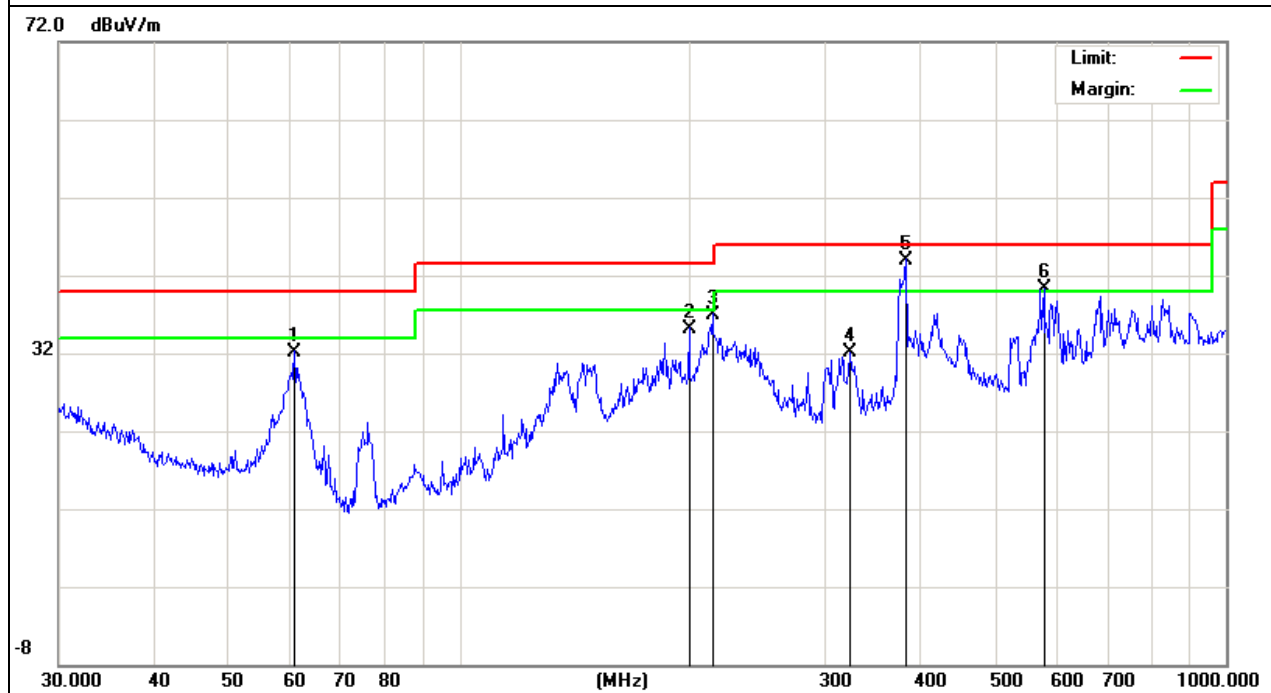

EUT :	Media Recorder	Model Name :	PT1190
Temperature :	24 °C	Relative Humidity :	54%
Pressure :	1010 hPa	Test Date :	2016-11-18
Test Mode :	Mode 1	Polarization :	Vertical
Test Power :	AC 120V/60Hz		

Freq. (MHz)	Reading (dBμV/m)	Factor (dB)	Measurement (dBμV/m)	Limit (dBμV/m)	Over (dB)	Detector
52.7599	26.93	9.91	36.84	40	-3.16	QP
148.9625	25.68	10.52	36.2	43.5	-7.3	QP
160.9088	25.42	10.48	35.9	43.5	-7.6	QP
341.9786	21.98	15.91	37.89	46	-8.11	QP
393.4723	21.05	18.04	39.09	46	-6.91	QP
528.2458	22.22	20.88	43.1	46	-2.9	QP

Remark:

Factor = Antenna Factor + Cable Loss.

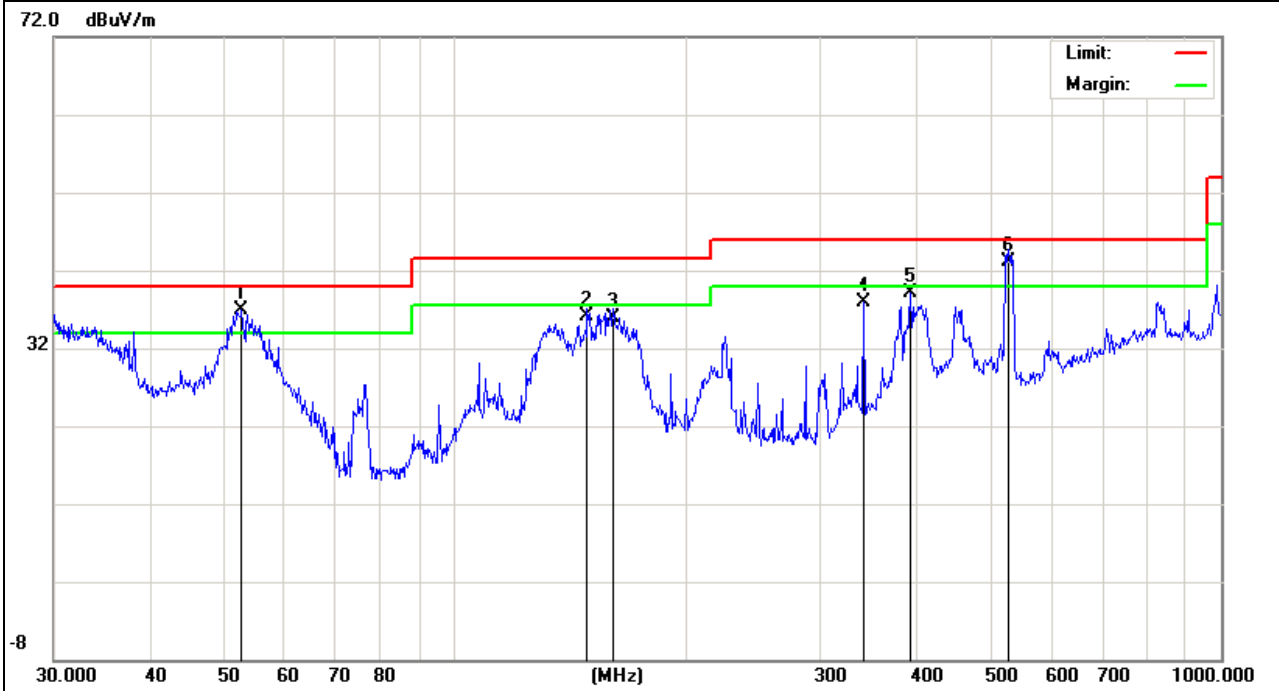

EUT :	Media Recorder	Model Name :	PT1190
Temperature :	24 °C	Relative Humidity :	54%
Pressure :	1010 hPa	Test Date :	2016-11-18
Test Mode :	Mode 2	Polarization :	Horizontal
Test Power :	AC 120V/60Hz		

Freq. (MHz)	Reading (dBμV/m)	Factor (dB)	Measurement (dBμV/m)	Limit (dBμV/m)	Over (dB)	Detector
60.9176	22.59	7.63	30.22	40	-9.78	QP
142.824	20.01	11.13	31.14	43.5	-12.36	QP
215.2677	25.09	11.82	36.91	43.5	-6.59	QP
382.5878	25.61	17.59	43.2	46	-2.8	QP
574.6258	18.93	21.86	40.79	46	-5.21	QP
830.4002	11.8	27.3	39.1	46	-6.9	QP

Remark:
Factor = Antenna Factor + Cable Loss.

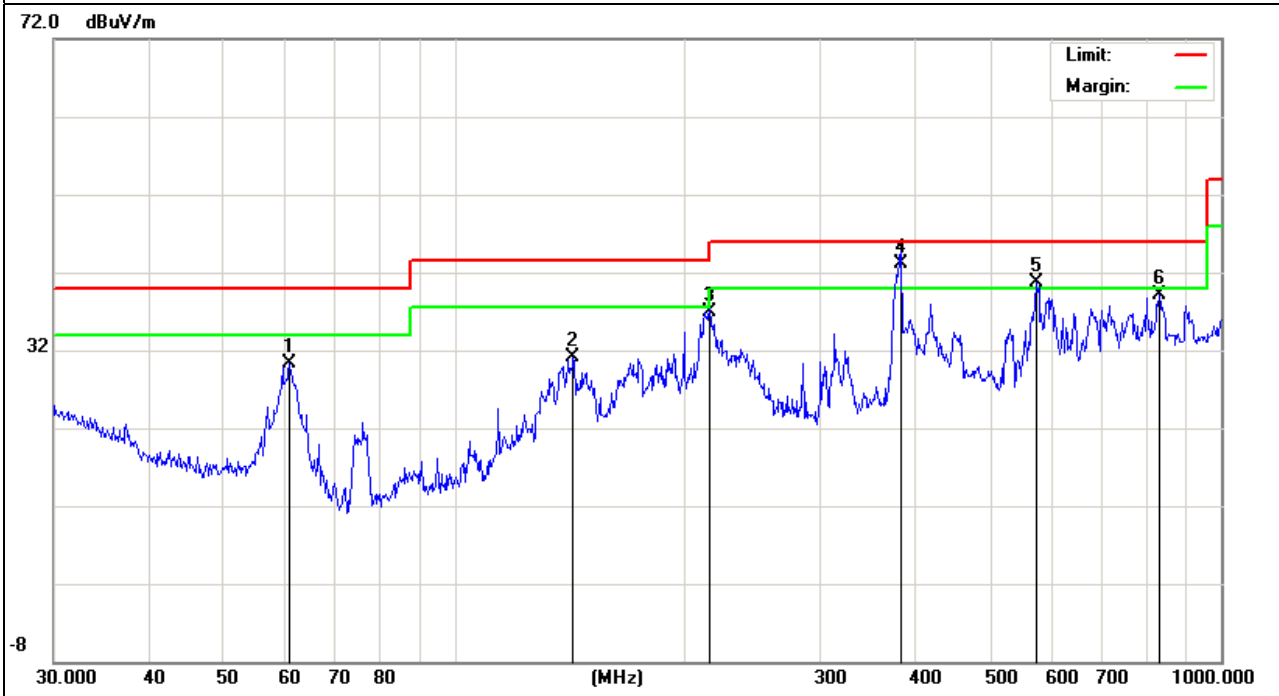

EUT :	Media Recorder	Model Name :	PT1190
Temperature :	24 °C	Relative Humidity :	54%
Pressure :	1010 hPa	Test Date :	2016-11-18
Test Mode :	Mode 2	Polarization :	Vertical
Test Power :	AC 120V/60Hz		

Freq. (MHz)	Reading (dBμV/m)	Factor (dB)	Measurement (dBμV/m)	Limit (dBμV/m)	Over (dB)	Detector
53.5052	27.05	9.69	36.74	40	-3.26	QP
154.8204	25	10.45	35.45	43.5	-8.05	QP
297.2241	28.08	14.12	42.2	46	-3.8	QP
446.4141	23.86	19.23	43.09	46	-2.91	QP
595.1326	20.11	22.31	42.42	46	-3.58	QP
744.8659	16.52	25.96	42.48	46	-3.52	QP

Remark:

Factor = Antenna Factor + Cable Loss.

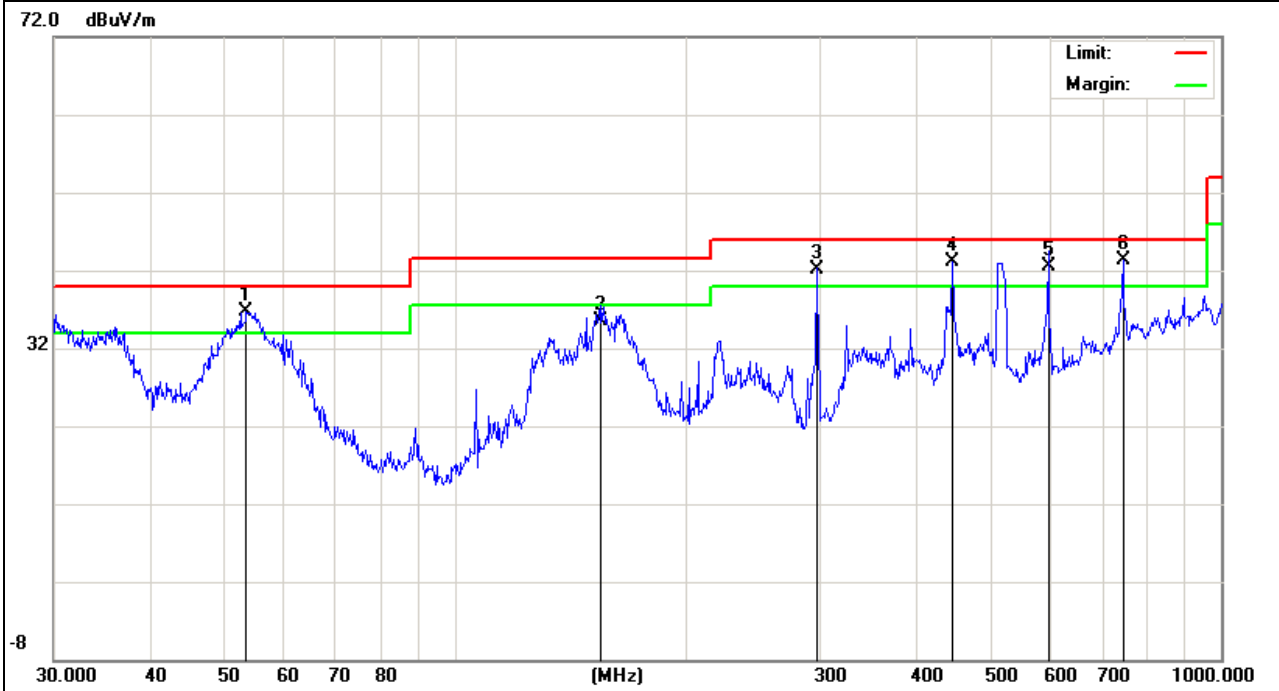

EUT :	Media Recorder	Model Name :	PT1190
Temperature :	24 °C	Relative Humidity :	54%
Pressure :	1010 hPa	Test Date :	2016-11-18
Test Mode :	Mode 3	Polarization :	Horizontal
Test Power :	AC 120V/60Hz		

Freq. (MHz)	Reading (dBμV/m)	Factor (dB)	Measurement (dBμV/m)	Limit (dBμV/m)	Over (dB)	Detector
60.4919	26.66	7.72	34.38	40	-5.62	QP
114.1136	20.08	10.83	30.91	43.5	-12.59	QP
147.9214	21.55	10.63	32.18	43.5	-11.32	QP
213.7633	25.26	11.71	36.97	43.5	-6.53	QP
382.5878	25.36	17.59	42.95	46	-3.05	QP
576.6443	19.1	21.91	41.01	46	-4.99	QP

Remark:

Factor = Antenna Factor + Cable Loss.

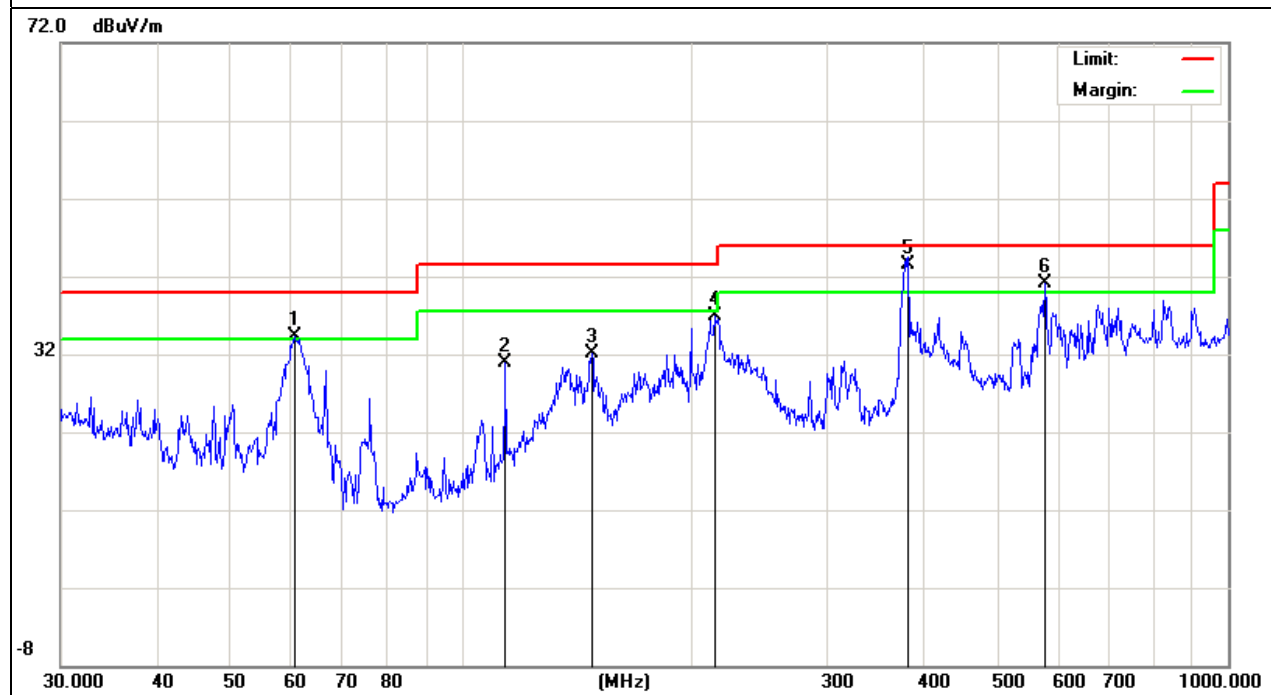

EUT :	Media Recorder	Model Name :	PT1190
Temperature :	24 °C	Relative Humidity :	54%
Pressure :	1010 hPa	Test Date :	2016-11-18
Test Mode :	Mode 3	Polarization :	Vertical
Test Power :	AC 120V/60Hz		

Freq. (MHz)	Reading (dBµV/m)	Factor (dB)	Measurement (dBµV/m)	Limit (dBµV/m)	Over (dB)	Detector
43.9658	24.73	12.26	36.99	40	-3.01	QP
104.1701	24.41	9.39	33.8	43.5	-9.7	QP
138.8735	25.33	11.47	36.8	43.5	-6.7	QP
154.8204	25.85	10.45	36.3	43.5	-7.2	QP
223.7333	24.53	12.38	36.91	46	-9.09	QP
522.7178	22.33	20.77	43.1	46	-2.9	QP

Remark:

Factor = Antenna Factor + Cable Loss.

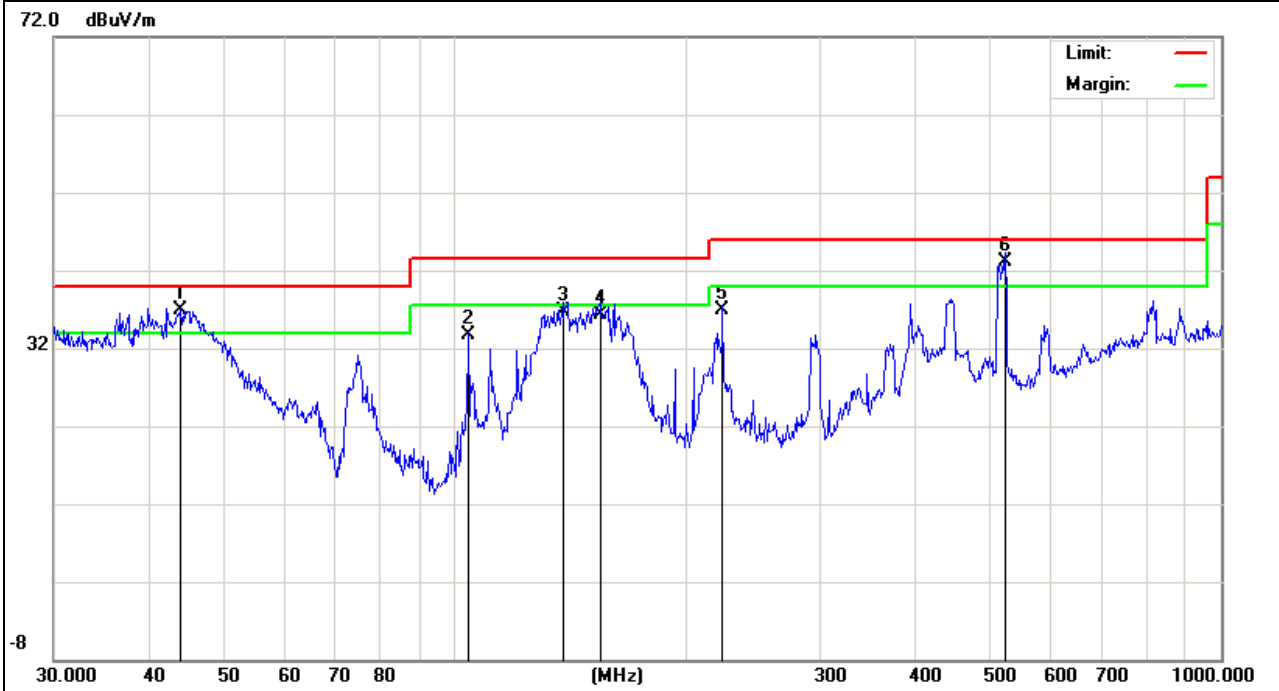

EUT :	Media Recorder	Model Name :	PT1190
Temperature :	24 °C	Relative Humidity :	54%
Pressure :	1010 hPa	Test Date :	2016-11-18
Test Mode :	Mode 4	Polarization :	Horizontal
Test Power :	AC 120V/60Hz		

Freq. (MHz)	Reading (dBμV/m)	Factor (dB)	Measurement (dBμV/m)	Limit (dBμV/m)	Over (dB)	Detector
75.1821	27.33	5.71	33.04	40	-6.96	QP
130.8369	24.65	11.85	36.5	43.5	-7	QP
210.786	23.79	11.51	35.3	43.5	-8.2	QP
222.9499	24.67	12.33	37	46	-9	QP
522.7178	22.16	20.77	42.93	46	-3.07	QP
821.7103	14.02	27.33	41.35	46	-4.65	QP

Remark:

Factor = Antenna Factor + Cable Loss.

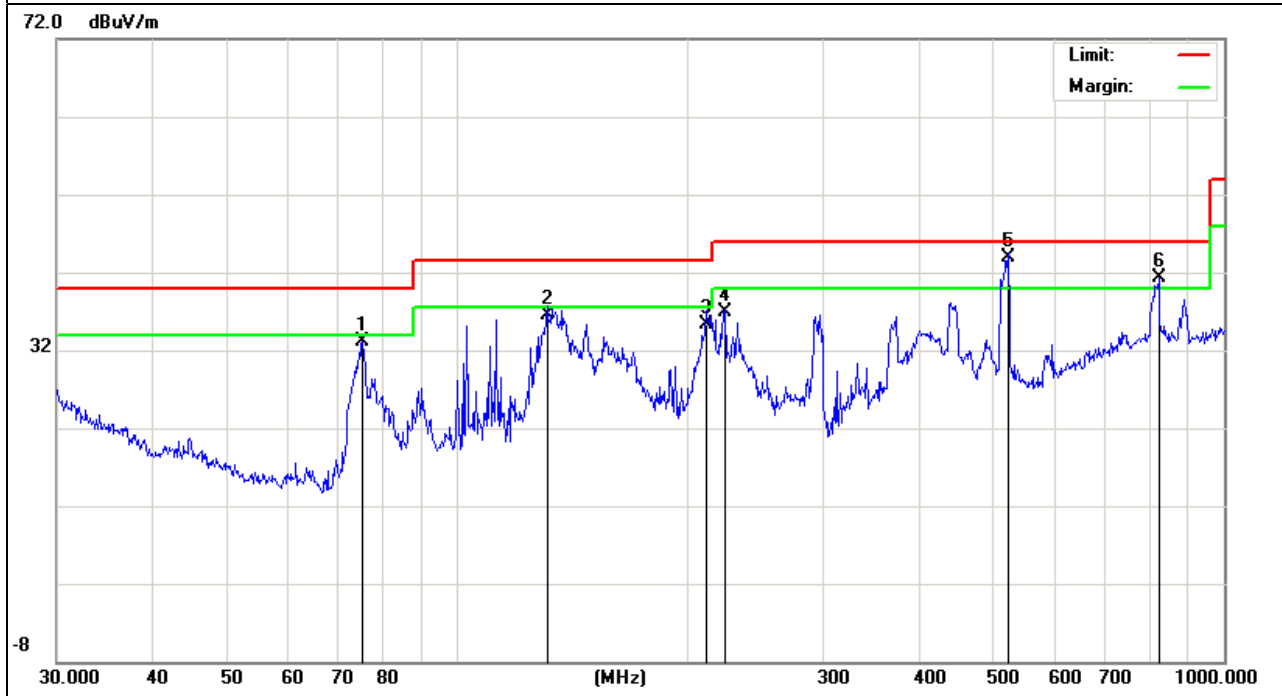

EUT :	Media Recorder	Model Name :	PT1190
Temperature :	24 °C	Relative Humidity :	54%
Pressure :	1010 hPa	Test Date :	2016-11-18
Test Mode :	Mode 4	Polarization :	Vertical
Test Power :	AC 120V/60Hz		

Freq. (MHz)	Reading (dBµV/m)	Factor (dB)	Measurement (dBµV/m)	Limit (dBµV/m)	Over (dB)	Detector
53.8817	25.72	9.58	35.3	40	-4.7	QP
117.3602	20.67	11.53	32.2	43.5	-11.3	QP
160.9088	24.76	10.48	35.24	43.5	-8.26	QP
324.456	21.5	15.18	36.68	46	-9.32	QP
393.4723	21.24	18.04	39.28	46	-6.72	QP
522.718	21.43	20.77	42.2	46	-3.8	QP

Remark:

Factor = Antenna Factor + Cable Loss.

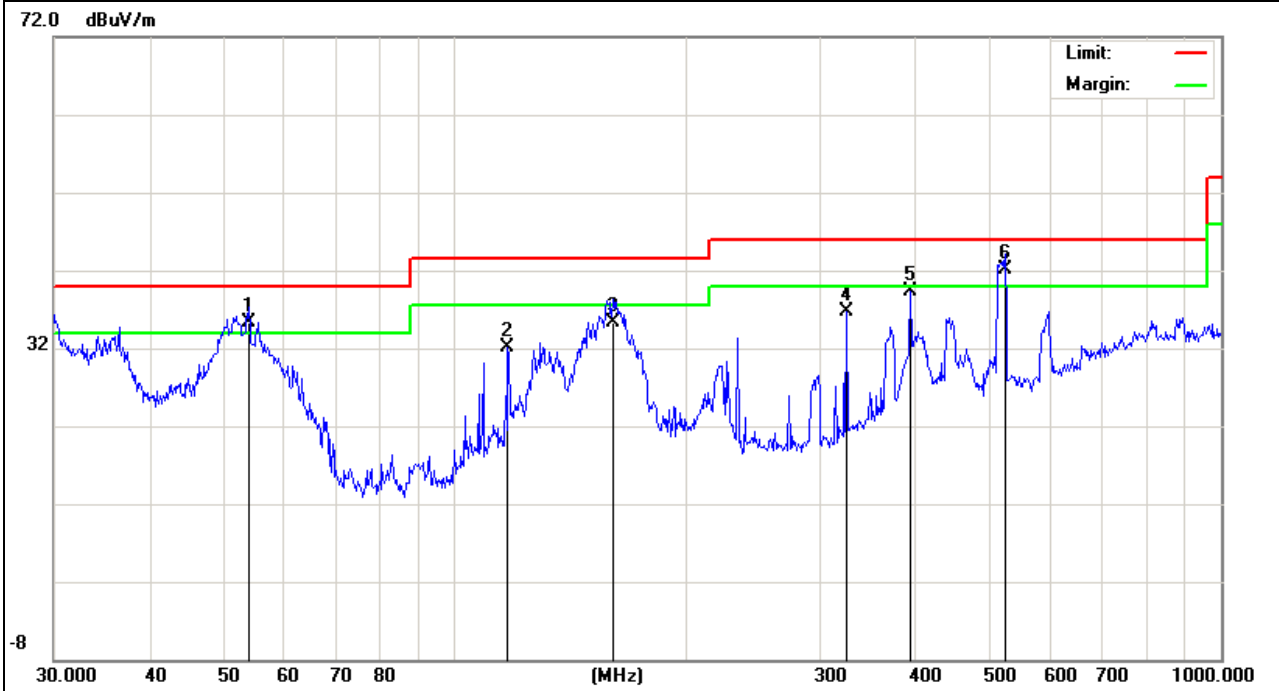

EUT :	Media Recorder	Model Name :	PT1190
Temperature :	24 °C	Relative Humidity :	54%
Pressure :	1010 hPa	Test Date :	2016-11-18
Test Mode :	Mode 5	Polarization :	Horizontal
Test Power :	AC 120V/60Hz		

Freq. (MHz)	Reading (dBμV/m)	Factor (dB)	Measurement (dBμV/m)	Limit (dBμV/m)	Over (dB)	Detector
54.261	21.78	9.48	31.26	40	-8.74	QP
148.441	24.86	10.57	35.43	43.5	-8.07	QP
297.2241	28.44	14.12	42.56	46	-3.44	QP
446.4141	23.56	19.23	42.79	46	-3.21	QP
595.1326	20.42	22.31	42.73	46	-3.27	QP
744.8659	17.01	25.96	42.97	46	-3.03	QP

Remark:

Factor = Antenna Factor + Cable Loss.

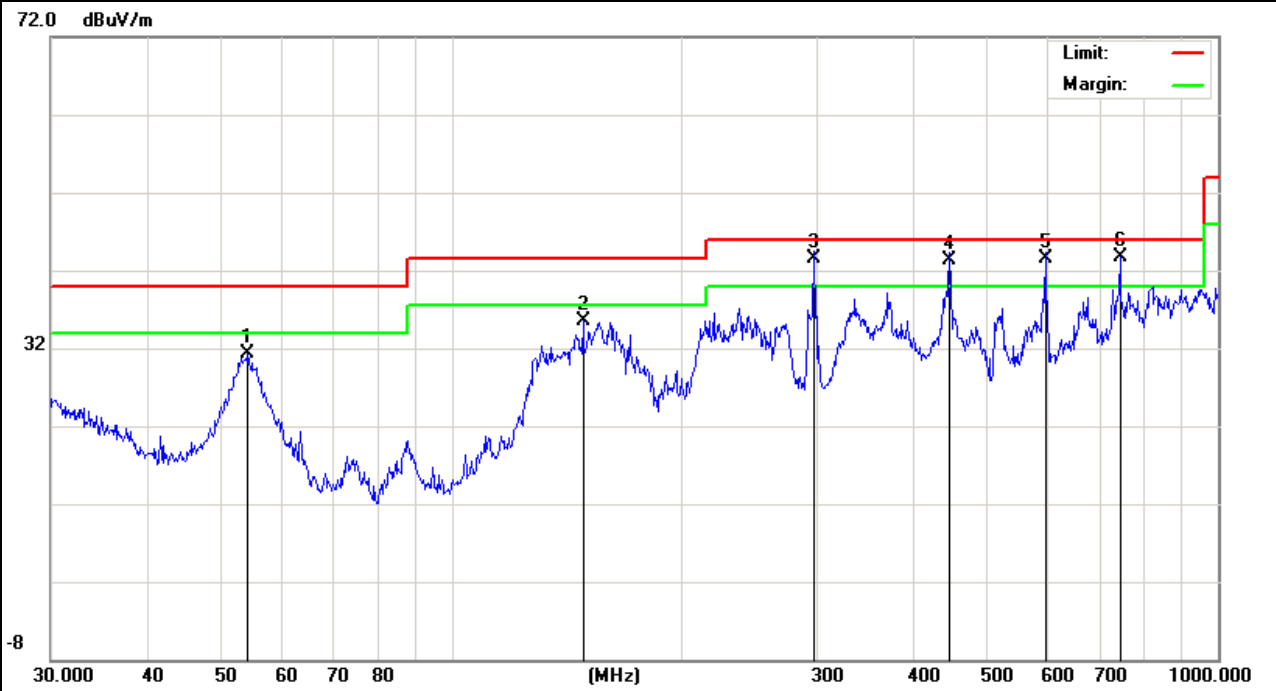

EUT :	Media Recorder	Model Name :	PT1190
Temperature :	24 °C	Relative Humidity :	54%
Pressure :	1010 hPa	Test Date :	2016-11-18
Test Mode :	Mode 5	Polarization :	Vertical
Test Power :	AC 120V/60Hz		

Freq. (MHz)	Reading (dBμV/m)	Factor (dB)	Measurement (dBμV/m)	Limit (dBμV/m)	Over (dB)	Detector
37.945	21.82	14.83	36.65	40	-3.35	QP
60.28	28.43	7.77	36.2	40	-3.8	QP
114.1137	23.11	10.83	33.94	43.5	-9.56	QP
167.2366	23.68	10.54	34.22	43.5	-9.28	QP
379.9141	22.15	17.47	39.62	46	-6.38	QP
682.3484	15.18	24.31	39.49	46	-6.51	QP

Remark:
Factor = Antenna Factor + Cable Loss.

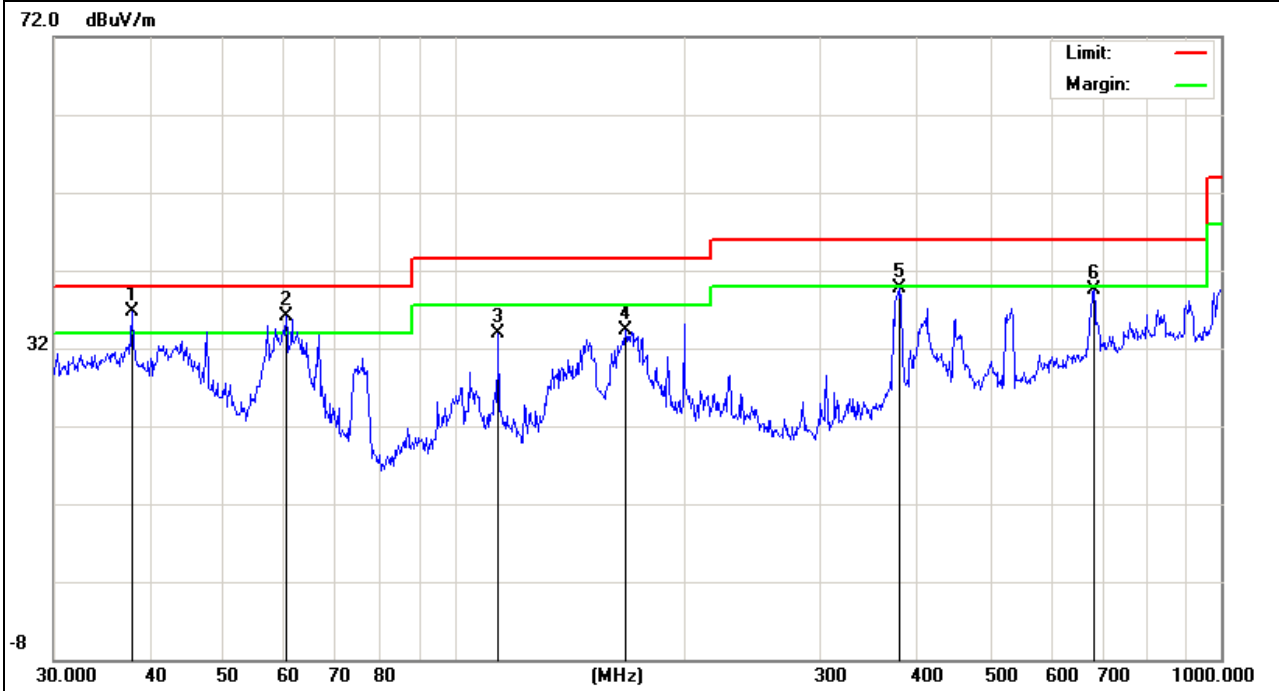

EUT :	Media Recorder	Model Name :	PT1190
Temperature :	24 °C	Relative Humidity :	54%
Pressure :	1010 hPa	Test Date :	2016-11-18
Test Mode :	Mode 6	Polarization :	Horizontal
Test Power :	AC 120V/60Hz		

Freq. (MHz)	Reading (dBμV/m)	Factor (dB)	Measurement (dBμV/m)	Limit (dBμV/m)	Over (dB)	Detector
53.1313	23.11	9.8	32.91	40	-7.09	QP
149.4857	24.94	10.46	35.4	43.5	-8.1	QP
210.786	21.99	11.51	33.5	43.5	-10	QP
297.2241	21.22	14.12	35.34	46	-10.66	QP
522.7178	22.49	20.77	43.26	46	-2.74	QP
821.7103	13.89	27.33	41.22	46	-4.78	QP

Remark:

Factor = Antenna Factor + Cable Loss.

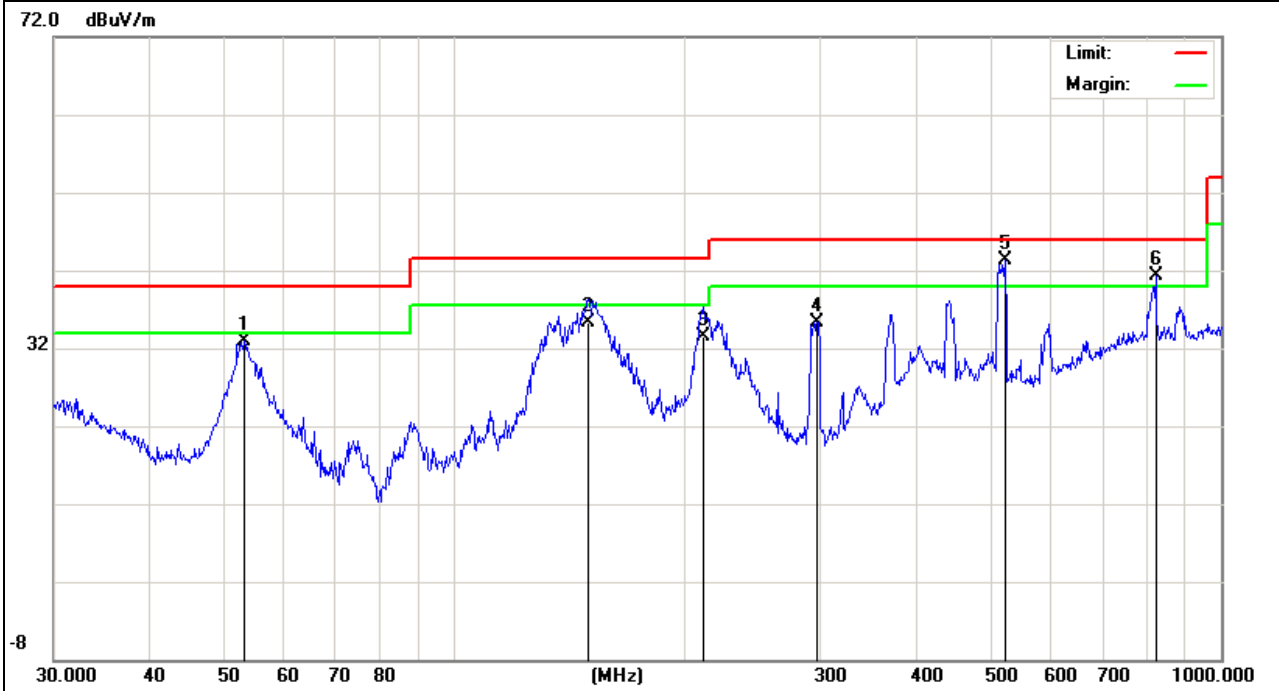

EUT :	Media Recorder	Model Name :	PT1190
Temperature :	24 °C	Relative Humidity :	54%
Pressure :	1010 hPa	Test Date :	2016-11-18
Test Mode :	Mode 6	Polarization :	Vertical
Test Power :	AC 120V/60Hz		

Freq. (MHz)	Reading (dBμV/m)	Factor (dB)	Measurement (dBμV/m)	Limit (dBμV/m)	Over (dB)	Detector
60.4919	28.77	7.72	36.49	40	-3.51	QP
114.1136	22.49	10.83	33.32	43.5	-10.18	QP
148.9625	24.95	10.52	35.47	43.5	-8.03	QP
170.7925	24.9	10.56	35.46	43.5	-8.04	QP
381.2485	21.6	17.53	39.13	46	-6.87	QP
679.96	13.62	24.25	37.87	46	-8.13	QP

Remark:

Factor = Antenna Factor + Cable Loss.

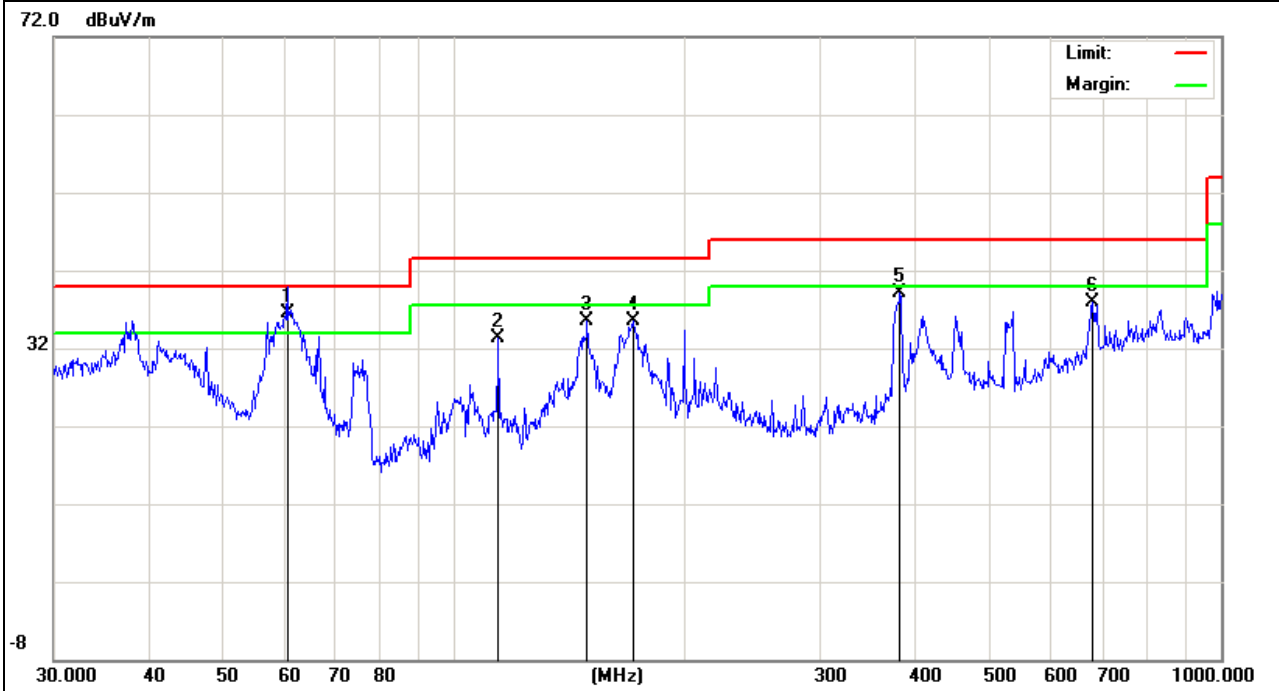

3.2.6 TEST RESULTS(1000~6000MHz)

EUT :	Media Recorder	Model Name :	PT1190
Temperature :	24 °C	Relative HuMedia Recorderity :	54%
Pressure :	1010 hPa	Test Date :	2016-11-18
Test Mode :	Mode 1	Polarization :	Horizontal
Test Power :	AC 120V/60Hz		

Freq. (MHz)	Reading (dBµV/m)	Factor (dB)	Measurement (dBµV/m)	Limit (dBµV/m)	Over (dB)	Detector
1066.6290	61.70	-12.91	48.79	74.00	-25.21	peak
1066.6290	39.44	-12.91	26.53	54.00	-27.47	AVG
1559.4860	64.03	-10.96	53.07	74.00	-20.93	peak
1559.4860	41.58	-10.96	30.62	54.00	-23.38	AVG
2184.1070	61.13	-7.38	53.75	74.00	-20.25	peak
2184.1070	38.65	-7.38	31.27	54.00	-22.73	AVG
3119.7950	57.38	-5.90	51.48	74.00	-22.52	peak
3119.7950	35.15	-5.90	29.25	54.00	-24.75	AVG
4377.2020	56.42	-0.18	56.24	74.00	-17.76	peak
4377.2020	34.25	-0.18	34.07	54.00	-19.93	AVG
4830.5320	50.06	1.87	51.93	74.00	-22.07	peak
4830.5320	27.65	1.87	29.52	54.00	-24.48	AVG

Remark:

Factor = Antenna Factor + Cable Loss.

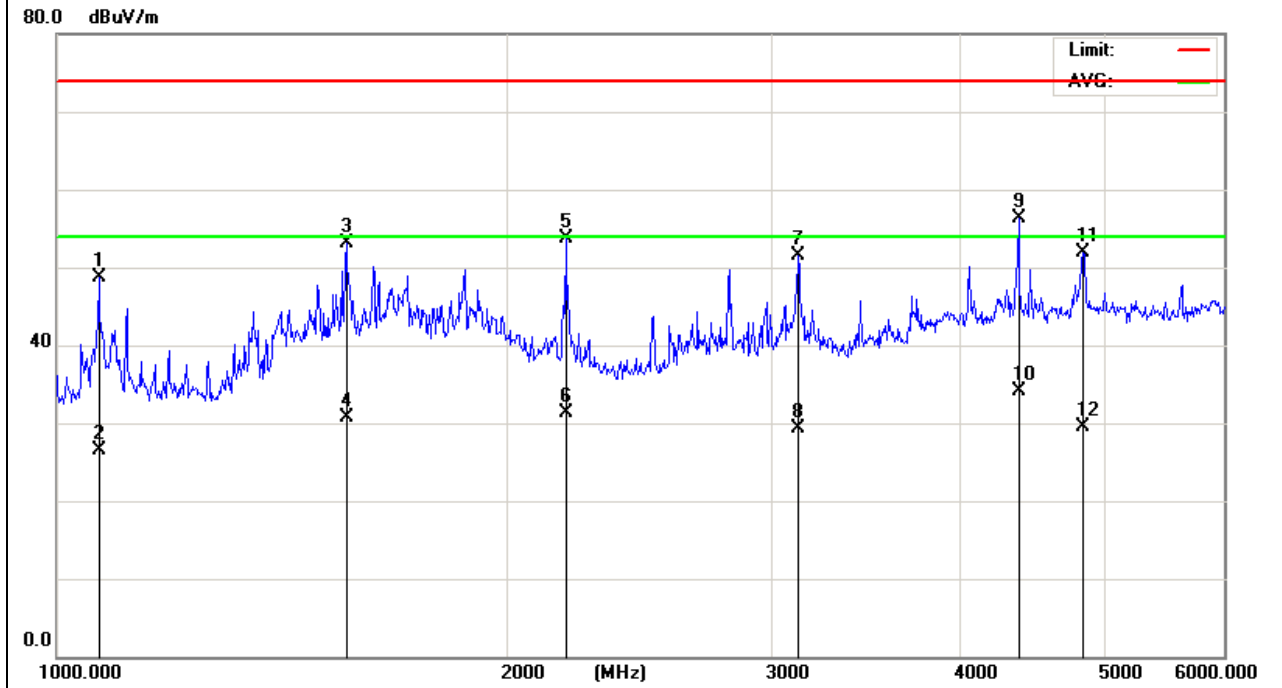

EUT :	Media Recorder	Model Name :	PT1190
Temperature :	24 °C	Relative HuMedia Recorderity :	54%
Pressure :	1010 hPa	Test Date :	2016-11-18
Test Mode :	Mode 1	Polarization :	Vertical
Test Power :	AC 120V/60Hz		

Freq. (MHz)	Reading (dBµV/m)	Factor (dB)	Measurement (dBµV/m)	Limit (dBµV/m)	Over (dB)	Detector
1095.6850	62.03	-12.73	49.30	74.00	-24.70	peak
1095.6850	39.48	-12.73	26.75	54.00	-27.25	AVG
1493.8460	64.37	-11.03	53.34	74.00	-20.66	peak
1493.8460	42.34	-11.03	31.31	54.00	-22.69	AVG
1714.8400	60.42	-10.20	50.22	74.00	-23.78	peak
1714.8400	38.46	-10.20	28.26	54.00	-25.74	AVG
2405.9920	56.33	-7.73	48.60	74.00	-25.40	peak
2405.9920	34.14	-7.73	26.41	54.00	-27.59	AVG
3119.7950	56.54	-5.90	50.64	74.00	-23.36	peak
3119.7950	33.84	-5.90	27.94	54.00	-26.06	AVG
4804.6360	54.56	1.78	56.34	74.00	-17.66	peak
4804.6360	31.82	1.78	33.60	54.00	-20.40	AVG

Remark:

Factor = Antenna Factor + Cable Loss.

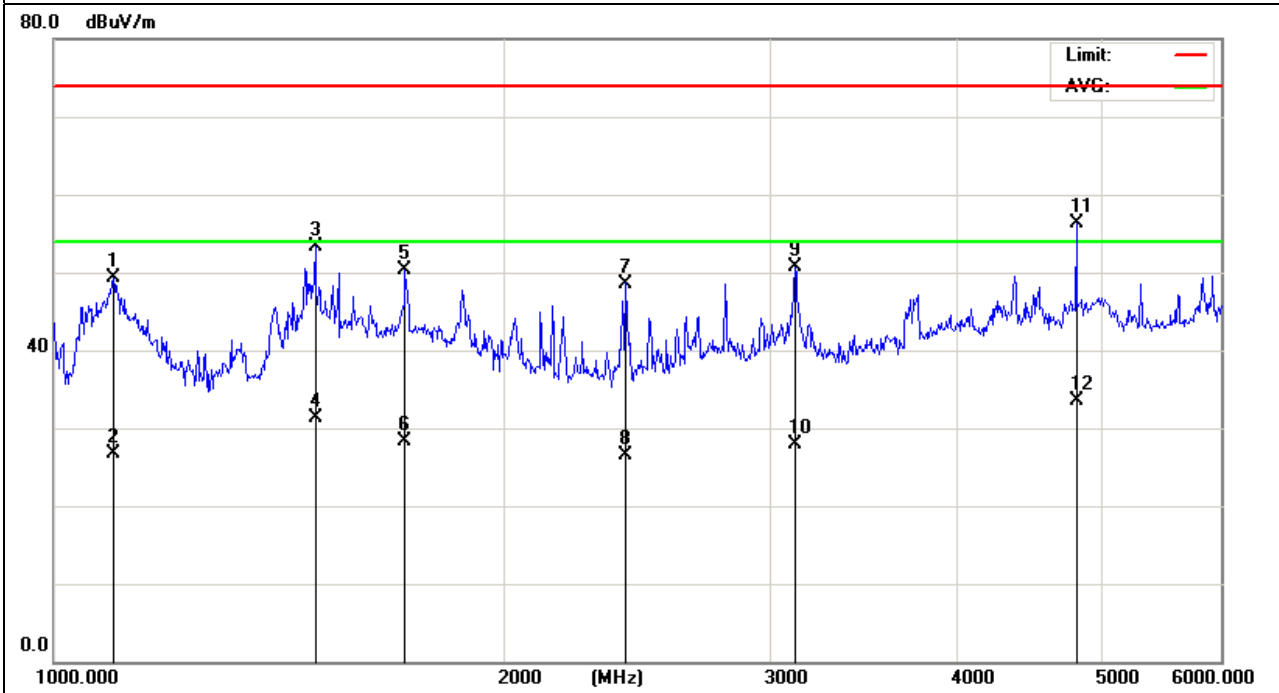

All the modes had been tested, but only the worst data recorded in the report.

Radiated Measurement Photos

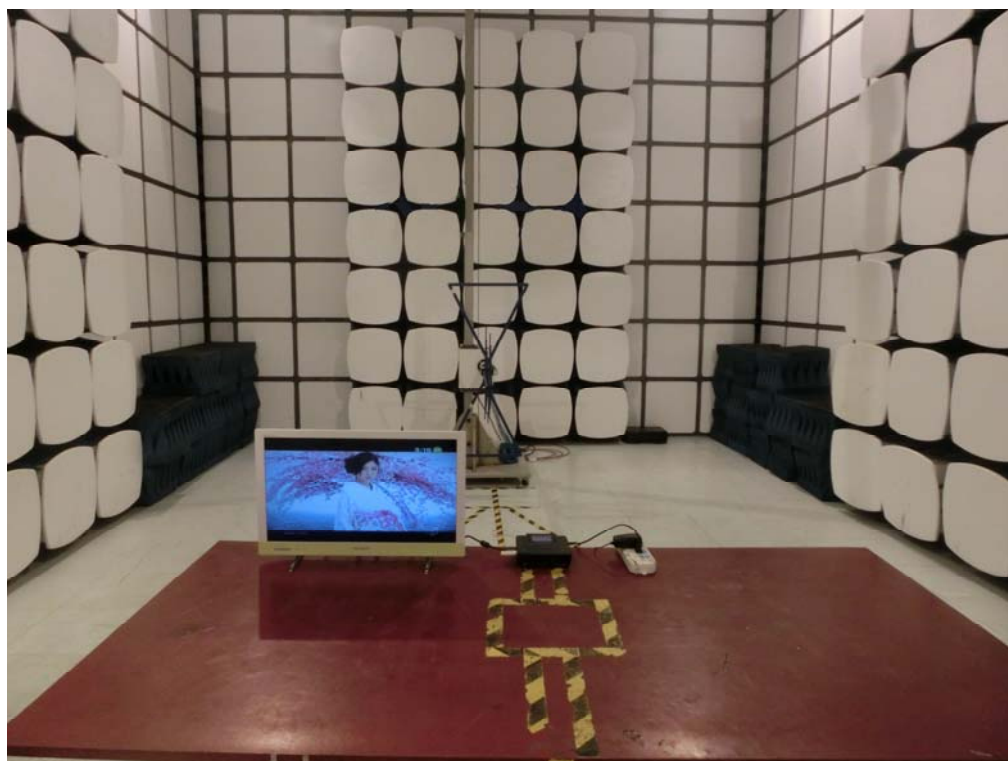

Conducted Measurement Photos



---END OF REPORT---