

FCC TEST REPORT

FCC ID : AZQKC076-22
Applicant : Shenzhen KOHO Technology Co., Ltd
Address : Building3, Jin Yuda Industrial Park, ShangLiao, Shajin, Baoan, Shenzhen
Manufacturer : Shenzhen Kanghai Electronics CO.,LTD
Address : Shenzhen Baoan District Shajing Street 107 State Road jinyuda industrial park(I,II,3)3 2 nd Floor, 3rd Floor, A

Equipment Under Test (EUT) :

Product Name : MID
Model No. : KC076-22, KC076-03
Rules : FCC CFR47 Part15 B Section 15.109:2010

Date of Test : May 28, 2013

Date of Issue : June 5, 2013

Test Result : PASS*

Remark:

* The sample detailed above has been tested to the requirements of FCC rules mentioned above.

The test results have been reviewed against the directives above and found to meet their essential requirements.

The results shown in this test report refer only to the sample(s) tested, this test report cannot be reproduced, except in full, without prior written permission of the company.

The report would be invalid without specific stamp of test institute and the signatures of compiler and approver.

PERPARED BY:

Waltek Services (Shenzhen) Co., Ltd.

1/F, Fukangtai Building, West of Baima Road., Songgang Street, Bao'an District,
Shenzhen, China

Tel: +86-755-83551033

Fax: +86-755-83552400

Compiled by:



Zero Zhou / Project Engineer

Approved by:

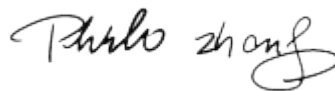

Philo Zhong / Manager

2 Test Summary

Test Items	Test Requirement	Result
Conducted Emissions	15.107	PASS
Radiated Emissions	15.109	PASS

3 Contents

	Page
1 COVER PAGE	1
2 TEST SUMMARY	2
3 CONTENTS	3
4 GENERAL INFORMATION	4
4.1 GENERAL DESCRIPTION OF E.U.T.	4
4.2 DETAILS OF E.U.T.	4
4.3 TEST FACILITY	4
4.4 TEST LOCATION	4
4.5 TEST MODE LIST	5
5 EQUIPMENT USED DURING TEST	6
5.1 EQUIPMENTS LIST	6
5.2 MEASUREMENT UNCERTAINTY	7
5.3 TEST EQUIPMENT CALIBRATION	7
6 CONDUCTED EMISSIONS	8
6.1 E.U.T. TEST CONDITION	8
6.2 EUT SETUP	8
6.3 CONDUCTED EMISSION TEST RESULT	9
7 RADIATED EMISSIONS	11
7.1 EUT OPERATION:	11
7.2 TEST SETUP	11
7.3 SPECTRUM ANALYZER SETUP	13
7.4 TEST PROCEDURE	13
7.5 CORRECTED AMPLITUDE & MARGIN CALCULATION	13
7.6 SUMMARY OF TEST RESULTS	14
8 PHOTOGRAPHS –TEST SETUP	18
8.1 CONDUCTED EMISSIONS	18
8.2 RADIATED EMISSIONS	18
9 PHOTOGRAPHS - CONSTRUCTIONAL DETAILS	21
9.1 EUT – EXTERNAL VIEW	21
9.2 EUT- INTERNAL VIEW	21

4 General Information

4.1 General Description of E.U.T.

Product Name	: MID
Model No.	: KC076-22, KC076-03
Model Description	: The circuit principle,PCB wiring and internal structure are the same except for appearance.
Oscillator	: Crystal 32.768KHz and 24MHz for CPU,40MHz for RF module

4.2 Details of E.U.T.

Technical Data	: DC 5V, 1.5A powered from adapter
Adapter	: SOY Techonolgy Model:SUN-0500150 INPUT:100-240V~ 50/60Hz 0.3A

4.3 Test Facility

The test facility has a test site registered with the following organizations:

- **IC – Registration No.: 7760A**

Waltek Services (Shenzhen) Co., Ltd. has been registered and fully described in a report filed with the Industry Canada. The acceptance letter from the Industry Canada is maintained in our files. Registration 7760A, July 12, 2012.

- **FCC – Registration No.: 880581**

Waltek Services (Shenzhen) Co., Ltd. EMC Laboratory has been registered and fully described in a report filed with the (FCC) Federal Communications Commission. The acceptance letter from the FCC is maintained in our files. Registration 880581, May 26, 2011.

4.4 Test Location

All the tests were performed at:
Waltek Services (Shenzhen) Co., Ltd. at 1/F, Fukangtai Building, West Baima Rd., Songgang Street, Baoan District, Shenzhen, China

4.5 Test Mode List

Test Item	Test Mode	Remark
Conducted Emissions	data transmitting mode	The worst data
	charging mode	Do not report
	video playing mode	Do not report
	recording mode	Do not report
Radiated Emissions (30MHz~1GHz)	data transmitting mode	The worst data
	charging mode	Do not report
	video playing mode	Do not report
	recording mode	Do not report
Radiated Emissions (1GHz~6GHz)	data transmitting mode	The worst data

5 Equipment Used during Test

5.1 Equipments List

Conducted Emissions						
Item	Equipment	Manufacturer	Model No.	Serial No.	Last Calibration Date	Calibration Due Date
1.	EMI Test Receiver	R&S	ESCI	100947	Aug. 13,2012	Aug. 13,2013
2.	LISN	R&S	ENV216	101215	Aug. 13,2012	Aug. 13,2013
3.	Cable	Top	TYPE16(3.5M)	-	Aug.14,2012	Aug. 14,2013
3m Semi-anechoic Chamber for Radiation(TDK) (Test Frequency: Below 1000MHz)						
Item	Equipment	Manufacturer	Model No.	Serial No	Last Calibration Date	Calibration Due Date
1	Test Receiver	R&S	ESCI	101296	Aug.09,2012	Aug.09,2013
2	Active Loop Antenna	Beijing Dazhi	ZN30900A	-	Aug. 13,2012	Aug. 13,2013
3	Trilog Broadband Antenna	SCHWARZBECK	VULB9160	9160-3325	Aug.11,2012	Aug.11,2013
4	Amplifier	Compliance pirection systems inc	PAP-0203	22024	Apr.07,2013	Apr.07,2014
5	Cable	HUBER+SUHNE R	CBL2	525178	Sep.15,2012	Sep.15,2013
3m Semi-anechoic Chamber for Radiation Emissions (Test Frequency:Above 1GHz)						
Item	Equipment	Manufacturer	Model No.	Serial No.	Last Calibration Date	Calibration Due Date
1.	EMC Analyzer	Agilent	E7405A	MY45114943	Aug. 13,2012	Aug. 13,2013
2.	Broad-band Horn Antenna	SCHWARZBECK	BBHA 9120 D	667	Aug. 13,2012	Aug. 13,2013
3.	Broad-band Horn Antenna	SCHWARZBECK	BBHA 9170	399	Aug. 13,2012	Aug. 13,2013
4.	Broadband Preamplifier	COMPLIANCE DIRECTION	PAP-1G18	2004	Apr.07,2013	Apr.07,2014
5.	Broadband Preamplifier	SCHWARZBECK	BBV 9718	9718-148	Aug. 13,2012	Aug. 13,2013
6.	10m Coaxial Cable with N- plug	SCHWARZBECK	AK 9515 H	-	Aug. 13,2012	Aug. 13,2013
Associated Equipment						
1.	Notebook	FLORA	PC4NB8	-	-	-
2.	Notebook	IBM	2672-39C	99-8D3W4	-	-

5.2 Measurement Uncertainty

Parameter	Uncertainty
Radiated Spurious Emissions test	± 5.03 dB (Bilog antenna 30M~1000MHz)
	± 4.74 dB (Horn antenna 1000M~25000MHz)
Conducted Spurious Emissions test	± 3.64 dB (AC mains 150KHz~30MHz)

5.3 Test Equipment Calibration

All the test equipments used are valid and calibrated by CEPREI Certification Body that address is No.110 Dongguan Zhuang RD. Guangzhou, P.R.China.

6 Conducted Emissions

Test Requirement:	FCC CFR 47 Part 15 Section 15.107
Test Method:	ANSI C63.4:2003
Test Result:	PASS
Frequency Range:	150kHz to 30MHz
Class:	Class B
Limit:	66-56 dB μ V between 0.15MHz & 0.5MHz 56 dB μ V between 0.5MHz & 5MHz 60 dB μ V between 5MHz & 30MHz
Detector:	Peak for pre-scan (9kHz Resolution Bandwidth) Quasi-Peak & Average if maximised peak within 6dB of Average Limit

6.1 E.U.T. Test Condition

Operating Environment:

Temperature:	25.5 °C
Humidity:	51 % RH
Atmospheric Pressure:	1012 mbar

Operation Mode:

The EUT was tested in the following mode and the data of worst mode(data transmitting mode) is shown in the report.

- (1) data transmitting mode
- (2) charging mode
- (3) video playing mode
- (4) recording mode

6.2 EUT Setup

The conducted emission tests were performed using the setup accordance with the ANSI C63.4:2003, the specification used in this report was the FCC Part15.207 limits. The EUT was placed on the test table in shielding room

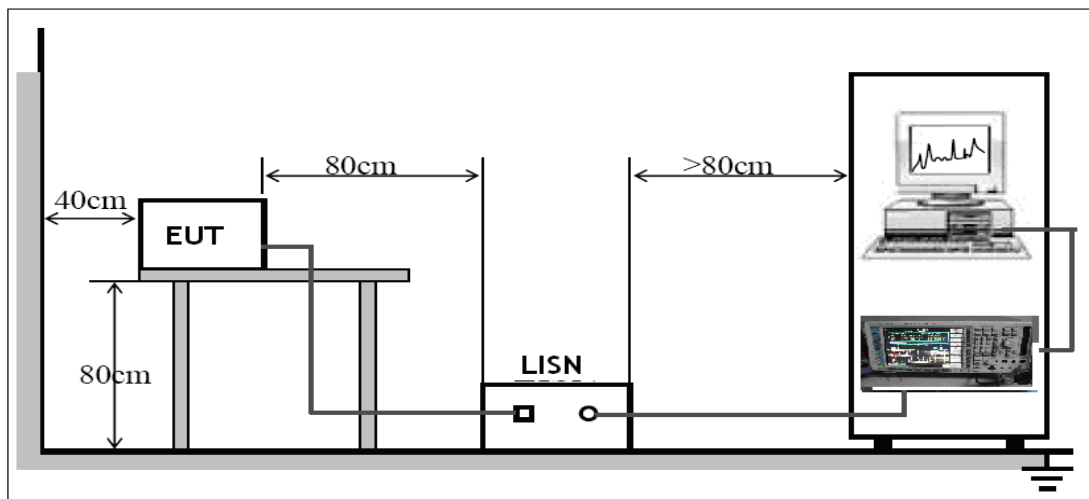

6.3 Conducted Emission Test Result

The maximised peak emissions from the EUT was scanned and measured for both the Live and Neutral Lines. Quasi-peak & average measurements were performed if peak emissions were within 6dB of the average limit line.

data transmitting mode(the worst mode)

Live line:

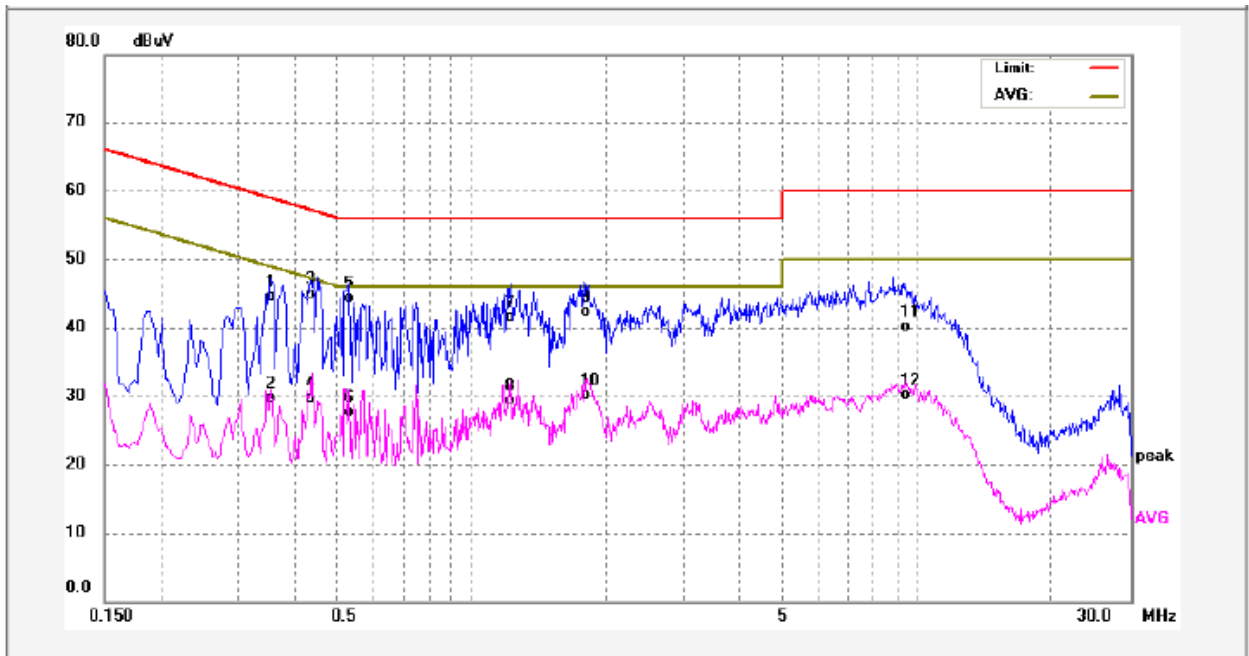

No.	Freq. (MHz)	Reading (dBuV)	Factor (dB)	Result (dBuV)	Limit dBuV	Margin (dB)	Detector	Remark
1	0.3540	33.15	11.31	44.46	58.87	-14.41	QP	
2	0.3540	18.47	11.31	29.78	48.87	-19.09	AVG	
3	0.4420	33.65	11.31	44.96	57.02	-12.06	QP	
4	0.4420	18.46	11.31	29.77	47.02	-17.25	AVG	
5	0.5299	32.99	11.31	44.30	56.00	-11.70	QP	
6	0.5299	16.46	11.31	27.77	46.00	-18.23	AVG	
7	1.2220	30.38	11.18	41.56	56.00	-14.44	QP	
8	1.2220	18.19	11.18	29.37	46.00	-16.63	AVG	
9	1.8220	31.14	11.20	42.34	56.00	-13.66	QP	
10	1.8220	18.84	11.20	30.04	46.00	-15.96	AVG	
11	9.4340	28.85	11.30	40.15	60.00	-19.85	QP	
12	9.4340	18.72	11.30	30.02	50.00	-19.98	AVG	

Neutral line:

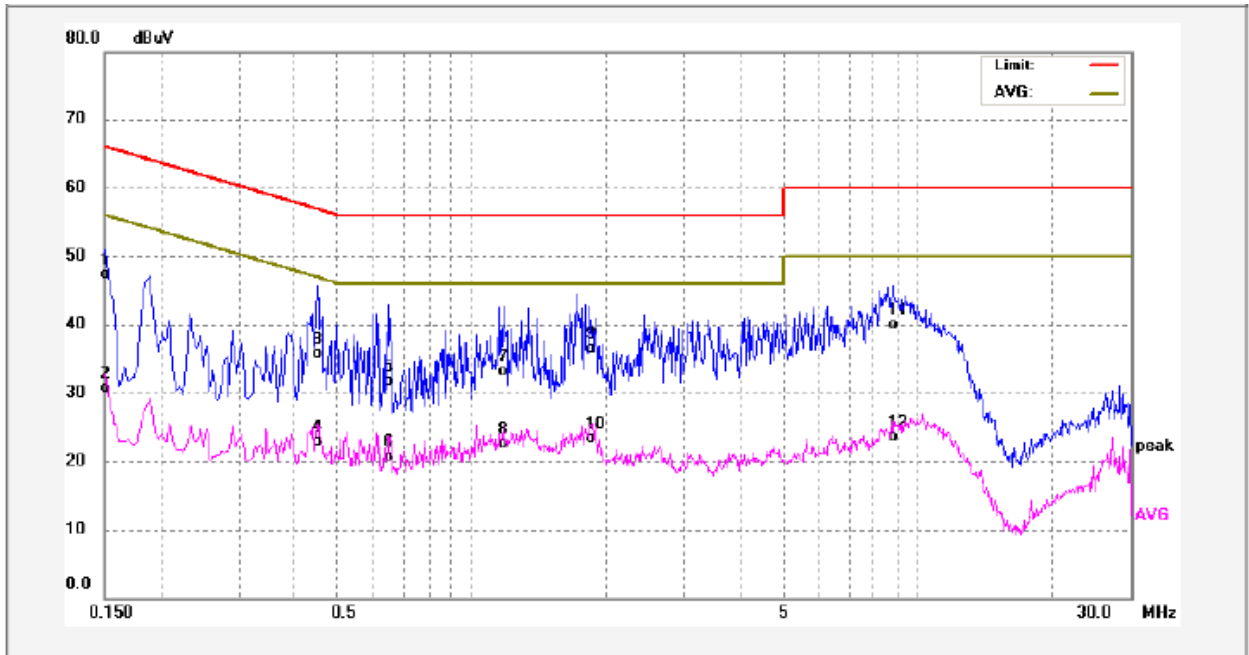

No.	Freq. (MHz)	Reading (dBuV)	Factor (dB)	Result (dBuV)	Limit dBuV	Margin (dB)	Detector	Remark
1	0.1500	36.16	11.17	47.33	65.99	-18.66	QP	
2	0.1500	19.61	11.17	30.78	55.99	-25.21	AVG	
3	0.4500	24.40	11.31	35.71	56.87	-21.16	QP	
4	0.4500	11.60	11.31	22.91	46.87	-23.96	AVG	
5	0.6540	20.38	11.33	31.71	56.00	-24.29	QP	
6	0.6540	9.33	11.33	20.66	46.00	-25.34	AVG	
7	1.1820	21.98	11.18	33.16	56.00	-22.84	QP	
8	1.1820	11.37	11.18	22.55	46.00	-23.45	AVG	
9	1.8620	25.29	11.20	36.49	56.00	-19.51	QP	
10	1.8620	12.17	11.20	23.37	46.00	-22.63	AVG	
11	8.7900	28.54	11.29	39.83	60.00	-20.17	QP	
12	8.7900	12.18	11.29	23.47	50.00	-26.53	AVG	

7 Radiated Emissions

Test Requirement: FCC CFR47 Part 15 Section 15.109

Test Method: ANSI C63.4:2003

Test Result: PASS

Except as otherwise indicated in paragraphs (b)(2) or (b)(3), for an unintentional radiator, including a digital device, the spectrum shall be investigated from the lowest radio frequency signal generated or used in the device, without going below the lowest frequency for which a radiated emission limit is specified, up to 5th harmonic of the highest frequency .

Measurement Distance: 3m

15.109 Limit:

Frequency (MHz)	Field Strength (microvolts/meter)	Measurement Distance (meters)
0.009 -0.490	2400/F(kHz)	300
0.490 - 1.705	24000/F(kHz)	30
1.705 - 30.0	30	30
30-88	100**	3
88-216	150**	3
216-960	200**	3
Above 960	500	3

7.1 EUT Operation:

Operating Environment:

Temperature: 25.5 °C

Humidity: 51 % RH

Atmospheric Pressure: 1012 mbar

Operation Mode:

The EUT was tested in the following mode and the data of worst mode(data transmitting mode) is shown in the report.

- (1) data transmitting mode
- (2) charging mode
- (3) video playing mode
- (4) recording mode

7.2 Test Setup

The radiated emission tests were performed in the 3m Semi- Anechoic Chamber test site, using the setup accordance with the ANSI C63.4: 2003.

The test setup for emission measurement below 30MHz.

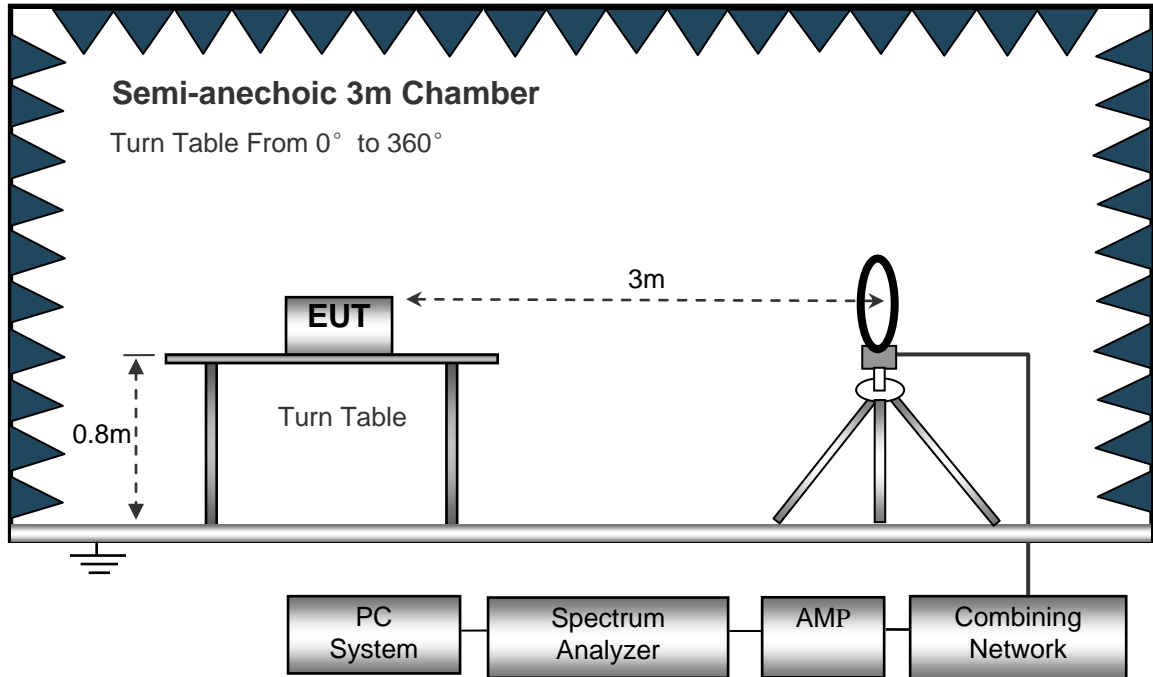

The test setup for emission measurement from 30 MHz to 1 GHz.

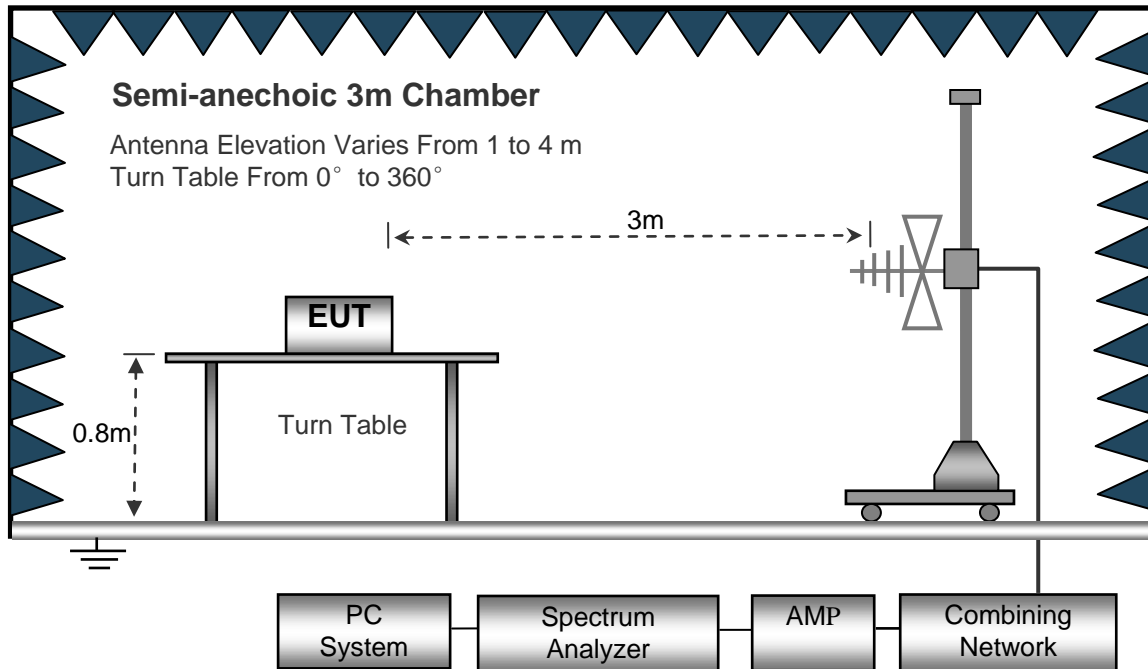

7.3 Spectrum Analyzer Setup

According to FCC Part15 Rules, the system was tested from 32.768KHz to 1 GHz.

Below 30MHz

Sweep SpeedAuto
 IF Bandwidth10KHz
 Video Bandwidth.....10KHz
 Resolution Bandwidth.....10KHz

30 MHz to 1 GHz

Sweep SpeedAuto
 IF Bandwidth120 KHz
 Video Bandwidth.....100KHz
 Quasi-Peak Adapter Bandwidth120 KHz
 Quasi-Peak Adapter ModeNormal
 Resolution Bandwidth.....100KHz

7.4 Test Procedure

1. The EUT is placed on a turntable, which is 0.8m above ground plane.
2. The turntable shall be rotated for 360 degrees to determine the position of maximum emission level.
3. EUT is set 3m away from the receiving antenna, which is moved from 1m to 4m to find out the maximum emissions.
4. Maximum procedure was performed on the six highest emissions to ensure EUT compliance.
5. And also, each emission was to be maximized by changing the polarization of receiving antenna both horizontal and vertical.
6. Repeat above procedures until the measurements for all frequencies are complete.
7. The radiation measurements are tested under X-axis. The worst data were shown as follow.

7.5 Corrected Amplitude & Margin Calculation

The Corrected Amplitude is calculated by adding the Antenna Factor and Cable Factor, and subtracting the Amplifier Gain from the Amplitude reading. The basic equation is as follows:
 Corr. Ampl. = Indicated Reading + Antenna Factor + Cable Factor - Amplifier Gain
 The “Margin” column of the following data tables indicates the degree of compliance with the applicable limit. For example, a margin of -7dB means the emission is 7dB below the maximum limit for Class B. The equation for margin calculation is as follows:

$$\text{Margin} = \text{Corr. Ampl.} - \text{Limit}$$

7.6 Summary of Test Results

Test Frequency : Below 30MHz

After pretested, the emission below 30MHz is no more than background level. So the data is not shown in the report.

data transmitting mode (the worst data)

Test Frequency : 30MHz ~ 1000MHz

Antenna polarization: Vertical

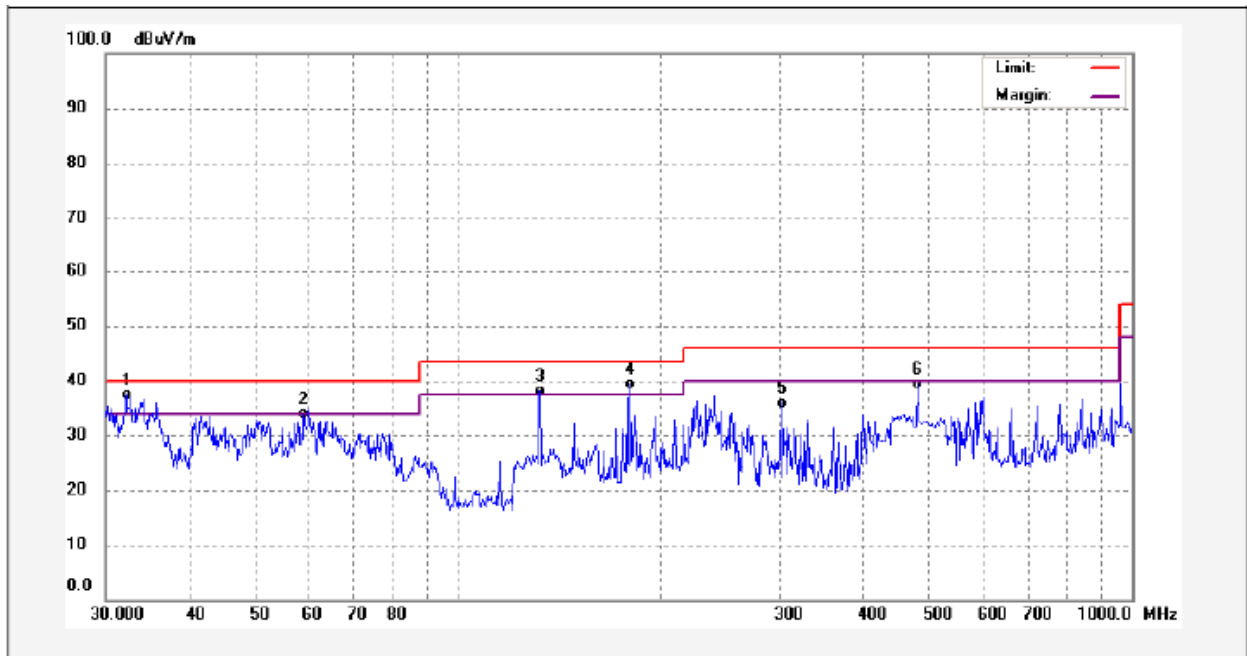

No.	Freq. (MHz)	Reading (dBuV/m)	Factor (dB)	Result (dBuV/m)	Limit (dBuV/m)	Margin (dB)	Detector	Remark
1	32.1794	56.95	-19.96	36.99	40.00	-3.01	QP	
2	59.0251	57.07	-23.28	33.79	40.00	-6.21	QP	
3	132.2204	60.36	-22.13	38.23	43.50	-5.27	QP	
4	180.0164	62.06	-22.58	39.48	43.50	-4.02	QP	
5	302.4811	55.58	-19.58	36.00	46.00	-10.00	QP	
6	480.5276	54.23	-14.80	39.43	46.00	-6.57	QP	

Antenna polarization: Horizontal

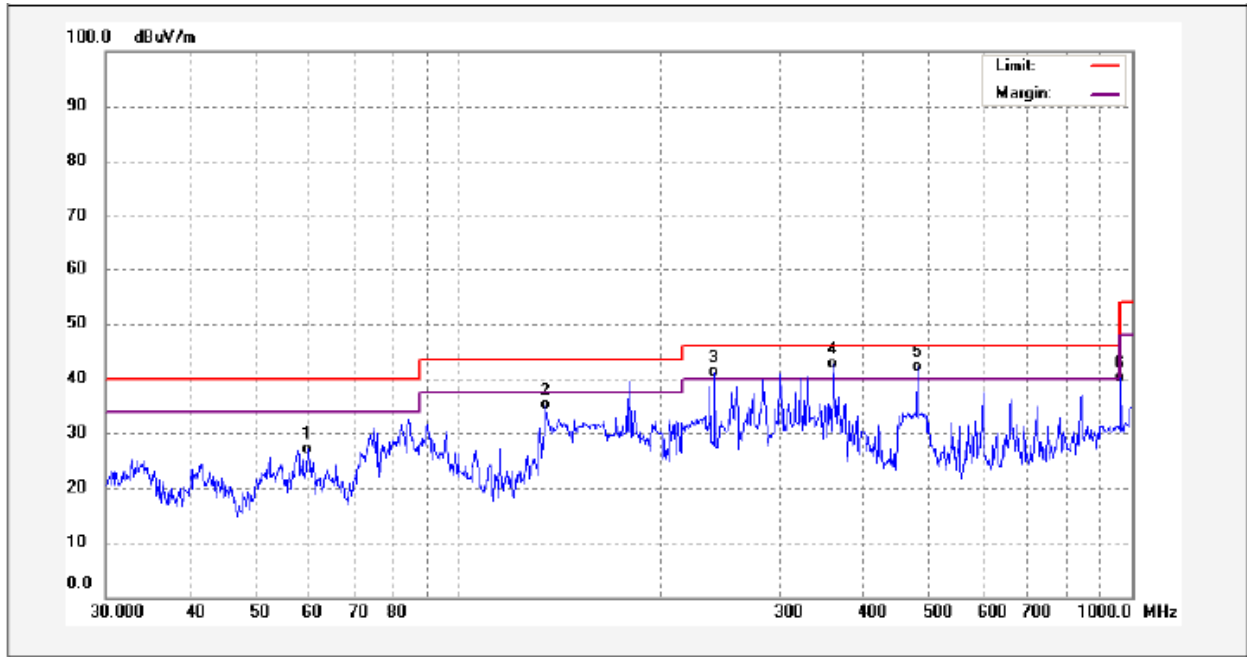

No.	Freq. (MHz)	Reading (dBuV/m)	Factor (dB)	Result (dBuV/m)	Limit (dBuV/m)	Margin (dB)	Detector	Remark
1	59.8588	48.46	-21.29	27.17	40.00	-12.83	QP	
2	134.5591	56.85	-21.76	35.09	43.50	-8.41	QP	
3	239.9873	62.93	-21.88	41.05	46.00	-4.95	QP	
4	360.4476	60.47	-17.96	42.51	46.00	-3.49	QP	
5	480.5276	56.77	-14.62	42.15	46.00	-3.85	QP	
6	962.1621	44.28	-4.24	40.04	54.00	-13.96	QP	

data transmitting mode (the worst data)

Test Frequency : 1000MHz ~ 6000MHz

Antenna polarization: Vertical

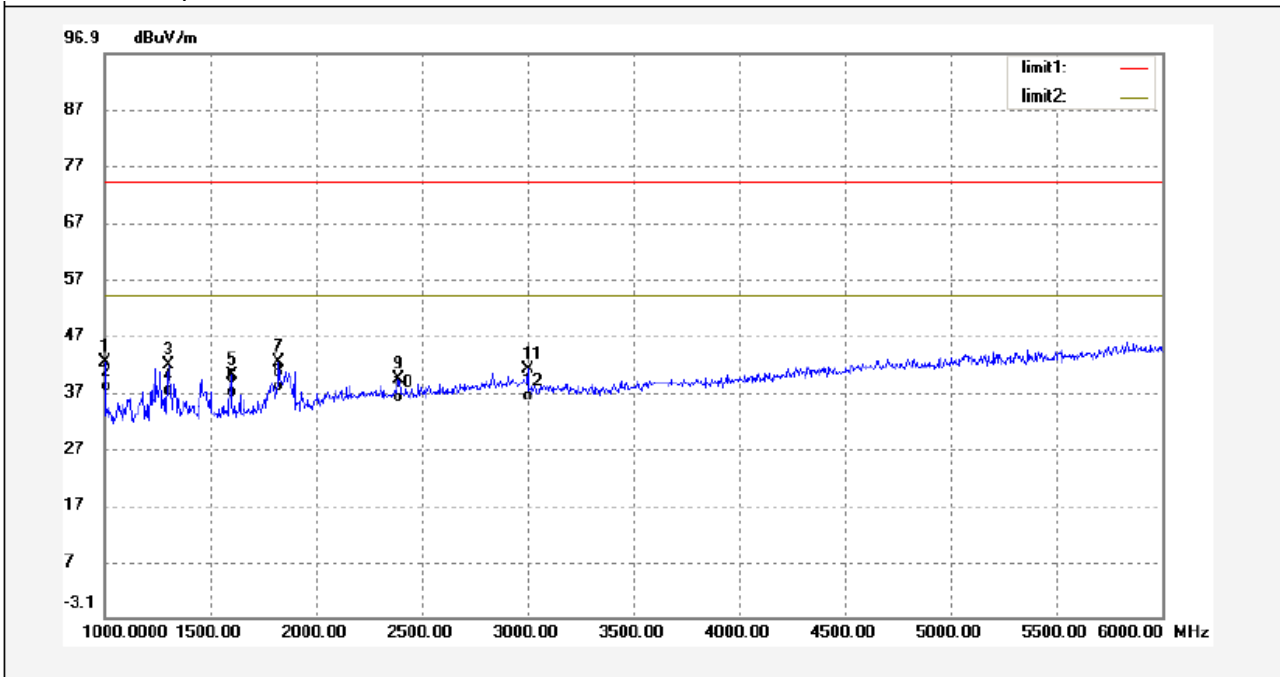

No.	Freq. (MHz)	Reading (dBuV/m)	Factor (dB)	Result (dBuV/m)	Limit (dBuV/m)	Margin (dB)	Detector	Remark
1	1000.0000	56.44	-14.08	42.36	74.00	-31.64	peak	
2	1000.0000	51.05	-14.08	36.97	54.00	-17.03	AVG	
3	1300.000	54.68	-12.90	41.78	74.00	-32.22	peak	
4	1300.000	49.14	-12.90	36.24	54.00	-17.76	AVG	
5	1600.000	53.20	-13.16	40.04	74.00	-33.96	peak	
6	1600.000	49.23	-13.16	36.07	54.00	-17.93	AVG	
7	1825.000	54.79	-12.39	42.40	74.00	-31.60	peak	
8	1825.000	49.44	-12.39	37.05	54.00	-16.95	AVG	
9	2390.000	48.49	-9.27	39.22	74.00	-34.78	peak	
10	2390.000	44.20	-9.27	34.93	54.00	-19.07	AVG	
11	3000.000	48.75	-7.73	41.02	74.00	-32.98	peak	
12	3000.000	43.04	-7.73	35.31	54.00	-18.69	AVG	

Antenna polarization: Horizontal

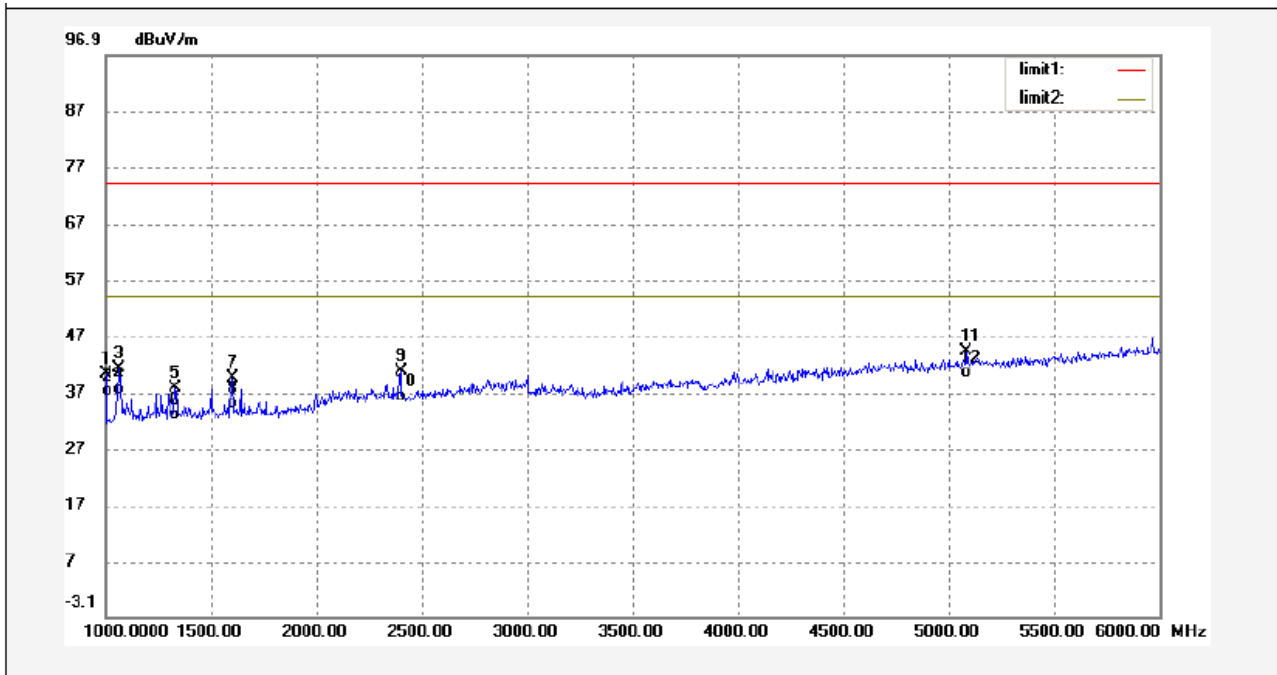

No.	Freq. (MHz)	Reading (dBuV/m)	Factor (dB)	Result (dBuV/m)	Limit (dBuV/m)	Margin (dB)	Detector	Remark
1	1000.0000	54.30	-14.08	40.22	74.00	-33.78	peak	
2	1000.0000	50.26	-14.08	36.18	54.00	-17.82	AVG	
3	1065.0000	55.42	-14.24	41.18	74.00	-32.82	peak	
4	1065.0000	50.78	-14.24	36.54	54.00	-17.46	AVG	
5	1330.0000	50.63	-12.77	37.86	74.00	-36.14	peak	
6	1330.0000	44.85	-12.77	32.08	54.00	-21.92	AVG	
7	1600.0000	52.77	-13.16	39.61	74.00	-34.39	peak	
8	1600.0000	47.31	-13.16	34.15	54.00	-19.85	AVG	
9	2400.0000	50.03	-9.28	40.75	74.00	-33.25	peak	
10	2400.0000	44.54	-9.28	35.26	54.00	-18.74	AVG	
11	5085.0000	46.57	-2.38	44.19	74.00	-29.81	peak	
12	5085.0000	41.99	-2.38	39.61	54.00	-14.39	AVG	

8 Photographs –Test Setup

8.1 Conducted Emissions



8.2 Radiated Emissions

Below 30MHz



From 30-1000MHz



From 1GHz-6GHz



9 Photographs - Constructional Details

9.1 EUT – External View

Refer to test report No.: WTS13S0503856E

9.2 EUT- Internal View

Refer to test report No.: WTS13S0503856E

==End of test report==