

Futaba®

6EX-2.4GHz



INSTRUCTION MANUAL **for Futaba 6EX-2.4GHz** 6-channel, FASST Radio control system for Airplane/helicopter

Futaba Corporation

Technical updates available at: <http://www.futaba-rc.com>



TABLE OF CONTENTS

<p>Introduction3</p> <p>Service3</p> <p>Usage Precautions.....3</p> <p>Contents and specifications.....4</p> <p>Glossary4</p> <p>Introduction to the 6EX-2.4GHz system5</p> <p>Transmitter controls and descriptions5</p> <p>Radio installation7</p> <p>Receiver and servo connections10</p> <p>Charging the Ni-Cd batteries11</p> <p>LCD and Programming controls12</p> <p>Programming the T6EX-2.4GHz radio.....14</p> <p style="padding-left: 20px;">MODL Model select function.....14</p> <p style="padding-left: 40px;">MODL Model select function14</p> <p style="padding-left: 40px;">REST Data reset function14</p> <p style="padding-left: 40px;">ACRO/HELI Model type select function15</p> <p style="padding-left: 40px;">TRNR Trainer function15</p> <p style="padding-left: 40px;">Model name settings.....16</p> <p style="padding-left: 40px;">REVR Servo reversing.....16</p> <p style="padding-left: 20px;">D/R Dual Rate and Exponential settings16</p> <p style="padding-left: 40px;">D/R Dual Rate settings.....16</p> <p style="padding-left: 40px;">EXPO Exponentials17</p> <p style="padding-left: 20px;">EPA End Point Adjustments.....17</p> <p style="padding-left: 20px;">TRIM Trim Settings18</p> <p style="padding-left: 20px;">FS Fail safe (Throttle channel only).....30</p> <p style="padding-left: 20px;">(ACRO functions)</p> <p style="padding-left: 40px;">PMX1 Programmable Mixer #119</p> <p style="padding-left: 40px;">PMX2 Programmable Mixer #219</p> <p style="padding-left: 40px;">FLPR Flaperon mixing20</p> <p style="padding-left: 40px;">FLTR Flap trim.....20</p> <p style="padding-left: 40px;">V-TL V-tail mixing21</p> <p style="padding-left: 40px;">ELVN Elevon mixing.....22</p>	<p style="padding-left: 20px;">(HELI functions)</p> <p style="padding-left: 40px;">N-TH Normal Throttle Curve24</p> <p style="padding-left: 40px;">N-PI Normal Pitch Curve.....24</p> <p style="padding-left: 40px;">I-TH Idle-Up Throttle Curve function.....24</p> <p style="padding-left: 40px;">I-PI Idle-Up Pitch Curve function25</p> <p style="padding-left: 40px;">HOLD Throttle hold function25</p> <p style="padding-left: 40px;">REVO Pitch - rudder mixing function.....26</p> <p style="padding-left: 40px;">GYRO Gyro mixing function.....26</p> <p style="padding-left: 40px;">SW-T Swash to throttle mixing.....28</p> <p style="padding-left: 40px;">SWSH Swashplate types selection & Swash AFR.....28</p> <p>Flow chart (ACRO)31</p> <p>Flow chart (HELI).....32</p> <p>Other T6EX-2.4GHz functions.....33</p> <p style="padding-left: 20px;">Trainer function33</p> <p style="padding-left: 20px;">Throttle cut function.....33</p> <p style="padding-left: 20px;">Adjustable-length control sticks34</p> <p style="padding-left: 20px;">Changing the stick mode.....34</p> <p>Flying safety guidelines34</p> <p>Flight preparation35</p> <p>Model Data Recording Sheets (ACRO).....36</p> <p>Model Data Recording Sheets (HELI)37</p>
--	--

INTRODUCTION

Thank you for purchasing the Futaba 6EX-2.4GHz FASST¹ digital proportional R/C airplane/helicopter system. If this is your first “computer” radio, rest assured that it is designed to make initial setup and field-tuning of your airplane/helicopter easier and more accurate than would be if using a “non-computer” radio. Although this is a **beginner** or **sport** system with the requirements of those flyers in mind, in order to make the best use of your Futaba 6EX-2.4GHz and to operate it safely, **you must carefully read all of the instructions.**

¹FASST: Futaba Advanced Spread Spectrum Technology

Suggestion: If, while reading the instructions, you are unclear of some of the procedures or functions and become “stuck,” continue to read on anyway. Often, the function or procedure will be explained again later in a different way providing another perspective from which to understand it. Another suggestion is to connect the battery, switch and servos to the receiver and actually operate the radio on your workbench as you make programming changes. Then, you’ll be able to see the effects of your programming inputs.

SERVICE

(in USA)

If any difficulties are encountered while setting up or operating your system, please consult the instruction manual first. For further assistance you may also refer to your hobby dealer, or contact the Futaba Service Center at the web site, fax number or telephone number below:

www.futaba-rc.com

Fax: (217) 398-7721

Telephone (8:00 am to 5:00 pm Central time Monday through Friday): (217) 398-8970, extension 2

If unable to resolve the problem, pack the system in its original container with a note enclosed and a **thorough, accurate** description of the problem(s). Include the following in your note:

- Symptoms.
- Any unusual mounting conditions.
- An inventory of items enclosed.
- The items that require repair.
- Your name, address, and telephone number.
- Include the warranty card if warranty service is requested.

Send your system to the authorized Futaba R/C Service Center at the address below:

**Futaba Service Center
3002 N Apollo Drive Suite 1
Champaign, IL 61822**



This product is to be used for sport and recreational flying of radio-control models only. Futaba is not responsible for the results of use of this product by the customer or for any alteration of this product, including modification or incorporation into other devices by third parties. Modification will void any warranty and is done at the owner's risk.

(USA only)

Protect the environment by disposing of rechargeable batteries responsibly. Throwing rechargeable batteries into the trash or municipal waste system is illegal in some areas. Call 1-800-8-BATTERY for information about Ni-Cd battery recycling in your area.

USAGE PRECAUTIONS

1. Special attention must be paid before turning on the transmitter while other models are running or flying because the 2.4GHz system may affect them.
2. If there is a special regulation for using 2.4GHz radio systems at your flying site, please obey all regulations to enjoy safe flying with your 2.4GHz system.
3. 2.4GHz is very different than the frequencies we currently use. Please keep the model in sight at all times as large objects can block the RF signal. Please keep in mind that objects such as wire fences and wire mesh will also cause loss of signal.
4. **NEVER** grip the transmitter antenna when flying as this degrades RF quality and cause loss of control.

CONTENTS AND SPECIFICATIONS

Transmitter: T6EX-2.4G

T6EX-2.4GHz Transmitter of FASST system.

Transmitting on 2.4GHz band.

Operating system: 2-stick, 6-channel system

Power supply: 9.6V NT8F600B Ni-Cd battery

Current drain: 170mA

Receiver: R606FS

6 channel receiver of FASST system.

Receiving on 2.4GHz band.

Power requirement: 4.8V or 6V (shared with servo)

Current drain: 80mA (at no signal)

Size: 1.64x1.08x0.36" (41.6x27.5x9.2mm)

Weight: 0.34oz. (9.8g)

Other components:

Switch harness

Instruction manual

*Specifications and ratings are subject to change without notice.

GLOSSARY

It will be helpful to understand the following terms before reading the rest of the manual. The terms are not in alphabetical order, but are in a logical order that prepares the reader for understanding the next term.

Reversing (servo reversing) - A function that allows the user to determine the direction of response of each servo. If, after hooking up the servos, a control on the model responds in the wrong direction, the user may change the servo's direction so the control responds correctly.

Throw - When speaking of a control surface (such as an elevator or aileron), the throw is the distance the surface moves. Control surface throw is usually measured at the trailing edge of the surface and is expressed in inches or millimeters. The model in the diagram has 1/2" [13mm] of up elevator throw. Throw can also refer to the distance a servo arm (or wheel) travels.

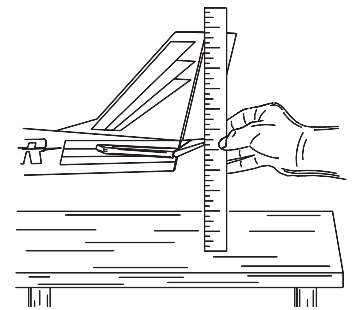

Dual rate (D/R) - On the 6EX-2.4GHz the dual rate switch allows you to instantly switch, in flight, between two different control throws for the aileron, elevator and rudder. Often, different control throws are required for different types of flying. ("Low" throws may be required for flying at high speeds where the model's response becomes more sensitive, and "high" throws may be required for aggressive aerobatic maneuvers or landing or flying at lower speeds where the model's response becomes less sensitive.)

End point adjustment (E.P.A.) - Sets the overall, maximum distance the servo rotates in either direction. (No matter where the dual rates are set, the servo will never travel beyond the limit set by the end point adjustment.)

Exponential - Normally, servos respond proportionally to control stick input from the transmitter (e.g., if the stick is moved halfway, the servo will move halfway). However, with "exponential," the servo can be made to move more or less than initial stick movement (less servo movement is more common). Exponentials are commonly used to "soften," or decrease initial servo travel for the ailerons, elevators and rudder. This way, initial control stick inputs from the pilot result in small servo movement for a smoother flying airplane.

(Dual rates adjust the **amount** of servo travel. Exponentials determine **where** most of the travel will occur.)

Mixing - Two (or more) servos can be made to operate together either by mechanically joining the wires (with a Y-connector) or by electronically "joining" them through programming functions in the transmitter. When servos are electronically joined via programming, they are said to be "mixed." Unlike joining servos with a Y-connector, when servos are mixed electronically they can be made to move in opposition. Additionally, each servo's end points can be independently set.

INTRODUCTION TO THE 6EX-2.4GHz SYSTEM

IMPORTANT! Always turn on the transmitter first, then the receiver. When turning off the system, always turn off the receiver first. The object is never to have the receiver on by itself. Otherwise, the servos or control surfaces could be damaged, or in the case of electric-powered models, the motor may unexpectedly turn on causing severe injury.

Transmitter

ACRO mode: External switches operate dual rates (D/R), landing gear, and trainer cord or “buddy-box” capabilities. Programming features include servo reversing and E.P.A on all channels, dual rates, exponentials and programmable mixing. Additionally, any one of four, factory-set, preprogrammed “wing-type” mixers including flaperon, V-tail, elevon mixing may be selected.

HELI mode: Dual rate (D/R), Idle up, Throttle hold, and Gyro sense can be operated by switch. Two different gyro senses can be set with Futaba GY401/502/611 Gyro on gyro function of this transmitter. Programming features include servo reversing and E.P.A on all channels, dual rates, exponentials, throttle curve, pitch curve, throttle hold, and pit to rudder mixing (REVO). Additionally, any one of three, factory-set, preprogrammed “swashplate type” mixers including three servo type 3-S/3-E may be selected.

Transmitter controls

The diagram and explanations briefly describe the functions of the Futaba T6EX-2.4GHz transmitter. Full instructions on how to operate the controls are provided beginning on page 14.

NOTE: The diagram shows a Mode 2 system as supplied. (More on flight modes on page 34).

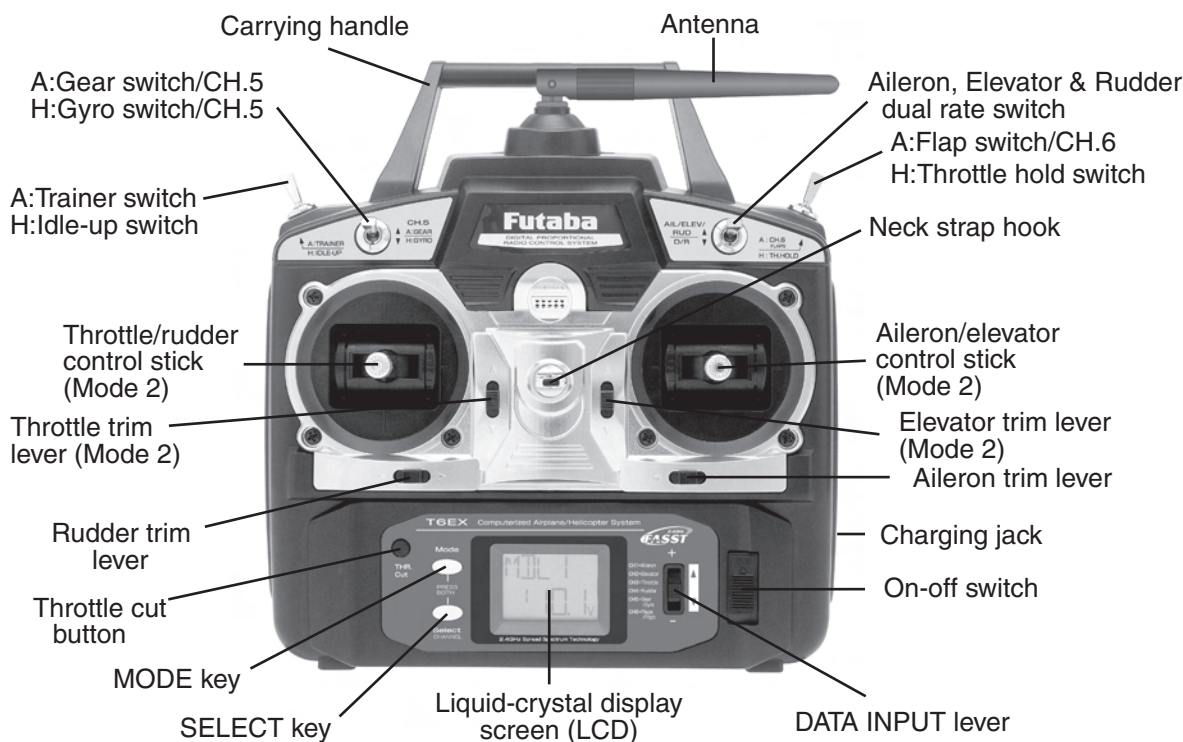

DESCRIPTIONS:

Aileron, Elevator and Rudder dual rate switch -

Use this switch to “flip” between two aileron, elevator and rudder control throw settings. The throws can be set up however you prefer, but generally, when the switch is “up” the throws are greater (“high rate”) and when the switch is “down” the throws are less (“low rate”). This switch also flips between exponential rates (if used).

A: Flap switch/Channel 6 - This switch operates the servo connected to channel 6 in the receiver if your model has flaps this is the control used to operate them.

H: Throttle – hold switch - This switch operates to hold the engine in the idling position and disengaged it from the Throttle Stick. It is commonly used to practice auto-rotation.

Neck strap hook - Mounting point for optional neck strap.

Aileron/elevator control stick - Operates the servos connected to channel 1 (aileron) and channel 2 (elevator) in the receiver.

Trim levers (all) - Used to shift the neutral or center position of each servo as labeled in the diagram. Once either trim lever is operated, the trim position is displayed on the LCD screen. Also once either edit key is operated, all trim positions are displayed sequentially on the LCD screen.

NOTE: The throttle trim lever is intended for fine tuning the throttle servo when the engine is at idle. Throttle trim does not affect the throttle servo when the throttle control stick is all the way up (so idle r.p.m. can be adjusted without affecting throttle settings through the rest of the stick movement).

Charging jack - Port for charging the transmitter batteries with the included battery charger.

On/off switch

DATA INPUT lever - Used to change the values of the various functions displayed on the LCD screen

Liquid – crystal display screen (LCD) - Displays programming modes and values entered.

MODE key - Used to scroll through and display the “11-14” different functions.

SELECT key - Used to display the values for the current function.

Throttle – cut button - To use the throttle-cut function, lower the throttle stick all the way, then push the throttle-cut button to fully close the carburetor and shut of the engine.

Throttle/rudder control stick - Operates the servos connected to channel 3 (throttle) and channel 4 (rudder) in the receiver.

A:Trainer switch - Operates the trainer functions. To operate as a trainer switch the transmitter must be connected to another transmitter via. a trainer cord (available separately).

H:Idle – up switch - This switch operates to change the fight condition which is set the throttle curve and pitch curve of mid air maneuvers (rolls, loops, stall turns) and 3D flight.

A:Retractable landing gear switch/Channel 5 - Switch operates the servo connected to channel 5 in the receiver if your model has retractable landing gear this is the control used to extend and retract the gear.

H:Gyro switch/Channel 5 - You can connect the sense adjust connector to the channel 5 of the receiver to operate the gyro which has two different sense. Also if you use Futaba GY401/502/611 Gyro, two different gyro senses setting on gyro function in this transmitter can be call by this switch.

Antenna - Radiates signals to the receiver. **NEVER** point at the model when flying! See page__ for detail.

RADIO INSTALLATION

Follow these guidelines to properly mount the servos, receiver and battery.

- Make certain the **alignment tab** on the battery, switch and servo connectors is oriented correctly and “keys” into the corresponding notch in the receiver or connectors before plugging them in. When unplugging connectors, never pull on the wires. Always pull on the plastic connector instead.
- If any servo wires are not long enough to reach the receiver, servo extension wires (available separately) may be used.

- Always mount the servos with the supplied **rubber grommets**. Do not over tighten the screws. No part of the servo casing should contact the mounting rails, servo tray or any other part of the airplane/helicopter structure. Otherwise, vibration will be transmitted to the servo causing premature wear and/or servo failure.

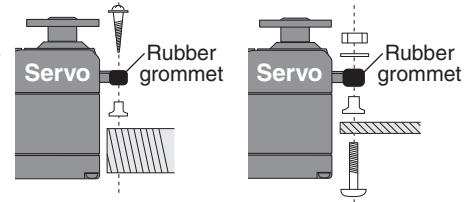

- Note the small numbers (1, 2, 3, 4) molded into each arm on the Futaba 4-arm servo arms. The numbers indicate how many degrees each arm is “off” from 90 degrees to correct for minute manufacturing deviations from servo to servo.

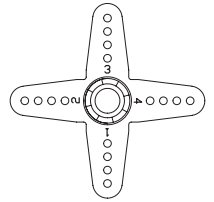

- To center the servos, connect them to the receiver and turn on the transmitter and receiver. Center the trims on the transmitter, then find the arm that will be perpendicular to the pushrod when placed on the servo.

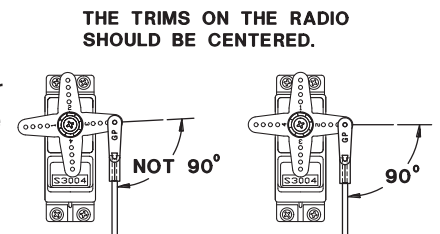

- After the servos are installed, operate each servo over its full travel and check that the pushrods and servo arms do not bind or contact each other. Also make sure the controls do not require excess force to operate. If there is an objectionable buzzing sound coming from a servo, there is probably too much resistance in the control. Find and correct the problem. Even if there is no servo damage, excess battery drain will result.
- Use the **mounting plate** from the receiver on/off switch as a template for the cutout and screw holes. Mount the switch on the side of the fuselage opposite the engine exhaust, and where it won't be inadvertently turned on or off during handling or storage. Be certain the switch moves without restriction and “snaps” from ON to OFF, and that the cutout allows **full motion** of the switch in **both** directions.
- When you install the switch harness to the helicopter, please use switch cover. Generally sandwich the frame by switch and switch cover and securely tighten the screws. It might be different installations on model by model. In that case, please follow the model instruction manual.
- To prevent the servo lead wires from being broken by vibration during flight, provide a margin so that the wire sticks out slightly and fasten it at suitable points. In addition, periodically check the wire during daily maintenance.

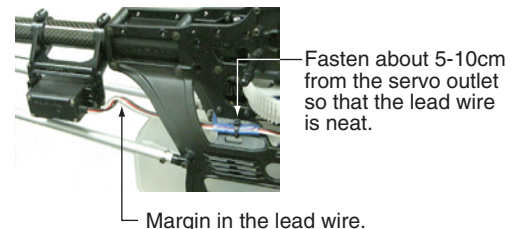

- **IMPORTANT:** Since the 2.4GHz have different characteristics than that of the conventional frequencies of 27MHz to 72MHz, please read this section carefully and enjoy your safety flight with the 2.4GHz system.

Receiver's Antenna Installation:

- The R606FS has two antennas. These antennas have a diversity function to decrease the chance of a receiving error.
- Since the wave length of the 2.4GHz is much shorter than that of the conventional frequencies 27MHz and 72MHz, it is very susceptible to loss of signal which results in a receiving error. In order to avoid this phenomenon, the R606FS adopted a diversity antenna system.
- To obtain the best results of the diversity function, please refer to the following instructions;

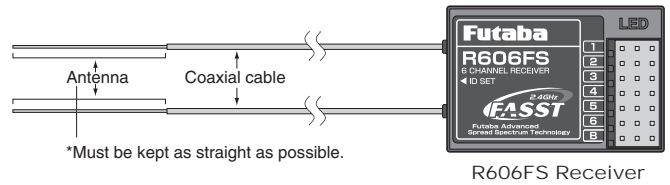

1. The two antennas must be kept as straight as possible otherwise it will reduce the effective range.
2. The two antennas should be placed at 90 degrees to each other.

This is not a critical figure, but the most important thing is to keep the antennas away from each other as much as possible.

Larger models can have large metal objects that can attenuate the RF signal. In this case the antennas should be placed at both sides of the model then the best RF signal condition is obtained at any flying attitude.

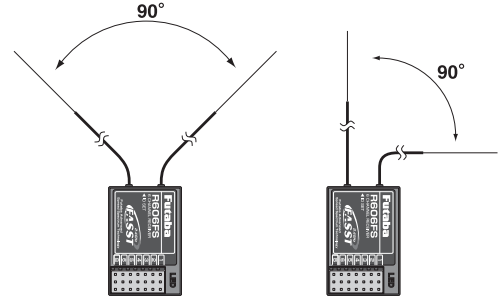

3. The antennas must be kept away from conductive materials, such as metal and carbon by at least a half inch. The coaxial part of the antennas does not need to follow these guidelines, but do not bend it in a small radius.
4. Keep the antennas away from the motor, ESC, and other noise sources as much as possible.

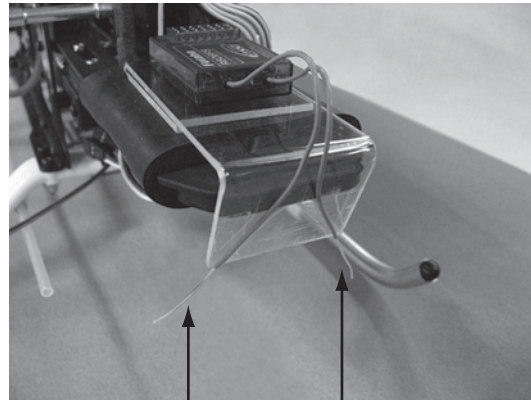

- *The two antennas should be placed at 90 degrees to each other.
- *The main purpose of the photo demonstrates how the antenna should be placed. For actual installation the receiver must be wrapped with a sponge or placed with floating material to protect from vibration.

- The receiver contains precision electronic parts. It is the most delicate radio component on-board the model and should be protected from vibration, shock and temperature extremes. To protect the receiver, wrap it in R/C foam rubber or other vibration-absorbing material. If appropriate, waterproof the receiver by placing it in a plastic bag and closing the open end with a rubber band before wrapping it in foam. If moisture enters the receiver, intermittent operation or a failure may result. Wrapping the receiver in a plastic bag also protects it from fuel and exhaust residue which, in some models, can work its way into the fuselage.

Transmitter Antenna

1. The transmitter antenna is adjustable so please make sure that the antenna is never pointed directly at the model when flying as this creates a weak signal for the receiver.
2. Keep the antenna perpendicular to the transmitter's face to create a better RF condition for the receiver. Of course this depends on how you hold the transmitter, but in most cases by adjusting the transmitter antenna so that it is perpendicular to the face will give the best results. Please adjust the transmitter antenna to the way you hold the transmitter.
3. **NEVER** grip the antenna when flying as this degrades RF quality.



Range Check the Radio

A range check **must** be performed before the **first** flight of a new model. It is not necessary to do a range check before every flight (but is not a bad idea to perform a range check before the first flight of each day). A range check is the final opportunity to reveal any radio malfunctions, and to be certain the system has adequate operational range.

1. We have installed a special "Power Down Mode" for doing a ground range check. To activate the "Power Down Mode" please hold down the Mode key and then turn the transmitter switch on. During this mode, the RF power is reduced so the range test can be performed. When this mode is active the red LED on the back of the transmitter starts blinking and the green LED is solid. In addition, when the mode is activated the transmitter gives users a warning with a beep sound every 3 seconds, and visual indication.
2. Walk away from the model while simultaneously operating the controls. Have an assistant stand by the model and signal what the controls are doing to confirm that they operate correctly. You should be able to walk approximately 30 - 50 paces from the model without losing control.
3. If everything operates correctly, return to the model. Set the transmitter in a safe, yet accessible location so it will be within reach after starting the engine. Be certain the throttle stick is all the way **down**, then start the engine. Perform another range check with your assistant holding the plane and the engine running at various speeds. If the servos jitter or move inadvertently, there may be a problem. **Do not fly** the plane! Look for loose servo connections or binding pushrods. Also be certain that the battery has been fully charged.
4. The "Power Down Mode" continues for 60 seconds and after that the power will go back to the normal level.
To exit the "Power Down Mode" before the 60 seconds, press the "MODE" key again. This mode is available 1 time only so if you need to re-use this function the transmitter power must be cycled.
5. **NEVER** start flying when the "Power Down Mode" is active.

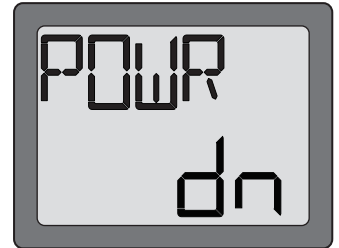

Link Procedure

Each transmitter has an individually assigned, unique ID code. In order to start operation, the receiver must be linked with the ID code of the transmitter with which it is being paired. Once the link is made, the ID code is stored in the receiver and no further linking is necessary unless the receiver is to be used with another transmitter. (For T/R set, the link is already done at factory. When you purchased another R606FS, this procedure is necessary; otherwise the receiver will not work.

1. Place the transmitter and the receiver close to each other within one (1) meter
2. Turn on the transmitter.
3. Check the LED that is placed on the back side of the transmitter to see if the RF signal is active. When the green LED is ON solid, the RF signal is being sent.
4. Turn on the receiver.
5. Press down the "ID SET" switch for more than one second, and release the switch. The receiver starts the linking operation.
6. When the linking is complete, the LED in the receiver will change to solid green. Please confirm that the servos will now operate by your transmitter. Please refer to the table below for the LED status of the receiver's condition.

No signal reception	Red : On
Receiving signals	Green: On
Receiving signals, but ID is unmatched.	Green: Blink
Unrecoverable failure (EEPROM, etc.)	Red and Green turn on alternatively.

RECEIVER AND SERVO CONNECTIONS

Connect the servos to the receiver to perform the functions indicated:

Receiver output channel	Function	
	Aircraft (ACRO)	Helicopter (HELI)
1	Aileron -or-right flaperon -or-right elevon (for tailless models)	Aileron
2	Elevator -or-left ruddervator (for V-tail models) -or-left elevon (for tailless models)	Elevator
3	Throttle	Throttle
4	Rudder -or-right ruddervator (for V-tail models)	Rudder
5	Retractable landing gear	Gyro sensitivity
6	Flap -or-left flaperon	Pitch
B	Receiver on/off switch (the plug colored red goes into the receiver)	Receiver on/off switch (the plug colored red goes into the receiver)

The diagram shown is for aircraft models only. Additional servos may have to be purchased separately.

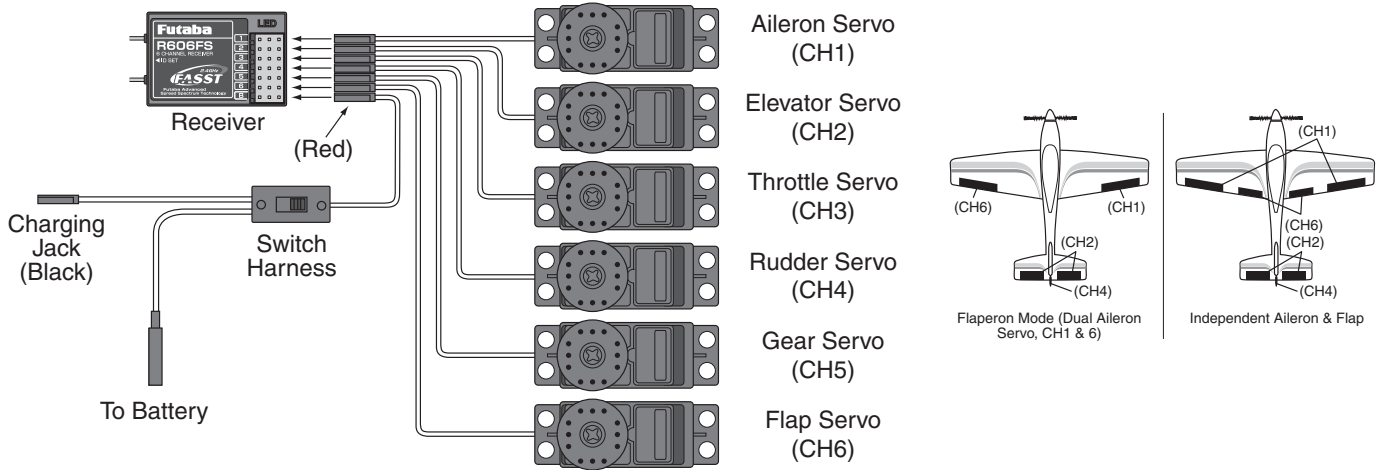

The diagram shown is for helicopter models only. It is necessary to buy an additional gyro separately.

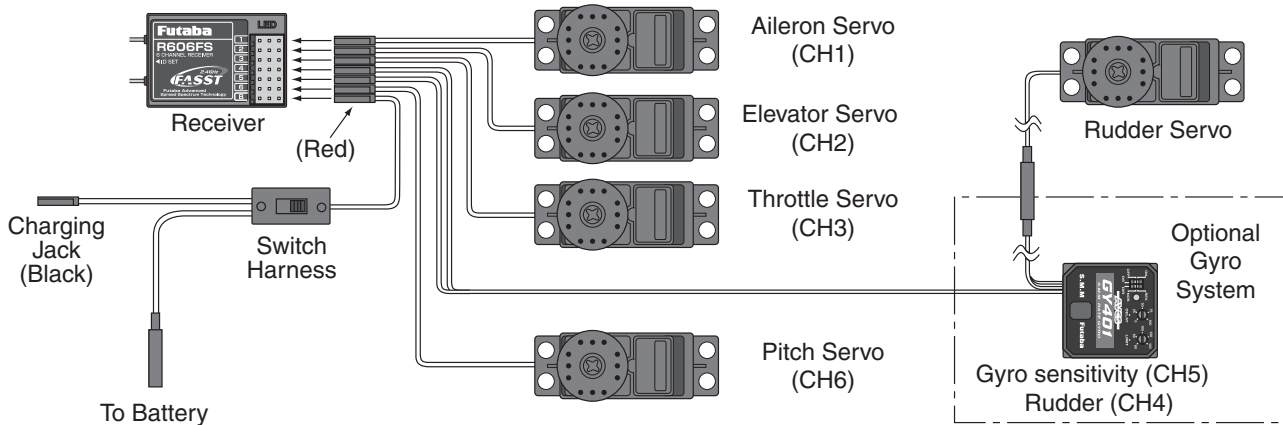

CHARGING THE NI-Cd BATTERIES

The transmitter batteries included with your 6EX-2.4GHz system are rechargeable, Ni-Cd (nickel-cadmium, pronounced ni-kad) batteries. Ni-Cd batteries require special care and charging. **Read the charging instructions carefully.**

NOTE: The batteries are supplied partially charged, but will require a full, overnight charge before the model may be flown.

1. Connect the **transmitter charging cord** coming from the A/C wall charger to the charge jack in the right side of the transmitter case. The receiver charging cord may be connected to the batteries two different ways: The charge cord may be connected directly to the battery pack, or to the vacant charge connector (black) coming from the on/off switch in the model. Charging “through the switch” is preferred as there will be no need to disconnect the battery.
2. Plug the A/C wall charger into a wall outlet. **Note:** If the wall outlet can be turned off by a switch in the room, be certain the switch remains on after leaving the room. Otherwise, the batteries will not be charged!
3. The LEDs (light-emitting diodes) should light red, indicating that current is flowing and the batteries are being charged. Discharged batteries will take about 15 hours to fully charge. If using an aftermarket fast charger, **be certain to follow the manufacturer’s instructions provided with the charger** so you do not overcharge the batteries. **NEVER** charge the batteries at a rate higher than 1,000mAh. The batteries should also be discharged periodically to prevent a condition called “memory.” If, for example, only two flights are made each time you go flying, the batteries will not have “reached” very far down into their full capacity. After doing this several times the batteries will “remember” and eventually “think” they can supply only enough power for two flights. After two flights the batteries may not provide enough power to operate the system, thus causing a crash. To erase any potential memory, cycle the batteries by discharging, then charging them with a commercial battery cyclor, or leave the system on and exercise the servos by moving the transmitter sticks until the servos are moving very slowly, indicating that the battery is discharged. Cycling should be done every one to two months, even during the winter or periods of long storage. If using a cyclor with a readout, note the capacity after the batteries have been cycled. If there is a noticeable drop in capacity the batteries should be replaced.

Note: Charging your batteries with the included Futaba A/C battery charger is always safe. However, fast-charging with an aftermarket charger is acceptable as long as you know how to properly operate the charger. **NEVER** charge at a rate higher than 1,000 mAh (1 Amp). If not done correctly, fast-charging can damage the batteries.

LIQUID CHIP DISPLAY (LCD) & PROGRAMMING CONTROLS

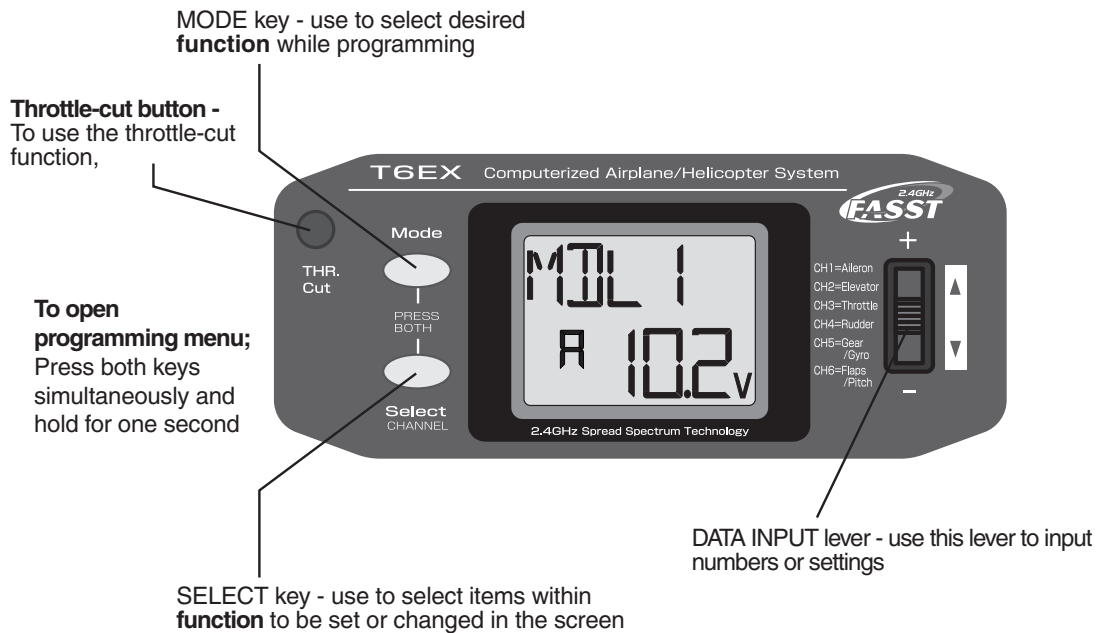

LCD display screen

When the transmitter is **initially** turned on, the **model type, model memory name, modulation type** and **transmitter battery voltage** are displayed on the LCD screen. When prompted by the user, the functions and settings stored in the memory can also be read on the screen. The user accesses the different functions using the MODE and SELECT keys and changes the values and settings using the DATA INPUT lever. (This is called programming!)

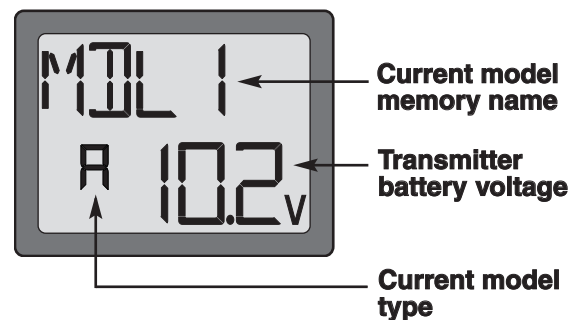

Note: Feel free to explore by scrolling through the programs and viewing the displays using the MODE and SELECT keys. The MODE and SELECT keys only determine what will be displayed on the screen and will not change any of the settings. Only when using the DATA INPUT lever will you be able to change any of the settings.

Model name

The Futaba T6EX-2.4GHz stores model memories for six models. This means all the data (control throws, trims, end points, etc.) for up to six different models can be stored in the transmitter and activated at any time (depending upon which model you choose to fly that day). This eliminates the requirement for reconfiguring the transmitter each time you decide to fly a different model with it! When the transmitter is turned on the **model type, model name, modulation** and the **transmitter voltage** will be indicated on the LCD screen. Before every flight **BE CERTAIN** that the correct model name for the model you intend to fly appears on the screen. If the transmitter is not operating the correct model, some (or all) of the controls could be reversed and the travels and trims will be wrong.

Flying a model with the wrong program will result in a crash, so always **be certain** the model name in the transmitter is correct. One way to ensure this is to write the corresponding model name directly on the airplane or helicopter, or attach a list to the bottom or back of the transmitter.

Transmitter battery voltage

In addition to the model type, the LCD screen also displays the **transmitter battery voltage**. When the voltage goes below approximately **8.5 Volts** the “battery” icon will **flash** and the low-battery alarm will continuously beep until the transmitter is turned off. When the low-battery alarm sounds you will have approximately four minutes (or less) to land your model before losing control. You should never allow the transmitter voltage to become this low while flying, but if it does, land **immediately**.

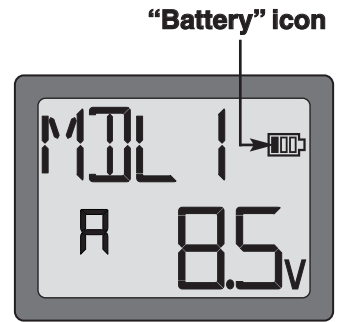

Note: When the transmitter voltage reads **8.9 Volts** you will still have approximately ten minutes (or less) before losing operational range, so this is the recommended **absolute minimum** voltage. If the transmitter ever reaches 8.9 Volts, land as soon as safely possible. A more reasonable margin of safety would be to quit flying for the day (or recharge the batteries) when the transmitter battery.

SUGGESTED GUIDELINES

- 9.4 Volts - No more flying until recharge.
- 8.9 Volts - Land as soon as safely possible.
- 8.5 Volts - **Emergency- Land immediately!**

Mixer alert warning

The **Mixer alert** warning is displayed to alert you whenever you turn on the transmitter with any of the mixing switches active. This warning will disappear when the offending switch or control is deactivated. Switches for which warnings will be issued at power-up and model selection are Throttle hold switch or Idle-up switch.



Backup error

The **Backup error** warning occurs when the transmitter memory is lost for any reason. If this occurs, all of the data will be reset when the power is turn on again.

When the Backup error occurs, initialization starts from model number 6 to 1.

The model number on the left of the screen changes from 6 to 5, to 4, to 3, to 2, to 1, and finally the number disappears. The disappearance of the model number indicates that the initialization has been completed. Now you can turn off the power of the transmitter. Please do NOT turn off the power during the initialization; otherwise initialization will restart when you turn on the power.

Do not fly when this message is displayed: all programming has been erased and is not available. Return your transmitter to Futaba service.



PROGRAMMING THE 6EX-2.4GHz RADIO

Anytime you wish to **view** or **change** any of the current settings in the transmitter, the programming mode must first be entered by, of course, turning on the power, then by pressing the **“MODE”** and **“SELECT”** keys simultaneously and holding them down for one second. Once in the program the MODE key will be used to scroll through each of the functions (**Model type ACRO**: model select/ data reset/ model type select/ modulation select/ trainer/ model name, reversing, dual rates/ exponentials, end point adjustments, trim, programmable mix 1, programmable mix 2, flaperon mixing, flap trim, v-tail mixing, elevon mixing, and failsafe **Model type HELI**: model select/ data reset/ model type select/ modulation select/ model name, reversing, dual rates/ exponentials, end point adjustments, trim, normal throttle curve, normal pitch curve, idle-up throttle curve, idle-up pitch curve, throttle hold, revolution mixing, gyro sensitivity, swash-throttle mixing/ swashplate types, and failsafe) and the SELECT key will be used to view the settings within the function. When a data change is actually required the **“DATA INPUT”** lever will be used to increase or decrease the value of the item displayed, thus making the change.

You can return to the home screen (where the model name and battery voltage is displayed) by pressing the MODE and SELECT keys simultaneously and holding them down for one second.

Note: The functions are listed and described in the order that they appear in the transmitter. Read all the way through the programming instructions before setting up your model (if you won't be using any of the mixing functions for a while you can read those instructions when ready). Refer to the FLOW CHART on page 31(ACRO) or page 32(HELI) as well.

Model Select / Data Reset / Model Type Select / Modulation Select / Trainer / Model Name

MODL Model select function

To select model memory:

1. Access the Model Select function in the programming mode (by pressing the MODE and SELECT keys simultaneously and holding them down for one second). The number for the current, active model will be blinking.
2. To activate a different model memory press the DATA INPUT lever and hold it down for 0.5 seconds until the desired model number appears.
3. Now the model has been selected. All programming inputs from this point forward will affect only the model number on the screen (until another model number is selected).

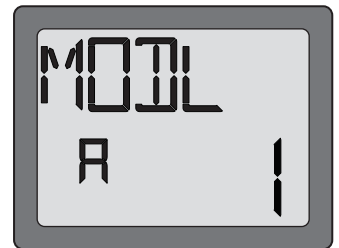

REST Data reset function

All the data for any model memory can be reset to the original factory defaults. Often this function is done to get a “fresh start” and clear the memory before inputting new model settings.

To reset data:

1. Access the Model Select function in the programming mode (by pressing the MODE and SELECT keys simultaneously and holding them down for one second). To select the model memory you wish to reset press the DATA INPUT lever and hold it down for 0.5 seconds until the desired model number appears.
2. Once the desired model number is displayed on the screen, press the SELECT key. A **“REST”** will appear on the screen.
3. Push DATA INPUT upward or downward for about 2 seconds to clear and reset the memory. **“CLR”** blinks first, and then it stops blinking with a sound. Now the model data is reset to the initial setting that is the default value set at the factory.



The existing modulation and swashplate type settings are not reset. If the power switch is turned off while reset is underway, the data may not be reset.

CAUTION: Resetting the current model memory will permanently erase **ALL** programming information for that model. The data cannot be recovered (unless you recorded it on a Model Data Recording Sheet in the back of this manual). Do not reset the model unless you are certain you want to clear-out that memory and start from scratch.

When actually setting up a model you should have the model in front of you with the power on so you can actually see the effects of your programming inputs and measure the control throws.

ACRO/HELI Model type select function

The Model type select function is used to select the **ACRO** or **HELI** mode of model type.

ACRO: Powered aircraft memory type (with multiple wing and tail configurations. See Wing mixing type selection for further information, p20.)

HELI: Helicopter memory type (with three helicopter swashplate type. See Swashplate types selection for further information, p28.)

CAUTION: Before doing anything else to set up your aircraft, first you must decide Model type (include wing mixing type or swashplate type) best fits this particular aircraft.

To select model type:

1. Access the Model Select function in the programming mode (by pressing the MODE and SELECT keys simultaneously and holding them down for one second). To select the model memory you wish to select model type press the DATA INPUT lever and hold it down for 0.5 seconds until the desired model number appears.
2. Push SELECT key twice after seeing on the screen the model memory where you want to select model type, then you will see “ACRO” or “HELI” on the screen.
3. To change model type, push the DATA INPUT lever and hold it down for about two seconds. “HL” and “AC” blinks first, and then it stops blinking with a sound. The current model type “**ACRO**” or “**HELI**” is displayed.



TRNR Trainer function (ACRO only)

The Trainer function is used to activate the trainer switch each model memory as the instructors' transmitter. See Trainer switch for further information, p33.

To activate trainer function:

1. Access the Model Select function in the programming mode (by pressing the MODE and SELECT keys simultaneously and holding them down for one second). To select the model memory you wish to activate trainer function press the DATA INPUT lever and hold it down for 0.5 seconds until the desired model number appears.
2. Push SELECT key four times after seeing on the screen the model memory where you want to activate trainer function, then you will see “TRNR” on the screen.
3. To activate the function, push the DATA INPUT lever up for 0.5 seconds. The “**ON**” is displayed. To inhibit the function, push the DATA INPUT lever down for 0.5 seconds. The “**INH**” is displayed.

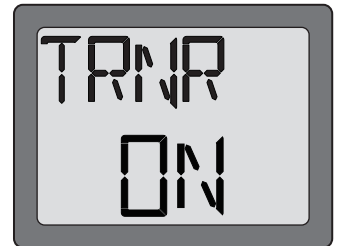

Model name function

Assign a name to the model memory. By giving each model a name that is immediately recognizable, you can quickly select the correct model, and minimize the chance of flying wrong model memory that could lead crash.

To assign a name

1. Access the Model Select function in the programming mode (by pressing the MODE and SELECT keys simultaneously and holding them down for one second). To select the model number you wish to change press the DATA INPUT lever and hold it down for 0.5 seconds until the desired model number appears..
2. Push SELECT key five times after seeing on the screen the model memory where you want to set the model name, then you will see the model name on the screen.
3. Choose a character for the first digit by using DATA INPUT lever. Then move to the next digit by pressing the SELECT key and choose a character in the same way. Continue choosing characters for the third and fourth digits. You can use up to four characters for the name.

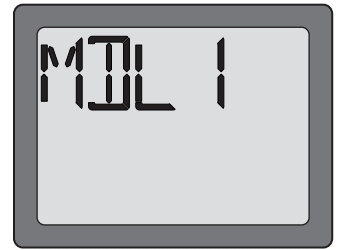

REVR Servo Reversing

The servo reversing function is used to change the direction that a servo responds to a control input from the transmitter (stick or switch). After using the reversing function, check **all** the controls on the model to **be certain** they are operating in the correct direction and that you did not inadvertently reverse a servo other than the one intended. Reversing the wrong servo (and not checking the response of the controls before each flight) may be the most common cause of a crash!

To reverse a servo:

1. Enter the programming mode and use the MODE key to access the **REVR** function.
2. Use the SELECT key to select the channel you wish to reverse.
3. Push the DATA INPUT lever downward for 0.5 seconds to reverse the servo (REV), or push the lever upward for 0.5 seconds to make the servo operate normally (NOR). The arrow will indicate the condition of the servo (normal or reversed).
4. Use the SELECT key to display other channels to be reversed.

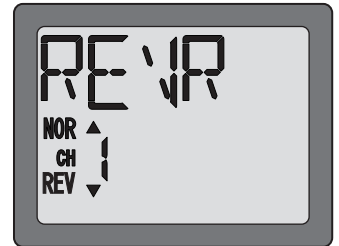

Dual Rates / Exponential Settings

The aileron, elevator and rudder dual rates on the 6EXHP are simultaneously activated by the dual rate switch. The amount of travel decrease for each control may be set between 0% and 100% of the values set for the end points (explained in End Point Adjustment on page 17).

Note: It is possible to set a dual rate value to zero, thus causing no response from that channel. If the dual rates are inadvertently set to zero, a crash could result.

Note: When performing initial model setup, the E.P.A.s should be set **prior to** setting the dual rates. When setting the E.P.A.s for the first time on a new model, the dual rates should be set to 100%.

D/R Dual Rate Settings

To set the dual rates:

1. Enter the programming mode. Access the **"D/R"** screen with the MODE key.
2. Select the channel to be adjusted (1-aileron, 2-elevator, 4-rudder) by pressing the SELECT key until the desired channel number the left side on the screen. Note: If a **"EXPO"** will appear on the screen, you have pressed the SELECT key too many times and displayed the values for the exponentials (explained later). Press the SELECT key to return to the dual rate values.
3. Place the dual rate switch in the desired position for the value you wish to change. (Generally, pilots prefer to have the switch in the "up" position for the high rate, and in the "down" position for the low rate.)
4. Change the dual rate value using the DATA INPUT lever until the desired control throw is achieved. If you wish to change the control throw when the switch is in the other position as well, flip the switch, then use the DATA INPUT lever to change

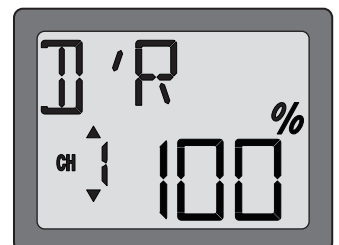

the throw.

- Repeat the procedure for the other dual rate (channel 2-elevator, 4-rudder).

EXPO Exponential Settings

The “exponentials” are in the same function as the dual rates. (Pressing the MODE key will take you to the next function which is End Point Adjustments). The same as dual rates, “expos” can be set for both switch positions. Negative exponential (-) decreases initial servo movement. Positive exponential (+) increases initial servo movement. The exponential “curve” may be set anywhere between -100% and +100%.

To set the exponentials:

- Enter the programming mode. Access the “D/R” screen with the MODE key.
- Access the “EXPO” screen with the SELECT key.
- Select the channel (1-aileron, 2-elevator, 4-rudder) you wish to set by pressing the SELECT key. The active channel number will be displayed on the screen. Note: If a “D/R” will appear on the screen, you have pressed the SELECT key too many times and displayed the values for the D/R (dual rate values). Press the SELECT key to return to the exponentials.
- Position the dual rate switch where desired for the value you wish to change.
- Enter the amount of exponential with the DATA INPUT lever. (As stated above, an exponential value with a “-” in front of it makes the initial servo movement less, or “softer.”)
- Flip the switch to the other position to enter the exponential value for that switch position.
- Repeat for the settings on the other channel.

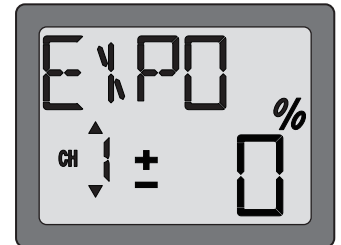

EPA End Point Adjustment

Note: Since changing the “end points” will also change the dual rates, the end points should be set prior to setting the dual rates. If you set the dual rates first, and then go back and change the end points, the dual rate throws will also change.

The EPA function is designed to “fine tune” the servo throws in cases where changing the pushrod hookup will not achieve the correct throw. The pushrods should first be connected to the servo arms and control horns so that the correct, or near correct control surface throw will be achieved. THEN the EPAs may be used to make small changes in the servo throw until the desired control throw is achieved. The control throws should be set up so that the “end points” are as near to 100% as possible. If the EPA values must be set below 70% or above 120% to get the desired throw, you should strongly consider changing the pushrod connections so the values can be set closer to 100%. (When the EPA is set to 100% the maximum servo throw for channels 1, 2, 3 & 4 is approximately 40° and approximately 55° for channels 5 & 6.)

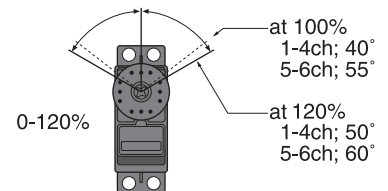

To set the end points:

- Enter the programming mode and use the MODE key to access the “EPA” screen. The channel number being adjusted will be on the left side of the screen and the “%” symbol will be flashing.
- To change the RIGHT aileron throw move the aileron stick to the right, then push the DATA INPUT lever up or down to change the value and the throw.
- Move the stick to the left and use the DATA INPUT lever to change the LEFT aileron throw.
- Use the SELECT key to display the other channels and set the other end points. Notice that moving the stick (or switch or dial) from one end to the other changes the value displayed and the position of the arrow for that “end” of the control input.

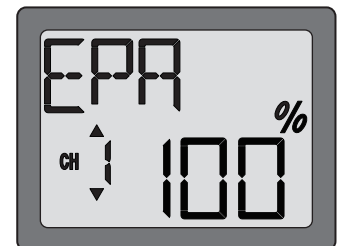

TRIM Trim Settings

There are four trim levers (“trims”) on the front of the transmitter. Three of the trims are for adjusting the neutral position of the aileron, elevator and rudder servos. The fourth trim is for setting the idle r.p.m. of the engine when the throttle stick is all the way down. The intended use of the trims is to make small servo adjustments, in flight, to get the model properly “trimmed” (so it will fly straight-and-level). Because the trims are intended to be used while the model is in flight, you do not have to “enter the program” to adjust the trims. Simply push or pull on the trim levers while flying and the neutral position of the servos will shift. Keep in mind that you should start out with the control surfaces centered when the servos are centered and the trims are “zeroed” (or near zero). **THEN** you can adjust the trims once airborne.

Center the servos:

1. Turn on the transmitter and receiver. Operate the controls to make sure the servos respond in the correct direction. Use the reversing function to reverse any servos necessary.
2. Center the throttle control stick.
3. Place the servo arms on the servos so they are perpendicular to the pushrods (see page 8). It is okay to cut off any unused servo arms.
4. Connect the pushrods to the control surfaces. Adjust the length of the pushrods until the control surfaces are centered when the servos are centered.

Note: The throttle trim affects the throttle servo only when the throttle stick is below “1/2 stick.” This way, the final closing of the carburetor can be adjusted without affecting the servo throughout the rest of the range.

To adjust the trim settings:

Once the servos and control surfaces have been connected and the control throws have been set using the end points and dual rates, get the model airborne. Adjust the trims as necessary to get the model to fly straight-and-level. If much trim is required on any one control it is a good idea to readjust the pushrods so the trims can be returned to neutral (zero). Adjusting the trims with the trim levers changes the servo’s position in increments of “4.” If finer adjustments are required, land the model, then enter the program as described below to adjust the trims in increments of “1.”

1. Enter the programming mode and use the MODE key to activate the TRIM menu.
2. Press the SELECT key to display the channel to be adjusted (the figure shows trim adjustment for CH1).
3. Adjust the trim using the DATA INPUT lever. Note that initially, the values change in increments of “1,”but if the DATA INPUT lever is held long enough the values will change more rapidly.
4. Repeat the steps for other channels that require trim adjustments.

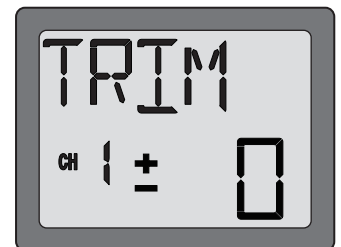

PMIX1/2 Programmable Mixer 1/2 (ACRO only)

Unlike the “wing mixing” function (explained later) where the channels to be mixed are factory-set, the T6EX-2.4GHz also contains two programmable mix where the you, the pilot determine the channels to be mixed. This could be used to correct unwanted flight tendencies (by mixing rudder to aileron, or aileron to rudder for example).

To set up a programmable mix:

1. Enter the programming mode. Access the “PMIX” screen with the MODE key.

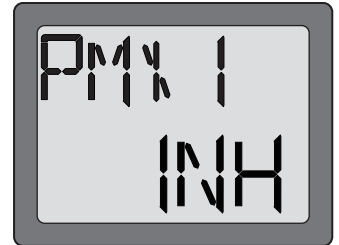

2. Push the DATA INPUT lever upward for 0.5 seconds. This will cause the flashing “INH” display to change to a flashing “ON” display.

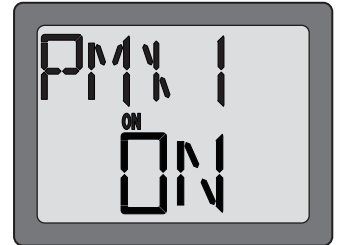

3. Push SELECT key to call the screen for selecting channels to control “MAS” (Master) mixing. Then select the channel by pushing DATA INPUT lever . Channel 1 (aileron) in this figure is assigned to the master.

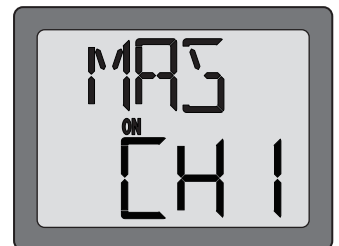

4. Push SELECT key to call the screen for selecting channels to control “SLV” (Slave) mixing. Then select the channel by pushing DATA INPUT lever. Channel 4 (rudder) in this figure is assigned to the slave.

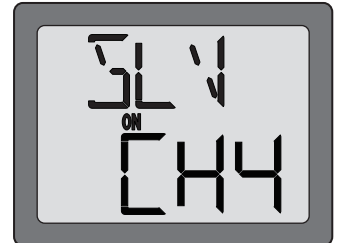

5. Press the SELECT key twice to display the flashing % sign. Use the DATA INPUT lever to set the percentage of mixing from -100% to +100% (depending on the direction and distance you wish the slave servo to move).

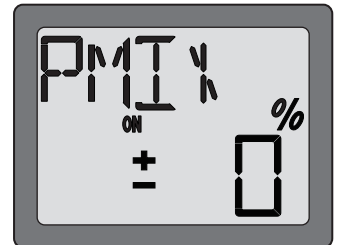

6. Push SELECT key to call the screen for selecting the on/off switch. Then select the switch by pushing DATA INPUT lever. CH5, D/R, or FLP switch (include the on direction) is selectable. The “ON” is “always on”.

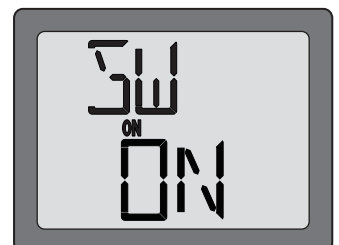

7. Observe how the controls on the model respond to be certain you have achieved the correct mix and that the throws are as desired.

Wing Mixing Type Selection (ACRO only)

With the programmable mix (previously described) the user determines the two channels to be mixed. The wing mixing function is another mix that may be used, but the channels mixed are predetermined. There are three different wing mixing functions to select from:

FLPR Flaperon mixing (ACRO only)

This function allows the ailerons to be used both as ailerons and as flaps. The flap control dial (CH 6) operates the flap function. To use flaperon mixing both ailerons must be operated by separate servos.

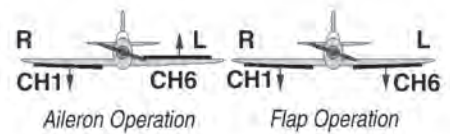

*If necessary, use the Servo Reversing function to achieve the correct direction of servo throws.

To activate flaperon mixing:

1. Connect the aileron servo in the right wing to channel 1 (aileron) in the receiver and connect the aileron servo in the left wing to channel 6 (flaps) in the receiver.

2. Enter the programming mode. Access the “FLPR” screen with the MODE key.

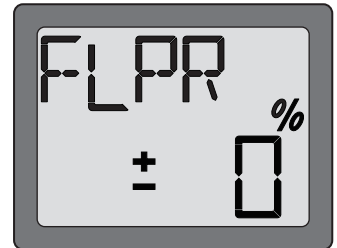
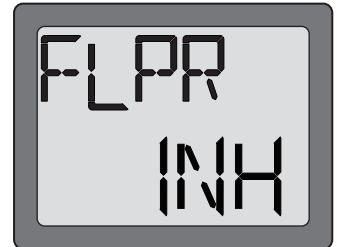

You cannot set “Flaperon” mixing when “Elevon” mixing has already been set. In order to enable “Flaperon” mixing, you first need to cancel “Elevon” mixing. However, it is allowed to use “Flaperon” and “V-Tail” mixing simultaneously.

3. Push the DATA INPUT lever upward for 0.5 seconds. This will cause the flashing “INH” display to change to a flashing “ON” display. Now the mixing is on.

4. If needed to set ailerons differential. Press the SELECT key to display the flashing “%” sign. Use the DATA INPUT lever to set the percentage of ailerons differential from -100% to +100% (The “-” direction indicates decreasing amount of movement toward the upward from the aileron surface, while “+” direction indicates decreasing amount of movement toward the downward from the aileron surface.)

5. Once this mix has been activated, move the servos to their full extremes to make certain they are not overdriving the controls. If necessary, adjust the linkages to achieve the correct control throws.

FLTR Flap trim (ACRO only)

The Flap Trim function is used to specify the amount of flap travel produced moving the flap switch. As normal flap switch will be inhibited to use if the flaperon function is activated, the Flap Trim function should be activated if you need to control flap by Flap switch.

To activate flap trim:

1. Enter the programming mode. Access the “FLTR” screen with the MODE key.

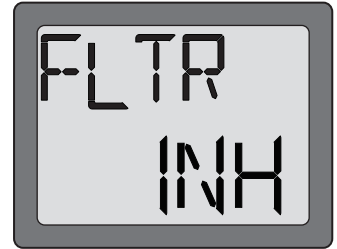

2. If “INH” is blinking, push DATA INPUT lever upward for 0.5 seconds. Then you will see that the blinking “INH” changes to “ON”. Your flap trim is now turned on.

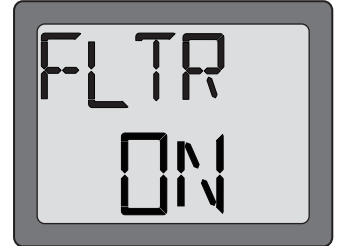

3. Set the travel of the flap switch at between -100% and +100% by using DATA INPUT lever. Two rates (upward and downward of flap switch) are adjustable.

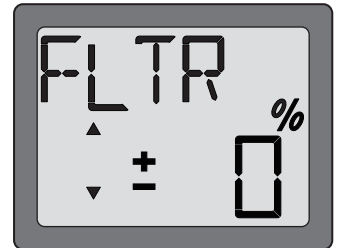

V-TL V-tail mixing (ACRO only)

Intended for V-tail aircraft (such as a Beechcraft Bonanza), V -tail mixing allows the ruddervators to operate both as rudders and elevators. The same as the other mixes, V -tail mixing requires that each ruddervator be operated by a separate servo.

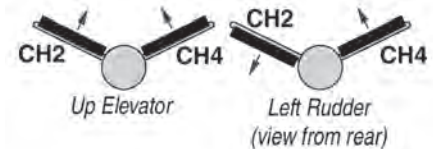

*If necessary, use the Servo Reversing function to achieve the correct direction of servo throws.

To activate V-tail mixing:

1. Connect the left ruddervator servo to channel 2 (elevator) in the receiver and connect the right ruddervator servo to channel 4 (rudder) in the receiver.

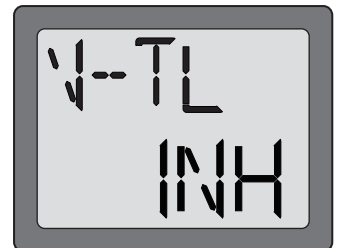

2. Enter the programming mode. Access the “V-TL” screen with the MODE key.

You cannot set “V-tail” mixing when “Elevon” mixing has already been set. In order to enable “V-tail” mixing, you first need to cancel “Elevon” mixing. However, it is allowed to use “V-Tail” and “Flaperon” mixing simultaneously.

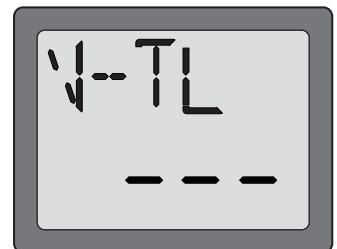

3. Push the DATA INPUT lever upward for 0.5 seconds. This will cause the flashing “INH” display to change to a flashing “ON” display. Now the mixing is on.

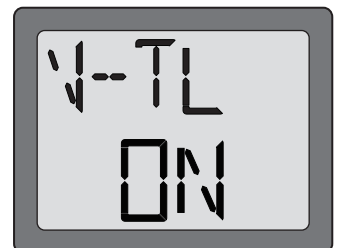

4. Next you may the elevator setting. Press the SELECT key to display the “CH2” and flashing “%” sign. Use the DATA INPUT lever to set the percentage of elevator travel rate from -100% to +100%

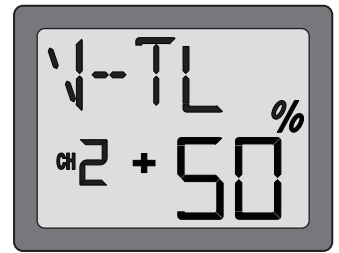

5. Next you may the rudder setting. Press the SELECT key to display the “CH4” and flashing “%” sign. Use the DATA INPUT lever to set the percentage of rudder travel rate from -100% to +100%

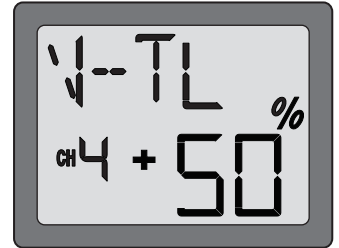

6. Once this mix has been activated, move the servos to their full extremes to make certain they are not overdriving the controls. If necessary, adjust the linkages to achieve the correct control throws.

ELVN Elevon mixing (ACRO only)

Intended for tailless, “flying wing” models such as delta wings and flying wings, elevon mixing mixes channel 1 (aileron) to channel 2 (elevator) allowing the elevons to operate in unison (as elevators) or in opposition (as ailerons). This function requires that each elevon be operated by a separate servo.

*If necessary, use the Servo Reversing function to achieve the correct direction of servo throws.

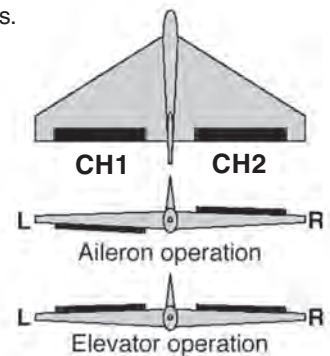

To activate elevon mixing:

1. Connect the servo in the right wing to channel 2 (elevator) in the receiver and connect the servo in the left wing to channel 1 (aileron) in the receiver.

2. Enter the programming mode. Access the “ELVN” screen with the MODE key.

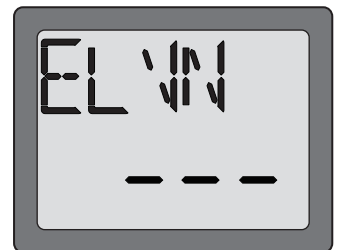
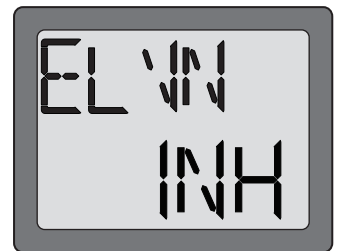

You cannot set “Elevon” mixing when “Flaperon” or “V-TL” mixing has already been set. In order to enable “Elevon” mixing, you first need to cancel both “Flaperon” and “V-tail” mixing.

3. Push the DATA INPUT lever upward for 0.5 seconds. This will cause the flashing "INH" display to change to a flashing "ON" display. Now the mixing is on.

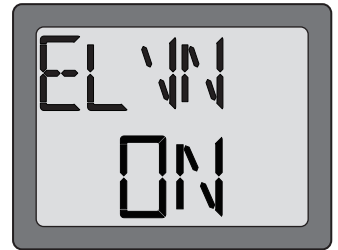

4. Next you set the left wing to channel 1 (aileron) setting. Press the SELECT key to display the "CH1" and flashing "%" sign. Use the DATA INPUT lever to set the percentage of elevator travel rate from -100% to +100%

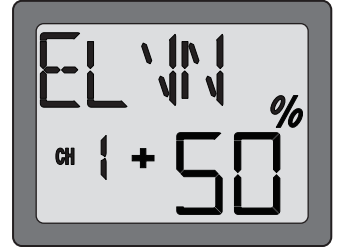

5. Next you set the right wing to channel 2 (elevator) setting. Press the SELECT key to display the "CH2" and flashing "%" sign. Use the DATA INPUT lever to set the percentage of rudder travel rate from -100% to +100%

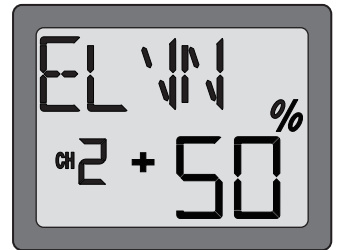

6. Once this mix has been activated, move the servos to their full extremes to make certain they are not overdriving the controls. If necessary, adjust the linkages to achieve the correct control throws.

N-TH Normal throttle curve function (HELI only)

Used to set throttle curve for normal flight. 5-point throttle curve is utilized to best match the blade collective pitch to the engine RPM for consistent load on the engine. Throttle curve can be adjust from 0-100% each point.

This normal throttle curve create basic curve for around hovering. Use this function together with the normal pitch curve (see Normal pitch curve) so that up/down control has a constant engine speed.

To set the normal throttle curve:

1. Enter the programming mode and use the MODE key to access the “N-TH” function. Throttle stick position number will appears on left side of display and “%” symbol will be flashing.
2. Use SELECT key to select the desire curve point. Point 1 is shown initially which is throttle stick all the way downward (slow) position. Point 5 is throttle stick all the way upward (hi) position.
3. Push up or down DATA INPUT lever to set the servo position.
4. Use SELECT key to set other points with same manner.

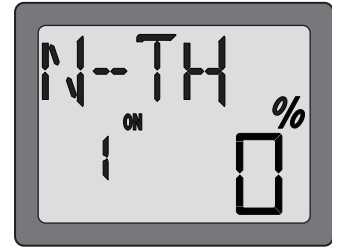

N-PI Normal pitch curve function (HELI only)

Used to set pitch curve for normal flight. 5-point pitch curve is utilized to best match the blade collective pitch to the engine RPM for consistent load on the engine. Pitch curve can be adjust from 0-100% each point.

This normal pitch curve create basic curve for around hovering. Use this function together with the normal throttle curve so that up/down control has a constant engine speed.

To set the normal pitch curve:

1. Enter the programming mode and use the MODE key to access the “N-PI” function. Throttle stick position number will appears on left side of display and “%” symbol will be flashing.
2. Use SELECT key to select the desire curve point. Point 1 is shown initially which is throttle stick all the way downward (slow) position. Point 5 is throttle stick all the way upward (hi) position.
3. Push up or down DATA INPUT lever to set the servo position.
4. Use SELECT key to set other points with same manner.

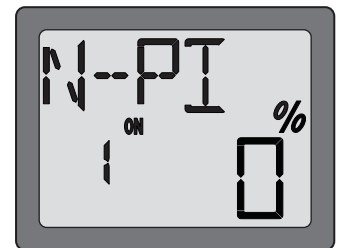

I-TH Idle-up throttle curve function (HELI only)

Used to set throttle curve for idle up flight. 5-point throttle curve is utilized to best match the blade collective pitch to the engine RPM for consistent load on the engine when idle up function is on. Throttle curve can be adjust from 0-100% each point.

This idle up throttle curve is to set for consistent engine RPM and can be activated at any time when mid air maneuvers are executed, such as loops, rolls, and 3D flight even when reduced the blade collective pitch.

To set the idle-up throttle curve:

1. Enter the programming mode and use the MODE key to access the “I-TH” function.
2. Push the DATA INPUT lever upward for 0.5 seconds. This will cause the flashing “INH” display to change to a flashing “ON” display. Now the I-TH function is on. Push the SELECT key, throttle stick position number will appears on left side of display and “%” is blinks.

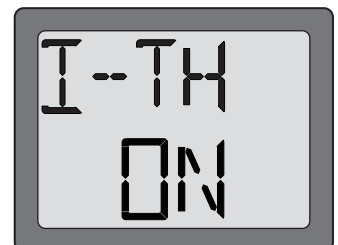
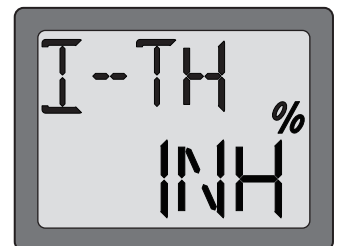

- Use SELECT key to select the desire curve point. Point 1 is shown initially which is throttles stick all the way downward (slow) position. Point 5 is throttles stick all the way upward (hi) position.
- Push up or down DATA INPUT lever to set the servo position.
- Use SELECT key to set other points with same manner.

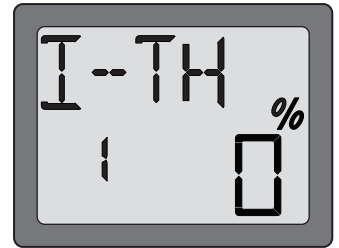

I-PI Idle-up pitch curve function: (HELI only)

Used to set pitch curve for idle up flight. 5-point pitch curve is utilized to best match the blade collective pitch to the consistent engine RPM when idle up is used. Pitch curve can be adjust from 0-100% each point.

The high side pitch curve should be set to not to over load the engine and keep consistent engine RPM. Generally set less pitch than normal maximum pitch. The low side pitch curve is to set for desired maneuver such as loops, rolls, and 3D flight.

To set the idle-up pitch curve:

- Enter the programming mode and use the MODE key to access the **"I-PI"** function.
- This function cannot be used when **"I-TH"** function is not activated. When you set **"I-PI"** function, you must activates **"I-TH"** function.
- Use SELECT key to select the desire curve point. Point 1 is shown initially which is throttles stick all the way downward (slow) position. Point 5 is throttles stick all the way upward (hi) position.
- Push up or down DATA INPUT lever to set the servo position.
- Use SELECT key to set other points with same manner.

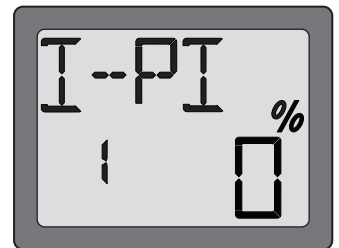

HOLD Throttle hold function (HELI only)

Throttle hold function is to be used for autorotations where only pitch control is used to make a descent and landing. Just flip the hold switch on to set the engine in the idling or cut position and disengaged it from the Throttle Stick. It can be set from (-)50 to (+)50% from throttle trim position.

To set the throttle hold:

- Enter the programming mode and use the MODE key to access the **"HOLD"** function.
- Push the DATA INPUT lever upward for 0.5 seconds. This will cause the flashing **"INH"** display to change to a flashing **"ON"** display. Now the **"HOLD"** function is on.
- Push SELECT key once. This will cause the flashing **"%"** symbol on the display. Pull the hold switch forwards you. Push up or down DATA INPUT lever to set the throttle servo position of throttle hold.

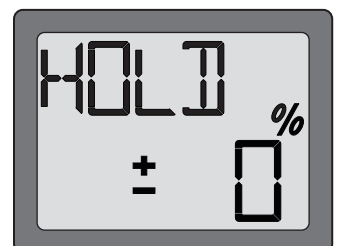
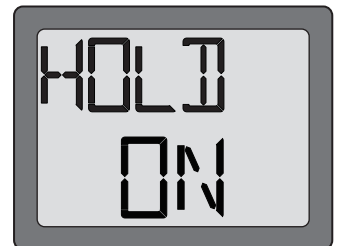
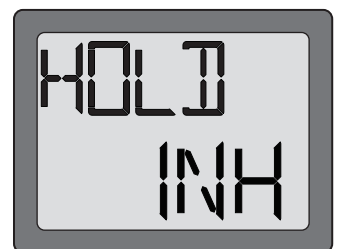

REVO Pitch-rudder mixing function (HELI only)

This mix adds rudder in conjunction with pitch. This helps compensate for rotation of the helicopter caused by the increased engine torque. (Never use revo. mixing with a heading-hold/AVCS gyro which is in heading hold/AVCS mode. However, revo. mixing is still used when a heading-hold/AVCS gyro is in normal mode.)

To set the REVO mixing:

1. Enter the programming mode and use the MODE key to access the “REVO” function.

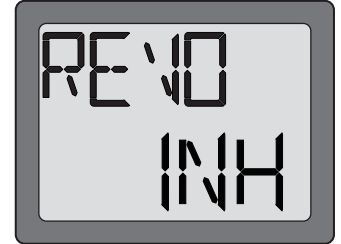

2. Push the DATA INPUT lever upward for 0.5 seconds. This will cause the flashing “INH” display to change to a flashing “ON” display. Now the “REVO” function is on.

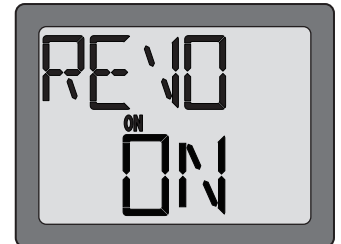

3. Push the SELECT key once. This will cause the flashing “%” symbol on the display. It can be set mixing amount on throttle stick hi side and low side separately. When you move the throttle stick to the low side from neutral, the arrow indicates down direction and then push up or down DATA INPUT lever to set the mixing amount of the low side. When you move the throttle stick to the high side from neutral, the arrow indicates up direction and then push up or down DATA INPUT lever to set the mixing amount of the low side.

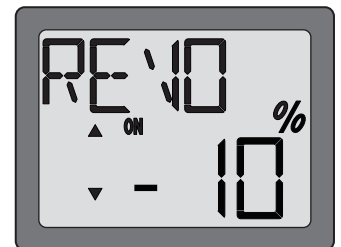

GYRO Gyro mixing function (HELI only)

GYROS : Using electronics to take some of the complexity out of setups and flight.

What is a gyro? A gyroscope is an electronic unit that senses motion and corrects for it. For example, if the wind blows your helicopters tail to the left, a gyro will sense that motion (and confirm that no input was given) and will correct for it.

How does it help in helicopter setup? A good gyro will totally eliminate the need for revo. mixing. The gyro will sense and correct the unwanted motion for you, so you don't have to spend time to get a complex curve operating properly.

Used with rudder
(yaw axis)

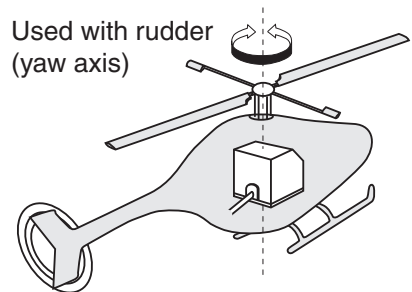

Gyro sensor kinds: There are many different kinds of gyros. Early gyros were mechanical, with a spinning drum similar to a child's gyroscope toy. The next generation utilized a special type of crystal, called piezoelectric, which sensed the motion and provided an electrical pulse. The finest gyros at the time of this writing are SMM technology. These silicone micro machines, or computer chips, sense the motion. SMM is far more accurate and less susceptible to inaccuracies caused by temperature changes, etc.

Choosing the right gyro for your skills, your helicopter, and your budget:

- Mechanical: some are still available. They are very challenging to set up and not as reliable as piezo or SMM.
- Non-Heading-Hold Piezo: these are now inexpensive gyros that are reliable and easy to set up. Some have dual rates and remote gain control to adjust sensitivity in flight. Lack heading-hold capabilities for precision flying.
- Heading-Hold Piezo: Until recently, the cream of the crop. Expensive, and more complex to set up. Adds GPS-like heading recognition. Exhibits minor difficulties with temperature drift (position setting varying with unit's temperature).
- Heading-Hold SMM: 21st Century gyro technology. Computer chip technology. Expensive, easier set up, higher durability. Significant decrease in temperature sensitivity. Many include frame rate settings to allow faster response when using specialized digital servos. Examples:

- **GY401:** Simpler set up. Ideal for learning aerobatics through 3D.
- **GY502:** Better centering than 401 for more advanced aerobatics. Ideal through Class III competition.
- **GY611:** Exceptional center. Extremely fast response time. Requires specialized servo.

Gyro mixing function is use for adjusting the gain of the gyro and selecting the gain from two different gain settings by switch on the transmitter with the gyro that can set two different gains witch placed on the model.

To set the GYRO mixing:

1. Plug the gyro’s sensitivity adjustment to channel 5 of the receiver. (not assignable)
2. EPA of channel 5 (see page 12-13) to set 100% both UP and DOWN.
3. Enter the programming mode and use the MODE key to access the **“GYRO”** function.

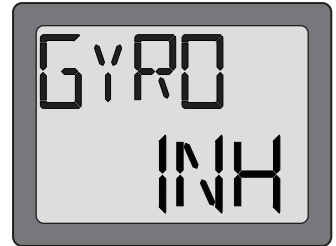

4. Push the DATA INPUT lever upward for 0.5 seconds. This will cause the flashing **“INH”** display to change to a flashing **“ON”** display. Now the mixing is on.



5. Push the SELECT key once. This will show the gyro gain setting and flashing **“%”** symbol on the display.

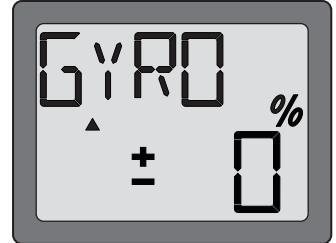

Flip the gyro (CH5) switch up and down. This will cause the arrow points up and down on the display simultaneously with switching operation and show the position of the switch. Push up or down DATA INPUT lever to set the gyro gains both switch up and down position. Gyro gain can be adjust from -100% to +100%.

Example of sensitivity setting with GY401

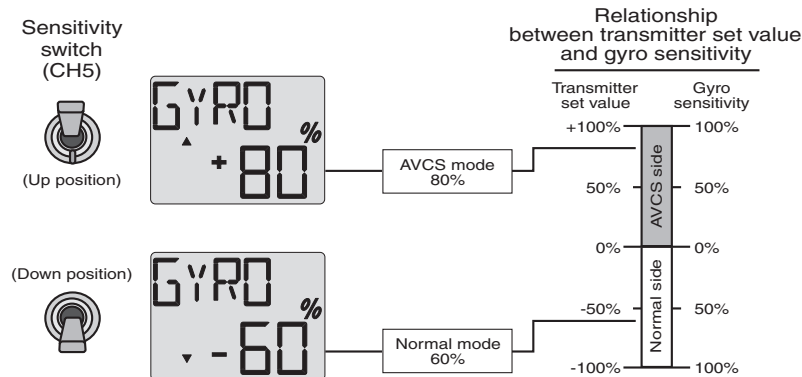

SW-T Swash to throttle mixing (HELI only)

This function corrects slowing of engine speed caused by swashplate operation at aileron or elevator operation.

To activate swash to throttle mixing:

1. Enter the programming mode. Access the "SW-T" screen with the MODE key.

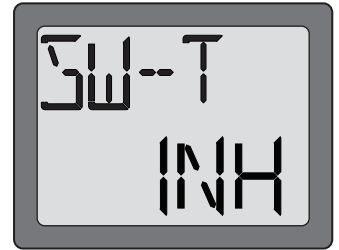

2. Push the DATA INPUT lever upward for 0.5 seconds. This will cause the flashing "INH" display to change to a flashing "ON" display. Now the mixing is on.



3. Press the SELECT key to display the "CHA". Use the DATA INPUT lever to set the percentage of aileron to throttle mixing rate from 0% to 50%.

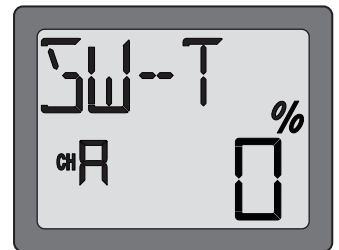

4. Press the SELECT key to display the "CHE". Use the DATA INPUT lever to set the percentage of elevator to throttle mixing rate from 0% to 50%.

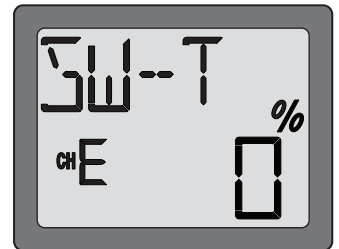

SWSH Swashplate types selection & Swash AFR (HELI only)

This function can choose from three swashplate types. Swash AFR can be set, if you choose 3-S or 3-E type

1-S: Independent aileron, pitch and elevator servos linked to the swashplate. Most kits are 1-S type.

3-S: With Aileron inputs, the aileron and pitch servos tilt the swashplate left and right; with Elevator inputs, the three servos tilt the swashplate fore and aft; with Pitch inputs, all three servos raise the swashplate up and down.

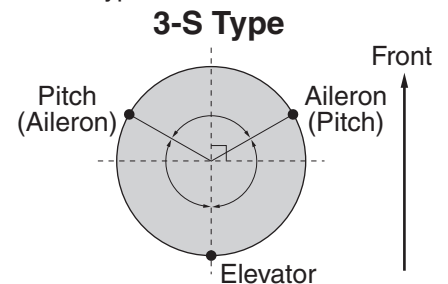

3-E: With Aileron inputs, the aileron and pitch servos tilt the swashplate left and right; with Elevator inputs, the servo tilt the swashplate fore and aft; with Pitch inputs, all three servos raise the swashplate up and down.

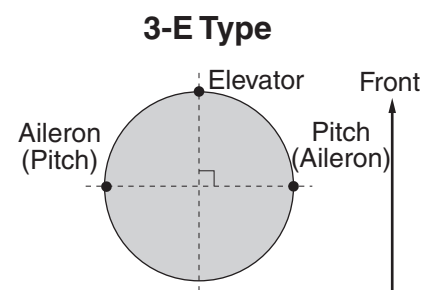

To select the swashplate types:

1. Enter the programming mode and use the MODE key to access the **“SWSH”** function.
2. To select swashplate type press the DATA INPUT lever upward or downward for about two seconds. When you are changing swashplate type to 1-S, 3-S or 3-E, the 1-S, 3-S or 3-E on the display flashes slow to change rapid and then returns slow flashing with conformation sound.
3. Now it set the swashplate type.

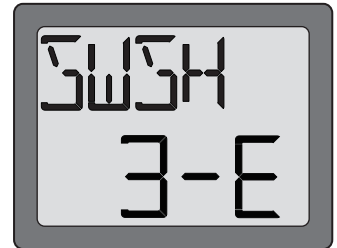
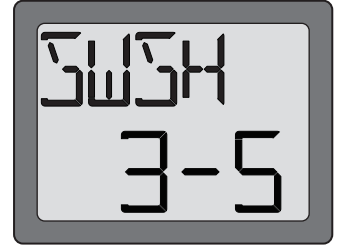
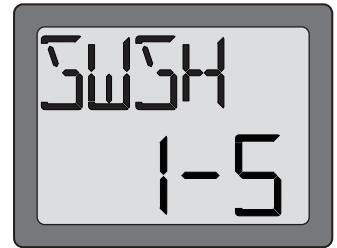

To set the swash AFR:

This function only can set when you selected the 3-S or 3-E swashplate type. There is no swash AFR setting with 1-S type. This swash AFR function is to use for change the direction and amount of servo movement on aileron, elevator, and pitch.

At first, linkage and set the servo horn length on aileron, elevator, and pitch servos follow by instruction manual comes with the model. Basically "EPA" (see page17) is set near 100% with these three servos. To set the servo "reverses" function (see page16) so that swashplate keeps horizontally and moves correct direction up and down by operating pitch control (up and down throttle stick).

1. Enter the programming mode and use the MODE key to access the **“SWSH”** function.
2. Swashplate types, Confirm 3-S or 3-E type is selected. If 3-S or 3-E type is not selected, please see **“To select the swashplate types”** and set.
3. Use SELECT key to select the channel you wanted to set. Aileron channel **“CHA”** is displayed at first and **“%”** is flashing.
Move the aileron stick left and right to set the direction and amount of movement on the aileron servo by push up or down DATA INPUT lever. Aileron movement can be adjust from -100% to +100% .
4. Other channel (elevator and pitch) select by SELECT key to set the direction of movement and movement amount of servo with same manner of aileron channel setting.
“CHE” is elevator and **“CHP”** is pitch channel on the Display.

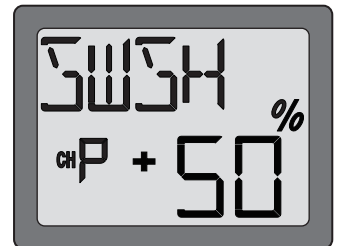
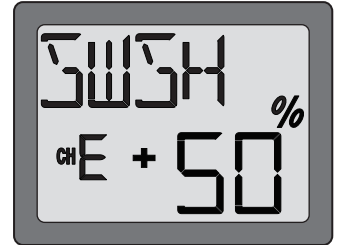
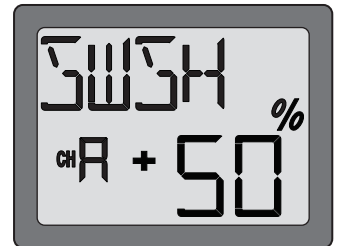

F/S Fail Safe (Throttle channel <ch 3> only)

The Fail Safe function is recommended to use for safety reason in the event radio interference is received. In this menu, you may select from one of two options of operation. The “NOR”(normal) setting holds the servo in its last commanded position, while the “F/S”(Fail Safe) function moves the servo to a predetermined position.

The setting is set to “F/S” as a default.

The use of the failsafe function is recommended from the standpoint of safety. You may wish to set the throttle channel so that the throttle is moved to idle when there’s interference. This may give enough warning to allow you to fly towards yourself and recover from the radio interference. If you choose to specify a failsafe setting, the failsafe data are automatically transmitted to the receiver many times during the flight.

Battery Failsafe

Your system provides a second safety function called Battery Failsafe. When the airborne battery voltage drops below approximately 3.8V, the battery fail safe function moves the throttle to a predetermined position or fast idle, if you haven’t set it. If this happens, you should immediately land! If you need to increase throttle for your landing approach, you may temporarily reset the failsafe function by moving the throttle stick to idle, after which you’ll have about 30 seconds of throttle control before the battery function reactivates.

To set the Fail Safe Function:

1. Enter the programming mode. Access the “**F/S**” screen with the MODE key.
2. Press DATA Input lever downward when you need to set Fail Safe. The arrow moves to “F/S” side. This means that the F/S function is activated. Then move the throttle stick to the position where you want the servo to move when “**F/S**” function works and press DATA INPUT lever downward for about two seconds. A figure in percentage will be shown with a beeping sound. Press DATA INPUT lever upward if you want to set “**NOR**”. The arrow moves to “NOR” side and then the “**NOR**” function is selected.

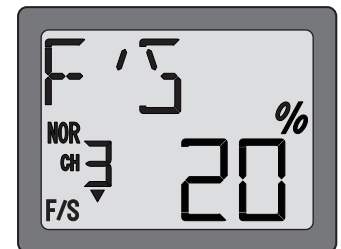

The F/S value is set to 20% of the full throttle for “F/S” function as a default.

3. Verify if the F/S function has been correctly set. Turn off the transmitter, then check if the throttle servo move to the position that you set.

FLOW CHART ACRO MODE FUNCTIONS

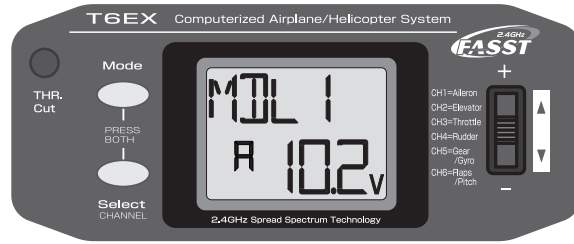

(Screen at Startup)

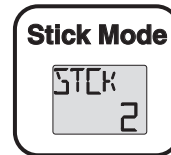

To enter or leave Programming Mode, press MODE and SELECT keys simultaneously for one second.

To change the Stick Mode, turn on the transmitter holding MODE and SELECT keys down simultaneously. Use the DATA INPUT lever to display the desired stick mode.

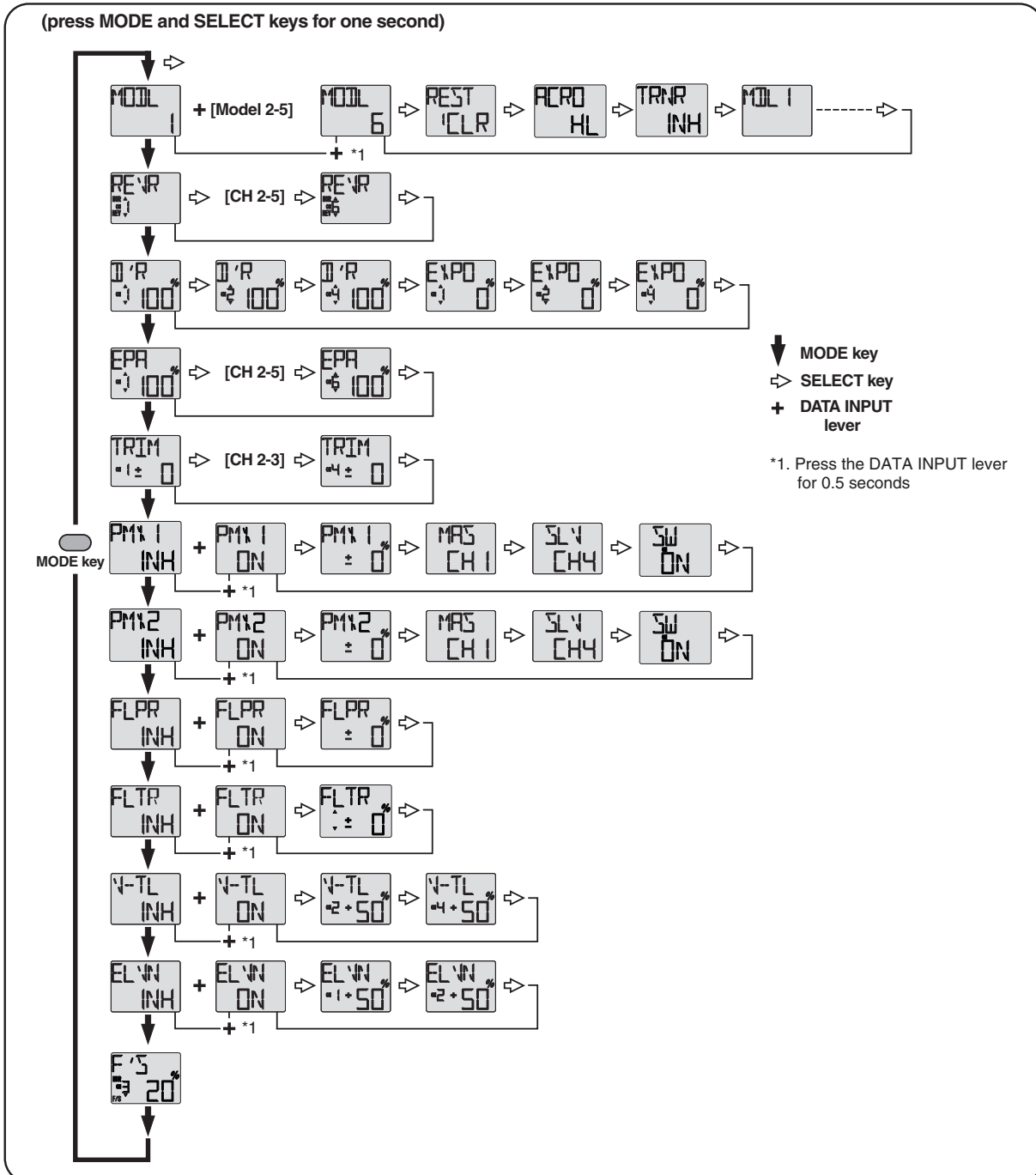

Simultaneously Press the **“MODE”** and **“SELECT”** keys and hold them down for one second to enter the programming mode. Press the keys again (or turn off the transmitter) to exit the programming mode.

FLOW CHART HELI MODE FUNCTIONS

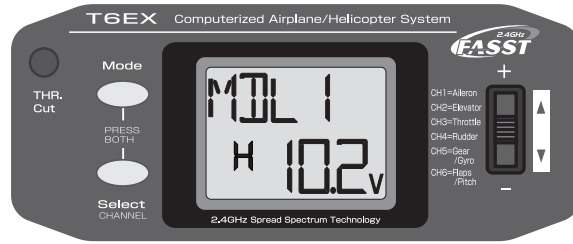

(Screen at Startup)

To enter or leave Programming Mode, press MODE and SELECT keys simultaneously for one second.

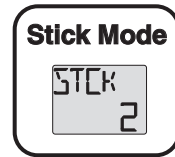

To change the Stick Mode, turn on the transmitter holding MODE and SELECT keys down simultaneously. Use the DATA INPUT lever to display the desired stick mode.

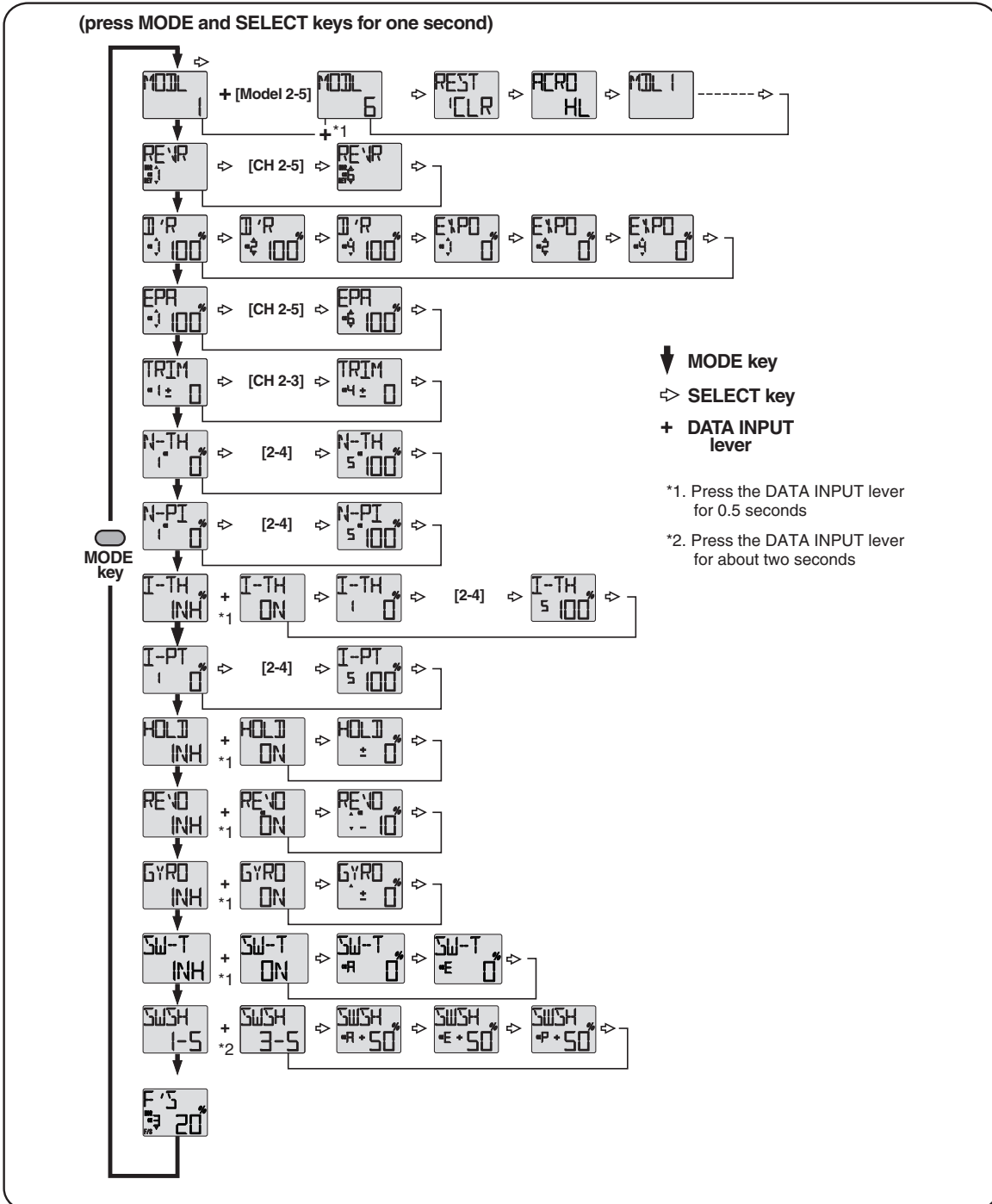

Simultaneously Press the **“MODE”** and **“SELECT”** keys and hold them down for one second to enter the programming mode. Press the keys again (or turn off the transmitter) to exit the programming mode.

OTHER 6EX-2.4GHz FUNCTIONS

Trainer switch (ACRO mode)

To utilize the trainer function, the appropriate trainer cord (available separately) and a second Futaba transmitter (usually provided by your flight instructor or R/C club) will be required. When two radios are connected with the trainer cord, they are both capable of operating the model, but it's usually best for the instructor to hold the radio that has been setup for the plane to be flown (as it is already programmed to fly the model). When the instructor holds the trainer switch on his radio, the student will have control. When the instructor wishes to regain control he simply releases the switch. Then he will have immediate, full control.

If connecting the 6EX-2.4GHz to another 6EX-2.4GHz with the small, square "micro" trainer jack, use the "Micro to Micro" (MM-TC) trainer cord (FUTM4415). Never connect the T6EX-2.4GHz trainer system with Futaba radios that have the large round "DIN" connector type as it will cause malfunction to your T6EX-2.4GHz. The T6EX-2.4GHz transmitter may be connected to another T6EX-2.4GHz, or any T4EX, T6EXA, T7C, T9C, T12Z, T14MZ, FX-40 series transmitter.

To use the trainer function:

1. It is best for the instructor to use the transmitter that is already set up for the model to be flown.
2. If the student's radio has PCM/PPM capability, set it to PPM.
3. If the student's radio has a plug-in RF module, remove the module.
4. Collapse the student's antenna when the student's transmitter is conventional type. (29-72MHz)
5. With the transmitters off, connect the trainer cord to both radios. (On the 6EX-2.4GHz the trainer jack is in the center of the rear of the case.) Do not force the plug into the transmitter and note that the plug is "keyed" so it can go in only one way.
6. Turn on the instructor's transmitter. **DO NOT** turn on the student's transmitter it will automatically "power up," but will not transmit a signal. Set the servo reversing and trims of the student's radio to match that of the instructor's. If both the instructor and the student use T6EX2.4G, the F/S function's set-up must be the same in both transmitters.
7. Turn on the receiver switch in the model. Depress the trainer switch on the instructor's radio. Use the student's radio to operate the controls (ailerons, elevator, rudder, etc.) and observe how they respond. Make any adjustments necessary to the student's transmitter to get the controls to respond correctly.
8. Check to see that the trims are in "sync" by toggling the trainer switch back and forth a few times. The controls on the model should remain stationary. If the controls do not remain stationary, this indicates that the trim settings on the student's radio do not match those on the instructor's radio. Adjust the student's trims as necessary.



Note: When the instructor initially depresses the trainer switch on his transmitter, there will be a one-second delay before the student takes control. In most situations this momentary delay will go unnoticed.

Trainer function (HELI mode, student only)

The T6EX-2.4GHz (HELI mode) trainer function lets you practice flying as student by connecting the T6EX-2.4GHz to the instructor's Futaba transmitter.

Throttle-cut function

The throttle-cut function is intended to be used for shutting off the engine. The engine can be conveniently shut off by pressing the "THR Cut" button. The throttle-cut feature prevents inadvertently shutting off of the engine when lowering the throttle stick all the way (such as when coming in for a landing). Throttle-cut works only when the throttle stick is down. To set up throttle-cut, turn on the transmitter and receiver. Actuate the throttle-cut function by rapidly depressing, then releasing the switch twice. Observe the momentary position of the carburetor barrel on the engine. It should be fully closed (thus shutting off the engine). If necessary, use the throttle E.P.A. (channel 3) to fully close the carburetor barrel when the throttle-cut is activated. Now use the throttle trim to open the carburetor barrel so the engine will idle at the desired R.P.M. when the throttle stick is all the way down.

Adjustable-length control sticks

The control stick length is adjustable to make the transmitter more comfortable to hold and operate. To adjust the length, hold the **locking piece (B)** and turn the **stick tip (A)** counterclockwise. Turn the locking piece B up or down to lengthen or shorten the stick. When the length is suitable, lock the stick in position by turning locking piece B counterclockwise.

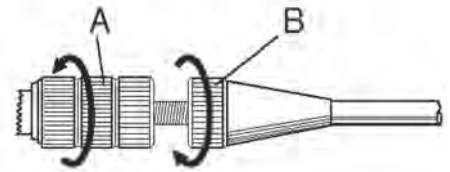

Changing the 6EX-2.4GHz stick mode

The transmitter may be operated in four different stick “modes” (1, 2, 3 & 4). The modes determine the functions that will be operated by control sticks. Currently, the transmitter is in “mode 2” and should be left in mode 2 unless you are an experienced flyer and have learned to fly in a different mode. In mode 2, the right control stick operates the aileron and elevator and the left stick operates the rudder and throttle. This is how 99% of Americans fly their models.



To change the mode, simultaneously depress the MODE and SELECT keys, then turn on the power. The current mode will appear on the LCD screen. Push the DATA INPUT lever up or down to change the mode. If a mode is selected that moves the throttle control to the right stick, **the throttle detent mechanism will have to be moved as well.** This can be done by the Futaba Service Center. (See page 3)

FLYING SAFETY GUIDELINES

Find a suitable flying site (for USA)

If you are a beginning modeler and not yet a member of an R/C club, joining a club and flying at a site specifically intended for R/C model aircraft is highly recommended. In addition to joining a club, we strongly recommend joining the AMA (Academy of Model Aeronautics). AMA membership is required to fly at AMA clubs. There are over 2,500 AMA-chartered clubs across the country. Among other benefits, the AMA provides insurance to its members who fly at sanctioned sites and events. Additionally, training programs and instructors are available at AMA club sites to help you get started the right way. Contact the AMA at the address or toll-free phone number below:

Academy of Model Aeronautics

5151 East Memorial Drive
Muncie, IN 47302-9252
Tele. (800) 435-9262
Fax (765) 741-0057

Or via the Internet at: <http://www.modelaircraft.org>



IMPORTANT:

If you do insist on flying on your own, you must be aware of your proximity to R/C club sites. If there is an R/C site within six miles of where you are flying, and if you are operating your model on the same frequency as somebody else, there is a strong possibility that one or both models will crash due to radio interference. There is great potential for an out-of-control model to cause property damage and/or severe personal injury. We strongly urge you to fly at an R/C club site where frequency control is in effect so you can be confident you will be the only one flying on your channel.

Charge the batteries

Second to the pilot's flight skills, one of the most important factors that can determine a model's longevity is the state-of-charge of the batteries - especially the on-board receiver pack. Inadequate charging and failing to monitor a battery's voltage may lead to low battery power, causing loss of control and a crash. To avoid this, always charge the batteries the night before you go flying. If ever uncertain how much “charge” is left in a battery, it is wiser to err on the side of caution, rather than trying to get in one last flight! Due to the number of factors that determine receiver battery power consumption (such as the number and type of servos in your model, the type of flying you do, how much resistance is built into the controls, the size of the model, etc.), it is not possible to recommend how many flights one can get on a charge. The best way to monitor battery power and calculate how much flight time you have left is to use a volt meter to check the batteries after each flight. This can be done through the battery charging plug coming from the switch. There are many small, hand-held volt meters available specially intended for R/C use. The Hobbico® Digital Voltmeter MKIII™ (HCAP0356) is one such unit. An on-board volt meter mounted directly on the model (HCAP0330) can also be used.

FLIGHT PREPARATION

Flight preparation is to be done at the flying field.

If you are an inexperienced pilot, be certain your flight instructor performs these following checks with you.

Check the controls

1. Get the frequency clip from the frequency control board at your flying site if the site have a clip for 2.4GHz.
2. Mount the wing to the fuselage. Turn on the transmitter, then the receiver (remember to do this in reverse order when turning off the system). Be certain the correct model memory matching the model you will be flying is the one on the LCD screen.
3. Operate and observe the controls. Look for inadvertent movement and listen for abnormal servo sounds. If problems are noted, correct them before flying. Look for binding pushrods or servo arms or pushrods that interfere with each other.
4. One at a time, operate each control on the airplane using the sticks on the transmitter to make certain each control is responding correctly. This **must** be done before **every** flight. (There are several types of malfunctions that can be discovered by performing this elementary task, thus saving your model!)

Range check the radio

A range check **must** be performed before the **first** flight of a new model. It is not necessary to do a range check before every flight (but is not a bad idea to perform a range check before the first flight of each day). A range check is the final opportunity to reveal any radio malfunctions, and to be certain the system has adequate operational range.

1. We have installed a special "Power Down Mode" for doing a ground range check. To activate the "Power Down Mode" please hold down the "Mode" key and then turn the transmitter switch on. During this mode, the RF power is reduced so the range test can be performed. When this mode is active the red LED on the back of the transmitter starts blinking and the green LED is solid. In addition, when the mode is activated the transmitter gives users a warning with a beep sound every 3 seconds, and visual indication.
2. Walk away from the model while simultaneously operating the controls. Have an assistant stand by the model and signal what the controls are doing to confirm that they operate correctly. You should be able to walk approximately 30 - 50 paces from the model without losing control.
3. If everything operates correctly, return to the model. Set the transmitter in a safe, yet accessible location so it will be within reach after starting the engine. Be certain the throttle stick is all the way **down**, then start the engine. Perform another range check with your assistant holding the plane and the engine running at various speeds. If the servos jitter or move inadvertently, there may be a problem. **Do not fly** the plane! Look for loose servo connections or binding pushrods. Also be certain that the battery has been fully charged.
4. The "Power Down Mode" continues for 60 seconds and after that the power will go back to the normal level.
To exit the "Power Down Mode" before the 60 seconds, press the "MODE" key again. This mode is available 1 time only so if you need to re-use this function the transmitter power must be cycled.
5. **NEVER** start flying when the "Power Down Mode" is active.

Do not fly in the rain!

Moisture may enter the transmitter through the antenna or stick openings and cause erratic operation or loss of control. If you must fly in wet weather during a contest, be sure to cover the transmitter with a plastic bag or other waterproof cover.

MODEL DATA RECORDING SHEET

After finalizing the programming for each model, fill out the values and settings in the **Model Data Recording Sheets** in the back of the manual. The data sheets will serve as a backup in case a program is ever lost or inadvertently reset, or in case you have to intentionally reset a program to make room for another model. Make additional copies before filling out the sheets.

MODEL DATA RECORDING SHEET (ACRO)

(Make copies before using)

Model name: _____

Model No. 1 • 2 • 3 • 4 • 5 • 6

Model Type: ACRO

MENU FUNCTION		CH 1	CH 2	CH 3	CH 4	CH 5	CH 6
REVR	Servo Reverse	N • R	N • R	N • R	N • R	N • R	N • R
D/R	Dual Rate setting	▲ %	▲ %		▲ %		
		▼ %	▼ %		▼ %		
EPA	End Point Adjust	▲ %	▲ %	▲ %	▲ %	▲ %	▲ %
		▼ %	▼ %	▼ %	▼ %	▼ %	▼ %
TRIM	Trims						
EXPO	Exponential setting	▲ %	▲ %		▲ %		
		▼ %	▼ %		▼ %		
F/S	Failsafe			%			

MIXING SETTING

PMX1	Programmable Mixer 1	INH • ON	Master Ch ____ Slave Ch ____ Rate- ± ____% Sw ____			
PMX2	Programmable Mixer 2	INH • ON	Master Ch ____ Slave Ch ____ Rate- ± ____% Sw ____			
FLPR	Flaperon	INH • ON	Ailerons differential rate ± ____%			
V-TL	V-Tail	INH • ON	CH 2 (Elevator) rate- ± ____%	CH 4 (Rudder) rate- ± ____%		
ELVN	Elevon	INH • ON	CH 1 (Aileron) rate- ± ____%	CH 2 (Elevator) rate- ± ____%		

FLAP TRIM SETTING

FLTR	Flap Trim	INH • ON	Flap trim rate ▲ ± ____% ▼ ± ____%
------	-----------	----------	------------------------------------

TRAINER SETTING

TRNR	Trainer Function	INH • ON
------	------------------	----------

MODEL DATA RECORDING SHEET (HELI)

(Make copies before using)

Model name: _____

Model No. 1 • 2 • 3 • 4 • 5 • 6

Model Type: HELI

MENU FUNCTION		CH 1	CH 2	CH 3	CH 4	CH 5	CH 6
REVR	Servo Reverse	N • R	N • R	N • R	N • R	N • R	N • R
D/R	Dual Rate setting	▲ %	▲ %		▲ %		
		▼ %	▼ %		▼ %		
EPA	End Point Adjust	▲ %	▲ %	▲ %	▲ %	▲ %	▲ %
		▼ %	▼ %	▼ %	▼ %	▼ %	▼ %
TRIM	Trims						
EXPO	Exponential setting	▲ %	▲ %		▲ %		
		▼ %	▼ %		▼ %		
F/S	Failsafe			%			

MIXING SETTING

N-TH	Normal Throttle Curves		P-1 _____ %	P-2 _____ %	P-3 _____ %	P-4 _____ %	P-5 _____ %	
N-PI	Normal Pitch Curves		P-1 _____ %	P-2 _____ %	P-3 _____ %	P-4 _____ %	P-5 _____ %	
I-TH	Idle-UP Throttle Curves	INH • ON	P-1 _____ %	P-2 _____ %	P-3 _____ %	P-4 _____ %	P-5 _____ %	
I-PI	Idle-UP Pitch Curves	INH • ON	P-1 _____ %	P-2 _____ %	P-3 _____ %	P-4 _____ %	P-5 _____ %	
HOLD	Throttle Hold	INH • ON	Throttle hold position					± _____ %
REVO	Pitch- Rudder Mixing	INH • ON	▼ ± _____ %				▲ ± _____ %	
GYRO	Gyro Mixing	INH • ON	▼ ± _____ %				▲ ± _____ %	
SW-T	Swash-Throttle Mixing	INH • ON	CH A (Aileron) _____ %		CH E (Elevator) _____ %			
SWSH	Swashplate Types	1-S • 3-S • 3-E	CH A (Aileron) ± _____ %	CH E (Elevator) ± _____ %	CH P (Pitch) ± _____ %			

INSTRUCTIONS MANUAL FEDERAL COMMUNICATIONS COMMISSION INTERFERENCE STATEMENT

This equipment has been tested and found to comply with the limits for a Class B digital device, pursuant to Part 15 of the FCC Rules. These limits are designed to provide reasonable protection against harmful interference in a residential installation. This equipment generates, uses, and can radiate radio frequency energy and, if not installed and used according to the instructions, may cause harmful interference to radio communications. However, there is no guarantee that interference will not occur in a particular installation. If this equipment does cause harmful interference to radio or television reception, which it found by turning the equipment off and on, the user is encouraged to try to correct the interference by one or more of the following measures:

- Reorient or relocate the receiving antenna.
- Increase the separation between the equipment and receiver.
- Connect the equipment into an outlet other than the receiver's
- Consult the dealer or an experienced radio/TV technician for assistance.

CAUTION:

To assure continued FCC compliance:

- (1) Any changes or modifications not expressly approved by the grantee of this device could void the user's authority to operate the equipment.

FCC Label Compliance Statement:

This device complies with Part 15 of the FCC Rules. Operation is subject to the following two conditions: (1) this device may not cause harmful interference, and (2) this device must accept any interference received, including interference that may cause undesired operation.

Exposure to Radio Frequency Radiation

To comply with FCC RF exposure compliance requirements, a separation distance of at least 20cm must be maintained between the antenna of this device and all persons. This device must not be co-located or operating in conjunction with any other antenna or transmitter.