

Straubing, 09 January 2003

TEST - REPORT**No. 55503-20837****for****TX6EXA 72 MHz
R/C Transmitter**

Applicant: Futaba Corporation

Purpose of testing: To show compliance with

- FCC Code of Federal Regulations,
CFR 47, Part 95

- FCC Code of Federal Regulations,
CFR 47, Part 2, Subpart J

Note:

The test data of this report relate only to the individual item which has been tested. This report shall not be reproduced except in full extent without the written approval of the testing laboratory.

Table of Contents

1.	Administrative Data	3
2.	Identification of Test Laboratory	4
3.	Summary of Test Results	5
4.	Operation Mode of EUT.....	6
5.	Configuration of EUT and Peripheral Devices	7
6.	Measuring Methods	8
6.1.	Maximum Transmitter Power (§95.639).....	8
6.2.	Frequency tolerance (§95.623).....	10
6.3.	Emission Bandwidth (§95.633)	12
6.4.	Unwanted Emission 30 MHz - 1 GHz (§95.635, §95.639).....	13
7.	Photographs of Test Setups	15
8.	Equipment List.....	17
9.	Referenced Regulations	19
10.	List of Measurements	20
11.	Test Results	21
12.	Additional Results.....	31
13.	Additional Information supplementary to the Test Report	56
13.1.	Calculation of the necessary bandwidth (Section 2.202b).....	56
13.2.	Additional Information	56

1. Administrative Data

Equipment Under Test (EUT): TX6EXA 72 MHz

Serial number(s): 001

Type of equipment: R/C Transmitter

Type of emission: 6K00F1D

Parts/accessories: ---

FCC-ID: AZPT6EXA-72

Applicant:
(full address) Futaba Corporation
R/C Engineering Unit 1
1080, Yabutsuka Chosei-son, Chosei-gun,
Chiba-ken, 299-4395 Japan

Contract identification: ---

Contact person: Mr. Fujita

Manufacturer: Futaba Corporation

Receipt of EUT: January 07, 2003

Dates of test: January 08, 2003

Note: ---

Responsible for testing: Thomas Eberl

Responsible for test report: Thomas Eberl

2. Identification of Test Laboratory

Test Laboratory: Senton GmbH EMI/EMC Test Center
(full address): Aeussere Fruehlingstrasse 45
D-94315 Straubing
Germany

Contact person: Mr. Johann Roidt
Communication: Telephone (+49) 0 94 21 / 55 22-0
Fax (+49) 0 94 21 / 55 22-99
eMail: Office@senton.de

FCC registration number: 90926
Industry Canada file number: IC 3050

3. Summary of Test Results

The tested sample complies with the requirements for R/C Transmitters set forth in the

The Code of Federal Regulations 47, Part 95, Subpart C & E

and

The Code of Federal Regulations 47 Part 2, Subpart J.

of the Federal Communication Commission (FCC).



Johann Roidt
Laboratory Manager



Thomas Eberl
Test Engineer

4. Operation Mode of EUT

- transmitting continuously¹
- with accu pack supply nominal 9.6 V DC)²
- antenna extended to maximum³

- operating with $f = 72.510$ MHz

For conducted measurements a dummy load was used as delivered by applicant. A short description of the circuit and the method to stop modulation can be found in the following figure.

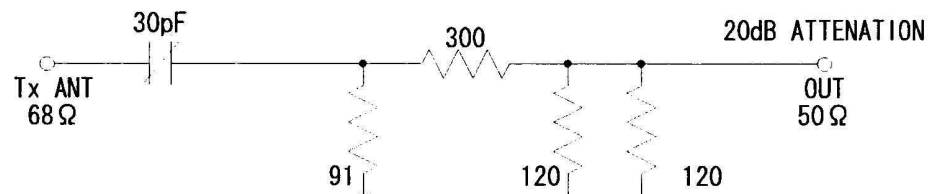

¹ Modulation as indicated on appropriate test record

² For conducted measurements replaced by external DC supply

³ For radiated emissions only

5. Configuration of EUT and Peripheral Devices

EUT is configured as stand-alone device

Configuration of cables of EUT

Not applicable

Configuration of peripheral devices connected to EUT

Not applicable

6. Measuring Methods

6.1. Maximum Transmitter Power (§95.639)

The maximum transmitter power was measured conducted and radiated.

6.1.1. Conducted Maximum Transmitter Power

A spectrum analyzer / EMI test receiver was connected to the output of the transmitter power amplifier (conducted measurement) via dummy load while EUT was operating in transmit mode using the assigned frequency.

The trace mode of the spectrum analyzer was set to max hold with:
 RBW = 100 kHz, VBW = 100 kHz, span = 1 MHz, sweep = 20 ms (auto mode)

See figure 1 for the measurement setup.

Test equipment used (see equipment list for details):
 02, 18, 51, 69, 70, 71

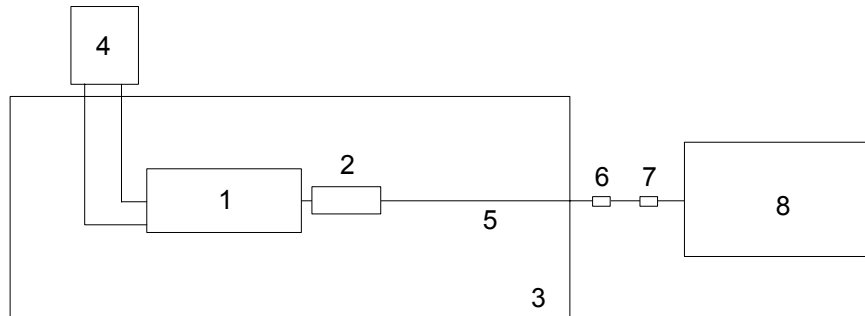

Figure 1: Measurement setup for testing on antenna connector

- | | |
|---------------------|---------------------|
| 1 Transmitter (EUT) | 5 Test cable |
| 2 Dummy load | 6 DC-block |
| 3 Wooden table | 7 Attenuator |
| 4 DC power supply | 8 Spectrum analyzer |

6.1.2. Radiated Maximum Transmitter Power

Radiated Maximum Transmitter Power was measured with detector-function of the spectrum analyzer set to positive peak and trace mode max hold:

RBW = 100 kHz, VBW = 100 kHz, span = 1 MHz, sweep = 15 s

For measurement setup and procedure see section "Unwanted Emission 30 MHz - 1 GHz (§95.635, §95.639)" on Page 13.

6.2. Frequency tolerance (§95.623)

6.2.1. Frequency stability vs. temperature

The frequency stability vs. temperature was measured with a spectrum analyzer connected to the output of the transmitter power amplifier (conducted measurement) via dummy load while EUT was operating in transmit mode using the assigned frequency.

The trace mode of the spectrum analyzer was set to write with frequency count mode activated:

RBW = 100 Hz, VBW = 100 Hz, span = 20 kHz, sweep = 1.5 s (auto mode)

See figure 2 for the measurement setup.

Test equipment used (see equipment list for details):
 02, 18, 51, 54, 69, 70, 71

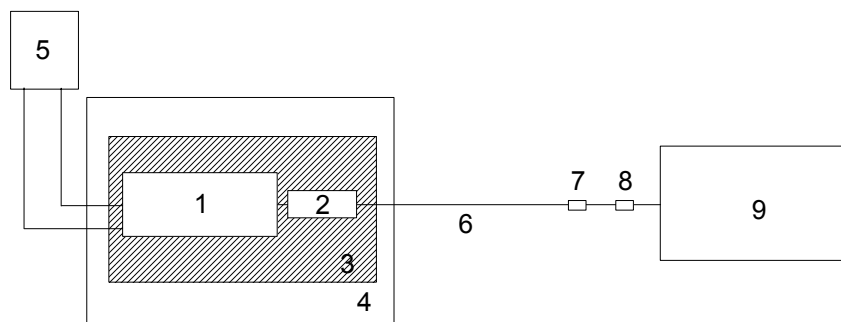

Figure 2: Measurement setup for testing within temperature test chamber

- | | |
|----------------------------|---------------------|
| 1 Transmitter (EUT) | 6 Test cable |
| 2 Dummy load | 7 DC-block |
| 3 Wooden support | 8 Attenuator |
| 4 Temperature test chamber | 9 Spectrum analyzer |
| 5 DC power supply | |

6.2.2. Frequency stability vs. supply voltage

The frequency stability vs. supply voltage was measured with a spectrum analyzer connected to the output of the transmitter power amplifier (conducted measurement) via dummy load while EUT was operating in transmit mode using the assigned frequency.

The trace mode of the spectrum analyzer was set to write with frequency count mode activated:

RBW = 100 Hz, VBW = 100 Hz, span = 20 kHz, sweep = 1.5 s (auto mode)

See figure 1 for the measurement setup.

Test equipment used (see equipment list for details):
02, 18, 51, 69, 70, 71

6.3. Emission Bandwidth (§95.633)

The emission bandwidth was measured as occupied bandwidth with a spectrum analyzer connected to the output of the transmitter power amplifier (conducted measurement) via dummy load while EUT was operating in transmit mode using the assigned frequency.

The occupied bandwidth measurement was performed referring to 99% of total power: The trace mode of the spectrum analyzer was set to max hold with RBW = 30 Hz, VBW = 30 Hz, span = 40 kHz, sweep = 90 s

See figure 1 for the measurement setup.

Test equipment used (see equipment list for details):
02, 18, 51, 69, 70, 71

6.4. Unwanted Emission 30 MHz - 1 GHz (§95.635, §95.639)

Radiated emissions were measured over the frequency range from 30 MHz to 1 GHz. For final testing the detector-function of the spectrum analyzer was set to positive peak and trace mode max hold:

RBW = 3 kHz, VBW = 10 kHz, span = 20 kHz, sweep = 10 s

Measurements were made in both the horizontal and vertical planes of polarization. The scans were taken in a fully-anechoic room using a spectrum analyzer with the detector function set to peak and resolution bandwidth set to 100 kHz. All tests were performed at a test-distance of 3 meters. Hand-held or body-worn devices are rotated through three orthogonal axes to determine which attitude and configuration produces the highest emission relative to the limit and therefore shall be used for final testing. During the tests the EUT was rotated all around to find the maximum levels of emissions. The cables and equipment were placed and moved within the range of position likely to find their maximum emissions.

Final testing was performed referring to substitution method as described in TIA/EIA-603, section 2.2.12 ("Radiated Spurious Emissions").

See figure 3 for the measurement setup.

Test equipment used (see equipment list for details):

01, 06, 12, 15, 38, 39, 40, 41, 55, 58, 61, 64, 66

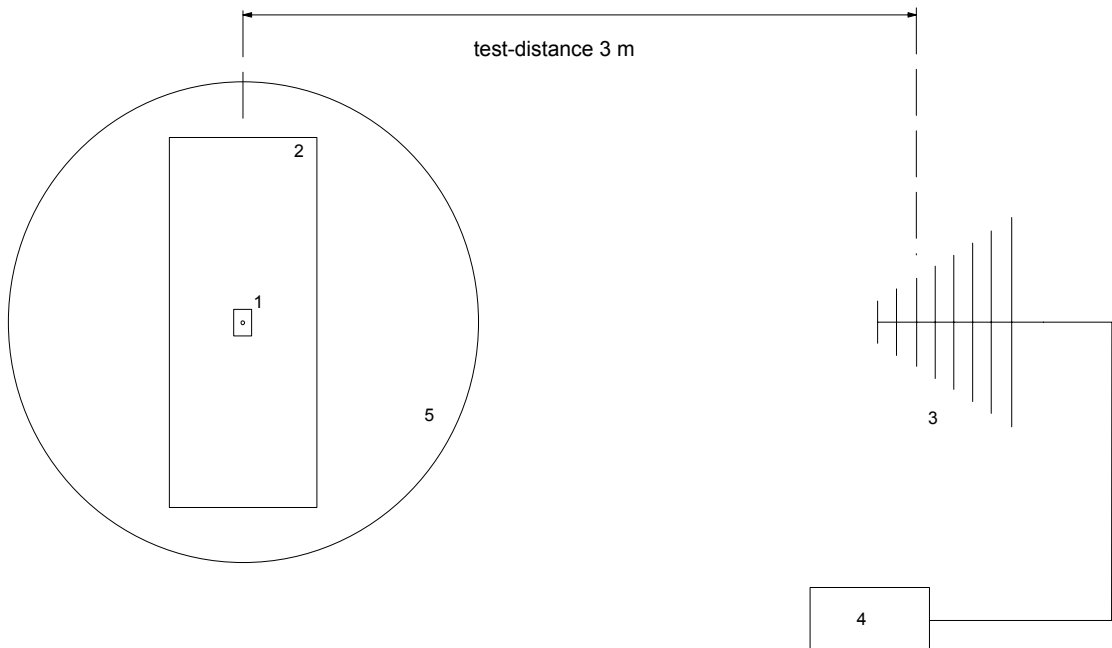

Figure 3: Measurement setup for radiated emission test

- 1 Transmitter (EUT)
- 2 Wooden table

- 3 Measurement antenna
- 4 Test receiver
- 5 Turn table

7. Photographs of Test Setups

Test setup unwanted radiation 30 MHz - 1 GHz



Test setup unwanted radiation 30 MHz - 1 GHz (continued)



8. Equipment List

To facilitate reference to test equipment used for related tests, each item of test equipment and ancillaries such as cables are identified (numbered) by the Test Laboratory.

No.	Type	Model	Serial Number	Manufacturer
01	Spectrum Analyzer	R 3271	05050023	Advantest
02	EMI Test Receiver	ESMI	839379/013 839587/006	Rohde & Schwarz
03	Test Receiver	ESH 3	880112/032	Rohde & Schwarz
04	Test Receiver	ESHS 10	860043/016	Rohde & Schwarz
05	Test Receiver	ESV	881414/009	Rohde & Schwarz
06	Test Receiver	ESVP	881120/024	Rohde & Schwarz
07	Audio Analyzer	UPA	862954	Rohde & Schwarz
08	Power Meter	NRVS	836856/015	Rohde & Schwarz
09	Power Sensor	NRV-Z52	837901/030	Rohde & Schwarz
10	Power Sensor	NRV-Z4	863828/015	Rohde & Schwarz
11	Preamplifier	ESV-Z3	860907/004	Rohde & Schwarz
12	Preamplifier	R14601		Advantest
13	Preamplifier	ACX/080-3030	32640	CTT
14	Preamplifier	ACO/180-3530	32641	CTT
15	Signal generator	SMY 01	830694/001	Rohde & Schwarz
16	Signal Generator	HP 8673 D	2930A00966	Hewlett Packard
17	Waveform Generator	HP 33120 A	US34005375	Hewlett Packard
18	Attenuator 20 dB	4776-20	9503	Narda
19	Attenuator 10 dB	4776-10	9412	Narda
20	Pulse Limiter	ESH 3-Z2	1144	Rohde & Schwarz
21	Pulse Limiter	11947 A	3107A00566	Hewlett Packard
22	V-Network	ESH 3-Z5	862770/018	Rohde & Schwarz
23	V-Network	ESH 3-Z5	894785/005	Rohde & Schwarz
24	V-Network	ESH 3-Z5	830952/025	Rohde & Schwarz
25	V-Network	ESH 3-Z6	830722/010	Rohde & Schwarz
26	V-Network	NSLK 8127	8127152	Schwarzbeck
27	V-Network	NNLA 8119	8119148	Schwarzbeck
28	V-Network	SE 01	01	Senton
29	T-Network	ESH 3-Z4	890602/011	Rohde & Schwarz
30	T-Network	ESH 3-Z4	890602/012	Rohde & Schwarz
31	High Impedance Probe	TK 9416	01	Schwarzbeck
32	High Impedance Probe	TK 9416	02	Schwarzbeck
33	Current Probe	ESH 2-Z1	863366/18	Rohde & Schwarz
34	Current Probe	ESV-Z1	862553/3	Rohde & Schwarz

No.	Type	Model	Serial Number	Manufacturer
35	Absorbing Clamp	MDS 21	80911	Lüthi
36	Absorbing Clamp	MDS 21	79690	Lüthi
37	Loop Antenna	HFH2-Z2	882964/1	Rohde & Schwarz
38	Biconical Antenna	HK 116	842204/001	Rohde & Schwarz
39	Biconical Antenna	HK 116	836239/02	Rohde & Schwarz
40	Log. Periodic Antenna	HL 223	841516/023	Rohde & Schwarz
41	Log. Periodic Antenna	HL 223	834408/12	Rohde & Schwarz
42	Horn Antenna	3115	9508-4553	Emco
43	Horn Antenna	3160-03	9112-1003	Emco
44	Horn Antenna	3160-04	9112-1001	Emco
45	Horn Antenna	3160-05	9112-1001	Emco
46	Horn Antenna	3160-06	9112-1001	Emco
47	Horn Antenna	3160-07	9112-1008	Emco
48	Horn Antenna	3160-08	9112-1002	Emco
49	Horn Antenna	3160-09	9403-1025	Emco
50	Digital multimeter	199	463386	Keithley
51	DC Power Supply	NGSM 32/10	203	Rohde & Schwarz
52	DC Power Supply	NGB	2455	Rohde & Schwarz
53	DC Power Supply	NGA	386	Rohde & Schwarz
54	Temperature Test Chamber	HT4010	07065550	Heraeus
55	Cable	RG214	1309	Senton
56	Cable	200CM_001	1357	Rosenberger
57	Cable	150CM_001	1479	Rosenberger
58	Cable Set EG1	RG214	1189 - 1191	Senton
59	Cable Set Cabine 1	RG214		Senton
60	Cable Set Cabine 2	RG214		Senton
61	Cable Set Cabine 3	RG214		Senton
62	Shielded Room	No. 1	1451	Senton
63	Shielded Room	No. 2	1452	Senton
64	Semi-anechoic Chamber	No. 3	1453	Siemens
65	Shielded Room	No. 4	1454	Euroshield
66	Open Area Test Site	EG 1		Senton
67	Cable for Antenna Connector			Lucent Technologies
68	DC Block 0.01-18GHz		8037	Inmet Corp.
69	High pass filter			Lucent Technologies
69	DC Block	7006	A2798	Weinschel Corp.
70	Cable for Antenna Connector			Senton
71	Dummy load			Futaba Corporation

9. Referenced Regulations

All tests were performed with reference to the following regulations and standards:

<input checked="" type="checkbox"/>	CFR 47 Part 2	Code of Federal Regulations Part 2 (Frequency Allocations And Radio Treaty Matters, General Rules And Regulations) of the Federal Communication Commission (FCC)	October 1, 1999
<input type="checkbox"/>	CFR 47 Part 15 Subpart A	Code of Federal Regulations Part 15 (Radio Frequency Devices), Subpart A (General) of the Federal Communication Commission (FCC)	October 1, 1999
<input type="checkbox"/>	CFR 47 Part 15 Subpart B	Code of Federal Regulations Part 15 (Radio Frequency Devices), Subpart B (Unintentional Radiators) of the Federal Communication Commission (FCC)	October 1, 1999
<input type="checkbox"/>	CFR 47 Part 15 Subpart C	Code of Federal Regulations Part 15 (Radio Frequency Devices), Subpart C (Intentional Radiators) of the Federal Communication Commission (FCC)	October 1, 1999
<input checked="" type="checkbox"/>	CFR 47 Part 95 Subpart C/E	Code of Federal Regulations Part 95 (Personal Radio Services), Subpart C/E (Radio Control(R/C) Radio Service) of the Federal Communication Commission (FCC)	October 1, 1998
<input type="checkbox"/>	ANSI C63.4	American National Standard for Methods of Measurement of Radio-Noise Emissions from Low-Voltage Electrical and Electronic Equipment in the Range of 9 kHz - 40 GHz	October, 1992
<input type="checkbox"/>	RSS-210	Radio Standards Specification RSS-210 Issue 2 for Low Power Licence-Exempt Radiocommunication Devices of Industry Canada	February 24, 1996
<input checked="" type="checkbox"/>	TIA/EIA-603	Land Mobile FM or PM Communications Equipment Measurement and Performance Standards	February, 1993
<input checked="" type="checkbox"/>	TIA/EIA-603-1	Addendum to TIA/EIA-603	March 4, 1998

10. List of Measurements

CFR 47 Part 95 Subpart C / E CFR 47 Part 2 Subpart J			
Section(s):	Test	Page	Result
§95.639	Maximum transmitter power	22	Passed
§95.623	Frequency tolerance	24	Passed
§95.633	Emission bandwidth	26	Passed
§95.635	Unwanted radiation 30 MHz - 1 GHz	28	Passed

11. Test Results

MAXIMUM TRANSMITTER POWER - CONDUCTED**Section 95.639b3**

EUT: TX6EXA 72 MHz
Serial number: 001
Applicant: Futaba Corporation
Mode: - transmitting continuously (TX mode)
- operating with f = 72.510 MHz
Date of test: 08 January 2003
Operator: Thomas Eberl

Test conditions:

Temperature: +20°C
Nominal supply voltage: 9.6V DC

Specifications:

Voltage range: ±15 % of nominal supply voltage

Supply voltage (V)	Modulation	Transmitter power (dBm)	Transmitter power (W)	Limit (W)
8.16	off	24.00	0.251	0.750
9.60	off	25.00	0.316	0.750
11.04	off	25.30	0.338	0.750
8.16	on	23.50	0.223	0.750
9.60	on	24.30	0.269	0.750
11.04	on	24.70	0.295	0.750

Result: Test passed

MAXIMUM TRANSMITTER POWER - RADIATED SECTION 95.639B3

EUT: TX6EXA 72 MHz
Serial number: 001
Applicant: Futaba Corporation
Mode: - transmitting continuously (TX mode)
- with modulation
- with supply voltage 9.6 V DC
- antenna extended to maximum
- operating with $f = 72.510$ MHz
Date of test: 08 January 2003
Operator: Thomas Eberl

Test conditions:

Temperature: +20°C
Voltage supply: Fully charged batteries (9.6 V DC nominal)

Note 1:

Limit of 28.8 dBm corresponds to 0.75 W.

Note 2:

For calculation of correction factors see tables "Test Site Calibration Data Sheets" (supplied as additional information summarized on page 56).

Position of EUT	Frequency (MHz)	Polarisation V/H	Reading value (dBm)	Correction factor (dB)	ERP (dBm)	Limit (dBm)
vertical, antenna vertical	72.550	V	-10.50	25.99	15.49	28.8
horiz., antenna horizontal	72.550	H	-10.90	26.26	15.36	28.8
horiz., right side on table	72.550	H	-11.30	26.26	14.96	28.8

Result: Test passed

FREQUENCY STABILITY VS. TEMPERATURE**Section 95.623c**

EUT: TX6EXA 72 MHz
Serial number: 001
Applicant: Futaba Corporation
Mode: - transmitting continuously (TX mode)
- without modulation
- operating with $f = 72.510$ MHz
Date of test: January 08, 2003
Operator: Thomas Eberl

Test conditions:

Temperature: see table below
Supply voltage: 9.6 V DC

Specifications:

Frequency tolerance: ± 0.002 % of nominal carrier frequency
Temperature range: -30 to +50°C

Temperature (°C)	Nominal car. frequency (MHz)	Frequency measured (MHz)	Frequency deviation (Hz)	Frequency deviation (%)	Limit (%)
-30	72.510	72.50965	-350	0.0004894	0.002
-20	72.510	72.51006	+60	0.0000839	0.002
-10	72.510	72.51031	+310	0.0004335	0.002
0	72.510	72.51033	+330	0.0004614	0.002
+10	72.510	72.51025	+250	0.0003496	0.002
+20	72.510	72.51008	+80	0.0001118	0.002
+30	72.510	72.50989	-110	0.0001538	0.002
+40	72.510	72.50974	-260	0.0003635	0.002
+50	72.510	72.50968	-320	0.0004474	0.002

Result: Test passed

FREQUENCY STABILITY VS. SUPPLY VOLTAGE**Section 95.623c**

EUT: TX6EXA 72 MHz
Serial number: 001
Applicant: Futaba Corporation
Mode: - transmitting continuously (TX mode)
- without modulation
- operating with $f = 72.510$ MHz
Date of test: January 08, 2003
Operator: Thomas Eberl

Test conditions:

Temperature: +20°C
Nominal supply voltage: 9.6 V DC

Specifications:

Frequency tolerance: ± 0.002 % of nominal carrier frequency
Voltage range: ± 15 % of nominal supply voltage

Supply voltage (V)	Nominal car. frequency (MHz)	Frequency measured (MHz)	Frequency deviation (Hz)	Frequency deviation (%)	Limit (%)
8.16	72.510	72.51006	+60	0.0000839	0.002
8.50	72.510	72.51006	+60	0.0000839	0.002
9.00	72.510	72.51006	+60	0.0000839	0.002
9.60	72.510	72.51006	+60	0.0000839	0.002
10.00	72.510	72.51006	+60	0.0000839	0.002
10.50	72.510	72.51006	+60	0.0000839	0.002
11.04	72.510	72.51006	+60	0.0000839	0.002
Batt. end point (V)					
6.5	72.510	72.51004	+40	0.0000559	0.002

Note: EUT is equipped with a low batt warning indicator - starts at 8.65 V !!

Result: Test passed

EMISSION BANDWIDTH**Section 95.633b**

EUT: TX6EXA 72 MHz
Serial number: 001
Applicant: Futaba Corporation
Mode: - transmitting continuously (TX mode)
- with modulation
- operating with $f = 72.510$ MHz
Date of test: 08 January 2003
Operator: Thomas Eberl

Test conditions:

Temperature: +20°C
Supply voltage: 12.0 V DC

Specifications:

Authorized bandwidth: 8 kHz

Note:

Emission bandwidth was measured as occupied bandwidth. For details see plot on following page.

Test procedure	Measured occupied bandwidth (kHz)	Limit (kHz)
TIA/EI-603	4.7	8.00

Result: Test passed

EMISSION BANDWIDTH (CONTINUED))

Section 95.633b

Specifications:

Authorized bandwidth: 8 kHz
Test procedure: TIA/EIA-603 (99% of total power with RBW as close to, but not less than 1% of the 99% power bandwidth)

Note:

Tested on antenna connector via dummy load

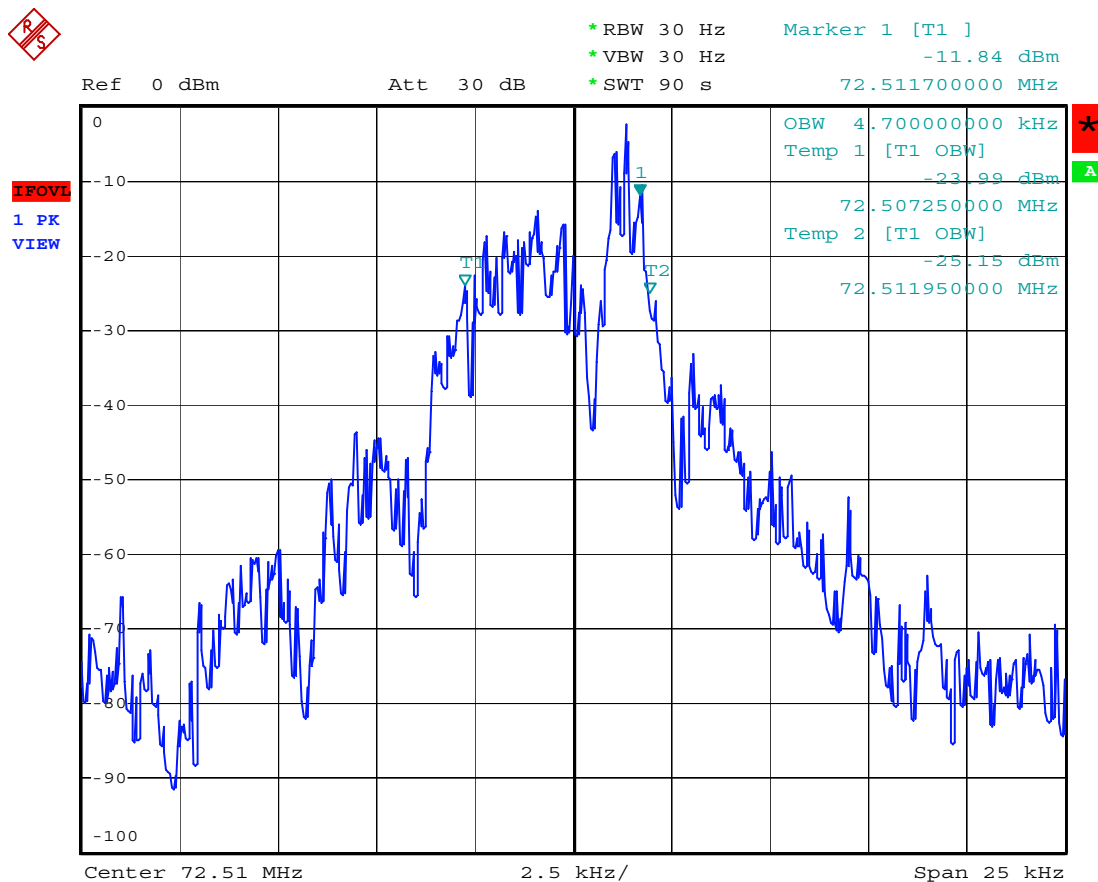

UNWANTED RADIATION 30 MHz - 1 GHz

Section 95.635

EUT: TX6EXA 72 MHz
 Serial number: 001
 Applicant: Futaba Corporation

Mode: - transmitting continuously (TX mode)
 - with modulation
 - with supply voltage 9.6 V DC
 - antenna extended to maximum
 - operating with $f = 72.510$ MHz
 - EUT in vertical position, antenna to the top

Date of test: January 07, 2003
 Operator: Thomas Eberl

Specifications:

Test-distance: 3 meters
 Limit: $10 \log(P_{\text{carrier}}) - 56$ dB
 with P_{carrier} as the maximum transmitter power limit in W for the unmodulated carrier according to §95.639

Maximum transmitter power (conducted) :	25.3 dBm	0.338 Watt
Maximum carrier power (radiated) :	15.49 dBm	0.035 Watt
Calculated limit (referring to TP) :	-26.0 dBm	

Frequency (MHz)	Polarization V/H	Reading value (dBm)	Correction factor (dB)	ERP (dBm)	Calculated limit (dBm)	Margin to limit (dB)
57.900	V	-83.13	26.11	-57.02	-26.0	31.02
72.510	V	-10.50	25.99	15.49	28.8	13.31
86.950	V	-70.68	27.24	-43.44	-26.0	17.44
145.020	V	-65.78	23.25	-42.53	-26.0	16.53
217.530	V	-72.23	21.45	-50.78	-26.0	24.78
290.040	V	-83.44	27.31	-56.13	-26.0	30.13
362.550	H	-87.06	28.46	-58.60	-26.0	32.60
435.060	V	-78.09	30.62	-47.47	-26.0	21.47
507.570	V	-81.33	30.27	-51.06	-26.0	25.06
580.080	V	-89.86	32.75	-57.11	-26.0	31.11
652.590	V	-87.09	33.77	-53.32	-26.0	27.32
725.100	V	-87.89	32.95	-54.94	-26.0	28.94
797.610	V	-91.55	35.59	-55.96	-26.0	29.96
870.120	V	-79.81	37.07	-42.74	-26.0	16.74
942.630	V	87.05	36.51	-50.53	-26.0	24.53

Note: For calculation of correction factors see tables "Test Site Calibration Data Sheets" (supplied as additional information summarized on page 56).

Result: Test passed

UNWANTED RADIATION 30 MHz - 1 GHz

Section 95.635

EUT: TX6EXA 72 MHz
 Serial number: 001
 Applicant: Futaba Corporation

Mode: - transmitting continuously (TX mode)
 - with modulation
 - with supply voltage 9.6 V DC
 - antenna extended to maximum
 - operating with $f = 72.510$ MHz
 - EUT in horizontal position with rear side on table

Date of test: 08 January 2003
 Operator: Thomas Eberl

Specifications:

Test-distance: 3 meters
 Limit: $10 \log(P_{\text{carrier}}) - 56$ dB
 with P_{carrier} as the maximum transmitter power limit in W for the unmodulated carrier according to §95.639

Maximum transmitter power (conducted) :	25.3 dBm	0.338 Watt
Maximum carrier power (radiated) :	15.49 dBm	0.035 Watt
Calculated limit (referring to TP) :	-26.0 dBm	

Frequency (MHz)	Polarization V/H	Reading value (dBm)	Correction factor (dB)	ERP (dBm)	Calculated limit (dBm)	Margin to limit (dB)
57.90	H	-82.19	26.08	-56.11	-26.0	30.11
72.51	H	-10.90	26.26	15.36	28.8	13.44
86.95	H	-70.20	26.90	-43.30	-26.0	17.30
145.02	H	-66.62	23.75	-42.87	-26.0	16.87
217.53	H	-69.68	22.35	-47.34	-26.0	21.34
290.04	H	-75.13	25.7	-49.43	-26.0	23.43
362.55	H	-81.97	28.46	-53.51	-26.0	27.51
435.06	H	-75.34	31.75	-43.59	-26.0	17.59
507.57	H	-78.54	32.02	-46.52	-26.0	20.52
580.08	H	-88.44	31.04	-57.39	-26.0	31.39
652.59	H	-84.81	31.81	-53.00	-26.0	27.00
725.10	H	-85.89	35.03	-50.86	-26.0	24.86
797.61	H	-90.08	35.72	-54.37	-26.0	28.37
870.12	V	-80.13	37.7	-43.07	-26.0	17.07
942.63	H	-80.61	35.73	-44.87	-26.0	18.87

Note: For calculation of correction factors see tables "Test Site Calibration Data Sheets" (supplied as additional information summarized on page 56).

Result: Test passed

UNWANTED RADIATION 30 MHz - 1 GHz

Section 95.635

EUT: TX6EXA 72 MHz
 Serial number: 001
 Applicant: Futaba Corporation

Mode: - transmitting continuously (TX mode)
 - with modulation
 - with supply voltage 9.6 V DC
 - antenna extended to maximum
 - operating with f = 72.510 MHz
 - EUT in horizontal position with right side on table

Date of test: 08 January 2003
 Operator: Thomas Eberl

Specifications:

Test-distance: 3 meters
 Limit: $10 \log(P_{\text{carrier}}) - 56 \text{ dB}$
 with P_{carrier} as the maximum transmitter power limit in W for the unmodulated carrier according to §95.639

Maximum transmitter power (conducted) :	25.3 dBm	0.338 Watt
Maximum carrier power (radiated) :	15.49 dBm	0.035 Watt
Calculated limit (referring to TP) :	-26.0 dBm	

Frequency (MHz)	Polarization V/H	Reading value (dBm)	Correction factor (dB)	ERP (dBm)	Calculated limit (dBm)	Margin to limit (dB)
72.51	H	-11.30	26.26	14.96	28.8	13.84
86.95	H	-71.56	26.90	-44.65	-26.0	18.65
145.02	H	-66.90	23.75	-43.16	-26.0	17.16
217.53	H	-69.83	22.35	-47.48	-26.0	21.48
290.04	H	-74.18	25.70	-48.48	-26.0	22.48
362.55	H	-82.10	28.46	-53.64	-26.0	27.64
435.06	H	-75.37	31.75	-43.62	-26.0	17.62
507.57	H	-80.60	32.02	-48.58	-26.0	22.58
580.08	H	-88.58	31.81	-57.54	-26.0	31.54
652.59	V	-86.77	33.77	-53.01	-26.0	27.01
725.10	H	-87.08	35.03	-52.05	-26.0	26.05
797.61	V	-90.25	35.59	-54.67	-26.0	28.67
870.12	V	-77.11	37.07	-40.04	-26.0	14.04
942.63	H	-82.33	35.73	-46.59	-26.0	20.56

Note: For calculation of correction factors see tables "Test Site Calibration Data Sheets" (supplied as additional information summarized on page 56).

Result: Test passed

12. Additional Results

Radiated Power Test 25 MHz - 200 MHz acc. to FCC Part 95 Subpart C/E

<p>Model: T6EXA 72 MHz</p> <p>Serial no.: Test sample 1</p> <p>Applicant: Futaba Corporation</p> <p>Test site: Fully anechoic room, cabin no. 2</p> <p>Tested on: Test distance 3 meters Horizontal Polarization</p> <p>Date of test: 01/07/2003 Operator: T. Eberl</p> <p>Test performed: automatically File name: default.emi</p>	<p>Comment:</p> <ul style="list-style-type: none"> - TX mode - EUT DC powered : 9.6 V (accu pack) - EUT in vertical position
--	---

<p>Detector: Peak</p>	<p>List of values: 10 dB Margin 8 Subranges</p>
----------------------------------	---

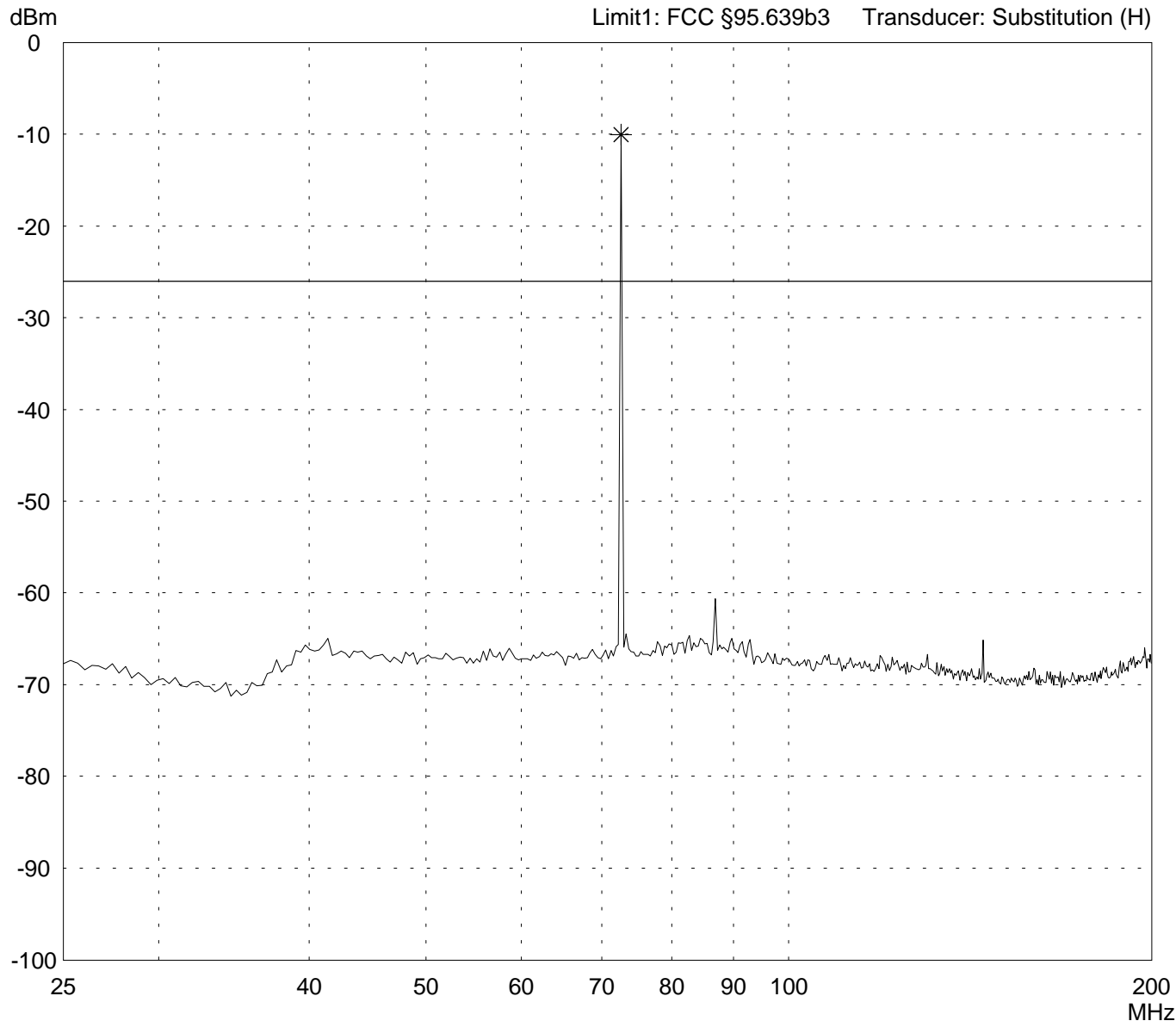

<p>Result: Prescan</p>	<p>Project file: 55503-20837</p> <p style="text-align: right;">Page 32 of 56 Pages</p>
-----------------------------------	---

Radiated Power Test 25 MHz - 200 MHz acc. to FCC Part 95 Subpart C/E

<p>Model: T6EXA 72 MHz</p> <p>Serial no.: Test sample 1</p> <p>Applicant: Futaba Corporation</p> <p>Test site: Fully anechoic room, cabin no. 2</p> <p>Tested on: Test distance 3 meters Horizontal Polarization</p> <p>Date of test: 01/07/2003</p> <p>Operator: T. Eberl</p> <p>Test performed: automatically</p> <p>File name: default.emi</p>	<p>Comment:</p> <ul style="list-style-type: none"> - TX mode - EUT DC powered : 9.6 V (accu pack) - EUT in horizontal position - rear side on table
--	--

<p>Detector: Peak</p>	<p>List of values: Selected by hand</p>
----------------------------------	--

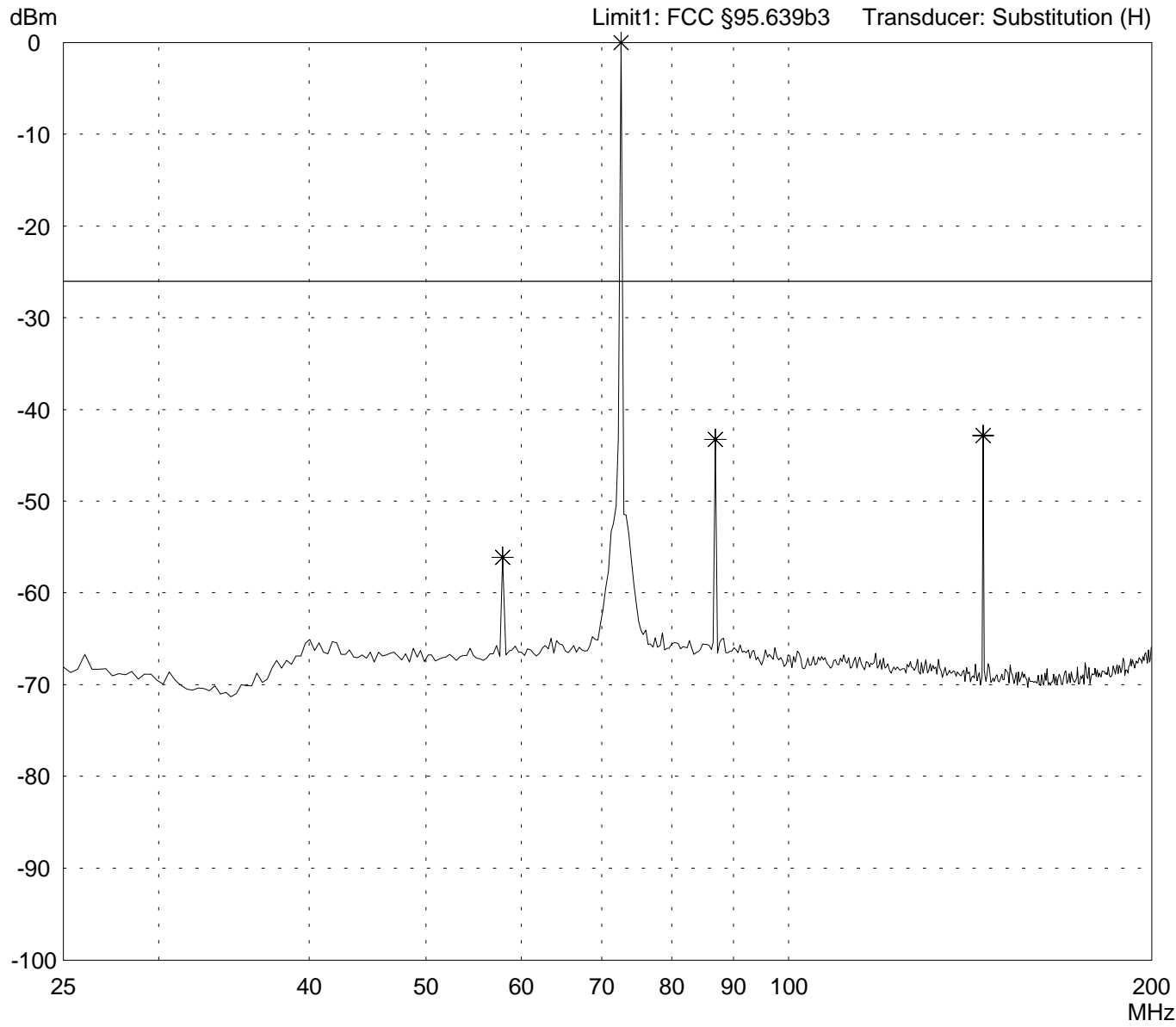

<p>Result: Prescan</p>	<p>Project file: 55503-20837</p> <p style="text-align: right;">Page 34 of 56 Pages</p>
-----------------------------------	---

**Radiated Power Test 25 MHz - 200 MHz
acc. to FCC Part 95 Subpart C/E**

Model: T6EXA 72 MHz	Comment: - TX mode - EUT DC powered : 9.6 V (accu pack) - EUT in horizontal position - rear side on table
Serial no.: Test sample 1	
Applicant: Futaba Corporation	
Test site: Fully anechoic room, cabin no. 2	
Tested on: Test distance 3 meters Horizontal Polarization	
Date of test: 01/07/2003 Operator: T. Eberl	
Test performed: automatically File name: default.emi	

Detector: Peak	List of values: Selected by hand
-------------------	-------------------------------------

<i>Frequency [MHz]</i>	<i>Reading [dBm]</i>	<i>Correction factor [dB]</i>	<i>Value [dBm]</i>	<i>Limit [dBm]</i>	<i>Limit exceeded</i>
57.900000	-82.19	26.08	-56.11	-26.00	
72.600000	-10.90	26.26	15.36	-26.00	*
86.950000	-70.20	26.90	-43.30	-26.00	
145.050000	-66.62	23.75	-42.87	-26.00	

Result: Prescan	Project file: 55503-20837	Page 35 of 56 Pages
--------------------	------------------------------	---------------------

Radiated Power Test 25 MHz - 200 MHz acc. to FCC Part 95 Subpart C/E

Model:
T6EXA 72 MHz

Serial no.:
Test sample 1

Applicant:
Futaba Corporation

Test site:
Fully anechoic room, cabin no. 2

Tested on:
Test distance 3 meters
Horizontal Polarization

Date of test: 01/07/2003
Operator: T. Eberl

Test performed: automatically
File name: default.emi

Comment:
- TX mode
- EUT DC powered : 9.6 V (accu pack)
- EUT in horizontal position
- right side on table

Detector:
Peak

List of values:
Selected by hand

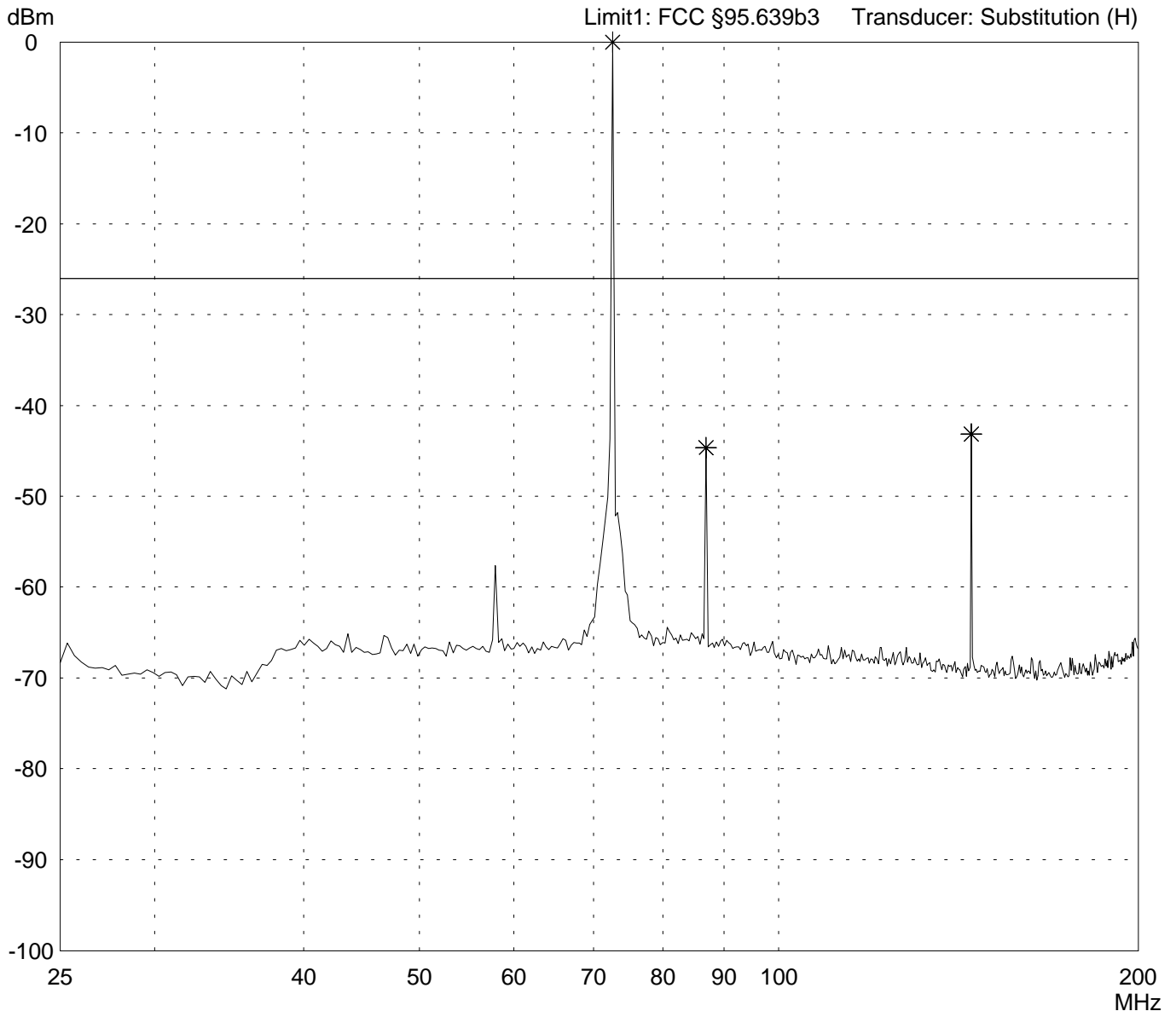

Result:
Prescan

Project file:
55503-20837

Page 36 of 56 Pages

**Radiated Power Test 25 MHz - 200 MHz
acc. to FCC Part 95 Subpart C/E**

<p>Model: T6EXA 72 MHz</p> <p>Serial no.: Test sample 1</p> <p>Applicant: Futaba Corporation</p> <p>Test site: Fully anechoic room, cabin no. 2</p> <p>Tested on: Test distance 3 meters Horizontal Polarization</p> <p>Date of test: Operator: 01/07/2003 T. Eberl</p> <p>Test performed: File name: automatically default.emi</p>	<p>Comment:</p> <ul style="list-style-type: none"> - TX mode - EUT DC powered : 9.6 V (accu pack) - EUT in horizontal position - right side on table
--	--

<p>Detector: Peak</p>	<p>List of values: Selected by hand</p>
----------------------------------	--

Frequency [MHz]	Reading [dBm]	Correction factor [dB]	Value [dBm]	Limit [dBm]	Limit exceeded
72.600000	-11.30	26.26	14.96	-26.00	*
86.950000	-71.56	26.90	-44.65	-26.00	
145.050000	-66.90	23.75	-43.16	-26.00	

<p>Result: Prescan</p>	<p>Project file: 55503-20837</p> <p style="text-align: right;">Page 37 of 56 Pages</p>
-----------------------------------	---

Radiated Power Test 200 MHz - 1 GHz acc. to FCC Part 95 Subpart C/E

<p>Model: T6EXA 72 MHz</p> <p>Serial no.: Test sample 1</p> <p>Applicant: Futaba Corporation</p> <p>Test site: Fully anechoic room, cabin no. 2</p> <p>Tested on: Test distance 3 meters Horizontal Polarization</p> <p>Date of test: 01/07/2003 Operator: T. Eberl</p> <p>Test performed: automatically File name: default.emi</p>	<p>Comment:</p> <ul style="list-style-type: none"> - TX mode - EUT DC powered : 9.6 V (accu pack) - EUT in vertical position - rear side on table
--	---

<p>Detector: Peak</p>	<p>List of values: Selected by hand</p>
----------------------------------	--

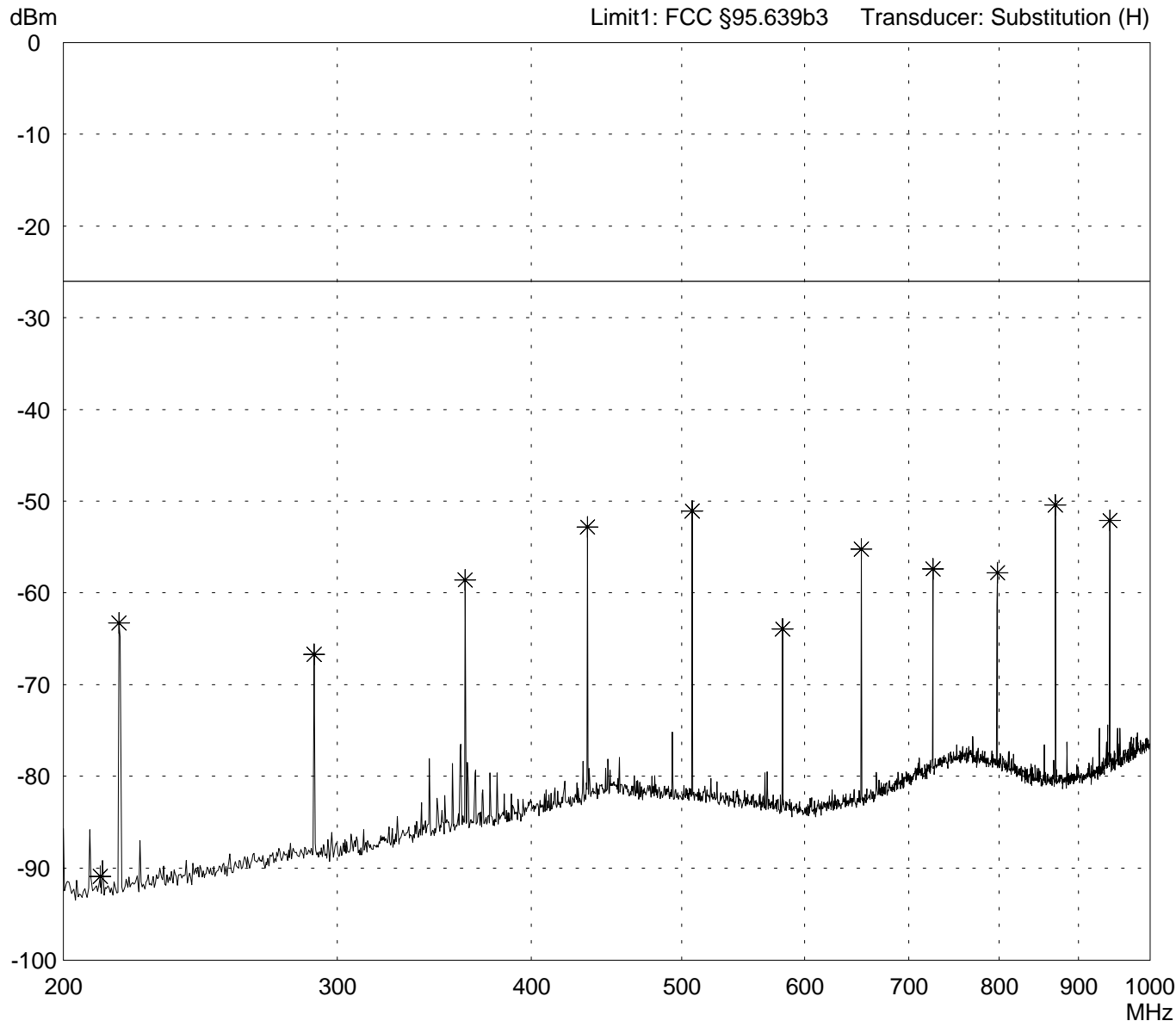

<p>Result: Prescan</p>	<p>Project file: 55503-20837</p> <p style="text-align: right;">Page 38 of 56 Pages</p>
-----------------------------------	---

**Radiated Power Test 200 MHz - 1 GHz
acc. to FCC Part 95 Subpart C/E**

<p>Model: T6EXA 72 MHz</p> <p>Serial no.: Test sample 1</p> <p>Applicant: Futaba Corporation</p> <p>Test site: Fully anechoic room, cabin no. 2</p> <p>Tested on: Test distance 3 meters Horizontal Polarization</p> <p>Date of test: 01/07/2003 Operator: T. Eberl</p> <p>Test performed: automatically File name: default.emi</p>	<p>Comment:</p> <ul style="list-style-type: none"> - TX mode - EUT DC powered : 9.6 V (accu pack) - EUT in vertical position - rear side on table
--	---

<p>Detector: Peak</p>	<p>List of values: Selected by hand</p>
----------------------------------	--

Frequency [MHz]	Reading [dBm]	Correction factor [dB]	Value [dBm]	Limit [dBm]	Limit exceeded
211.200000	-113.18	22.23	-90.95	-26.00	
217.200000	-85.64	22.35	-63.30	-26.00	
290.000000	-92.40	25.70	-66.70	-26.00	
362.800000	-87.06	28.46	-58.60	-26.00	
434.800000	-84.57	31.75	-52.82	-26.00	
507.600000	-83.12	32.02	-51.10	-26.00	
580.400000	-94.99	31.04	-63.95	-26.00	
652.400000	-87.04	31.81	-55.23	-26.00	
725.200000	-92.40	35.03	-57.37	-26.00	
798.000000	-93.50	35.72	-57.79	-26.00	
870.000000	-84.14	33.73	-50.41	-26.00	
942.800000	-87.83	35.73	-52.10	-26.00	

<p>Result: Prescan</p>	<p>Project file: 55503-20837</p> <p style="text-align: right;">Page 39 of 56 Pages</p>
-----------------------------------	---

Radiated Power Test 200 MHz - 1 GHz acc. to FCC Part 95 Subpart C/E

Model:
T6EXA 72 MHz

Serial no.:
Test sample 1

Applicant:
Futaba Corporation

Test site:
Fully anechoic room, cabin no. 2

Tested on:
Test distance 3 meters
Horizontal Polarization

Date of test: 01/07/2003
Operator: T. Eberl

Test performed: automatically
File name: default.emi

Comment:
- TX mode
- EUT DC powered : 9.6 V (accu pack)
- EUT in horizontal position
- rear side on table

Detector:
Peak

List of values:
Selected by hand

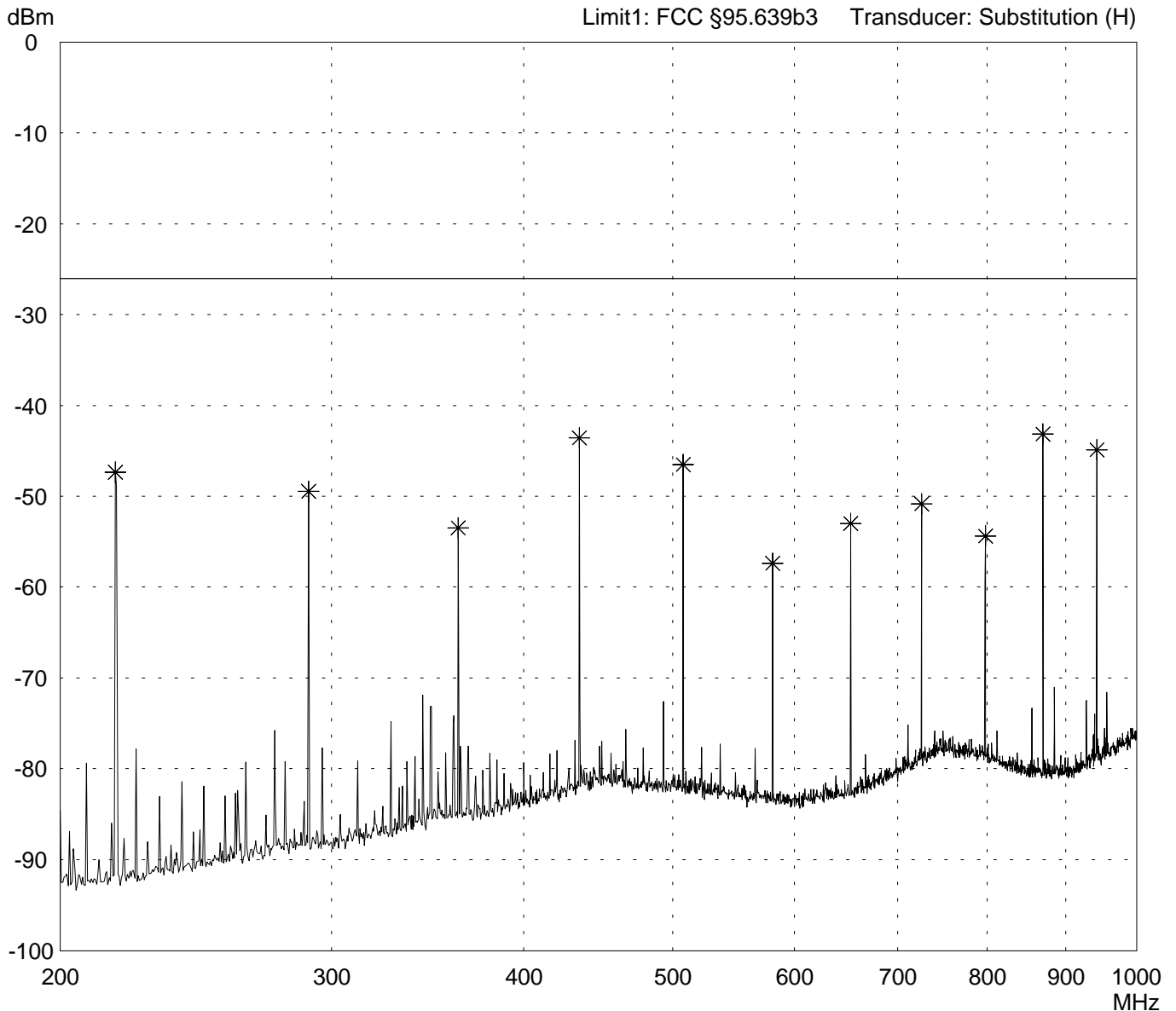

Result:
Prescan

Project file:
55503-20837

Page 40 of 56 Pages

**Radiated Power Test 200 MHz - 1 GHz
acc. to FCC Part 95 Subpart C/E**

Model: T6EXA 72 MHz	Comment: - TX mode - EUT DC powered : 9.6 V (accu pack) - EUT in horizontal position - rear side on table
Serial no.: Test sample 1	
Applicant: Futaba Corporation	
Test site: Fully anechoic room, cabin no. 2	
Tested on: Test distance 3 meters Horizontal Polarization	
Date of test: 01/07/2003 Operator: T. Eberl	
Test performed: automatically File name: default.emi	

Detector: Peak	List of values: Selected by hand
-------------------	-------------------------------------

<i>Frequency [MHz]</i>	<i>Reading [dBm]</i>	<i>Correction factor [dB]</i>	<i>Value [dBm]</i>	<i>Limit [dBm]</i>	<i>Limit exceeded</i>
217.200000	-69.68	22.35	-47.34	-26.00	
290.000000	-75.13	25.70	-49.43	-26.00	
362.800000	-81.97	28.46	-53.51	-26.00	
434.800000	-75.34	31.75	-43.59	-26.00	
507.600000	-78.54	32.02	-46.52	-26.00	
580.400000	-88.44	31.04	-57.39	-26.00	
652.400000	-84.81	31.81	-53.00	-26.00	
725.200000	-85.89	35.03	-50.86	-26.00	
798.000000	-90.08	35.72	-54.37	-26.00	
870.000000	-76.86	33.73	-43.14	-26.00	
942.800000	-80.61	35.73	-44.87	-26.00	

Result: Prescan	Project file: 55503-20837	Page 41 of 56 Pages
--------------------	------------------------------	---------------------

Radiated Power Test 200 MHz - 1 GHz acc. to FCC Part 95 Subpart C/E

<p>Model: T6EXA 72 MHz</p> <p>Serial no.: Test sample 1</p> <p>Applicant: Futaba Corporation</p> <p>Test site: Fully anechoic room, cabin no. 2</p> <p>Tested on: Test distance 3 meters Horizontal Polarization</p> <p>Date of test: 01/07/2003 Operator: T. Eberl</p> <p>Test performed: automatically File name: default.emi</p>	<p>Comment:</p> <ul style="list-style-type: none"> - TX mode - EUT DC powered : 9.6 V (accu pack) - EUT in horizontal position - right side on table
--	--

<p>Detector: Peak</p>	<p>List of values: Selected by hand</p>
----------------------------------	--

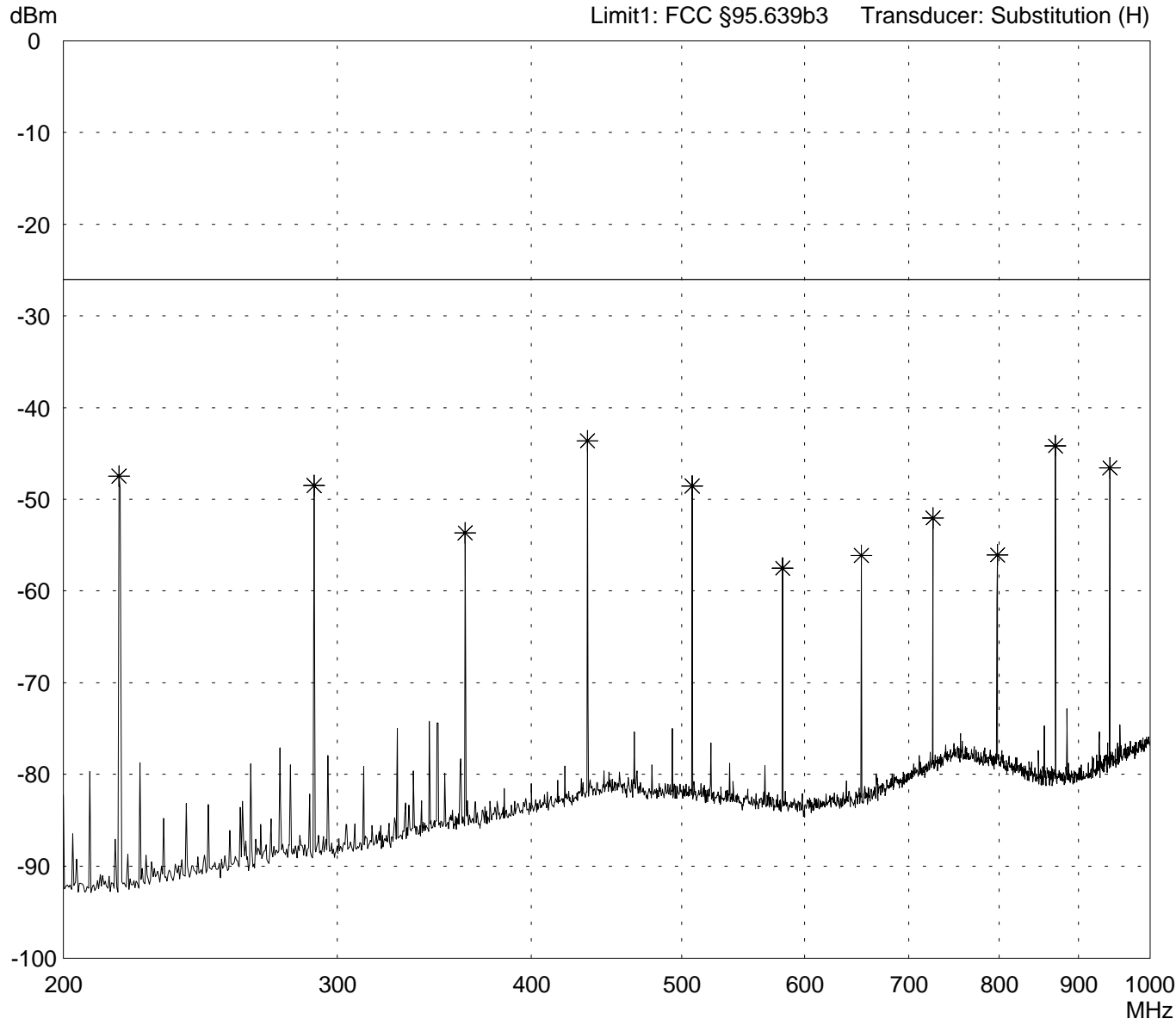

<p>Result: Prescan</p>	<p>Project file: 55503-20837</p> <p style="text-align: right;">Page 42 of 56 Pages</p>
-----------------------------------	---

**Radiated Power Test 200 MHz - 1 GHz
acc. to FCC Part 95 Subpart C/E**

Model: T6EXA 72 MHz	Comment: - TX mode - EUT DC powered : 9.6 V (accu pack) - EUT in horizontal position - right side on table
Serial no.: Test sample 1	
Applicant: Futaba Corporation	
Test site: Fully anechoic room, cabin no. 2	
Tested on: Test distance 3 meters Horizontal Polarization	
Date of test: 01/07/2003 Operator: T. Eberl	
Test performed: automatically File name: default.emi	

Detector: Peak	List of values: Selected by hand
-------------------	-------------------------------------

<i>Frequency [MHz]</i>	<i>Reading [dBm]</i>	<i>Correction factor [dB]</i>	<i>Value [dBm]</i>	<i>Limit [dBm]</i>	<i>Limit exceeded</i>
217.200000	-69.83	22.35	-47.48	-26.00	
290.000000	-74.18	25.70	-48.48	-26.00	
362.800000	-82.10	28.46	-53.64	-26.00	
434.800000	-75.37	31.75	-43.62	-26.00	
507.600000	-80.60	32.02	-48.58	-26.00	
580.400000	-88.58	31.04	-57.54	-26.00	
652.400000	-87.96	31.81	-56.15	-26.00	
725.200000	-87.08	35.03	-52.05	-26.00	
798.000000	-91.80	35.72	-56.09	-26.00	
870.000000	-77.88	33.73	-44.16	-26.00	
942.800000	-82.33	35.73	-46.59	-26.00	

Result: Prescan	Project file: 55503-20837	Page 43 of 56 Pages
--------------------	------------------------------	---------------------

Radiated Power Test 25 MHz - 200 MHz acc. to FCC Part 95 Subpart C/E

<p>Model: T6EXA 72 MHz</p> <p>Serial no.: Test sample 1</p> <p>Applicant: Futaba Corporation</p> <p>Test site: Fully anechoic room, cabin no. 2</p> <p>Tested on: Test distance 3 meters Vertical Polarization</p> <p>Date of test: 01/07/2003 Operator: T. Eberl</p> <p>Test performed: automatically File name: default.emi</p>	<p>Comment:</p> <ul style="list-style-type: none"> - TX mode - EUT DC powered : 9.6 V (accu pack) - EUT in vertical position
--	---

<p>Detector: Peak</p>	<p>List of values: Selected by hand</p>
----------------------------------	--

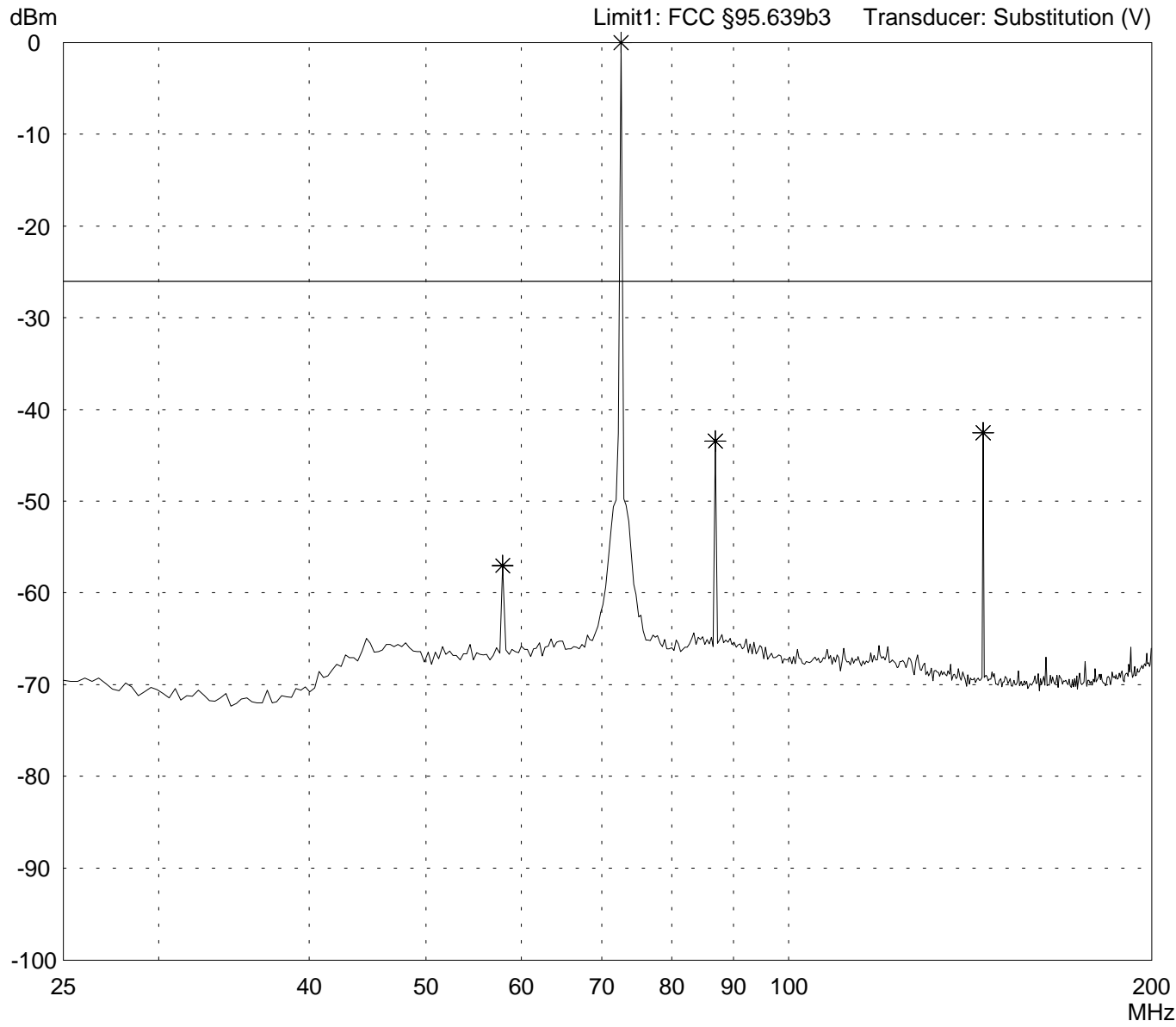

<p>Result: Prescan</p>	<p>Project file: 55503-20837</p> <p style="text-align: right;">Page 44 of 56 Pages</p>
-----------------------------------	---

**Radiated Power Test 25 MHz - 200 MHz
acc. to FCC Part 95 Subpart C/E**

<p>Model: T6EXA 72 MHz</p> <p>Serial no.: Test sample 1</p> <p>Applicant: Futaba Corporation</p> <p>Test site: Fully anechoic room, cabin no. 2</p> <p>Tested on: Test distance 3 meters Vertical Polarization</p> <p>Date of test: Operator: 01/07/2003 T. Eberl</p> <p>Test performed: File name: automatically default.emi</p>	<p>Comment:</p> <ul style="list-style-type: none"> - TX mode - EUT DC powered : 9.6 V (accu pack) - EUT in vertical position
--	---

<p>Detector: Peak</p>	<p>List of values: Selected by hand</p>
----------------------------------	--

<i>Frequency [MHz]</i>	<i>Reading [dBm]</i>	<i>Correction factor [dB]</i>	<i>Value [dBm]</i>	<i>Limit [dBm]</i>	<i>Limit exceeded</i>
57.900000	-83.13	26.11	-57.02	-26.00	
72.600000	-10.50	25.99	15.49	-26.00	*
86.950000	-70.68	27.24	-43.44	-26.00	
145.050000	-65.78	23.25	-42.53	-26.00	

<p>Result: Prescan</p>	<p>Project file: 55503-20837</p> <p style="text-align: right;">Page 45 of 56 Pages</p>
-----------------------------------	---

Radiated Power Test 25 MHz - 200 MHz acc. to FCC Part 95 Subpart C/E

<p>Model: T6EXA 72 MHz</p> <p>Serial no.: Test sample 1</p> <p>Applicant: Futaba Corporation</p> <p>Test site: Fully anechoic room, cabin no. 2</p> <p>Tested on: Test distance 3 meters Vertical Polarization</p> <p>Date of test: 01/07/2003 Operator: T. Eberl</p> <p>Test performed: automatically File name: default.emi</p>	<p>Comment:</p> <ul style="list-style-type: none"> - TX mode - EUT DC powered : 9.6 V (accu pack) - EUT in horizontal position - rear side on table
--	---

<p>Detector: Peak</p>	<p>List of values: 10 dB Margin 8 Subranges</p>
----------------------------------	---

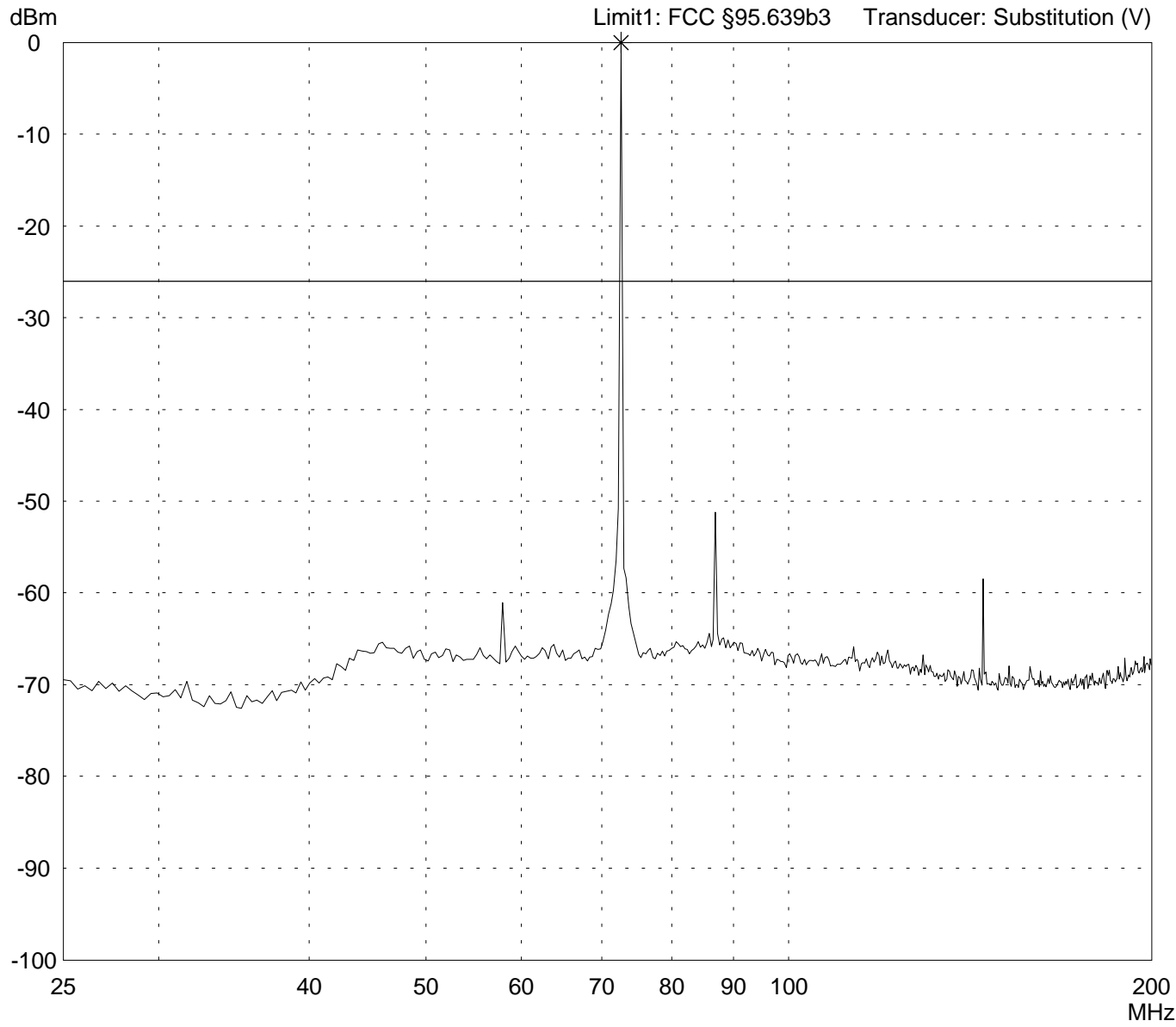

<p>Result: Prescan</p>	<p>Project file: 55503-20837</p> <p style="text-align: right;">Page 46 of 56 Pages</p>
-----------------------------------	---

Radiated Power Test 25 MHz - 200 MHz acc. to FCC Part 95 Subpart C/E

<p>Model: T6EXA 72 MHz</p> <p>Serial no.: Test sample 1</p> <p>Applicant: Futaba Corporation</p> <p>Test site: Fully anechoic room, cabin no. 2</p> <p>Tested on: Test distance 3 meters Vertical Polarization</p> <p>Date of test: 01/07/2003 Operator: T. Eberl</p> <p>Test performed: automatically File name: default.emi</p>	<p>Comment:</p> <ul style="list-style-type: none"> - TX mode - EUT DC powered : 9.6 V (accu pack) - EUT in horizontal position - right side on table
--	--

<p>Detector: Peak</p>	<p>List of values: Selected by hand</p>
----------------------------------	--

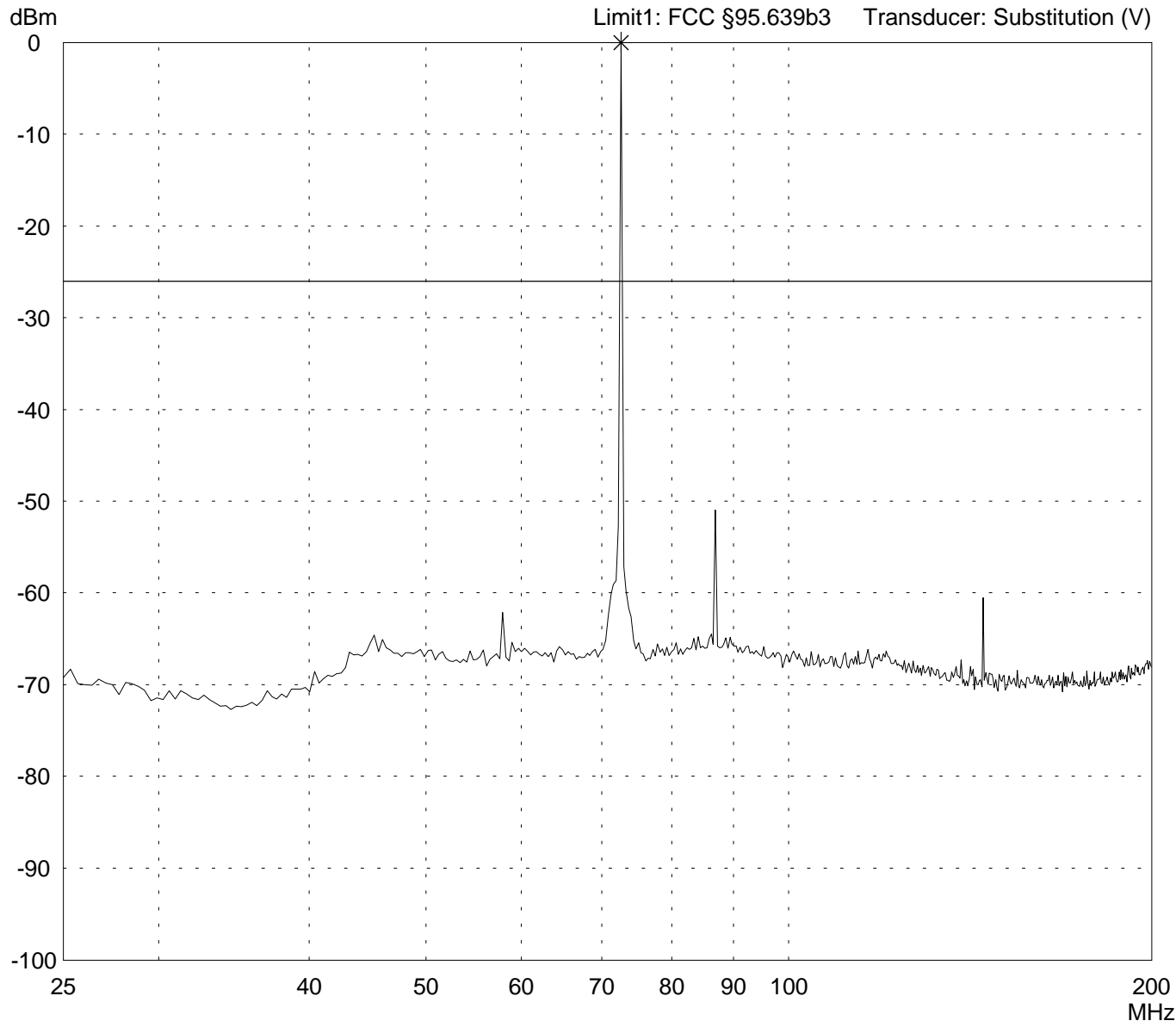

<p>Result: Prescan</p>	<p>Project file: 55503-20837</p> <p style="text-align: right;">Page 48 of 56 Pages</p>
-----------------------------------	---

**Radiated Power Test 25 MHz - 200 MHz
acc. to FCC Part 95 Subpart C/E**

<p>Model: T6EXA 72 MHz</p> <p>Serial no.: Test sample 1</p> <p>Applicant: Futaba Corporation</p> <p>Test site: Fully anechoic room, cabin no. 2</p> <p>Tested on: Test distance 3 meters Vertical Polarization</p> <p>Date of test: 01/07/2003 Operator: T. Eberl</p> <p>Test performed: automatically File name: default.emi</p>	<p>Comment:</p> <ul style="list-style-type: none"> - TX mode - EUT DC powered : 9.6 V (accu pack) - EUT in horizontal position - right side on table
--	--

<p>Detector: Peak</p>	<p>List of values: Selected by hand</p>
----------------------------------	--

Frequency [MHz]	Reading [dBm]	Correction factor [dB]	Value [dBm]	Limit [dBm]	Limit exceeded
72.600000	-18.10	25.99	7.89	-26.00	*

<p>Result: Prescan</p>	<p>Project file: 55503-20837</p> <p style="text-align: right;">Page 49 of 56 Pages</p>
-----------------------------------	---

Radiated Power Test 200 MHz - 1 GHz acc. to FCC Part 95 Subpart C/E

<p>Model: T6EXA 72 MHz</p> <p>Serial no.: Test sample 1</p> <p>Applicant: Futaba Corporation</p> <p>Test site: Fully anechoic room, cabin no. 2</p> <p>Tested on: Test distance 3 meters Vertical Polarization</p> <p>Date of test: 01/07/2003 Operator: T. Eberl</p> <p>Test performed: automatically File name: default.emi</p>	<p>Comment:</p> <ul style="list-style-type: none"> - TX mode - EUT DC powered : 9.6 V (accu pack) - EUT in vertical position - rear side on table
--	---

<p>Detector: Peak</p>	<p>List of values: Selected by hand</p>
----------------------------------	--

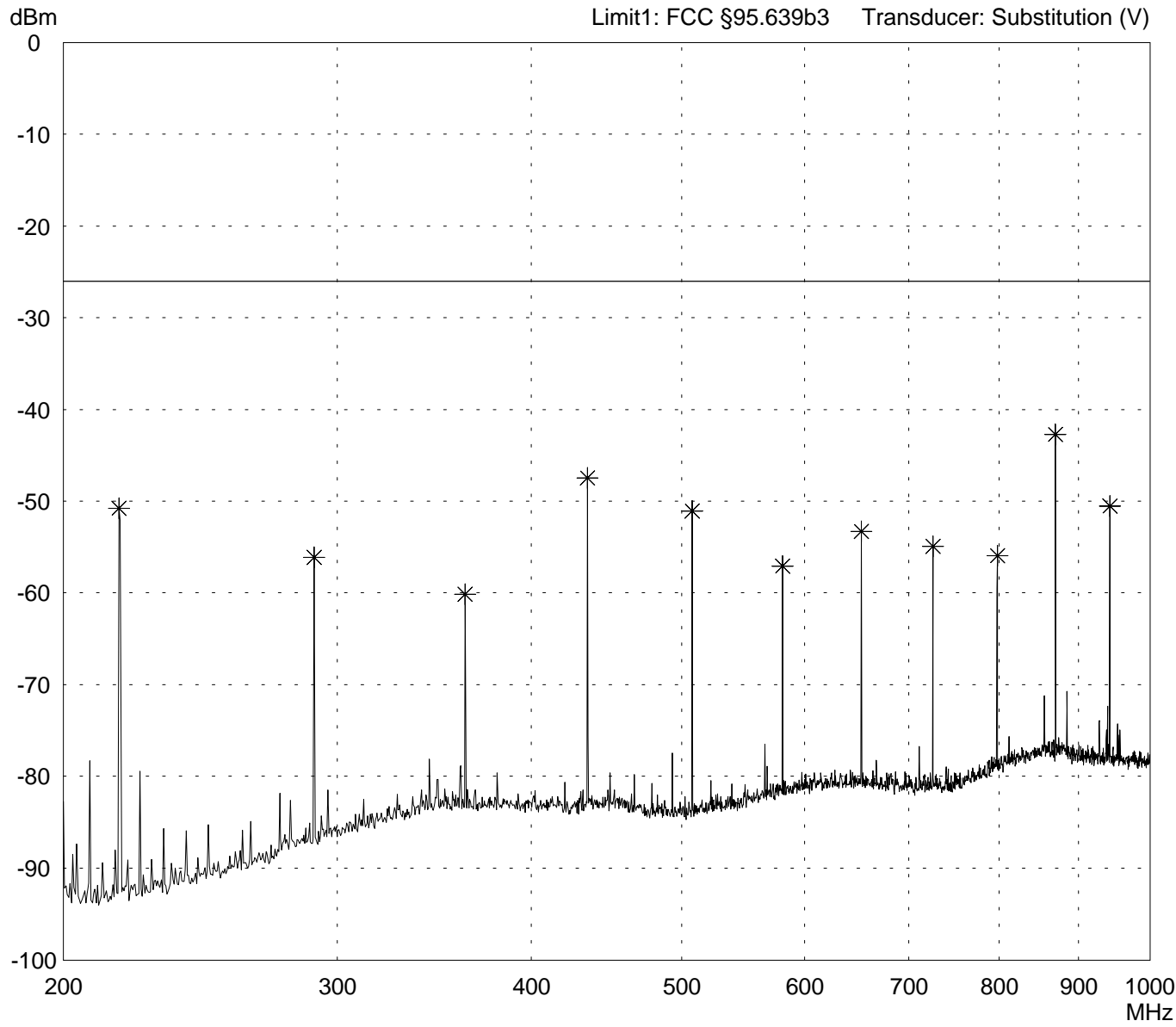

<p>Result: Prescan</p>	<p>Project file: 55503-20837</p> <p style="text-align: right;">Page 50 of 56 Pages</p>
-----------------------------------	---

Radiated Power Test 200 MHz - 1 GHz acc. to FCC Part 95 Subpart C/E

<p>Model: T6EXA 72 MHz</p> <p>Serial no.: Test sample 1</p> <p>Applicant: Futaba Corporation</p> <p>Test site: Fully anechoic room, cabin no. 2</p> <p>Tested on: Test distance 3 meters Vertical Polarization</p> <p>Date of test: Operator: 01/07/2003 T. Eberl</p> <p>Test performed: File name: automatically default.emi</p>	<p>Comment:</p> <ul style="list-style-type: none"> - TX mode - EUT DC powered : 9.6 V (accu pack) - EUT in vertical position - rear side on table
---	---

<p>Detector: Peak</p>	<p>List of values: Selected by hand</p>
---------------------------	---

<i>Frequency [MHz]</i>	<i>Reading [dBm]</i>	<i>Correction factor [dB]</i>	<i>Value [dBm]</i>	<i>Limit [dBm]</i>	<i>Limit exceeded</i>
217.200000	-72.23	21.45	-50.78	-26.00	
290.000000	-83.44	27.31	-56.13	-26.00	
362.800000	-90.70	30.54	-60.15	-26.00	
434.800000	-78.09	30.62	-47.47	-26.00	
507.600000	-81.33	30.27	-51.06	-26.00	
580.400000	-89.86	32.75	-57.11	-26.00	
652.400000	-87.09	33.77	-53.32	-26.00	
725.200000	-87.89	32.95	-54.94	-26.00	
798.000000	-91.55	35.59	-55.96	-26.00	
870.000000	-79.81	37.07	-42.74	-26.00	
942.800000	-87.05	36.51	-50.53	-26.00	

<p>Result: Prescan</p>	<p>Project file: 55503-20837</p> <p style="text-align: right;">Page 51 of 56 Pages</p>
----------------------------	--

Radiated Power Test 200 MHz - 1 GHz acc. to FCC Part 95 Subpart C/E

<p>Model: T6EXA 72 MHz</p> <p>Serial no.: Test sample 1</p> <p>Applicant: Futaba Corporation</p> <p>Test site: Fully anechoic room, cabin no. 2</p> <p>Tested on: Test distance 3 meters Vertical Polarization</p> <p>Date of test: 01/07/2003 Operator: T. Eberl</p> <p>Test performed: automatically File name: default.emi</p>	<p>Comment:</p> <ul style="list-style-type: none"> - TX mode - EUT DC powered : 9.6 V (accu pack) - EUT in horizontal position - rear side on table
--	---

<p>Detector: Peak</p>	<p>List of values: Selected by hand</p>
----------------------------------	--

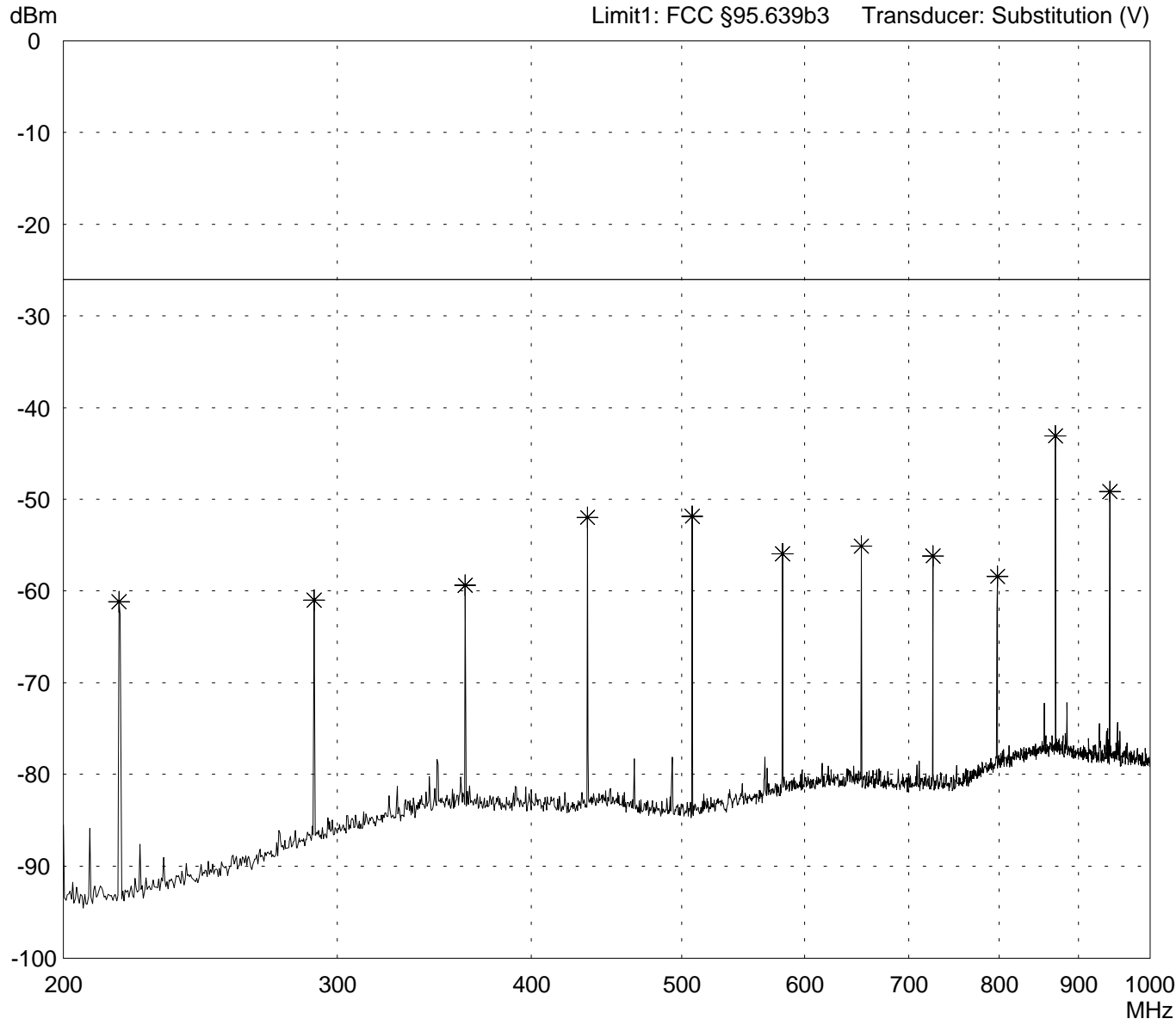

<p>Result: Prescan</p>	<p>Project file: 55503-20837</p> <p style="text-align: right;">Page 52 of 56 Pages</p>
-----------------------------------	---

**Radiated Power Test 200 MHz - 1 GHz
acc. to FCC Part 95 Subpart C/E**

<p>Model: T6EXA 72 MHz</p> <p>Serial no.: Test sample 1</p> <p>Applicant: Futaba Corporation</p> <p>Test site: Fully anechoic room, cabin no. 2</p> <p>Tested on: Test distance 3 meters Vertical Polarization</p> <p>Date of test: 01/07/2003 Operator: T. Eberl</p> <p>Test performed: automatically File name: default.emi</p>	<p>Comment:</p> <ul style="list-style-type: none"> - TX mode - EUT DC powered : 9.6 V (accu pack) - EUT in horizontal position - rear side on table
--	---

<p>Detector: Peak</p>	<p>List of values: Selected by hand</p>
----------------------------------	--

<i>Frequency [MHz]</i>	<i>Reading [dBm]</i>	<i>Correction factor [dB]</i>	<i>Value [dBm]</i>	<i>Limit [dBm]</i>	<i>Limit exceeded</i>
217.200000	-82.62	21.45	-61.18	-26.00	
290.000000	-88.32	27.31	-61.01	-26.00	
362.800000	-89.95	30.54	-59.40	-26.00	
434.800000	-82.58	30.62	-51.96	-26.00	
507.600000	-82.15	30.27	-51.88	-26.00	
580.400000	-88.70	32.75	-55.95	-26.00	
652.400000	-88.86	33.77	-55.09	-26.00	
725.200000	-89.16	32.95	-56.21	-26.00	
798.000000	-93.99	35.59	-58.40	-26.00	
870.000000	-80.13	37.07	-43.07	-26.00	
942.800000	-85.70	36.51	-49.18	-26.00	

<p>Result: Prescan</p>	<p>Project file: 55503-20837</p> <p style="text-align: right;">Page 53 of 56 Pages</p>
-----------------------------------	---

Radiated Power Test 200 MHz - 1 GHz acc. to FCC Part 95 Subpart C/E

Model:
T6EXA 72 MHz

Serial no.:
Test sample 1

Applicant:
Futaba Corporation

Test site:
Fully anechoic room, cabin no. 2

Tested on:
Test distance 3 meters
Vertical Polarization

Date of test: 01/07/2003
Operator: T. Eberl

Test performed: automatically
File name: default.emi

Comment:
- TX mode
- EUT DC powered : 9.6 V (accu pack)
- EUT in horizontal position
- right side on table

Detector:
Peak

List of values:
Selected by hand

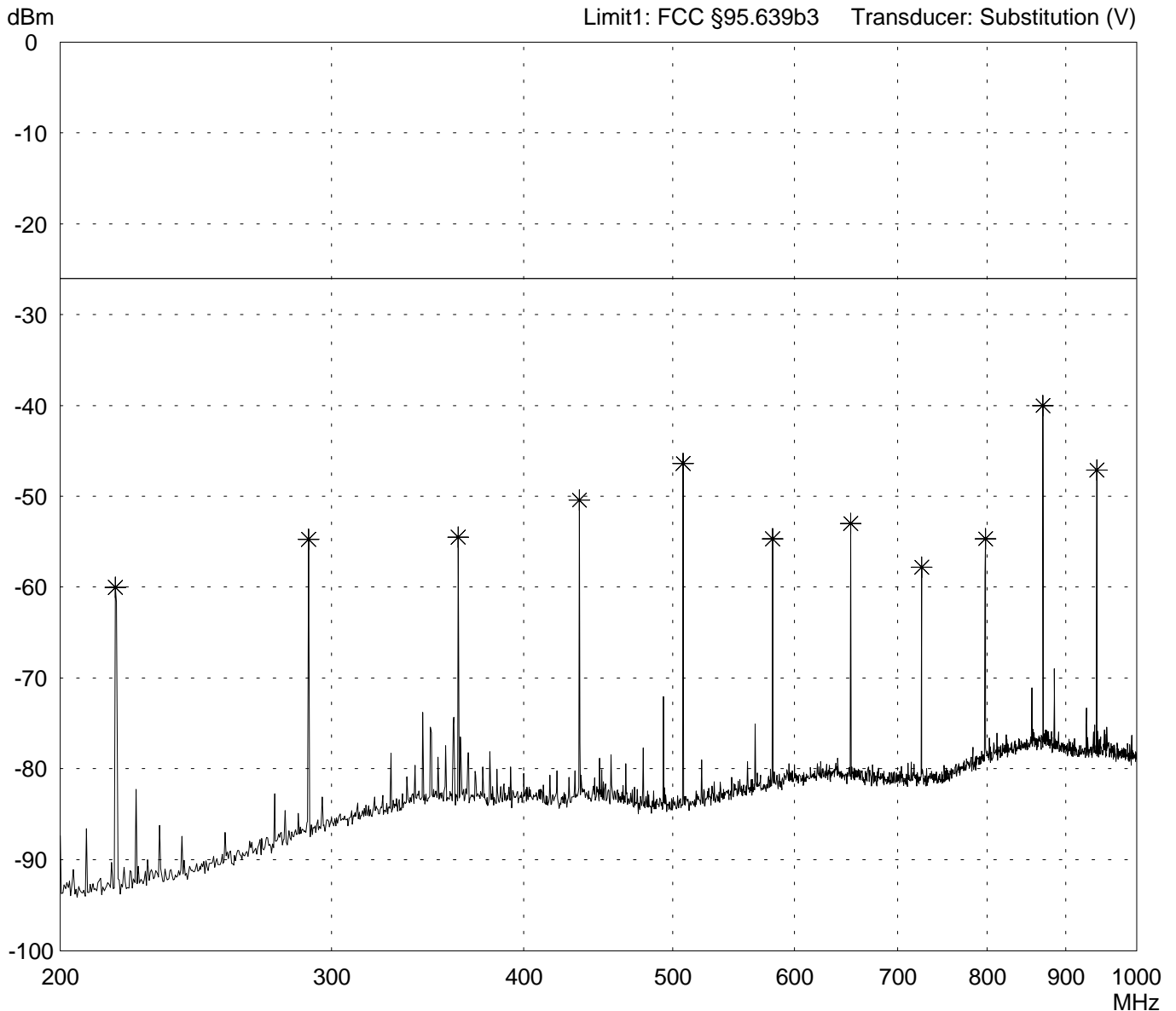

Result:
Prescan

Project file:
55503-20837

Page 54 of 56 Pages

**Radiated Power Test 200 MHz - 1 GHz
acc. to FCC Part 95 Subpart C/E**

<p>Model: T6EXA 72 MHz</p> <p>Serial no.: Test sample 1</p> <p>Applicant: Futaba Corporation</p> <p>Test site: Fully anechoic room, cabin no. 2</p> <p>Tested on: Test distance 3 meters Vertical Polarization</p> <p>Date of test: 01/07/2003 Operator: T. Eberl</p> <p>Test performed: automatically File name: default.emi</p>	<p>Comment:</p> <ul style="list-style-type: none"> - TX mode - EUT DC powered : 9.6 V (accu pack) - EUT in horizontal position - right side on table
--	--

<p>Detector: Peak</p>	<p>List of values: Selected by hand</p>
----------------------------------	--

<i>Frequency [MHz]</i>	<i>Reading [dBm]</i>	<i>Correction factor [dB]</i>	<i>Value [dBm]</i>	<i>Limit [dBm]</i>	<i>Limit exceeded</i>
217.200000	-81.48	21.45	-60.03	-26.00	
290.000000	-82.05	27.31	-54.74	-26.00	
362.800000	-85.03	30.54	-54.49	-26.00	
434.800000	-81.06	30.62	-50.44	-26.00	
507.600000	-76.65	30.27	-46.38	-26.00	
580.400000	-87.44	32.75	-54.69	-26.00	
652.400000	-86.77	33.77	-53.01	-26.00	
725.200000	-90.78	32.95	-57.83	-26.00	
798.000000	-90.25	35.59	-54.67	-26.00	
870.000000	-77.11	37.07	-40.04	-26.00	
942.800000	-83.63	36.51	-47.12	-26.00	

<p>Result: Prescan</p>	<p>Project file: 55503-20837</p> <p style="text-align: right;">Page 55 of 56 Pages</p>
-----------------------------------	---

13. Additional Information supplementary to the Test Report**13.1. Calculation of the necessary bandwidth (Section 2.202b)**

Calculation	$B_n = 2DK + B$
D = Peak frequency deviation	D = 2.5 kHz
K = Overall numerical factor	K = 1
B = Modulation rate in bauds	B = 1 kHz
	$B_n = 2 \cdot (2.5 \text{ kHz}) \cdot 1 + 1 \text{ kHz} = 6 \text{ kHz}$
Type of Emission	6K00F1D

13.2. Additional Information

Item	Description	No. of Pages
1	Test Site Calibration Data Sheets	4

Test Site Calibration 25 MHz - 5 GHz for ERP Measurements (Substitution Method)

Test site: Semi-anechoic room, cabin no. 2
 Test distance: Standard position [m]: 3
 Date: 07/15/2002
 Operator: R. Heller
 Transmit antennae: Biconical antenna HK 116, Rohde & Schwarz, inv.-no. A-1261
 Log.-per. antenna HL 223, Rohde & Schwarz, inv.-no. A-1262
 Horn antenna EMCO 3115, EMCO, inv.-no. B-1516
 Receiving antennae: Biconical antenna HK 116, Rohde & Schwarz, inv.-no. C-1560
 Log.-per. antenna 3147, EMCO, inv.-no. A-1009
 Signal source: Tracking generator of ESMI, Rohde & Schwarz, inv.-no. A-1569,
 connected to transmit antenna via cables inv.-no. 1683, port 2 of AP 1
 and 1592, nominal power at signal generator set to 0 dBm
 Receiving cables: Inv.-no. 1657, 1681 and 1592
 Test receiver: ESMI, Rohde & Schwarz, inv.-no. A-1569
 Antenna heights: TX antenna (h1): 1.5 metre
 RX antenna (h2): 1.5 metre
 Antenna position: TX antenna: center of turn table
 Polarization: horizontal

Frequency [MHz]	Transmit signal P tx [dBm]	TX antenna gain		True transmit signal P true [dBm]	Analyzer reading P site [dBm]	Correction for reading in "dBm" [dB]
		(isotropic) [dBi]	(dipole) [dBd]			
25.0	-1.1	-17.0	-19.2	-20.3	-44.9	25.3
30.0	-1.4	-13.8	-16.0	-17.3	-40.0	23.3
35.0	-1.5	-11.1	-13.3	-14.7	-36.1	22.0
40.0	-1.5	-8.8	-11.0	-12.5	-38.8	27.0
45.0	-1.6	-6.7	-8.9	-10.5	-35.7	25.9
50.0	-1.6	-5.1	-7.3	-8.9	-34.3	26.1
55.0	-1.7	-3.8	-6.0	-7.6	-32.9	25.9
60.0	-1.7	-2.8	-5.0	-6.7	-32.2	26.2
65.0	-1.7	-2.0	-4.2	-5.9	-31.4	26.2
70.0	-1.7	-1.3	-3.5	-5.2	-30.6	26.1
75.0	-1.8	-0.7	-2.9	-4.7	-30.4	26.4
80.0	-1.9	-0.1	-2.3	-4.1	-30.4	26.9
85.0	-1.9	0.2	-2.0	-3.9	-30.3	27.1
90.0	-2.0	0.5	-1.7	-3.6	-29.6	26.6
95.0	-2.0	0.6	-1.6	-3.6	-28.9	26.0
100.0	-2.0	0.7	-1.5	-3.5	-28.2	25.3
110.0	-2.1	0.9	-1.3	-3.3	-27.9	25.2
120.0	-2.1	1.0	-1.2	-3.3	-27.4	24.8
130.0	-2.2	1.1	-1.1	-3.3	-27.2	24.6
140.0	-2.3	1.4	-0.8	-3.0	-26.3	23.9
150.0	-2.3	1.8	-0.4	-2.7	-25.6	23.6
160.0	-2.4	1.9	-0.3	-2.6	-25.4	23.4
170.0	-2.4	2.0	-0.2	-2.6	-25.3	23.4
180.0	-2.5	2.1	0.0	-2.5	-25.6	23.7
190.0	-2.6	2.3	0.2	-2.4	-26.4	24.6
200.0	-2.6	2.3	0.2	-2.4	-27.8	26.0
200.1	-2.3	6.5	4.4	2.0	-19.4	22.0
220.0	-2.6	6.9	4.8	2.1	-19.6	22.4
240.0	-2.7	7.0	4.9	2.1	-20.5	23.3
260.0	-2.8	7.1	5.0	2.2	-21.5	24.4
280.0	-2.9	7.3	5.1	2.2	-22.9	25.7

Test Site Calibration 25 MHz - 5 GHz for ERP Measurements (Substitution Method)

Test site: Semi-anechoic room, cabin no. 2
 Test distance: Standard position [m]: 3
 Date: 07/15/2002
 Operator: R. Heller
 Transmit antennae: Biconical antenna HK 116, Rohde & Schwarz, inv.-no. A-1261
 Log.-per. antenna HL 223, Rohde & Schwarz, inv.-no. A-1262
 Horn antenna EMCO 3115, EMCO, inv.-no. B-1516
 Receiving antennae: Biconical antenna HK 116, Rohde & Schwarz, inv.-no. C-1560
 Log.-per. antenna 3147, EMCO, inv.-no. A-1009
 Signal source: Tracking generator of ESMI, Rohde & Schwarz, inv.-no. A-1569,
 connected to transmit antenna via cables inv.-no. 1683, port 2 of AP 1
 and 1592, nominal power at signal generator set to 0 dBm
 Receiving cables: Inv.-no. 1657, 1681 and 1592
 Test receiver: ESMI, Rohde & Schwarz, inv.-no. A-1569
 Antenna heights: TX antenna (h1): 1.5 metre
 RX antenna (h2): 1.5 metre
 Antenna position: TX antenna: center of turn table
 Polarization: horizontal

Frequency [MHz]	Transmit signal P tx [dBm]	TX antenna gain		True transmit signal P true [dBm]	Analyzer reading P site [dBm]	Correction for reading in "dBm" [dB]
		(isotropic) [dBi]	(dipole) [dBd]			
300.0	-3.0	7.2	5.1	2.1	-23.0	25.7
325.0	-3.0	7.2	5.1	2.0	-23.9	26.6
350.0	-3.2	7.1	5.0	1.8	-25.7	28.2
375.0	-3.2	7.2	5.1	1.8	-26.2	28.7
400.0	-3.1	6.8	4.7	1.6	-27.8	30.0
425.0	-3.4	6.7	4.6	1.1	-29.1	30.9
433.9	-3.4	6.8	4.7	1.3	-29.8	31.7
450.0	-3.4	7.0	4.9	1.4	-30.6	32.6
475.0	-3.6	6.9	4.8	1.2	-30.1	32.0
500.0	-3.7	7.0	4.9	1.2	-30.2	32.1
550.0	-3.8	7.5	5.4	1.6	-29.3	31.6
600.0	-3.7	7.0	4.9	1.1	-28.9	30.7
650.0	-4.0	6.9	4.8	0.8	-30.3	31.7
700.0	-4.2	6.5	4.4	0.2	-33.0	33.9
750.0	-4.2	7.2	5.1	0.8	-34.6	36.1
800.0	-4.3	7.1	5.0	0.7	-34.3	35.7
850.0	-4.6	6.7	4.6	0.0	-33.2	33.8
867.8	-4.4	6.6	4.5	0.0	-32.9	33.7
900.0	-4.6	7.0	4.9	0.3	-33.1	34.1
950.0	-4.6	7.7	5.6	0.9	-34.4	36.0
1000.0	-4.7	7.0	4.9	0.2	-36.9	37.8
1000.1	-4.6	4.3		-0.3	-36.8	37.2
1500.0	-5.6	6.9		1.3	-41.1	43.2
2000.0	-6.2	7.1		0.9	-42.7	44.4
2500.0	-6.6	7.6		1.0	-46.0	47.8
3000.0	-6.8	7.7		0.9	-47.9	49.7
3500.0	-7.6	7.8		0.2	-49.4	50.5
4000.0	-8.2	7.9		-0.3	-53.7	54.3
4500.0	-9.0	9.0		0.0	-55.3	56.4
5000.0	-9.5	8.9		-0.6	-55.5	55.9

Test Site Calibration 25 MHz - 5 GHz for ERP Measurements (Substitution Method)

Test site: Semi-anechoic room, cabin no. 2
 Test distance: Standard position [m]: 3
 Date: 07/15/2002
 Operator: R. Heller
 Transmit antennae: Biconical antenna HK 116, Rohde & Schwarz, inv.-no. A-1261
 Log.-per. antenna HL 223, Rohde & Schwarz, inv.-no. A-1262
 Horn antenna EMCO 3115, EMCO, inv.-no. B-1516
 Receiving antennae: Biconical antenna HK 116, Rohde & Schwarz, inv.-no. C-1560
 Log.-per. antenna 3147, EMCO, inv.-no. A-1009
 Signal source: Tracking generator of ESMI, Rohde & Schwarz, inv.-no. A-1569,
 connected to transmit antenna via cables inv.-no. 1683, port 2 of AP 1
 and 1592, nominal power at signal generator set to 0 dBm
 Receiving cables: Inv.-no. 1657, 1681 and 1592
 Test receiver: ESMI, Rohde & Schwarz, inv.-no. A-1569
 Antenna heights: TX antenna (h1): 1.5 metre
 RX antenna (h2): 1.5 metre
 Antenna position: TX antenna: center of turn table
 Polarization: vertical

Frequency [MHz]	Transmit signal ¹ P tx [dBm]	TX antenna gain		True transmit signal P true [dBm]	Analyzer reading P site [dBm]	Correction for reading in "dBm" [dB]
		(isotropic) [dBi]	(dipole) [dBd]			
25.0	-1.1	-17.0	-19.2	-20.3	-43.4	23.8
30.0	-1.4	-13.8	-16.0	-17.3	-38.6	21.9
35.0	-1.5	-11.1	-13.3	-14.7	-34.9	20.8
40.0	-1.5	-8.8	-11.0	-12.5	-34.3	22.5
45.0	-1.6	-6.7	-8.9	-10.5	-37.0	27.1
50.0	-1.6	-5.1	-7.3	-8.9	-34.3	26.1
55.0	-1.7	-3.8	-6.0	-7.6	-32.7	25.7
60.0	-1.7	-2.8	-5.0	-6.7	-32.5	26.4
65.0	-1.7	-2.0	-4.2	-5.9	-31.3	26.1
70.0	-1.7	-1.3	-3.5	-5.2	-30.6	26.1
75.0	-1.8	-0.7	-2.9	-4.7	-29.9	25.9
80.0	-1.9	-0.1	-2.3	-4.1	-29.9	26.5
85.0	-1.9	0.2	-2.0	-3.9	-30.5	27.2
90.0	-2.0	0.5	-1.7	-3.6	-30.3	27.3
95.0	-2.0	0.6	-1.6	-3.6	-29.0	26.1
100.0	-2.0	0.7	-1.5	-3.5	-28.3	25.5
110.0	-2.1	0.9	-1.3	-3.3	-27.9	25.2
120.0	-2.1	1.0	-1.2	-3.3	-28.2	25.5
130.0	-2.2	1.1	-1.1	-3.3	-27.0	24.3
140.0	-2.3	1.4	-0.8	-3.0	-25.8	23.4
150.0	-2.3	1.8	-0.4	-2.7	-25.1	23.1
160.0	-2.4	1.9	-0.3	-2.6	-25.1	23.1
170.0	-2.4	2.0	-0.2	-2.6	-25.0	23.1
180.0	-2.5	2.1	0.0	-2.5	-25.1	23.2
190.0	-2.6	2.3	0.2	-2.4	-25.5	23.7
200.0	-2.6	2.3	0.2	-2.4	-26.9	25.2
200.1	-2.3	6.5	4.4	2.0	-18.4	21.1
220.0	-2.6	6.9	4.8	2.1	-18.7	21.5
240.0	-2.7	7.0	4.9	2.1	-20.0	22.8
260.0	-2.8	7.1	5.0	2.2	-21.4	24.3
280.0	-2.9	7.3	5.1	2.2	-23.7	26.6

Test Site Calibration 25 MHz - 5 GHz for ERP Measurements (Substitution Method)

Test site: Semi-anechoic room, cabin no. 2
 Test distance: Standard position [m]: 3
 Date: 07/15/2002
 Operator: R. Heller
 Transmit antennae: Biconical antenna HK 116, Rohde & Schwarz, inv.-no. A-1261
 Log.-per. antenna HL 223, Rohde & Schwarz, inv.-no. A-1262
 Horn antenna EMCO 3115, EMCO, inv.-no. B-1516
 Receiving antennae: Biconical antenna HK 116, Rohde & Schwarz, inv.-no. C-1560
 Log.-per. antenna 3147, EMCO, inv.-no. A-1009
 Signal source: Tracking generator of ESMI, Rohde & Schwarz, inv.-no. A-1569,
 connected to transmit antenna via cables inv.-no. 1683, port 2 of AP 1
 and 1592, nominal power at signal generator set to 0 dBm
 Receiving cables: Inv.-no. 1657, 1681 and 1592
 Test receiver: ESMI, Rohde & Schwarz, inv.-no. A-1569
 Antenna heights: TX antenna (h1): 1.5 metre
 RX antenna (h2): 1.5 metre
 Antenna position: TX antenna: center of turn table
 Polarization: vertical

Frequency [MHz]	Transmit signal ¹ P tx [dBm]	TX antenna gain		True transmit signal P true [dBm]	Analyzer reading P site [dBm]	Correction for reading in "dBm" [dB]
		(isotropic) [dBi]	(dipole) [dBd]			
300.0	-3.0	7.2	5.1	2.1	-25.3	28.0
325.0	-3.0	7.2	5.1	2.0	-26.7	29.3
350.0	-3.2	7.1	5.0	1.8	-28.2	30.7
375.0	-3.2	7.2	5.1	1.8	-27.9	30.4
400.0	-3.1	6.8	4.7	1.6	-28.3	30.5
425.0	-3.4	6.7	4.6	1.1	-28.2	30.0
433.9	-3.4	6.8	4.7	1.3	-28.6	30.6
450.0	-3.4	7.0	4.9	1.4	-28.8	30.9
475.0	-3.6	6.9	4.8	1.2	-28.1	30.0
500.0	-3.7	7.0	4.9	1.2	-28.2	30.0
550.0	-3.8	7.5	5.4	1.6	-29.5	31.7
600.0	-3.7	7.0	4.9	1.1	-31.6	33.4
650.0	-4.0	6.9	4.8	0.8	-32.4	33.8
700.0	-4.2	6.5	4.4	0.2	-32.2	33.1
750.0	-4.2	7.2	5.1	0.8	-31.3	32.8
800.0	-4.3	7.1	5.0	0.7	-34.4	35.7
850.0	-4.6	6.7	4.6	0.0	-36.3	36.9
867.8	-4.4	6.6	4.5	0.0	-36.3	37.1
900.0	-4.6	7.0	4.9	0.3	-35.7	36.6
950.0	-4.6	7.7	5.6	0.9	-34.9	36.5
1000.0	-4.7	7.0	4.9	0.2	-34.7	35.6
1000.1	-4.6	4.3		-0.3	-36.3	36.7
1500.0	-5.6	6.9		1.3	-39.1	41.2
2000.0	-6.2	7.1		0.9	-44.3	46.1
2500.0	-6.6	7.6		1.0	-45.1	46.9
3000.0	-6.8	7.7		0.9	-46.5	48.3
3500.0	-7.6	7.8		0.2	-50.3	51.4
4000.0	-8.2	7.9		-0.3	-52.8	53.4
4500.0	-9.0	9.0		0.0	-55.9	57.0
5000.0	-9.5	8.9		-0.6	-54.7	55.1