

Straubing, July 03 2002

**TEST - REPORT****No. 55503-20364****for****T4YBF 72****R/C Transmitter**

Applicant: Futaba Corporation

Purpose of testing: To show compliance with

- FCC Code of Federal Regulations,  
CFR 47, Part 95

- FCC Code of Federal Regulations,  
CFR 47, Part 2, Subpart J

---

**Note:**

The test data of this report relate only to the individual item which has been tested. This report shall not be reproduced except in full extent without the written approval of the testing laboratory.

---

**Table of Contents**

1.	Administrative Data .....	3
2.	Identification of Test Laboratory .....	4
3.	Summary of Test Results .....	5
4.	Operation Mode of EUT.....	6
5.	Configuration of EUT and Peripheral Devices .....	7
6.	Measuring Methods .....	8
6.1.	Maximum Transmitter Power (§95.639).....	8
6.2.	Frequency tolerance (§95.623).....	10
6.3.	Emission Bandwidth (§95.633) .....	12
6.4.	Unwanted Emission 30 MHz - 1 GHz (§95.635, §95.639).....	13
7.	Photographs of Test Setups .....	15
8.	Equipment List.....	17
9.	Referenced Regulations .....	19
10.	List of Measurements .....	20
11.	Test Results .....	21
12.	Additional Results.....	31

**1. Administrative Data**

Equipment Under Test (EUT): T4YBF 72  
Serial number(s): 001  
Type of equipment: R/C Transmitter  
Type of emission: F1D  
Parts/accessories: ---  
FCC-ID: AZPT4YBF-72

---

Applicant:  
(full address) Futaba Corporation  
R/C Engineering Unit 1  
1080, Yabutsuka Chosei-son, Chosei-gun,  
Chiba-ken, 299-4395 Japan

Contract identification: ---

Contact person: Mr. Sakuma

Manufacturer: Futaba Corporation

---

Receipt of EUT: June19, 2002

Dates of test: June 19 to 29, 2002

Note: ---

---

Responsible for testing: Thomas Eberl

Responsible for test report: Thomas Eberl

## 2. Identification of Test Laboratory

Test Laboratory:  
(full address): Senton GmbH EMI/EMC Test Center  
Aeussere Fruehlingstrasse 45  
D-94315 Straubing  
Germany

---

Contact person: Mr. Johann Roidt  
Communication: Telephone (+49) 0 94 21 / 55 22-0  
Fax (+49) 0 94 21 / 55 22-99  
eMail: Office@senton.de

---

FCC registration number: 90926  
Industry Canada file number: IC 3050

### 3. Summary of Test Results

The tested sample complies with the requirements for set forth in the

**The Code of Federal Regulations 47, Part 95, Subpart C & E**

and

**The Code of Federal Regulations 47 Part 2, Subpart J.**

of the Federal Communication Commission (FCC).



Johann Roidt  
Technical Manager



Thomas Eberl  
Test Engineer

#### 4. Operation Mode of EUT

- transmitting continuously<sup>1</sup>
  - with accu pack supply nominal 9.6 V DC)<sup>2</sup>
  - antenna extended to maximum<sup>3</sup>
- 
- operating with  $f = 72.550$  MHz

For conducted measurements a dummy load was used as delivered by applicant. A short description of the circuit and the method to stop modulation can be found in the following figure.

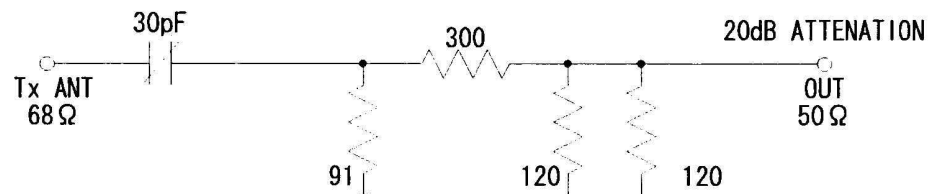

<sup>1</sup> Modulation as indicated on appropriate test record

<sup>2</sup> For conducted measurements replaced by external DC supply

<sup>3</sup> For radiated emissions only

## 5. Configuration of EUT and Peripheral Devices

EUT is configured as stand-alone device

### Configuration of cables of EUT

Not applicable

### Configuration of peripheral devices connected to EUT

Not applicable

## 6. Measuring Methods

### 6.1. Maximum Transmitter Power (§95.639)

The maximum transmitter power was measured conducted and radiated.

#### 6.1.1. Conducted Maximum Transmitter Power

A spectrum analyzer / EMI test receiver was connected to the output of the transmitter power amplifier (conducted measurement) via dummy load while EUT was operating in transmit mode using the assigned frequency.

The trace mode of the spectrum analyzer was set to max hold with:  
 RBW = 100 kHz, VBW = 100 kHz, span = 1 MHz, sweep = 20 ms (auto mode)

See figure 1 for the measurement setup.

Test equipment used (see equipment list for details):  
 02, 18, 51, 69, 70, 71

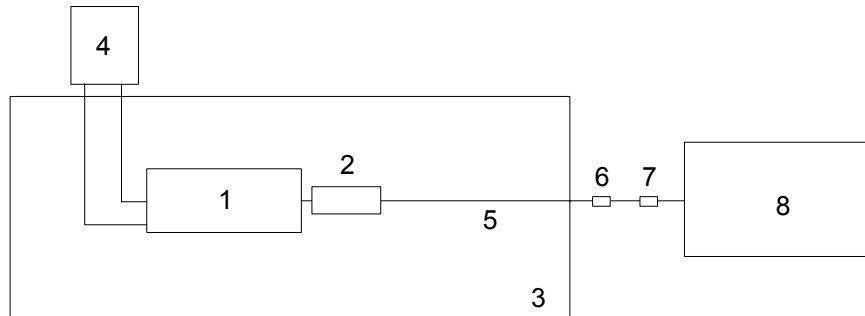

Figure 1: Measurement setup for testing on antenna connector

- |                            |                            |
|----------------------------|----------------------------|
| <b>1</b> Transmitter (EUT) | <b>5</b> Test cable        |
| <b>2</b> Dummy load        | <b>6</b> DC-block          |
| <b>3</b> Wooden table      | <b>7</b> Attenuator        |
| <b>4</b> DC power supply   | <b>8</b> Spectrum analyzer |



### 6.1.2. Radiated Maximum Transmitter Power

Radiated Maximum Transmitter Power was measured with detector-function of the spectrum analyzer set to positive peak and trace mode max hold:

RBW = 100 kHz, VBW = 100 kHz, span = 1 MHz, sweep = 15 s

For measurement setup and procedure see section "Unwanted Emission 30 MHz - 1 GHz (§95.635, §95.639)" on Page 13.

## 6.2. Frequency tolerance (§95.623)

### 6.2.1. Frequency stability vs. temperature

The frequency stability vs. temperature was measured with a spectrum analyzer connected to the output of the transmitter power amplifier (conducted measurement) via dummy load while EUT was operating in transmit mode using the assigned frequency.

The trace mode of the spectrum analyzer was set to write with frequency count mode activated:

RBW = 100 Hz, VBW = 100 Hz, span = 20 kHz, sweep = 1.5 s (auto mode)

See figure 2 for the measurement setup.

Test equipment used (see equipment list for details):  
 02, 18, 51, 54, 69, 70, 71

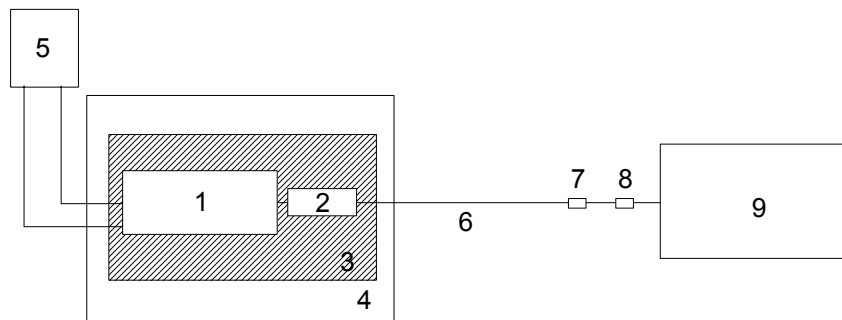

Figure 2: Measurement setup for testing within temperature test chamber

- |                            |                     |
|----------------------------|---------------------|
| 1 Transmitter (EUT)        | 6 Test cable        |
| 2 Dummy load               | 7 DC-block          |
| 3 Wooden support           | 8 Attenuator        |
| 4 Temperature test chamber | 9 Spectrum analyzer |
| 5 DC power supply          |                     |

### 6.2.2. Frequency stability vs. supply voltage

The frequency stability vs. supply voltage was measured with a spectrum analyzer connected to the output of the transmitter power amplifier (conducted measurement) via dummy load while EUT was operating in transmit mode using the assigned frequency.

The trace mode of the spectrum analyzer was set to write with frequency count mode activated:

RBW = 100 Hz, VBW = 100 Hz, span = 20 kHz, sweep = 1.5 s (auto mode)

See figure 1 for the measurement setup.

Test equipment used (see equipment list for details):  
02, 18, 51, 69, 70, 71

### 6.3. Emission Bandwidth (§95.633)

The emission bandwidth was measured as occupied bandwidth with a spectrum analyzer connected to the output of the transmitter power amplifier (conducted measurement) via dummy load while EUT was operating in transmit mode using the assigned frequency.

The occupied bandwidth measurement was performed referring to 99% of total power: The trace mode of the spectrum analyzer was set to max hold with RBW = 30 Hz, VBW = 30 Hz, span = 40 kHz, sweep = 90 s

See figure 1 for the measurement setup.

Test equipment used (see equipment list for details):  
02, 18, 51, 69, 70, 71

#### **6.4. Unwanted Emission 30 MHz - 1 GHz (§95.635, §95.639)**

Radiated emissions were measured over the frequency range from 30 MHz to 1 GHz. For final testing the detector-function of the spectrum analyzer was set to positive peak and trace mode max hold:

RBW = 3 kHz, VBW = 10 kHz, span = 20 kHz, sweep = 10 s

Measurements were made in both the horizontal and vertical planes of polarization. The scans were taken in a semi-anechoic room using a spectrum analyzer with the detector function set to peak and resolution bandwidth set to 100 kHz. All tests were performed at a test-distance of 3 meters. Hand-held or body-worn devices are rotated through three orthogonal axes to determine which attitude and configuration produces the highest emission relative to the limit and therefore shall be used for final testing. During the tests the EUT was rotated all around and the receiving-antenna was raised and lowered from 1 meter to 4 meters to find the maximum levels of emissions. The cables and equipment were placed and moved within the range of position likely to find their maximum emissions.

Final testing was performed referring to substitution method as described in TIA/EIA-603, section 2.2.12 ("Radiated Spurious Emissions").

See figure 3 for the measurement setup.

Test equipment used (see equipment list for details):

01, 06, 12, 15, 38, 39, 40, 41, 55, 58, 61, 64, 66

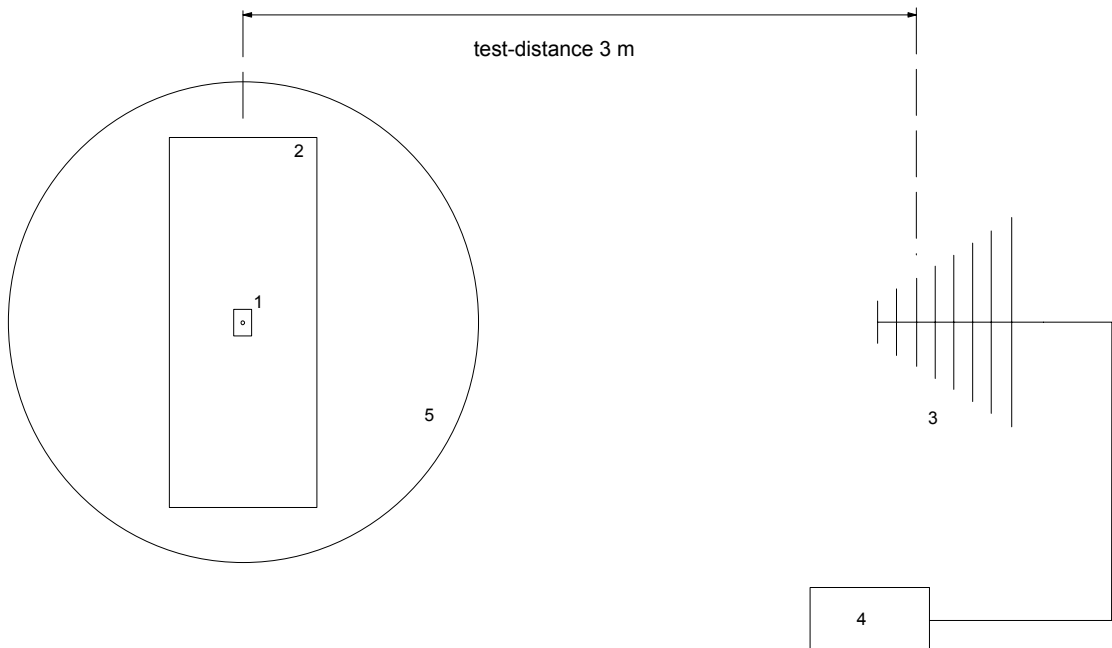

Figure 3: Measurement setup for radiated emission test

- 1 Transmitter (EUT)
- 2 Wooden table

- 3 Measurement antenna
- 4 Test receiver
- 5 Turn table

## 7. Photographs of Test Setups

### Test setup unwanted radiation 30 MHz - 1 GHz



## Test setup unwanted radiation 30 MHz - 1 GHz (continued)

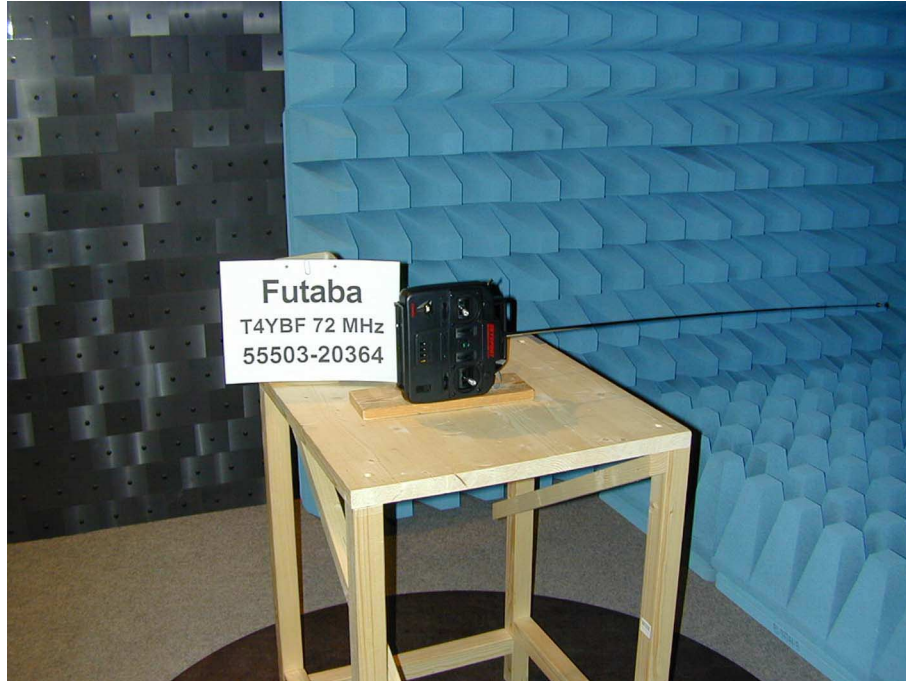



## 8. Equipment List

To facilitate reference to test equipment used for related tests, each item of test equipment and ancillaries such as cables are identified (numbered) by the Test Laboratory.

No.	Type	Model	Serial Number	Manufacturer
01	Spectrum Analyzer	R 3271	05050023	Advantest
02	EMI Test Receiver	ESMI	839379/013 839587/006	Rohde & Schwarz
03	Test Receiver	ESH 3	880112/032	Rohde & Schwarz
04	Test Receiver	ESHS 10	860043/016	Rohde & Schwarz
05	Test Receiver	ESV	881414/009	Rohde & Schwarz
06	Test Receiver	ESVP	881120/024	Rohde & Schwarz
07	Audio Analyzer	UPA	862954	Rohde & Schwarz
08	Power Meter	NRVS	836856/015	Rohde & Schwarz
09	Power Sensor	NRV-Z52	837901/030	Rohde & Schwarz
10	Power Sensor	NRV-Z4	863828/015	Rohde & Schwarz
11	Preamplifier	ESV-Z3	860907/004	Rohde & Schwarz
12	Preamplifier	R14601		Advantest
13	Preamplifier	ACX/080-3030	32640	CTT
14	Preamplifier	ACO/180-3530	32641	CTT
15	Signal generator	SMY 01	830694/001	Rohde & Schwarz
16	Signal Generator	HP 8673 D	2930A00966	Hewlett Packard
17	Waveform Generator	HP 33120 A	US34005375	Hewlett Packard
18	Attenuator 20 dB	4776-20	9503	Narda
19	Attenuator 10 dB	4776-10	9412	Narda
20	Pulse Limiter	ESH 3-Z2	1144	Rohde & Schwarz
21	Pulse Limiter	11947 A	3107A00566	Hewlett Packard
22	V-Network	ESH 3-Z5	862770/018	Rohde & Schwarz
23	V-Network	ESH 3-Z5	894785/005	Rohde & Schwarz
24	V-Network	ESH 3-Z5	830952/025	Rohde & Schwarz
25	V-Network	ESH 3-Z6	830722/010	Rohde & Schwarz
26	V-Network	NSLK 8127	8127152	Schwarzbeck
27	V-Network	NNLA 8119	8119148	Schwarzbeck
28	V-Network	SE 01	01	Senton
29	T-Network	ESH 3-Z4	890602/011	Rohde & Schwarz
30	T-Network	ESH 3-Z4	890602/012	Rohde & Schwarz
31	High Impedance Probe	TK 9416	01	Schwarzbeck
32	High Impedance Probe	TK 9416	02	Schwarzbeck
33	Current Probe	ESH 2-Z1	863366/18	Rohde & Schwarz
34	Current Probe	ESV-Z1	862553/3	Rohde & Schwarz

No.	Type	Model	Serial Number	Manufacturer
35	Absorbing Clamp	MDS 21	80911	Lüthi
36	Absorbing Clamp	MDS 21	79690	Lüthi
37	Loop Antenna	HFH2-Z2	882964/1	Rohde & Schwarz
38	Biconical Antenna	HK 116	842204/001	Rohde & Schwarz
39	Biconical Antenna	HK 116	836239/02	Rohde & Schwarz
40	Log. Periodic Antenna	HL 223	841516/023	Rohde & Schwarz
41	Log. Periodic Antenna	HL 223	834408/12	Rohde & Schwarz
42	Horn Antenna	3115	9508-4553	Emco
43	Horn Antenna	3160-03	9112-1003	Emco
44	Horn Antenna	3160-04	9112-1001	Emco
45	Horn Antenna	3160-05	9112-1001	Emco
46	Horn Antenna	3160-06	9112-1001	Emco
47	Horn Antenna	3160-07	9112-1008	Emco
48	Horn Antenna	3160-08	9112-1002	Emco
49	Horn Antenna	3160-09	9403-1025	Emco
50	Digital multimeter	199	463386	Keithley
51	DC Power Supply	NGSM 32/10	203	Rohde & Schwarz
52	DC Power Supply	NGB	2455	Rohde & Schwarz
53	DC Power Supply	NGA	386	Rohde & Schwarz
54	Temperature Test Chamber	HT4010	07065550	Heraeus
55	Cable	RG214	1309	Senton
56	Cable	200CM_001	1357	Rosenberger
57	Cable	150CM_001	1479	Rosenberger
58	Cable Set EG1	RG214	1189 - 1191	Senton
59	Cable Set Cabine 1	RG214		Senton
60	Cable Set Cabine 2	RG214		Senton
61	Cable Set Cabine 3	RG214		Senton
62	Shielded Room	No. 1	1451	Senton
63	Shielded Room	No. 2	1452	Senton
64	Semi-anechoic Chamber	No. 3	1453	Siemens
65	Shielded Room	No. 4	1454	Euroshield
66	Open Area Test Site	EG 1		Senton
67	Cable for Antenna Connector			Lucent Technologies
68	DC Block 0.01-18GHz		8037	Inmet Corp.
69	High pass filter			Lucent Technologies
69	DC Block	7006	A2798	Weinschel Corp.
70	Cable for Antenna Connector			Senton
71	Dummy load			Futaba Corporation

## 9. Referenced Regulations

All tests were performed with reference to the following regulations and standards:

<input checked="" type="checkbox"/>	CFR 47 Part 2	Code of Federal Regulations Part 2 (Frequency Allocations And Radio Treaty Matters, General Rules And Regulations) of the Federal Communication Commission (FCC)	October 1, 1999
<input type="checkbox"/>	CFR 47 Part 15 Subpart A	Code of Federal Regulations Part 15 (Radio Frequency Devices), Subpart A (General) of the Federal Communication Commission (FCC)	October 1, 1999
<input type="checkbox"/>	CFR 47 Part 15 Subpart B	Code of Federal Regulations Part 15 (Radio Frequency Devices), Subpart B (Unintentional Radiators) of the Federal Communication Commission (FCC)	October 1, 1999
<input type="checkbox"/>	CFR 47 Part 15 Subpart C	Code of Federal Regulations Part 15 (Radio Frequency Devices), Subpart C (Intentional Radiators) of the Federal Communication Commission (FCC)	October 1, 1999
<input checked="" type="checkbox"/>	CFR 47 Part 95 Subpart C/E	Code of Federal Regulations Part 95 (Personal Radio Services), Subpart C/E (Radio Control(R/C) Radio Service) of the Federal Communication Commission (FCC)	October 1, 1998
<input type="checkbox"/>	ANSI C63.4	American National Standard for Methods of Measurement of Radio-Noise Emissions from Low-Voltage Electrical and Electronic Equipment in the Range of 9 kHz - 40 GHz	October, 1992
<input type="checkbox"/>	RSS-210	Radio Standards Specification RSS-210 Issue 2 for Low Power Licence-Exempt Radiocommunication Devices of Industry Canada	February 24, 1996
<input checked="" type="checkbox"/>	TIA/EIA-603	Land Mobile FM or PM Communications Equipment Measurement and Performance Standards	February, 1993
<input checked="" type="checkbox"/>	TIA/EIA-603-1	Addendum to TIA/EIA-603	March 4, 1998

**10. List of Measurements**

<b>CFR 47 Part 95 Subpart C / E CFR 47 Part 2 Subpart J</b>			
<b>Section(s):</b>	<b>Test</b>	<b>Page</b>	<b>Result</b>
<b>§95.639</b>	Maximum transmitter power		Passed
<b>§95.623</b>	Frequency tolerance		Passed
<b>§95.633</b>	Emission bandwidth		Passed
<b>§95.635</b>	Unwanted radiation 30 MHz - 1 GHz		Passed

## 11. Test Results

**MAXIMUM TRANSMITTER POWER - CONDUCTED****Section 95.639b3**

EUT: T4YBF 72  
Serial number: 001  
Applicant: Futaba Corporation  
Mode: - transmitting continuously (TX mode)  
- operating with f = 72.550 MHz  
Date of test: June 20, 2002  
Operator: Thomas Eberl

**Test conditions:**

Temperature: +20°C  
Nominal supply voltage: 9.6V DC

**Specifications:**

Voltage range: ±15 % of nominal supply voltage

Supply voltage (V)	Modulation	Transmitter power (dBm)	Transmitter power (W)	Limit (W)
8.16	off	22.40	0.174	0.750
9.60	off	23.80	0.240	0.750
11.04	off	24.80	0.302	0.750
8.16	on	22.40	0.174	0.750
9.60	on	23.80	0.240	0.750
11.04	on	24.80	0.302	0.750

**Result:** Test passed

**MAXIMUM TRANSMITTER POWER - RADIATED SECTION 95.639B3**

EUT: T4YBF 72  
Serial number: 001  
Applicant: Futaba Corporation  
Mode: - transmitting continuously (TX mode)  
- with modulation  
- with supply voltage 9.6 V DC  
- antenna extended to maximum  
- operating with f = 72.550 MHz  
Date of test: June 20, 2002  
Operator: Thomas Eberl

**Test conditions:**

Temperature: +20°C  
Voltage supply: Fully charged batteries (9.6 V DC nominal)

**Note 1:**

Limit of 28.8 dBm corresponds to 0.75 W.

**Note 2:**

For calculation of correction factors see tables "Test Site Calibration 30 MHz - 1 GHz for ERP Measurements (Substitution Method)" starting on page 32.

Position of EUT	Frequency (MHz)	Polarisation V/H	Reading value (dBm)	Correction factor (dB)	ERP (dBm)	Limit (dBm)
vertical, antenna vertical	72.550	V	-7.95	24.74	16.79	28.8
horiz., antenna horizontal	72.550	H	-9.54	25.51	15.97	28.8
horiz., right side on table	72.550	H	-9.38	25.5	16.14	28.8

**Result:** Test passed

**FREQUENCY STABILITY VS. TEMPERATURE****Section 95.623c**

EUT: T4YBF 72  
Serial number: 001  
Applicant: Futaba Corporation  
Mode: - transmitting continuously (TX mode)  
- without modulation  
- operating with  $f = 72.550$  MHz  
Date of test: June 20, 2002  
Operator: Thomas Eberl

**Test conditions:**

Temperature: see table below  
Supply voltage: 9.6 V DC

**Specifications:**

Frequency tolerance:  $\pm 0.002$  % of nominal carrier frequency  
Temperature range: -30 to +50°C

Temperature (°C)	Nominal car. frequency (MHz)	Frequency measured (MHz)	Frequency deviation (Hz)	Frequency deviation (%)	Limit (%)
-30	72.550	72.54948	-520	0.0007167	0.002
-20	72.550	72.55036	+360	0.0004962	0.002
-10	72.550	72.55049	+490	0.0006753	0.002
0	72.550	72.55044	+440	0.0006064	0.002
+10	72.550	72.55028	+280	0.0003859	0.002
+20	72.550	72.55010	+10	0.0000137	0.002
+30	72.550	72.54968	-320	0.0004410	0.002
+40	72.550	72.54942	-580	0.0007994	0.002
+50	72.550	72.54928	-720	0.0009924	0.002

**Result:** Test passed



**FREQUENCY STABILITY VS. SUPPLY VOLTAGE****Section 95.623c**

EUT: T4YBF 72  
Serial number: 001  
Applicant: Futaba Corporation  
Mode: - transmitting continuously (TX mode)  
- without modulation  
- operating with  $f = 72.550$  MHz  
Date of test: June 20, 2002  
Operator: Thomas Eberl

**Test conditions:**

Temperature: +20°C  
Nominal supply voltage: 9.6 V DC

**Specifications:**

Frequency tolerance:  $\pm 0.002$  % of nominal carrier frequency  
Voltage range:  $\pm 15$  % of nominal supply voltage

Supply voltage (V)	Nominal car. frequency (MHz)	Frequency measured (MHz)	Frequency deviation (Hz)	Frequency deviation (%)	Limit (%)
8.16	72.550	72.54980	-200	0.0002756	0.002
8.50	72.550	72.54985	-150	0.0002067	0.002
9.00	72.550	72.54990	-100	0.0001378	0.002
9.60	72.550	72.54991	-90	0.0001240	0.002
10.00	72.550	72.55001	+10	0.0000137	0.002
10.50	72.550	72.55003	+30	0.0000413	0.002
11.04	72.550	72.55004	+40	0.0000551	0.002
Batt. end point (V)					
6.5	72.550	72.54939	-610	0.0008400	0.002

**Result:** Test passed

**EMISSION BANDWIDTH****Section 95.633b**

EUT: T4YBF 72  
Serial number: 001  
Applicant: Futaba Corporation  
Mode: - transmitting continuously (TX mode)  
- with modulation  
- operating with  $f = 72.550$  MHz  
Date of test: June 20, 2002  
Operator: Thomas Eberl

**Test conditions:**

Temperature: +20°C  
Supply voltage: 12.0 V DC

**Specifications:**

Authorized bandwidth: 8 kHz

**Note:**

Emission bandwidth was measured as occupied bandwidth. For details see plot on following page.

Test procedure	Measured occupied bandwidth (kHz)	Limit (kHz)
TIA/EI-603	4.7	8.00

**Result:** Test passed

Calculation	$B_n = 2M + 2DK$
M = Modulation Frequency	M = 1.55 kHz
D = Deviation	D = 1.45 kHz
	K = 1
	$B_n = 2(1.55 \text{ kHz}) + 2(1.45 \text{ kHz}) = 3.1 + 2.9 = 6 \text{ kHz}$

**Type of Emission = 6K00F3E**

## EMISSION BANDWIDTH (CONTINUED))

## Section 95.633b

### Specifications:

Authorized bandwidth: 8 kHz  
Test procedure: TIA/EIA-603 (99% of total power with RBW as close to, but not less than 1% of the 99% power bandwidth)

### Note:

Tested on antenna connector via dummy load

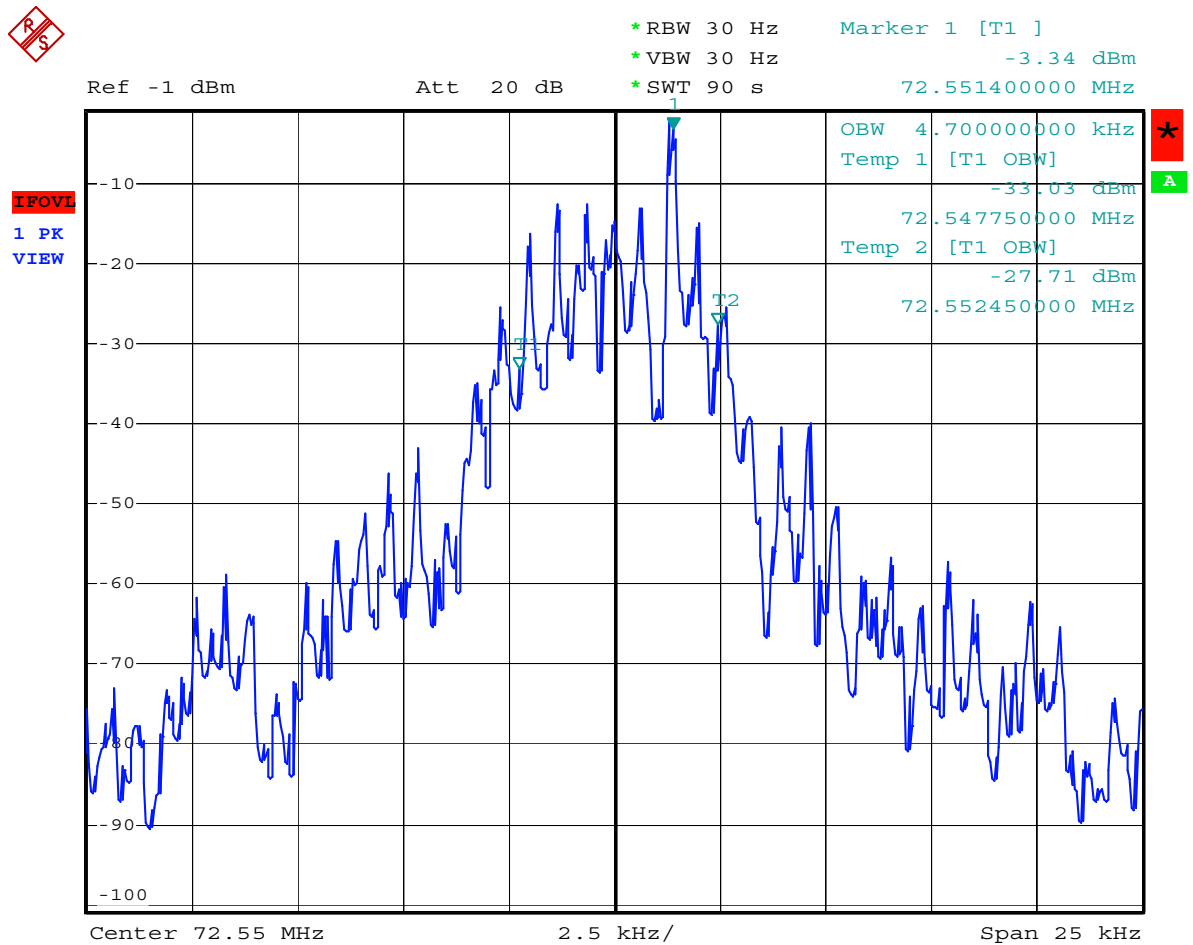

## UNWANTED RADIATION 30 MHz - 1 GHz

## Section 95.635

EUT: T4YBF 72  
 Serial number: 001  
 Applicant: Futaba Corporation  
 Mode: - transmitting continuously (TX mode)  
 - with modulation  
 - with supply voltage 9.6 V DC  
 - antenna extended to maximum  
 - operating with  $f = 72.550\text{MHz}$   
 - EUT in vertical position, antenna to the top  
 Date of test: June 19, 2002  
 Operator: Thomas Eberl

### Specifications:

Test-distance: 3 meters  
 Limit:  $10 \log(P_{\text{carrier}}) - 56 \text{ dB}$   
 with  $P_{\text{carrier}}$  as the maximum transmitter power limit for the unmodulated carrier according to §95.639

Maximum transmitter power (conducted) :	23.8 dBm	0.240 Watt
Maximum carrier power (radiated) :	16.79 dBm	0.047 Watt
Calculated limit (referring to TP) :	-26.0 dBm (constant)	

Frequency (MHz)	Polarization V/H	Reading value (dBm)	Correction factor (dB)	ERP (dBm)	Calculated limit (dBm)	Margin to limit (dB)
72.550	V	-7.95	24.74	16.79	28.8	12.01
217.650	V	-69.87	19.84	-50.02	-26.0	22.72
290.200	V	-76.72	25.78	-50.94	-26.0	23.64
362.750	V	-77.60	28.24	-59.36	-26.0	32.06
435.300	V	-70.88	28.11	-42.77	-26.0	15.47
507.850	V	-77.46	28.12	-49.33	-26.0	22.03
580.400	V	-82.19	30.67	-51.52	-26.0	24.22
652.950	V	-88.68	29.94	-58.74	-26.0	31.44
725.500	H	-85.30	31.07	-54.23	-26.0	26.93
798.050	V	-81.22	32.41	-48.82	-26.0	21.52
870.600	V	-88.86	34.17	-54.69	-26.0	27.39
943.600	H	-100.37	34.03	-66.34	-26.0	39.04

**Note:** For calculation of correction factors see tables "Test Site Calibration 30 MHz - 1 GHz for ERP Measurements (Substitution Method)" starting on page 32.

**Result:** Test passed

## UNWANTED RADIATION 30 MHz - 1 GHz

## Section 95.635

EUT: T4YBF 72  
 Serial number: 001  
 Applicant: Futaba Corporation  
 Mode: - transmitting continuously (TX mode)  
 - with modulation  
 - with supply voltage 9.6 V DC  
 - antenna extended to maximum  
 - operating with  $f = 72.550$  MHz  
 - EUT in horizontal position with rear side on table

Date of test: June 19, 2002  
 Operator: Thomas Eberl

### Specifications:

Test-distance: 3 meters  
 Limit:  $10 \log(P_{\text{carrier}}) - 56$  dB  
 with  $P_{\text{carrier}}$  as the maximum transmitter power limit for the unmodulated carrier according to §95.639

Maximum transmitter power (conducted) :	23.8 dBm	0.240 Watt
Maximum carrier power (radiated) :	16.79 dBm	0.047 Watt
Calculated limit (referring to TP) :	-26.0 dBm (constant)	

Frequency (MHz)	Polarization V/H	Reading value (dBm)	Correction factor (dB)	ERP (dBm)	Calculated limit (dBm)	Margin to limit (dB)
72.550	H	-9.54	25.51	15.97	28.8	12.83
217.650	H	-72.94	20.37	-52.58	-26.0	25.28
290.200	H	-86.11	24.06	-62.05	-26.0	34.75
362.750	H	-77.49	27.82	-49.67	-26.0	22.37
435.300	H	-87.13	29.56	-57.57	-26.0	30.27
507.850	H	-96.88	28.61	-68.26	-26.0	40.96
580.400	H	-85.99	29.21	-56.79	-26.0	29.49
652.950	H	-85.84	29.75	-56.08	-26.0	28.78
725.500	H	-85.49	31.07	-54.43	-26.0	27.13
798.050	H	-80.03	31.60	-48.43	-26.0	21.13
870.600	H	-86.04	32.67	-53.37	-26.0	26.07
943.150	H	-95.26	34.03	-61.23	-26.0	33.93

**Note:** For calculation of correction factors see tables "Test Site Calibration 30 MHz - 1 GHz for ERP Measurements (Substitution Method)" starting on page 32.

**Result:** Test passed

## UNWANTED RADIATION 30 MHz - 1 GHz

## Section 95.635

EUT: T4YBF 72  
 Serial number: 001  
 Applicant: Futaba Corporation

Mode: - transmitting continuously (TX mode)  
 - with modulation  
 - with supply voltage 9.6 V DC  
 - antenna extended to maximum  
 - operating with  $f = 72.550$  MHz  
 - EUT in horizontal position with right side on table

Date of test: June 19, 2002  
 Operator: Thomas Eberl

### Specifications:

Test-distance: 3 meters  
 Limit:  $10 \log(P_{\text{carrier}}) - 56$  dB  
 with  $P_{\text{carrier}}$  as the maximum transmitter power limit for the unmodulated carrier according to §95.639

Maximum transmitter power (conducted) :	23.8 dBm	0.240 Watt
Maximum carrier power (radiated) :	16.79 dBm	0.047 Watt
Calculated limit (referring to TP) :	-26.0 dBm (constant)	

Frequency (MHz)	Polarization V/H	Reading value (dBm)	Correction factor (dB)	ERP (dBm)	Calculated limit (dBm)	Margin to limit (dB)
72.550	H	-9.38	25.51	16.14	28.8	12.66
217.650	H	-72.53	20.37	-52.17	-26.0	24.87
290.200	H	-85.79	24.06	-61.73	-26.0	34.43
362.750	H	-80.98	27.84	-53.15	-26.0	25.85
435.300	H	-86.54	29.56	56.99	-26.0	29.69
507.850	H	-92.28	28.62	-63.67	-26.0	36.37
580.400	H	-89.50	29.2	-60.30	-26.0	33.00
652.950	H	-90.90	29.76	-61.14	-26.0	33.84
725.500	V	-87.21	29.52	-57.69	-26.0	30.39
798.050	V	-85.29	32.41	-52.89	-26.0	25.59
870.600	V	-90.26	34.17	-56.09	-26.0	28.79
943.150	H	-90.62	34.04	-56.58	-26.0	29.28

**Note:** For calculation of correction factors see tables "Test Site Calibration 30 MHz - 1 GHz for ERP Measurements (Substitution Method)" starting on page 32.

**Result:** Test passed

## 12. Additional Results

**Radiated Power Test 25 MHz - 200 MHz**  
acc. to FCC Part 95 Subpart C/E

Model: T4YBF 72 MHz	Comment:  - TX mode f= 72.550 Mhz  - EUT in vertical position
Serial no.: 001	
Applicant: Futaba Corporation	
Test site: Fully anechoic room	
Tested on: Test distance 3 meters Horizontal Polarization	
Date of test: 06/25/2002	
Test performed: automatically	File name: default.emi

Detector: Peak	List of values: Selected by hand
-------------------	-------------------------------------

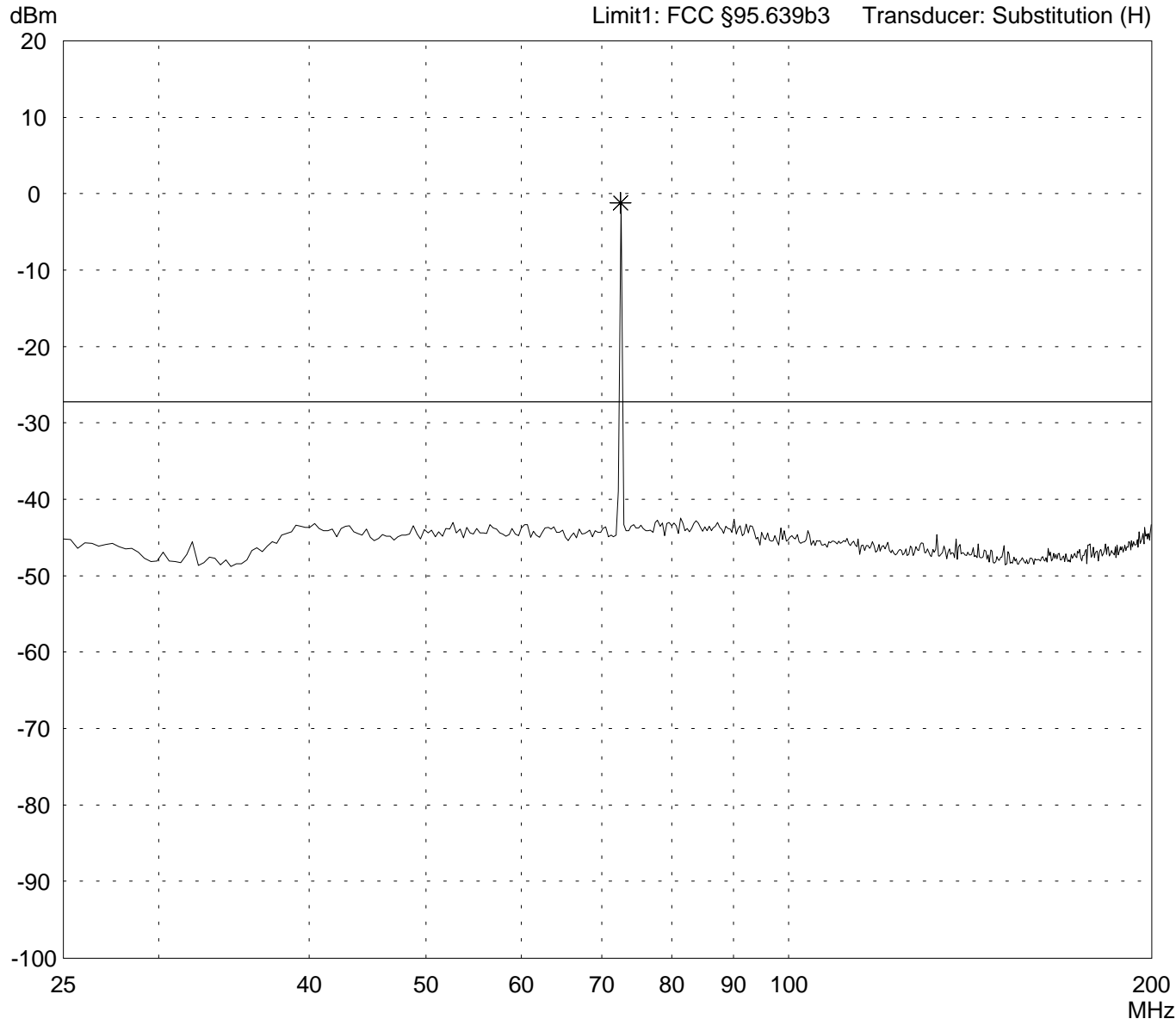

Result: Limit kept	Project file: 55503-20364	Page 32 of 55 Pages
-----------------------	------------------------------	---------------------



**Radiated Power Test 25 MHz - 200 MHz  
acc. to FCC Part 95 Subpart C/E**

Model: T4YBF 72 MHz	Comment:  - TX mode f= 72.550 Mhz  - EUT in vertical position
Serial no.: 001	
Applicant: Futaba Corporation	
Test site: Fully anechoic room	
Tested on: Test distance 3 meters Horizontal Polarization	
Date of test: 06/25/2002      Operator: T. Eberl	
Test performed: automatically      File name: default.emi	

Detector: Peak	List of values: Selected by hand
-------------------	-------------------------------------

<i>Frequency [MHz]</i>	<i>Reading [dBm]</i>	<i>Correction factor [dB]</i>	<i>Value [dBm]</i>	<i>Limit [dBm]</i>	<i>Limit exceeded</i>
72.550000	-26.73	25.51	-1.22	-27.25	*

Result: Limit kept	Project file: 55503-20364	Page 33 of 55 Pages
-----------------------	------------------------------	---------------------

**Radiated Power Test 25 MHz - 200 MHz**  
acc. to FCC Part 95 Subpart C/E

Model: T4YBF 72 MHz	Comment:  - TX mode f= 72.550 Mhz  - EUT in horizontal position (rear side on table)
Serial no.: 001	
Applicant: Futaba Corporation	
Test site: Fully anechoic room	
Tested on: Test distance 3 meters Horizontal Polarization	
Date of test: 06/25/2002	Operator: T. Eberl
Test performed: automatically	File name: default.emi

Detector: Peak	List of values: Selected by hand
-------------------	-------------------------------------

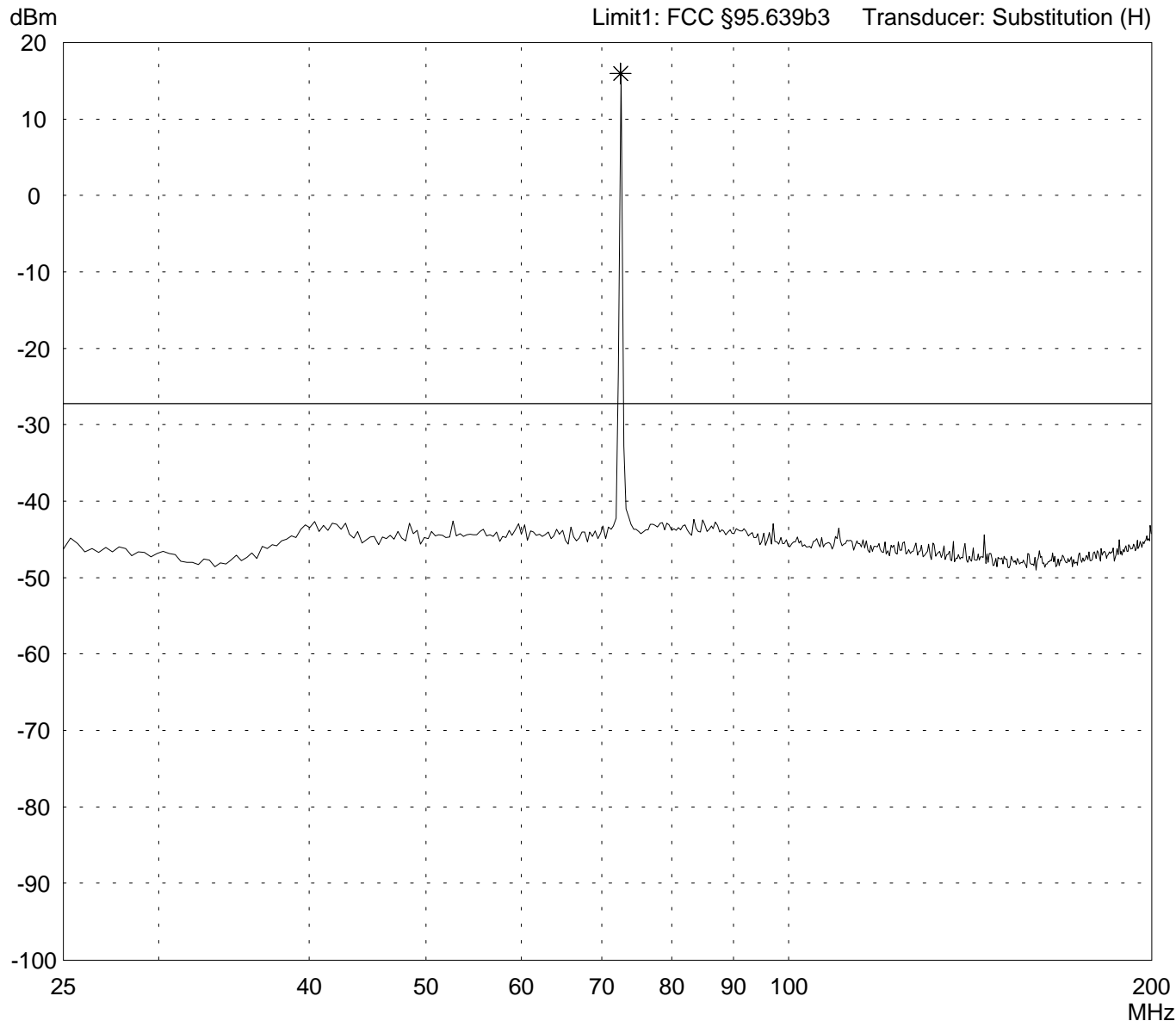

Result: Limit kept	Project file: 55503-20364	Page 34 of 55 Pages
-----------------------	------------------------------	---------------------

**Radiated Power Test 25 MHz - 200 MHz  
acc. to FCC Part 95 Subpart C/E**

Model: T4YBF 72 MHz	Comment:  - TX mode f= 72.550 Mhz  - EUT in horizontal position (rear side on table)
Serial no.: 001	
Applicant: Futaba Corporation	
Test site: Fully anechoic room	
Tested on: Test distance 3 meters Horizontal Polarization	
Date of test: 06/25/2002      Operator: T. Eberl	
Test performed: automatically      File name: default.emi	

Detector: Peak	List of values: Selected by hand
-------------------	-------------------------------------

<i>Frequency [MHz]</i>	<i>Reading [dBm]</i>	<i>Correction factor [dB]</i>	<i>Value [dBm]</i>	<i>Limit [dBm]</i>	<i>Limit exceeded</i>
72.550000	-9.54	25.51	15.97	-27.25	*

Result: Limit kept	Project file: 55503-20364	Page 35 of 55 Pages
-----------------------	------------------------------	---------------------

# Radiated Power Test 25 MHz - 200 MHz acc. to FCC Part 95 Subpart C/E

<p>Model: <b>T4YBF 72 MHz</b></p> <p>Serial no.: <b>001</b></p> <p>Applicant: <b>Futaba Corporation</b></p> <p>Test site: <b>Fully anechoic room</b></p> <p>Tested on: <b>Test distance 3 meters Horizontal Polarization</b></p> <p>Date of test: <b>06/25/2002</b>      Operator: <b>T. Eberl</b></p> <p>Test performed: <b>automatically</b>      File name: <b>default.emi</b></p>	<p>Comment:</p> <ul style="list-style-type: none"> <li>- TX mode f= 72.550 Mhz</li> <li>- EUT in horizontal position (right side on table)</li> </ul>
---	---

<p>Detector: <b>Peak</b></p>	<p>List of values: <b>Selected by hand</b></p>
----------------------------------	--

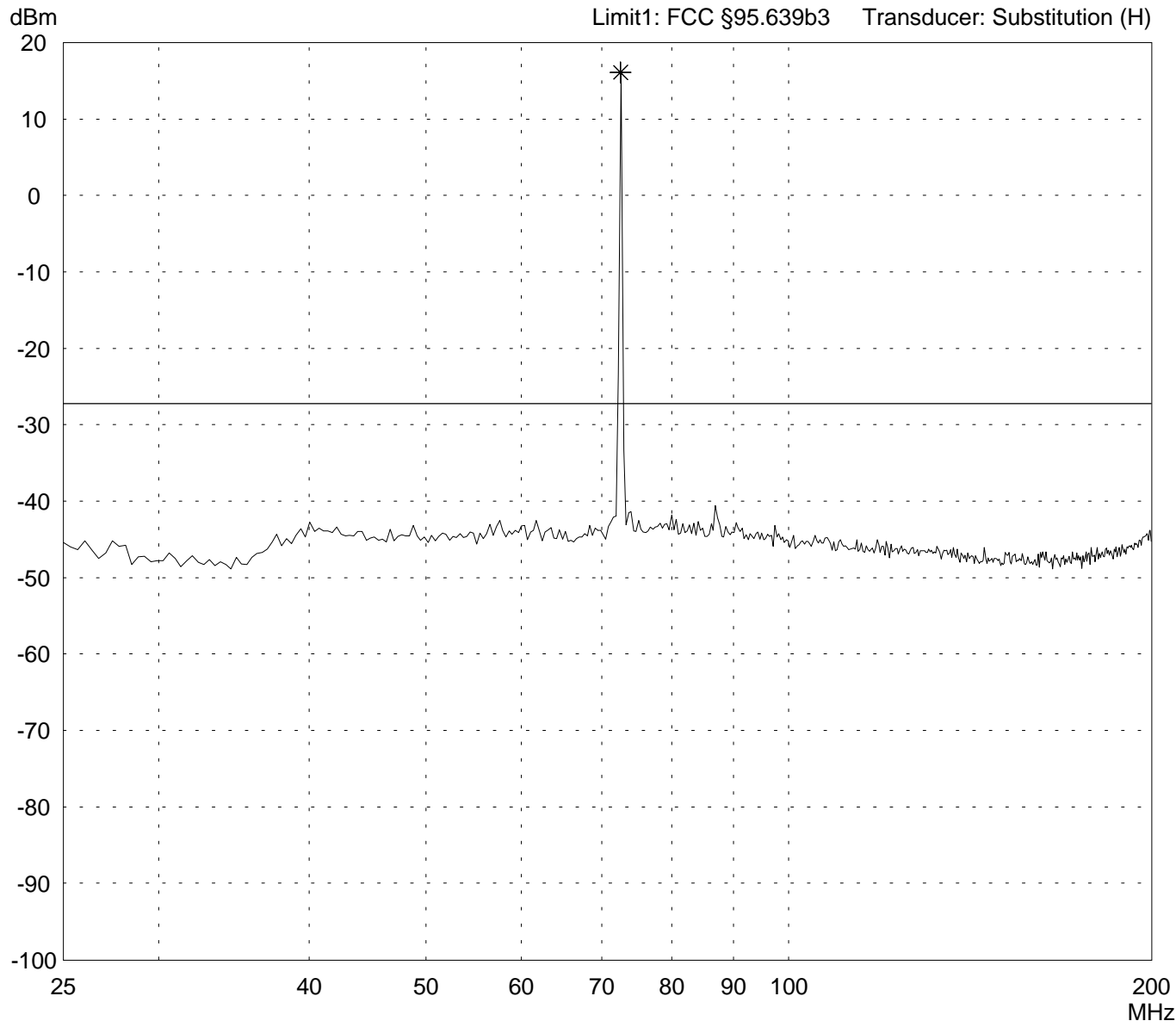

<p>Result: <b>Limit kept</b></p>	<p>Project file: <b>55503-20364</b></p>
--------------------------------------	---

**Radiated Power Test 25 MHz - 200 MHz  
acc. to FCC Part 95 Subpart C/E**

Model: T4YBF 72 MHz	Comment:  - TX mode f= 72.550 Mhz  - EUT in horizontal position (right side on table)
Serial no.: 001	
Applicant: Futaba Corporation	
Test site: Fully anechoic room	
Tested on: Test distance 3 meters Horizontal Polarization	
Date of test: 06/25/2002      Operator: T. Eberl	
Test performed: automatically      File name: default.emi	

Detector: Peak	List of values: Selected by hand
-------------------	-------------------------------------

<i>Frequency [MHz]</i>	<i>Reading [dBm]</i>	<i>Correction factor [dB]</i>	<i>Value [dBm]</i>	<i>Limit [dBm]</i>	<i>Limit exceeded</i>
72.550000	-9.38	25.51	16.14	-27.25	*

Result: Limit kept	Project file: 55503-20364	Page 37 of 55 Pages
-----------------------	------------------------------	---------------------

# Radiated Power Test 200 MHz - 1 GHz acc. to FCC Part 95 Subpart C/E

Model:  
T4YBF 72 MHz

Serial no.:  
001

Applicant:  
Futaba Corporation

Test site:  
Fully anechoic room

Tested on:  
Test distance 3 meters  
Horizontal Polarization

Date of test:  
06/19/2002

Operator:  
T. Eberl

Test performed:  
automatically

File name:  
default.emi

Comment:

- TX mode f= 72.550 MHz

- EUT in vertical position

Detector:  
Peak

List of values:  
Selected by hand

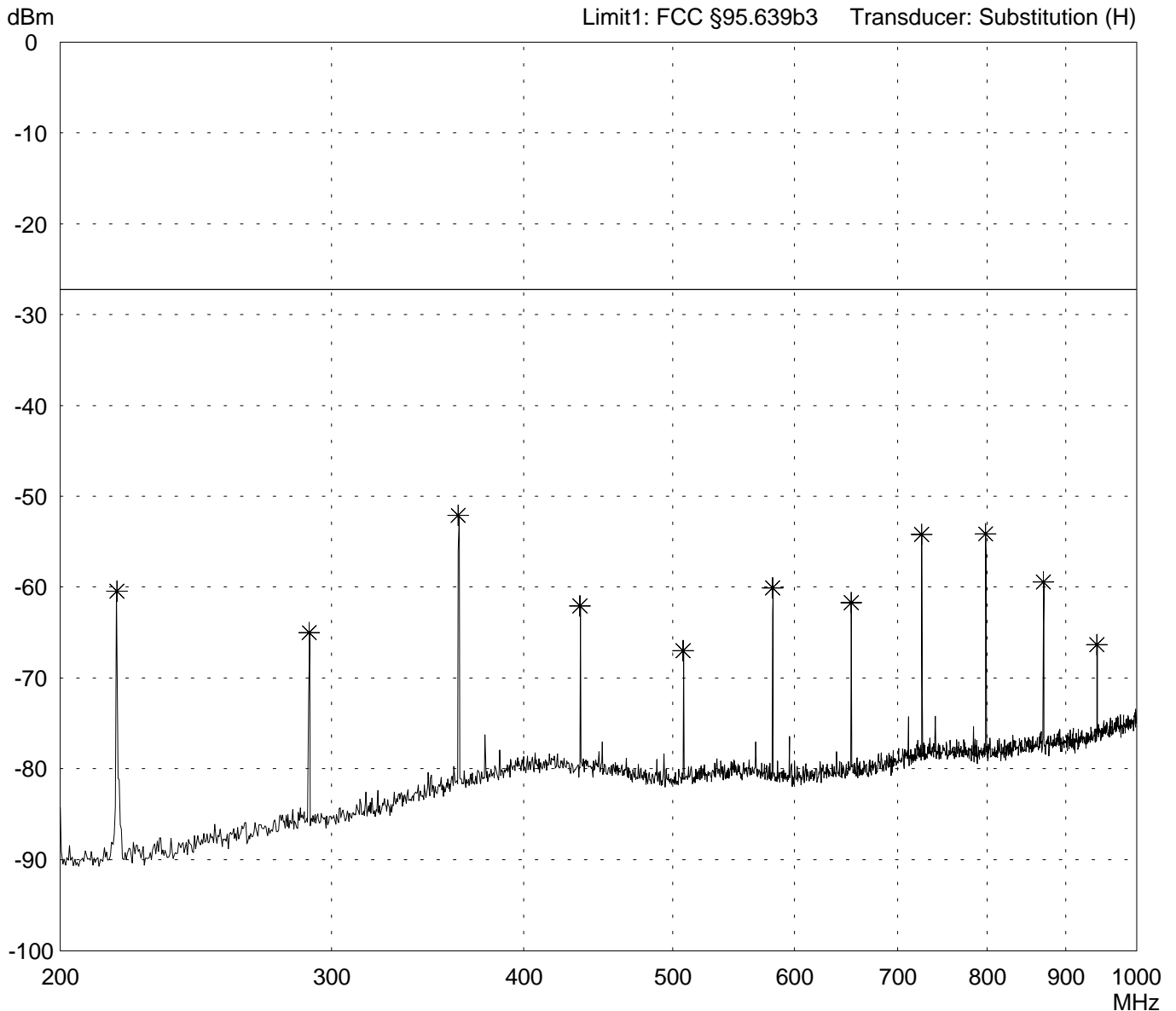

Result:  
Limit kept

Project file:  
55503-20364

Page 38 of 55 Pages

**Radiated Power Test 200 MHz - 1 GHz  
acc. to FCC Part 95 Subpart C/E**

<p>Model: <b>T4YBF 72 MHz</b></p> <p>Serial no.: <b>001</b></p> <p>Applicant: <b>Futaba Corporation</b></p> <p>Test site: <b>Fully anechoic room</b></p> <p>Tested on: <b>Test distance 3 meters Horizontal Polarization</b></p> <p>Date of test:                      Operator: <b>06/19/2002                      T. Eberl</b></p> <p>Test performed:                      File name: <b>automatically                      default.emi</b></p>	<p>Comment:</p> <ul style="list-style-type: none"> <li>- TX mode f= 72.550 MHz</li> <li>- EUT in vertical position</li> </ul>
---	---

<p>Detector: <b>Peak</b></p>	<p>List of values: <b>Selected by hand</b></p>
----------------------------------	--

<i>Frequency [MHz]</i>	<i>Reading [dBm]</i>	<i>Correction factor [dB]</i>	<i>Value [dBm]</i>	<i>Limit [dBm]</i>	<i>Limit exceeded</i>
217.650000	-80.83	20.37	-60.46	-27.25	
290.200000	-89.11	24.06	-65.05	-27.25	
362.750000	-79.92	27.82	-52.10	-27.25	
435.300000	-91.64	29.56	-62.08	-27.25	
507.850000	-95.65	28.61	-67.03	-27.25	
580.400000	-89.30	29.21	-60.09	-27.25	
652.950000	-91.50	29.75	-61.74	-27.25	
725.500000	-85.30	31.07	-54.23	-27.25	
798.050000	-85.73	31.60	-54.13	-27.25	
870.600000	-92.10	32.67	-59.43	-27.25	
943.150000	-100.37	34.03	-66.34	-27.25	

<p>Result: <b>Limit kept</b></p>	<p>Project file: <b>55503-20364</b></p> <p style="text-align: right;"><b>Page 39 of 55 Pages</b></p>
--------------------------------------	--

# Radiated Power Test 200 MHz - 1 GHz acc. to FCC Part 95 Subpart C/E

<p>Model: <b>T4YBF 72 MHz</b></p> <p>Serial no.: <b>001</b></p> <p>Applicant: <b>Futaba Corporation</b></p> <p>Test site: <b>Fully anechoic room</b></p> <p>Tested on: <b>Test distance 3 meters Horizontal Polarization</b></p>	<p>Comment:</p> <ul style="list-style-type: none"> <li>- TX mode f= 72.550 MHz</li> <li>- EUT in horizontal position (rear side on table)</li> </ul>
<p>Date of test: <b>06/19/2002</b></p> <p>Operator: <b>T. Eberl</b></p>	<p>Test performed: <b>automatically</b></p> <p>File name: <b>default.emi</b></p>

<p>Detector: <b>Peak</b></p>	<p>List of values: <b>Selected by hand</b></p>
----------------------------------	--

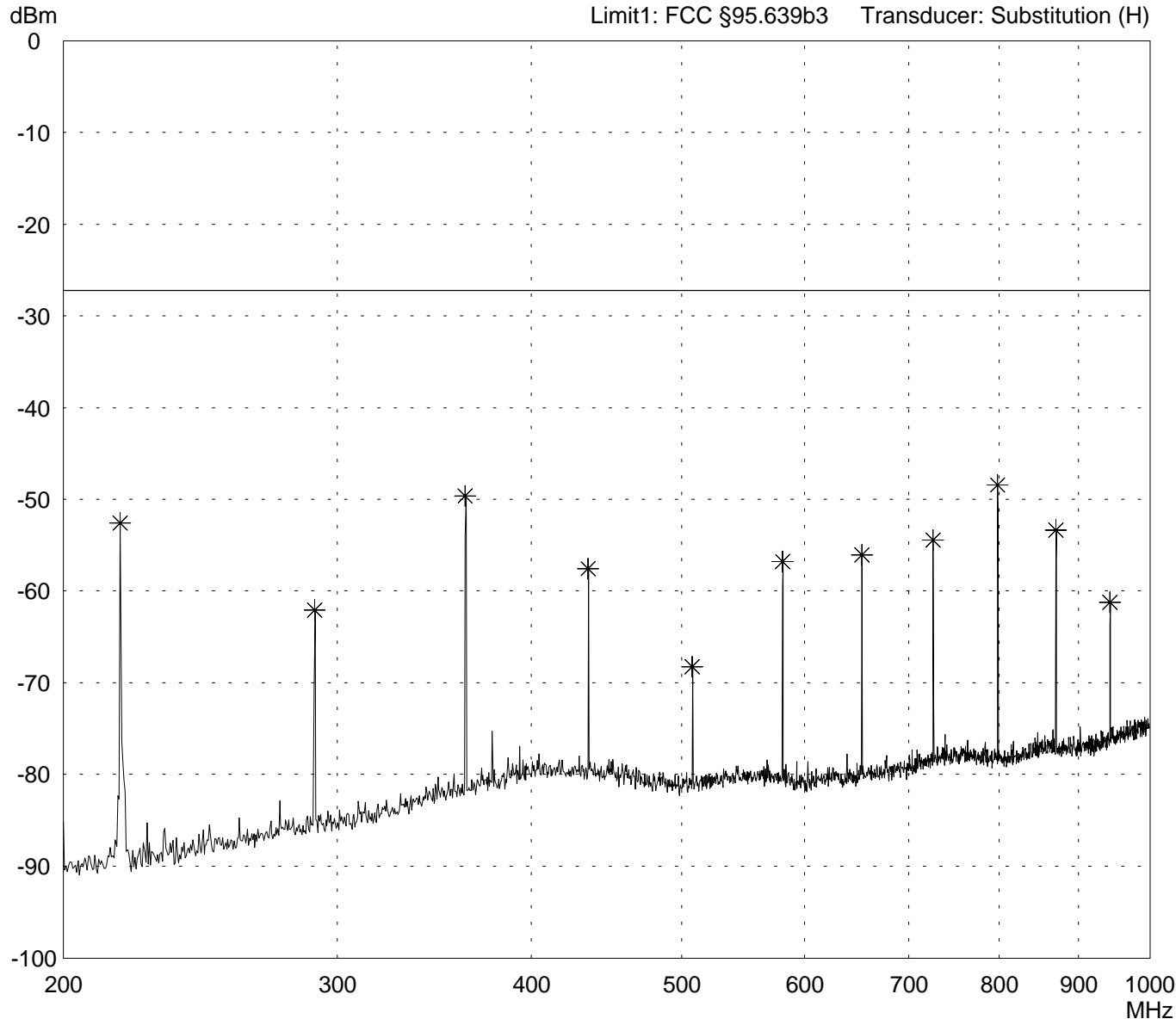

<p>Result: <b>Limit kept</b></p>	<p>Project file: <b>55503-20364</b></p>
--------------------------------------	---



**Radiated Power Test 200 MHz - 1 GHz  
acc. to FCC Part 95 Subpart C/E**

<p>Model: <b>T4YBF 72 MHz</b></p> <p>Serial no.: <b>001</b></p> <p>Applicant: <b>Futaba Corporation</b></p> <p>Test site: <b>Fully anechoic room</b></p> <p>Tested on: <b>Test distance 3 meters Horizontal Polarization</b></p> <p>Date of test:                      Operator: <b>06/19/2002                      T. Eberl</b></p> <p>Test performed:                  File name: <b>automatically                  default.emi</b></p>	<p>Comment:</p> <ul style="list-style-type: none"> <li>- TX mode f= 72.550 MHz</li> <li>- EUT in horizontal position (rear side on table)</li> </ul>
---	--

<p>Detector: <b>Peak</b></p>	<p>List of values: <b>Selected by hand</b></p>
----------------------------------	--

<i>Frequency [MHz]</i>	<i>Reading [dBm]</i>	<i>Correction factor [dB]</i>	<i>Value [dBm]</i>	<i>Limit [dBm]</i>	<i>Limit exceeded</i>
217.600000	-72.94	20.37	-52.58	-27.25	
290.200000	-86.11	24.06	-62.05	-27.25	
362.750000	-77.49	27.82	-49.67	-27.25	
435.300000	-87.13	29.56	-57.57	-27.25	
507.850000	-96.88	28.61	-68.26	-27.25	
580.400000	-85.99	29.21	-56.79	-27.25	
652.950000	-85.84	29.75	-56.08	-27.25	
725.500000	-85.49	31.07	-54.43	-27.25	
798.050000	-80.03	31.60	-48.43	-27.25	
870.600000	-86.04	32.67	-53.37	-27.25	
943.150000	-95.26	34.03	-61.23	-27.25	

<p>Result: <b>Limit kept</b></p>	<p>Project file: <b>55503-20364</b></p> <p style="text-align: right;"><b>Page 41 of 55 Pages</b></p>
--------------------------------------	--

# Radiated Power Test 200 MHz - 1 GHz acc. to FCC Part 95 Subpart C/E

<p>Model: <b>T4YBF 72 MHz</b></p> <p>Serial no.: <b>001</b></p> <p>Applicant: <b>Futaba Corporation</b></p> <p>Test site: <b>Fully anechoic room</b></p> <p>Tested on: <b>Test distance 3 meters Horizontal Polarization</b></p> <p>Date of test: <b>06/19/2002</b></p> <p>Operator: <b>T. Eberl</b></p> <p>Test performed: <b>automatically</b></p> <p>File name: <b>default.emi</b></p>	<p>Comment:</p> <ul style="list-style-type: none"> <li>- TX mode f= 72.550 MHz</li> <li>- EUT in horizontal position (right side on table)</li> </ul>
---	---

<p>Detector: <b>Peak</b></p>	<p>List of values: <b>Selected by hand</b></p>
----------------------------------	--

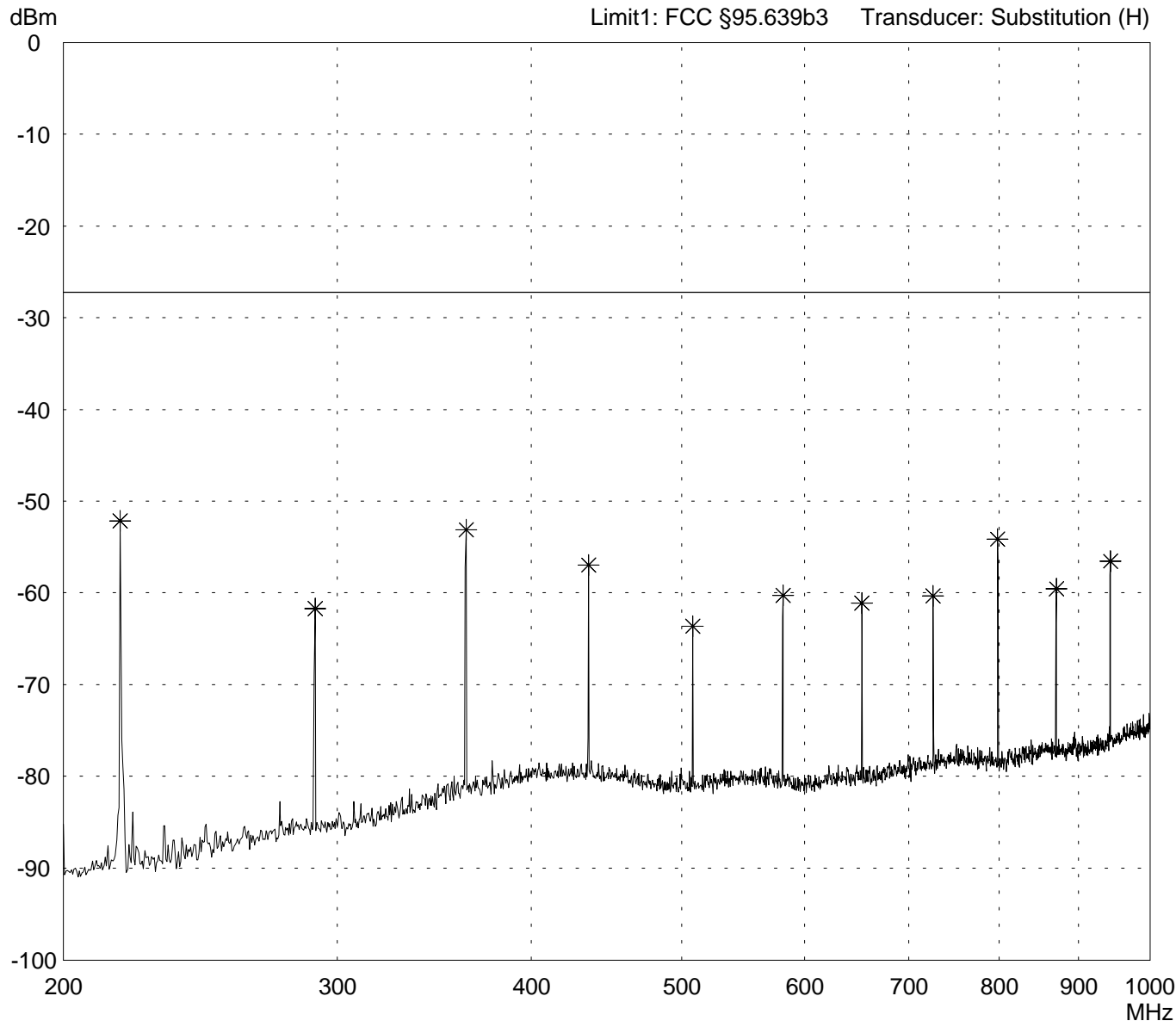

<p>Result: <b>Limit kept</b></p>	<p>Project file: <b>55503-20364</b></p> <p style="text-align: right;">Page 42 of 55 Pages</p>
--------------------------------------	---

**Radiated Power Test 200 MHz - 1 GHz  
acc. to FCC Part 95 Subpart C/E**

<p>Model: <b>T4YBF 72 MHz</b></p> <p>Serial no.: <b>001</b></p> <p>Applicant: <b>Futaba Corporation</b></p> <p>Test site: <b>Fully anechoic room</b></p> <p>Tested on: <b>Test distance 3 meters Horizontal Polarization</b></p> <p>Date of test:                      Operator: <b>06/19/2002                      T. Eberl</b></p> <p>Test performed:                      File name: <b>automatically                      default.emi</b></p>	<p>Comment:</p> <ul style="list-style-type: none"> <li>- TX mode f= 72.550 MHz</li> <li>- EUT in horizontal position (right side on table)</li> </ul>
---	---

<p>Detector: <b>Peak</b></p>	<p>List of values: <b>Selected by hand</b></p>
----------------------------------	--

<i>Frequency [MHz]</i>	<i>Reading [dBm]</i>	<i>Correction factor [dB]</i>	<i>Value [dBm]</i>	<i>Limit [dBm]</i>	<i>Limit exceeded</i>
217.600000	-72.53	20.37	-52.17	-27.25	
290.400000	-85.79	24.06	-61.73	-27.25	
363.200000	-80.98	27.84	-53.15	-27.25	
435.600000	-86.54	29.56	-56.99	-27.25	
508.000000	-92.28	28.62	-63.67	-27.25	
580.800000	-89.50	29.20	-60.30	-27.25	
653.200000	-90.90	29.76	-61.14	-27.25	
725.600000	-91.43	31.07	-60.37	-27.25	
798.400000	-85.74	31.60	-54.15	-27.25	
870.800000	-92.20	32.67	-59.54	-27.25	
943.600000	-90.62	34.04	-56.58	-27.25	

<p>Result: <b>Limit kept</b></p>	<p>Project file: <b>55503-20364</b></p> <p style="text-align: right;"><b>Page 43 of 55 Pages</b></p>
--------------------------------------	--

**Radiated Power Test 25 MHz - 200 MHz**  
acc. to FCC Part 95 Subpart C/E

Model: T4YBF 72 MHz	Comment:  - TX mode f= 72.550 Mhz  - EUT in vertical position
Serial no.: 001	
Applicant: Futaba Corporation	
Test site: Fully anechoic room	
Tested on: Test distance 3 meters Vertical Polarization	
Date of test: 06/25/2002	
Test performed: automatically	File name: default.emi

Detector: Peak	List of values: Selected by hand
-------------------	-------------------------------------

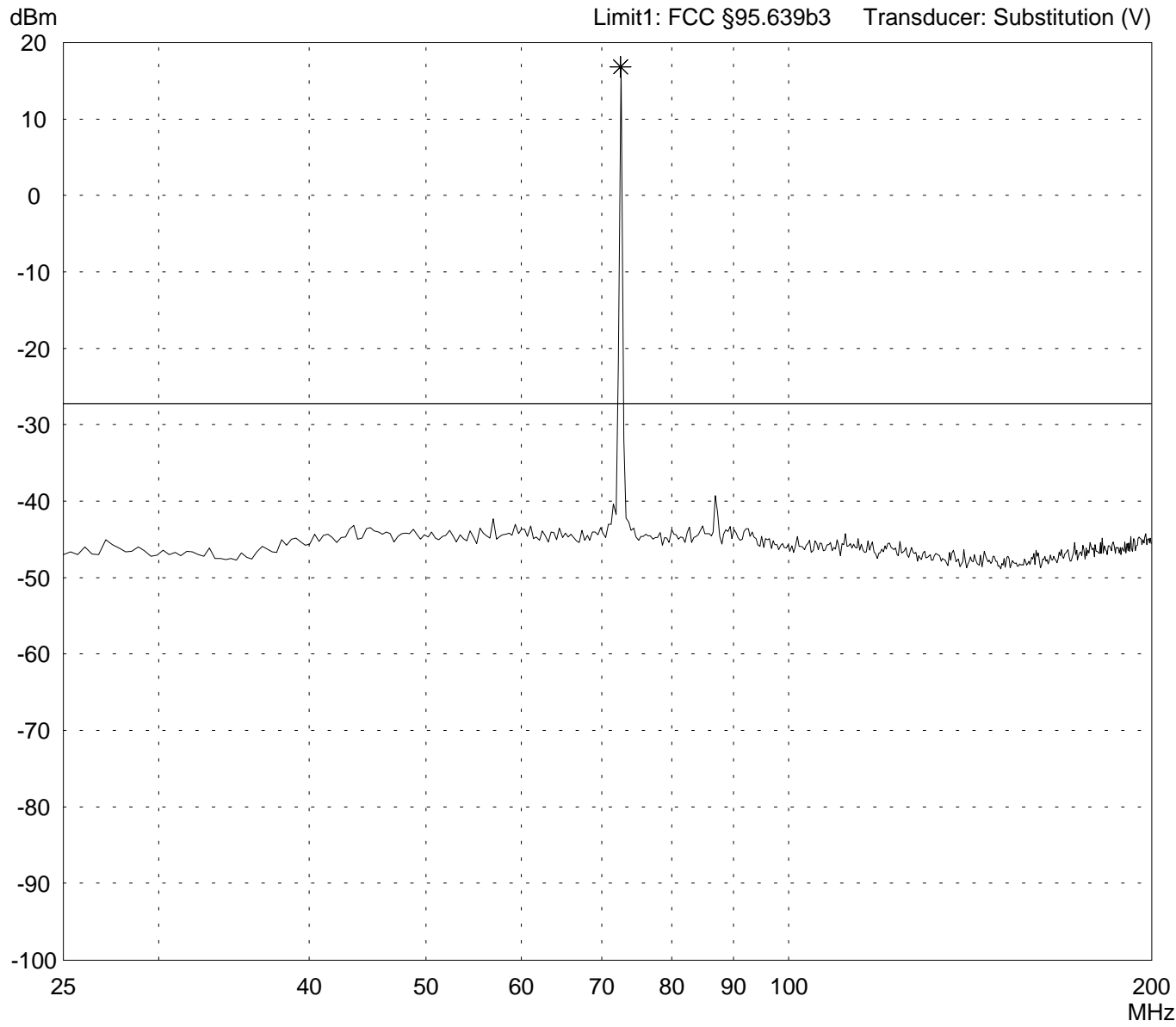

Result: Limit kept	Project file: 55503-20364	Page 44 of 55 Pages
-----------------------	------------------------------	---------------------

**Radiated Power Test 25 MHz - 200 MHz  
acc. to FCC Part 95 Subpart C/E**

Model: T4YBF 72 MHz	Comment:  - TX mode f= 72.550 Mhz  - EUT in vertical position
Serial no.: 001	
Applicant: Futaba Corporation	
Test site: Fully anechoic room	
Tested on: Test distance 3 meters Vertical Polarization	
Date of test: 06/25/2002      Operator: T. Eberl	
Test performed: automatically      File name: default.emi	

Detector: Peak	List of values: Selected by hand
-------------------	-------------------------------------

<i>Frequency [MHz]</i>	<i>Reading [dBm]</i>	<i>Correction factor [dB]</i>	<i>Value [dBm]</i>	<i>Limit [dBm]</i>	<i>Limit exceeded</i>
72.550000	-7.95	24.74	16.79	-27.25	*

Result: Limit kept	Project file: 55503-20364	Page 45 of 55 Pages
-----------------------	------------------------------	---------------------

# Radiated Power Test 25 MHz - 200 MHz acc. to FCC Part 95 Subpart C/E

<p>Model: <b>T4YBF 72 MHz</b></p> <p>Serial no.: <b>001</b></p> <p>Applicant: <b>Futaba Corporation</b></p> <p>Test site: <b>Fully anechoic room</b></p> <p>Tested on: <b>Test distance 3 meters Vertical Polarization</b></p> <p>Date of test: <b>06/25/2002</b>      Operator: <b>T. Eberl</b></p> <p>Test performed: <b>automatically</b>      File name: <b>default.emi</b></p>	<p>Comment:</p> <ul style="list-style-type: none"> <li>- TX mode f= 72.550 Mhz</li> <li>- EUT in horizontal position (rear side on table)</li> </ul>
---	--

<p>Detector: <b>Peak</b></p>	<p>List of values: <b>Selected by hand</b></p>
----------------------------------	--

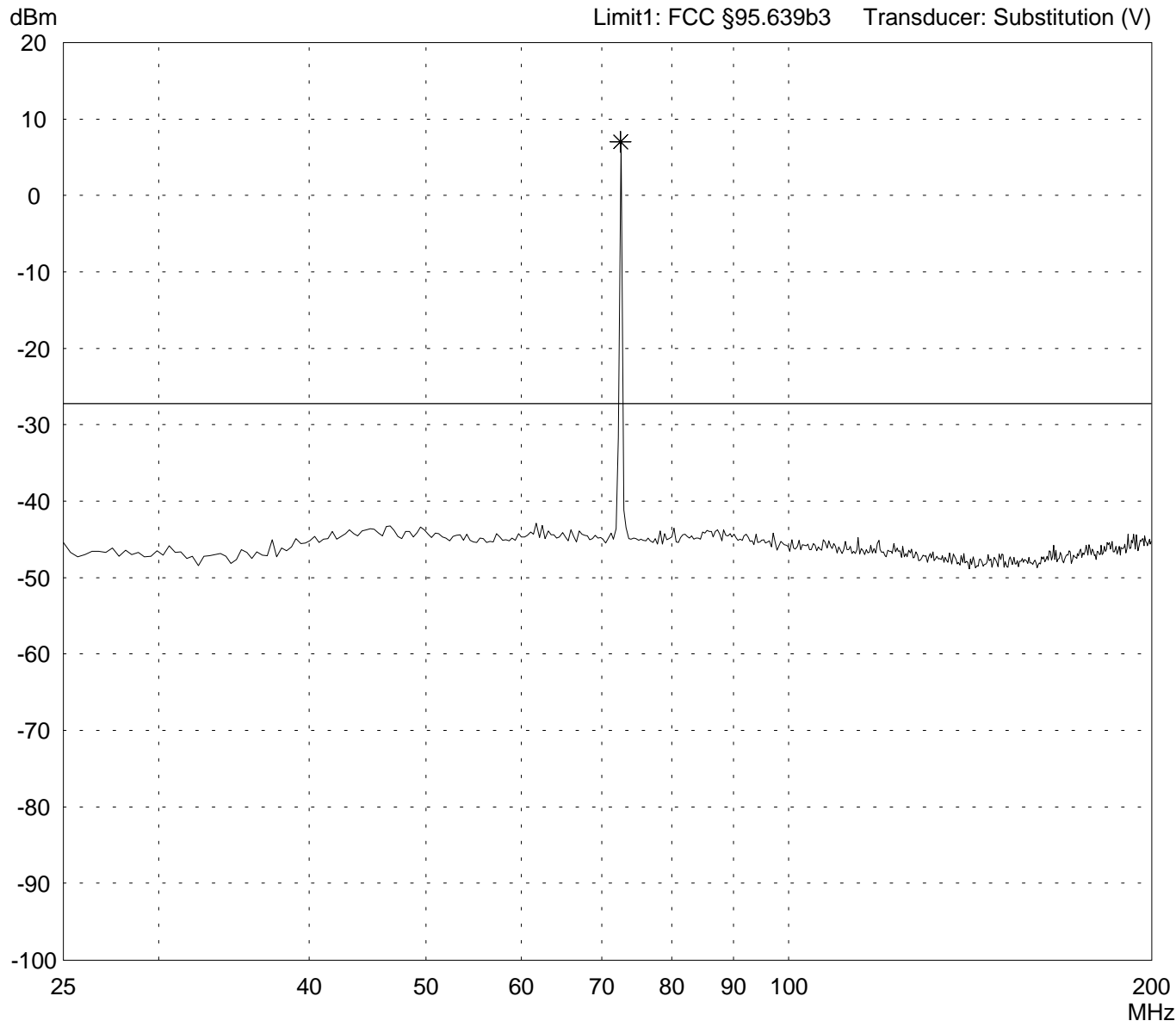

<p>Result: <b>Limit kept</b></p>	<p>Project file: <b>55503-20364</b></p> <p style="text-align: right;">Page 46 of 55 Pages</p>
--------------------------------------	---

**Radiated Power Test 25 MHz - 200 MHz  
acc. to FCC Part 95 Subpart C/E**

<p>Model: <b>T4YBF 72 MHz</b></p> <p>Serial no.: <b>001</b></p> <p>Applicant: <b>Futaba Corporation</b></p> <p>Test site: <b>Fully anechoic room</b></p> <p>Tested on: <b>Test distance 3 meters Vertical Polarization</b></p> <p>Date of test:                      Operator: <b>06/25/2002                      T. Eberl</b></p> <p>Test performed:                  File name: <b>automatically                  default.emi</b></p>	<p>Comment:</p> <p>- TX mode f= 72.550 Mhz</p> <p>- EUT in horizontal position (rear side on table)</p>
---	---

<p>Detector: <b>Peak</b></p>	<p>List of values: <b>Selected by hand</b></p>
----------------------------------	--

Frequency [MHz]	Reading [dBm]	Correction factor [dB]	Value [dBm]	Limit [dBm]	Limit exceeded
72.550000	-17.72	24.74	7.02	-27.25	*

<p>Result: <b>Limit kept</b></p>	<p>Project file: <b>55503-20364</b></p> <p style="text-align: right;">Page 47 of 55 Pages</p>
--------------------------------------	---

# Radiated Power Test 25 MHz - 200 MHz acc. to FCC Part 95 Subpart C/E

<p>Model: <b>T4YBF 72 MHz</b></p> <p>Serial no.: <b>001</b></p> <p>Applicant: <b>Futaba Corporation</b></p> <p>Test site: <b>Fully anechoic room</b></p> <p>Tested on: <b>Test distance 3 meters Vertical Polarization</b></p> <p>Date of test: <b>06/25/2002</b>      Operator: <b>T. Eberl</b></p> <p>Test performed: <b>automatically</b>      File name: <b>default.emi</b></p>	<p>Comment:</p> <ul style="list-style-type: none"> <li>- TX mode f= 72.550 Mhz</li> <li>- EUT in horizontal position (right side on table)</li> </ul>
---	---

<p>Detector: <b>Peak</b></p>	<p>List of values: <b>Selected by hand</b></p>
----------------------------------	--

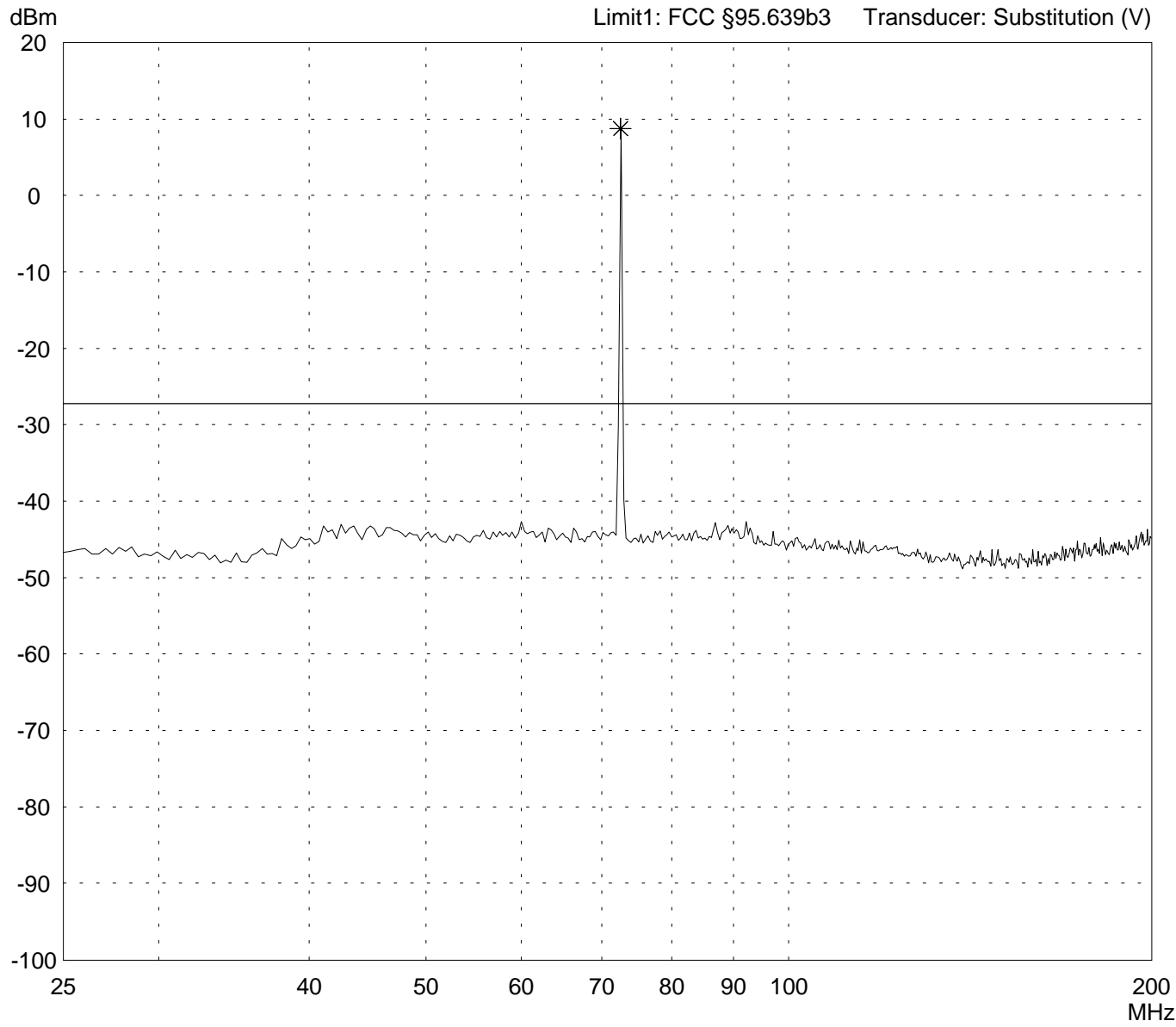

<p>Result: <b>Limit kept</b></p>	<p>Project file: <b>55503-20364</b></p> <p style="text-align: right;">Page 48 of 55 Pages</p>
--------------------------------------	---



**Radiated Power Test 25 MHz - 200 MHz  
acc. to FCC Part 95 Subpart C/E**

Model: T4YBF 72 MHz	Comment:  - TX mode f= 72.550 Mhz  - EUT in horizontal position (right side on table)
Serial no.: 001	
Applicant: Futaba Corporation	
Test site: Fully anechoic room	
Tested on: Test distance 3 meters Vertical Polarization	
Date of test: 06/25/2002      Operator: T. Eberl	
Test performed: automatically      File name: default.emi	

Detector: Peak	List of values: Selected by hand
-------------------	-------------------------------------

<i>Frequency [MHz]</i>	<i>Reading [dBm]</i>	<i>Correction factor [dB]</i>	<i>Value [dBm]</i>	<i>Limit [dBm]</i>	<i>Limit exceeded</i>
72.550000	-16.01	24.74	8.74	-27.25	*

Result: Limit kept	Project file: 55503-20364	Page 49 of 55 Pages
-----------------------	------------------------------	---------------------

Radiated Power Test 200 MHz - 1 GHz  
acc. to FCC Part 95 Subpart C/E

Model:  
T4YBF 72 MHz

Serial no.:  
001

Applicant:  
Futaba Corporation

Test site:  
Fully anechoic room

Tested on:  
Test distance 3 meters  
Vertical Polarization

Date of test: 06/19/2002  
Operator: T. Eberl

Test performed: automatically  
File name: default.emi

Comment:  
- TX mode f= 72.550 MHz  
- EUT in vertical position

Detector:  
Peak

List of values:  
Selected by hand

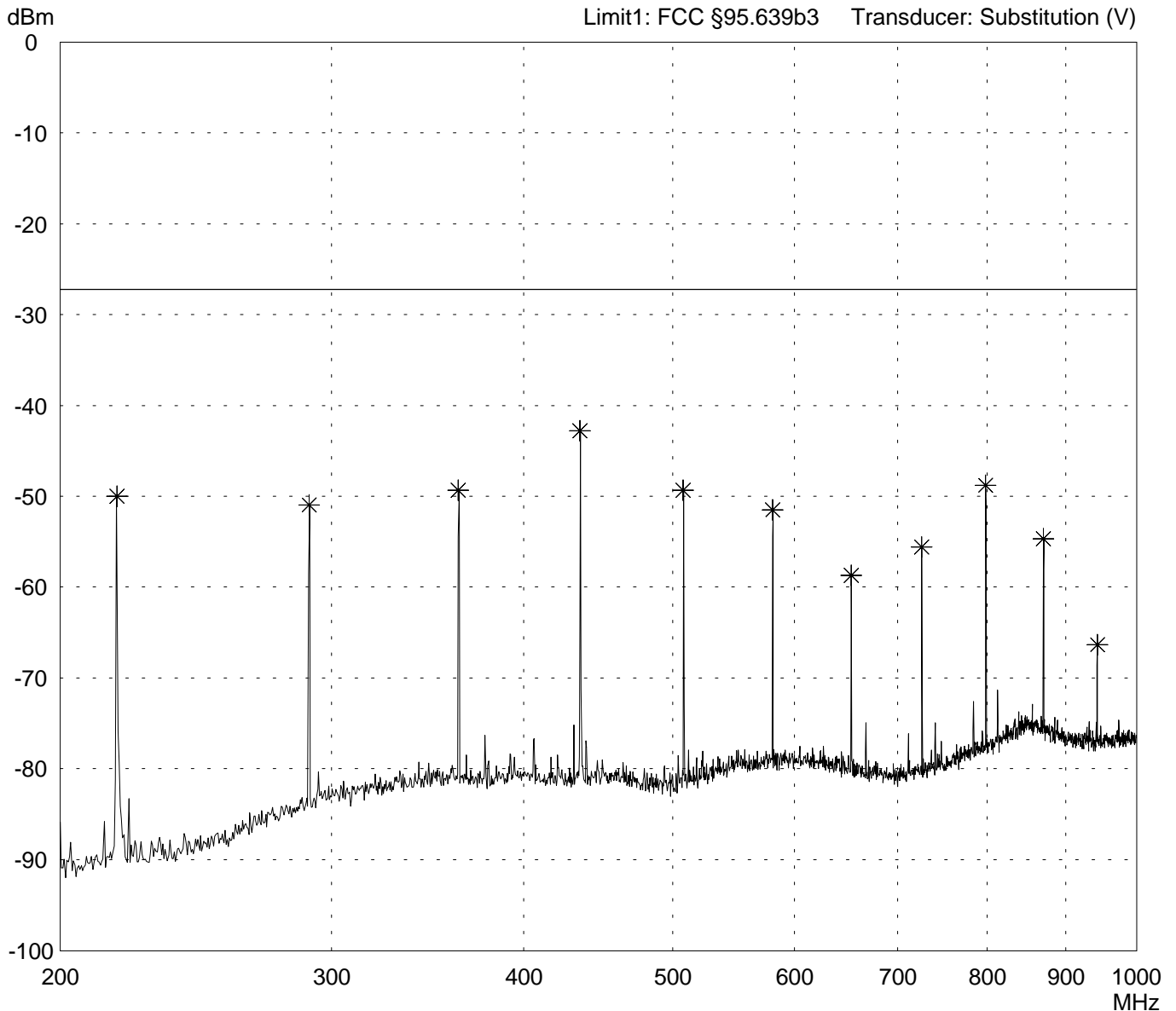

Result:  
Limit kept

Project file:  
55503-20364

Page 50 of 55 Pages

**Radiated Power Test 200 MHz - 1 GHz  
acc. to FCC Part 95 Subpart C/E**

Model: T4YBF 72 MHz	Comment:  - TX mode f= 72.550 MHz  - EUT in vertical position	
Serial no.: 001		
Applicant: Futaba Corporation		
Test site: Fully anechoic room		
Tested on: Test distance 3 meters Vertical Polarization		
Date of test: 06/19/2002		Operator: T. Eberl
Test performed: automatically		File name: default.emi

Detector: Peak	List of values: Selected by hand
-------------------	-------------------------------------

<i>Frequency [MHz]</i>	<i>Reading [dBm]</i>	<i>Correction factor [dB]</i>	<i>Value [dBm]</i>	<i>Limit [dBm]</i>	<i>Limit exceeded</i>
217.650000	-69.87	19.84	-50.02	-27.25	
290.200000	-76.72	25.78	-50.94	-27.25	
362.750000	-77.60	28.24	-49.36	-27.25	
435.300000	-70.88	28.11	-42.77	-27.25	
507.850000	-77.46	28.12	-49.33	-27.25	
580.400000	-82.19	30.67	-51.52	-27.25	
652.950000	-88.68	29.94	-58.74	-27.25	
725.500000	-85.10	29.52	-55.58	-27.25	
798.050000	-81.22	32.41	-48.82	-27.25	
870.600000	-88.86	34.17	-54.69	-27.25	
943.600000	-99.58	33.21	-66.37	-27.25	

Result: Limit kept	Project file: 55503-20364	Page 51 of 55 Pages
-----------------------	------------------------------	---------------------

# Radiated Power Test 200 MHz - 1 GHz acc. to FCC Part 95 Subpart C/E

Model:  
T4YBF 72 MHz

Serial no.:  
001

Applicant:  
Futaba Corporation

Test site:  
Fully anechoic room

Tested on:  
Test distance 3 meters  
Vertical Polarization

Date of test: 06/19/2002  
Operator: T. Eberl

Test performed: automatically  
File name: default.emi

Comment:

- TX mode f= 72.550 MHz
- EUT in horizontal position (rear side on table)

Detector:  
Peak

List of values:  
Selected by hand

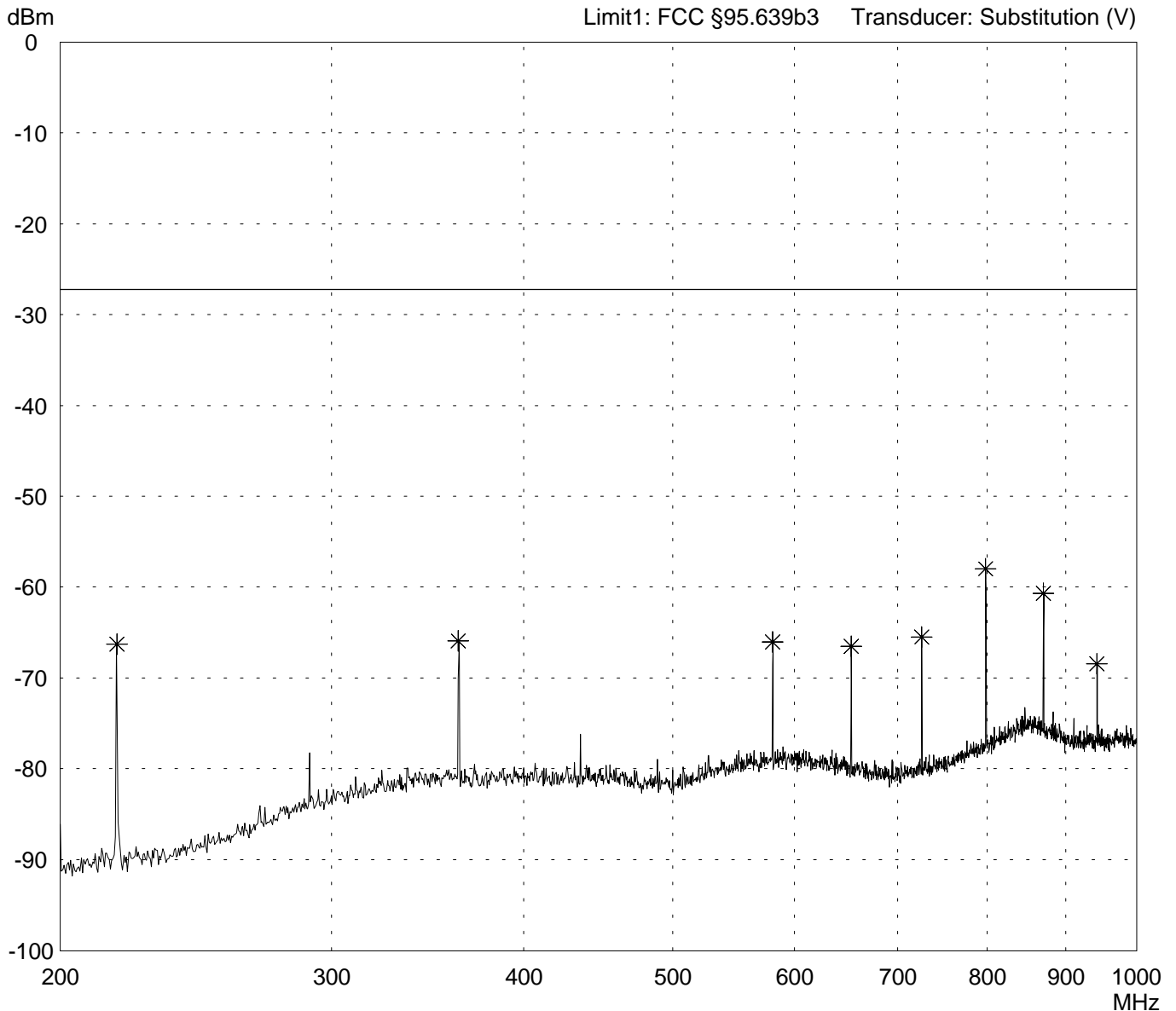

Result:  
Limit kept

Project file:  
55503-20364

Page 52 of 55 Pages

**Radiated Power Test 200 MHz - 1 GHz  
acc. to FCC Part 95 Subpart C/E**

Model: T4YBF 72 MHz	Comment:  - TX mode f= 72.550 MHz  - EUT in horizontal position (rear side on table)
Serial no.: 001	
Applicant: Futaba Corporation	
Test site: Fully anechoic room	
Tested on: Test distance 3 meters Vertical Polarization	
Date of test: 06/19/2002      Operator: T. Eberl	
Test performed: automatically      File name: default.emi	

Detector: Peak	List of values: Selected by hand
-------------------	-------------------------------------

<i>Frequency [MHz]</i>	<i>Reading [dBm]</i>	<i>Correction factor [dB]</i>	<i>Value [dBm]</i>	<i>Limit [dBm]</i>	<i>Limit exceeded</i>
217.650000	-86.14	19.84	-66.30	-27.25	
362.750000	-94.16	28.24	-65.92	-27.25	
580.400000	-96.71	30.67	-66.04	-27.25	
652.950000	-96.46	29.94	-66.52	-27.25	
725.500000	-95.05	29.52	-65.53	-27.25	
798.050000	-90.42	32.41	-58.02	-27.25	
870.060000	-94.91	34.19	-60.72	-27.25	
943.150000	-101.63	33.21	-68.42	-27.25	

Result: Limit kept	Project file: 55503-20364	Page 53 of 55 Pages
-----------------------	------------------------------	---------------------

# Radiated Power Test 200 MHz - 1 GHz acc. to FCC Part 95 Subpart C/E

Model:  
T4YBF 72 MHz

Serial no.:  
001

Applicant:  
Futaba Corporation

Test site:  
Fully anechoic room

Tested on:  
Test distance 3 meters  
Vertical Polarization

Date of test: 06/19/2002  
Operator: T. Eberl

Test performed: automatically  
File name: default.emi

Comment:

- TX mode f= 72.550 MHz
- EUT in horizontal position (right side on table)

Detector:  
Peak

List of values:  
Selected by hand

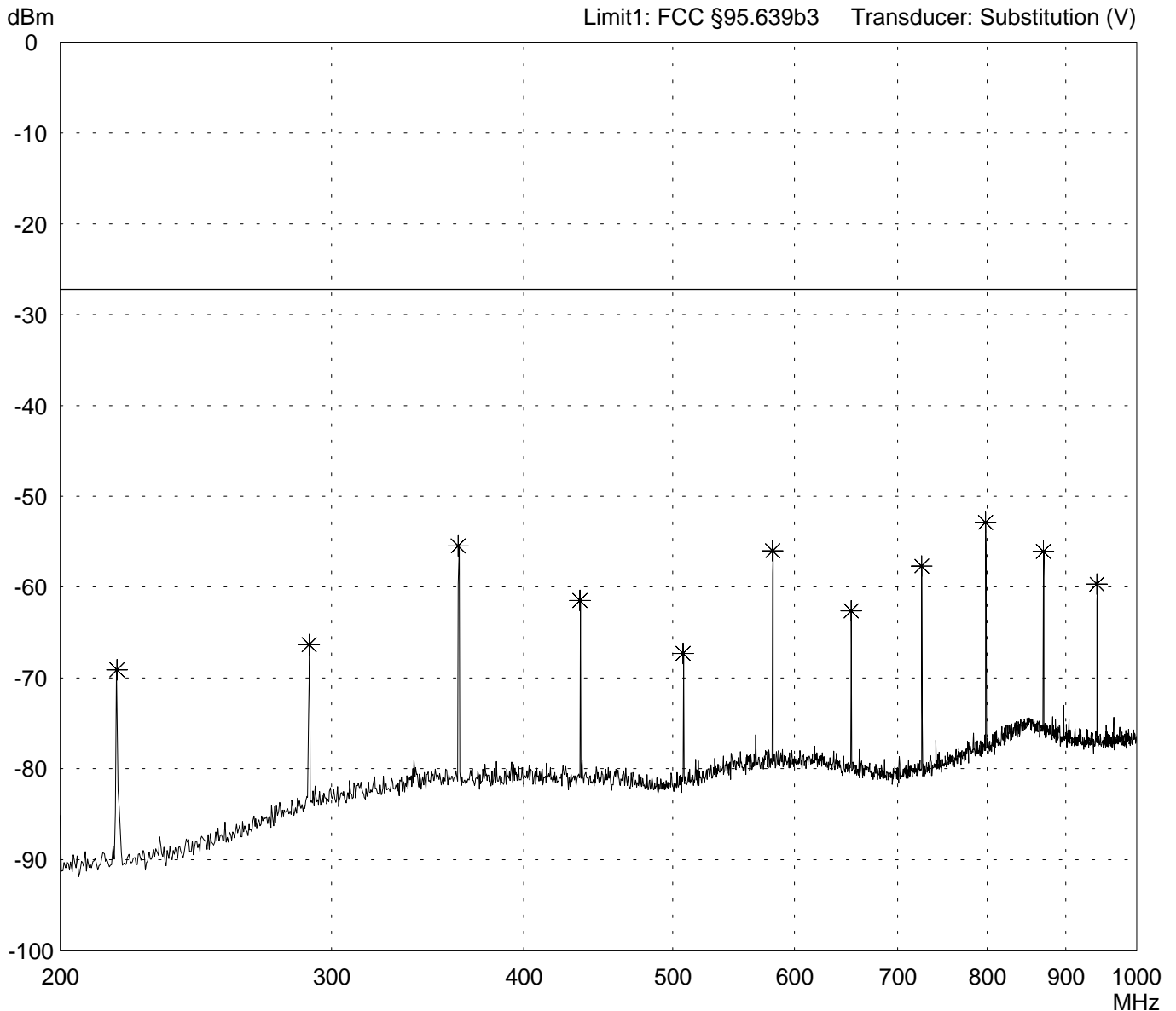

Result:  
Limit kept

Project file:  
55503-20364

Page 54 of 55 Pages

**Radiated Power Test 200 MHz - 1 GHz  
acc. to FCC Part 95 Subpart C/E**

<p>Model: <b>T4YBF 72 MHz</b></p> <p>Serial no.: <b>001</b></p> <p>Applicant: <b>Futaba Corporation</b></p> <p>Test site: <b>Fully anechoic room</b></p> <p>Tested on: <b>Test distance 3 meters Vertical Polarization</b></p> <p>Date of test:                      Operator: <b>06/19/2002                      T. Eberl</b></p> <p>Test performed:                  File name: <b>automatically                  default.emi</b></p>	<p>Comment:</p> <p>- TX mode f= 72.550 MHz</p> <p>- EUT in horizontal position (right side on table)</p>
---	--

<p>Detector: <b>Peak</b></p>	<p>List of values: <b>Selected by hand</b></p>
----------------------------------	--

<i>Frequency [MHz]</i>	<i>Reading [dBm]</i>	<i>Correction factor [dB]</i>	<i>Value [dBm]</i>	<i>Limit [dBm]</i>	<i>Limit exceeded</i>
217.650000	-88.97	19.84	-69.13	-27.25	
290.200000	-92.11	25.78	-66.33	-27.25	
362.750000	-83.69	28.24	-55.45	-27.25	
435.300000	-89.60	28.11	-61.49	-27.25	
507.850000	-95.44	28.12	-67.32	-27.25	
580.400000	-86.67	30.67	-56.00	-27.25	
652.950000	-92.58	29.94	-62.64	-27.25	
725.500000	-87.21	29.52	-57.69	-27.25	
798.050000	-85.29	32.41	-52.89	-27.25	
870.600000	-90.26	34.17	-56.09	-27.25	
943.150000	-92.86	33.21	-59.65	-27.25	

<p>Result: <b>Limit kept</b></p>	<p>Project file: <b>55503-20364</b></p> <p style="text-align: right;">Page 55 of 55 Pages</p>
--------------------------------------	---