

Model Select

Forty model data (model data for 40 R/C cars) can be saved in the T4PX transmitter and used when the relevant model data is called.

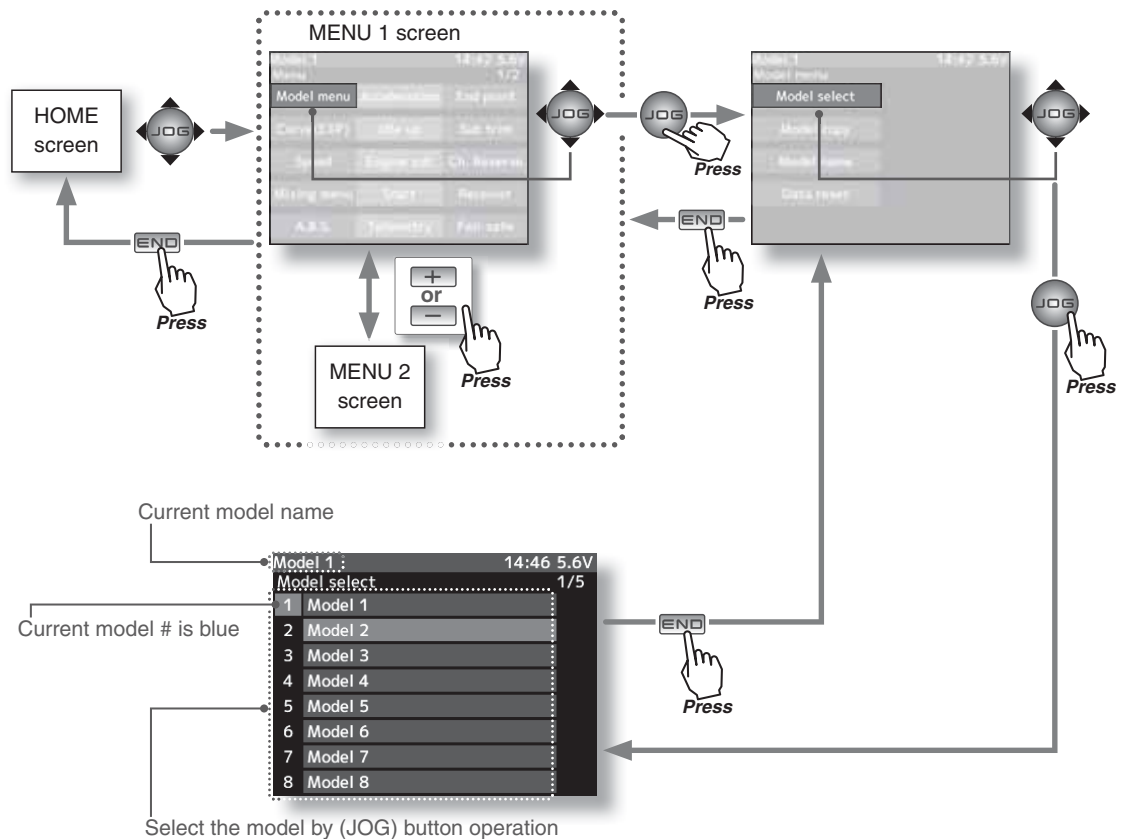

Using the model selection function

1 (Model No. selection)

Select the model by (JOG) button up or down operation.

When the (JOG) button up operation is performed from the cursor position on the top row or the (JOG) button down operation is performed from the cursor position on the bottom row, the page changes.

Model #.

M1~M40

Model selection button

- Select the model by (JOG) button up or down operation.

2 (Model selection execution)

When the model was selected, press the (JOG) button. The confirmation message "Are you sure?" appears. To execute selection, select "Yes" and press the (JOG) button and to cancel selection, select "No" and press the (JOG) button.



Model selection set button

- The (JOG) button are pressed.

3 When ending setting, return to the menu screen by pressing the (END) button.

Model Name

This function allows you to assign a ten character name to each model memory.

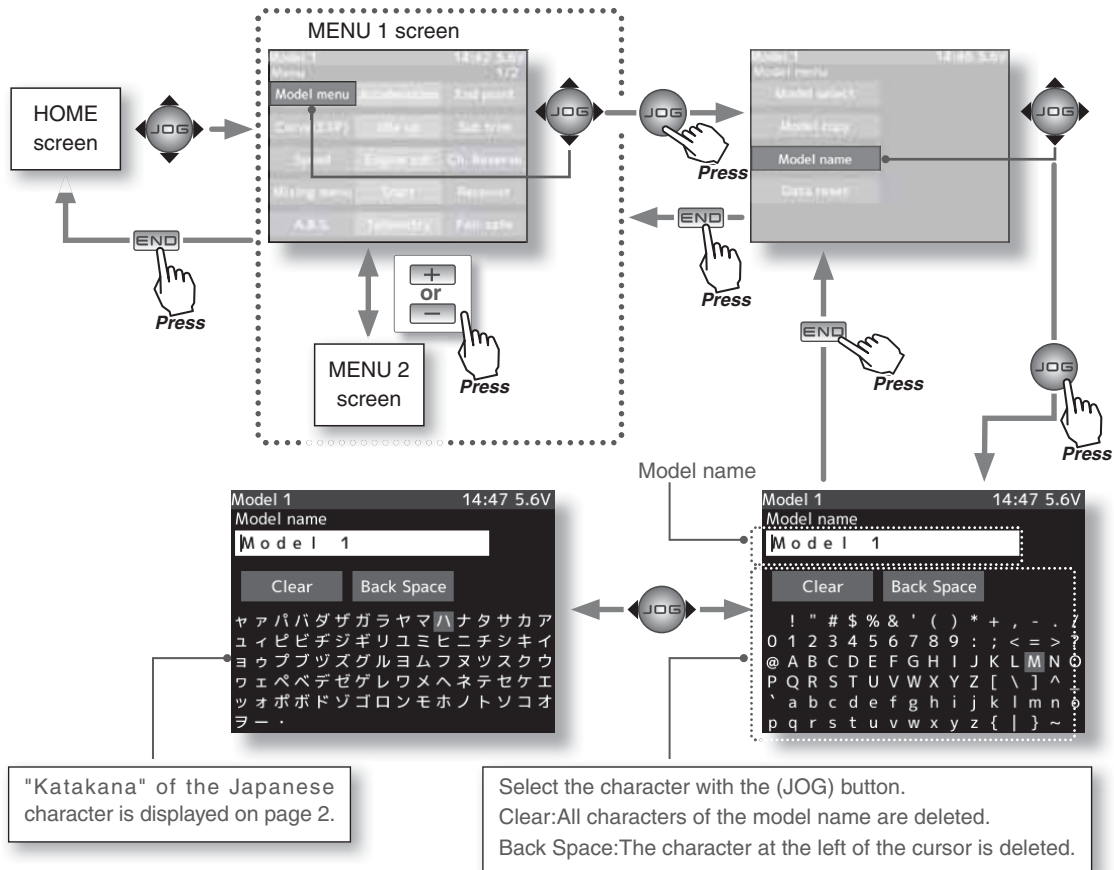

Setting the model name and user name

- 1** (Moving the cursor to the character you want to change.)
Move the cursor to the model name character you want to set or change by pressing the (+) or (-) button. The selected character blinks.
- 2** (Selecting the character to be used)
Move the cursor by (JOG) button up, down, left, or right operation, and select the characters to be used from the character list at the bottom of the screen. After deciding the characters to be used, press the (JOG) button. The characters are selected and the model name character string moves to the right. When "Back space" on the center row is selected and the (JOG) button is pressed, the character at the left of the vertical cursor is deleted. When "Clear" is selected and the (JOG) button is pressed, all the characters are deleted.
- 3** When ending setting, return to the menu screen by pressing the (END) button.

Character select/set button

- Select the character by (JOG) button up, down, left, or right operation and enter the character by pressing the (JOG) button.

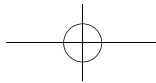

Model Copy

The contents of the model memory can be copied to another model memory. The contents can also be saved or stored in a microSD card for copying to another T4PX.

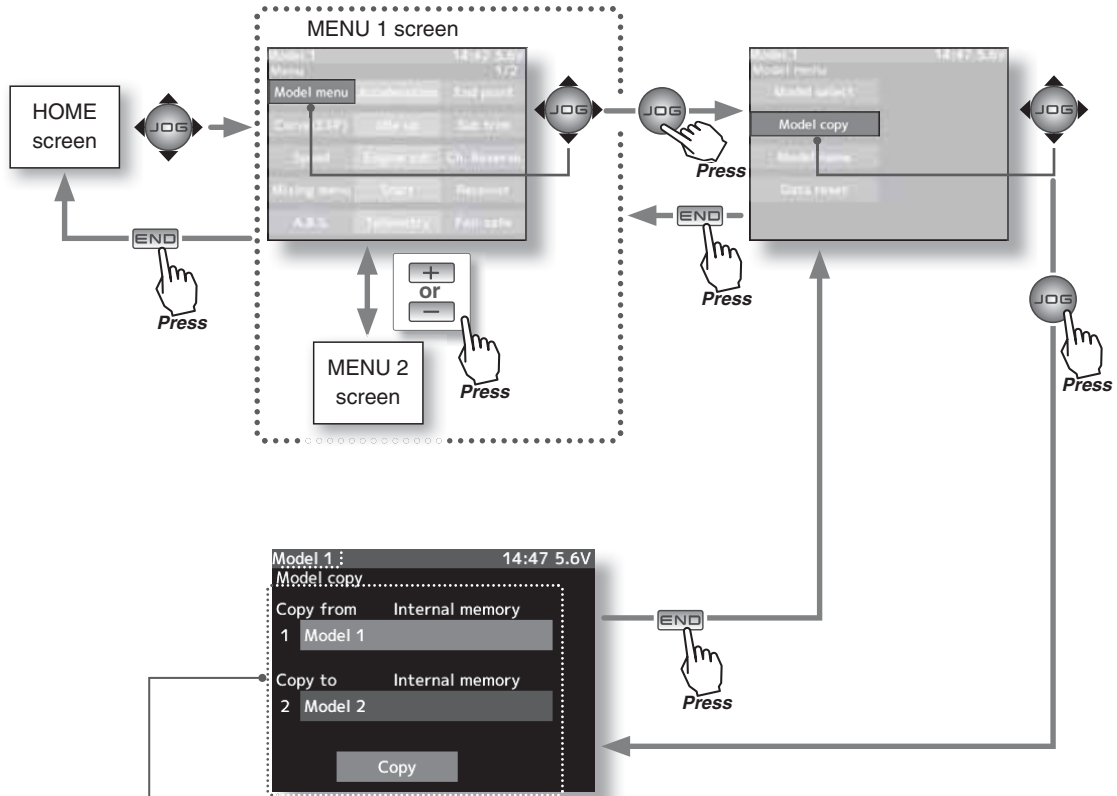

Selects the copy source model and copy destination model data.

Model copying

Function

1 (Copy source model selection)

Select the setting item "Copy source" by (JOG) button up or down operation. Press the (JOG) button. A list of the models stored in the T4PX transmitter is displayed. Select the model by (JOG) button up or down operation, and press the (JOG) button.

When a microSD card is installed in the T4PX, a screen for selecting T4PX model memory (Internal memory) or microSD card is displayed.

After selecting either T4PX model memory or microSD card by (JOG) button, select the model.

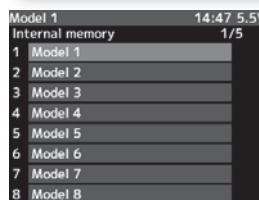
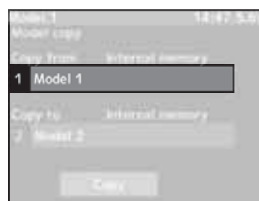

Setup item selection

- Select by (JOG) button up or down operation.

Model number selection

- The (JOG) button are pressed

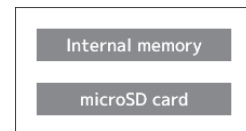

T4PX transmitter or microSD card selection

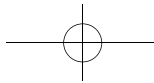

2 (Copy destination model selection)

Select the setting item "Copy Source" by (JOG) button up or down operation, and press the (JOG) button. A list of the model numbers saved in the T4PX transmitter is displayed. Select the model by (JOG) button up or down operation, and press the (JOG) button. When a microSD card is installed in the T4PX transmitter, a screen for selecting the models in the T4PX transmitter (Internal memory) or the models in the microSD card is displayed.



Setup item selection

- Select by (JOG) button up or down operation.

Model number selection

- The (JOG) button are pressed

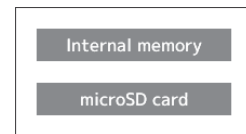
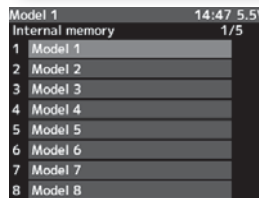

T4PX transmitter or microSD card selection

After selecting the screen by (JOG) button, select the model.

-The model currently in use cannot be selected.

-Since the copy destination cannot be overwritten when it is in a microSD card, a models list is not displayed and the model is saved directly to the microSD card.

3 (Copy execution)

After checking that the copy source and copy destination models are correct, select the setting item "Copy execution" by (JOG) button up or down operation, and press the (JOG) button. The confirmation message "Are you sure" appears. To execute copy, select "Yes" and to cancel copy, select "No" by (JOG) button.

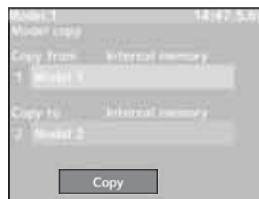

When the copy destination model name becomes the same name as the copy source, copying is complete.

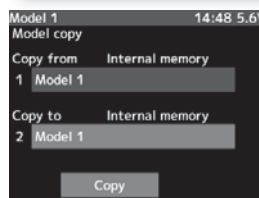

4 When ending setting, return to the menu screen by pressing the (END) button.

microSD card storage destination

When a microSD card is installed in the T4PX, a folder called "Futaba" is created, and folders called "LOG" and "MODEL" are created in it. The "MODEL" folder contains the model data.

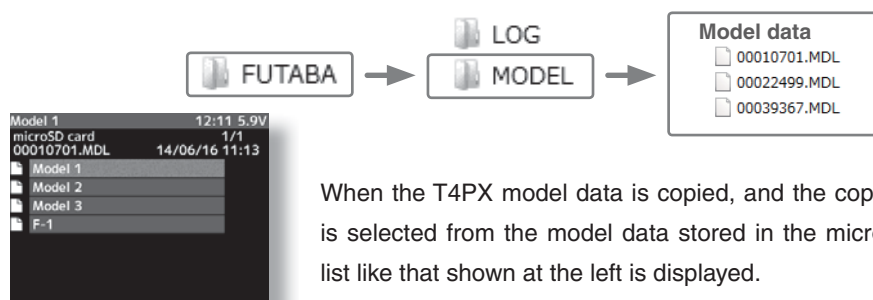

When the T4PX model data is copied, and the copy source data is selected from the model data stored in the microSD, a model list like that shown at the left is displayed.

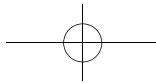

Data Reset

This function resets the contents of the currently called model memory.

The reset method can be selected from among the 3 types described below. These resets do not initialize the adjuster function, system function, user name, and receiver type, servo type selection function.

Model data

Initializes only the function setting data. The direct menu function is not initialized.

Direct menu

Initializes the direct menu function. Other settings are not initialized.

All data

Initializes the menu function, direct selection function, and the setting data of each function.

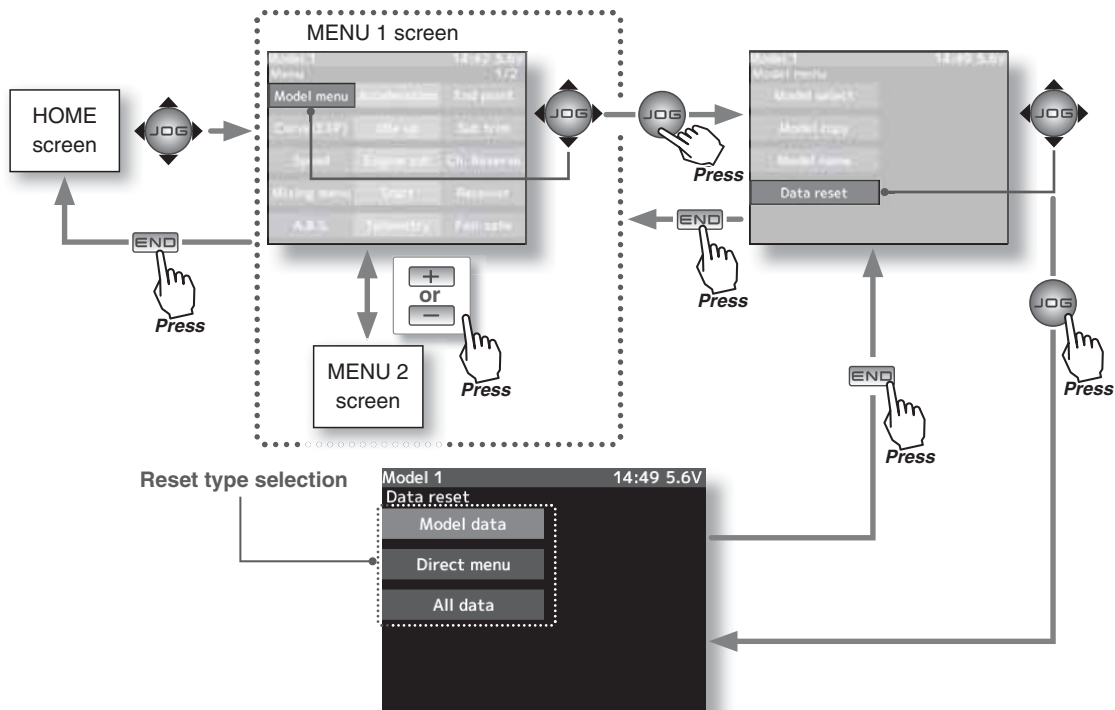

Function

Data Reset

Select the reset type by (JOG) button up or down operation and press the (JOG) button.

1 (Reset execution)

Press the (JOG) button. The "Are you sure?" confirmation message appears. To execute, select "Yes" and to cancel select "No" and press the (JOG) button.

This completes resetting.

Setup item selection

- Select by (JOG) button up or down operation.

Reset execution button

- (JOG) buttons pressed.

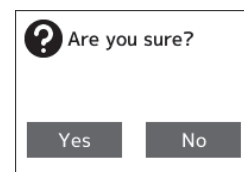

2 When ending setting, return to the menu screen by pressing the (END) button.

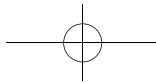

MC Link Function (ESC Link)

This is a special function which allows Futaba motor controller (MC) data changes to be set by the T4X transmitter (MC960CR, MC950CR, MC851C, MC602C, MC402CR, etc.).

However, some data changes require a PC and Link software.

This function is used by connecting ESC directly to the transmitter.

Use the various optional servo extension cords according to the distance between the transmitter and ESC.

-Also connect the battery at the ESC side.

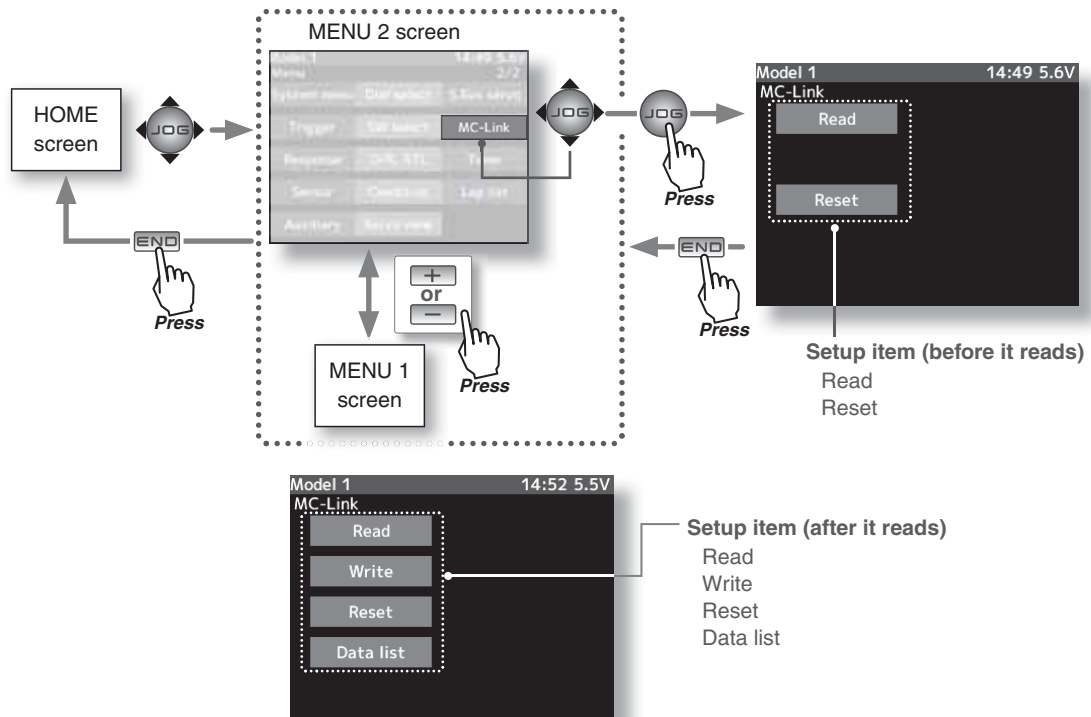
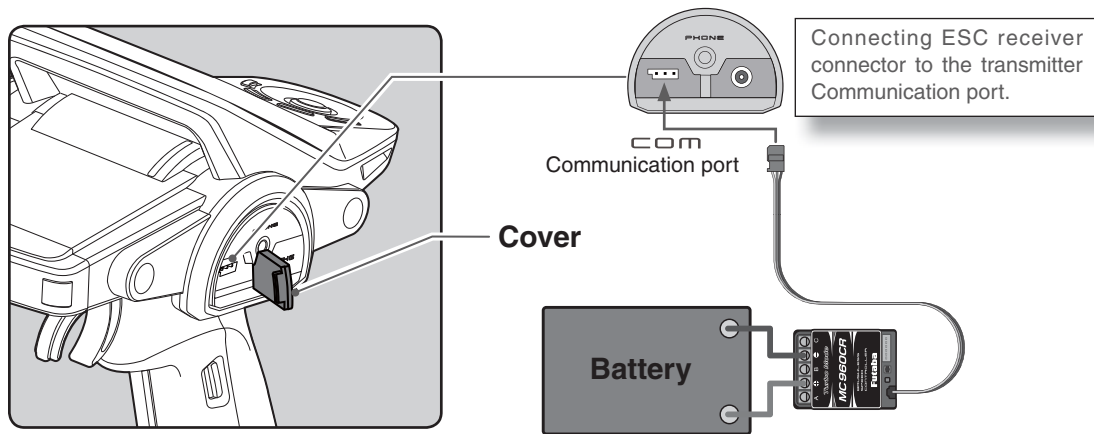

MC Link Function (ESC Link)

117

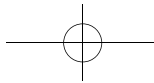

Using the ESC Link function

(Preparation)

- Connect the T4PX and ESC in accordance with the connection diagram shown on page 117.
- Connect the battery to ESC.

1 Turn power on the transmitter. "MC link" menu is displayed referring to the map of page117. Set the FET amp power switch to the ON position.

Setup item selection

- Select by (JOG) button up or down operation.

Reset execution button

- (JOG) buttons pressed.

2 (ESC read)

Execute this function to read the connected ESC type and the data currently set at the ESC.

- Select the setting item "Read" by (JOG) button up or down operation, and press the (JOG) button.

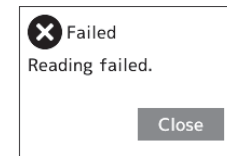
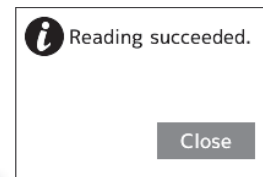
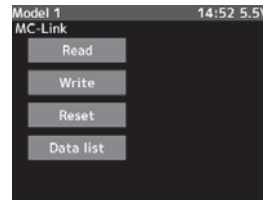

- "Reading succeeded" is displayed on the screen and the ESC type and currently set contents are read.
- If "Failed" is displayed on the screen, communication with the ESC is not being performed normally. Check the T4PX and ESC connection and the battery connection to ESC and the ESC power switch and repeat "Read".

3 (Writing to ESC)

Execute this function to write the setting data to ESC. See pages 120~125 for the setting data contents.

- Select the setting item "Write" by (JOG) button up or down operation, and press the (JOG) button.

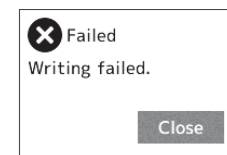
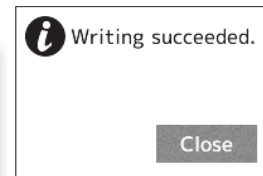

- "Writing succeeded" is displayed on the screen and the setting data is written to ESC.
- If "Failed" is displayed on the screen, communication with the ESC is not being performed normally. Check the T4PX and ESC connection and the battery connection to ESC and the ESC power switch and repeat "Write".
- Different type ESC data cannot be written. If writing is attempted, "Failed" is displayed on the screen.

4 (Initialization)

Write the factory set ESC setting data to the connected ESC and T4PX.

- Select the setting item "Reset" by (JOG) button up or down operation, and press the (JOG) button.

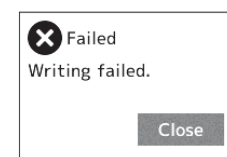
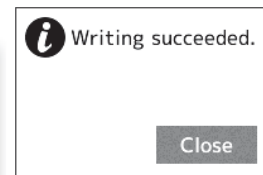

- "Writing succeeded" is displayed on the screen and the setting data is written to ESC.
- If "Failed" is displayed on the screen, communication with the ESC is not being performed normally. Check the T4PX and ESC connection and the battery connection to ESC and the ESC power switch and repeat "Write".

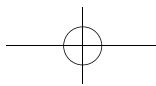

Data list

(Preparation)

-ESC is read referring to the explanation of page 118.

- 1 Select the setting item "Data list" by (JOG) button up or down operation, and press the (JOG) button.



Setup item selection

- Select by (JOG) button up or down operation.

Reset execution button

- (JOG) buttons pressed.

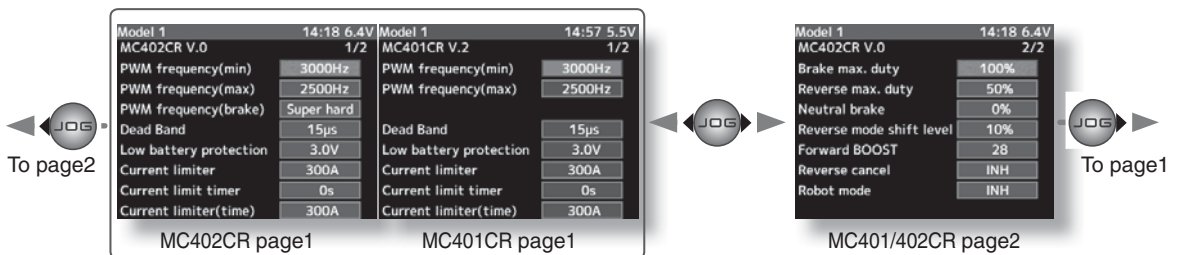
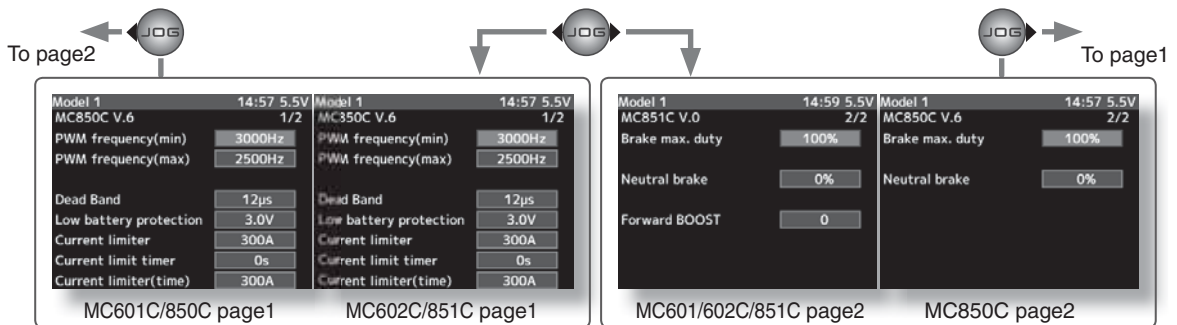
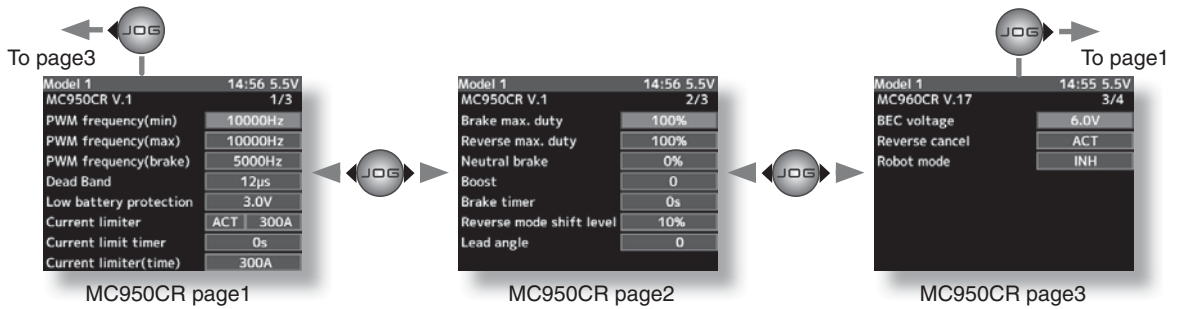
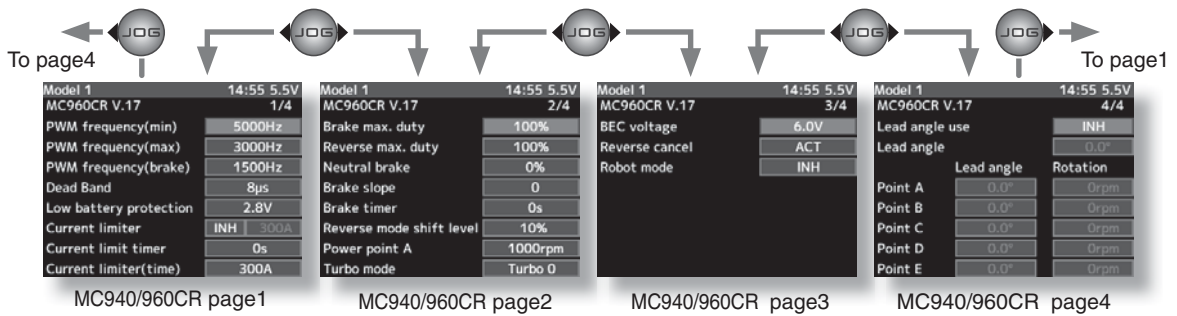

Function

MC Link Function (ESC Link)

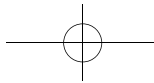

System function setup

- Select the setting item by (JOG) button up, down, left, or right operation.
Set the value by (+) and (-) button.

PWM frequency (min)

MC401,402CR/601,602C/850,851C :0.1kHz(100Hz) 10kHz (10000Hz)

MC950CR :0.5kHz(500Hz) 30kHz(30000Hz)

MC940,960CR :1kHz(1000Hz) 30kHz(30000Hz)

Same as Link software PWM frequency (at Min. load),
Min sets the "0"A PWM frequency at minimum load.

PWM frequency (max)

MC401,402CR/601,602C/850,851C:0.1kHz(100Hz) 10kHz (10000Hz)

MC950CR :0.5kHz(500Hz) 30kHz(30000Hz)

MC940,960CR :1kHz(1000Hz) 30kHz(30000Hz)

Same as Link software PWM frequency (at Max. load).
MAX sets the PWM frequency at maximum load at the out-
put current limit value set by Current Limiter.

Model 1	14:55 5.5V
MC960CR V.17	1/4
PWM frequency(min)	5000Hz
PWM frequency(max)	3000Hz
PWM frequency(brake)	1500Hz
Dead Band	8µs
Low battery protection	2.8V
Current limiter	INH 300A
Current limit timer	0s
Current limiter(time)	300A

PWM frequency (brake)

MC402CR/602C/851C (MC401,601,850 cannot be adjusted 2kHz fixation)

:Normal(2000Hz) /Hard(1000Hz) /Super hard(500Hz)

MC950CR :0.5kHz(500Hz)30kHz(30000Hz)

MC940,960CR :1kHz(1000Hz)30kHz(30000Hz)

Same as Link software Brake PWM at frequency.
This setting can set the brake PWM frequency.

"min" which sets the frequency when the load is small, is set to the high frequency side (large value) when extension is desired after straightaways and curves.

"max" which sets the frequency when the load is large, is set to the high frequency side (large value) when you want to suppress the rise from low speed and when motor heating and commutator roughness are sensed.

When the rise from low speed is poor, and becomes bad even when "max" is set to the low frequency side, use the log data to check if there was a momentary voltage drop. When you want to suppress the overall power, lengthen the run time, and otherwise improve efficiency, set both "max" and "min" to the high frequency side. When you want to set a fixed PWM frequency at full range regardless of the load current, set PWM frequency (at Max. load) and PWM frequency (at Min. load) to the same value.

Dead Band

All type :±2µs~±50µs

Same as Link software Dead Band.
This sets the range (neutral point range) over which the ESC does not respond to transmitter throttle operation.
The larger the set value, the wider this range.

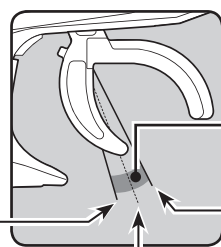

Position at which motor starts to run

Point at which brakes start taking effect

Throttle neutral position

Model 1	14:55 5.5V
MC960CR V.17	1/4
PWM frequency(min)	5000Hz
PWM frequency(max)	3000Hz
PWM frequency(brake)	1500Hz
Dead Band	8µs
Low battery protection	2.8V
Current limiter	INH 300A
Current limit timer	0s
Current limiter(time)	300A

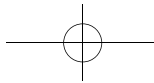

Low Bat Protection

MC401,402CR/601,602C/850,851C:2.5V 6.0V

MC950CR/MC940,960CR 2.5V 7.5V

Same as Link software Low Bat Protection.

When the power supply voltage drops, the output current to the motor is limited and supply voltage to the receiver is ensured. When the power supply voltage drops to the set voltage, a protection circuit operation alarm is activated and output to the motor is cut. The protection circuit is automatically reset by recovery of the power supply voltage.

Current Limiter

MC401,402CR/601,602C/850:50A 300A, INH

MC851C :50A~300A(can not INH)

MC950CR/MC940,960CR:50A~500A, INH

Same as Link software PWM frequency (at Max. load).

MAX sets the PWM frequency at maximum load at the output current limit value set by Current Limiter.

Model 1	14:55 5.5V
MC960CR V.17	1/4
PWM frequency(min)	5000Hz
PWM frequency(max)	3000Hz
PWM frequency(brake)	1500Hz
Dead Band	8µs
Low battery protection	2.8V
Current limiter	INH 300A
Current limit timer	0s
Current limiter(time)	300A

Current limiter INH/ACT setting

With the MC950CR and MC940/960CR move the cursor to current limiter "INH(Off)/ACT(On)" and select INH or ACT with the (+) or (-) button.

With other MC, when the (+) button is pressed from the current limiter maximum value, INH(Off) is set.

The MC851C does not have an INH(Off) setting.

Current Limit timer

MC401,402CR/601,602C/850,851C:0sec(OFF)240sec

MC940,960CR:0sec(OFF)~240sec (MC950CR can not)

Same as Link software Current Limit timer.

The output current can be limited up to the set time lapse from the start of running. This is effective in preventing the motor from outputting wasted energy when the voltage is high immediately after the power battery was recharged.

"Current Limiter (time)" sets the time the output current is limited. This function is disabled when set to "0" sec.

Since the Current Limit Timer starts when the throttle is operated to the forward side and current is output to the motor, this function begins to operate when the motor is run during trim adjustment, etc.

Current Limiter (time)

MC401,402CR/601,602C/850,851C :50A~300A

MC940,960CR :50A~500A (MC950CR can not)

"Current Limit timer " (Time Limit) sets the maximum output current within the time the output current is limited.

Model 1	14:55 5.5V
MC960CR V.17	1/4
PWM frequency(min)	5000Hz
PWM frequency(max)	3000Hz
PWM frequency(brake)	1500Hz
Dead Band	8µs
Low battery protection	2.8V
Current limiter	INH 300A
Current limit timer	0s
Current limiter(time)	300A

Model 1	14:18 6.4V
MC402CR V.0	1/2
PWM frequency(min)	3000Hz
PWM frequency(max)	2500Hz
PWM frequency(brake)	Super hard
Dead Band	15µs
Low battery protection	3.0V
Current limiter	300A
Current limit timer	0s
Current limiter(time)	300A

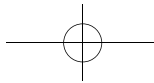

Brake max. duty

All type :0%~100%

Same as Link software Brake Max. Duty.

This setting can set the braking force between the neutral point and Max brake point.

The larger this value, the greater the braking force. When set to "0%", the brakes are not effective.

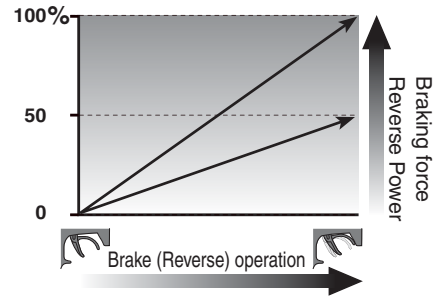

Reverse max. duty

MC401,402CR/MC950CR/MC940,960CR :0%~100%

Same as Link software Reverse Max. Duty.

This setting can set the reverse power between the neutral point and Max reverse point.

The larger this value, the greater the reverse power. When set to "0%", the reverses are not effective.

Neutral brake

All type :0%~100%

Same as Link software Current Limit timer.

Make this setting when you want to use the brakes at the neutral throttle (OFF) position by throttle operation. The larger this value, the greater the braking force. When you want to use the neutral brake, set this value to "0%".

MC401,402CR/MC950CR/MC940,960CR

MC601,602C/MC850,851C

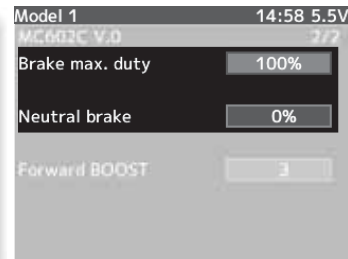
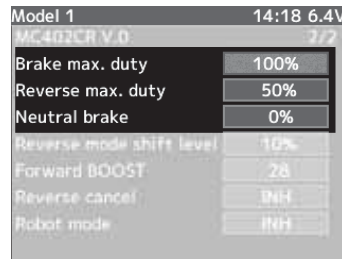

Reverse mode shift level

MC401,402CR/MC950CR/MC940,960CR :0%~100%

Same as Link software Reverse Mode Shift Leve.

The reverse operation can be done with the throttle trigger to be thrown from brake status to the neutral. The value can set the amount of the brake in order to switch to the reverse operation.

MC401,402CR

MC950CR/MC940,960CR

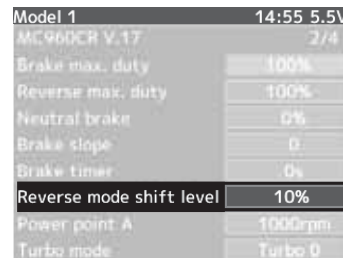
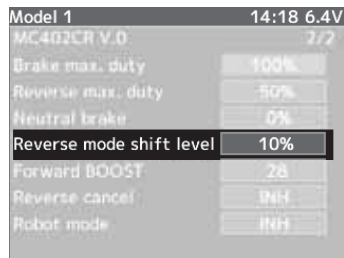

Forward BOOST

MC401,402CR/MC601,602C/MC851C :0%~100%

Same as Link software Forward Boost (Boost).

Operation near the throttle trigger neutral position becomes a sharp rise.

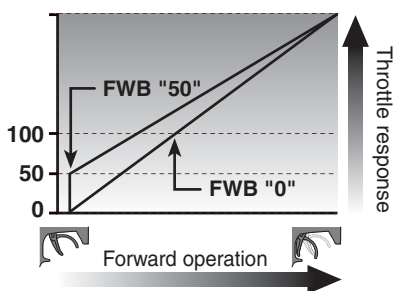

MC401,402CR

MC601,602,851C

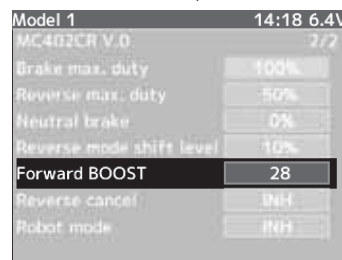

Function

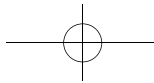

Reverse cancel

MC401,402CR/MC950CR/MC940,960CR :ACT/INH

Same as Link software Reverse Cancel.
When set to "ACT", reverse operation is not performed.

Robot mode

MC401,402CR/MC950CR/MC940,960CR :ACT/INH

Same as Link software Robot Model.
When set to "ACT", breke operation is not performed, there is only forward and reverse operation.

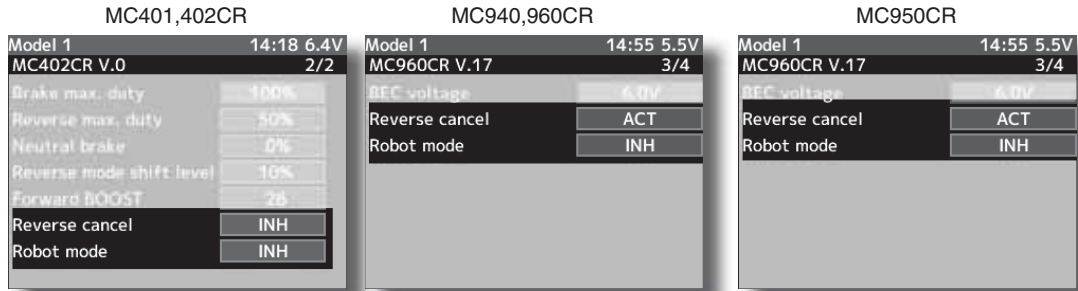

Brake slope

MC940,960CR/ :0~300

Same as Link software Brake Slope.
This function adjusts the braking effect when the throttle was returned (throttle off). It cancels operation like that called engine brake of actual vehicles.

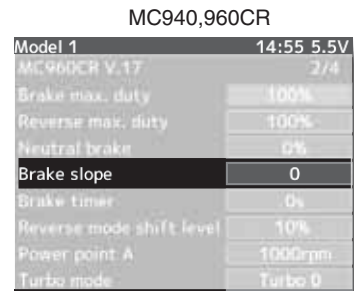

Brake timer

MC940,960CR/MC950CR :0sec~300sec

Same as Link software Brake Timer.
When the reverse function is used, ordinarily if the trigger is not moved to the brake (reverse) side and then returned from the brake operation position to the neutral position, reverse operation will not be performed. However, when used by intentionally moving the neutral point to the forward side, if brake operation is repeated, reverse operation may be performed even if the trigger is not returned to the neutral position. The time required to switch to reverse operation can be set to prevent this from occurring.

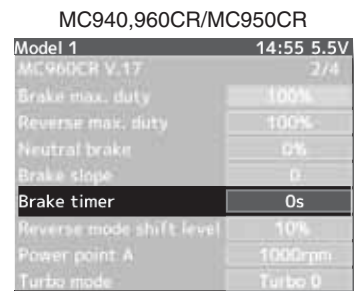

Function

Lead angle

MC950CR/ :0~1500

Same as Link software Lead Angle.
The lead angle of the motor can be set at the MC950CR side. However, we recommend that it normally be set to "0". Since this setting is premised on setting by referring to the speed log by the Link software.



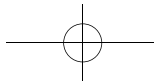

BEC voltage

MC940,960CR/ :6.0V/7.4V

Same as Link software BEC Volt.

The receiver BEC voltage can be selected from 6.0V and 7.4V. Match the voltage to the rating of the servo connected to the same receiver. This BEC voltage cannot output a voltage higher than the input voltage.

For instance, if a 6.0V receiver and servo are used with a power supply voltage of 7.4V or more, set the BEC voltage to 6.0V and when a high voltage receiver and servo are used, set the BEC voltage to 7.4V.

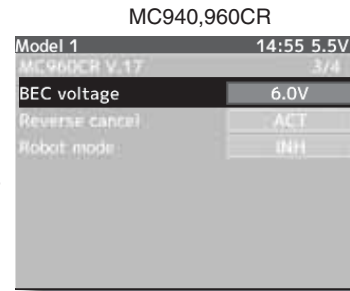

Turbo mode

MC940,960CR/ :Turbo0/Turbo1/Turbo2

Same as Link software Turbo Mode.

This function sets the turbo mode. More power can be displayed by using the turbo mode. Depending on the setting, the motor and ESC may be damaged so make this setting carefully.

(Note) When "Lead angle use" is INH, lead angle setting will not operate even if set to "Turbo1" or "Turbo2." (Turbo mode disabled, Turbo0=Off)

-Turbo0 mode: (No Lead Angle mode) Lead angle - No

When used in races in which the lead angle setting function is inhibited by ESC, set to this mode. The lead angle function is disabled the same as if "Lead angle use" was turned off.

When the lead angle function was disabled by the method described above, the MC940,960CR shows that the lead angle function is off by blinking a blue LED at an ON 0.1 second, OFF 0.9 second cycle at the neutral point.



-Turbo1 turbo mode: (Lead Angle mode) Lead angle – Yes

The output can be increased by setting a lead angle.

Depending on the set value, the motor may be damaged so increase the lead angle value in steps from a small value while observing the conditions.

Turn on "Lead angle use" and adjust the lead angle by "Lead angle" and point A, B, C, D, E (A, B, C, D, E Lead angle) value.

-Turbo2 power mode: (Power Mode) Lead angle – Yes

Displays still more power than a turbo.

However, since even a motor applies a large load on the ESC, make the lead angle larger in steps from a small value while observing the conditions.

Turn on "Lead angle use" and adjust the lead angle by "Lead angle" and point A, B, C, D, E (A, B, C, D, E Lead angle) value.

Power point A

MC940,960CR/ :0rpm~100000rpm

Same as Link software Power Point A.

When the turbo mode is power 2 (Power mode) and the lead angle is large, movement may become stiff when entering the course, etc. In this case, make operation smooth by lowering the set speed at power point A.

This function is not performed in modes other than Turbo 2.

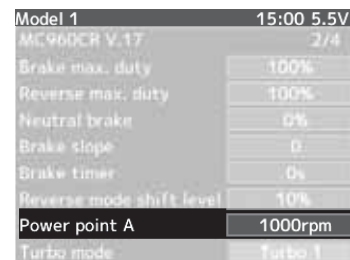

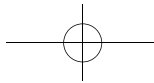

Lead angle use

MC940,960CR :ACT/INH

Same as Link software Lead Angle Use.

This function is effective when Turbo Mode is Turbo1 or Turbo2 and sets whether or not lead angle is used. This setting has priority over the Turbo Mode setting. When using in races in which the lead angle function is inhibited by the ESC set this function to INH.

INH : Lead angle function not used.

ACT : Lead angle used

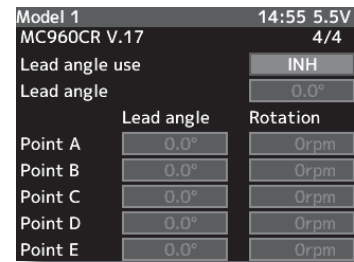

Turn on "Lead angle use"

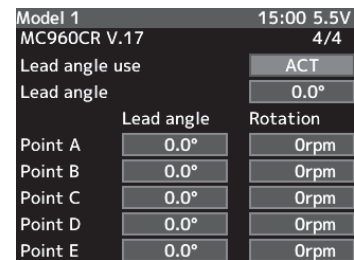

Lead angle

MC940,960CR :0deg-59deg

Same as Link software Lead Angle.

When "Lead Angle Use" is turned on the motor lead angle can be set at the MC960CR. The lead angle can be set up to 59 degrees in 1 degree increments.

Point A,B,C,D,E Lead angle

MC940,960CR :0deg~59deg

Same as Link software Boost Angle.

Point A,B,C,D,E Rotation

MC940,960CR :0rpm-99990rpm

Same as Link software Boost Angle rpm.

When "Lead Angle Use" is turned on the lead angle versus motor speed of the 5 points A to E can be set. The lead angle can be set up to 59 degrees in 1 degree increments.

The "Lead angle" and "Point A, B, C, D, E Lead angle" relationship is shown on the graphs below. Graph [1] shows the relationship when the same value is set at "Points A, B, C, D, E Lead angle" of [1] and [2] and the "Lead angle" was set to "0" and graph [2] shows the relationship when a value other than "0" was set at "Lead angle". As shown in the graphs, [2] is added to the "Points A, B, C, D, E Lead angle" set lead angle and [1] is added to the "Lead angle" set lead angle. For example, if "3" is set at Point A and "Lead angle" of [2] is set to "2", the actual Point A becomes 3+2=5 (deg). Since "Lead angle" of [A] is "0", the actual Point A also becomes 3+0=3 (deg).

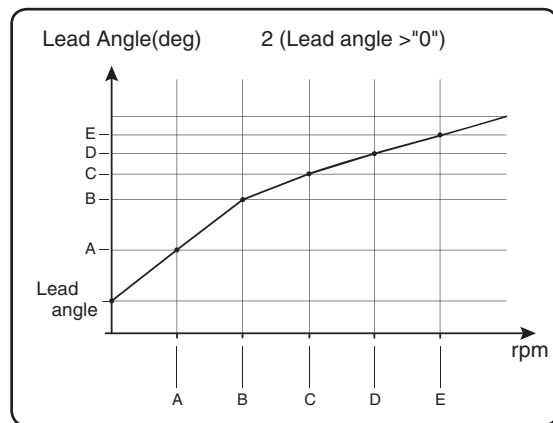
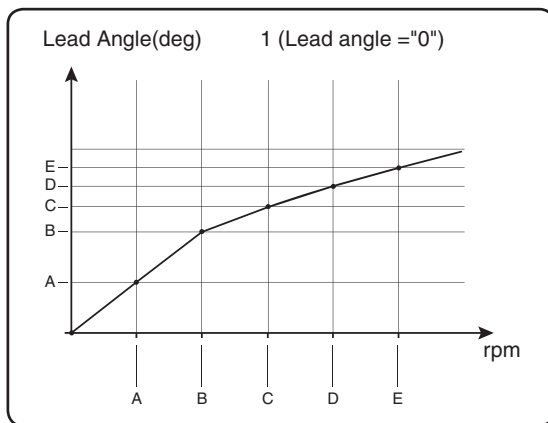

When using in races in which the lead angle setting function is inhibited by the ESC, set "Lead angle use" to "INH". The "Lead angle use" setting has priority over "Turbo mode". If "Lead angle use" is set to "INH", the lead angle setting function can be turned off even if "Turbo mode" is set to "Turbo1" or "Turbo2".

The MC940,960CR shows that the lead angle setting function is OFF ("0" timing) by blinking a LED.

Function

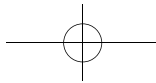

S.Bus Servo

This is a special function which allows Futaba S.BUS/S.BUS2 servo parameter changes to be set by the T4X transmitter.

However, some data changes require a PC and S-Link software.

This function is used by connecting Futaba S.BUS/S.BUS2 servo directly to the transmitter.

Use the various optional servo extension cords according to the distance between the transmitter and servo.

-When the T4PX battery voltage drops, since the display switches to low battery display, use this function in the state in which the remaining battery charge is sufficient.

-Power is supplied to the servo from the transmitter, but the corresponding voltage is for high voltage servo (HV) use. Since an overvoltage will be applied to servos other than this, connect the corresponding battery to the servo. When the battery is connected, the supply of power from the transmitter automatically stops.

⚠ Caution

❗ When connecting an S-BUS servo that does not support high voltage, connect a battery matched to the servo specifications.

High voltage servo support voltage is supplied from the transmitter. If a servo that does not support high voltage is connected, unreasonable force will be applied to the servo and will cause trouble.

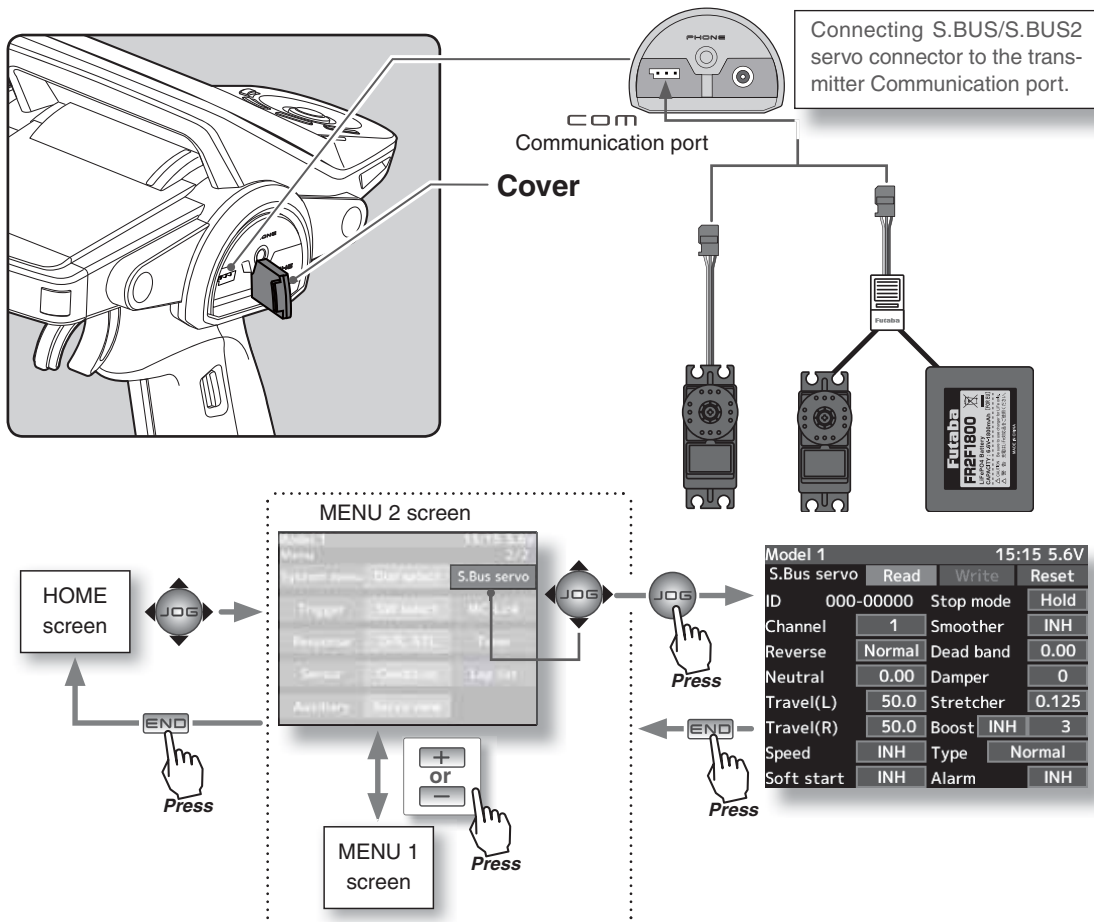

Function

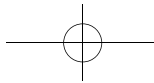

Using the S.Bus servo function

(Preparation)

- Connect the T4PX and S.BUS or S.BUS2 servo in accordance with the connection diagram shown on page 126.
- Connect the battery to a non-high voltage(HV) support S.BUS/S.BUS2 servo.

1 Turn power on the transmitter. "S.Bus servo" menu is displayed referring to the map of page126.

2 (S.BUS/S.BUS2 servo read)

Execute this function to read the connected servo type and the data currently set at the servo.

-Select the setting item "Read" by (JOG) button up or down operation, and press the (JOG) button.



Model 1		15:15 5.5V	
S.Bus servo	Read	Write	Reset
ID	017-00005	Stop mode	Hold
Channel	1	Smoother	ACT
Reverse	Normal	Dead band	0.36
Neutral	0.00	Damper	96
Travel(L)	100.0	Stretcher	1.000
Travel(R)	100.0	Boost	INH 5
Speed	INH	Type	Normal
Soft start	3.00	Alarm	INH

Setup item selection

- Select by (JOG) button up or down operation.

Reset execution button

- (JOG) buttons pressed.

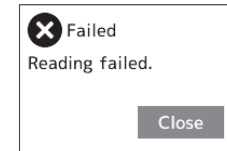
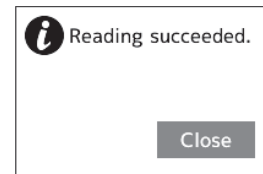

- "Reading succeeded" is displayed on the screen and the servo's ID cord and currently set contents are read.

- If "Failed" is displayed on the screen, communication with the servo is not being performed normally.

Check the T4PX and servo connection to servo and repeat "Read". (Connect the battery to a non-high voltage(HV) support servo.)

3 (Writing to S.BUS/S.BUS2)

Execute this function to write the setting data to servo. See pages 128~129 for the setting data contents.

-Select the setting item "Write" by (JOG) button up or down operation, and press the (JOG) button.

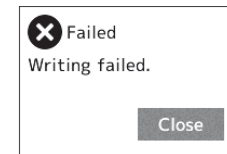
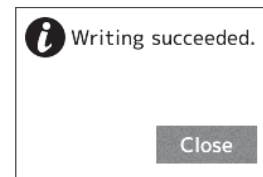

- "Writing succeeded" is displayed on the screen and the setting data is written to servo.

- If "Failed" is displayed on the screen, communication with the servo is not being performed normally. Check the T4PX and servo connection to servo and repeat "Write". (Connect the battery to a non-high voltage(HV) support servo.)

4 (Initialization)

Write the factory set servo setting data to the connected servo and T4PX.

-Select the setting item "Reset" by (JOG) button up or down operation, and press the (JOG) button.

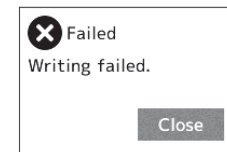
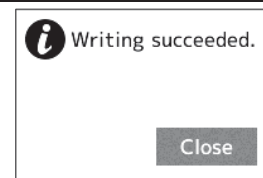

- "Writing succeeded" is displayed on the screen and the setting data is written to servo.

- If "Failed" is displayed on the screen, communication with the servo is not being performed normally. Check the T4PX and servo connection to servo and repeat "Write". (Connect the battery to a non-high voltage(HV) support servo.)

S.Bus servo

Function

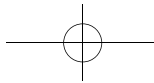

S.BUS function setup

(Preparation)

-S.BUS/S.BUS2 servo is read referring to the explanation of page 127.

- 1 Select the setting item by (JOG) button up, down, left, or right operation.
Set the value by (+) and (-) button.

ID

Displays the ID of the servo whose parameters are to be read. It cannot be changed.

Channel

This is the S.BUS system channel assigned to the servo. When connected to the receiver S-BUS2 connector as an S.BUS system, the channel used by the transmitter is assigned. When the normal receiver channel is used, channel setting is unnecessary.

Reverse

The direction in which the servo rotates can be changed.

Neutral

The neutral position can be changed. When the neutral offset is large value, the servo's range of travel is restricted on one side.

Travel(L)

The maximum left travels centered about the neutral position can be set independently.

Travel(R)

The maximum right travels centered about the neutral position can be set independently.

Speed

Speeds can be matched by specifying the operating speed. The speed of multiple servos can be matched without being affected by motor fluctuations. This is effective for load torques below the maximum torque.

However, note that the maximum speed will not be exceeded what the servo is capable of even if the servos operating voltage is increased.

Soft Start

Restricts operation in the specified direction the instant the power is turned on. By using this setting, the first initial movement when the power is turned on slowly moves the servo to the specified position.

Stop Mode

The state of the servo when the servo input signal is lost can be specified. The "Hold" mode setting holds the servo in its last commanded position even if using AM or FM system.

Smoother

This function makes servo operation smooth. Set it according to your taste. Normally set it to "ACT". Set it to "INH" when want especially quick operation. When the smoother function was set to "ACT" and the servo was operated the distance up to the target position is hanged in steps so movement is smooth.

Dead band

The dead band angle at stopping can be specified.

[Relationship between dead band set value and servo operation]

Small - Dead band angle is small and the servo is immediately operated by a small signal change.

Large - Dead band angle is large and the servo does not operate at small signal changes.

(Note) If the dead band angle is too small, the servo will operate continuously and the current consumption will increase and the life of the servo will be shortened.

Model 1		15:15 5.6V	
S.Bus servo	Read	Write	Reset
ID	000-00000	Stop mode	Hold
Channel	1	Smoother	INH
Reverse	Normal	Dead band	0.00
Neutral	0.00	Damper	0
Travel(L)	50.0	Stretcher	0.125
Travel(R)	50.0	Boost	INH 3
Speed	INH	Type	Normal
Soft start	INH	Alarm	INH

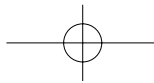

Damper

The characteristic when the servo is stopped can be set.

When smaller than the standard value, the characteristic becomes an overshoot characteristic. If the value is larger than the standard value, the brake is applied before the stop position.

Especially, when a large load is applied, overshoot, etc. are suppressed by inertia and hunting may occur, depending on the conditions. If hunting (phenomena which cause the servo to oscillate) occurs even though the Dead Band, Stretcher, Boost and other parameters are suitable, adjust this parameter to a value larger than the initial value.

[Relationship between damper set value and servo operation]

Small - When you want to overshoot. Set so that hunting does not occur.

Large - When you want to operate so that braking is not applied. However, it will feel like the servo response has worsened.

(Note) If used in the hunting state, not only will the current consumption increase, but the life of the servo will also be shortened.

Stretcher

The servo hold characteristic can be set. The torque which attempts to return the servo to the target position when the current servo position has deviated from the target position can be adjusted.

This is used when stopping hunting, etc., but the holding characteristic changes as shown below.

[Relationship between stretcher and servo operation]

Small - Servo holding force becomes weaker.

Large - Servo holding force becomes stronger.

(Note) When this parameter is large, the current consumption increases

Boost/Boost (ON/OFF)

INH : It is the boost ON at the time of low-speed operation. (In the case of usual)

ACT : It is always the boost ON. (When quick operation is hope)

The minimum current applied to the internal motor when starting the servo can be set. Since a small travel does not start the motor, it essentially feels like the dead band was expanded. The motor can be immediately started by adjusting the minimum current which can start the motor.

[Relationship between boost set value and servo operation]

Small - Motor reacts to a minute current and operation becomes smooth.

Large - Initial response improves and output torque increases. However, if the torque is too large, operation will become rough.

Type

When "Retractable" is selected and the servo has been continuously stopped for 30 seconds, the dead band expands and unnecessary hold current due to external force is eliminated. When a new control signal enters, normal operation is resumed. When using the servo as a landing gear servo, select "Retractable". Also adjust the servo travel to match the landing gear movement range.

Alarm

When the power supply of a servo is previously turned on at the time of a power supply injection without taking transmit of a transmitter, the buzzer sound of about 2.5 Hz continues sounding from a servo.

(Even when the transmit of a transmitter is taken out previously, a buzzer becomes until the signal of a servo is outputted normally, but it is not unusual.)

The transmitter has been turned OFF ahead of a servo power supply The buzzer sound of about 1.25 Hz continues sounding as servo power supply end failure alarm.

(Do not insert or remove the servo connector while the receiver power is ON. A buzzer may sound by incorrect recognition.)

*Buzzer sound is generated by vibrating the motor of a servo.

Since current is consumed and a servo generates heat, please do not operate the number more than needed or do not continue sounding a buzzer for a long time.

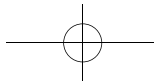

Telemetry Menu

It is necessary to turn on the telemetry on the receiver setting screen to use the telemetry function. (p.46)

This screen displays and sets the various information from the receiver. An alarm and vibration can be generated depending on the information. The alarm and the vibration are set by each information screen. For example, a drop in the voltage of the receiver battery housed in the model car can be reported by an alarm.

The telemetry data received last is memorized. Therefore, even if the receiver power is turned off, information display, audio guide, and alarms remain until the transmitter power is turned off.

The speech function can be turned on and off with the specified switch. See the function select switch function (p.99).

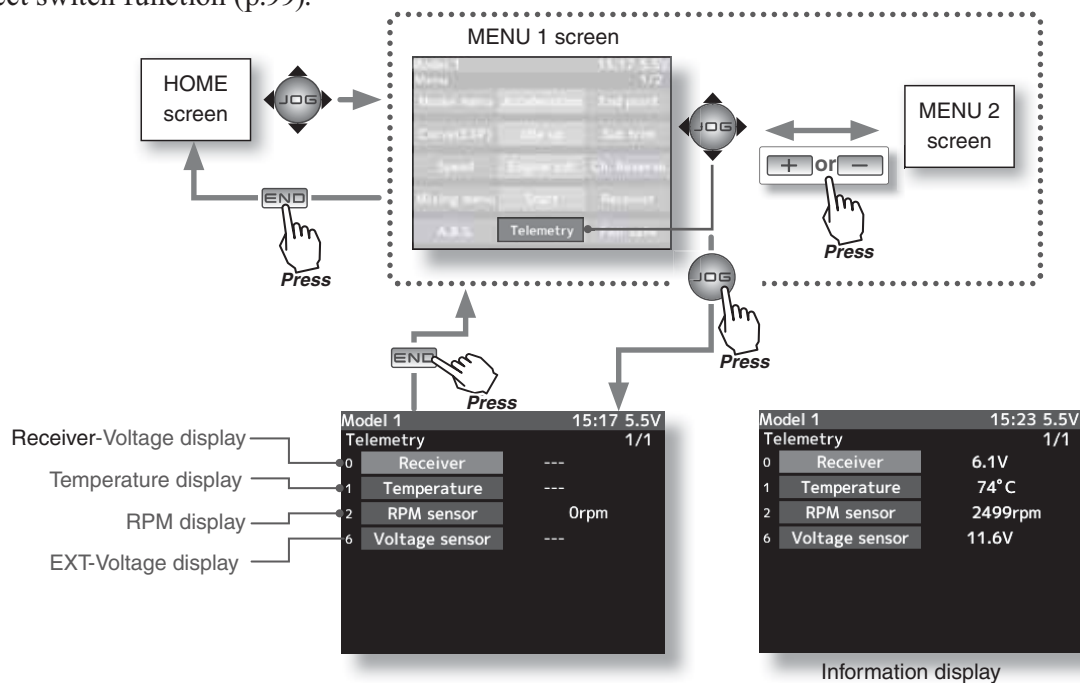

Using Telemetry function

(Preparation)

The sensor used is connected with the receiver referring to the connection diagram of page 130.

1 (Telemetry act)

The telemetry is turned on on the receiver setting screen.

(p.46)

It comes to be able to display telemetry information.

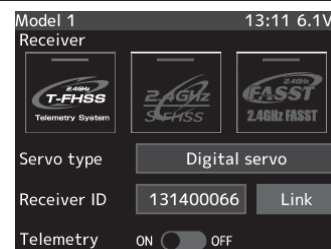

2 When ending setting, return to the menu screen by pressing the (END) button.

Each information is described in detail beginning from page132.

Telemetry

Function

131

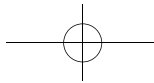

Telemetry :Receiver Battery

This function displays and sets the receiver power supply battery. The sensor sold separately does not have to be installed. The transmitter initial state voltage is also displayed. For a description of alarm setting when the voltage drops, see the description of the procedure on this page.

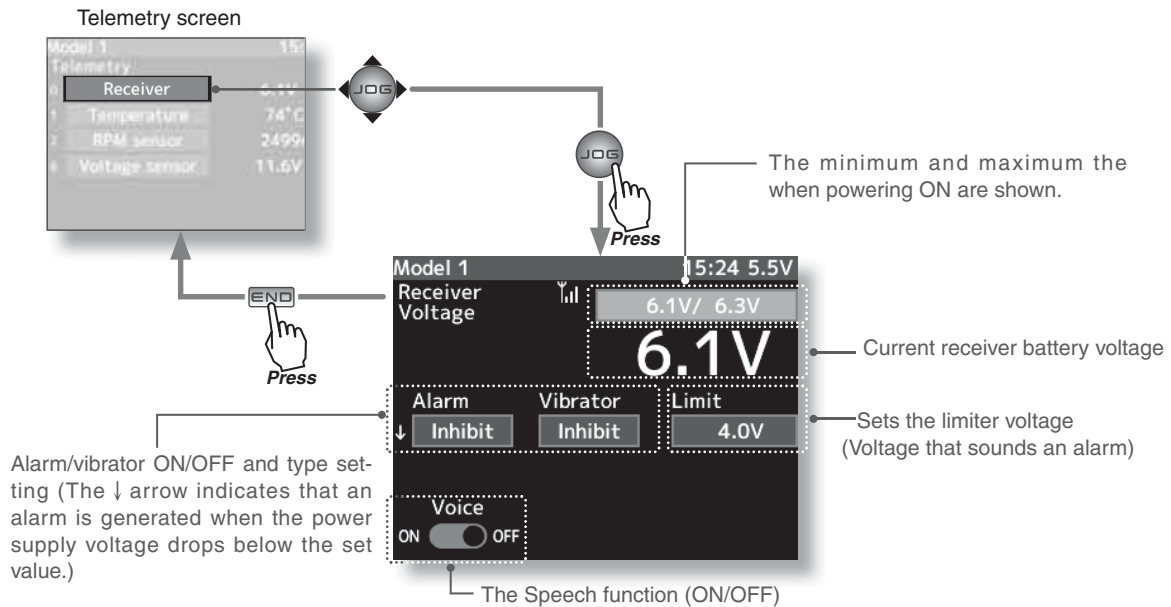

Alarm and Vibrator function setup

1 (Limit adjustment)

Select the setting item "Limit" by (JOG) button up, down, left or right operation.

Use the (+) or (-) button to adjust the limit voltage.

2 (Alarm and vibrator function setup)

Select the setting item "Alarm" by (JOG) button up, down, left or right operation. Set the function to the active state by pressing the (+) or (-) button.

"Inhibit" :No audible alarm

"Buzzer" :Audible alarm

"Voice" :Voice alarm

Select the setting item "Vibrator" by (JOG) button up, down, left or right operation. Press the (+) or (-) button and select the type.

"Inhibit" :No active vibration

"Type1" :Continuous vibration

"Type2" :Intermittent vibration for a long time

"Type3" :Intermittent vibration for a short time

3 (Speech function setup)

Select the setting item "Voice" by (JOG) button up, down, left or right operation. Set the function to the active state by pressing the (+) or (-) button.

The voice guide loading interval is set by sensor menu.

"OFF" :No voice guide

"ON" :Information loaded by voice

4 When ending setting, return to the Telemetry menu screen by pressing the (END) button.

Telemetry :The Drive Battery

With an external power supply, one voltage of the batteries (drive battery, servo power supply battery, etc.) mounted separately in the chassis can be displayed at the transmitter. The receiver S.BUS2 connector is used to connect the SBS-01Vsensor and the battery.

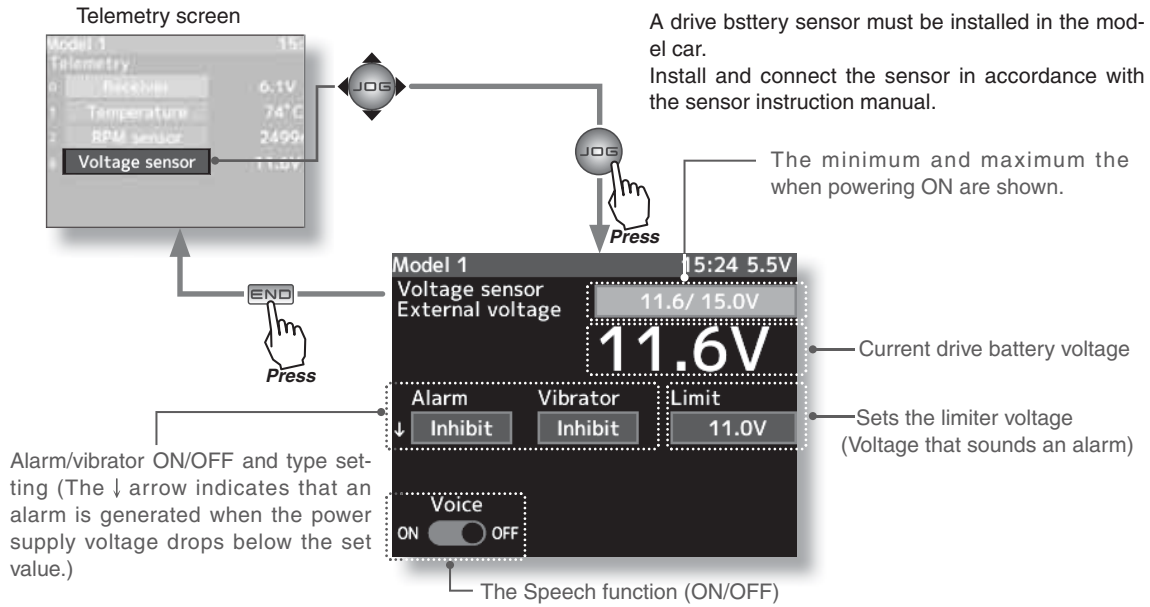

Alarm and Vibrator function setup

1 (Limit adjustment)

Select the setting item "Limit" by (JOG) button up, down, left or right operation.
Use the (+) or (-) button to adjust the limit voltage.

2 (Alarm and vibrator function setup)

Select the setting item "Alarm" by (JOG) button up, down, left or right operation. Set the function to the active state by pressing the (+) or (-) button.

"Inhibit" :No audible alarm
"Buzzer" :Audible alarm
"Voice" :Voice alarm

Select the setting item "Vibrator" by (JOG) button up, down, left or right operation. Press the (+) or (-) button and select the type.

"Inhibit" :No active vibration
"Type1" :Continuous vibration
"Type2" :Intermittent vibration for a long time
"Type3" :Intermittent vibration for a short time

3 (Speech function setup)

Select the setting item "Voice" by (JOG) button up, down, left or right operation. Set the function to the active state by pressing the (+) or (-) button.

"OFF" :No voice guide
"ON" :Information loaded by voice

The voice guide loading interval is set by sensor menu.

4 When ending setting, return to the Telemetry menu screen by pressing the (END) button.

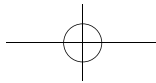

Telemetry :RPM

Speed information from an SBS-01RM (telemetry rotation sensor) sold separately is displayed and set at this screen. The speed of the engine, motor, etc. of the chassis while running can be viewed at the transmitter. When the speed becomes higher (lower) than the set speed, it can be announced by an alarm and vibration.

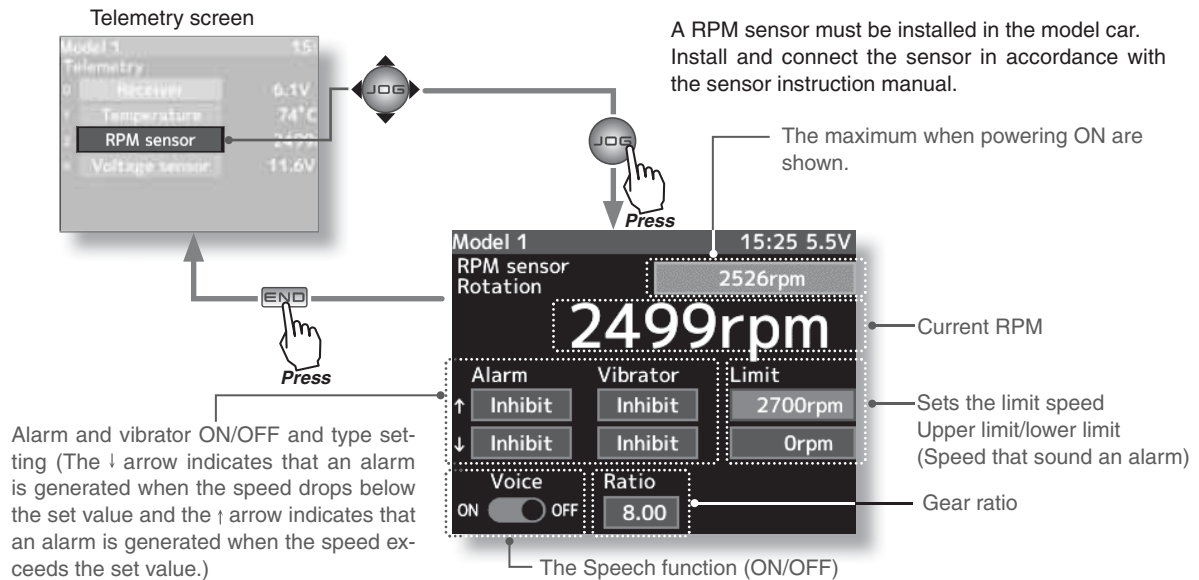

Alarm and Vibrator function setup

- 1** (Gear ratio setup)
Select the setting item "Ratio" by (JOG) button up, down, left or right operation. Use the (+) or (-) button to adjust the lgear ratio.
- 2** (Limit adjustment)
Select the setting item "↑ Limit" or "↓ Limit" by (JOG) button up, down, left or right operation. Use the (+) or (-) button to adjust the limit voltage.
- 3** (Alarm and vibrator function setup)
Select the setting item "↑ Alarm" or "↓ Alarm" by (JOG) button up, down, left or right operation. Set the function to the active state by pressing the (+) or (-) button.
"Inhibit" :No audible alarm / "Buzzer" :Audible alarm/ "Voice" :Voice alarm
Select the setting item "↑ Vibrator" or "↓ Vibrator" by (JOG) button up, down, left or right operation. Press the (+) or (-) button and select the type.
"Inhibit" :No active vibration/ "Type1" :Continuous vibration/ "Type2" :Intermittent vibration for a long time/
"Tyoe3" :Intermittent vibration for a short time
- 4** (Speech function setup)
Select the setting item "Voice" by (JOG) button up, down, left or right operation. Set the function to the active state by pressing the (+) or (-) button.
"OFF" :No voice guide/ "ON" :Information loaded by voice
- 5** When ending setting, return to the Telemetry menu screen by pressing the (END) button.

The voice guide loading interval is set by sensor menu.

Telemetry :Temperature

This screen displays and sets the temperature information from an SBS-01T (telemetry temperature sensor) sold separately. The temperature of the engine, motor, amp, etc. of the chassis while running can be viewed at the transmitter.

When the temperature becomes higher (lower) than the set value, it can be announced by an alarm and vibration.

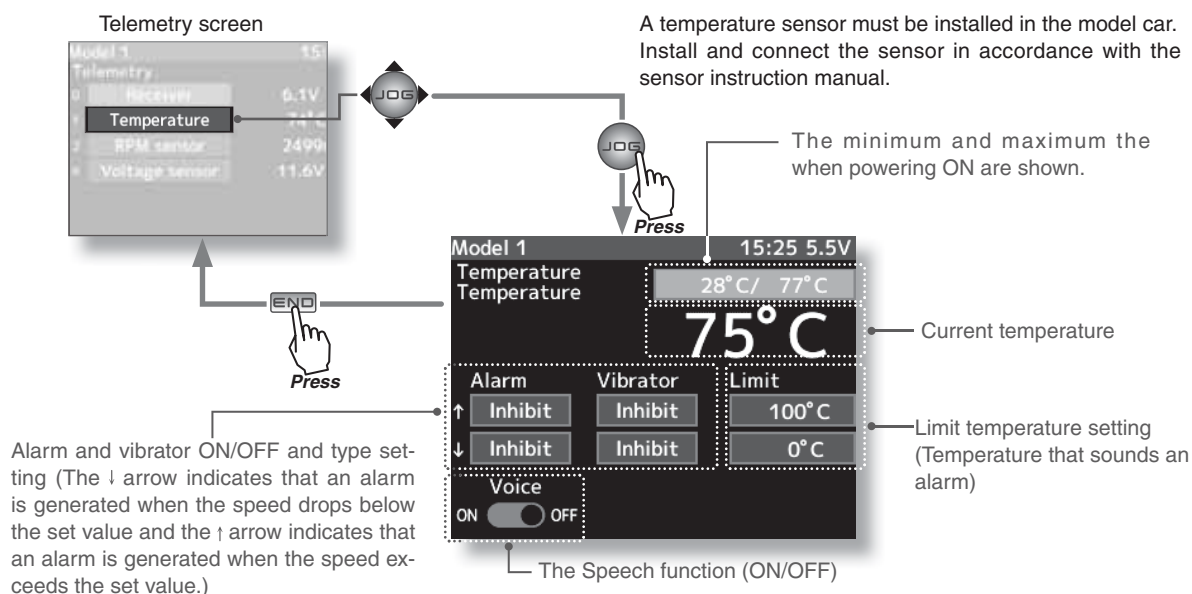

Alarm and Vibrator function setup

1 (Limit adjustment)

Select the setting item "↑ Limit" or "↓ Limit" by (JOG) button up, down, left or right operation. Use the (+) or (-) button to adjust the limit voltage.

2 (Alarm and vibrator function setup)

Select the setting item "↑ Alarm" or "↓ Alarm" by (JOG) button up, down, left or right operation. Set the function to the active state by pressing the (+) or (-) button.

"Inhibit" :No audible alarm / "Buzzer" :Audible alarm/ "Voice" :Voice alarm

Select the setting item "↑ Vibrator" or "↓ Vibrator" by (JOG) button up, down, left or right operation. Press the (+) or (-) button and select the type.

"Inhibit" :No active vibration/ "Type1" :Continuous vibration/ "Type2" :Intermittent vibration for a long time/
"Type3" :Intermittent vibration for a short time

3 (Speech function setup)

Select the setting item "Voice" by (JOG) button up, down, left or right operation. Set the function to the active state by pressing the (+) or (-) button.

The voice guide loading interval is set by sensor menu.

"OFF" :No voice guide
"ON" :Information loaded by voice

4 When ending setting, return to the Telemetry menu screen by pressing the (END) button.

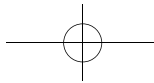

Sensor Menu

This menu registers the telemetry sensors used with the transmitter. When only one of a certain type of sensor is used, this setting is unnecessary and the sensor can be used by simply connecting it to the S.BUS2 port of the transmitter.

When using 2 or more of the same kind of sensor, they must be registered here.

What is a slot?

Servos are classified by CH, but sensors are classified in units called "slot". There are slots from No. 1 to No. 31. Using a sensor which uses two or more slots, the required number of slots is automatically assigned by setting up a start slot. When 2 or more of the same kind of sensor are used, the sensors themselves must allocate unused slots and memorize that slot.

The interval at which the voice guide of the telemetry information is read and the interval at which the log data is recorded can be set at this screen.

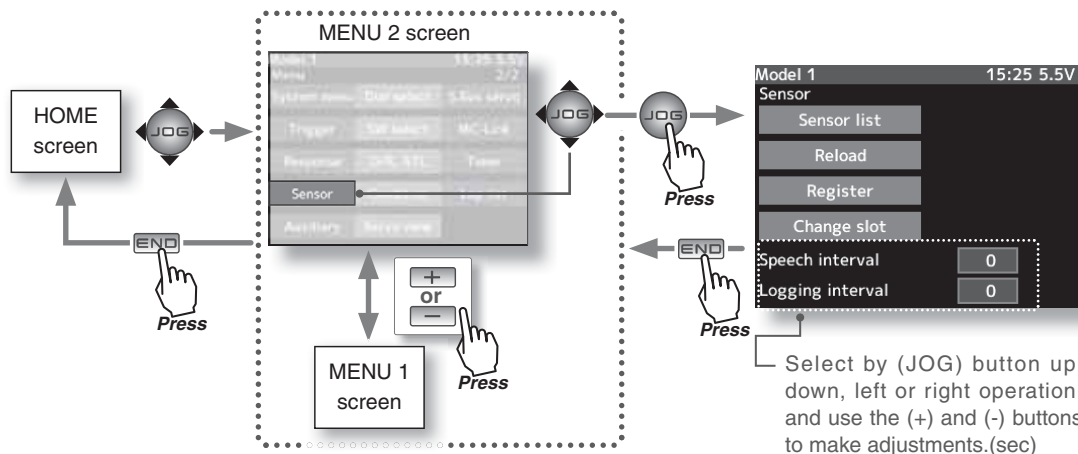

sensor	The required number of slots	The number which can be used as a start slot
TEMP(SBS-01T)	1 slot	1~31
RPM(SBS01RM)	1 slot	1~31
Voltage(SBS-01V)	2 slot	1, 2, 3, 4, 5, 6, 8, 9, 10, 11, 12, 13, 14, 16, 17, 18, 19, 20, 21, 22, 24, 25, 26, 27, 28, 29, 30

Function

Sensor List

The sensors registered at the T4PX are displayed. When sensor reloading, sensor registration, slot number change, etc. is performed, it is added to the list and the list is changed.

- Adjustment buttons**
- Use the (+) and (-) buttons to make adjustments.
 - Return to the initial value by pressing the (+) and (-) buttons simultaneously (approx. 1 sec).
- Interval**
0 ~ 30sec
Initial value:0

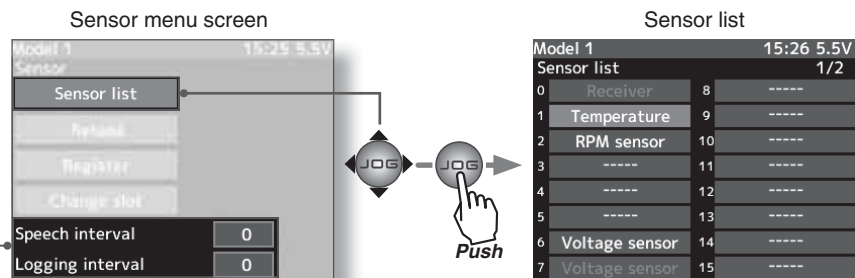

Sensor Menu

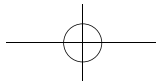

When sensor registration or slot number change was performed and the message "Failed. The connected sensor is not ready." was displayed, check the sensor connection. If the sensor is firmly connected, the sensor or transmitter is probably faulty.

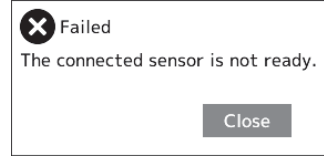

Sensor Reload

This function secures contiguous unused slots by rearranging the registration state when sensor registration and deregistration are performed repeatedly and the unused slots are fragmented.

All the sensors to be used are connected to the T4PX.

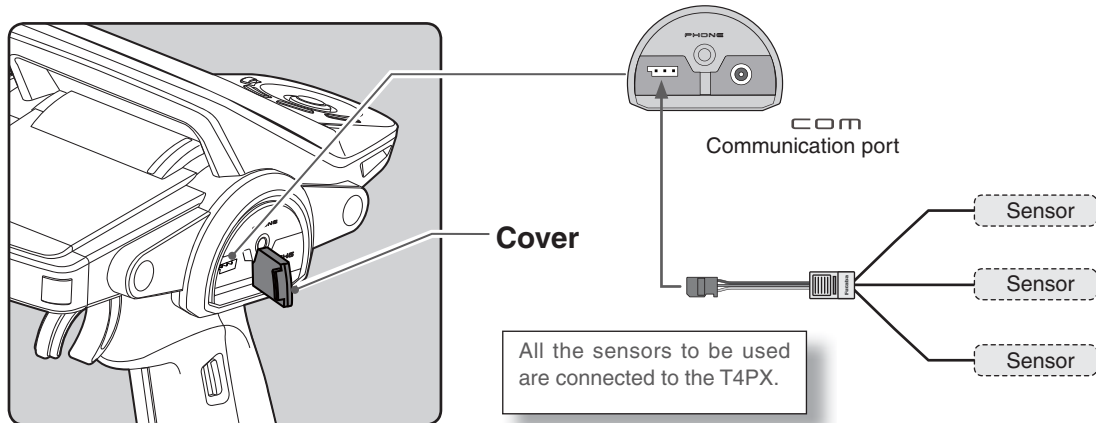

Sensor reload

1 (Reload)

Select "Reload" by (JOG) button up or down operation and press the (JOG) button. The confirmation message "Are you sure?" appears. To execute reload, select "Yes" and to cancel reload, select "No" with the (JOG) button and press the (JOG) button. If the message "Success" is displayed, reloading is complete.

Sensor menu screen

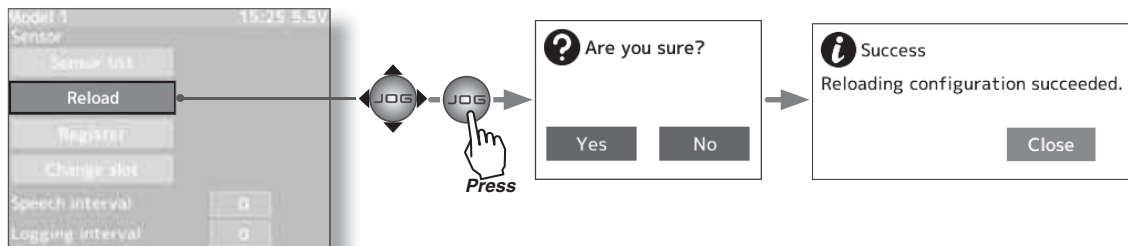

Setup item selection

- Select by (JOG) button up or down operation.

Reload button

- (JOG) buttons pressed.

Function

2 When ending setting, return to the Sensor menu screen by pressing the (END) button.

Sensor Menu

137

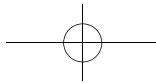

Sensor Register

This function registers an additional sensor. Connect the sensor as shown in the figure and register it by the following procedure. The sensor ID is registered in the transmitter.

This function is set when using multiple telemetry sensors of the same type.

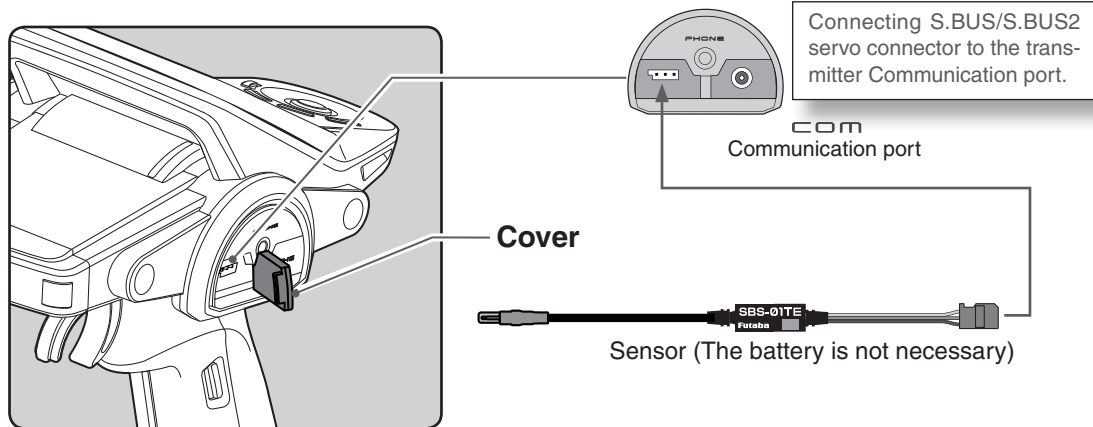

Sensor register

1 (Register)

Select "Register" by (JOG) button up or down operation and press the (JOG) button. The confirmation message "Are you sure?" appears. To execute registration, select "Yes" and to cancel registration, select "No" by (JOG) button and press the (JOG) button. If registering a sensor that has already been registered is attempted, the message "Failed" will be displayed.

Setup item selection

- Select by (JOG) button up or down operation.

Register button

- (JOG) buttons pressed.

Function

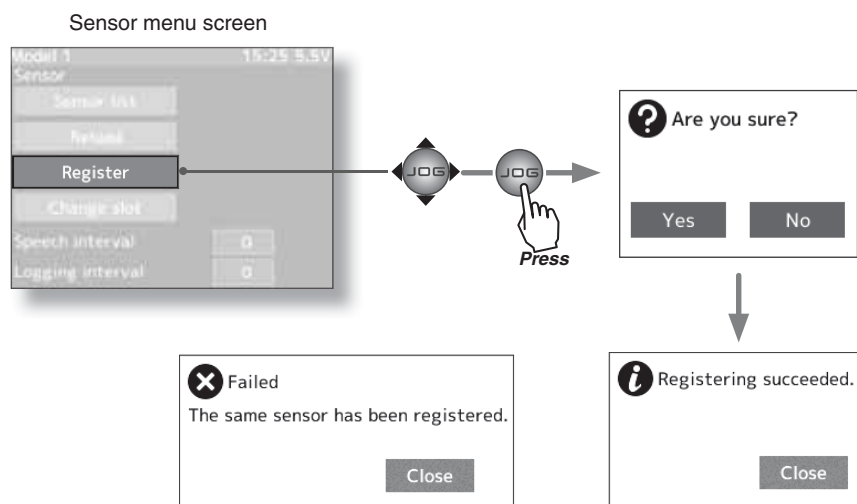

2 When ending setting, return to the Sensor menu screen by pressing the (END) button.

Change Slot

This procedure changes the slot number of one registered sensor. Connect the sensor as shown in the figure(p.138), and change slot number. it by the following procedure.

This function is set when using multiple telemetry sensors of the same type.

Sensor slot change

1 (Change)

Select "Slot No. change" by (JOG) button up or down operation and press the (JOG) button. A sensor details screen is displayed.

Setup item selection

- Select by (JOG) button up or down operation.

Select button

- (JOG) buttons pressed.

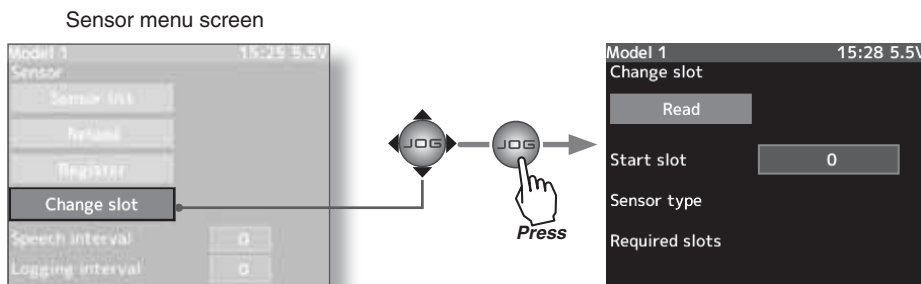

2 Select "Load" by (JOG) button up or down operation and press the (JOG) button. The message "Reading succeeded" appears and the current sensor information is displayed.

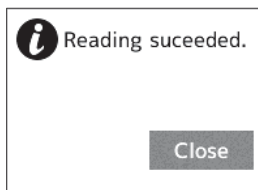

3 Select "Slot No." by (JOG) button up or down operation and set the new number by pressing the (+) or (-) button.

4 Select "Write" by (JOG) button up or down operation and press the (JOG) button. The message "Settings written" appears and number change is complete.

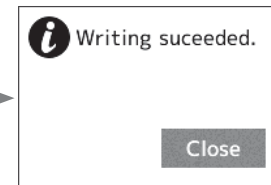
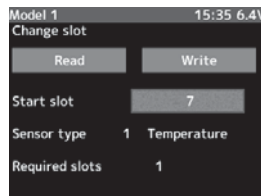

5 When ending setting, return to the Sensor menu screen by pressing the (END) button.

Function

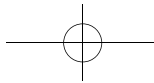

Condition Function

Two kinds of data can be set in one model for specific functions only; for example, two kinds of data such as steering D/R set to 90% at normal condition and steering D/R set to 80% at second condition. This second condition can be set for each model.

-The functions that can be set at each condition are displayed by condition number at the top of the menu screen. Since the reverse function, end point and other model standard setup menus are not displayed by conditioner number, the condition 1 and condition 2 settings are common.

- To use the condition function, switch setting by function select switch (p.99) is necessary.

- Switching from normal condition to second condition by switch set by function select switch is indicated by an audible alarm, and the condition number is displayed in the upper on the screen.

-First, the initial settings of each condition 2 function are created.

-The data set at condition 2 is memorized until reset by model reset (p.116). The data is memorized even if the condition function is turned off or setting of the SW by switch setting function is changed.

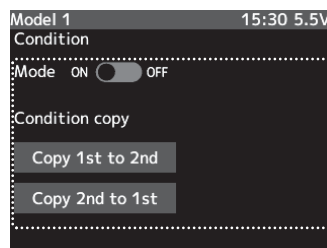
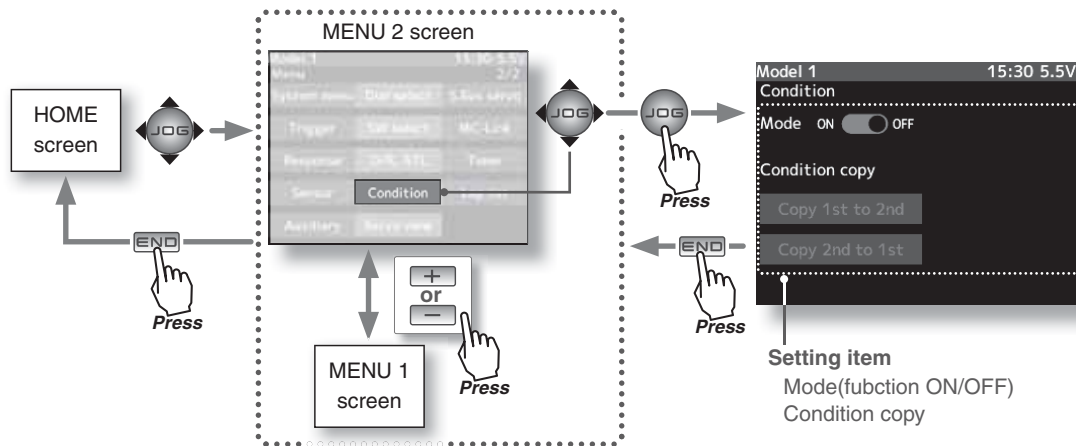

When the condition function is turned on, the condition copy display becomes active and the condition is enabled.

Function

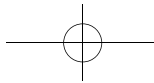

Condition setup

(Preparation)

- Use the function select switch function to select the switch. (p.99)

1 (Function ON/OFF)

Select the setting item "Mode" by (JOG) button up or down operation. Set the function to the active state by pressing the (+) or (-) button.

"OFF" :Function OFF
"ON" :Function ON



Setup item selection

- Select by (JOG) button up, or down operation.

Setup buttons

- Use the (+) or (-) buttons to make setup.

Function ON/OFF (Mode)
ON,OFF

Condition copy display becomes active and the condition can be used.

2 (Condition copy ON/OFF)

Select the condition copy direction by (JOG) button up or down operation. When copying from condition copy 1 to condition copy 2, select "2nd to 1st", and press the (JOG) button.

The confirmation message "Are you sure?" appears. To execute copy, select "Yes" and to cancel copy, select "No" and press the (JOG) button.

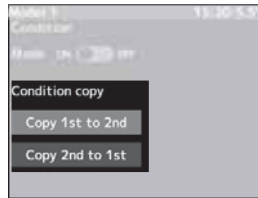

Copy selection

- Select by (JOG) button up, or down operation.

Setup buttons

- (JOG) buttons pressed.



3 When ending setting, return to the menu screen by pressing the (END) button.

Display when condition is used

Condition number 1

HOME screen

Condition number 2

Example D/R, ATL screen

Condition Function

Function

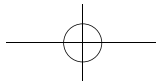

Response Adjustment

The operation response can be adjusted to your preference and the steering and throttle can be individually adjusted in 50 steps to match the course and vehicle.

Basically, the standard fastest response is recommended. However, use this function when you want to change the response feeling. When this function is turned on, both the steering and throttle are switched from the standard fastest response to step 1 mild direction setting. The steering and throttle can be separately adjusted up to 50 steps in the mild direction based on this.

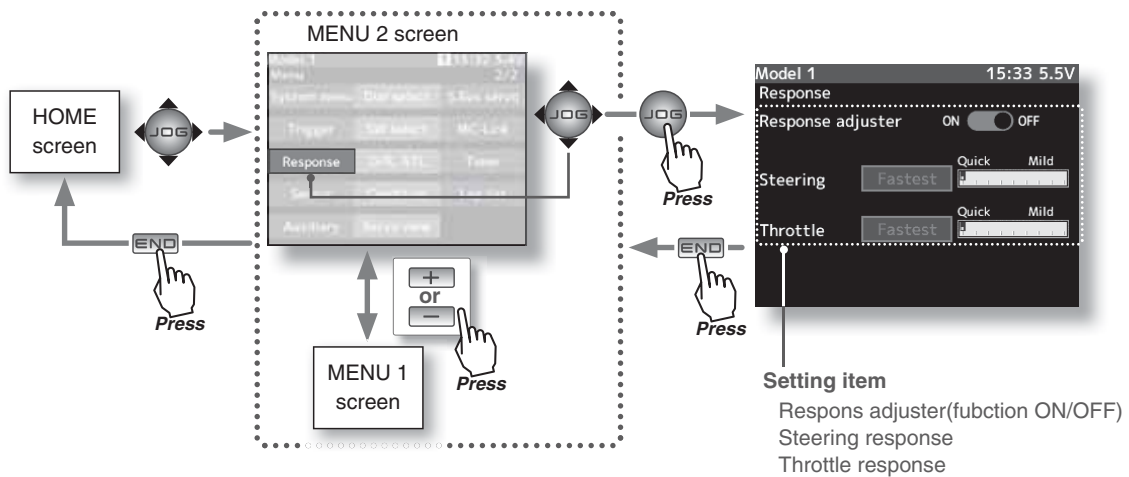

Response adjustment

1 (Function ON/OFF)

Select the setting item "Response adjuster" by (JOG) button up or down operation. Set the function to the active state by pressing the (+) or (-) button.



Setup item selection

- Select by (JOG) button up, or down operation.

Setup buttons

- Use the (+) or (-) buttons to make setup.

2 (Steering response)

Select the "Steering" to be set by (JOG) button operation. When you want to milder steering response, use the (+) button to adjust the "+" side. When you want to make steering operation quicken use the (-) button to adjust the "-" side.

Adjustment buttons

- Use the (+) and (-) buttons to make adjustments.
- Return to the initial value by pressing the (+) and (-) buttons simultaneously (approx. 1 sec).

Rate: 1 ~ 50

3 (Throttle response)

Select the "Throttle" to be set by (JOG) button operation. When you want to milder throttle response, use the (+) button to adjust the "+" side. When you want to make steering operation quicken use the (-) button to adjust the "-" side.

4 When ending setting, return to the menu screen by pressing the (END) button.

Function

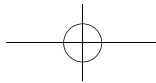

System Menu

The graphic liquid crystal screen display mode, sound, LED setting, date/time, user name, battery mode, calibration can be set and information.

The system function setup items cannot be set for each model. (Second condition can be set for each model.)

- Display

Liquid crystal screen backlighting display mode setup.
(OFF, ON at button operation, normally ON)

- Sound

Buzzer, speech sound volume adjustment.

- LED setting

LED display setup. (OFF, Link to LCD screen backlight setting)

- Battery

Select the battery alarm voltage according to the battery to be used.
Battery type setting (LiFe 2cells, NiMH 5cells, Other)

- User name

This function allows you to assign a 15 character to user name.

- Date and Time

Setting at date and time/ Setting of either time or total timer on HOME screen.

- Calibration

Use this function when a mechanical offset has occurred for some reason.

- Information

System program version information, and selection of language.

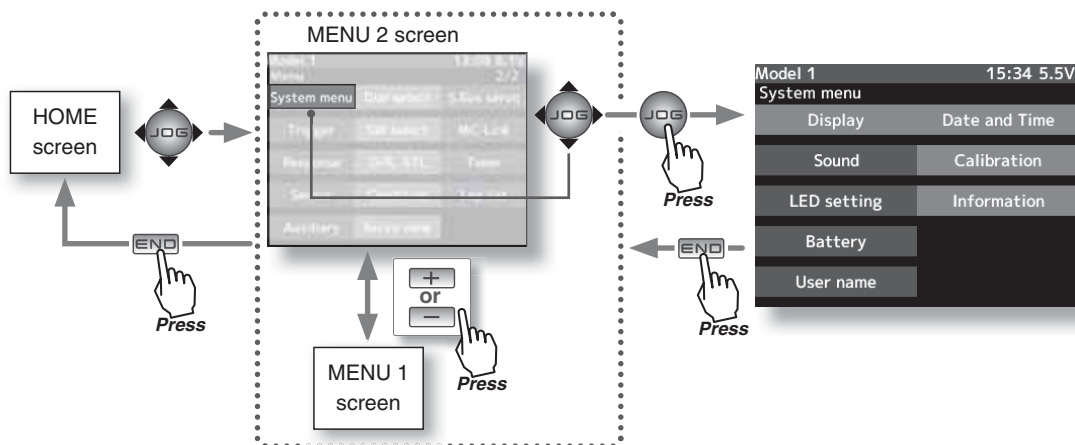

Function

Each set screen is displayed from the system menu. Please refer to the following maps.

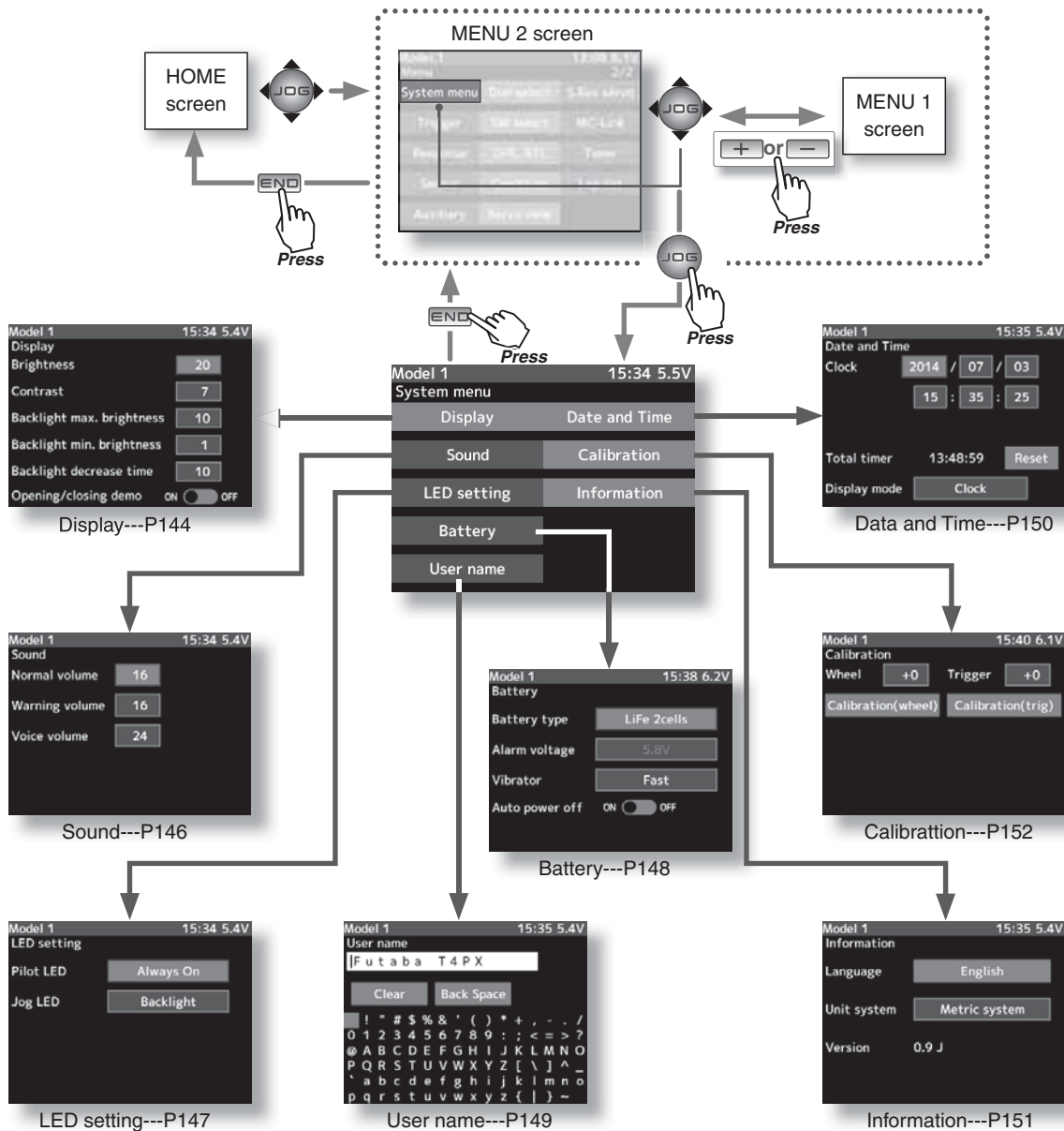

Function

Display setting

Brightness, contrast and back light mode adjustment LCD screen.

This setting is displayed from the screen of the system menu. (above figure)

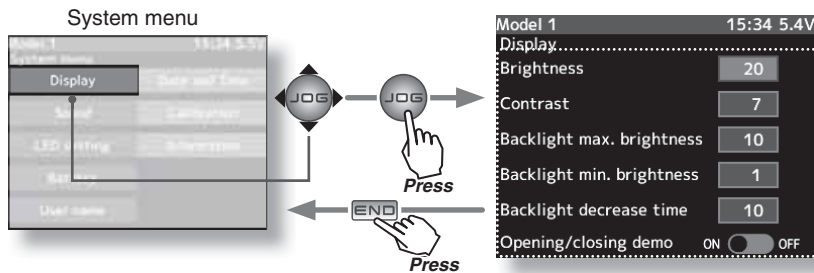

Setup item selection

- Select by (JOG) button up, or down operation.

buttons

- **Setup /Adjustment buttons**
- Use the (+) and (-) buttons to make adjustments.
- Return to the initial value by pressing the (+) and (-) buttons simultaneously (approx. 1 sec).

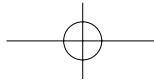

Display setup

- 1** (Adjusting the crystal brightness)
Select the "brightness" to be set by (JOG) button operation, and use the (+) and (-) buttons to adjust the screen brightness.

- 2** (Adjusting the liquid crystal contrast)
Select the "Contrast" to be set by (JOG) button operation, and use the (+) and (-) buttons to adjust the screen contrast.

- 3** (Backlight decrease brightness adjustment)
Select the "Backlight max, brightness" or "Backlight man, brightness" to be set by (JOG) button operation, Adjust the backlight decrease brightness with the (+) and (-) buttons.

- 4** (Backlight decrease time)
You can set a time period to decrease the LCD backlight. This function counts the period that the touch panel has been not operated. This time can be set by one second steps. You can also turn off the backlight decrease if you like.
Select the "Backlight decrease time", to be set by (JOG) button operation, and use the (+) and (-) buttons to adjust the backlight decrease time .

- 5** (Setting of Opening/closing demo)
Whether or not the Futaba T4PX logo appears on the screen at starting and ending can be set. When set to OFF, the logo is not displayed.
Select the "Opening/closing screen" to be set by (JOG) button operation, and use the (+) and (-) buttons to select the display mode.

- 6** When ending setting, return to the system menu screen by pressing the (END) button.

Brightness
0~63
Initial value: 20

Contrast
0~15
Initial value: 8

Backlight decrease brightness
0~20
Initial value: max-10,min-1

Backlight decrease time
NH,1~240 sec
Initial value: max-10,min-1

Demo csreen
ON/OFF
Initial value:ON

Function

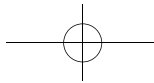

Sound Setting

This function can set the volume of "Key Operation", "Warning" and "Telemetry speech info".

-The volume of the click when edit key, jog, and trim are operated can be adjusted.

-The volume of the audible alarm sound can be adjusted.

-When the telemetry function is used, the volume of the voice that announces the temperature, speed, voltage, and other information at a fixed interval can be adjusted.

This setting is displayed from the screen of the system menu. (p.144)

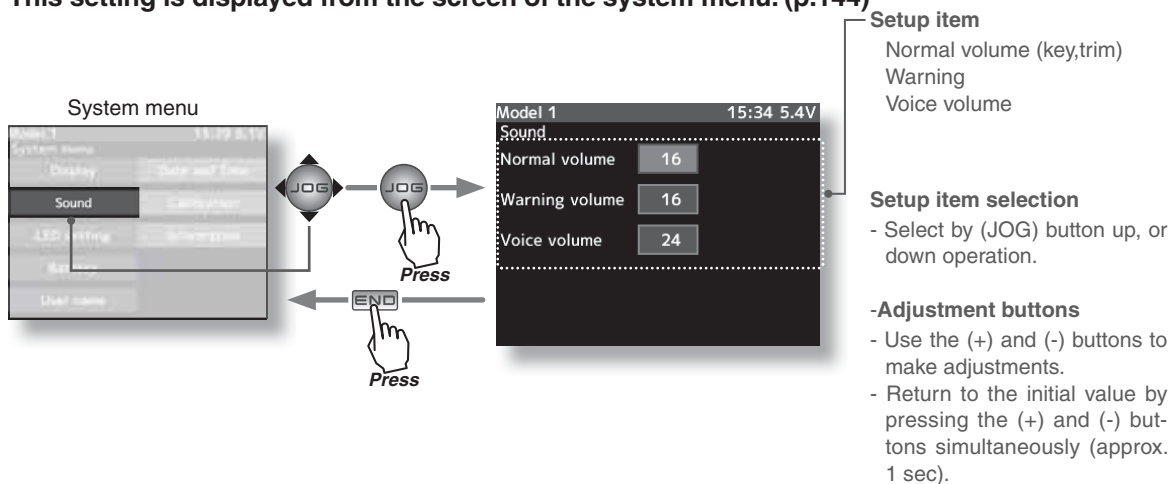

Volume adjustment

1 (Adjusting the key operation volume)

Select the "Normal volume" to be set by (JOG) button operation, and use the (+) and (-) buttons to adjust the volume.

Normal volume
0~32
Initial value: 16

2 (Adjusting the warning volume)

Select the "Warning volume" to be set by (JOG) button operation, and use the (+) and (-) buttons to adjust the volume.

Warning volume
1~32
Initial value: 16

3 (Adjusting the voice volume)

Select the "Voice volume" to be set by (JOG) button operation, and use the (+) and (-) buttons to adjust the volume.

Voice volume
0~32
Initial value: 16

4 When ending setting, return to the system menu screen by pressing the (END) button.

LED Setting

The method of lighting the pilot LED light and job LED light can be adjusted.

-Pilot LED always on, off.

-Jog LED always on, off, linked with backlighting.

This setting is displayed from the screen of the system menu. (p.144)

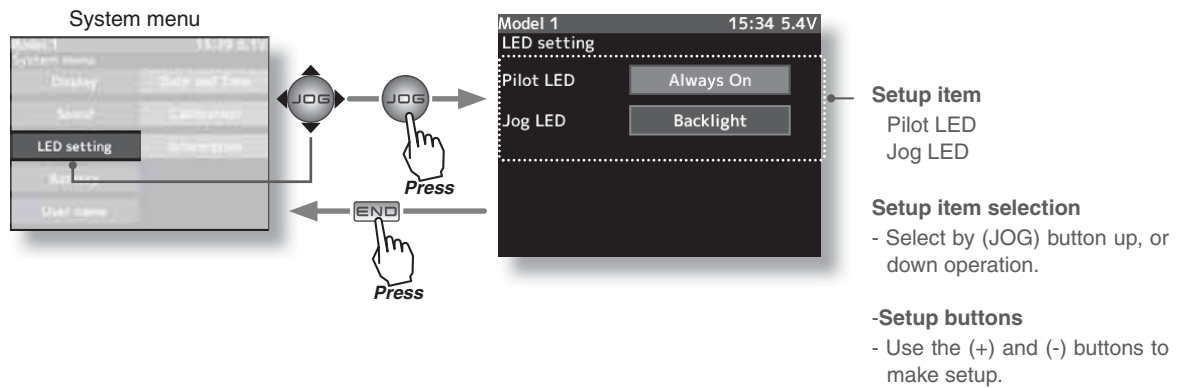

LED setting

1 (Setting pilot LED)

Select the "Pilot LED" to be set by (JOG) button operation, and use the (+) and (-) buttons to select the LED mode.

Pilot LED mode
Always On, OFF

2 (Setting Jog LED)

Select the "Jog LED" to be set by (JOG) button operation, and use the (+) and (-) to select the LED mode.

Jog LED mode
Backlight, Always On, OFF

3 When ending setting, return to the system menu screen by pressing the (END) button.

Function

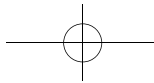

Battery Type Setting

With the T4PX, the low battery alarm setting is different, depending on the type of battery. Therefore, always set the battery type matched to the power supply to be used. When using a Futaba rechargeable type battery, always select "LiFe 2 cells" or "NiMH 5 cells". Incorrect setting will substantially shorten the time from low battery alarm to system stopping and is very dangerous.

Exceptionally, when using a battery other than this, select "Other" and set the low battery alarm voltage on your own responsibility. Futaba is not responsible for trouble caused by use of an unspecified battery.

This setting is displayed from the screen of the system menu. (p.144)

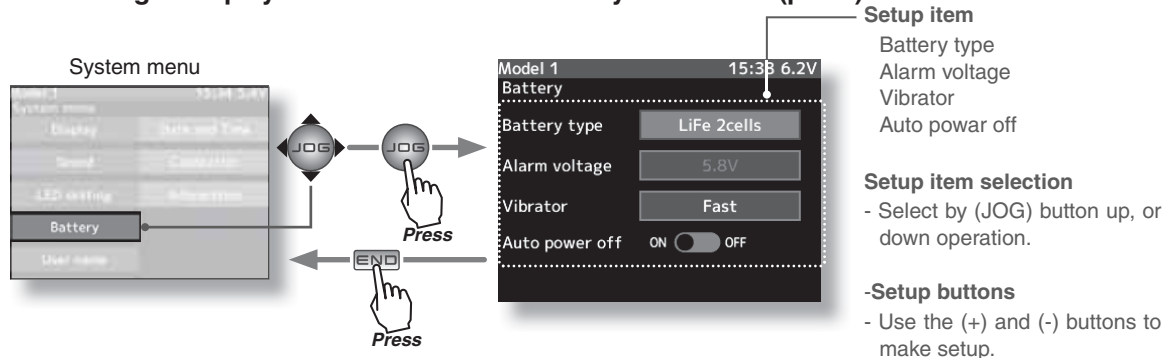

Battery setting

1 (Select battery type)

Select the "Battery type" to be set by (JOG) button operation, and use the (+) and (-) buttons to select the attery type.

Battery type

LiFe 2cells, NiMH 5cells, Other

2 (Setting low bwtttery alarm voltage)

When a specified battery was set by battery type, the alarm voltage is automatically set and cannot be adjusted. When "Other" was set by battery type, set the alarm voltage yourself. Select the "Alarm voltage" to be set by (JOG) button operation, and use the (+) and (-) to adjust the volutage.

Alarm voltagre (Other battery)

4.2V~8.0V
Initial value: 4.2V

3 (Select vibrator type)

Select the "Vibrator" to be set by (JOG) button operation, and use the (+) and (-) buttons to select the Vibrator type.

Vibrator tyape

Inhibit, Continuous, Slow, Fast

Select the vibrator type from among Inhibit, Continuous, Slow, and Fast. When vibration is not linked with the battery alarm, select "Inhibit".

Auto power off

ON, OFF

4 (Auto power off serjting)

Select the "Auto power of" to be set by (JOG) button operation. Set the function to the active state by pressing the (+) or (-) button.

5 When ending setting, return to the system menu screen by pressing the (END) button.

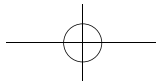

User Name

This function allows you to assign a 15 character name to each user name.

This setting is displayed from the screen of the system menu. (p.144)

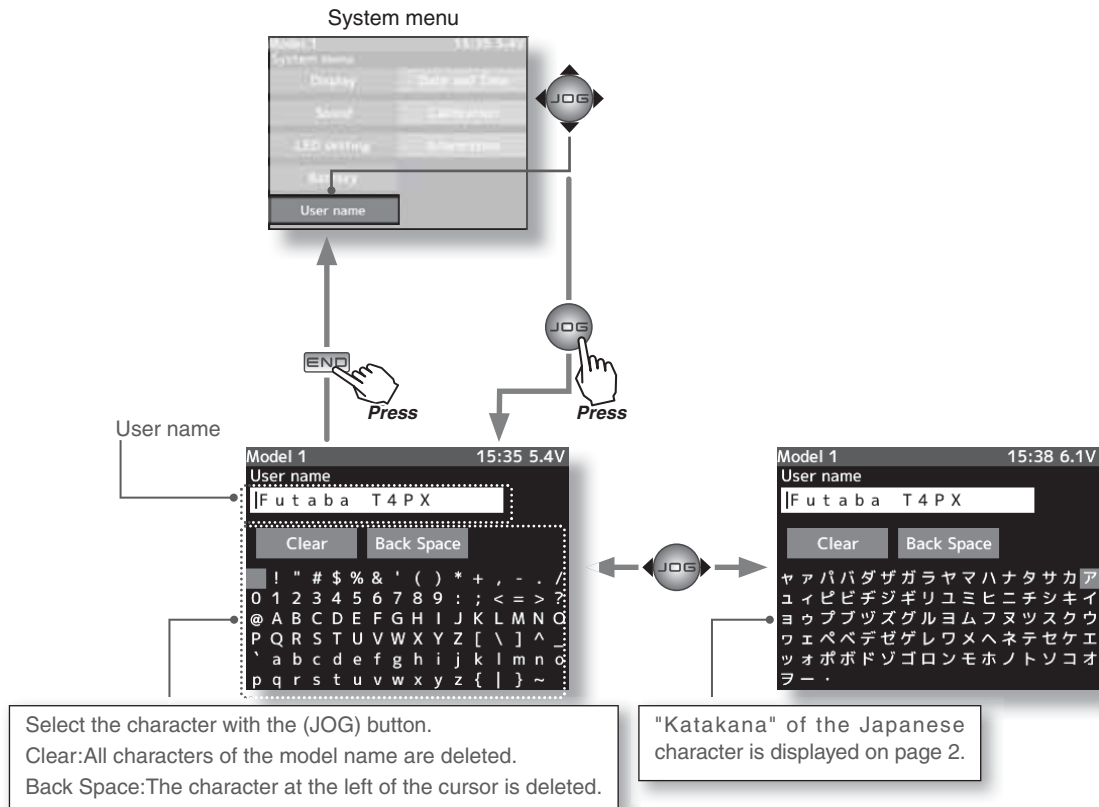

Setting the user name

- 1** (Moving the cursor to the character you want to change.)
"Move the cursor to the user name character you want to set or change by pressing the (+) or (-) button. The selected character blinks."
- 2** (Selecting the character to be used)
Move the cursor by (JOG) button up, down, left, or right operation, and select the characters to be used from the character list at the bottom of the screen. After deciding the characters to be used, press the (JOG) button. The characters are selected and the user name character string moves to the right. When "Back space" on the center row is selected and the (JOG) button is pressed, the character at the left of the vertical cursor is deleted. When "Clear" is selected and the (JOG) button is pressed, all the characters are deleted.
- 3** When ending setting, return to the system menu screen by pressing the (END) button.

Character select/set button

- Select the character by (JOG) button up, down, left, or right operation and enter the character by pressing the (JOG) button.

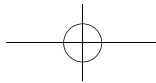

Data And Time

This function adjusts the system clock of the T4PX transmitter. Perform this setting when you purchase the set and when adjustment is necessary.

Whether the time or the total timer (accumulation timer) is displayed on the initial screen can be set. The total timer can be reset at this menu. When the total timer is displayed on the initial screen, it can also be reset at the initial screen.

This setting is displayed from the screen of the system menu. (p.144)

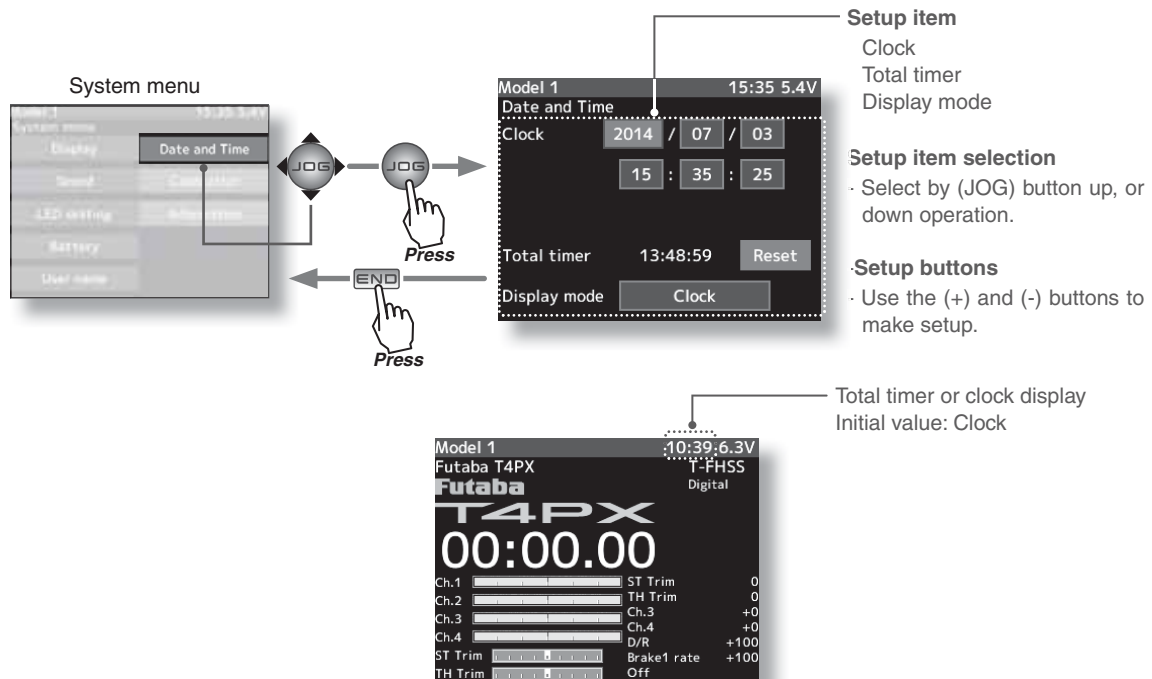

Date and time setting

1 (Date and time setting)

Select the "Year", "Month", "Day", "Hour", "Minute" or "Second" to be set by (JOG) button operation, and use the (+) and (-) buttons.

Select "Time adjust" by (JOG) button up, down, left, or right operation, and press the (JOG) button. The system clock is updated.



2 (Total time reset)

Select the "Reset" to be set by (JOG) button operation, and press the (JOG) button. The total time is reset.

3 (Select Display mode)

Select the "Display mode" to be set by (JOG) button operation, and use the (+) and (-) buttons to select the Display mode

4 When ending setting, return to the system menu screen by pressing the (END) button.

Information

System program version information, and selection of language.

This setting is displayed from the screen of the system menu. (p.144)

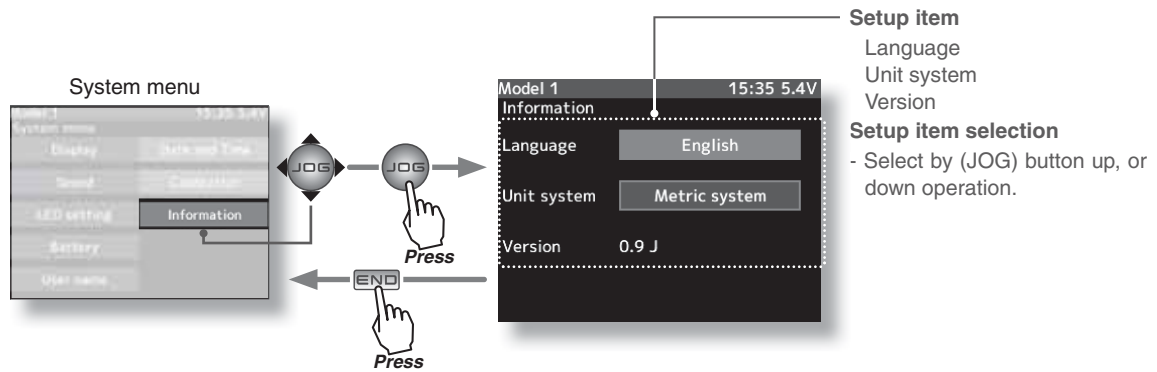

Menu screen of Japanese

Model 1	9:43	6.2V
メニュー	1/2	
モデルメニュー	アグレッション	ソフトポイント
カーブ(EXP)	アイトリップ	サブトリム
スピード	インテリカト	リバース
ミキシングメニュー	スタート	受信機設定
A.B.S.	テレメトリー	フェイルセーフ

Menu screen of German

Model1	0:33	6.5V
Menü	1/2	
Modell Menü	Beschleunig.	Endpunkt
Expo Kurve	Gasvorwahl	Sub Trim
Geschwindig.	Motor Aus	Servo Rev.
Mischer Menü	Start	Empfänger
A.B.S.	Telemetrie	Failsafe

Information

1 (Language setting)

Select "Language" by (JOG) button up operation and press the (JOG) key. A list of languages appears on the screen. Select "English", "Japanese", or "German" by (JOG) button up or down operation and press the (JOG) button. The language changes.

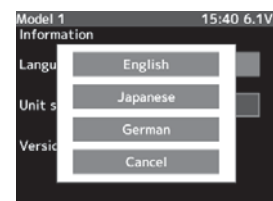

2 (Units system setting)

Select "Units system" by (JOG) button up or down operation and select the metric system or yard and pound system by pressing the (+) or (-) button.

3 When ending setting, return to the system menu screen by pressing the (END) button.

Function

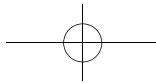

Calibration

Steering and throttle correction can be applied. Use this function when a mechanical offset has occurred for some reason.

However, if correction was applied, it may be necessary to recheck the set values of all the setup functions.

This setting is displayed from the screen of the system menu. (p.144)

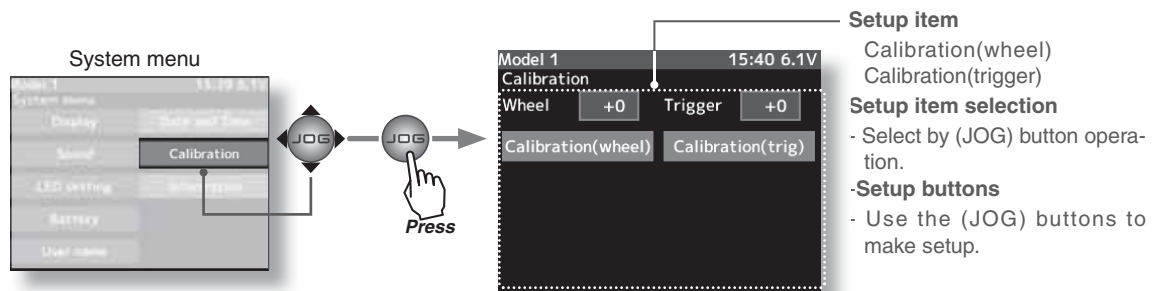

Steering adjustment

(Preparation)

Select "Wheel" (steering side) by (JOG) button left or right operation and press the (JOG) button. The neutral correction screen appears.

1 (Steering neutral adjustment)

After pulling the wheel was lightly to the left or right, press the (JOG) button in the state in which the wheel is not touched. If neutral correction is OK, the end point correction screen appears. If not within the correction range, the end point correction screen will not appear.

2 (Steering wheel travel adjustment)

In the end point correction screen (figure at the right) state, lightly turn the wheel fully to the left and right and press the (JOG) button. If end point correction is OK, the display returns to the adjuster screen. If the end point is not within the correction range, the display does not return to the adjuster screen. In this case, return to the system menu screen by pressing the (END) button. If operation cannot be ended normally even when correction is repeated, please contact the Futaba Service Center.

3 When ending setting, return to the system menu screen by pressing the (END) button.

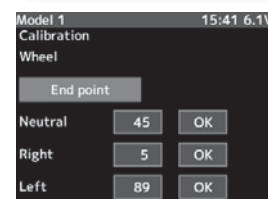
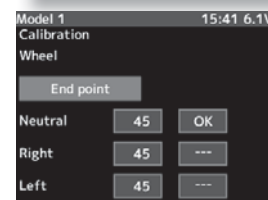
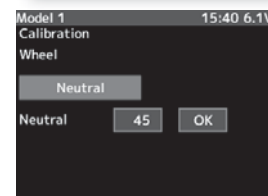

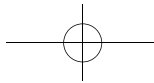

Throttle adjustment

(Preparation)

Select "Trigger" (throttle side) by (JOG) button left or right operation and press the (JOG) button. The neutral correction screen appears.



1 (Throttle neutral adjustment)

After lightly pulling the throttle trigger to the left and right, press the (JOG) button in the state in which the trigger is not touched. If neutral correction is OK, the end point correction screen appears. If not within the correction range, the end point correction screen will not appear.

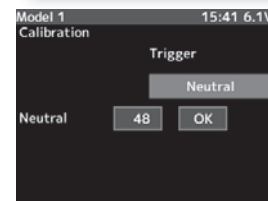

2 (Steering travel adjustment)

In the end point correction screen (figure at the right) state, lightly operate the trigger to the full forward and full brake side and press the (JOG) button. If end point correction is OK, the display returns to the adjuster screen. If not within the correction range, the display will not return to the adjuster screen. In this case, return to the system menu by pressing the (END) button. When operation cannot be ended normally even when correction is repeated, and cannot be ended normally, contact the Futaba Service Center.

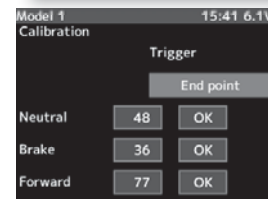
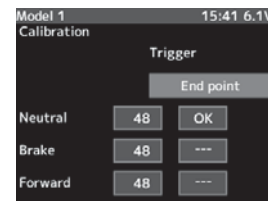

3 When ending setting, return to the system menu screen by pressing the (END) button.

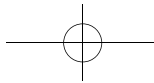

Steering Dual Rate/ Throttle ATL "D/R ATL"

D/R (Steering dual rate)

The steering left and right servo travels are adjusted simultaneously. This setting is linked to transmitter grip dial DT5. When DT5 is assigned another function, dual rate can be adjusted with this screen.

ATL (Brake1 rate)

This function decreases the set value when the braking effect is strong and increases the set value when the braking effect is weak. This function is linked to transmitter grip dial DT6. When DT6 is assigned another function, this function can be set with this screen.

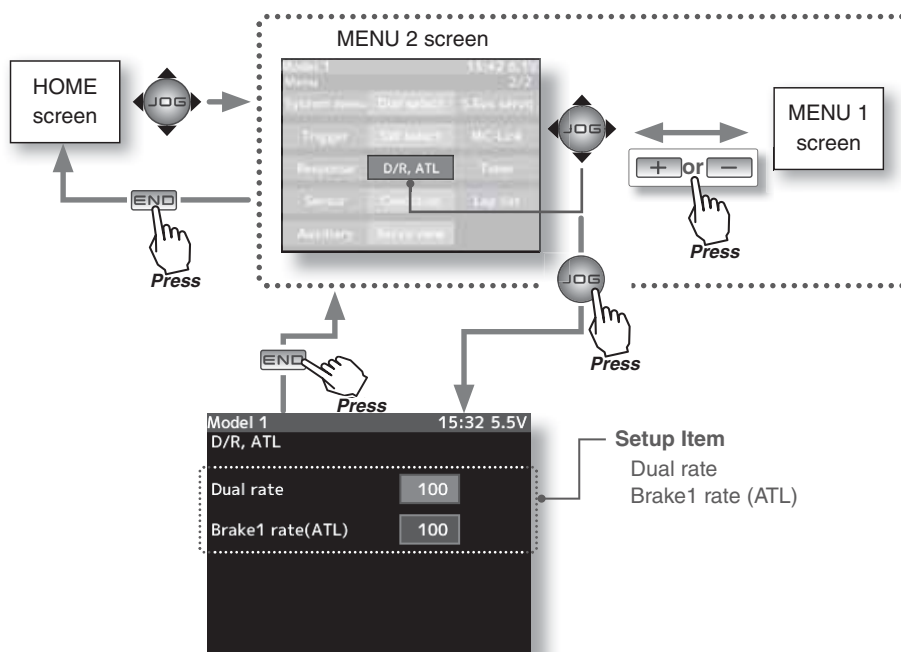

Dual rate adjustment

- 1 (Dual rate adjustment)
Select the setting item "Dual rate" or "Brake1 rate" by (JOG) button up or down operation. Adjust the servo travel with the (+) and (-) buttons.

This dual rate servo travel is linked to the grip trim.

- 2 When ending setting, return to the menu screen by pressing the (END) button.

Setup item selection

- Select by (JOG) button up or down operation.

Adjustment buttons

- Use the (+) and (-) buttons to make adjustments.
- Press the (+) and (-) buttons simultaneously (approx. 1 sec) to return to the initial screen.

D/R rate (RATE)

0~100%
Initial value: 100

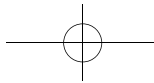

Auxiliary Channel "CH3", "CH4"

The channel 3/4 servo position can be set from the transmitter. When CH3 is assigned to a dial by the dial function (p.101), this setting is linked to that dial.

When CH3/4 is not assigned to a dial, it can be set with this screen.

When CH3/4 is assigned to a switch by the switch function (p.99), you cannot adjust the CH3/4 via the screen.

When CH3 or CH4 is assigned by mixing function, channel operation cannot be performed at this screen.

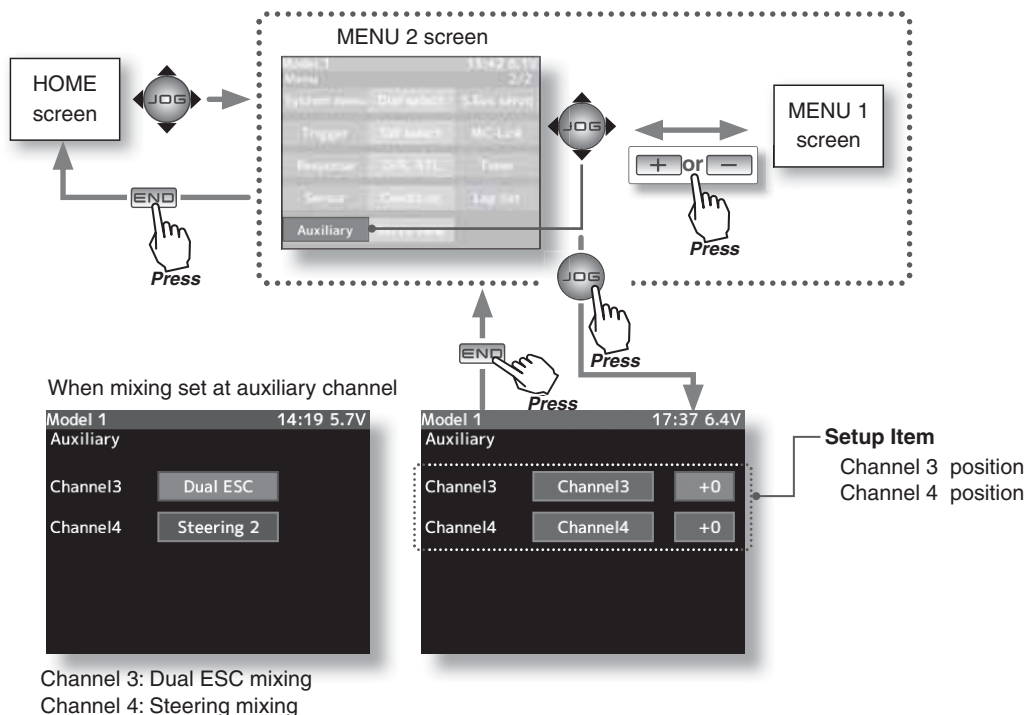

Channel 3/4 adjustment

- 1** (Position adjustment)
Use the (+) and (-) buttons to adjust the channel 3 or channel 4 position.
- 2** When ending setting, return to the initial screen by pressing the (END) button twice (for function menu screen, press the (END) button once).

Adjustment buttons

- Use the (+) and (-) buttons to make adjustments.
- Press the (+) and (-) buttons simultaneously (approx. 1 sec) to return to the initial screen

Channel 3 position (POSI)

Channel 4 position (POSI)

0~100%
Initial value: 100%

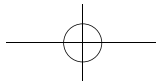

Servo View

Servo operation of each channel can be checked. Operation of the steering angle adjustment, when a mixing function was set, etc. can be easily checked.

The neutral position of the throttle channel varies depending on the modes defined by the "Trigger-Ratio". The screen shown below shows an example of "Forward50/Brake50" mode.

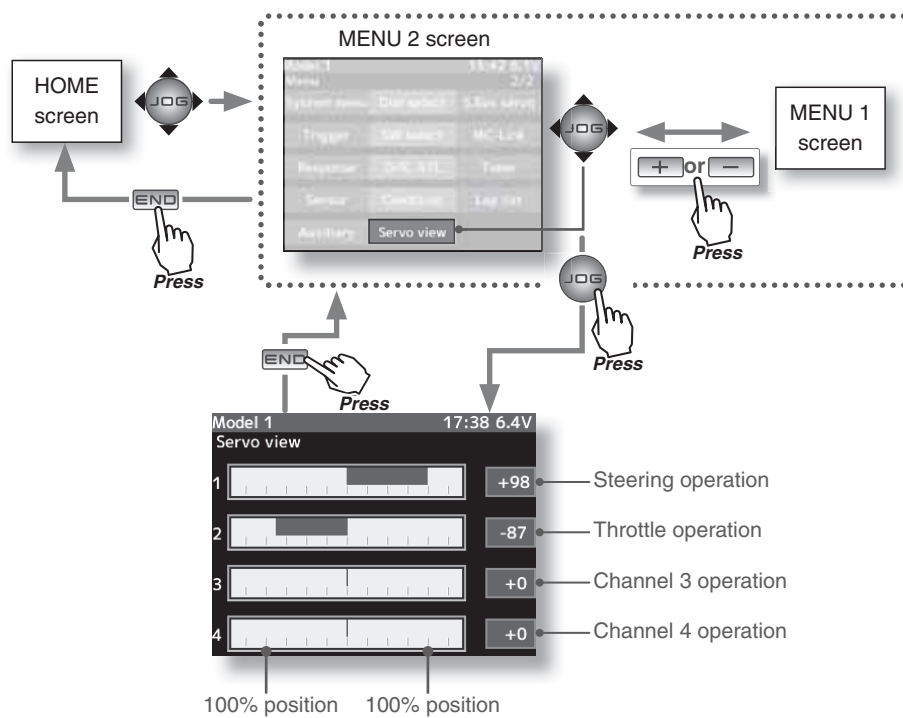

Function

Ending the "Servo view" screen

1 When ending servo operation checks, return to the menu screen by pressing the (END) button.

2 When ending setting, return to the menu screen by pressing the (END) button.

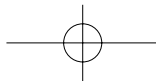

4PX

Reference

Specifications

*Specifications and ratings are subject to change without prior notice.

Transmitter T4PX

(Wheel system, 4 channels)

- Transmitting frequencies 2.4GHz band
- Futaba T-FHSS(R304SB/SB-E)/S-FHSS(R2104GF, R204GF-E/FASST-C2(R614FS/FF-E/FF, R604FS/FS-E)
- Power requirement
 - (Ni-MH battery) NT5F1700B Ni-MH battery (6V)
 - (LiFe battery) FT2F1700BV2 (6.6V)
- Current drain 300mA or less (When the T-FHSS, Vibration off, back lighting on)
- Transmitting antenna 1/2λdipole

Receiver R304SB / R304SB-E: (T-FHSS system, 4 channels)

Receiving frequency: 2.4GHz band

Power requirement: 4.8V~7.4V battery / 3.5 ~ 8.4V useable (Dry cell battery cannot be used.)

System: T-FHSS system (auto detection)

Size:

R304SB :1.38x0.91x0.33" (35.1x23.2x8.5mm) (excluding a projection part)

R304SB-E :1.38x0.91x0.49" (35.1x23.2x12.5mm)(excluding a projection part)

Weight: R304SB :0.23oz. (6.6g) / R304SB-E :0.24oz. (6.7g)

⚠ Caution

❶ When using the 4PX in the "Digital servo" type, always use it under the following conditions:

- Servos** :Futaba digital servo (including BLS Series brushless servos)
- Receiver's battery** :Matched to the ratings of the receiver and connected digital servo (dry cell battery cannot be used).
- Transmitter mode** :Digital servo type(See p.39 for setting method.)

Under other conditions, the set will not operate, or the specified performance will not be displayed even if it operates. In addition, it may cause servo trouble. Futaba will not be responsible for damage, etc. caused by combination with the products of other companies.

In addition, the FSU Fail Safe Unit cannot be used because the system is different. Use the fail safe function of the transmitter.

❷ When using analog servos, always switch the 4PX servo type to the "Analog servo" mode.

- Transmitter mode** :Analog servo type(See p.39 for setting method.)
- Receiver's battery** :Matched to the ratings of the receiver and connected servo.

The set cannot operate in the "Digital servo" type. Operation in this type will cause trouble with the servo and other equipment. Digital servos (including BLS Series brushless servos) can also be used in the "Analog servo" type.

Reference

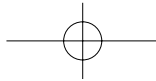

Optional Parts

The following parts are available as T4PX options. Purchase them to match your application. For other optional parts, refer to our catalog.

Transmitter Battery

When purchasing a transmitter battery use the following:

Part name

HT5F1800B (6V/1800mAh) Ni-MH battery

FT2F1700B(6.6V/1700mAh)/2100BV2 (6.6V/2100mAh) Li-Fe battery

Please do not use the transmitter batteries HT5F1800B and FT2F1700/2100BV2 as the receiver's battery.

T4PX Angle spacer

This Angle spacer is option part for T4PX. Angle of a steering wheel can be changed. Refer to the page 28 of this manual for means of attachment.

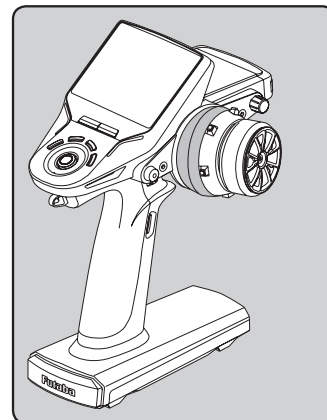
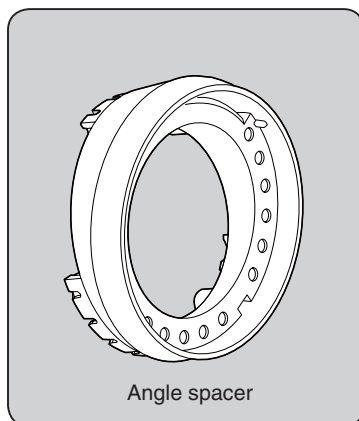

Large grip (for transmitter)

This handle grip is larger than the standard handle grip. It is perfect for those with large hands. Remove and replace the standard handle grip.

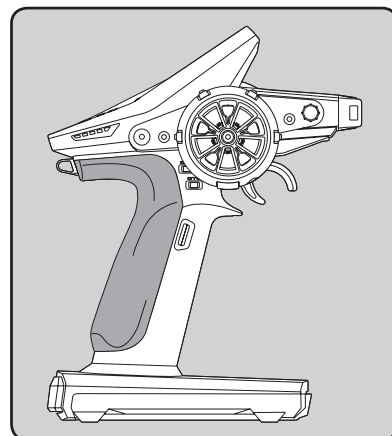

Reference

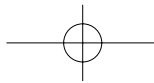

Carbon handle (for transmitter)

An optional carbon handle can be installed to the T4PX. Use the 2.0 hex wrench supplied with the 4PX set to install it. The flat head screws (3x10) are supplied with the optional carbon handle.

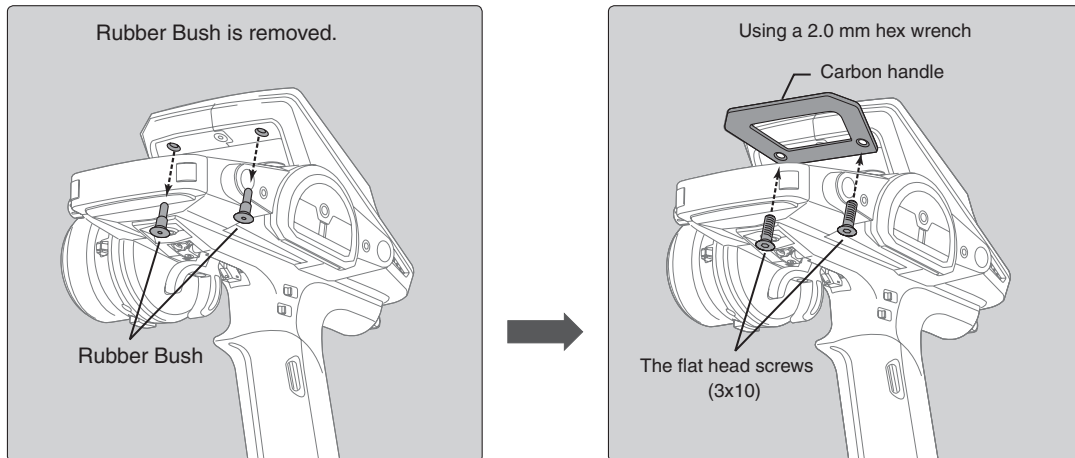

Telemetry sensors

Usable sensor options(As of June 2014)

Temperature sensor (SBS-01T) Perfect for engine head, etc.

Temperature sensor (SBS-01TE) Used by attaching to a motor, etc.

RPM Sensor (SBS-01RM) Measures speed over the 0 to 999,900rpm range.

Voltage Sensor (SBS-01V) Measures external power supply voltages up to 100V.

About data saved to microSD card

When a microSD card is installed in the T4PX transmitter, a folder called "Futaba" is created. Folders called "LOG" and "MODEL" are created in this folder. The "MODEL" folder stores the model data and the "LOG" folder stores the telemetry log data. When "Screen capture" is set at the push switch by switch setting, an image of the screen to be displayed on the T4PX is saved by that switch. The saved image is stored in a folder call "PICTURE". A "PICTURE" folder is not created until "Screen capture" is set.

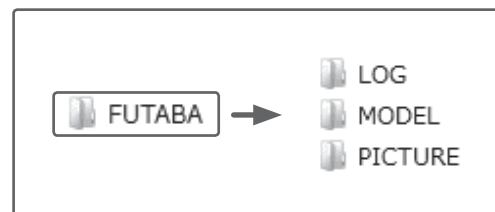

Reference

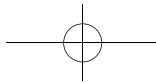

Warning Displays

Low Battery Alarm

If the transmitter battery voltage drops below the usable range, an audible alarm will sound and "Low battery" will be displayed. Since the usable range of LiFe and NiMH batteries and LiFe batteries is different, the power supply used must be set by system setting.(p.148)

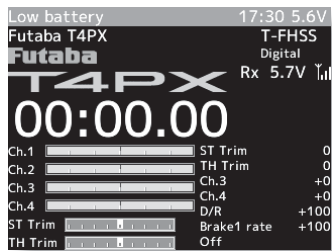

Audible alarm: Continuous tone.

The vibrator: Active (initial setting) page 148

Warning

① When a low battery alarm is generated, cease operation immediately and retrieve the model.

If the battery goes dead while in operation, you will lose control.

Power off forgotten alarm

At T4PX initialization, if steering wheel, throttle trigger, push switch, edit button, or other operation is not performed within 10 minutes, an audible alarm will sound and the message "Warning: Auto power off" will appear. If steering wheel, throttle trigger, push switch, edit button or other operation is performed, the alarm is reset. Also turn off the power when the transmitter is not in use. If you do not want to use this alarm and the auto power off function, they can be disabled by system setting. (p.148)

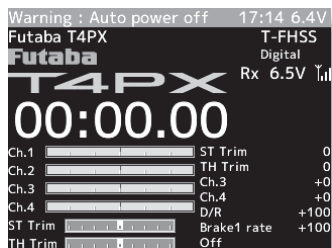

Audible alarm:

Tone sounds (7 times) and stops (repeated)

- If the alarm is not reset, the auto power off function will automatically turn off the power after 5 minutes.

MIX Warning

When the power switch is turned on while the idle-up, engine cut or neutral brake function switch is on, an audible alarm will sound and "Warning" will be displayed on the LCD. When that function switch is turned off, the alarm will stop.

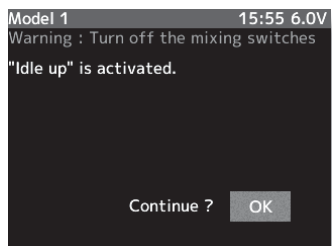

Audible alarm:

Tone sounds (7 times) and stops (repeated)

- The alarm stops even if the (JOG) button is pressed. However, check the function switch.

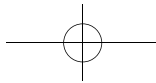

System Error

If the data is lost for an unknown reason, an audible alarm will sound and "System error" will be displayed on the LCD screen.

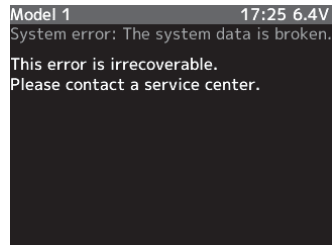

Audible alarm: Continuous tone.
The vibrator: Active (initial setting) page 148

Warning

- ❗ When a system error is generated, immediately stop using the system and request repair from the Futaba Service Center.
If you continue to use the system, the transmitter may malfunction and cause loss of control.

Backup Error

If the data in the transmitter is not transferred normally when the power is turned on, an audible alarm will sound and "Backup error" will be displayed on the LCD.

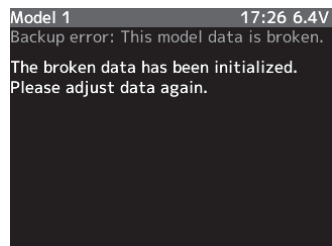

Audible alarm:
Tone sounds (7 times) and stops (repeated)

- To stop the alarm, turn off the power.
- Turn the power back on. If the alarm is not generated again, there is no problem.

RF Error

When the RF module does not operate, "RF Error" is displayed on the LCD.

If the power is turned on during charging, an RF error will be displayed and an audible alarm will sound. Immediately turn off the power.

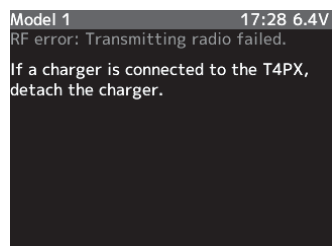

Audible alarm:
Tone sounds (7 times) and stops (repeated)

- To stop the alarm, turn off the power.
- Turn the power back on. If the alarm is generated again, request repair from the Futaba Service Center.

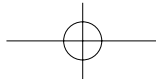

When requesting repair

Before requesting repair, read this instruction again and recheck your system. Should the problems continue, request as follows.

(Information needed for repair)

Describe the problem in as much detail as possible and send the letter along with the system in question.

- Symptom (Including the conditions and when the problem occurred)
- R/C System (Send transmitter, receiver and servos)
- Model (Type of model, brand name and model number or kit name)
- Detailed packing list (Make a list of all items sent in for repair)
- Your name, address and telephone number.

(Warranty)

Read the Warranty card.

- When requesting warranty service, send the card or some type of dated proof purchase.

When requesting repair

Before requesting repair, read this instruction again and recheck your system. Should the problems continue, request as follows.

(Information needed for repair)

Describe the problem in as much detail as possible and send the letter along with the system in question.

- Symptom (Including the conditions and when the problem occurred)
- R/C System (Send transmitter, receiver and servos)
- Model (Type of model, brand name and model number or kit name)
- Detailed packing list (Make a list of all items sent in for repair)
- Your name, address and telephone number.

(Warranty)

Read the Warranty card.

- When requesting warranty service, send the card or some type of dated proof purchase.

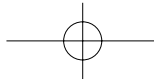

Federal Communications Commission Interference Statement (for U.S.A.)

This equipment has been tested and found to comply with the limits for a Class B digital device, pursuant to Part 15 of the FCC Rules. These limits are designed to provide reasonable protection against harmful interference in a residential installation.

This equipment generates, uses and can radiate radio frequency energy and, if not installed and used in accordance with the instructions, may cause harmful interference to radio communications. However, there is no guarantee that interference will not occur in a particular installation. If this equipment does cause harmful interference to radio or television reception, which can be determined by turning the equipment off and on, the user is encouraged to try to correct the interference by one or more of the following measures:

- Reorient or relocate the receiving antenna.
- Increase the separation between the equipment and receiver.
- Connect the equipment into an outlet on a circuit different from that to which the receiver is connected.
- Consult the dealer or an experienced radio/TV technician for help.

Compliance Information Statement (for U.S.A.)

This device, trade name Futaba Corporation, model number T4PX, complies with part 15 of the FCC Rules. Operation is subject to the following two conditions:

- (1) This device may not cause harmful interference, and (2) This device must accept any interference received, including interference that may cause undesired operation.
- (3) This module meets the requirements for a mobile device that may be used at separation distances of more than 20cm from human body. To meet the RF exposure requirements of the FCC this device shall not be co-located with another transmitting device.

The responsible party for the compliance of this device is:

Futaba Service Center

3002 N Apollo Drive Suite 1, Champaign, IL 61822 U.S.A

TEL (217)398-8970 or E-mail: support@futaba-rc.com (Support)

TEL (217)398-0007 or E-mail: futabaservice@hobbico.com (Service)

CAUTION:

To assure continued FCC compliance:

Any changes or modifications not expressly approved by the grantee of this device could void the user's authority to operate the equipment.

Exposure to Radio Frequency Radiation

To comply with FCC RF exposure compliance requirements, a separation distance of at least 20 cm must be maintained between the antenna of this device and all persons. This device must not be located or operating in conjunction with any other antenna or transmitter.

©Copyright 2010. No part of this manual may be reproduced in any form without prior permission. The contents of this manual are subject to change without prior notice. While this manual has been carefully written, there may be inadvertent errors or omissions. Please contact our service center if you feel that any corrections or clarifications should be made.

FUTABA CORPORATION Phone: +81 475 32 6982, Facsimile: +81 475 32 6983
1080 Yabutsuka, Chosei-mura, Chosei-gun, Chiba 299-4395, Japan

1M23N29402

©FUTABA CORPORATION 2014, 07 (1)

Reference

163