

Straubing, August 6, 2007

TEST - REPORT

No. 55503-070530 (Edition 2)

for

T2DR

Remote Control Transmitter

Applicant: Futaba Corporation

Test Specifications: FCC Code of Federal Regulations,
CFR 47, Part 95, Subpart C&E

FCC Code of Federal Regulations,
CFR 47, Part 2, Subpart J

Note:

The test data of this report is related only to the individual item which has been tested. This report shall not be reproduced except in full extent without the written approval of the testing laboratory.

Table of Contents

1	Description of the Equipment Under Test (EUT)	3
2	Administrative Data	4
3	Identification of the Test Laboratory	5
4	Summary	6
5	Operation Mode and Configuration of EUT.....	7
6	Measurement Procedures.....	8
6.1	Maximum Transmitter Power.....	8
6.2	Frequency tolerance.....	11
6.3	Emission Bandwidth	13
6.4	Unwanted Emission 30 MHz - 1 GHz	14
7	Photographs Taken During Testing	16
8	Test Results.....	19
8.1	Maximum transmitter power	20
8.2	Carrier Frequency Stability	22
8.3	Emission Bandwidth	25
8.4	Unwanted Radiation 30 MHz - 1 GHz.....	27
9	Referenced Regulations	31
10	Revision History	32
11	Additional Information supplementary to the Test Report.....	33

1 Description of the Equipment Under Test (EUT)

General data of EUT	
Type designation ¹ :	T2DR
Parts ² :	
Serial number(s):	A70124103
Manufacturer:	Futaba Corporation
Type of equipment:	Remote Control Transmitter
Version:	Series version
FCC ID:	
Additional parts/accessories:	No additional parts

Technical data of EUT	
Application frequency range:	75.410 MHz - 75.990 MHz
Frequency range:	75.410 MHz - 75.990 MHz
Operating frequency:	75.750 MHz
Type of modulation:	ASK
Pulse train:	Not Applicable
Pulse width:	Not Applicable
Number of RF-channels:	
Channel spacing:	
Designation of emissions ³ :	2k80A1D
Type of antenna:	Telescope antenna
Size/length of antenna:	83 cm
Connection of antenna:	<input type="checkbox"/> detachable <input checked="" type="checkbox"/> not detachable
Type of power supply:	DC supply
Specifications for power supply:	nominal voltage: 12.0 V minimum voltage: 10.2 V maximum voltage: 13.8 V nominal frequency: 0 Hz

¹ Type designation of the system if EUT consists of more than one part.

² Type designations of the parts of the system, if applicable.

³ Also known as "Class of Emission".

2 Administrative Data

Application details	
Applicant (full address):	Futaba Corporation 1080, Yabutsuka Chosei-mura, Chosei-gun, Chiba-ken 299-4395 Japan
Contact person:	Kazunori Fujita
Contract identification:	
Receipt of EUT:	June 25, 2007
Date(s) of test:	June 26, 2007
Note(s):	

Report details	
Report number:	55503-070530
Edition:	2
Issue date:	August 6, 2007

3 Identification of the Test Laboratory

Details of the Test Laboratory	
Company name:	Senton GmbH EMI/EMC Test Center
Address:	Aeussere Fruehlingstrasse 45 D-94315 Straubing Germany
Laboratory accreditation:	DAR-Registration No. DAT-P-171/94-02
FCC test site registration number	90926
Industry Canada test site registration:	IC 3050
Contact person:	Mr. Johann Roidt
	Phone: (+49) (0)9421 5522-0 Fax: (+49) (0)9421 5522-99

4 Summary

Summary of test results

The tested sample complies with the requirements set forth in the
Code of Federal Regulations CFR 47, Part 95, Subpart C & E
and the
Code of Federal Regulations CFR 47 Part 2, Subpart J
of the Federal Communication Commission (FCC).

Personnel involved in this report

Laboratory Manager:



Mr. Johann Roidt

Responsible for testing:



Mr. Thomas Eberl

Responsible for test report:

Mr. Thomas Eberl

5 Operation Mode and Configuration of EUT

Operation Mode(s)

Transmitting continuously with 75.75 MHz, modulation as indicated in appropriate test record.

Antenna extended to maximum. ⁴

Configuration(s) of EUT

The EUT was configured as stand alone device

List of ports and cables

<i>Port</i>	<i>Description</i>	<i>Classification⁵</i>	<i>Cable type</i>	<i>Cable length</i>
	Not Applicable			

List of devices connected to EUT

<i>Item</i>	<i>Description</i>	<i>Type Designation</i>	<i>Serial no. or ID</i>	<i>Manufacturer</i>
	Not Applicable			

List of support devices

<i>Item</i>	<i>Description</i>	<i>Type Designation</i>	<i>Serial no. or ID</i>	<i>Manufacturer</i>
	Not Applicable			

⁴ For radiated measurements only

⁵ Ports shall be classified as ac power, dc power or signal/control port

6 Measurement Procedures

6.1 Maximum Transmitter Power

The maximum transmitter power was measured conducted and radiated.

6.1.1 Conducted Maximum Transmitter Power

Measurement Procedure:

Rules and specifications: CFR 47 Part 95, section 95.639

Guide: CFR 47 Part 2, section 2.1046

Conducted output power is measured at the RF output terminals (e.g. antenna connector if antenna is detachable) when the transmitter is adjusted in accordance with the tune-up procedure, if applicable. The RF output terminals are connected to a spectrum analyzer and/or a power meter with appropriate sensor. If required, a resistive matching network equal to the impedance specified or employed for the antenna is used as well as dc block and appropriate attenuators (50 Ohms). The electrical characteristics of the radio frequency load attached to the output terminals shall be stated, if applicable.

If a spectrum analyzer is used and no other settings are specified resolution bandwidth shall be selected according to the carrier frequency f_c and set to 100 kHz. The video bandwidth shall be at least three times greater than the resolution bandwidth. The settings used have to be indicated within the appropriate test record(s).

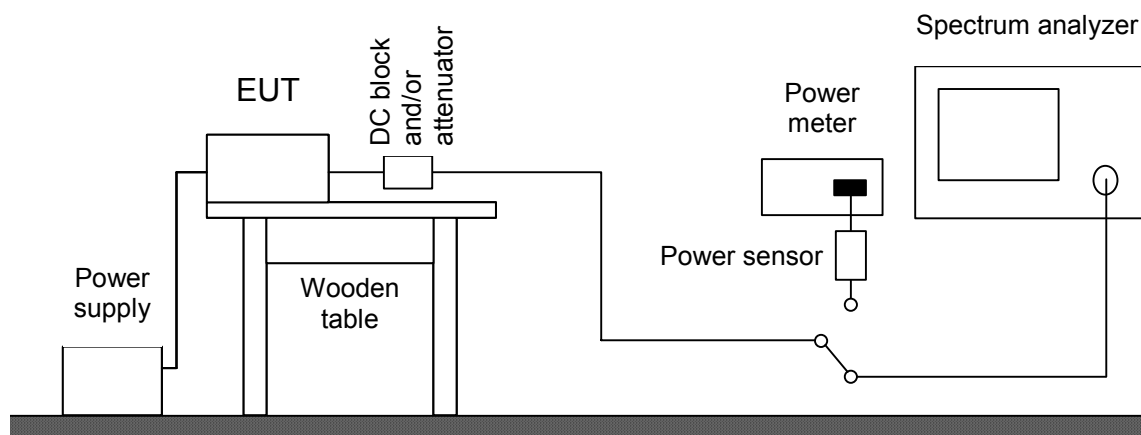

Test instruments used:

Used	Type	Model	Serial No. or ID	Manufacturer
<input type="checkbox"/>	Spectrum Analyzer	FSP 30	100063	Rohde & Schwarz
<input type="checkbox"/>	EMI test receiver	ESPI7	836914/0002	Rohde & Schwarz
<input type="checkbox"/>	EMI test receiver	ESMI	839379/013 839587/006	Rohde & Schwarz
<input checked="" type="checkbox"/>	Radio Communication Service Monitor	CMS 54	838384/030	Rohde & Schwarz
<input type="checkbox"/>	Power meter	NRVS	836856/015	Rohde & Schwarz
<input type="checkbox"/>	Peak power sensor	NRV-Z31	8579604.03	Rohde & Schwarz
<input type="checkbox"/>	Power sensor	NRV-Z52	837901/030	Rohde & Schwarz
<input type="checkbox"/>	Power sensor	NRV-Z4	863828/015	Rohde & Schwarz
<input checked="" type="checkbox"/>	DC-block	7006	A2798	Weinschel
<input type="checkbox"/>	Attenuator	4776-10	9412	Narda
<input type="checkbox"/>	Attenuator	4776-20	9503	Narda
<input checked="" type="checkbox"/>	Dummy Load	LD 01	001	Futaba

6.1.2 Radiated Maximum Transmitter Power

Measurement Procedure:

For measurement setup and procedure see section *Unwanted Emission 30 MHz - 1 GHz* (6.4)

6.2 Frequency tolerance

Measurement Procedure:	
Rules and specifications:	CFR 47 Part 95, section 95.623
Guide:	ANSI C63.4
<p>The frequency tolerance of the carrier signal is measured over a temperature variation of -30 °C to +50 °C at normal supply voltage, and for a variation in the primary supply voltage from 85% to 115% of the rated supply voltage at a temperature of +20 °C.</p> <p>If the EUT provides an antenna connector the spectrum analyzer is connected to this port. If required, a resistive matching network equal to the impedance specified or employed for the antenna is used as well as dc block and appropriate attenuators (50 Ohms). In cases where the EUT does not provide an antenna connector a test fixture is used.</p> <p>For battery operated equipment, the test is performed using a new battery. Alternatively, an external supply voltage can be used and is at least set to:</p> <ul style="list-style-type: none"> • the maximum battery voltage as delivered by a new battery or 115% of the battery nominal voltage • the battery nominal voltage • 85% of the battery nominal voltage • the battery operating end point voltage which shall be specified by the equipment manufacturer <p>The EUT is operating providing an unmodulated carrier. The peak detector of the spectrum analyzer is selected and resolution as well as video bandwidth are set to values appropriate to the shape of the spectrum of the EUT. The frequency counter mode of the spectrum analyzer is used to maximize the accuracy of the measured frequency tolerance.</p> <p>If an unmodulated carrier is not available a significant and stable point on the spectrum is selected and the span is reduced to a value that delivers an accuracy which shall be better than 1% of the maximum frequency tolerance allowed for the carrier signal. This method may be performed as long as the margin to the frequency tolerance allowed is larger than the uncertainty of the measured frequency tolerance.</p>	

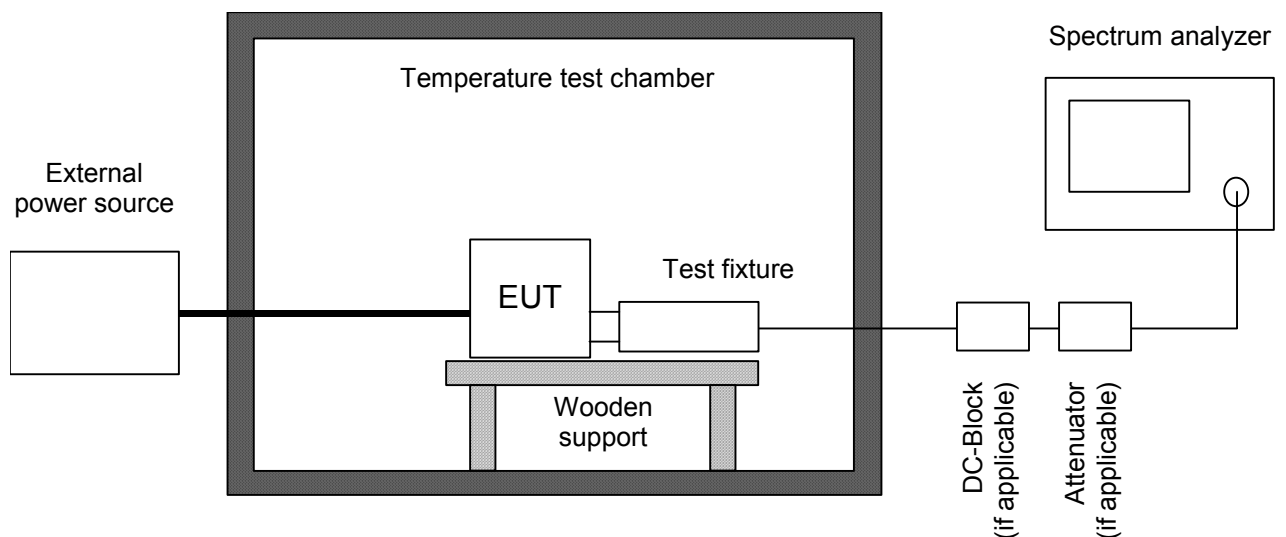

Test instruments used:

Used	Type	Model	Serial No. or ID	Manufacturer
<input checked="" type="checkbox"/>	Spectrum Analyzer	FSP 30	100063	Rohde & Schwarz
<input type="checkbox"/>	EMI test receiver	ESPI7	836914/0002	Rohde & Schwarz
<input type="checkbox"/>	EMI test receiver	ESMI	839379/013 839587/006	Rohde & Schwarz
<input checked="" type="checkbox"/>	Radio Communication Service Monitor	CMS 54	838384/030	Rohde & Schwarz
<input type="checkbox"/>	DC-block	7006	A2798	Weinschel
<input type="checkbox"/>	Attenuator	4776-10	9412	Narda
<input type="checkbox"/>	Attenuator	4776-20	9503	Narda
<input type="checkbox"/>	Test probe	TP01	001	Senton
<input checked="" type="checkbox"/>	DC power supply	NGSM 32/10	203	Rohde & Schwarz
<input type="checkbox"/>	Isolating transformer	RT 5A	10387	Grundig
<input type="checkbox"/>	Isolating transformer	RT 5A	10416	Grundig
<input checked="" type="checkbox"/>	Temperature test chamber	HT4010	07065550	Heraeus
<input checked="" type="checkbox"/>	Dummy Load	LD 01	001	Futaba

6.3 Emission Bandwidth

Measurement Procedure:	
Rules and specifications:	CFR 47 Part 2, section 2.1046(a)
Guide:	TIA/EI-603
<p>Emission bandwidth is measured at the RF output terminals (e.g. antenna connector if antenna is detachable) when the transmitter is adjusted in accordance with the tune-up procedure, if applicable. The RF output terminals are connected to a spectrum analyzer. If required, a resistive matching network equal to the impedance specified or employed for the antenna is used as well as dc block and appropriate attenuators (50 Ohms). The electrical characteristics of the radio frequency load attached to the output terminals shall be stated, if applicable.</p> <p>The occupied bandwidth measurement was performed referring to 99% of total power with RBW as close to, but not less than 1% of the 99% power bandwidth.</p>	

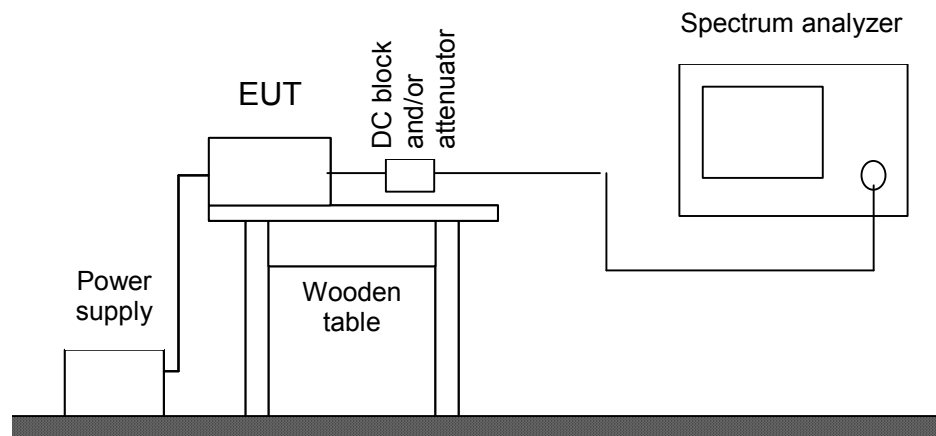

Test instruments used:

Used	Type	Model	Serial No. or ID	Manufacturer
<input checked="" type="checkbox"/>	Spectrum Analyzer	FSP 30	100063	Rohde & Schwarz
<input type="checkbox"/>	EMI test receiver	ESPI7	836914/0002	Rohde & Schwarz
<input type="checkbox"/>	EMI test receiver	ESMI	839379/013 839587/006	Rohde & Schwarz
<input type="checkbox"/>	Power meter	NRVS	836856/015	Rohde & Schwarz
<input type="checkbox"/>	Peak power sensor	NRV-Z31	8579604.03	Rohde & Schwarz
<input type="checkbox"/>	Power sensor	NRV-Z52	837901/030	Rohde & Schwarz
<input type="checkbox"/>	Power sensor	NRV-Z4	863828/015	Rohde & Schwarz
<input checked="" type="checkbox"/>	DC-block	7006	A2798	Weinschel
<input type="checkbox"/>	Attenuator	4776-10	9412	Narda
<input type="checkbox"/>	Attenuator	4776-20	9503	Narda
<input checked="" type="checkbox"/>	Dummy Load	LD 01	001	Futaba

6.4 Unwanted Emission 30 MHz - 1 GHz

Measurement Procedure:	
Rules and specifications:	CFR 47 Part 95, section 95.635
Guide:	ANSI C63.4 TIA/EIA-603, section 2.2.12
<p>Measurements are made in both the horizontal and vertical planes of polarization in a fully anechoic room using a spectrum analyzer with the detector function set to peak and resolution bandwidth set to 30 kHz, video bandwidth set to 100 kHz.</p> <p>Testing up to 1 GHz is performed with a linear polarized logarithmic periodic antenna combined with a 4:1 broadband dipole ("Trilog broadband antenna"). For testing above 1 GHz horn antennas are used.</p> <p>Hand-held or body-worn devices are rotated through three orthogonal axes to determine which attitude and configuration produces the highest emission relative to the limit and therefore shall be used for final testing.</p> <p>During testing the EUT is rotated all around to find the maximum levels of emissions. Equipment and cables are placed and moved within the range of position likely to find their maximum emissions.</p> <p>Final testing was performed referring to substitution method as described in TIA/EIA-603, section 2.2.12 ("Radiated Spurious Emissions").</p>	

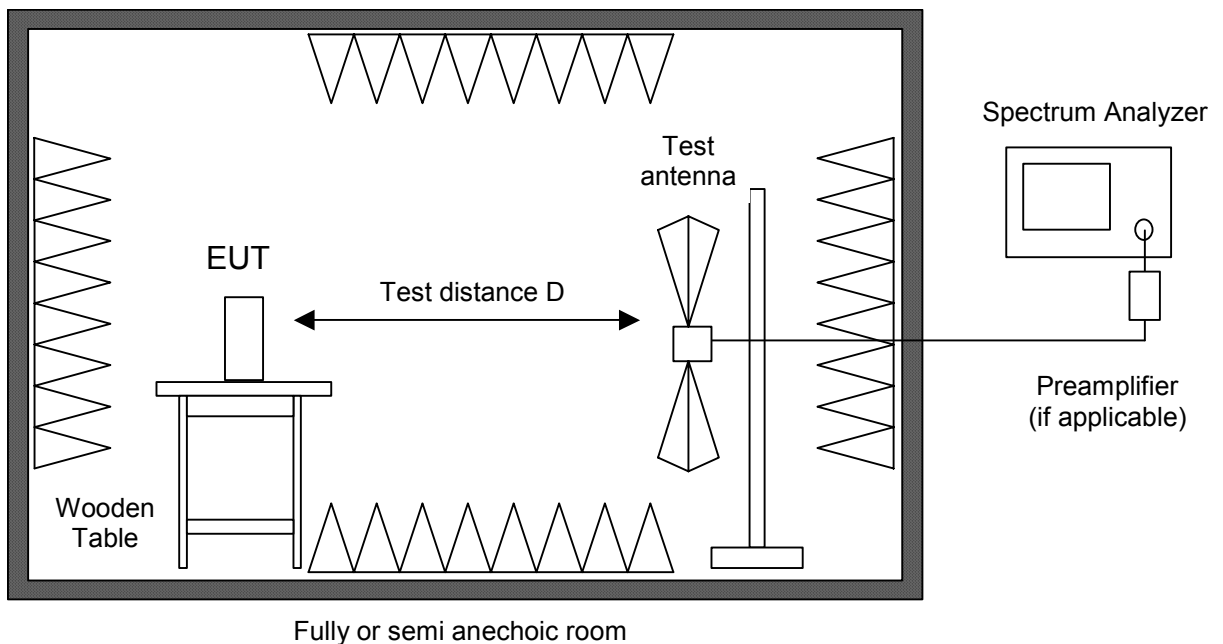

Test instruments used:

Used	Type	Model	Serial No. or ID	Manufacturer
<input checked="" type="checkbox"/>	Spectrum Analyzer	FSP 30	100063	Rohde & Schwarz
<input type="checkbox"/>	Spectrum analyzer	R 3271	05050023	Advantest
<input type="checkbox"/>	EMI test receiver	ESMI	839379/013 839587/006	Rohde & Schwarz
<input checked="" type="checkbox"/>	Preamplifier	CPA9231A	3393	Schaffner
<input type="checkbox"/>	Preamplifier	R14601		Advantest
<input type="checkbox"/>	Preamplifier 1-8 GHz	AFS3-00100800-32-LN	847743	Miteq
<input type="checkbox"/>	Preamplifier 0.5-8 GHz	AMF-4D-005080-25-13P	860149	Miteq
<input type="checkbox"/>	Preamplifier 8-18 GHz	ACO/180-3530	32641	CTT
<input type="checkbox"/>	External Mixer	WM782A	845881/005	Tektronix
<input type="checkbox"/>	Harmonic Mixer	FS-Z30	843389/007	Rohde & Schwarz
	Accessories			
<input checked="" type="checkbox"/>	Trilog broadband antenna	VULB 9163	9163-188	Schwarzbeck
<input type="checkbox"/>	Horn antenna	3115	9508-4553	EMCO
<input type="checkbox"/>	Horn antenna	3160-03	9112-1003	EMCO
<input type="checkbox"/>	Horn antenna	3160-04	9112-1001	EMCO
<input type="checkbox"/>	Horn antenna	3160-05	9112-1001	EMCO
<input type="checkbox"/>	Horn antenna	3160-06	9112-1001	EMCO
<input type="checkbox"/>	Horn antenna	3160-07	9112-1008	EMCO
<input type="checkbox"/>	Horn antenna	3160-08	9112-1002	EMCO
<input type="checkbox"/>	Horn antenna	3160-09	9403-1025	EMCO
<input type="checkbox"/>	Horn antenna	3160-10	399185	EMCO
<input checked="" type="checkbox"/>	Fully anechoic room	No. 2	1452	Albatross Projects
<input type="checkbox"/>	Semi-anechoic room	No. 3	1453	Siemens

7 Photographs Taken During Testing

**Test setup for radiated emission measurement
(fully anechoic room)**



**Test setup for radiated emission measurement
(fully anechoic room) - continued -**



8 Test Results

CFR 47 Part 95 Subpart C / E CFR 47 Part 2 Subpart J			
<i>Section(s):</i>	<i>Test</i>	<i>Page</i>	<i>Result</i>
95.639	Maximum transmitter power	20	Passed
95.623	Frequency tolerance	22	Passed
95.633	Emission bandwidth	25	Passed
95.635 (b) (1) (3) (7) (10) (11) (12)	Unwanted radiation 30 MHz - 1 GHz	27	Passed

8.1 Maximum transmitter power

8.1.1 Maximum transmitter power - Conducted

Rules and specifications:	CFR 47 Part 95, section 95.639(b)(3)
Guide:	CFR 47 Part 2, section 2.1046
Limit:	0.75 W in the 72 – 76 MHz frequency band
Measurement procedure:	Conducted Maximum Transmitter Power (6.1.1)

Comment:	
Date of test:	28 June, 2007
Test site:	Fully anechoic room, cabin no. 2
Test conditions:	Temperature + 20 °C Nominal supply voltage: 12.0 V
Specifications:	Voltage range: ±15 % of nominal supply voltage

Supply voltage (V)	Modulation	Transmitter power (dBm)	Transmitter power (W)	Limit (W)
10.20	off	18.20	0.066	0.750
12.00	off	19.04	0.080	0.750
13.80	off	19.65	0.092	0.750
10.20	on	18.20	0.066	0.750
12.00	on	19.02	0.080	0.750
13.80	on	19.70	0.093	0.750

Test Result:	Test passed
--------------	-------------

8.1.2 Maximum transmitter power - Radiated

Rules and specifications:	CFR 47 Part 95, section 95.635
Guide:	ANSI C63.4 TIA/EIA-603, section 2.2.12
Limit:	0.75 W (28.8 dBm) in the 72 – 76 MHz frequency band
Measurement procedure:	Radiated Maximum Transmitter Power (6.1.2)

Comment:	
Date of test:	26 June, 2007
Test site:	Fully anechoic room, cabin no. 2
Test conditions:	Temperature + 20 °C Nominal supply voltage: 12.0 V
Note:	For calculation of correction factors see table "Test Site Calibration Data Sheets", supplied as additional information summarized on page 33.

Position of EUT	Antenna polarization	Frequency (MHz)	Reading value (dBm)	Correction factor (dB)	E(I)RP (dBm)	Limit (dBm)	Margin to limit (dB)
EUT in vertical position, Antenna to the top	Horizontal	75.750	-26.7	26.3	-0.4	28.8	+29.2
EUT in vertical position, Antenna to the top	Vertical	75.750	-9.1	26.5	17.5	28.8	+11.3
EUT in horizontal position, Right side on table	Vertical	75.750	-20.1	26.5	6.5	28.8	+22.3
EUT in horizontal position, Right side on table	Horizontal	75.750	-10.4	26.3	16.0	28.8	+12.9
EUT in horizontal position, Rear side on table	Vertical	75.750	-17.6	26.5	9.0	28.8	+19.8
EUT in horizontal position, Rear side on table	Horizontal	75.750	-10.5	26.3	15.8	28.8	+13.0

Test Result:	Test passed
--------------	-------------

8.2 Carrier Frequency Stability

Rules and specifications:	CFR 47 Part 95, section 95.623(c)
Guide:	ANSI C63.4
Limit:	The frequency tolerance of the carrier signal shall be maintained within $\pm 0.002\%$ (± 20 ppm) of the carrier frequency under nominal conditions.
Temperature range:	-30°C to +50°C (at normal supply voltage)
Voltage range:	85% to 115% of the rated supply voltage (at a temperature of +20 °C)
Measurement procedure:	Frequency tolerance (6.2)

Comment:	
Mode:	Transmit mode
Date of test:	June 27, 2007

Test Result:	Test passed
--------------	-------------

8.2.1 Frequency Stability vs. Temperature

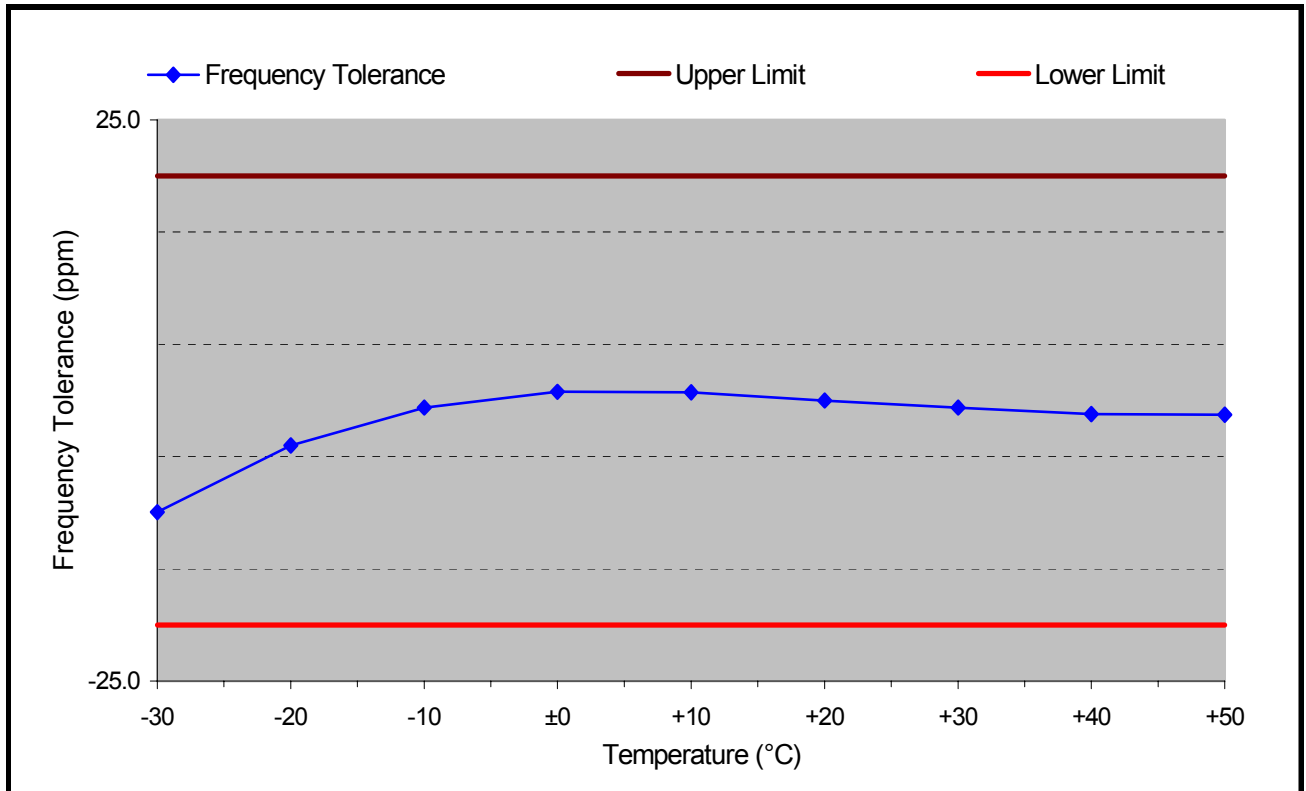

Supply voltage: 12 V Nominal frequency: 75.749839 MHz

Temperature (°C)	Frequency (MHz)	Frequency Tolerance (Hz)	Frequency Tolerance (ppm)	Upper Limit (ppm)	Lower Limit (ppm)	Margin (ppm)
-30	75.749086	-753	-9.9	+20.0	-20.0	10.1
-20	75.749535	-304	-4.0	+20.0	-20.0	16.0
-10	75.749791	-48	-0.6	+20.0	-20.0	19.4
±0	75.749898	59	0.8	+20.0	-20.0	19.2
+10	75.749894	55	0.7	+20.0	-20.0	19.3
+20	75.749839	0	0.0	+20.0	-20.0	20.0
+30	75.749790	-49	-0.6	+20.0	-20.0	19.4
+40	75.749747	-92	-1.2	+20.0	-20.0	18.8
+50	75.749743	-96	-1.3	+20.0	-20.0	18.7

Test Result: Test passed

8.2.2 Frequency Stability vs. Supply Voltage

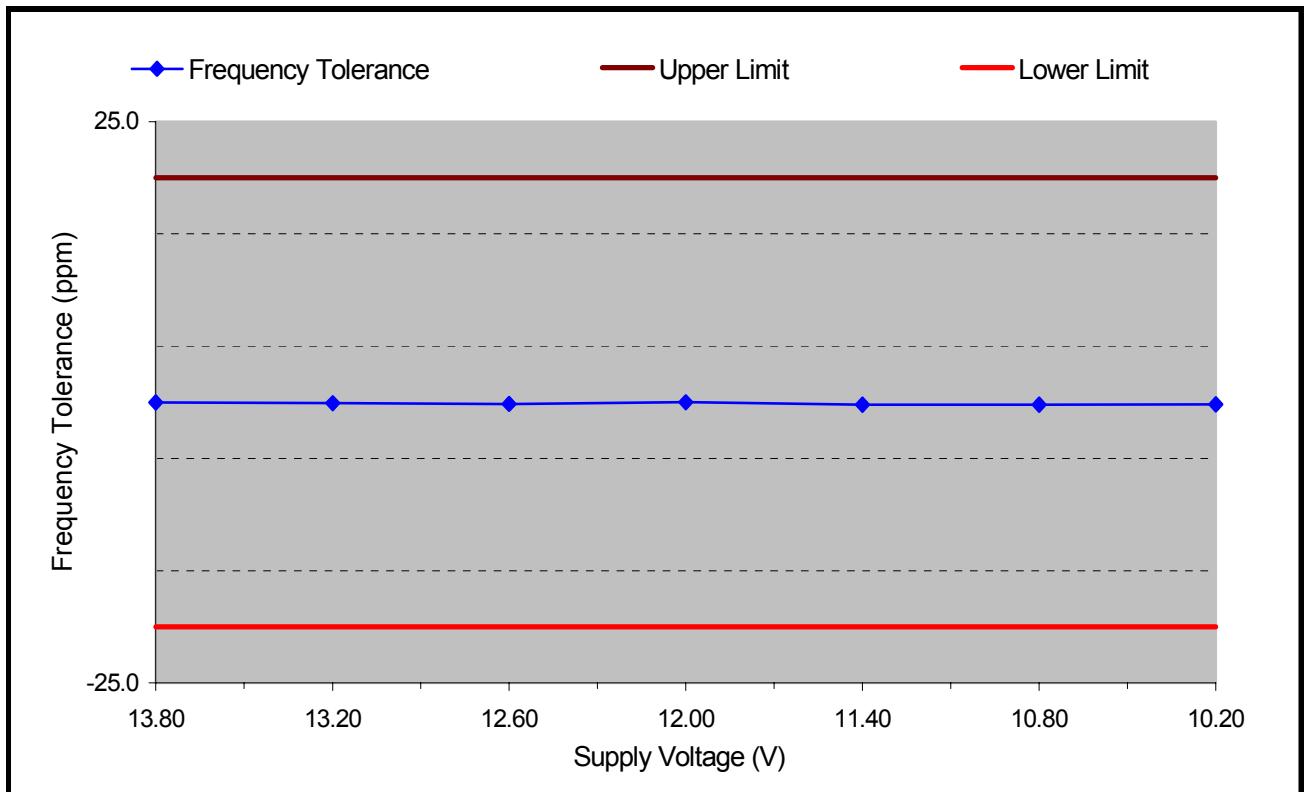

Temperature: +20 °C Battery End Point: 8.30 V
 Nominal frequency: 75.749849 MHz

Supply Voltage (V)	Frequency (MHz)	Frequency Tolerance (Hz)	Frequency Tolerance (ppm)	Upper Limit (ppm)	Lower Limit (ppm)	Margin (ppm)
13.80	75.749848	-2	0.0	+20.0	-20.0	20.0
13.20	75.749842	-7	-0.1	+20.0	-20.0	19.9
12.60	75.749838	-11	-0.1	+20.0	-20.0	19.9
12.00	75.749849	0	0.0	+20.0	-20.0	20.0
11.40	75.749832	-17	-0.2	+20.0	-20.0	19.8
10.80	75.749833	-16	-0.2	+20.0	-20.0	19.8
10.20	75.749835	-14	-0.2	+20.0	-20.0	19.8

Note: EUT is equipped with a low battery warning indicator, starting at 8.52 V

Test Result: Test passed

8.3 Emission Bandwidth

Rules and specifications:	CFR 47 Part 2, section 2.1046(a)
Guide:	TIA/EI-603
Limit:	Authorized bandwidth: 8 kHz
Measurement procedure:	Emission Bandwidth (6.3)

Calculation	$B_n = 2 \cdot B \cdot K$
B = modulation rage	B = 1.4kHz
K = Overall numerical factor	K = 1
	$B_n = 2 \cdot 1.4 \text{ kHz} \cdot 1 = 2.8 \text{ kHz}$
Type of Emission	2K80A1D

Test Result:	Test passed
--------------	-------------

Comment:
 Date of test: June 27, 2007



*RBW 300 Hz Marker 1 [T1 CNT] 18.54 dBm
 VBW 1 kHz
 SWT 560 ms 75.7498578 MHz

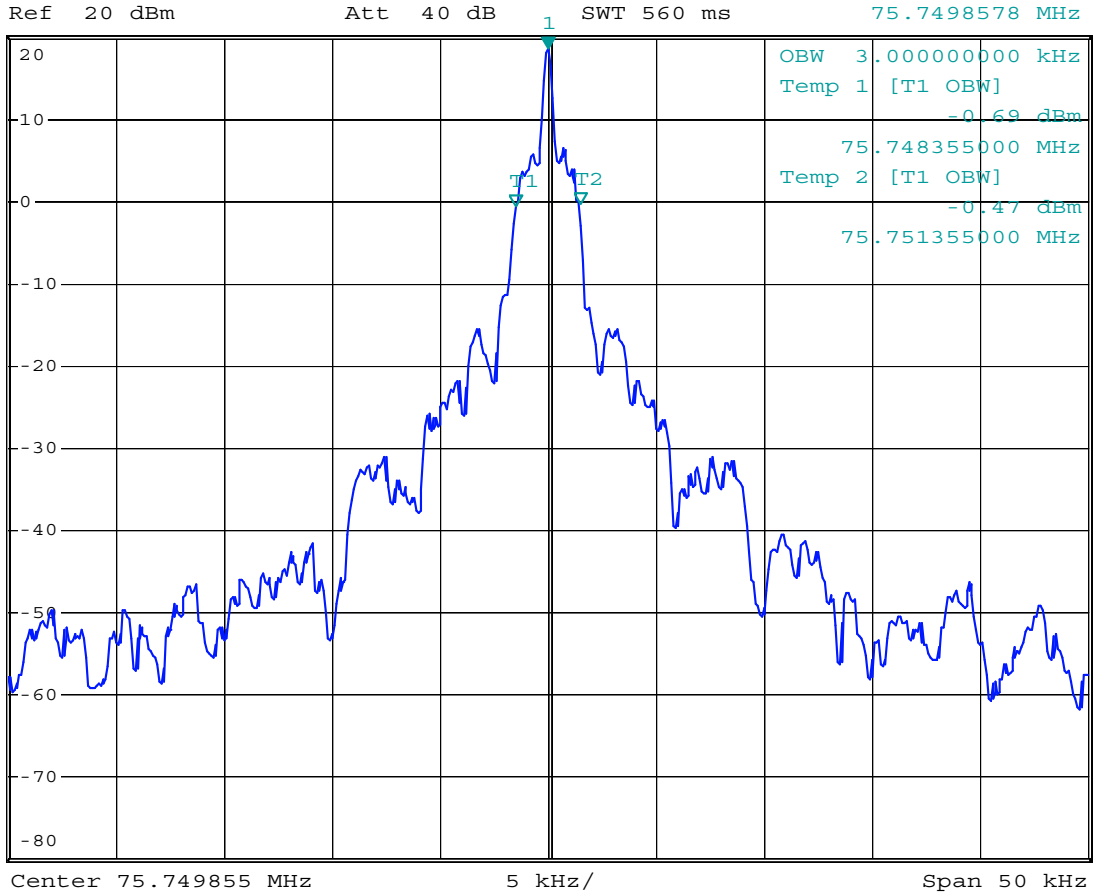

Date: 28.JUN.2007 08:30:34

Occupied Bandwidth (99 %): **3 kHz**

Test Result: Test passed

8.4 Unwanted Radiation 30 MHz - 1 GHz

Rules and specifications:	CFR 47 Part 95, section 95.635
Guide:	ANSI C63.4 TIA/EIA-603, section 2.2.12
Limit:	$10 \log(P_{\text{carrier}}) - 56 \text{ dB}$ with P_{carrier} as the maximum transmitter power limit in W for the unmodulated carrier according to §95.639 (b); that is -27.25 dBm .
Note	For calculation of correction factors see tables "Test Site Calibration Data Sheets"
Measurement procedure:	Unwanted Emission 30 MHz - 1 GHz (6.4)

Test Result:	Test passed
--------------	-------------

Position:	EUT in vertical position
Mode:	Transmit mode
Date of test:	26 June, 2007
Test site:	Fully anechoic room, cabin no. 2
Test distance:	3 meters

Maximum transmitter power (conducted):	19.04 dBm	0.080 W
Maximum transmitter power (radiated):	17.50 dBm	0.056 W
Calculated limit (referring to TP):	-27.25 dBm	

Frequency (MHz)	Antenna Polarization	Detector	Receiver Reading (dBm)	Correction Factor (dB)	Final Value (dBm)	Limit (dBm)	Margin (dB)
113.550	vertical	Peak	-85.6	25.6	-60.1	-27.3	32.8
151.600	horizontal	Peak	-79.9	20.6	-59.4	-27.3	32.1
151.700	vertical	Peak	-64.0	19.2	-44.8	-27.3	17.6
189.400	horizontal	Peak	-87.5	20.6	-66.9	-27.3	39.6
189.500	vertical	Peak	-80.8	20.5	-60.3	-27.3	33.0
227.200	vertical	Peak	-73.0	21.2	-51.8	-27.3	24.6
265.200	horizontal	Peak	-96.8	24.2	-72.6	-27.3	45.3
303.200	vertical	Peak	-96.5	27.6	-68.8	-27.3	41.6
340.800	vertical	Peak	-93.5	29.2	-64.3	-27.3	37.1
378.800	horizontal	Peak	-94.3	29.8	-64.5	-27.3	37.2
416.400	horizontal	Peak	-95.2	30.8	-64.4	-27.3	37.1
454.400	horizontal	Peak	-79.5	30.4	-49.1	-27.3	21.8
492.400	horizontal	Peak	-92.7	30.3	-62.5	-27.3	35.2
530.400	horizontal	Peak	-82.5	30.5	-52.0	-27.3	24.7
568.400	vertical	Peak	-91.7	32.0	-59.8	-27.3	32.5
606.000	horizontal	Peak	-82.5	31.9	-50.5	-27.3	23.3
643.600	vertical	Peak	-82.5	31.9	-50.6	-27.3	23.4
681.600	horizontal	Peak	-74.4	32.5	-41.9	-27.3	14.6
719.600	horizontal	Peak	-83.4	33.6	-49.9	-27.3	22.6
757.600	horizontal	Peak	-81.0	34.5	-46.5	-27.3	19.2
795.600	horizontal	Peak	-88.6	34.3	-54.3	-27.3	27.0
833.200	horizontal	Peak	-82.7	34.1	-48.6	-27.3	21.3
871.200	horizontal	Peak	-87.9	34.3	-53.6	-27.3	26.4
909.200	horizontal	Peak	-89.7	35.6	-54.1	-27.3	26.9
946.800	horizontal	Peak	-90.5	36.2	-54.3	-27.3	27.0
984.800	horizontal	Quasi-Peak	-94.9	35.2	-59.7	-27.3	32.5

Test Result:	Test passed
--------------	-------------

Position:	EUT in horizontal position (Right side on table)
Mode:	Transmit mode
Date of test:	26 June, 2007
Test site:	Fully anechoic room, cabin no. 2
Test distance:	3 meters

Maximum transmitter power (conducted):	19.04 dBm	0.080 W
Maximum transmitter power (radiated):	16.00 dBm	0.040 W
Calculated limit (referring to TP):	-27.25 dBm	

Frequency (MHz)	Antenna Polarization	Detector	Receiver Reading (dBm)	Correction Factor (dB)	Final Value (dBm)	Limit (dBm)	Margin (dB)
37.900	horizontal	Peak	-76.7	26.7	-50.0	-27.3	22.8
113.550	vertical	Peak	-93.0	25.6	-67.5	-27.3	40.2
113.600	horizontal	Peak	-85.8	26.6	-59.2	-27.3	31.9
151.600	horizontal	Peak	-63.6	20.6	-43.0	-27.3	15.8
151.700	vertical	Peak	-75.4	19.2	-56.2	-27.3	29.0
189.400	horizontal	Peak	-82.1	20.6	-61.5	-27.3	34.3
189.500	vertical	Peak	-85.4	20.5	-64.9	-27.3	37.7
227.200	horizontal	Peak	-72.5	22.1	-50.4	-27.3	23.2
265.200	horizontal	Peak	-92.4	24.2	-68.2	-27.3	40.9
303.200	horizontal	Peak	-86.5	25.8	-60.7	-27.3	33.5
340.800	horizontal	Peak	-83.7	28.1	-55.6	-27.3	28.4
378.800	horizontal	Peak	-88.7	29.8	-58.9	-27.3	31.7
416.400	horizontal	Peak	-89.3	30.8	-58.4	-27.3	31.2
454.400	horizontal	Peak	-76.5	30.4	-46.1	-27.3	18.9
492.400	vertical	Peak	-87.2	28.9	-58.4	-27.3	31.1
530.400	vertical	Peak	-78.2	30.3	-47.9	-27.3	20.7
568.400	vertical	Peak	-92.0	32.0	-60.1	-27.3	32.8
606.000	vertical	Peak	-79.5	33.1	-46.4	-27.3	19.2
643.600	horizontal	Peak	-80.7	31.8	-48.9	-27.3	21.6
681.600	vertical	Peak	-71.8	31.3	-40.5	-27.3	13.2
719.600	vertical	Peak	-79.4	31.9	-47.5	-27.3	20.2
757.600	vertical	Peak	-77.6	33.4	-44.2	-27.3	17.0
795.600	vertical	Peak	-85.8	35.0	-50.8	-27.3	23.6
833.200	vertical	Peak	-84.1	35.4	-48.8	-27.3	21.5
871.200	vertical	Peak	-86.2	35.9	-50.3	-27.3	23.1
909.200	horizontal	Peak	-89.4	35.6	-53.9	-27.3	26.6
946.800	horizontal	Peak	-89.7	36.2	-53.5	-27.3	26.3
984.800	horizontal	Peak	-94.1	36.6	-57.5	-27.3	30.3

Test Result:	Test passed
--------------	-------------

Position:	EUT in horizontal position (Rear side on table)
Mode:	Transmit mode
Date of test:	26 June 2007
Test site:	Fully anechoic room, cabin no. 2
Test distance:	3 meters

Maximum transmitter power (conducted):	19.04 dBm	0.080 W
Maximum transmitter power (radiated):	15.80 dBm	0.038 W
Calculated limit (referring to TP):	-27.25 dBm	

Frequency (MHz)	Antenna Polarization	Detector	Receiver Reading (dBm)	Correction Factor (dB)	Final Value (dBm)	Limit (dBm)	Margin (dB)
37.900	horizontal	Peak	-77.1	26.7	-50.4	-27.3	23.1
113.550	vertical	Peak	-97.3	25.6	-71.8	-27.3	44.5
113.600	horizontal	Peak	-90.0	26.6	-63.4	-27.3	36.2
151.600	horizontal	Peak	-64.9	20.6	-44.4	-27.3	17.1
151.700	vertical	Peak	-77.2	19.2	-58.0	-27.3	30.7
189.400	horizontal	Peak	-78.5	20.6	-58.0	-27.3	30.7
189.500	vertical	Peak	-87.4	20.5	-66.9	-27.3	39.6
227.200	horizontal	Peak	-70.1	22.1	-48.0	-27.3	20.8
265.200	horizontal	Peak	-90.5	24.2	-66.3	-27.3	39.0
303.200	horizontal	Peak	-80.1	25.8	-54.3	-27.3	27.0
340.800	horizontal	Peak	-84.4	28.1	-56.3	-27.3	29.1
378.800	horizontal	Peak	-87.0	29.8	-57.1	-27.3	29.9
416.400	horizontal	Peak	-87.1	30.8	-56.3	-27.3	29.0
454.400	horizontal	Peak	-75.6	30.4	-45.2	-27.3	17.9
492.400	horizontal	Peak	-88.2	30.3	-57.9	-27.3	30.7
530.400	horizontal	Peak	-76.3	30.5	-45.8	-27.3	18.5
568.400	horizontal	Peak	-89.3	31.1	-58.2	-27.3	30.9
606.000	horizontal	Peak	-77.7	31.9	-45.7	-27.3	18.5
643.600	horizontal	Peak	-80.9	31.8	-49.1	-27.3	21.9
681.600	horizontal	Peak	-69.2	32.5	-36.7	-27.3	9.4
719.600	horizontal	Peak	-78.7	33.6	-45.1	-27.3	17.9
757.600	horizontal	Peak	-75.6	34.5	-41.1	-27.3	13.9
795.600	horizontal	Peak	-86.4	34.3	-52.1	-27.3	24.9
833.200	horizontal	Peak	-81.0	34.1	-46.9	-27.3	19.7
871.200	horizontal	Peak	-84.1	34.3	-49.8	-27.3	22.6
909.200	horizontal	Peak	-88.8	35.6	-53.2	-27.3	25.9
946.800	horizontal	Peak	-88.3	36.2	-52.1	-27.3	24.9
984.800	horizontal	Peak	-91.1	36.6	-54.5	-27.3	27.2

Test Result:	Test passed
--------------	-------------

9 Referenced Regulations

All tests were performed with reference to the following regulations and standards:

<input checked="" type="checkbox"/>	CFR 47 Part 2	Code of Federal Regulations Part 2 (Frequency allocation and radio treaty matters; General rules and regulations) of the Federal Communication Commission (FCC)	October 1, 2006
<input checked="" type="checkbox"/>	CFR 47 Part 95 Subpart C/E	Code of Federal Regulations Part 95 (Personal Radio Services), Subpart C/E (Radio Control(R/C) Radio Service) of the Federal Communication Commission (FCC)	October 1, 2003
<input checked="" type="checkbox"/>	ANSI C63.4	American National Standard for Methods of Measurement of Radio-Noise Emissions from Low-Voltage Electrical and Electronic Equipment in the Range of 9 kHz to 40 GHz	December 11, 2003 (published on January 30, 2004)
<input type="checkbox"/>	RSS-210	Radio Standards Specification RSS-210 Issue 7 for Low Power Licence-Exempt Radiocommunication Devices (All Frequency Bands): Category I Equipment, published by Industry Canada	June 2007
<input type="checkbox"/>	RSS-102	Radio Standards Specification RSS-102 Issue 2: Radio Frequency Exposure Compliance of Radiocommunication Apparatus (All Frequency Bands)	November 2005
<input type="checkbox"/>	ICES-003	Interference-Causing Equipment Standard ICES-003 Issue 4 for Digital Apparatus, published by Industry Canada	February 2004
<input type="checkbox"/>	CISPR 22	Third Edition of the International Special Committee on Radio Interference (CISPR), Pub. 22, "Information Technology Equipment – Radio Disturbance Characteristics – Limits and Methods of Measurement"	1997
<input type="checkbox"/>	CAN/CSA-CEI/IEC CISPR 22	Limits and Methods of Measurement of Radio Disturbance Characteristics of Information Technology Equipment	2002
<input type="checkbox"/>	TIA/EIA-603 Revision C	Land Mobile FM or PM Communications Equipment Measurement and Performance Standards	August 17, 2004
<input type="checkbox"/>	TRC-43	Notes Regarding Designation of Emission (Including Necessary Bandwidth and Classification), Class of Station and Nature of Service, published by Industry Canada	October 9, 1982

10 Revision History

<i>Revision</i>	<i>Date</i>	<i>Issued by</i>	<i>Modifications</i>
000	July 2, 2007	Thomas Eberl (cj)	First edition
001	August 6, 2007	C. Jäger	Edition 2 Modification required for FCC Certification Page 27 to 30 / 8.4 Unwanted Radiation 30 MHz - 1 GHz Limit changed: -27.25 dBm

11 Additional Information supplementary to the Test Report

Item	Description	No. of Pages
1	Test Site Calibration Data Sheets	4
2	Charts taken during testing	12

Test Site Calibration 25 MHz - 1 GHz for ERP Measurements (Substitution Method)

Test site: Fully anechoic room, cabin no. 2
 Test distance: Standard position [m]: 3.5
 Date: 11/07/2003
 Operator: J. Roidt
 Transmit antennae: Biconical antenna HK 116, Rohde & Schwarz, inv.-no. A-1261
 Log.-per. antenna HL 223, Rohde & Schwarz, inv.-no. A-1262
 Horn antenna EMCO 3115, EMCO, inv.-no. B-1516
 Receiving antenna: Trilog Antenna VULB 9163
 Signal source: SMY 01, Rohde & Schwarz, inv.-no. A-1627,
 connected to transmit antenna via cables inv.-no. 1683, port 2 of AP 1
 and 1657, nominal power at signal generator set to 0 dBm
 Receiving cables: Inv.-no. 1656, 1681 and 1592
 Test receiver: FSP 30, Rohde & Schwarz, inv.-no. A-1666
 Antenna heights: TX antenna (h1): 1.5 metre
 RX antenna (h2): 1.5 metre
 Antenna position: TX antenna: center of turn table
 Polarization: horizontal

Frequency [MHz]	Transmit signal P tx [dBm]	TX antenna gain		True transmit signal P true [dBm]	Analyzer reading P site [dBm]	Attenuation RELAX Matrix [dB]	Correction for reading in "dBm" [dB]
		(isotropic) [dBi]	(dipole) [dBd]				
25.0	-0.7	-17.0	-19.2	-19.8	-44.6	0.1	24.8
30.0	-0.9	-13.8	-16.0	-16.9	-39.6	0.1	22.8
35.0	-1.0	-11.1	-13.3	-14.3	-39.0	0.1	24.9
40.0	-1.0	-8.8	-11.0	-12.0	-39.8	0.2	27.9
45.0	-1.1	-6.7	-8.9	-10.0	-41.5	0.2	31.7
50.0	-1.1	-5.1	-7.3	-8.4	-39.3	0.1	31.0
55.0	-1.2	-3.8	-6.0	-7.1	-39.2	0.1	32.2
60.0	-1.2	-2.8	-5.0	-6.2	-37.0	0.2	31.0
65.0	-1.2	-2.0	-4.2	-5.4	-35.5	0.2	30.3
70.0	-1.3	-1.3	-3.5	-4.7	-32.1	0.2	27.6
75.0	-1.2	-0.7	-2.9	-4.1	-30.3	0.2	26.4
80.0	-1.3	-0.1	-2.3	-3.6	-29.3	0.2	25.9
85.0	-1.4	0.2	-2.0	-3.3	-31.3	0.2	28.1
90.0	-1.4	0.5	-1.7	-3.1	-31.2	0.2	28.3
95.0	-1.5	0.6	-1.6	-3.0	-32.2	0.3	29.4
100.0	-1.4	0.7	-1.5	-2.9	-30.5	0.3	27.9
110.0	-1.5	0.9	-1.3	-2.8	-29.0	0.3	26.6
120.0	-1.5	1.0	-1.2	-2.7	-27.5	0.3	25.1
130.0	-1.6	1.1	-1.1	-2.6	-25.5	0.3	23.2
140.0	-1.7	1.4	-0.8	-2.4	-24.1	0.3	22.0
150.0	-1.7	1.8	-0.4	-2.0	-22.4	0.3	20.7
160.0	-1.7	1.9	-0.3	-2.0	-21.3	0.4	19.7
170.0	-1.8	2.0	-0.2	-1.9	-21.0	0.3	19.4
180.0	-1.8	2.1	0.0	-1.9	-20.9	0.4	19.4
190.0	-1.9	2.3	0.2	-1.8	-22.1	0.4	20.7
200.0	-1.7	2.3	0.2	-1.6	-22.4	0.4	21.2
200.1	-1.8	6.5	4.4	2.5	-18.5	0.4	21.5
220.0	-2.1	6.9	4.8	2.7	-18.5	0.4	21.5
240.0	-2.2	7.0	4.9	2.7	-20.0	0.4	23.0

Test Site Calibration 25 MHz - 1 GHz for ERP Measurements (Substitution Method)

Test site: Fully anechoic room, cabin no. 2
 Test distance: Standard position [m]: 3.5
 Date: 11/07/2003
 Operator: J. Roidt
 Transmit antennae: Biconical antenna HK 116, Rohde & Schwarz, inv.-no. A-1261
 Log.-per. antenna HL 223, Rohde & Schwarz, inv.-no. A-1262
 Horn antenna EMCO 3115, EMCO, inv.-no. B-1516
 Receiving antenna: Trilog Antenna VULB 9163
 Signal source: SMY 01, Rohde & Schwarz, inv.-no. A-1627,
 connected to transmit antenna via cables inv.-no. 1683, port 2 of AP 1
 and 1657, nominal power at signal generator set to 0 dBm
 Receiving cables: Inv.-no. 1656, 1681 and 1592
 Test receiver: FSP 30, Rohde & Schwarz, inv.-no. A-1666
 Antenna heights: TX antenna (h1): 1.5 metre
 RX antenna (h2): 1.5 metre
 Antenna position: TX antenna: center of turn table
 Polarization: horizontal

Frequency [MHz]	Transmit signal P tx [dBm]	TX antenna gain		True transmit signal P true [dBm]	Analyzer reading P site [dBm]	Attenuation RELAX Matrix [dB]	Correction for reading in "dBm" [dB]
		(isotropic) [dBi]	(dipole) [dBd]				
260.0	-2.2	7.1	5.0	2.7	-20.9	0.4	24.0
280.0	-2.4	7.3	5.1	2.8	-21.5	0.4	24.7
300.0	-2.4	7.2	5.1	2.6	-22.6	0.5	25.7
325.0	-2.5	7.2	5.1	2.6	-23.8	0.4	26.9
350.0	-2.6	7.1	5.0	2.3	-26.0	0.5	28.8
375.0	-2.7	7.2	5.1	2.4	-26.7	0.5	29.6
400.0	-2.5	6.8	4.7	2.2	-28.2	0.6	31.0
425.0	-2.8	6.7	4.6	1.7	-28.5	0.6	30.8
433.9	-2.8	6.8	4.7	1.8	-28.5	0.6	30.9
450.0	-2.8	7.0	4.9	2.0	-27.9	0.6	30.5
475.0	-3.0	6.9	4.8	1.8	-27.6	0.7	30.0
500.0	-3.1	7.0	4.9	1.8	-27.9	0.7	30.4
550.0	-3.2	7.5	5.4	2.2	-27.7	0.6	30.6
600.0	-3.2	7.0	4.9	1.7	-29.6	0.7	32.0
650.0	-3.4	6.9	4.8	1.3	-29.7	0.7	31.8
700.0	-3.6	6.5	4.4	0.8	-31.4	0.7	32.9
750.0	-3.6	7.2	5.1	1.4	-32.4	0.8	34.6
800.0	-3.6	7.1	5.0	1.3	-32.2	0.8	34.3
850.0	-4.0	6.7	4.6	0.5	-32.6	0.9	34.0
867.8	-3.8	6.6	4.5	0.6	-32.7	0.8	34.2
900.0	-4.0	7.0	4.9	0.9	-33.6	0.9	35.4
950.0	-4.0	7.7	5.6	1.5	-33.8	0.9	36.2
1000.0	-4.1	7.0	4.9	0.8	-35.0	1.0	36.8

Test Site Calibration 25 MHz - 1 GHz for ERP Measurements (Substitution Method)

Test site: Fully anechoic room, cabin no. 2
 Test distance: Standard position [m]: 3.5
 Date: 11/07/2003
 Operator: J. Roidt
 Transmit antennae: Biconical antenna HK 116, Rohde & Schwarz, inv.-no. A-1261
 Log.-per. antenna HL 223, Rohde & Schwarz, inv.-no. A-1262
 Horn antenna EMCO 3115, EMCO, inv.-no. B-1516
 Receiving antenna: Trilog Antenna VULB 9163
 Signal source: SMY 01, Rohde & Schwarz, inv.-no. A-1627,
 connected to transmit antenna via cables inv.-no. 1683, port 2 of AP 1
 and 1657, nominal power at signal generator set to 0 dBm
 Receiving cables: Inv.-no. 1656, 1681 and 1592
 Test receiver: FSP 30, Rohde & Schwarz, inv.-no. A-1666
 Antenna heights: TX antenna (h1): 1.5 metre
 RX antenna (h2): 1.5 metre
 Antenna position: TX antenna: center of turn table
 Polarization: vertical

Frequency [MHz]	Transmit signal P tx [dBm]	TX antenna gain		True transmit signal P true [dBm]	Analyzer reading P site [dBm]	Attenuation RELAX Matrix [dB]	Correction for reading in "dBm" [dB]
		(isotropic) [dBi]	(dipole) [dBd]				
25.0	-0.7	-17.0	-19.2	-19.8	-44.8	0.1	25.0
30.0	-0.9	-13.8	-16.0	-16.9	-38.8	0.1	22.0
35.0	-1.0	-11.1	-13.3	-14.3	-36.7	0.1	22.6
40.0	-1.0	-8.8	-11.0	-12.0	-36.4	0.2	24.6
45.0	-1.1	-6.7	-8.9	-10.0	-41.4	0.2	31.6
50.0	-1.1	-5.1	-7.3	-8.4	-39.5	0.1	31.2
55.0	-1.2	-3.8	-6.0	-7.1	-37.9	0.1	30.9
60.0	-1.2	-2.8	-5.0	-6.2	-39.3	0.2	33.3
65.0	-1.2	-2.0	-4.2	-5.4	-36.5	0.2	31.3
70.0	-1.3	-1.3	-3.5	-4.7	-33.8	0.2	29.3
75.0	-1.2	-0.7	-2.9	-4.1	-30.5	0.2	26.6
80.0	-1.3	-0.1	-2.3	-3.6	-29.6	0.2	26.2
85.0	-1.4	0.2	-2.0	-3.3	-30.9	0.2	27.8
90.0	-1.4	0.5	-1.7	-3.1	-31.8	0.2	29.0
95.0	-1.5	0.6	-1.6	-3.0	-31.9	0.3	29.1
100.0	-1.4	0.7	-1.5	-2.9	-31.3	0.3	28.6
110.0	-1.5	0.9	-1.3	-2.8	-28.7	0.3	26.2
120.0	-1.5	1.0	-1.2	-2.7	-26.9	0.3	24.5
130.0	-1.6	1.1	-1.1	-2.6	-24.0	0.3	21.7
140.0	-1.7	1.4	-0.8	-2.4	-22.0	0.3	19.9
150.0	-1.7	1.8	-0.4	-2.0	-20.9	0.3	19.2
160.0	-1.7	1.9	-0.3	-2.0	-20.8	0.4	19.2
170.0	-1.8	2.0	-0.2	-1.9	-21.0	0.3	19.4
180.0	-1.8	2.1	0.0	-1.9	-20.9	0.4	19.4
190.0	-1.9	2.3	0.2	-1.8	-22.0	0.4	20.6
200.0	-1.7	2.3	0.2	-1.6	-22.1	0.4	20.9
200.1	-1.8	6.5	4.4	2.5	-17.1	0.4	20.0
220.0	-2.1	6.9	4.8	2.7	-17.5	0.4	20.5
240.0	-2.2	7.0	4.9	2.7	-19.0	0.4	22.1

Test Site Calibration 25 MHz - 1 GHz for ERP Measurements (Substitution Method)

Test site: Fully anechoic room, cabin no. 2
 Test distance: Standard position [m]: 3.5
 Date: 11/07/2003
 Operator: J. Roidt
 Transmit antennae: Biconical antenna HK 116, Rohde & Schwarz, inv.-no. A-1261
 Log.-per. antenna HL 223, Rohde & Schwarz, inv.-no. A-1262
 Horn antenna EMCO 3115, EMCO, inv.-no. B-1516
 Receiving antenna: Trilog Antenna VULB 9163
 Signal source: SMY 01, Rohde & Schwarz, inv.-no. A-1627,
 connected to transmit antenna via cables inv.-no. 1683, port 2 of AP 1
 and 1657, nominal power at signal generator set to 0 dBm
 Receiving cables: Inv.-no. 1656, 1681 and 1592
 Test receiver: FSP 30, Rohde & Schwarz, inv.-no. A-1666
 Antenna heights: TX antenna (h1): 1.5 metre
 RX antenna (h2): 1.5 metre
 Antenna position: TX antenna: center of turn table
 Polarization: vertical

Frequency [MHz]	Transmit signal P tx [dBm]	TX antenna gain		True transmit signal P true [dBm]	Analyzer reading P site [dBm]	Attenuation RELAX Matrix [dB]	Correction for reading in "dBm" [dB]
		(isotropic) [dBi]	(dipole) [dBd]				
260.0	-2.2	7.1	5.0	2.7	-20.5	0.4	23.7
280.0	-2.4	7.3	5.1	2.8	-22.4	0.4	25.7
300.0	-2.4	7.2	5.1	2.6	-24.5	0.5	27.6
325.0	-2.5	7.2	5.1	2.6	-25.1	0.4	28.2
350.0	-2.6	7.1	5.0	2.3	-27.0	0.5	29.8
375.0	-2.7	7.2	5.1	2.4	-26.4	0.5	29.3
400.0	-2.5	6.8	4.7	2.2	-26.7	0.6	29.5
425.0	-2.8	6.7	4.6	1.7	-26.4	0.6	28.7
433.9	-2.8	6.8	4.7	1.8	-26.4	0.6	28.8
450.0	-2.8	7.0	4.9	2.0	-26.3	0.6	28.9
475.0	-3.0	6.9	4.8	1.8	-26.2	0.7	28.7
500.0	-3.1	7.0	4.9	1.8	-26.5	0.7	29.0
550.0	-3.2	7.5	5.4	2.2	-28.3	0.6	31.2
600.0	-3.2	7.0	4.9	1.7	-30.9	0.7	33.3
650.0	-3.4	6.9	4.8	1.3	-29.7	0.7	31.7
700.0	-3.6	6.5	4.4	0.8	-29.7	0.7	31.2
750.0	-3.6	7.2	5.1	1.4	-30.9	0.8	33.1
800.0	-3.6	7.1	5.0	1.3	-33.1	0.8	35.2
850.0	-4.0	6.7	4.6	0.5	-34.0	0.9	35.4
867.8	-3.8	6.6	4.5	0.6	-34.5	0.8	36.0
900.0	-4.0	7.0	4.9	0.9	-33.4	0.9	35.2
950.0	-4.0	7.7	5.6	1.5	-32.4	0.9	34.8
1000.0	-4.1	7.0	4.9	0.8	-33.5	1.0	35.3

Radiated Power Test 25 MHz - 100 MHz acc. to FCC Part 95 Subpart C/E

Model: T2DR	Comment: - TX mode - f = 75.750 MHz - EUT in vertical position - EUT battery powered 12 V
Serial no.: A70124103	
Applicant: Futaba Corporation	
Test site: Fully anechoic room, cabin no. 2	
Tested on: Test distance 3 metres Horizontal Polarization	
Date of test: 06/27/2007	
Test performed: automatically	File name: default.emi
Detector: Peak	List of values: Selected by hand

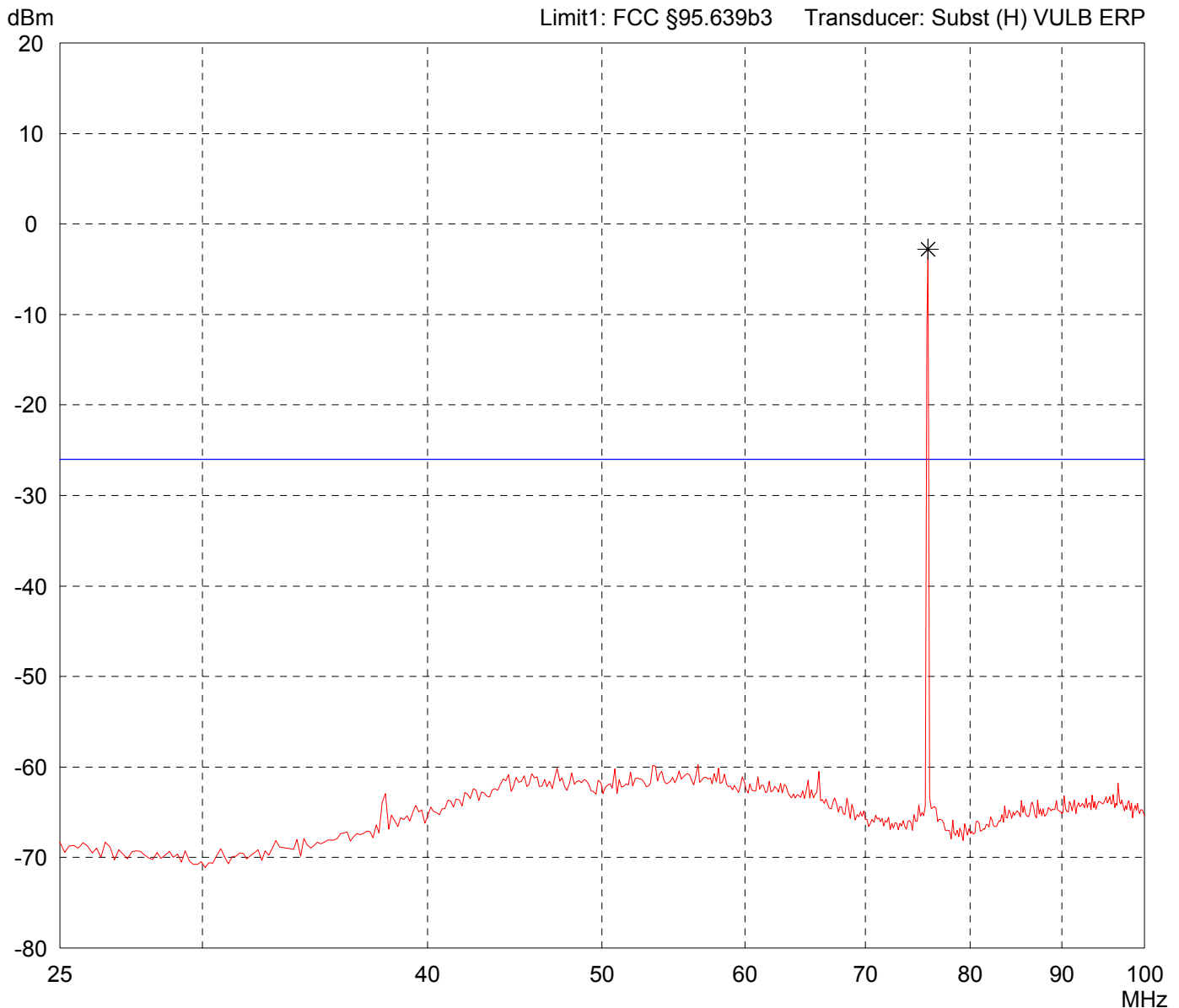

Result: Limit kept - Carrier excluded	Project file: 55503-70530
--	------------------------------

Radiated Power Test 25 MHz - 100 MHz acc. to FCC Part 95 Subpart C/E

Model: T2DR	Comment: - TX mode - f = 75.750 MHz - EUT in vertical position - EUT battery powered 12 V
Serial no.: A70124103	
Applicant: Futaba Corporation	
Test site: Fully anechoic room, cabin no. 2	
Tested on: Test distance 3 metres Vertical Polarization	
Date of test: 06/27/2007	
Test performed: automatically	File name: default.emi
Detector: Peak	List of values: Selected by hand

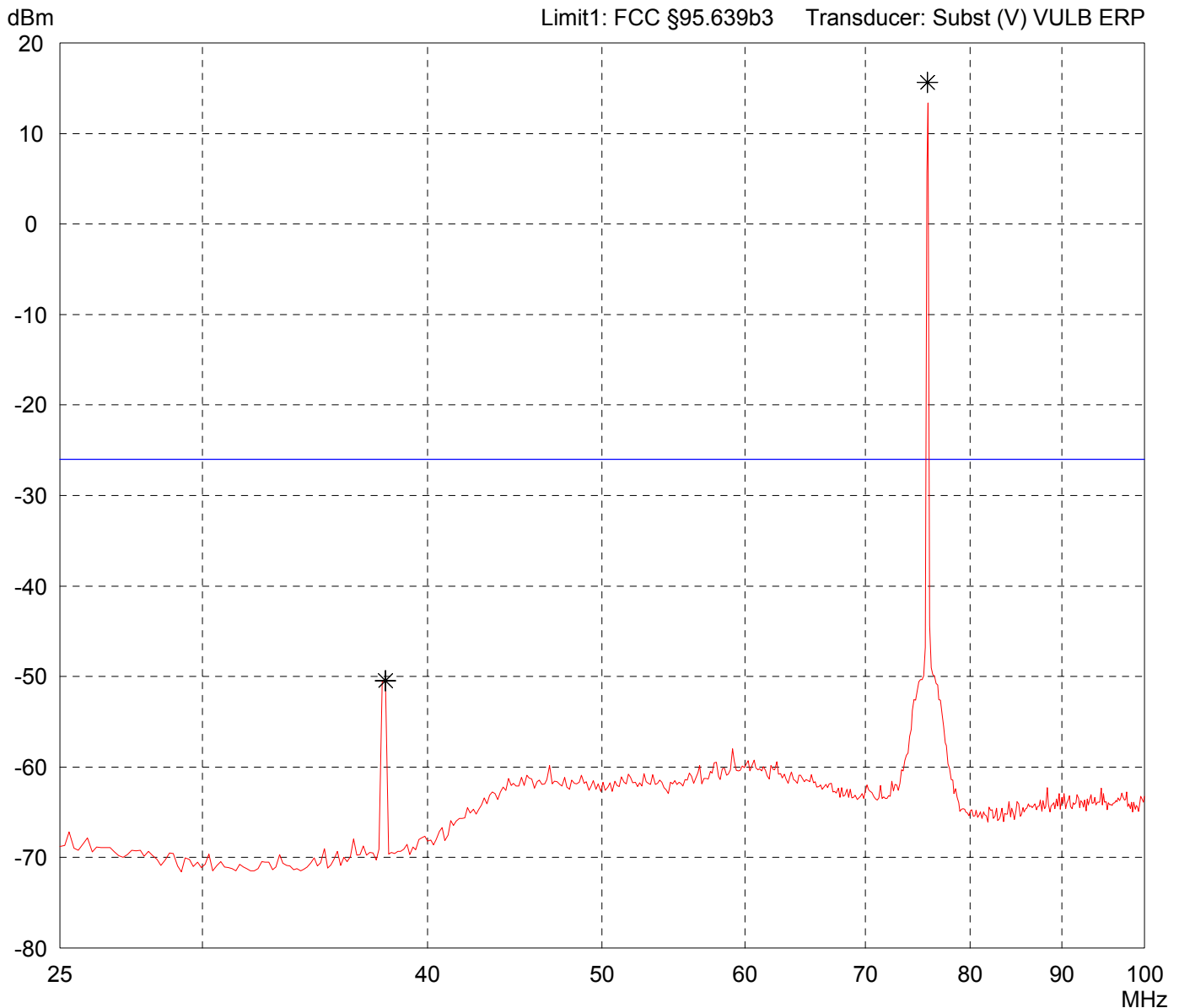

Result: Limit kept - carrier excluded	Project file: 55503-70530
--	------------------------------

Radiated Power Test 25 MHz - 100 MHz acc. to FCC Part 95 Subpart C/E

Model:
T2DR

Serial no.:
A70124103

Applicant:
Futaba Corporation

Test site:
Fully anechoic room, cabin no. 2

Tested on:
Test distance 3 metres
Horizontal Polarization

Date of test:
06/27/2007

Operator:
T. Eberl

Test performed:
automatically

File name:
default.emi

Comment:

- TX mode
- f = 75.750 MHz
- EUT in horizontal position - right side on table
- EUT battery powered 12 V

Detector:
Peak

List of values:
Selected by hand

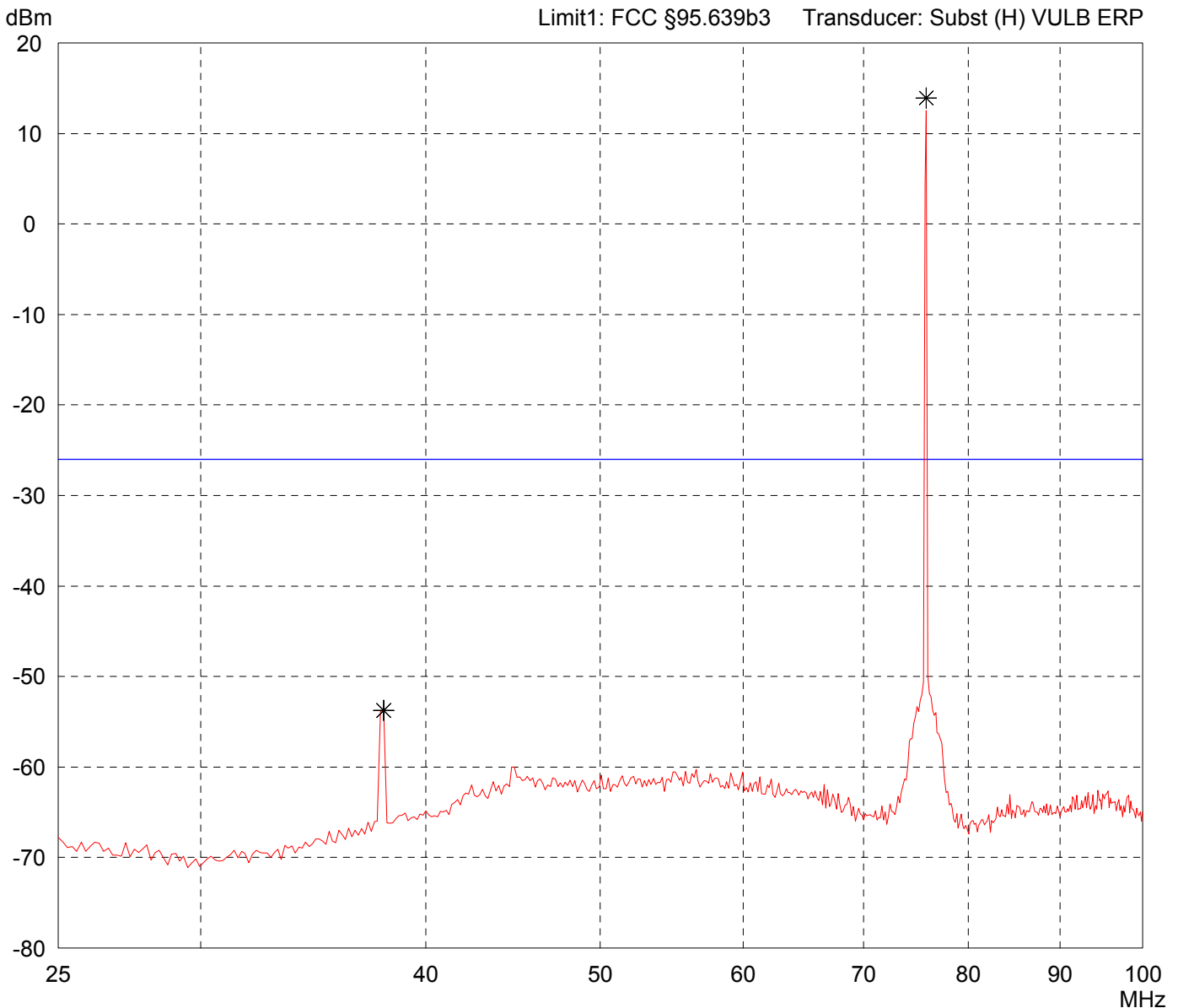

Result:
Limit kept - Carrier excluded

Project file:
55503-70530

Radiated Power Test 25 MHz - 100 MHz acc. to FCC Part 95 Subpart C/E

Model:
T2DR

Serial no.:
A70124103

Applicant:
Futaba Corporation

Test site:
Fully anechoic room, cabin no. 2

Tested on:
Test distance 3 metres
Vertical Polarization

Date of test:
06/27/2007

Operator:
T. Eberl

Test performed:
automatically

File name:
default.emi

Comment:

- TX mode
- f = 75.750 MHz
- EUT in horizontal position - right side on table
- EUT battery powered 12 V

Detector:
Peak

List of values:
Selected by hand

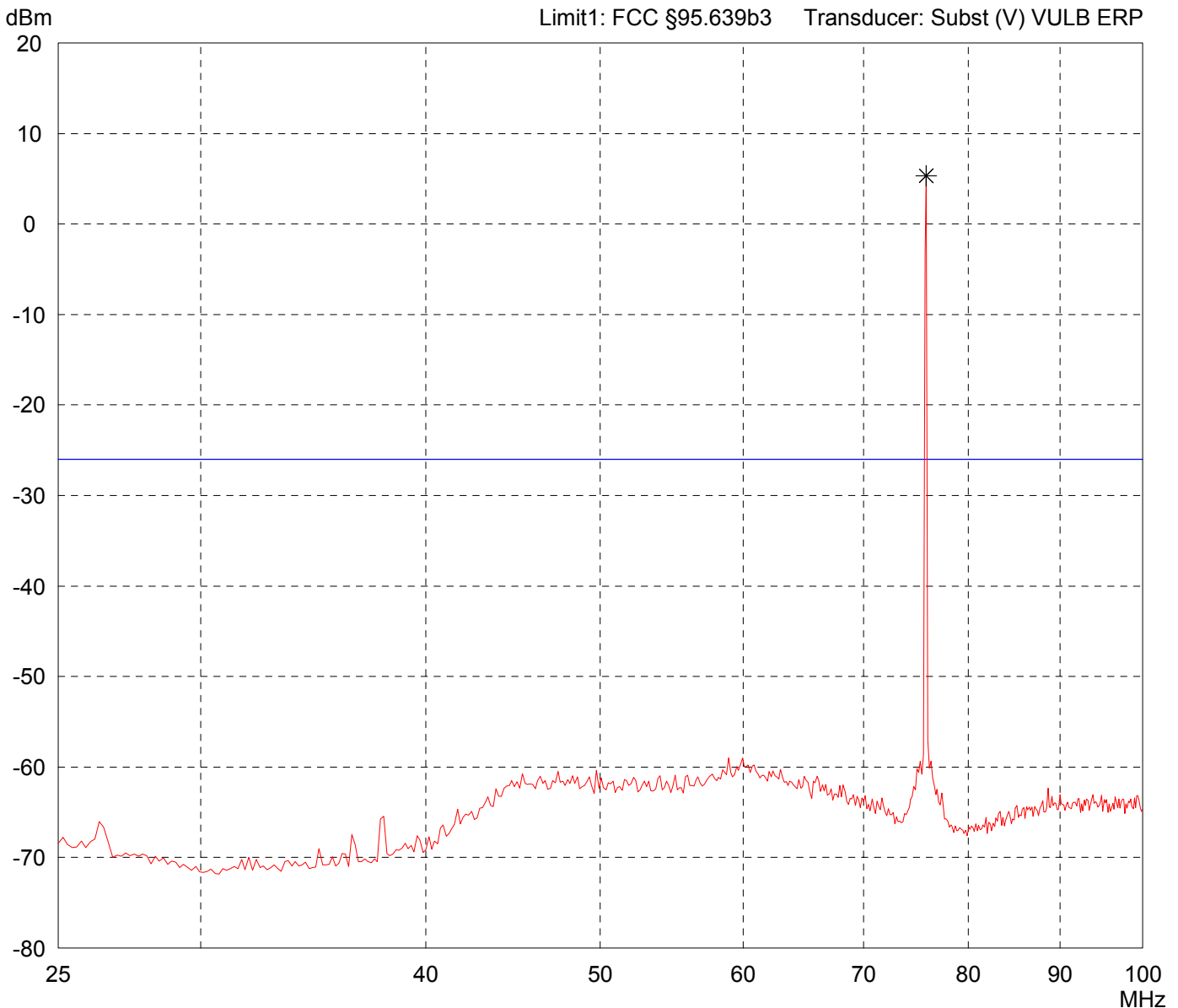

Result:
Limit kept - Carrier excluded

Project file:
55503-70530

Radiated Power Test 25 MHz - 100 MHz acc. to FCC Part 95 Subpart C/E

Model:
T2DR

Serial no.:
A70124103

Applicant:
Futaba Corporation

Test site:
Fully anechoic room, cabin no. 2

Tested on:
Test distance 3 metres
Horizontal Polarization

Date of test:
06/27/2007

Operator:
T. Eberl

Test performed:
automatically

File name:
default.emi

Comment:

- TX mode
- f = 75.750 MHz
- EUT in horizontal position - rear side on table
- EUT battery powered 12 V

Detector:
Peak

List of values:
Selected by hand

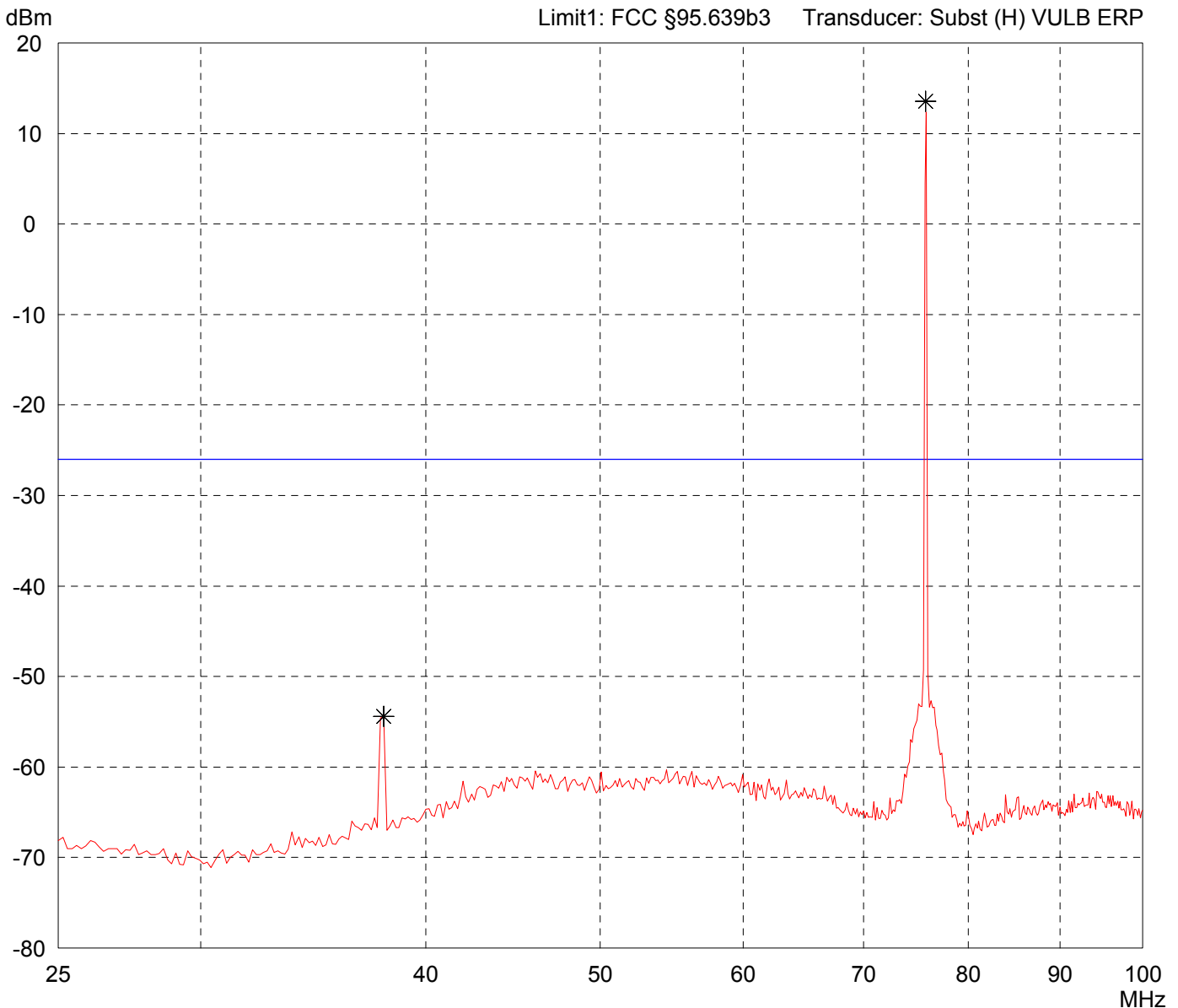

Result:
Limit kept - Carrier excluded

Project file:
55503-70530

Radiated Power Test 25 MHz - 100 MHz acc. to FCC Part 95 Subpart C/E

Model: T2DR	Comment: - TX mode - f = 75.750 MHz - EUT in horizontal position - rear side on table - EUT battery powered 12 V
Serial no.: A70124103	
Applicant: Futaba Corporation	
Test site: Fully anechoic room, cabin no. 2	
Tested on: Test distance 3 metres Vertical Polarization	
Date of test: 06/27/2007	
Test performed: automatically	File name: default.emi
Detector: Peak	List of values: Selected by hand

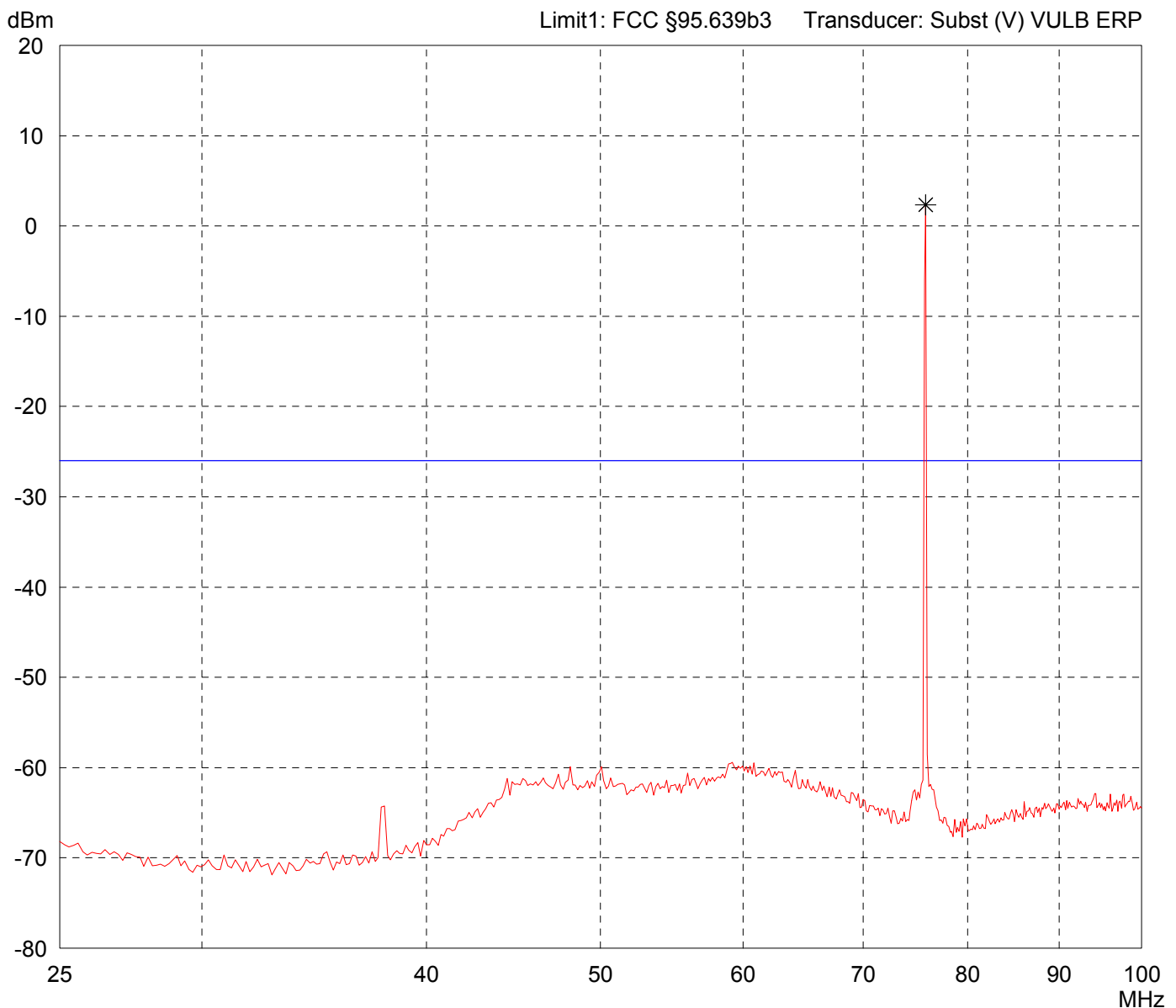

Result: Limit kept - Carrier excluded	Project file: 55503-70530
--	------------------------------

Radiated Power Test 100 MHz - 1 GHz acc. to FCC Part 95 Subpart C/E

Model: T2DR	Comment: - TX mode - f = 75.750 MHz - EUT in vertical position - EUT battery powered 12 V
Serial no.: A70124103	
Applicant: Futaba Corporation	
Test site: Fully anechoic room, cabin no. 2	
Tested on: Test distance 3 metres Horizontal Polarization	
Date of test: 06/27/2007	Operator: T. Eberl
Test performed: automatically	File name: default.emi
Detector: Peak	List of values: Selected by hand

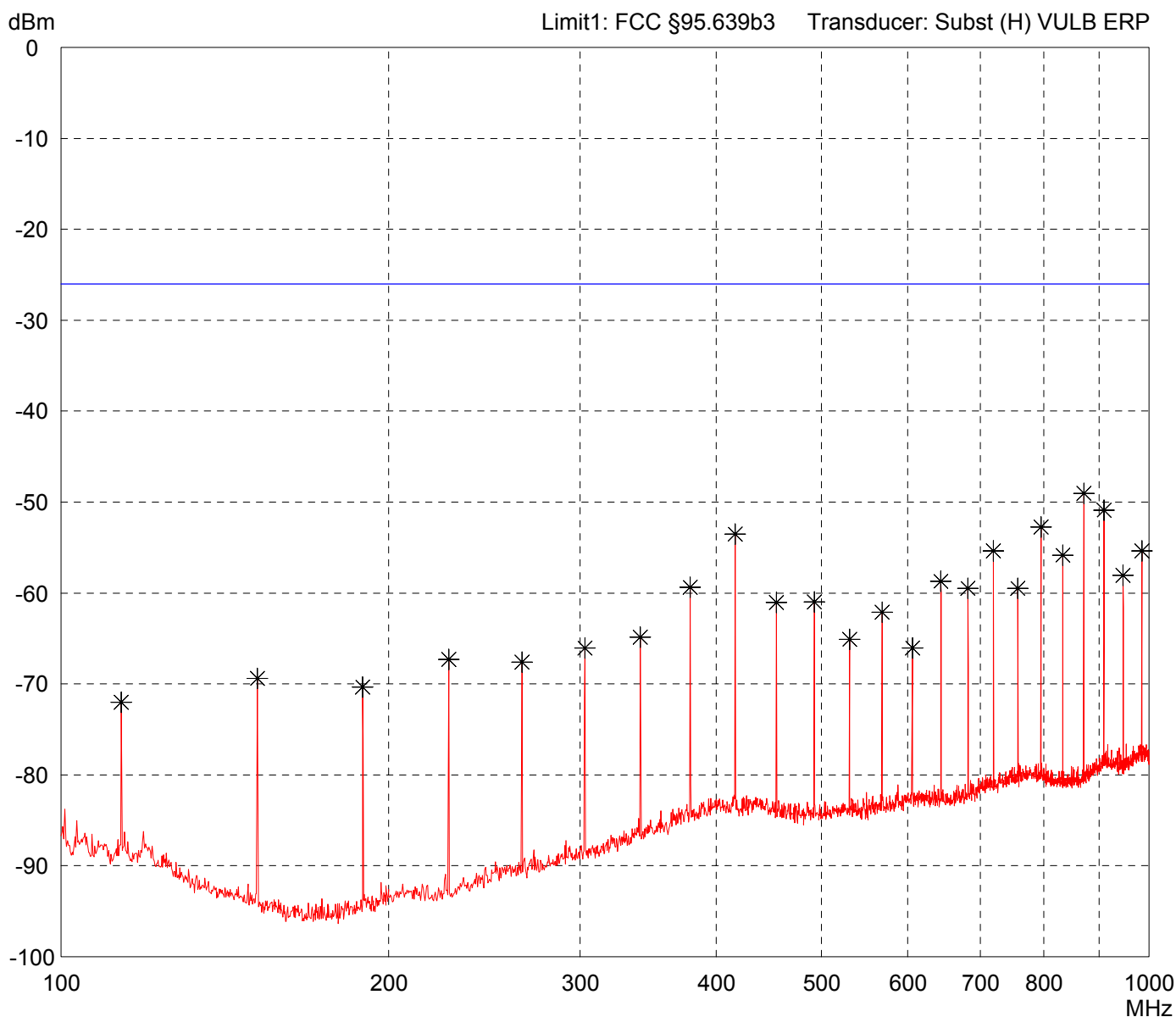

Result: Limit kept	Project file: 55503-70530
-----------------------	------------------------------

Radiated Power Test 100 MHz - 1 GHz acc. to FCC Part 95 Subpart C/E

Model:
T2DR

Serial no.:
A70124103

Applicant:
Futaba Corporation

Test site:
Fully anechoic room, cabin no. 2

Tested on:
Test distance 3 metres
Vertical Polarization

Date of test:
06/27/2007

Operator:
T. Eberl

Test performed:
automatically

File name:
default.emi

Comment:

- TX mode
- f = 75.750 MHz
- EUT in vertical position
- EUT battery powered 12 V

Detector:
Peak

List of values:
Selected by hand

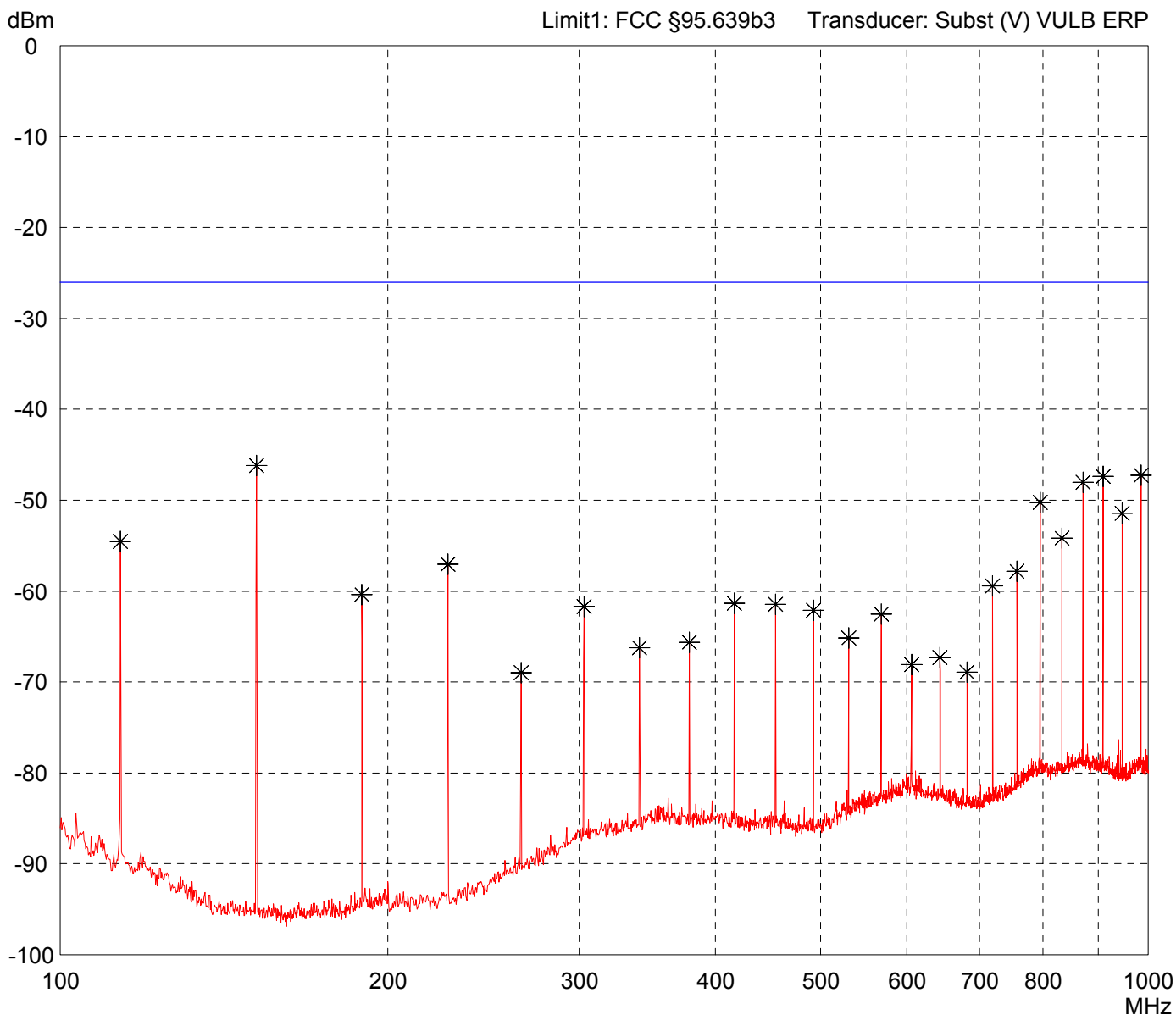

Result:
Limit kept

Project file:
55503-70530

Radiated Power Test 100 MHz - 1 GHz acc. to FCC Part 95 Subpart C/E

Model: T2DR	Comment: - TX mode - f = 75.750 MHz - EUT in horizontal position - right side on table - EUT battery powered 12 V
Serial no.: A70124103	
Applicant: Futaba Corporation	
Test site: Fully anechoic room, cabin no. 2	
Tested on: Test distance 3 metres Horizontal Polarization	
Date of test: 06/27/2007	Operator: T. Eberl
Test performed: automatically	File name: default.emi
Detector: Peak	List of values: Selected by hand

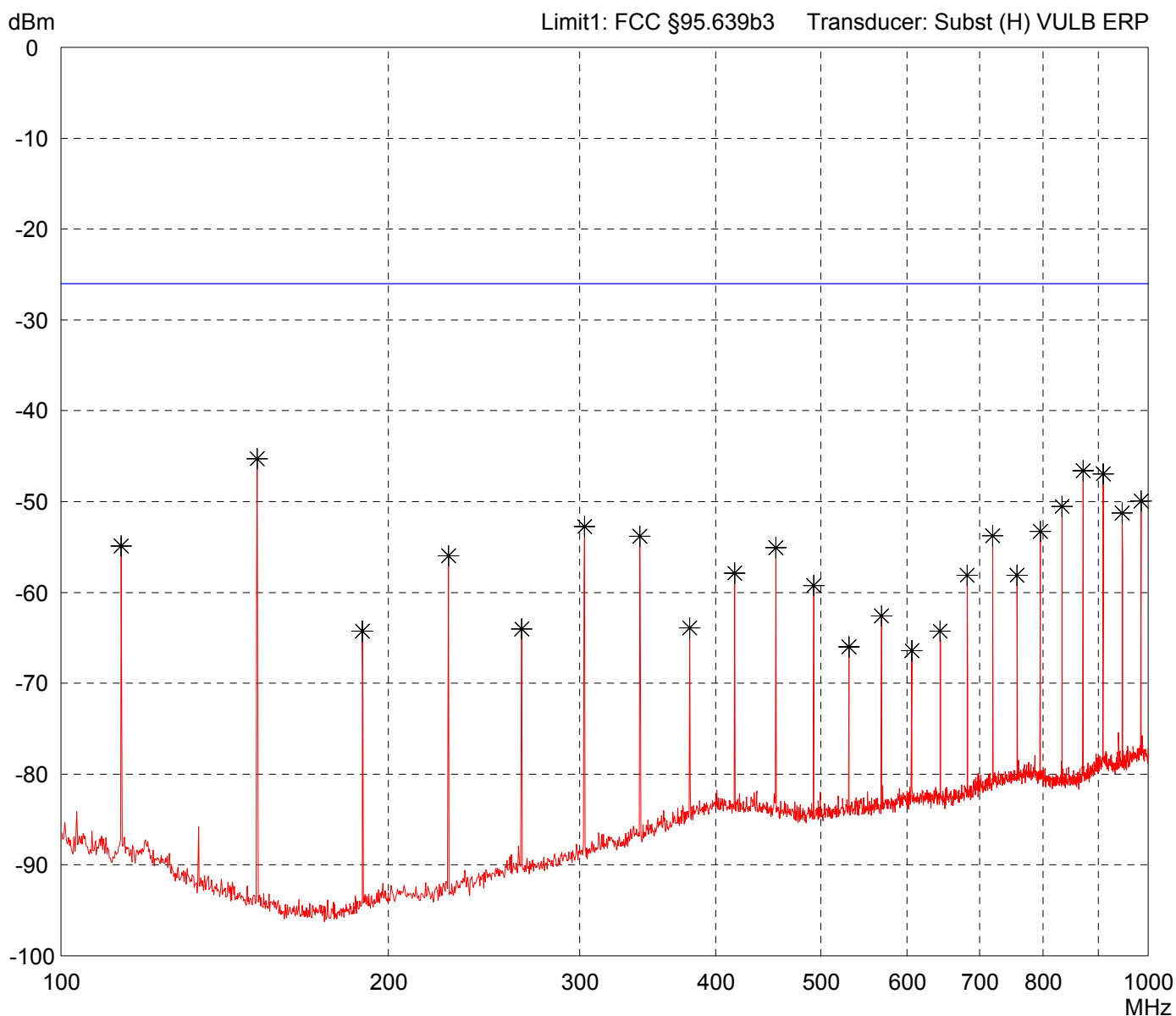

Result: Limit kept	Project file: 55503-70530
-----------------------	------------------------------

Radiated Power Test 100 MHz - 1 GHz acc. to FCC Part 95 Subpart C/E

Model: T2DR	Comment: - TX mode - f = 75.750 MHz - EUT in horizontal position - right side on table - EUT battery powered 12 V
Serial no.: A70124103	
Applicant: Futaba Corporation	
Test site: Fully anechoic room, cabin no. 2	
Tested on: Test distance 3 metres Vertical Polarization	
Date of test: 06/27/2007	Operator: T. Eberl
Test performed: automatically	File name: default.emi
Detector: Peak	List of values: Selected by hand

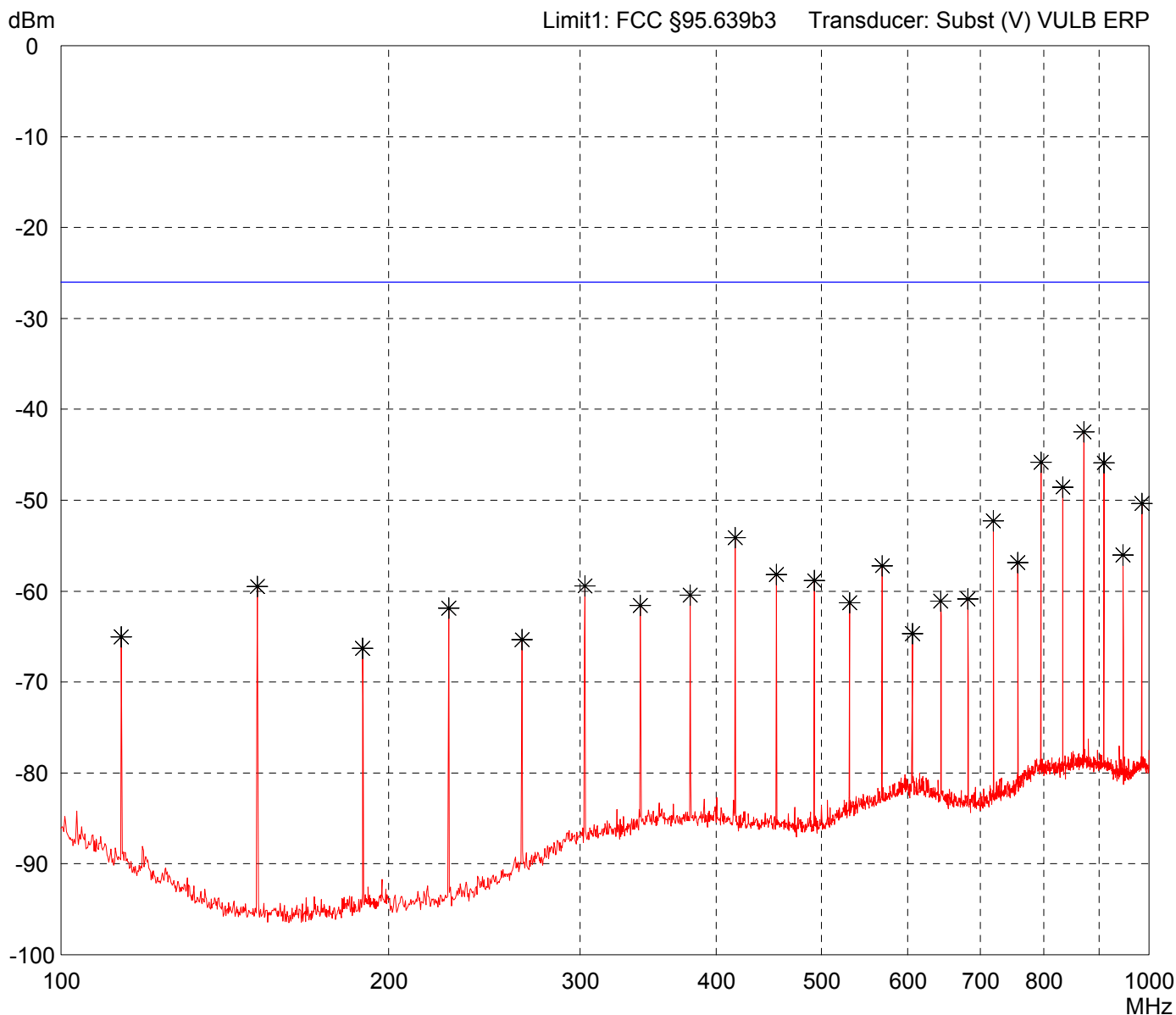

Result: Limit kept	Project file: 55503-70530
-----------------------	------------------------------

Radiated Power Test 100 MHz - 1 GHz acc. to FCC Part 95 Subpart C/E

Model: T2DR	Comment: - TX mode - f = 75.750 MHz - EUT in horizontal position - rear side on table - EUT battery powered 12 V
Serial no.: A70124103	
Applicant: Futaba Corporation	
Test site: Fully anechoic room, cabin no. 2	
Tested on: Test distance 3 metres Horizontal Polarization	
Date of test: 06/27/2007	Operator: T. Eberl
Test performed: automatically	File name: default.emi
Detector: Peak	List of values: Selected by hand

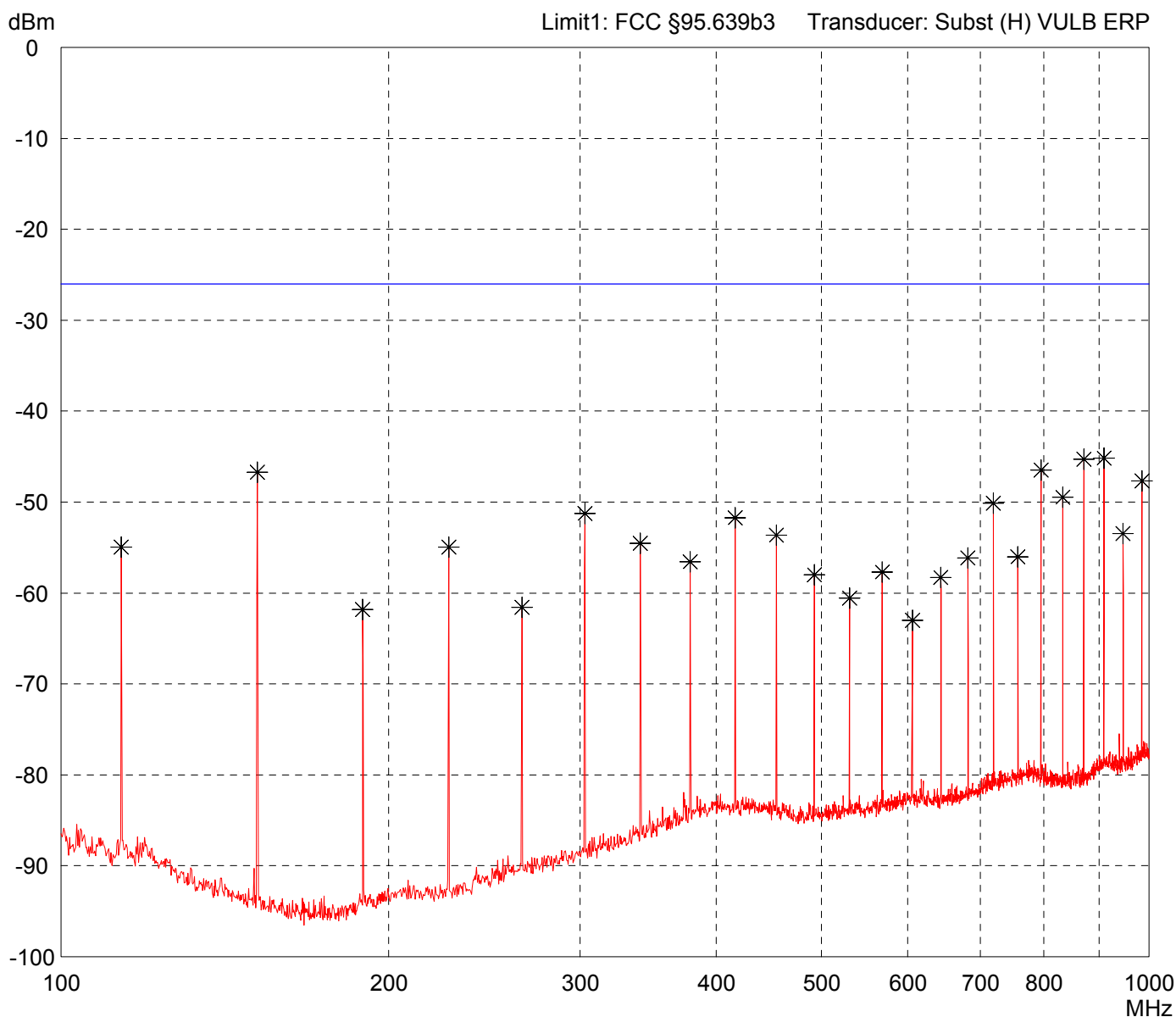

Result: Limit kept	Project file: 55503-70530
-----------------------	------------------------------

Radiated Power Test 100 MHz - 1 GHz acc. to FCC Part 95 Subpart C/E

Model: T2DR	Comment: - TX mode - f = 75.750 MHz - EUT in horizontal position - rear side on table - EUT battery powered 12 V
Serial no.: A70124103	
Applicant: Futaba Corporation	
Test site: Fully anechoic room, cabin no. 2	
Tested on: Test distance 3 metres Vertical Polarization	
Date of test: 06/27/2007	Operator: T. Eberl
Test performed: automatically	File name: default.emi
Detector: Peak	List of values: Selected by hand

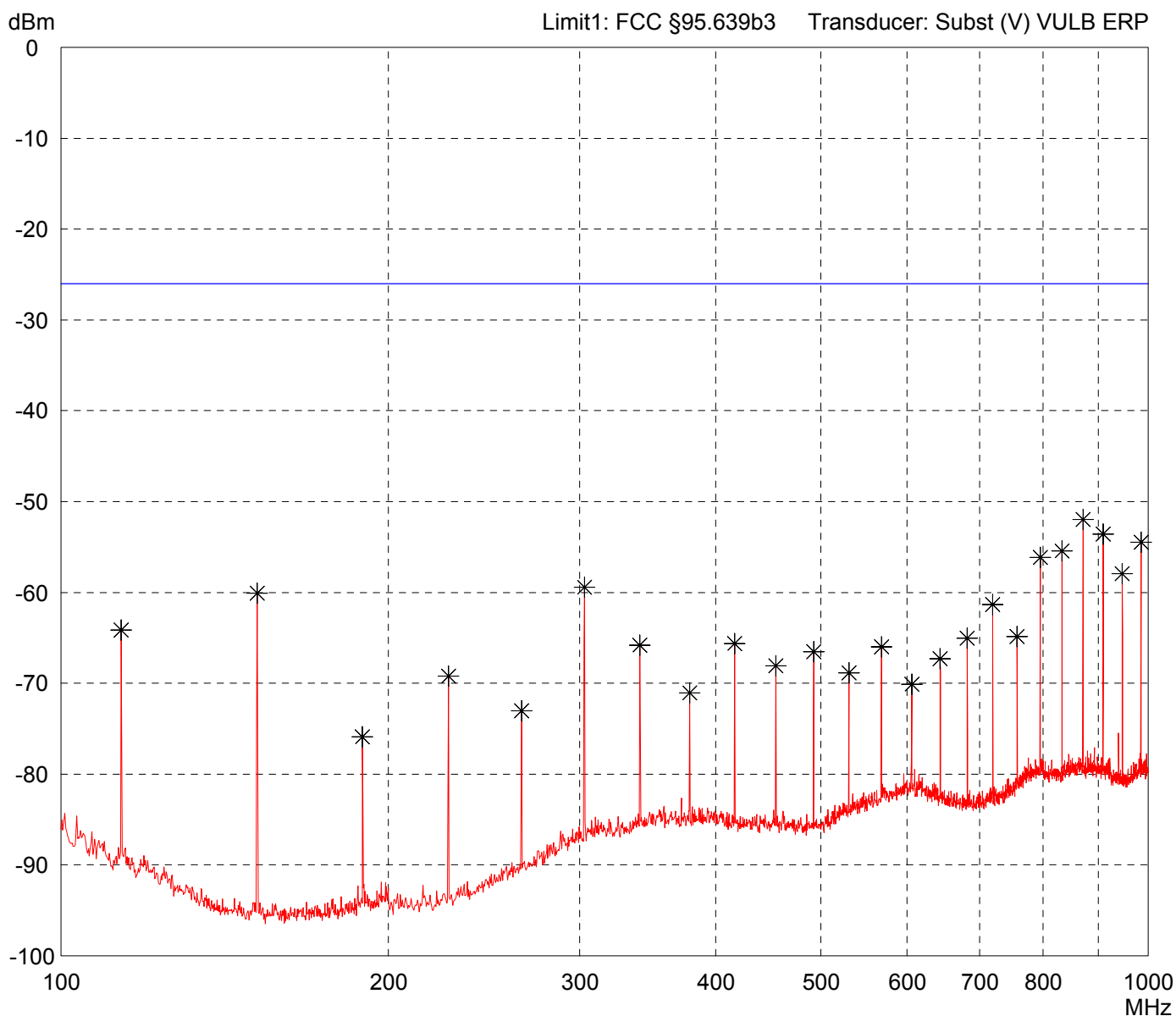

Result: Limit kept	Project file: 55503-70530
-----------------------	------------------------------