

Thank you for purchasing a Futaba 2PH/2PHKA.
Before using your 2PH/2PHKA, read this manual carefully and
use your R/C set safely.
After reading this manual, store it in a safe place.

APPLICATION, EXPORT, AND RECONSTRUCTION

1. This product may be used for models only.

The product described in this manual is subject to regulations of the Ministry of Radio/Telecommunications and is restricted under Japanese law to such purposes.

2. Exportation precautions

(a) When this product is exported from Japan, its use is to be approved by the Radio Law of the country of destination.

(b) Use of this product with other than models may be restricted by Export and Trade Control Regulations. An application for export approval must be submitted.

3. Modification, adjustment, and replacement of parts

Futaba is not responsible for unauthorized modification, adjustment, and replacement of parts of this product.

THE FOLLOWING STATEMENT APPLIES TO THE RECEIVER (FOR U.S.A.)

This device complies with part 15 of the FCC Rules. Operation is subject to the following two conditions:

(1) This device may not cause harmful interference, and

(2) This device must accept any interference received, including interference that may cause undesired operation.

THE RBRC™ SEAL (FOR U.S.A.)

The RBRC™ SEAL on the (easily removable) nickel-cadmium battery contained in Futaba products indicates that Futaba Corporation of America is voluntarily participating in an industry program to collect and recycle these batteries at the end of their useful lives, when taken out of service within the United States. The RBRC™ program provides a convenient alternative to placing used nickel-cadmium batteries into the trash or municipal waste which is illegal in some areas.

Futaba Corporation of America's payments to RBRC™ makes it easy for you to return the spent battery to Futaba for recycling purposes. You may also contact your local recycling center for information on where to return the spent battery. Please call 1-800-8-BATTERY for information on Ni-Cd battery recycling in your area. Futaba Corporation of America's involvement in this program is part of its commitment to protecting our environment and conserving natural resources.



NOTE: Our instruction manuals need to encourage our customers to return spent batteries to Futaba or a local recycling center in order to keep a healthy environment.

RBRC™ is a trademark of the Rechargeable Battery Recycling Corporation.

Warning: This product contains a chemical known to cause cancer and birth defects (or other reproductive harm).

-No part of this manual may be reproduced in any form without prior permission.

-The contents of this manual are subject to change without prior notice.

-This manual has been carefully written. Please write to Futaba if you feel that any corrections or clarifications should be made.

-Futaba is not responsible for the use of this product.

Safety Precautions	2
Definition Of Symbols.....	2..
Running Preparations Safety Precautions.....	2..
Running Safety Precautions.....	3..
Storage And Disposal Safety Precautions.....	4..
Other Safety Precautions.....	5..
Before Operation	6
System Contents.....	6..
Nomenclature / Handling.....	7..
Assembly / Adjustment	9
Receiver And Servo Connection.....	9..
Assembly Precautions.....	10..
Digital Proportional Adjustment.....	12..
Description Of Functions	13
Steering Trim.....	13..
Throttle Trim.....	13..
Servo Reverse.....	13..
Steering EPA.....	14..
Throttle EPA.....	14..
Steering D/R.....	14..
MC230CR/MC330CR.....	15..
Reference	16
Ratings.....	16..
Troubleshooting.....	17..

For your safety as well as that of others. Please read this manual thoroughly prior to installation and operation of your digital proportional R/C system.

Definition Of Symbols

The following defines the symbols used in this manual.

Explanation Of Symbols

Warning

Indicates a procedure that could result in serious injury or death to the user or other persons if ignored and not performed properly.

Caution

Indicates a procedure that may result in serious injury to the user or other persons, as well as physical damage. If ignored and not performed properly.

Explanation Of Graphic Symbols

 Indicates an operation that prompts a warning (including Caution).

 Indicates an operation that must not be performed.

 Indicates an operation that always must be performed.

Running (Sailing) Preparations Safety Precautions

Warning

(When using a Ni-cad battery to power your system)

Charging

-  When using a Ni-cad battery to power your system, always charge and check the battery voltage prior to operation.
Should the battery discharge below the minimum voltage level, control will be lost.

Caution

(When using a Ni-cad battery to power your system)

-  When the charger is not in use, disconnect from the outlet.
To prevent accidents, overheating and short circuits.

Running (Sailing) Safety Precautions

Warning

Conduct Tests



Prior to operation always perform a range test. Even one abnormality in the R/C system may cause loss of control. [Range Test Procedure]

Have a friend hold the model, or place on a stand where the wheels or prop can not come in contact with any object. Collapse the transmitter antenna and operate from a distance of about 10 yards. Be sure to check the movement of each servo to make sure they follow the movement of the steering wheel and throttle trigger. If the servos do not follow the commands from the transmitter or any type of interference is detected, Do Not operate the model.



Fully extend the transmitter antenna. If the transmitter antenna is not fully extended range will be reduced and control may be lost.

Prohibited



Do not operate two or more models on the same frequency at the same time. Operation of two or more models on the same frequency at the same time will cause interference and loss of control of both models. AM, FM and PCM are different methods of modulation. Nonetheless the same frequency can not be used at the same point in time, regardless of the signal format.

Do not operate outdoors on rainy days



Never operate in the rain or run through puddles. The transmitter, receiver, batteries and most servos, and speed controls are not waterproof. Contact with any type of moisture or immersion in water or snow will cause damage along with possible loss of control. Should any type of moisture enter any component of the system immediately stop using the R/C system and return to our service center for inspection.

Prohibited



Do not operate when visibility is limited. Should you lose sight of the model a collision or other dangerous situation may occur.

Prohibited



Do not operate near people or roads. Do not operate near high tension power lines or communication broadcasting antennas. Prior to the operation of any model be sure the area you plan to use is safe. Be aware of all objects that may be in the path of your model. Do not operate the model where people or any type of moveable object could stray in the path of your model. Control loss due to interference, component failure, loss of sight or low battery voltage could result in serious injury to yourself and others as well as damage to your model.

Prohibited





Do not operate your R/C system within 1 mile of another site where radio control activity may occur. Interference from other R/C systems will cause loss of control.

Prohibited

-  Do not operate when you are tired, not feeling well or under the influence of alcohol or drugs. Your judgement is impaired and could result in a dangerous situation that may cause serious injury to yourself and others.

-  Before you turn on the power switch on the transmitter, always check to see that the trigger is at the neutral position. Always turn the transmitter on first, then the receiver. When you turn the system off, always turn the receiver off first then the transmitter. This step is very important always follow this procedure. If this procedure is not followed, injury to yourself and others as well as loss of control could occur.

Adjustment Note

-  Make all adjustments to the radio control system with engine not running, or the electric motor disconnected. If the engine is running or the motor is connected while adjustments are made the model may run out of control.
-  Remove the main battery source from electric powered models when they are not being used. Should you accidently leave the receiver switch on the model could run out of control.

 **Caution**

Do not touch

-  Do not touch the engine, motor, speed control or any part of the model that will generate heat while running. Touching hot parts will result in serious burns.

Storage And Disposal Safety Precautions

 **Warning**

(When using a Ni-cad battery to power your system)

-  At the end of a days operation store the system with Ni-cad battery discharged. Be sure to recharge the system before it is used again. You should fully discharge your systems batteries periodicity to prevent a condition called "memory". For example if you only make two run in a day or you regularly use a small amount of the batteries capacity, the memory effect can reduce the actual capacity even if the battery is charged for the recommended amount of time.

Prohibited

-  Do not throw a Ni-cad battery into a fire. Do not disassemble or attempt to repair a Ni-cad battery pack. Overheating, damage and acid leakage may lead to burns, loss of eye sight as well as numerous other types of injuries. The electrolyte in Ni-cad batteries is a strong alkali. Should you get even the smallest amount of the electrolyte in your eyes, Do Not rub, wash immediately with water, seek medical attention at once. The electrolyte can cause blindness. If electrolyte comes in contact with your skin or clothes, wash with water immediately.

Caution

Prohibited



Do not store your R/C system where it will be exposed to the following conditions.

- Extreme heat or coldness
- Exposed to direct sunlight
- Where humidity is high
- Where vibration is prevalent
- Where dust is prevalent
- Where there is steam and condensation
- Where the system would be exposed to engine exhaust

Storing your R/C system under adverse conditions could cause deformation and numerous other problems with operation.

(When using a Ni-cad battery to power your system)

Caution



When disposing Ni-cad batteries, cover any exposed contacts with some type of insulation to prevent short circuit.

Improper disposal could cause fire.

*Special Note!

Some states require special handling when Ni-cad batteries are disposed. Contact the State Agency responsible for recycling hazardous waste for the procedures in your state.

Other Safety Precautions

Caution



When operating two or more models at the same time, have a third person act as a spotter. They will be in charge of safety and you should follow their instructions.



Beginners should receive instructions regarding safety and operation from an experienced modeler.

Use genuine Futaba parts only.



Always use only genuine Futaba receiver, servos, electronic speed controls along with other optional parts and components.

Futaba will not be held responsible for damages caused by other than genuine Futaba parts and components. Use only genuine Futaba parts and components listed in the instruction manual and catalog.

(When using a Ni-cad battery to power your system)

Prohibited



Do not short circuit the Ni-cad battery terminals.

Short circuiting the terminals will lead to sparks and overheating and could cause a fire and burns as well.

System Contents

After opening the container, check the contents for the following items. the contents will vary with the system purchased.

	System with 2 Servos	System with 1 Servo	System with E.S.C. and Servo
Transmitter	T2PH or T2PHKA (x1)		
Receiver	R122JE (x1)		
Servo	S3003 (x2)	S3003 (x1)	
E.S.C.			MC230CR (x1) or MC330CR (x1)
Switch	CSW-BN (x1)		
Battery Holder	R2-BSS-N (x1)		
Miscellaneous	Servo mounting hardware and servo horns		
			Mini Screwdriver

Before Operation

Should any item be missing or you are uncertain of the contents of the system, please contact the dealer where the unit was purchased.

Receiver R122JE

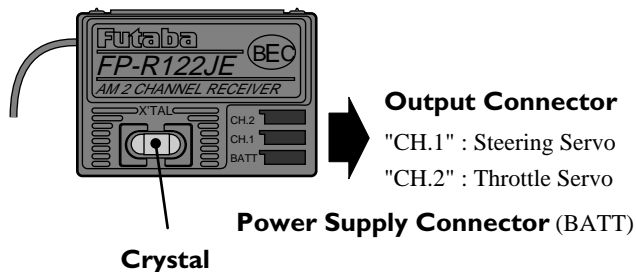

Servo S3003

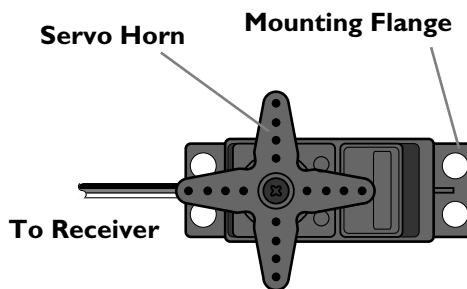

Nomenclature / Handling

Transmitter T2PH / T2PHKA

(T2PH)

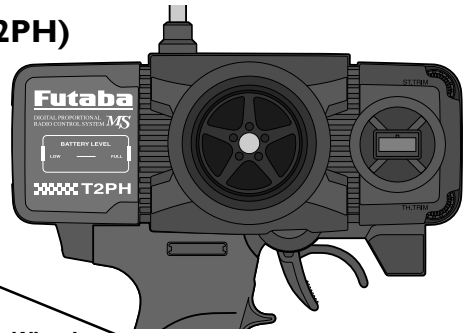

Battery Level Indicator

*Two LED display to indicate battery voltage level.
*If the Red led flashes, replace batteries.

Antenna

Steering Wheel

*Turn model to left or right.

Steering Trim (P13)

*Adjusts the steering in small increments so the model will run straight.

Power Switch

*When slid upward, the power is turned on.

Throttle Trim (P13)

*Adjusts the throttle in small increments so the model will not move at neutral.

Trim Panel Cover

*Open the cover by sliding it to the left.

Throttle Trigger

*Control the speed of the model and movement forward and backward.

- ¥ Servo Reversing Switch (P13)
- ¥ Steering EPA (only 2PHKA) (P14)
- ¥ Throttle EPA (only 2PHKA) (P14)
- ¥ Steering D/R (only 2PHKA) (P14)

Grip Handle

(T2PHKA)

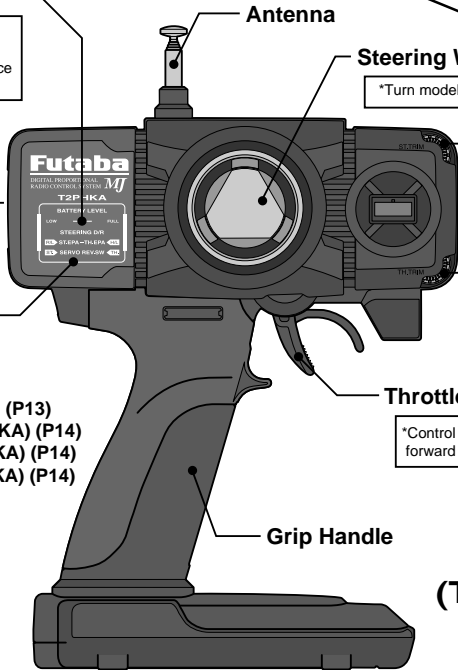

Before Operation

E.S.C. MC230CR / MC330CR

Applicable motors (Number of turns is criteria.)

- Use the MC230CR with a motor with 20T or more turns.
- Use the MC330CR with a motor with 13T or more turns.

*If a motor with a number of turns smaller than the above is used, the heat protector and overcurrent protection circuit may operate. The number of turns of the motor is a criteria only. Depending on the running conditions, the protection circuit may operate even if the condition above is satisfied.

Checker LED
Pushbutton switch

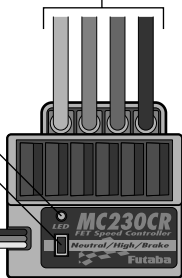

MC230CR

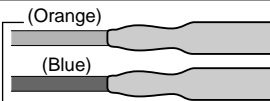

Motor connector

Connects to the motor.
(Orange) is plus. (Blue) is minus.
If the motor rotates in the wrong direction, interchange the connections of this connector.

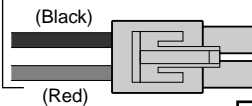

Nid battery connector

Connects to the running Nid battery.
(Red) is plus. (Black) is minus.

Nid battery 6~7 cells (7.2~8.4V)



Receiver connector

Connects to the receiver throttle channel.

Miniature screwdriver

Accessory. Use to press the pushbutton switch.

Power switch

Handling Procedure For Batteries (8 AA Size Batteries)

(Battery Replacement Method)

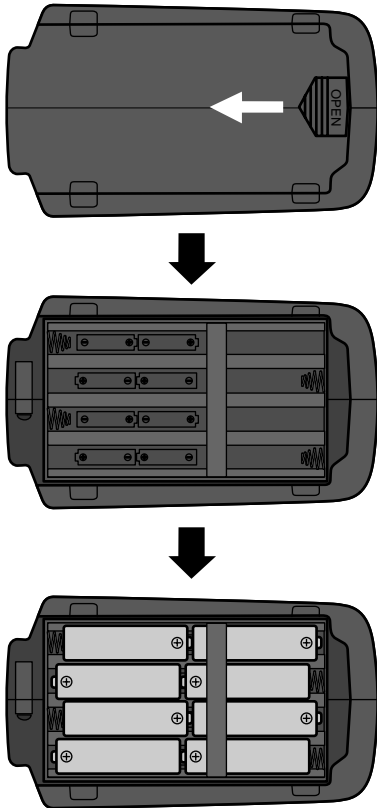

- 1** Remove the battery cover from the transmitter by sliding it in the direction of the arrow in the figure.
- 2** Remove the used batteries.
- 3** Load the new AA size batteries . Pay very close attention to the polarity markings and reinsert accordingly.
- 4** Slide the battery cover back onto the case.



(Check)

Turn the power switch on the transmitter to the ON position. Check to see if the two LEDs light. If the LEDs fail to light, check the batteries for insufficient contact in the case or incorrect battery polarity.

Caution

-  Always be sure you reinsert the batteries in the correct polarity order. If the batteries are loaded incorrectly , the transmitter may be damaged.
-  When the transmitter will not be used for any short or long period of time, always remove the batteries. If the batteries do happen to leak , clean the battery case and contacts thoroughly. Make sure the contacts are free of corrosion.

(Battery Disposal)

Some states require special handling when any type of battery is disposed. Contact the State Agency responsible for recycling hazardous waste for procedures in your area.

(Battery Alarm Display)

When the Green battery level indicator (LED) goes off and the Red LED flashes, change the batteries immediately.

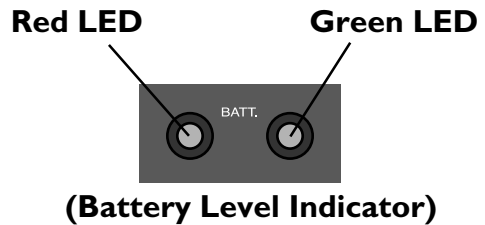

Receiver And Servo Connection

As you connect the receiver, servo's and other components, do so in accordance with the "Assembly Precautions" listed on the next page.

Connections when a E.S.C. MC230CR or MC330CR are used.

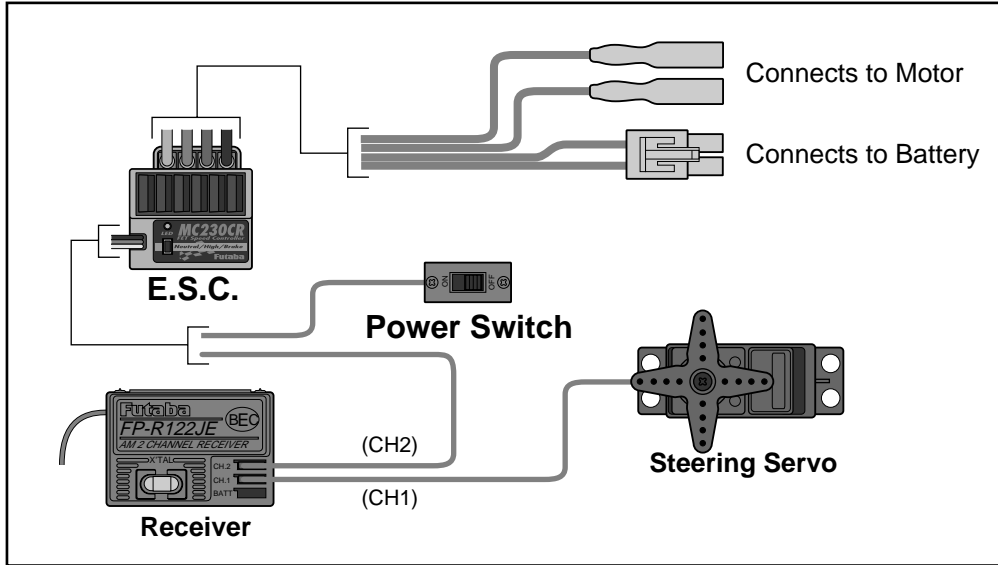

Gas Powered Model

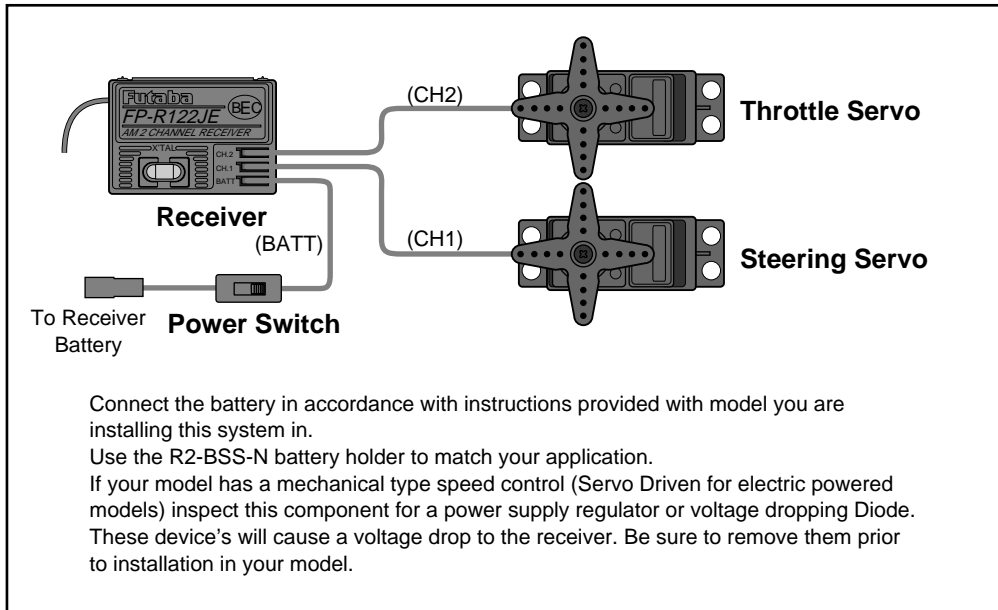

Assembly Precautions

Warning

Check

-  Check the receiver, servos, and battery connectors, to be sure they are firmly connected.
If a connector is not fully inserted, vibration may cause the connector to work loose while the model is operating. This will result in loss of control.

Check

-  Operate each servo horn over its full stroke and check to see that the linkage does not bind or is not too loose.
Excessive force applied to the servo horn by binding or poor installation may lead to servo problems and cause result in loss of control.

Prohibited

-  The receiver antenna may seem long. Do not cut or alter from the original length.
If the receiver antenna length is altered, the receiver will be adversely effected. The receiver will become considerably more susceptible to interference and high frequency noise which will result in loss of range and control.

Installation Note

-  (Electric Car's and Boat's)
Isolate the receiver from vibration by attaching to the chassis or mounting plate with thick double sided tape.
(Gas Powered Car's and Boat's)
Isolate the receiver from vibration by wrapping it in foam rubber or similar type cushioning material. Protect the unit from water damage by placing it in a plastic bag or waterproof radio box.
The receiver contains precision electronic parts. These parts are vulnerable to vibration and shock. Any contact with moisture (water or condensation) may cause receiver malfunction and loss of control.

Installation Note

-  Keep all devises that may omit high frequency noise, such as motor's, batteries, and wiring that handle heavy current loads, at least 1/2 inch away from the receiver and receiver antenna.
High frequency noise will cause a decrease in operating range and could cause loss of control.

Use genuine Futaba parts only.

-  Use only genuine Futaba crystal set's as specified in this instruction manual.
The use of other than Futaba crystal set's will result in decrease of range as well as loss of control. There are separate crystal's for the Transmitter and Receiver, there are also crystal set's for AM, FM and Dual Conversion FM. Use only single conversion AM crystal set's with this system.
Changing crystals in 72-75 MHz transmitter is illegal, however 27 MHz is allowable.
(For U.S.A.)



Install electronic speed control heat sinks as well as other components that conduct electricity so they can not come in contact with aluminum, carbon fiber or other materials that conduct electricity.

If for example the speed control came loose while the model was running and touched an aluminum chassis a short circuit may occur that would cause irreparable damage to the system as well as loss of control.

Installation Note



Noise suppression capacitors should be installed on almost all motors.

If the proper capacitors are not installed, high frequency noise will reduce range and cause loss of control along with various other problems.

Installation Note



Inspect all linkage installations and any point where metal could come in contact with other metal parts. Make sure these parts do not touch other metal parts under vibration.

Should a linkage or other metal parts come in contact with other metal parts under vibration the high frequency noise generated by this contact will cause interference and possible loss of control.

Caution

Disassembly Prohibited



Do Not disassemble any part of this system that is not specified in the instruction manual.

Futaba will not be responsible for any damage due to improper disassembly of any part of the radio control system.

Digital Proportional Adjustment

*When making these settings adjustments , do so with the motor disconnected or the engine not running.

Servo Horn Installation Instructions.

- 1 Connect the receiver, servos, and other components and then turn on the power switches to transmitter and receiver.
- 2 Be sure the Steering trim and Throttle trim on the transmitter are at their neutral position .
- 3 At this time install the servo horn in the manner described in the instruction manual provided with the model this system will be used in.

Both servos will move to the neutral position.

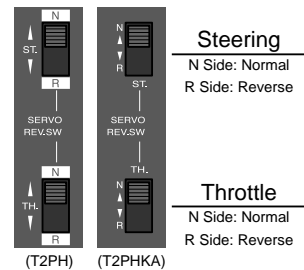
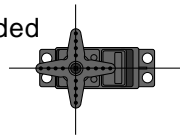

(Reversing Switches)

Reversing The Servo Operation Direction

Should the servo operate in the opposite direction required for your application, reverse the rotation with the reversing switch.

E.S.C. MC230CR / MC330CR

NEUTRAL, HIGH, AND BRAKE MAX POINTS SETTINGS

CAUTION

- 1 Set the steering angle adjustment function (ATV) to 100% and the ABS function and acceleration function to OFF using the transmitter throttle channel function. If the steering angle is too large or the ABS and acceleration functions are on, erroneous operation may occur.

*When using the ABS function, after setting up the MC230CR / MC330CR, stop the reverse function, then turn on the ABS function. If the ABS function is on, the MC230CR / MC330CR cannot be set up correctly.

Before setting each point, set the transmitter throttle channel trim to neutral.

- 1 Turn on the power in transmitter -> amp order.

	Transmitter throttle operation	MC230CR / MC330CR	
		(Pushbutton switch operation)	(Checker LED)
2 Neutral point setting	Neutral state	Press the pushbutton switch. (0.5 secs or longer) (Confirmation beep sounds)	LED Continuous single blink
3 High point setting	Full High N	Press the pushbutton switch. (Confirmation beep sounds)	LED Continuous double blink
4 Brake MAX point setting	Full brake N	Press the pushbutton switch. (Confirmation beep sounds.)	LED If the LED goes out, setting is complete.

If the LED does not go off but blinks rapidly, setting was not performed normally. Repeat setting from "Neutral point setting".



* Since the data is read at the end of setting of all points, the points cannot be set independently.
* If the amp power was turned off during setting, the setting points cannot be memorized. (The previous settings are retained.)
* The confirmation beep sounds only when the motor was connected.

Steering Trim

Steering neutral adjustments can be made by moving the Steering trim knob to the left or right.

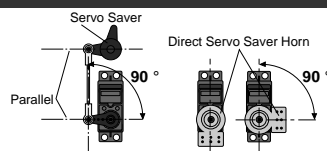

Racers Tip

When you install a servo always check to be sure the servo is at its neutral position. Adjust the servo horn hole position and linkage so both are parallel. When a servo saver is used place it as close to center position as possible. Be sure the steering trim on the transmitter is at the neutral position.

Trim Operation And Maximum Travel

Changing the trim can effect the overall settings, when adjustments are made with the trims recheck your installation for maximum servo travel. (Steering EPA right side and left side).

When Trim usage is extreme

If it takes most of your trim movement to get a servo to the neutral position, reposition the servo horn or servo saver on the servo and inspect your linkage installation.

Throttle Trim

Throttle neutral adjustments can be made moving the throttle trim to the left or right.

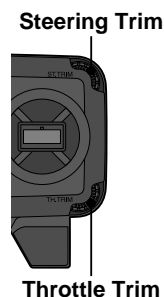

Racers Tip

When using a electronic speed control set the throttle trim to neutral and make adjustments to the speed control. On a gas powered model set the trim to neutral and adjust the linkage to the point where the carburetor is fully closed in accordance with the engine instruction manual.

Trim Operation and Travel

Trim adjustments will effect the overall servo travel, check the brake side (backward) movement when changes are made.

When trim movement is extreme

If you use most of the trim movement to get the servo to the neutral position , recenter the servo horn closer to the neutral position and inspect your throttle linkage.

Carburetor Fully Closed

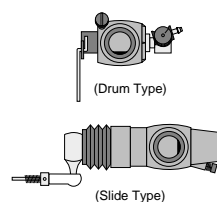

Servo Reverse

This function reverses the rotation direction of the Steering and Throttle servos.

When the trim position deviates from the center, the deviation will be on the opposite side when the servo is reversed.

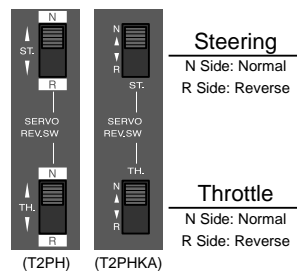

(Reversing Switches)

Steering EPA (only 2PHKA)

Use this function to limit the servo movement to the left or right. The servo travel to each side can be independently adjusted. This feature will compensate for any difference in right or left turning angles or radius due to the characteristics of your model.

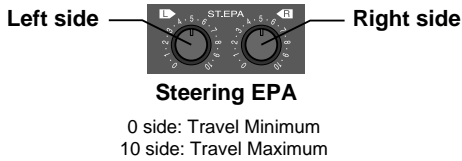

Warning

-  Be sure that the steering linkage does not bind or come in contact with any suspension parts or arms.
- If unreasonable force is applied to the servo, the servo may be damaged and result in loss of control.

Throttle EPA (only 2PHKA)

This function is used to adjust the forward and brake side servo travel. Each direction can be adjusted independent of each other. Use this feature to set the throttle servo travel.



Warning

-  Be sure that your throttle linkage does not apply excessive force to the servo.
- If your linkage installation causes an unreasonable amount of force to be applied to the servo, the servo may be damaged and result in loss of control.

Steering D/R (only 2PHKA)

Use this function to adjust the steering travel of your model. If the model understeers (push) while cornering, add steering by turning the dial clockwise. When the model oversteers (loose), take away steering by turning the dial counterclockwise.

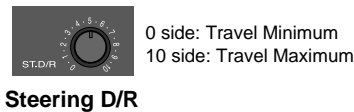

MC230CR / MC330CR

CANCELLING THE REVERSE FUNCTION

The amp reverse function can be cancelled by the following method so that the model can be used even in races that prohibit reverse running. (Brake operation only)

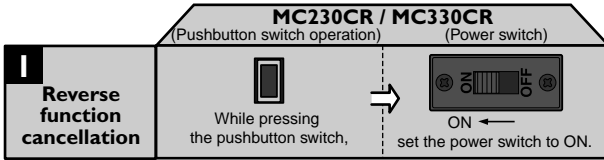

* When desired, you can enable the cancelled reverse function by repeating the operation shown at the left. (The reverse function is switched alternately.)

BRAKE/REVERSE OPERATING INSTRUCTIONS

Operation can be switched to reverse operation by returning the throttle trigger (or throttle stick) from the brake position to the neutral position.







PROTECTION CIRCUIT OPERATION

The following protection circuits are built into the MC230CR / MC330CR. When a protection circuit operates, remove the cause before operating the model again.

Overcurrent protection	When an overcurrent flows due to an output short circuit, etc., the overcurrent protection circuit automatically limits the current to protect the FET. ⇒ Remove the cause of the short circuit, etc. before operating the model again.
Heat protector	When abnormal heating of the FET due to an overload, etc. is detected, the heat protector operates so that the speed is gradually reduced. ⇒ When the FET temperature drops, the heat protector automatically resets. However, remove the cause of the overheating before operating the model again.
Low voltage operation	When the Nicd battery voltage drops, this function limits the motor output current and ensures steering operation. ⇒ After the speed drops, immediately recover the vehicle.

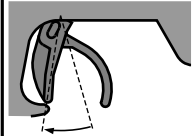
CHECKER LED DISPLAY

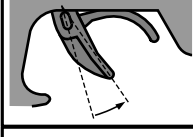
The amp operates linearly in proportion to the amount of forward, reverse, and brake operation. The amp operating state can be checked with the checker LED as shown below.

Operation	Checker LED display
Amp power ON	(Reverse operation set) Single blink (Single confirmation beep)  (Only brake operation set) Double blink (Two confirmation beeps) 
 High point Forward	Off On *Becomes brighter nearer the high point.
 Neutral point	Off
 Reverse /brake Brake MAX point	On *Becomes brighter nearer the brake MAX point. Off
(Amp power left on alarm) When the transmitter power was turned off first.	Blinks. (Confirmation beep also sounds.)  *Not used with PCM receivers. *When the transmitter is OFF, this function is not performed in environments such that the servo operates erroneously.

* Confirmation beep only sounds when the motor was connected.

*Specifications and ratings are subject to change without prior notice.

Ratings

Transmitter T2PH / T2PHKA

(2 channels, AM transmitter)
 Transmitting frequency:
 27, 29, 40, 41, 72 or 75 MHz
 Modulation method: AM
 Power requirement:
 12V (penlight battery X 8)
 Current drain: 250mA

Receiver R122JE

(2 channels, AM receiver)
 Receiving frequency:
 27, 29, 40, 41, 72 or 75 MHz
 Intermediate frequency: 455kHz
 Power requirement: 4.8 - 8.4V
 Current drain: 30mA (at 4.8V / No signal)
 Size: 47.2X33.3X17.3mm
 Weight: 16.6g

Servo S3003

(standard servo)
 Power requirement:
 4.8V or 6V (common with receiver)
 Current drain: 8mA (at 6V / Idle)
 Output torque: 3.2kg-cm (at 4.8V)
 Operating speed: 0.23sec/60 degree (at 4.8V)
 Size: 40.4x19.8x36mm
 Weight: 37.2g

E.S.C. MC230CR / MC330CR

(Electronic speed control)
 Operating system: Forward, reverse, and brake operations are all linear.
 Power requirement: Nicd battery 6-7 cells
 7.2 to 8.4V
 PWM frequency: 1.5kHz (fixed)
 Setting: One-touch input by pushbutton switch.
 Set data is saved to built-in EEPROM.
 Current capacity (FET rating):
 Forward=90A/200A, reverse=45A/100A
 Case size: 27.1x33.3x12.8mm
 (excluding protruding parts)
 Silicon cord gauge size:
 AWG16/AWG14 equivalent
 Weight: 44/45g
 (including connectors and switches)
 BEC voltage: 6.0V

Troubleshooting

If your digital proportional R/C set does not operate, its range is short, it intermittently stops operating, or it operates erroneously, take the action shown in the table below. If this does not correct the trouble, please contact a Futaba dealer.

Check point	Check item	Action
Transmitter/receiver battery	Dead battery.	Replace the battery. Charge the nicd battery.
	Incorrect loading.	Reload the batteries in the correct polarity.
	Faulty contact connection.	If the contact spring is deformed, correct it.
	Dirty contacts.	Wipe with a dry cloth.
Transmitter antenna	Loose.	Screw in.
	Not extended to full length.	Extend fully.
Crystal	Disconnected.	Push in.
	Wrong band.	Match transmitter/receiver band.
	Different from specification.	Replace with specified crystal.
Connector connection	Incorrect wiring.	Reinsert.
	Disconnection.	Push in.
Receiver antenna	Close to other wiring.	Separate from other wiring.
	Not cut?	Request repair.
	Not bundled?	Install in accordance with instruction manual.
Servo linkage	Binding or looseness	Adjust at the model side.
Motor	Noise countermeasures.	Install a noise absorbing capacitor.

FUTABA CORPORATION

Makuhari Techno Garden Bldg., B6F 1-3 Nakase, Mihama-ku, Chiba 261-8555, Japan
Phone: (043) 296-5119 Facsimile: (043) 296-5124

©FUTABA CORPORATION 2001, 07