

# Throttle acceleration (TH-ACCEL (Throttle system))

Gasoline engine cars have a small time lag at both the forward side and brake side because a certain clearance is necessary at the linkage. Reducing this time lag at the transmitter side provides the same sharp response as electric motor cars.

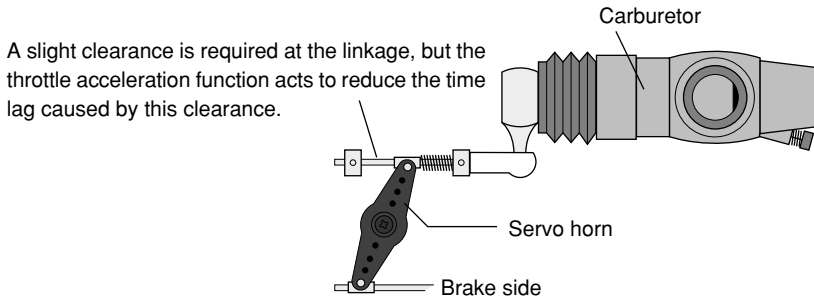

## Operation

- Operation near the throttle trigger neutral position becomes a sharp rise.
- The forward and brake sides can be set separately.

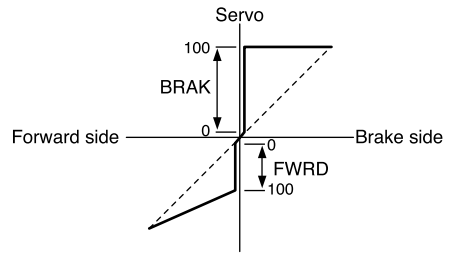

## Set value

The standard value (100% point) of this setup effects the operation amount set by throttle EPA function.

### Calling the setup screen

\* Calling from menu screen (Initial screen)

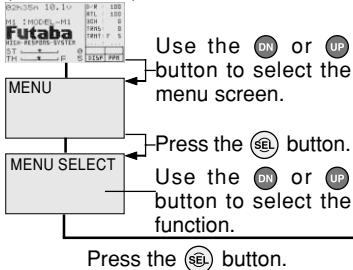

Use the **DN** or **UP** button to select the setup item.

\* **▶** blinks at the current setup item.

\* When the direct call button is set, the setup screen is also called by the following method:

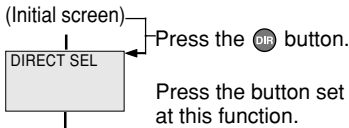

Setup items

FWRD : Forward side acceleration amount

BRAK : Brake side acceleration amount

## Throttle acceleration adjustment

(Preparation)

- Select setup item "FWRD" and make the following adjustments.

Adjustment buttons

- Use the (+) and (-) buttons to make adjustments.
- Press the (+) and (-) buttons simultaneously (approx. 1 sec) to return to the initial screen.

### 1 (Forward acceleration amount adjustment)

Use the (+) and (-) buttons to adjust the acceleration amount.

"0": No acceleration

"100": Maximum acceleration (Approximately 1/2 of the forward side steering angle)

Forward acceleration amount

0~100

Initial value: 0

### 2 (Brake side acceleration amount adjustment)

Select setup item "BRAK" by pressing the (DN) button once and use the (+) and (-) buttons to adjust the acceleration amount.

"0": No acceleration

"100": Maximum acceleration (Brake side maximum steering angle)

Brake side acceleration amount

0~100

Initial value: 0

3 When ending adjustment, return to the initial screen by pressing the (END) button 3 times.

# Start Function, Engine Cut/AT-START(Throttle system)

When the throttle trigger is set to full throttle simultaneously with starting when the track is slippery, the car wheels will spin and the car will not accelerate smoothly. When the Start function is activated, merely operating the throttle trigger slowly causes the throttle servo to automatically switch from the set trigger position to a preset point so that the tires do not lose their grip and the car accelerates smoothly.

## Without Start function

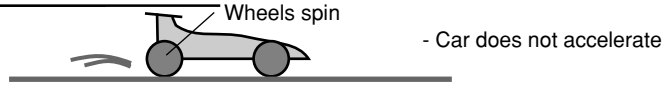

## With Start function

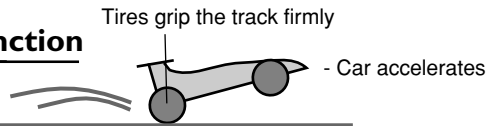

## Start Function Operation

- When the throttle stick is moved to the preset position (throttle position: TG.P), the throttle servo moves to the preset position.
- When the throttle stick is operated slowly so that the wheels will not spin, the car automatically accelerates to the set speed.
- This function is effective only for the first throttle trigger operation at starting. This function has to be activated before every start.
- When the throttle trigger is returned slightly, the Start function is automatically deactivated and the set returns to normal throttle trigger operation.

## Engine Cut Function

When the switch is pressed, the throttle servo will move to the preset position without regard to the throttle trigger position. This is convenient when used to cut the engine of boats, etc. (The function select switch function. Page )

### Calling the setup screen

\* Calling from menu screen (Initial screen)

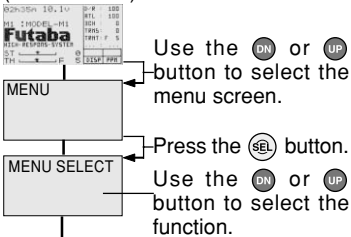

Press the **SEL** button.

\* When the direct call button is set, the setup screen is also called by the following method:

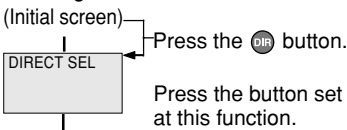

Use the **DN** or **UP** button to select the setup item.

\* **▶** blinks at the current setup item.



Function selection  
First, select the function at the "MODE" item.  
"AT&SW": Start function  
"SW": Engine Cut function

## Start function adjustment

(Preparation)

- Select function "AT&SW" at setup item "MODE".
- Select setup item "TG.P" and make the following adjustments.

```
AUTO-START          9.7V
ATS : OFF
TG.P▶ 5
PRST: 0
MODE: AT&SW (OFF)
```

### 1 (Trigger position setup)

Set the trigger position by pressing the (+) or (-) button.

Setup items

ATS: READY setting  
TG.P: Trigger position  
PRST: Preset position  
MODE: Function selection

Setup item switching

- Use the (DN) or (UP) button to switch the setup item.

Trigger position

5 ~ 95

Initial value: 5

### 2 (Preset position setup)

Select setup item "PRST" by pressing the (DN) button and use the (+) and (-) buttons to set the preset position of the throttle servo.

"B100" ~ "B1" : Brake side

"0" : neutral

"F1" ~ "F100" : Forward side

**Setting Example: (When amp used with an electric car)**

Set the preset position to F75% at EPA100%.

Preset position

B100 ~ B1, 0, F1 ~ F100

Initial value: 0

Adjustment buttons

- Use the (+) and (-) buttons to make adjustments.

- Press the (+) and (-) buttons simultaneously (approx. 1 sec) to return to the initial screen.

### 3 ("READY" setting)

Select setup item "ATS" by pressing the (UP) button twice, and press the (+) and (-) buttons simultaneously for about 1 second. "READY" blinks on the screen and the system enters the READY state. Trigger operation starts the function.

READY setting

OFF: off state

READY: Ready state

ACT: on state

### 4 When ending adjustment, return to the initial screen by pressing the (END) button 3 times.

-If the throttle trigger is moved to the set position while 'READY' is flashing, the throttle servo will move to the set position. The throttle operation wait state is reset when the throttle trigger is returned.

-When using the Start function, always set the function by performing step 3 above each time.

## Engine Cut function adjustment

(Preparation)

- Use the function select switch function (page ) to select the switch.
- Select function "SW" at setup item "MODE".
- Select setup item "PRST" and make the following adjustments.

```
AUTO-START          9.7V
ATS : (INH)
TG.P : (INH)
PRST▶  0
MODE:  SW  (OFF)
```

Setup items

PRST: Preset position

MODE: Function selection

Setup item switching

- Use the (DN) or (UP) button to switch the setup item.

### 1 (Preset position setup)

Use the (+) and (-) buttons to set the preset position of the throttle servo.

"B100" ~ "B1" : Brake side

"0" : neutral

"F1" ~ "F100" : Forward side

Preset position

B100 ~ B1, 0, F1 ~ F100

Initial value: 0

Adjustment buttons

- Use the (+) and (-) buttons to make adjustments.
- Press the (+) and (-) buttons simultaneously (approx. 1 sec) to return to the initial screen.

### 2 When ending adjustment, return to the initial screen by pressing the (END) button 3 times.

## Servo Throw

The throttle servo operating position (preset position) set by this setting is unrelated to the setting of other functions. Maximum to minimum servo travel can be set. However, the reverse function setting is enabled.

## Brake mixing/BRAKE MIXING (Throttle, 3rd channel system)

Use this mixing when the front and rear brakes must be adjusted independently such as 1/5GP cars, etc. This mixing uses the 2nd channel to control the rear brakes and the 3rd channel to control the front brakes.

### Operation

- When braking, mixing is applied to 2nd channel ? 3rd channel.
- Mixing rate, delay amount, brake amount balance and operation point setting are possible.
- Whether or not the set value of other related brake side functions is reflected can be selected.

(Related functions) EPA, ATL, TH-EXP, A.B.S., and TH-ACCEL functions

### Button trim setup

The function select trim function can control mixing rate (RATE), delay amount (DLY), and brake amount balance (BALN) setting using grip dials DL1 and DL2 and dial trim D3, etc. (Page )

#### Calling the setup screen

##### \* Calling from menu screen (Initial screen)

Use the **DN** or **UP** button to select the menu screen.

Press the **SEL** button.

Use the **DN** or **UP** button to select the function.

Press the **SEL** button.

\* When the direct call button is set, the setup screen is also called by the following method:

(Initial screen)

Press the **DIR** button.

Press the button set at this function.

Use the **DN** or **UP** button to select the setup item.

\* **▶** blinks at the current setup item.

Setup items

RATE: Mixing rate

DLY: Delay amount

BALN: Brake amount balance

TGP: Operation point

MXMD: Mix mode

MODE: Function ON/OFF

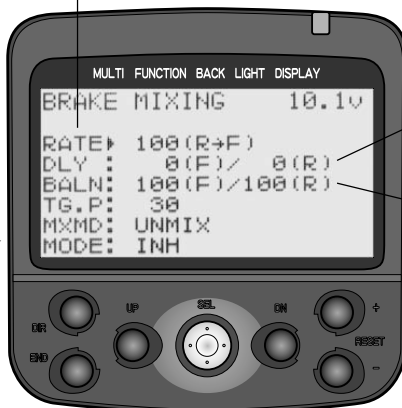

\* Delay amount setting becomes "0" at either the F side or the R side, at least.

\* Brake amount balance setting becomes "0" at either the F side or the R side, at least.

## Brake mixing adjustment

(Preparation)

- Select setup item "MODE" and make the following adjustments.

### 1 (Function ON/OFF)

Set the function to the "ACT" state by pressing the (+) or (-) button.

"INH": Function OFF

"ACT": Function ON

Adjustment buttons

- Use the (+) and (-) buttons to make adjustments.

- Press the (+) and (-) buttons simultaneously (approx. 1 sec) to return to the initial screen.

Function ON/OFF

INH, ACT

### 2 (Mixing amount adjustment)

Select setup item "RATE" by pressing the (DN) button five times, and use the (+) and (-) buttons to adjust the mixing amount.

- Mixing amount can be adjusted within the 0~120% range.

Mixing rate

0 ~ 100 ~ 120

Initial value: 100

### 3 (Delay amount setup)

Select setup item "DLY" by pressing the (DN) button once, and use the (+) and (-) button to adjust the delay amount.

"0": No delay

"100": Maximum delay amount

- This system sets either the "F" side or "R" side delay.

Delay amount (DLY)

0~100 (both F and R)

However, at least one must be "0".

Initial value: 0

### 4 (Brake amount balance setup)

Select setup item "BALN" by pressing the (DN) button once, and use the (+) and (-) buttons to adjust the brake amount balance.

- Brake amount balance can be adjusted within the "80"~"100" range.

- This system sets the brake amount balance by lowering either the "F" side or "R" side.

Brake amount balance (BALN)

80~100 (Both F and R)

However, at least one must be "100".

Initial value: 100

### 5 (Operation point setup)

Select setup item "TGP" by pressing the (DN) button once, and use the (+) and (-) buttons to set the operation point.

- Brake mixing can be applied from any throttle trigger position. The number is % display with the full brake position as 100.

(Remark)The prescribed delay may not be obtained even when setting the delay, depending on the balance with trigger operation speed.

Operation point

10 ~ 100

Initial value: 30

### 6 (Mixing mode setup)

Select setup item "MXMD" by pressing the (DN) button once, and use the (+) or (-) button to select the mixing mode.

"UNMIX": Mixing proportional to throttle trigger operation.

"MIXED": Mixing with brake side data set by another function considered.

Mixing mode

UNMIX, MIXED

Initial value: UNMIX

7 When ending adjustment, return to the initial screen by pressing the (END) button 3 times.

# Idle-Up/IDLE-UP(Throttle system)

Use this function to improve the starting characteristics of the engine by raising the idling speed when starting the engine of a gas powered car.

## Operation

Offsets the throttle neutral position to the forward side or brake side.

## Switch Setting

Select the idle-up function ON/OFF switch with the function select switch function. (Page )

## Operation Display

When this function is activated, the LED flashes.

If the power switch is turned on while the idle-up switch is on, an audible alarm will be heard. Immediately set the Idle-Up switch to OFF.

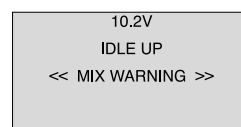

( Warning display )

### Calling the setup screen

\* Calling from menu screen (Initial screen)

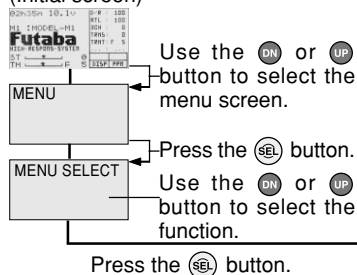

\* When the direct call button is set, the setup screen is also called by the following method: (Initial screen)

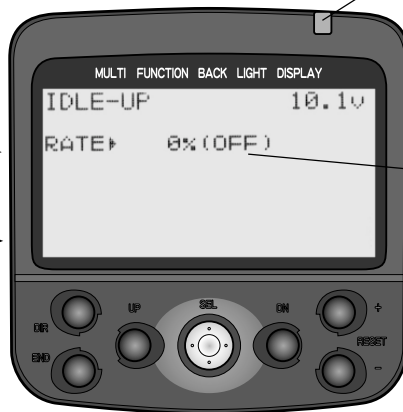
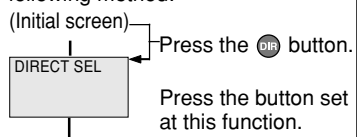

\* The LED blinks while the Idle-Up function is on.

\* Idle-Up on/off state.

Adjustment buttons  
 - Use the (+) and (-) buttons to make adjustments.  
 - Press the (+) and (-) buttons simultaneously (approx. 1 sec) to return to the initial screen.

## Idle-Up function adjustment

(Preparation)

- Use the function select switch function (page ) to select the switch.

### 1 (Idle-Up rate)

Use the (+) and (-) buttons to set the Idle-Up rate.

2 When ending adjustment, return to the initial screen by pressing the (END) button 3 times.

Idle-Up rate  
 D50% ~ D1%, 0%, U1% ~ U50%  
 Initial value: 0%  
 "D": Brake side  
 "U": Forward side



## Timer/TIMER

Use the timer by selecting one of the four timers UP TIMER, DOWN TIMER, LAP TIMER and LAP NAVIGATE timer.

### UP TIMER

#### UP TIMER function

- The UP TIMER can be used to count the time between start and stop, etc.
- The timer repeatedly starts and stops each time the switch is operated and accumulates the time between each start and stop. (When the count reaches 99 minutes 99 seconds, it returns to 00 minutes 00 seconds and repeats the count.)
- The first start operation can be linked to the throttle trigger.
- An alarm sound can be set. The passage of time is announced by sounding of a buzzer ([pee] sound) each minute after starting.

Alarm: Generates a [pee] sound at the set time (minutes).

Prealarm: Alarm advance announcement sound.

Sounding starts the set time (seconds) before the alarm.

(PeePeePee, PeePeePee, -----)

- After starting, the timer is enabled and can be stopped by switch even when the display switches to another screen.

```
RACING TIMER 10.1v
RST: 00m 00s 00
ALRM: 4m
PRAL: OFF
TYPE: UP TIMER
```

### DOWN TIMER

#### DOWN TIMER function

- The DOWN TIMER can be used to count the time between start and stop, etc. (The time remaining is displayed.)
- Start and stop are repeated at each switch operation and the time between each start and stop is counted down and displayed. The start time becomes the alarm set time. (When the count reaches 00 minute 00 second, the down timer operates like an up timer.)
- The first start operation can be linked with the throttle trigger.
- An alarm sound can be set. The passage of time is announced by sounding of a buzzer ([pee] sound) each minute after starting.

Alarm: Generates a [pee] sound at the set time (minute).

Prealarm: Alarm advance announcement sound.

Sounding starts the set time (seconds) before the alarm.

(PeePeePee, PeePeePee, -----)

- After starting, the timer is enabled and can be stopped by switch even when the display switches to another screen.

```
RACING TIMER 10.2v
RST: 04m 00s 00
ALRM: 4m
PRAL: OFF
TYPE: DOWN TIMER
```

# LAP TIMER

## LAP TIMER function

- The LAP TIMER can memorize each lap time of each switch operation. (99 laps)
- The race time can be set. Switch operation after the set time by alarm has elapsed automatically stops the timer.. Prealarm can also be set. The passage of time is announced by sounding of a buzzer ([Pee] sound) each minute after starting.

Alarm: Generates a [Pee] sound at the set time.

Prealarm: Starts sounding the set time (second) before the alarm. (PeePeePee, PeePeePee, -----)

- The first start operation can be linked with the throttle trigger.

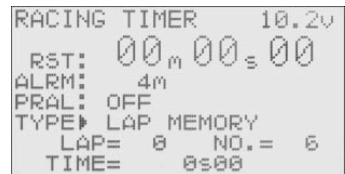

```
RACING TIMER 10.2V
RST: 00m 00s 00
ALRM: 4m
PRAL: OFF
TYPE▶ LAP MEMORY
LAP= 8 NO.= 6
TIME= 0s00
```

(LAP TIMER operation)

- When lap timer is selected, the number of laps (LAP) and the lap memory No. (No.) and current lap time (TIME) are displayed on the setup screen.

Number of laps (LAP): Counts up each time the switch is pressed after starting. The numbers blink for 3 seconds after the switch was pressed. To prevent erroneous counting, switch operation is not accepted during this period..

Lap memory No. (No.): Each lap time is memorized in a lap memory. The lap times are written sequentially from the number after the preceding data. After lap memory "No. 100", the lap No. returns to "No. 1".

The lap time data memorized in the lap memory can be checked at the lap list (page ) screen.

Lap time (TIME) : During the first 3seconds, the last lap time is displayed and then the current lap time is displayed. At starting, "0" is displayed for 3 seconds.

# LAP NAVIGATE timer

## LAP NAVIGATE timer function

- This function sounds a buzzer at a fixed interval after the timer starts. Since only the buzzer can be restarted when the switch is pressed during timer operation, this function can be used as the training run, etc. target time. (Lap navigation alarm) The passage of time is announced by sounding of a buzzer ([Pee] sound) every minute after starting.

- The first start operation can be linked with the throttle trigger.

- The alarm sounds (alarm/prealarm) can be set separately from the fixed interval buzzer.

Alarm: Generates a [Pee] sound at the set time (minutes).

Prealarm: Alarm advance announcement sound.

Sounding starts the set time (seconds) before the alarm.

(PeePeePee, PeePeePee, -----)

- After starting, the timer is enabled and can be stopped by switch even when the display switches to another screen.



### Calling the setup screen

\* Calling from menu screen (Initial screen)

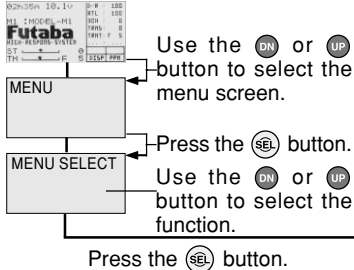

\* When the direct call button is set, the setup screen is also called by the following method:

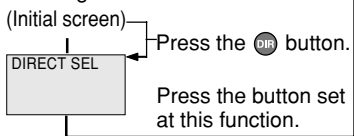

Use the **DN** or **UP** button to select the setup item.

\* **\*** blinks at the current setup item.

- \* Minute display (m)
- \* Second display (s)
- \* 1/100 second display

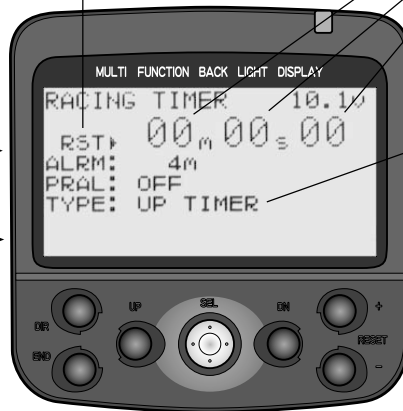

Timer selection  
First, select the type of timer at the "TYPE" item. The setup screen varies depending on the type of timer. This figure shows the UP TIMER setup screen.

- Timer selection (TYPE)
- UP TIMER: Up timer
  - DOWN TIMER: Down timer
  - LAP MEMORY: Lap timer
  - LAP NAVIGATE: Navigation timer

## Up timer setup

(Preparation)

- Use the function select switch function (page ) to select the switch.
- Select "UP TIMER" at setup item "TYPE".

Setup items  
RST: (Indicates the reset state)  
ALRM: Alarm setup  
PRAL: Prealarm setup  
TYPE: Timer selection



Setup item switching  
- Use the (DN) or (UP) button to switch the setup item.

Switches  
LAP START: Start/stop  
LAP RESET: Lap reset

\* Timer display  
Status display  
RST: Reset state  
RDY: Trigger operation wait  
RUN: Timer running  
STP: Timer stopped

Adjustment buttons  
- Use the (+) and (-) buttons to make adjustments.  
- Press the (+) and (-) buttons simultaneously (approx. 1 sec) to return to the initial screen.

Alarm time  
OFF, 1 ~ 99 m  
Initial value: 4 m

### 1 (Alarm time setup)

Select setup item "ALRM" by pressing the (UP) button twice, and use the (+) and (-) buttons to set the alarm time.

### 2 (Prealarm time setup)

Select setup item "PRAL" by pressing the (DN) button once, and use the (+) and (-) buttons to set the prealarm time.

Prealarm time  
OFF, 1 ~ 30 s  
Initial value: 5 s

### 3 (Linking start with the trigger)

Select setup item "RST" by pressing the (UP) button twice, and press the (+) and (-) buttons simultaneously for about 1 second. A PeePee sound is generated and "RST" > "RDY" blinks at the timer display and the system enters the RDY state. Trigger operation starts the timer.

### 4 When ending adjustment, return to the initial screen by pressing the (END) button 3 times.

### (Timer start/stop operation)

The switch (LAP START) preset by function select switch function (page ) starts the timer. Only starting can be linked with the throttle trigger.

### (Timer reset operation)

In the timer-stopped state, the switch (LAP RESET) preset by function select switch function (page ) resets the timer.

## DOWN TIMER setup

(Preparation)

- Use the function select switch function (page ) to select the switch.
- Select "DOWN TIMER" at setup item "TYPE".

Setup items  
RST: (Indicates the reset state.)  
ALRM: Alarm setup  
PRAL: Prealarm setup  
TYPE: Timer selection



Switches  
LAP START: Start/stop  
LAP RESET: Reset

\* Timer display

Status display  
RST: Reset state  
RDY: Trigger operation wait  
RUN: Timer running  
STP: Timer stopped

Setup item switch  
- Use the (DN) and (UP) buttons to switch the setup item.

Adjustment buttons  
- Use the (+) and (-) buttons to make adjustments.  
- Press the (+) and (-) buttons simultaneously (approx. 1 sec) to return to the initial screen.

### 1 (Alarm time setup)

Select setup item "ALRM" by pressing the (UP) button twice, and use the (+) and (-) buttons to set the alarm time.

Alarm time  
OFF, 1 ~ 99 m  
Initial value: 4 m

### 2 (Prealarm time setup)

Select setup item "PRAL" by pressing the (DN) button once, and use the (+) and (-) buttons to set the prealarm time.

Prealarm time  
OFF, 1 ~ 30 s  
Initial value: 5 s

### 3 (Linking start with trigger)

Select setup item "RST" by pressing the (UP) button twice, and press the (+) and (-) buttons simultaneously for about 1 second. A PeePee sound is generated and "RST" > "RDY" blinks on the timer display and the system enters the RDY state. Trigger operation starts the timer.

### 4 When ending adjustment, return to the initial screen by pressing the (END) button 3 times.

### (Timer start/stop operation)

The switch (LAP START) preset by function select switch function (page ) starts the timer. Only start can be linked with the trigger.

### (Timer reset operation)

In the timer-stopped state, the switch (LAP RESET) preset by function select switch function resets the timer.

## Lap timer setup

(Preparation)

- Use the function select switch function (page ) to select the switch.
- Select "LAP MEMORY" at setup item "TYPE".

Setup items

RST: (Indicates the reset state.)  
 ALRM: Alarm setup  
 PRAL: Prealarm setup  
 TYPE: Timer selection

Setup item switching

- Use the (DN) or (UP) button to switch the setup item.

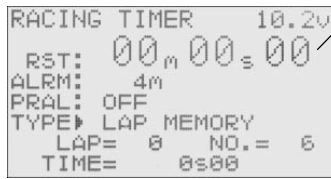

Switches

LAP START: Start/stop  
 LAP RESET: Stop/reset

\* Timer display

Status display

RST: Reset state  
 RDY: Trigger operation wait  
 RUN: Timer running  
 STP: Timer stopped

Adjustment buttons

- Use the (+) and (-) buttons to make adjustments.  
 - Press the (+) and (-) buttons simultaneously (approx. 1 sec) to return to the initial screen.

Alarm time

OFF, 1 ~ 99 m  
 Initial value: 4 m

### 1 (Alarm time setup)

Select setup item "ALRM" by pressing the (UP) button twice, and use the (+) and (-) buttons to set the alarm time.

### 2 (Prealarm time setup)

Select setup item "PRAL" by pressing the (DN) button once., and use the (+) and (-) buttons to set the prealarm time.

Prealarm time

OFF, 1 ~ 30 s  
 Initial value: 5 s

### 3 (Linking start with the trigger)

Select setup item "RST" by pressing the (UP) button twice, and press the (+) and (-) buttons simultaneously for about 1 second. A PeePee sound is generated and "RST" > "RDY" blinks on the timer display and the system enters the RDY state. Trigger operation starts the timer.

### 4 When ending adjustment, return to the initial screen by pressing the (END) button three times.

### (Timer start/lap counting operation)

The switch (LAP START) preset by function select switch function (page ) performs the timer and lap counting operation. Only start can be linked with the throttle trigger.

### (Timer stop/reset operation)

The switch (LAP RESET) preset by function select switch function (page ) performs

## Navigation timer setup

(Preparation)

- Use the function select switch function (page ) to select the switch.
- Select "LAP NAVIGATE" at setup item "TYPE".

Setup items

RST: (Indicates the reset state.)  
ALRM: Alarm setup  
PRAL: Prealarm setup  
TYPE: Timer selection  
LAP: Navigation alarm setup



RACING TIMER 10.2v  
RST: 00m 00s 00  
ALRM: 4m  
PRAL: OFF  
TYPE: LAP NAVIGATE  
LAP: 3s00  
PRE: OFF

Switches

LAP START: Start/navigation alarm restart  
LAP RESET: Stop/reset

\* Timer display

Status display

RST: Reset state  
RDY: Trigger operation wait  
RUN: Timer running  
STP: Timer stopped

Adjustment buttons

- Use the (+) and (-) buttons to make adjustments.
- Press the (+) and (-) buttons simultaneously (approx. 1 sec) to return to the initial screen.

Alarm time

OFF, 1 ~ 99 m  
Initial value: 4 m

Prealarm time

OFF, 1 ~ 30 s  
Initial value: 5 s

Lap NAVI alarm time

3 s ~ 30 m  
Initial value: 3 s

Setup item switching

- Use the (DN) and (UP) buttons to switch the setup item.

### 1 (Alarm time setup)

Select setup item "ALRM" by pressing the (UP) button twice, and use the (+) and (-) buttons to set the alarm time.

### 2 (Prealarm time setup)

Select setup item "PRAL" by pressing the (DN) button once, and use the (+) and (-) buttons to set the prealarm time.

### 3 (Lap navigation alarm time setup)

Select setup item "LAP" by pressing the (DN) button twice, and use the (+) and (-) buttons to set the lap navigation alarm time.

### 4 (Linking start with trigger)

Select setup item "RST" by pressing the (UP) button twice and press the (+) and (-) buttons simultaneously for about 1 second. A PeePee sound is generated and "RST" > "RDY" blinks at the timer display and the system enters the RDY state.

5 When ending adjustment, return to the initial screen by pressing the (END) button 3 times.

### (Timer start/lap navigation alarm restart operation)

The switch (LAP START) preset by function select switch function (page ) performs the timer start/lap navigation alarm restart operation. Only start is linked with the throttle trigger.

### (Timer stop/reset operation)

The switch (LAP RESET) preset by function select switch function (page ) performs the timer stop/reset operation. It resets the timer when operated in the timer-stopped state.

# Lap list/LAP-LIST

Call LAP-LIST when checking the lap memory data (each lap time) memorized by lap timer (page ) operation.

- After the lap timer is started, the lap time is sequentially memorized at each switch operation.
- When the timer is stopped, the final lap is memorized and the total time is automatically written to the next memory after the final lap.
- The next lap timer is memorized from the number after the total time.

- \* Lap memory No. display
- \* Lap time display
- \* The lap time and total time after the final lap time are memorized in the lap memory. "LAP" represents the lap time and "TOTAL" represents the total time.

## Calling the setup screen

\* Calling from menu screen  
(Initial screen)

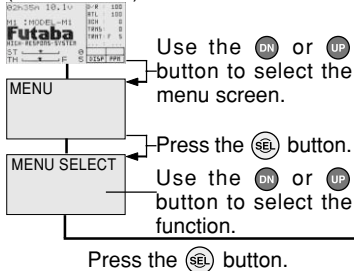

\* When the direct call button is set, the setup screen is also called by the following method:

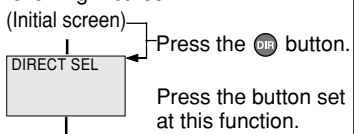

## (Lap memory reset)

Use the (DN) or (UP) button to select lap memory No., and reset the lap memory by pressing the (+) and (-) buttons simultaneously for about 1 second.

## (Lap memory entire data reset)

Pressing the (+) and (-) buttons simultaneously for about 1 second while pressing the (SEL) button, resets all the data.



# Program Mixing 1,2/PRG-MIX1,2

These functions allow you to apply mixing between the steering, throttle, and channel 3 channels.

Two programmable mixing systems can be used. The programmable mixing 1 and programmable mixing 2 set-up screens are independent.

## Additional Functions

- When the steering or throttle channel is the master channel (channel that applies mixing), trim data can be added.
- The mixing mode selection. (Master mixing mode)
- The master channel mixing center point (point at which the direction changes) can be offset.

### Calling the setup screen

\* Calling from menu screen (Initial screen)

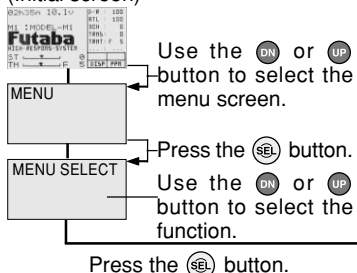

\* When the direct call button is set, the setup screen is also called by the following method: (Initial screen)

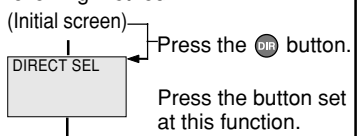

Use the **DN** or **UP** button to select the setup item.

\* **▶** blinks at the current setup item.

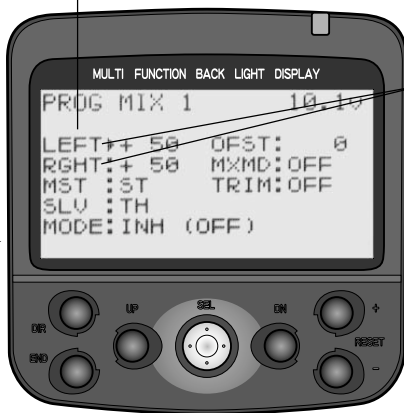

Setup items

- LEFT: Mixing rate (Left side)
- RGHT: Mixing rate (Right side)
- MST : Master channel
- SLV : Slave channel
- MODE: Function ON/OFF
- OFST : Offset
- MXMD: Mix mode
- TRIM : Trim mode

\* These setup items are different depend on the master channel.  
Upper side : LEFT/FWRD/UP  
Lower side : RGHT/BRAK/DOWN

Adjustment buttons

- Use the (+) and (-) buttons to make adjustments.
- Press the (+) and (-) buttons simultaneously (approx. 1 sec) to return to the initial screen.

## Program mixing adjustment

(Preparation)

- Use the function select switch function (page ) to select the switch. (as desired)
- Select setup item "MODE" and make the following adjustments.

Switch

- PROG MIX1 : Program mixing 1
- PROG MIX2 : Program mixing 2

## 1 (Function ON/OFF)

Set the function to the "ACT" state by pressing the (+) or (-) button.

"INH": Function OFF, "ACT": Function ON

Function ON/OFF  
INH, ACT

## 2 (Master channel)

Select setup item "MST" by pressing the (UP) button twice, and select the master channel by pressing the (+) or (-) button.

Channel selection  
ST, TH, CH3  
Initial value: ST

## 3 (Slave channel)

Select setup item "SLV" by pressing the (DN) button once, and select the slave channel by pressing the (+) or (-) button.

Channel selection  
ST, TH, CH3  
Initial value: TH

## 4 (Mixing amount adjustment)---upper item

Select setup item "LEFT" etc. by pressing the (UP) button three times, and use the (+) and (-) buttons to adjust the mixing amount.

Mixing amount  
-100~+50~+100  
Initial value: +50

## 5 (Mixing amount adjustment)---lower item

Select setup item "RGHT" etc. by pressing the (DN) button once, and use the (+) and (-) buttons to adjust the mixing amount.

Mixing amount  
-100~+50~+100  
Initial value: +50

## 6 (Offset amount setup)

Select setup item "OFST" by pressing the (DN) button twice, and use the (+) and (-) button to adjust the offset amount.

Offset amount  
-100~0~+100  
Initial value: 0

## 7 (Mixing mode setup)

Select setup item "MXMD" by pressing the (DN) button once, and use the (+) or (-) button to select the mixing mode.

"OFF": Mixing proportional to master channel operation.

"MIX": Mixing by master channel another function considered.

Mixing mode  
OFF, MIX  
Initial value: OFF

## 7 When ending adjustment, return to the initial screen by pressing the (END) button 3 times.

## When Steering and Throttle Travel is Insufficient

When the steering servo travel is insufficient even when D/R is 100% and EPA is 120%, programmable mixing can be used to increase the travel somewhat.

(Reference data)

- PM1->ON
- MST (master channel) -> ST Mixing is applied from steering
- SLV (slave channel) ->ST Mixing is applied to steering and the travel is increased.
- RIGH -> 10% [When subtrim is centered (0%)]
- LEFT -> 10% [When subtrim is centered (0%)]
- Trm -> OFF
- OFS -> 0%
- MXMD -> MIX

However, the operating range of the servo is exceeded even if a large value is input at RIGH and LEFT and a zone over which the servo does not operate even when the wheel is moved to the left or right is created. A zone over which the servo does not operate is also generated at the moving side when the subtrim is moved to the left and right. Therefore, set the RIGH and LEFT value by checking servo operation.

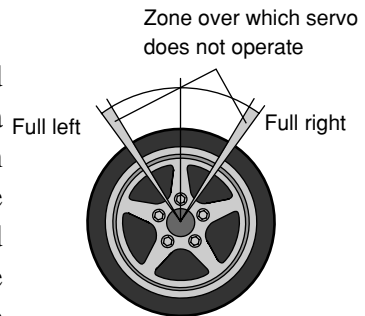

When the throttle servo travel is insufficient at ATL 100% and EPA120%, the same action can be performed by making TH (throttle) both the MST and SLV when steering.

When both steering and throttle operations are performed, use both PROG MIX1 and PROG MIX2 program mixing.

# Boat mode/BOAT MODE (Steering system/throttle system)

## Stopping of brake side operation

When brake operation is unnecessary with a boat, etc., only brake operation can be stopped.

## Tilt mixing

This mixing uses an outboard engine with a boat, etc. and applies mixing of both directions from rudder (steering) to 3rd channel and from 3rd channel to rudder and allows rudder operation and tilt mixing using 2 servos. Rudder operation by steering wheel and tilt mixing by 3rd channel knob are possible.

## Effect of set value of other functions

The steering side EPA function, ST-EXP function, ST-SPEED function, or ST-D/R function setting are effective even at 3rd channel side operation. However, the 3rd channel is not reversed even if the reverse function is set at the steering side.

## Slave channel output (Initial value)

Steering > 3rd channel side: +100%  
3rd channel > Steering side: -100%

### Calling the setup screen

\* Calling from menu screen (Initial screen)

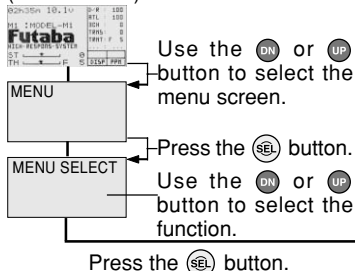

\* When the direct call button is set, the setup screen is also called by the following method:

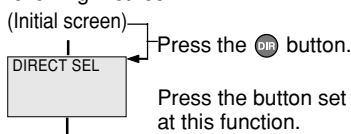

Use the **DN** or **UP** button to select the setup item.

\* **\*** blinks at the current setup item.



\* Brake side operation stop function

\* Tilt mixing function

Adjustment buttons  
- Use the (+) and (-) buttons to make adjustments.  
- Press the (+) and (-) buttons simultaneously (approx. 1 sec) to return to the initial screen.

## Brake side operation stop method

(Preparation)

- Preselect setup item "TRG-BRK".

1 (Stopping brake side operation)

Use the (+) or (-) button to select "CUT OFF".

2 When ending adjustment, return to the initial screen by pressing the (END) button 3 times.

Brake side operation (TRG-BRK)  
NORMAL, CUT OFF  
Initial value: NORMAL

## Tilt mixing adjustment

(Preparation)

- Select setup item "MODE" and make the following adjustments.

### 1 (Function ON/OFF)

Set the function to the "ON" state by pressing the (+) or (-) button.

Function ON/OFF  
INH, ON

"INH": Function OFF

"ON": Function ON

### 2 (CH1>CH3 mixing amount adjustment)

Select setup item "CH1>3" by pressing the (UP) button twice, and use the (+) and (-) buttons to adjust the mixing amount.

Mixing amount  
-100~+100  
Initial value: +100

"+": Operate in same direction as steering

"-": Operate in opposite direction of steering

### 3 (CH1>CH1 mixing amount adjustment)

Select setup item "CH3>1" by pressing the (DN) button once, and use the (+) and (-) buttons to adjust the mixing amount.

Mixing amount  
-100~+100  
Initial value: -100

"+": Operate in same direction as channel 3

"-": Operate in opposite direction of channel 3

4 When ending adjustment, return to the initial screen by pressing the (END) button 3 times.

# Subtrim/SUB-TRIM(All channel)

Use this function to adjust the neutral position of the steering, throttle and channel 3 servos.

Subtrim shifts the entire servo travel range in the set direction.

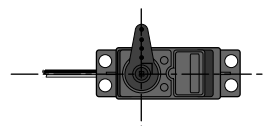

Use to adjust the neutral position

## Calling the setup screen

\* Calling from menu screen (Initial screen)

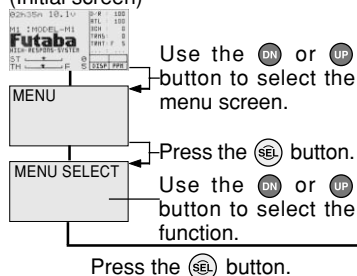

\* When the direct call button is set, the setup screen is also called by the following method:

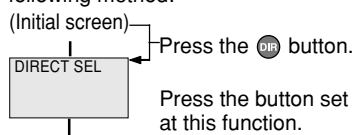

Use the **DN** or **UP** button to select the setup item.

\* **▶** blinks at the current setup item.



\* Steering subtrim

\* Throttle subtrim

\* Channel 3 subtrim

## Brake side operation stop method

(Preparation)

- Set the steering and throttle digital trims to the neutral "0" position. Set CH3 to the center "0" position.
- Preselect setup channel "ST", "TH", or "CH3".

### 1 (Subtrim adjustment)

Use the (+) or (-) button to adjust the center.

(Each channel can be set similarly.)

2 When ending adjustment, return to the initial screen by pressing the (END) button 3 times.

Subtrim

ST : L100~R100

TH : B100~F100

CH3 : -100~+100

Initial value : 0

# Servo Reverse/CH-REV(All channel)

This function reverses the direction of operation of the servos related to transmitter steering, throttle, and channel 3 operation.

However, when the position set by trim or subtrim shifts from the center, the center becomes the opposite side.

## Calling the setup screen

\* Calling from menu screen  
(Initial screen)

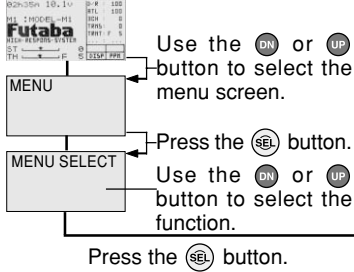

\* When the direct call button is set, the setup screen is also called by the following method:

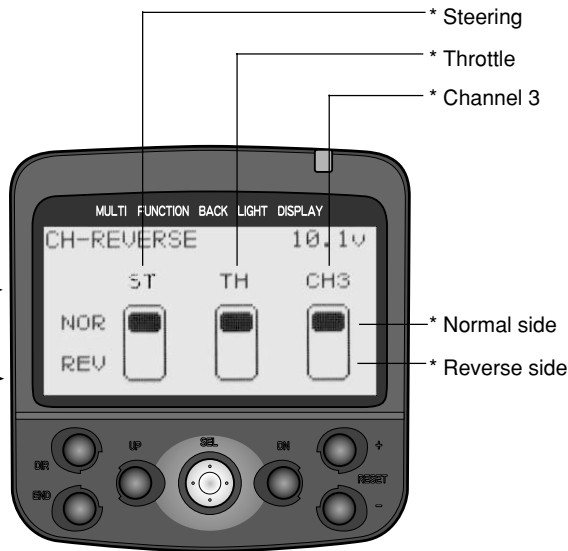
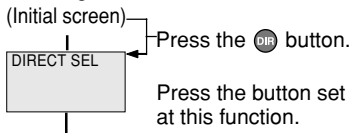

## Servo Reverse Function Setting

(Preparation)

- Preselect setup channel "ST", "TH", or "CH3".

1 (Servo reverse setting)

Use the (+) or (-) button to reverse the servo operation direction.

(Each channel can be set similarly.)

2 When ending adjustment, return to the initial screen by pressing the (END) button 3 times.

# Fail safe function/FAIL SAFE

(This function can only be used with HRS or PCM1024 system receivers.)

## Fail safe function

This function moves the steering, throttle and channel 3 servos to a preset position when the receiver cannot receive the signal from the transmitter for some reason. When the servo operation position is not set, this function operates so that the servos remains in the position they were in immediately before reception was lost. When the signal from the transmitter can be received again, this function automatically resets..

- For gasoline engine cars, it is recommended that the throttle channel be set to the direction that applies the brakes.
- When the transmitter power is turned on, the transmitter transfers the fail safe data to the receiver and continues to transfer the data every minute thereafter. Note that data for about 1 minute after the receiver power is turned on is not transferred because usually, the transmitter power is turned on first and the receiver power is turned on next.

## Battery fail safe function

When the receiver battery voltage drops to a certain voltage or less, this function moves the throttle servo to the position set by fail safe function. When the voltage recovers, this function automatically resets.

## Battery fail safe function ON/OFF switching (PCM only)

Battery fail safe function ON/OFF can be set by transmitter side setting.

Also, with an HRS system, the battery fail safe function cannot be turned OFF.

### Calling the setup screen

#### \* Calling from menu screen (Initial screen)

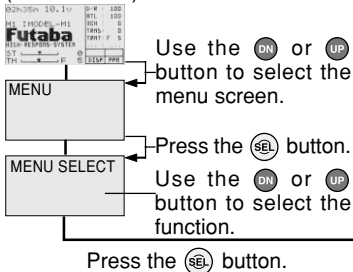

\* When the direct call button is set, the setup screen is also called by the following method:

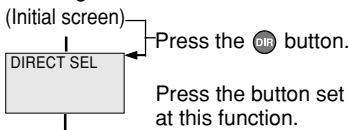

Use the **[DN]** or **[UP]** button to select the setup item.  
\* **▶** blinks at the current setup item.

Setup items

- ST: Steering setting
- TH: Throttle setting
- CH3: Channel 3 setting
- MODE: Battery fail safe function ON/OFF



\* Displays the servo position when fail safe is set.



## Fail safe function setup

(Preparation)

- Select the channel to be set.

### 1 (Servo position setup)

When the fail safe function operates, the steering wheel, the throttle trigger or channel 3 knob remains in the desired operation position. When the (+) and (-) buttons are pressed simultaneously for about 1 second, the servo position is displayed and you can confirm that the function was set.

Fail safe function  
ST: Steering setting  
TH: Throttle setting  
CH3: Channel 3 setting

When you want to release the setting, press the (+) or (-) button for 1 second. "HOLD" is displayed.

(Each channel can be set similarly.)

2 When ending adjustment, return to the initial screen by pressing the (END) button 3 times.

## Battery fail safe function ON/OFF (PCM only)

(Preparation)

- Select setup item "MODE".

### 1 (Battery fail safe function ON/OFF)

The function can be switched by pressing the (+) or (-) button.

Function ON/OFF  
OFF, ON  
Initial value: OFF

2 When ending adjustment, return to the initial screen by pressing the (END) button 3 times.

# Model Select/MDL-SEL

Use this function to call a new model number, or to change a set model number, to set new model data.

The T3PK transmitter can store the model data for ten R/C cars. The DP-16K Data Pac (Option) can store model data for ten more models.

The model numbers are M1 to M10 at the transmitter and E11 to E20 at the Data Pac. When the Data Pac is not installed, model numbers E11 to E20 are not displayed.

## Calling model memories of different modulation modes (HRS, PCM, or PPM)

After the new model is called, signals are still output in the old model modulation mode until the transmitter power is turned off. Before using the new modulation mode, turn the power off and on.

## DP-16K Data Pac (Option)

For the transmitter to use the Data Pac, it must be initialized when the power is turned on for the first time. If "INITIALIZE" is displayed on the screen when the power is turned on, press the (+) button. This automatically initializes the transmitter. This operation is unnecessary thereafter.

## Inserting and removing the Data Pac

Before inserting and removing the Data Pac, turn off the power switch. If the power is turned off when a model number (E11 to E20) in the Data Pac is selected and is turned back on after the Data Pac has been removed, "SELECT ERROR" will be displayed and model M1 will be forcibly selected.

### Calling the setup screen

\* Calling from menu screen  
(Initial screen)

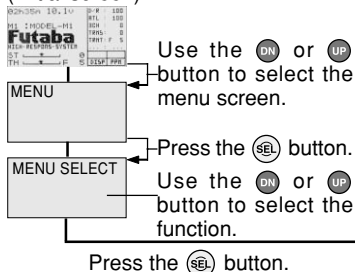

\* When the direct call button is set, the setup screen is also called by the following method:  
(Initial screen)

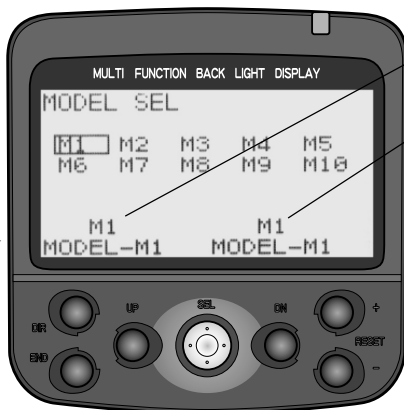
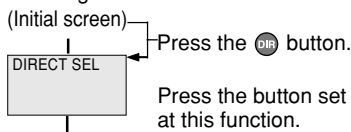

\*Current model No. and model name

\*Desired model No. and model name

## Model Select

### 1 (Model No. selection)

Use the (DN) or (UP) button to select the model No.

Model No.

M1~M10: Model memory in the Transmitter

E11~E20: Model memory in the DP-16K

### 2 (Select execution)

Press the (+) and (-) buttons simultaneously for about 1 second.

### 3 When ending adjustment, return to the initial screen by pressing the (END) button 3 times.

# Model Reset/MDL-RES

This functions resets the contents of the currently called model memory to the initial value. However, it does not reset the Adjuster function (ADJUSTER), System function (SYSTEM), Lap list (LAP-LIST), User name (USR-NAME), Direct selection button (DIRECT CUSTOMIZE), and HRS/PCM/PCM select (MOD-MODE).

## Calling the setup screen

\* Calling from menu screen  
(Initial screen)

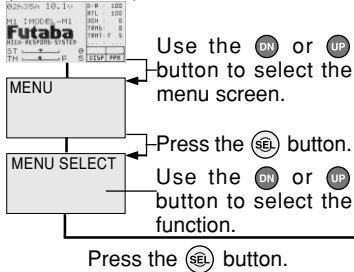

\* When the direct call button is set, the setup screen is also called by the following method:

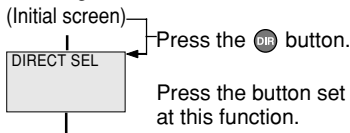

\*Current model No.

## Model Reset

### 1 (Reset execution)

Press the (+) and (-) buttons simultaneously for about 1 second. ("COMPLETE!" blinks)

### 2 When ending adjustment, return to the initial screen by pressing the (END) button 3 times.

Model No.

M1~M10: Model memory in the Transmitter

E11~E20: Model memory in the DP-16K

# Model Copy/MDL-COPY

This function copies the entire contents of the currently called model memory to another model memory.

## Calling the setup screen

\* Calling from menu screen  
(Initial screen)

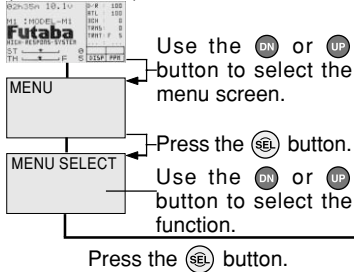

\* When the direct call button is set, the setup screen is also called by the following method:

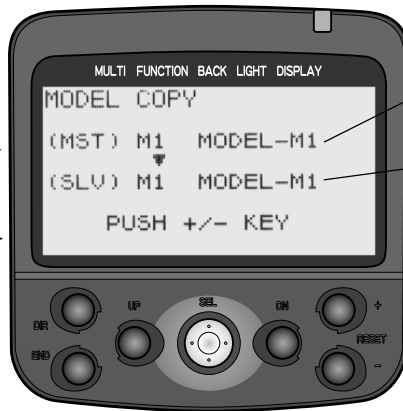
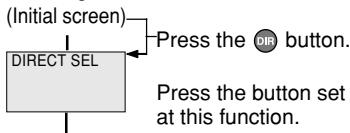

\*Current model No. and model name  
\*Copy destination model No. and model name

## Model Copy

### 1 (Copy destination selection)

Use the (DN) or (UP) button to select the model No.

### 2 (Copy execution)

Press the (+) and (-) buttons simultaneously for about 1 second. ("COMPLETE!" blinks)

### 3 When ending adjustment, return to the initial screen by pressing the (END) button 3 times.

Model No.  
M1~M10: Model memory in the Transmitter  
E11~E20: Model memory in the DP-16K

# Model Name/MDL-NAME

This function allows you to assign a ten character name to each model memory and an user name (ten character).

## Calling the setup screen

### \* Calling from menu screen (Initial screen)

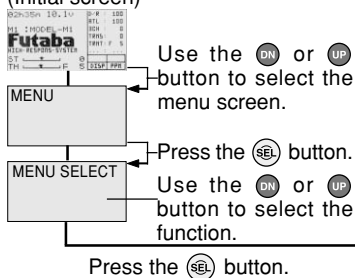

\* When the direct call button is set, the setup screen is also called by the following method:

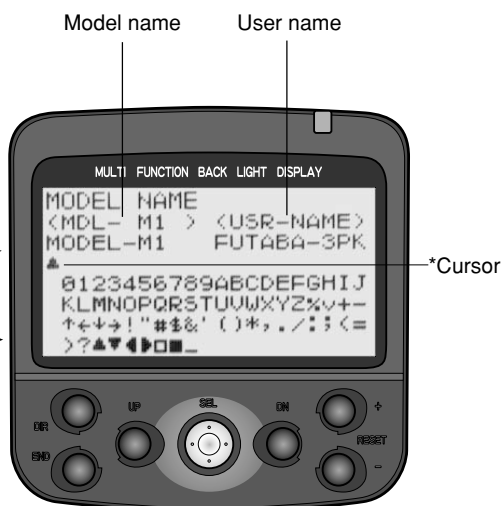
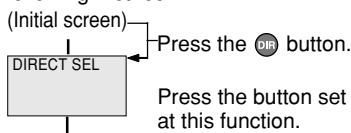

## Model Name and User Name

- 1 Move the cursor (blinking) to the column you want to change using the (DN) or (UP) button.
- 2 Change the character using the (+) or (-) button.

(Set the model name or user name by repeating steps 1 and 2 above. )

- 3 When ending adjustment, return to the initial screen by pressing the (END) button 3 times.

# Function select dial/FUNC-DIAL

This function allows selection of the function performed by the grip dials (DL1/DL2), knob (DL3), and digital trimmers (DT1/DT2/DT3), step amount adjustment, and operating direction reversal.

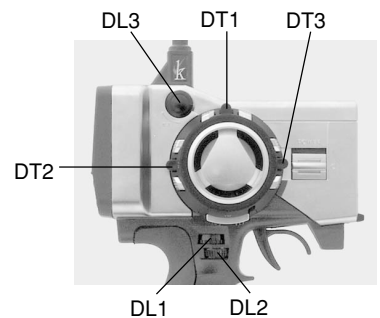
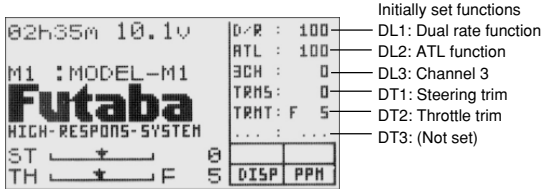

- The table below lists the functions that can be assigned to each dial, knob, and digital trimmer. The assigned function is also displayed on the initial screen together with the current adjustment value. They are displayed in DL1, DL2, DL3, DT1, DT2, and DT3 order, from top to bottom.
- The step amount can be adjusted. The table below shows the relationship between set value and step amount.
- The operation direction can be reversed. (NOR/REV)

## Settable functions

|               |   |
|---------------|---|
| D/R (D/R)     | : Dual rate function                      |
| ATL (ATL)     | : ATL function                            |
| EXP-S (EXPS)  | : Steering EXP                            |
| EXP-F (EXPF)  | : Throttle EXP (Forward side)             |
| EXP-B (EXPB)  | : Throttle EXP (Brake side)               |
| SPD-T (SPDT)  | : Steering speed (Turn side)              |
| SPD-R (SPDR)  | : Steering speed (Return side)            |
| ABP (ABP)     | : A.B.S. function (Return amount)         |
| ABSD (ABSD)   | : A.B.S. function (Delay)                 |
| ACC-F (ACCF)  | : Throttle acceleration (Forward side)    |
| ACC-B (ACCB)  | : Throttle acceleration (Brake side)      |
| THSPD (THSPD) | : Throttle speed                          |
| ST-TR (TRMS)  | : Steering trim                           |
| TH-TR (TRMT)  | : Throttle trim                           |
| CH3 (3CH)     | : Channel 3                               |
| SBT-1 (SBT1)  | : Sub trim (CH1)                          |
| SBT-2 (SBT2)  | : Sub trim (CH2)                          |
| SBT-3 (SBT3)  | : Sub trim (CH3)                          |
| D/R2 (D/R2)   | : 2nd dual rate function                  |
| IDLUP (IDLE)  | : Idle up function                        |
| TLT13 (TL13)  | : Tilt mixing (1>3)                       |
| TLT31 (TL31)  | : Tilt mixing (3>1)                       |
| PM1-A (PM1A)  | : Program mixing 1 (LEFT/FWRD/UP sides)   |
| PM1-B (PM1B)  | : Program mixing 1 (RGHT/BRAK/DOWN sides) |
| PM2-A (PM2A)  | : Program mixing 2 (LEFT/FWRD/UP sides)   |
| PM2-B (PM2B)  | : Program mixing 2 (RGHT/BRAK/DOWN sides) |
| BK-RT (BRKT)  | : Brake mixing (rate)                     |
| BK-DL (BKDL)  | : Brake mixing (delay)                    |
| BK-BL (BKBL)  | : Brake mixing (balance)                  |
| CYCLE (CYCL)  | : A.B.S. function (cycle speed)           |
| OFF (...)     | : OFF (not used)                          |

Function name, etc.  
Abbreviation displayed on initial screen  
Abbreviation used on setup screen

## Relationship between set value and step amount

- Steering trim/throttle trim  
(Setting range: 1, 2, 3, 4, 5, 6, 7, 10)  
When set to the minimum "1", the trim operation width is 200 clicks. When set to the maximum "100", the trim operation width is 20 clicks.
- Rate, etc. setup  
(Setting range: 1, 2, 3, 4, 5, 6, 7, 10%)  
The % value that is operated by 1 click relative to the set value of each rate can be set.
- Channel 3  
(Setting range: 1, 2, 5, 10, 20, 50, 3PS, 2PS)  
When set to the minimum "1", the channel 3 total operation width is 200 clicks. When set to "50", the channel 3 total operation width is 4 clicks. The total operation width for 3PS is 2 clicks and the total operation width for 2PS is 1 click. 3PS acts like a 3-position switch and 2PS acts like a 2-position switch.

## Calling the setup screen

### \* Calling from menu screen (Initial screen)

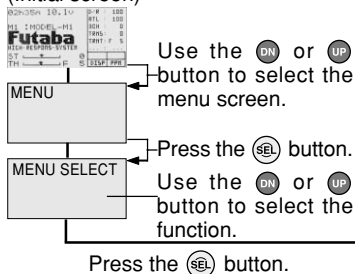

\* When the direct call button is set, the setup screen is also called by the following method:

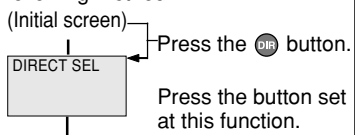

Use the (DN) or (UP) button to select the setup item.

\* ▶ blinks at the current setup item.

\* Setup item shifts in function -> step amount -> direction of operation order



Adjustment buttons

- Use the (+) and (-) buttons to make adjustments.

- Press the (+) and (-) buttons simultaneously (approx. 1 sec) to return to the initial screen.

Function selection

Step amount setting

Direction of operation setting

## Function select dial setup

### 1 (Setup item selection)

Use the (DN) or (UP) button to select the item to be set.

### 2 (When changing function)

Use the (DN) or (UP) button to select the function.

- See the preceding page for the function abbreviations.

### (When setting the step amount)

Use the (+) or (-) button to set the step amount.

- See the preceding page for the relationship between set value and step amount.

### (When changing the direction of operation)

Use the (+) or (-) button to switch the direction.

### 3 When ending setup, return to the initial screen by pressing the (END) button 3 times.



## Function select switch/FUNC-SW

This function allows selection of the function to be performed by the push switches (SW1/SW2/SW3) and setting of the direction, etc. of operation.

- The table below shows the functions that can be assigned to each push switch.
- SW1, SW2: The function of operation can be changed. (NOR/ALT)
- SW3: The direction of operation can be reversed. (NOR/REV)

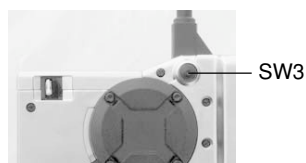
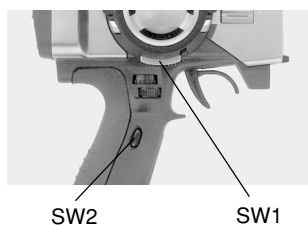

### Settable functions (sw1/sw2/sw3)

|           |   |
|-----------|---|
| AT-START  | : Start function                          |
| TH-SPEED  | : Throttle speed                          |
| AB.S.     | : A.B.S. function                         |
| IDLE-UP   | : Idle up                                 |
| D/R 2ND   | : 2nd dual rate                           |
| CH3       | : Channel 3                               |
| PROG MIX1 | : Program mixing 1                        |
| PROG MIX2 | : Program mixing 2                        |
| LAP START | : Timer function start (SW3 not possible) |
| LAP RESET | : Timer function reset (SW3 not possible) |
| OFF       | : (Not used)                              |

┌───┐ Function name, etc.  
└───┘  
┌───┐ Abbreviation used on setup screen  
└───┘

## Calling the setup screen

### \* Calling from menu screen (Initial screen)

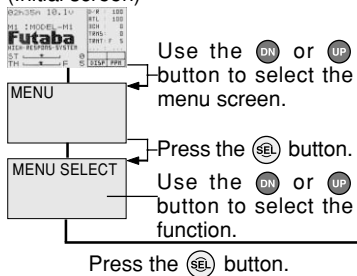

\* When the direct call button is set, the setup screen is also called by the following method:

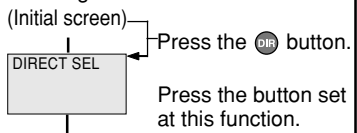

Use the (DN) or (UP) button to select the setup item.

\* ▶ blinks at the current setup item.



\* Setup item shifts in function -> direction of operation order.

Function selection

Direction of operation setting (NOR/REV)

## Function select switch setup

### 1 (Setup item selection)

Use the (DN) or (UP) button to select the item to be set.

### 2 (When changing the function)

Use the (+) or (-) button to select the function.

- See the preceding page for the function abbreviations.

(When changing the direction of operation)

Use the (+) or (-) button to switch the direction.

### 3 When ending setup, return to the initial screen by pressing the (END) button 3 times.

# Dual rate/ST-D/R (Steering system)

## Dual rate

When the steering angle is too small at under steering at corners while running, adjust at the + side and when the steering angle is too large at over steering, adjust at the - side. The setup here is linked with transmitter grip dial DL1. Adjustments can be made at this screen even if DL2 is assigned to another function.

## Second dual rate

Use when facing a fence and escape is difficult at a crash and similar cases.

## Switch setup

When using second dual rate, the function select switch function must be used to preselect the switching switch. (Page )

## Operation

- The steering servo left and right steering angles are adjusted simultaneously.
- Dual rate and second dual rate steering angle switching is performed by switch.

### Calling the setup screen

\* Calling from menu screen (Initial screen)

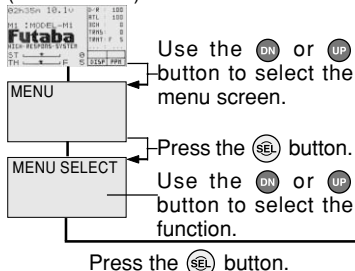

\* When the direct call button is set, the setup screen is also called by the following method:

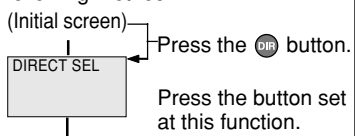

Use the **DN** or **UP** button to select the setup item.

\* **▶** blinks at the current setup item.

Setup Item

RATE: Rate setting (D/R)

2ND D/R RATE:

Rate setting (2nd D/R)

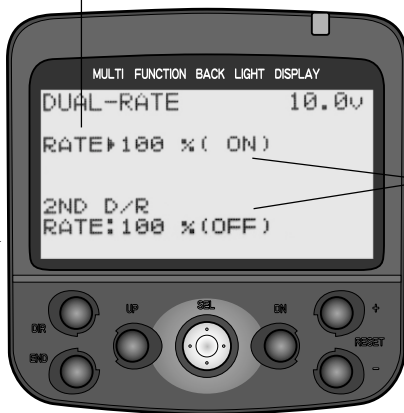

\* ON/OFF display. Linked with 2nd dual rate switch.

Adjustment buttons

- Use the (+) and (-) buttons to make adjustments.

- Press the (+) and (-) buttons simultaneously (approx. 1 sec) to return to the initial screen.

## Dual rate adjustment

(Preparation)

- When using the 2nd dual rate function, use the function select switch function (page ) to preselect the switch.

### 1 (Dual rate adjustment)

Use the (+) and (-) buttons to adjust the steering angle.

- This dual rate steering angle is linked with the grip dial.

D/R rate  
0~100%  
Initial value: 100

### 2 (2nd dual rate adjustment)

Select setup item "2ND D/R RATE" by pressing the (DN) button once, and use the (+) and (-) buttons to adjust the steering angle.

- When the switch is switched, the rate display right ON/OFF display changes. The "ON" display side becomes the steering angle during the current operation.

2ND D/R rate  
0~100%  
Initial value: 100

3 When ending adjustment, return to the initial screen by pressing the (END) button 3 times.

# ATL Function/TH-ATL(Throttle system)

This function adjusts the - side when the braking effect is strong and the + side when the braking effect is weak. This setting is linked to transmitter grip dial DL2. When DL2 is assigned to another function, set the ATL function with this screen.

## Operation

The throttle brake side (when the throttle trigger is pushed forward) brake amount can be adjusted.

### Calling the setup screen

\* Calling from menu screen  
(Initial screen)

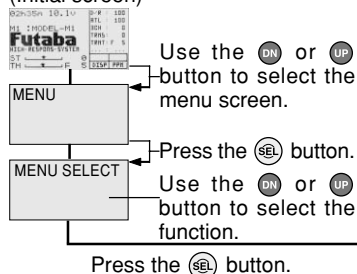

\* When the direct call button is set, the setup screen is also called by the following method:

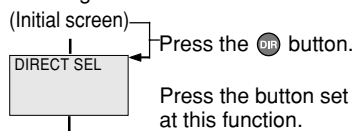

Setup Item  
RATE: Brake amount



Adjustment buttons

- Use the (+) and (-) buttons to make adjustments.
- Press the (+) and (-) buttons simultaneously (approx. 1 sec) to return to the initial screen.

## ATL function adjustment

### 1 (Brake amount adjustment)

Use the (+) and (-) buttons to adjust the brake amount.

Brake amount  
0~100%  
Initial value: 100%

- Adjust the - side when the braking effect is strong and the + side when the braking effect is weak.

2 When ending adjustment, return to the initial screen by pressing the (END) button 3 times.

# Channel 3 Position/CH3-POSI(Channel 3 system)

Use this function to set the servo position of the channel 3.

This setting is linked to transmitter knob (DL3). When the knob is assigned to another function, set the channel 3 position with this screen.

## Calling the setup screen

\* Calling from menu screen  
(Initial screen)

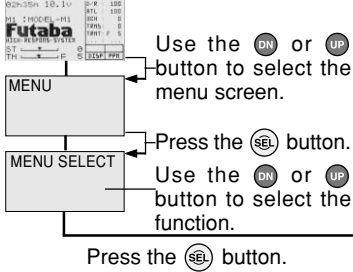

Setup Item  
RATE: Channel 3 position



\* When the direct call button is set, the setup screen is also called by the following method:

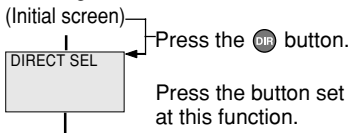

Adjustment buttons

- Use the (+) and (-) buttons to make adjustments.
- Press the (+) and (-) buttons simultaneously (approx. 1 sec) to return to the initial screen.

## Channel 3 adjustment

### 1 (Position adjustment)

Use the (+) and (-) buttons to adjust the channel 3 position.

- This position is linked with the knob (DL3).

Channel 3 position  
-100~0~+100%  
Initial value: 0%

### 2 When ending adjustment, return to the initial screen by pressing the (END) button 3 times.

# HRS/PCM/PPM select/MOD-MODE

The signal mode output from the transmitter can be changed. (PPM/PCM/HRS)

## Receiver

When using an FM receiver set to the PPM side, when using a PCM receiver, set to the PCM side and when using an HRS receiver, set to the HRS side.

**- When the mode was changed and when a model of a different mode was selected, signals are output in the mode set at the point at which the transmitter power was turned back on.**

### Calling the setup screen

\* Calling from menu screen  
(Initial screen)

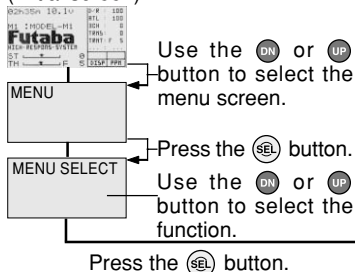

\* When the direct call button is set, the setup screen is also called by the following method:  
(Initial screen)

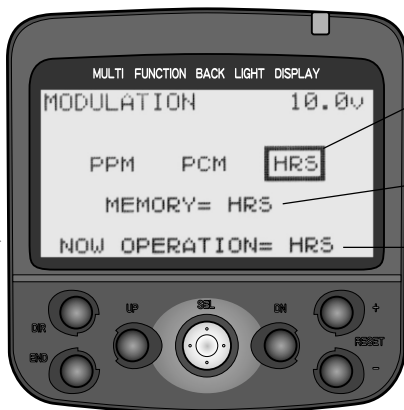
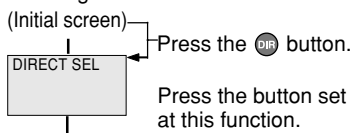

- \* At mode selection, the box cursor moves.
- \* Mode currently set in memory.
- \* Mode currently operating.

## HRS/PCM/PPM mode selection

### 1 (Mode selection)

Use the (DN) or (UP) button to select the mode.

- Selected by moving the box cursor.

Modes  
PPM, PCM, HRS

### 2 (Writing to memory)

Press the (+) and (-) buttons simultaneously for 1 second.

- The "MEMORY" display is switched.

### 3. When ending adjustment, return to the initial screen by pressing the (END) button 3 times.

The signal is output in the new mode when the transmitter power is turned on again.

# Level Select/LEVEL-SEL

This function lets you select the function selection menu from among the following 3 levels to match the level of use.

|           |            |
|-----------|------------|
| MENU 1    |            |
| *CH-REV   | *MOD-MODE  |
| *SUB-TRIM | *FAIL-SAFE |
| *CH-EPA   | *MDL-NAME  |
| *ST-EXP   | *MDL-RES   |
| *TH-EXP   | *LEVEL-SEL |
| *MDL-SEL  | *SYSTEM    |

|           |           |
|-----------|-----------|
| MENU 1    |           |
| *CH-EPA   | *TH-ACCEL |
| *ST-EXP   | *AT-START |
| *ST-SPEED | *IDLE-UP  |
| *TH-EXP   | *SUB-TRIM |
| *TH-SPEED | *TIMER    |
| *A.B.S    | *LAP-LIST |

|           |            |
|-----------|------------|
| MENU 1    |            |
| *CH-EPA   | *TH-ACCEL  |
| *ST-EXP   | *AT-START  |
| *ST-SPEED | *BRAKE-MIX |
| *TH-EXP   | *IDLE-UP   |
| *TH-SPEED | *TIMER     |
| *A.B.S    | *LAP-LIST  |

- The level can be set for each model.

## Caution when lowering the level

The set value of the functions removed from the menu when the level was lowered remains effective thereafter. Before lowering the level, turn off the unused functions, and when there is rate adjustment, etc. related to other functions, check the set values.

|            |            |
|------------|------------|
| MENU 2     |            |
| *MDL-SEL   | *MOD-MODE  |
| *MDL-RES   | *FAIL-SAFE |
| *MDL-COPY  | *DIRC-CALL |
| *MDL-NAME  | *CH-REV    |
| *FUNC-DIAL | *LEVEL-SEL |
| *FUNC-SW   | *SYSTEM    |

|            |            |
|------------|------------|
| MENU 2     |            |
| *PRG-MIX1  | *MDL-SEL   |
| *PRG-MIX2  | *MDL-RES   |
| *BOAT-MODE | *MDL-COPY  |
| *SUB-TRIM  | *MDL-NAME  |
| *CH-REV    | *FUNC-DIAL |
| *FAIL-SAFE | *FUNC-SW   |

|            |            |
|------------|------------|
| MENU 3     |            |
| *ST-D/R    | *SYSTEM    |
| *TH-ATL    | *DIRC-CALL |
| *CH3-POST  | *SERVO     |
| *MOD-MODE  | *MC-SETUP  |
| *LEVEL-SEL | *ADJUSTER  |

### Calling the setup screen

\* Calling from menu screen  
(Initial screen)

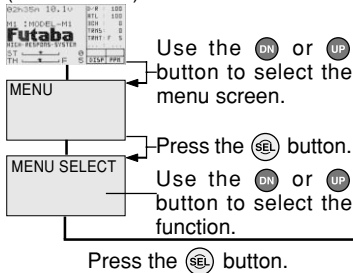

\* When the direct call button is set, the setup screen is also called by the following method:  
(Initial screen)

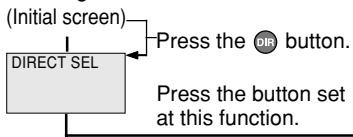

\* At level selection, the box cursor moves.

\* Currently set level

## Level selection

### 1 (Level selection)

Use the (DN) or (UP) button to select the level.

- The box cursor moves and the level is selected.

Level selection  
LV1, LV2, LV3

### 2 (Execution)

Press the (+) and (-) buttons simultaneously for 1 second.

- The "LEVEL" display switches.

### 3 When ending adjustment, return to the initial screen by pressing the (END) button 3



# System function/SYSTEM

The graphic liquid crystal screen display mode, buzzer sound, pilot lamp display mode and initial screen display mode can be set.

The system function setup items cannot be set for each model.

- Liquid crystal screen backlighting display mode setup (OFF, ON at button operation, normally ON)
- Setting of ON time (1~30 secs) when [ON at button operation] was selected above.
- Liquid crystal screen contrast adjustment (20 steps)
- Buzzer sound tone adjustment (OFF, 100 steps)
- Pilot lamp display color setup (OFF, 7 colors)
- Initial screen display mode setting ("Futaba" display, timer display, servo display)

## Calling the setup screen

\* Calling from menu screen (Initial screen)

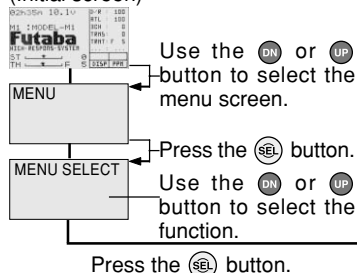

\* When the direct call button is set, the setup screen is also called by the following method:

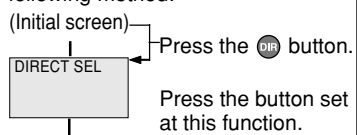

Use the [DN] or [UP] button to select the setup item.

\* ▶ blinks at the current setup item.

Setup items

LHT-MODE: Backlighting mode

LHT-TIME: Backlighting time

CONTRAST: Contrast

BUZ-TONE: Buzzer tone

LED-MODE: LED color

DISP-SEL: Initial screen mode



\*When "KEY-ON" was selected at backlighting mode, "ACT" is displayed and the backlighting time setting becomes effective.

Adjustment buttons

- Use the (+) and (-) buttons to make adjustments.

- Press the (+) and (-) buttons simultaneously (approx. 1 sec) to return to the initial screen.

## System function setup

### 1 (Setting the liquid crystal backlighting mode)

Use the (UP) or (DN) button to select setup item "LHT-MODE", and select the mode by pressing the (+) or (-) button.

Backlight mode  
KEY-ON, ALWAYS, OFF

"KEY-ON": Fixed time backlighting ON after button operated.

"ALWAYS": Backlighting always ON

"OFF": Backlighting OFF

### (Setting liquid crystal backlighting time)

Use the (UP) or (DN) button to select setup item "LHT-TIME", and use the (+) and (-) buttons to set the ON time.

Backlighting time  
1~30  
Initial value: 10

- When "KEY-ON" is set at the preceding item, this ON time becomes effective.

### (Adjusting the liquid crystal contrast)

Use the (UP) or (DN) button to select setup item "CONTRAST" and use the (+) and (-) buttons to adjust the screen contrast.

Contrast  
-10~0~+10  
Initial value: 0

- Adjust to an easy-to-see contrast.

### (Adjusting the buzzer tone)

Use the (UP) or (DN) button to select setup item "BUZ-TONE" and use the (+) and (-) buttons to adjust the tone.

Buzzer tone  
OFF, 1~75~100  
Initial value: 75

- Decide by referring to the tone at adjustment.

### (Changing the LED display color)

Use the (UP) or (DN) button to select setup item "LED-MODE" and use the (+) and (-) buttons to select the color.

LED color  
(OFF), GREEN, ORANGE, YELLOW,  
BLUE, LIGHT BULUE, PURPLE,  
WHITE  
Initial value: PURPLE

- Select your favorite color while viewing the LED color.

### (Changing the initial screen display mode)

Use the (UP) or (DN) button to select setup item "DISP-SEL) and use the (+) and (-) buttons to select the display mode.

Initial screen mode  
Futaba, TIMER,SRV-VIEW

"Futaba": "Futaba" logo is displayed on the initial screen.

"TIMER": Timer screen is displayed on the initial screen.

"SRV-VIEW": Servo operation graph is displayed on the initial screen.

2 When ending adjustment, return to the initial screen by pressing the (END) button 3 times.

# Direct call/DIRC-CALL

The function setup screen can be called from the menu screen or quickly called by using this direct call method. Adjustment can be made quickly by setting frequently used functions at direct call.

- Functions can be freely assigned to buttons 1~6 of the screen shown below.
- In the initial screen state, after (DIR) was pressed, the setup screen is called by simply pressing the assigned button.
- Assignable functions (All functions)

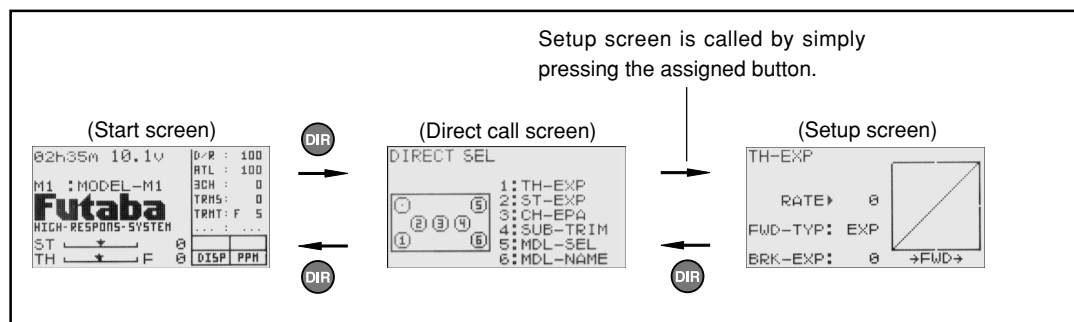

## Calling the setup screen

\* Calling from menu screen (Initial screen)

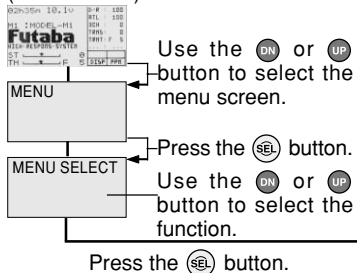

\* When the direct call button is set, the setup screen is also called by the following method:

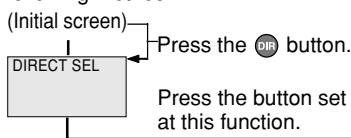

Use the **DN** or **UP** button to select the setup item.

\* **\*** blinks at the current setup item.



Setup items

- 1: Function assigned to button No. 1
- 2: Function assigned to button No. 2
- 3: Function assigned to button No. 3
- 4: Function assigned to button No. 4
- 5: Function assigned to button No. 5
- 6: Function assigned to button No. 6

\* 1~6 are buttons used at direct call.

## Direct call function assignment

### 1 (Function assignment)

Use the (DN) or (UP) button to select the button to be assigned and use the (+) or (-) button to select the assigned function.

(Repeatedly set for buttons you want to assign at item 1 above.)

### 2 When ending adjustment, return to the initial screen by pressing the (END) button 3 times.

# Servo view/SERVO

Servo operation of each channel can be checked. Operation at steering angle adjustment, when a mixing function was set, etc. can be easily checked. The servo view can also be displayed on the initial screen by using the system function (page ).

## Calling the setup screen

\* Calling from menu screen  
(Initial screen)

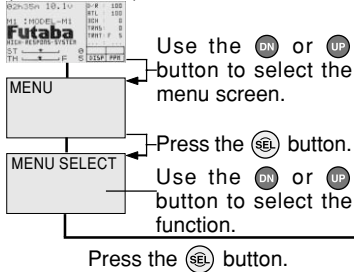

\* When the direct call button is set, the setup screen is also called by the following method:

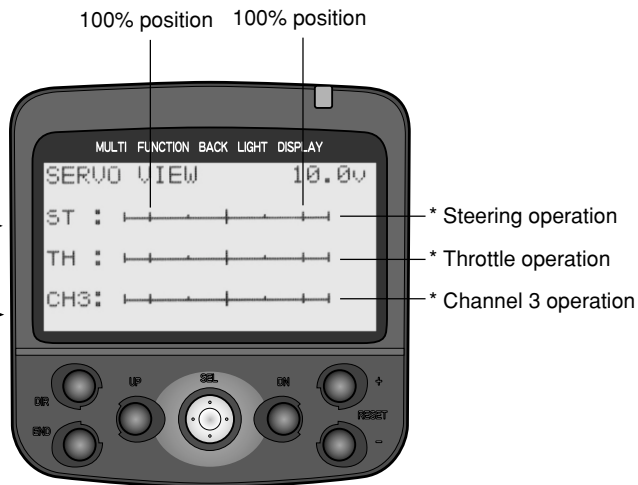
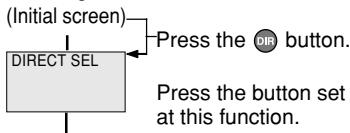

## Ending the setup screen

- 1 When ending servo operation checks, return to the initial screen by pressing the (END) button 3 times.

# HRS MC setup/MC-SETUP

This function is used only when using an FET amp like that shown below with a high response system (HRS System). This function is not used when using a Futaba amp.

The frame rate of the transmitter output signal at setup may be counted and the setup mode forcefully ended after a fixed time has elapsed, depending on the commercially available FET amp. If such an FET amp is used with the high response system, the setup time will be substantially shortened and FET amp setup may become difficult. When you have an FM receiver or PCM receive, only amp setup is possible in the PPM or PCM mode.

When using this function to make adjustments, the FET amp must be directly connected to the transmitter. Also, the following connection cords are necessary.

- Two-way cord (Must be bought separately.)
- DSC cord (Supplied with set.)

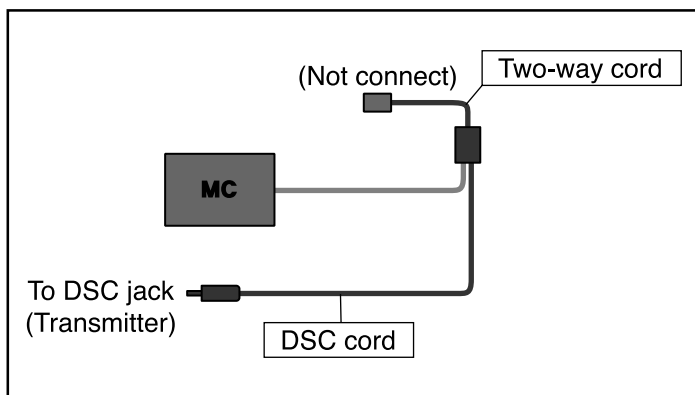

## Calling the setup screen

\* Calling from menu screen (Initial screen)

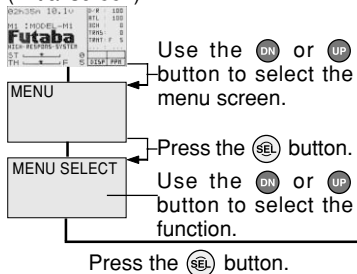

\* When the direct call button is set, the setup screen is also called by the following method:

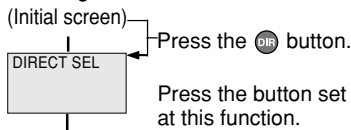

This screen does not appear except when the DSC cord is connected or set to ON by display switch.

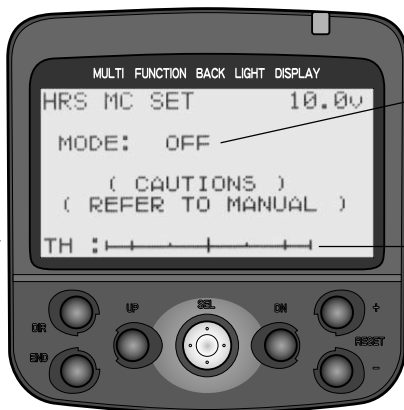

\* At setup, "NOW ACTIVE" blinks and a signal is output in the setup mode.

\* A bar graph linked with throttle operation is displayed

## FET amp adjustment

### 1 (Transmitter and amp connection)

Connect the transmitter and amp in accordance with the connection diagram on the preceding page.

### 2 (Amp setup)

Press the (+) and (-) buttons simultaneously for at least 1 second.

- "NOW ACTIVE" appears on the screen, and a special signal for amp adjustment is output from the transmitter OSC terminal. In this state, the amp can be adjusted.

Execute amp setup in accordance with the instruction manual supplied with the amp.

### 3 When ending adjustment, turn off the transmitter power switch.

If the power switch is not turned off, this setup amp mode cannot be reset. If returned to the initial screen in this setup mode, a blinking message like that shown below will appear.

CAUTION!  
NOW MOD OFF

# Adjuster/ADJUSTER

Steering wheel and throttle trigger correction can be applied. Use this function when a mechanical offset has occurred for some reason.

**However, when correction was executed, it may be necessary to recheck the set values of all the setup functions.**

## Calling the setup screen

\* Calling from menu screen (Initial screen)

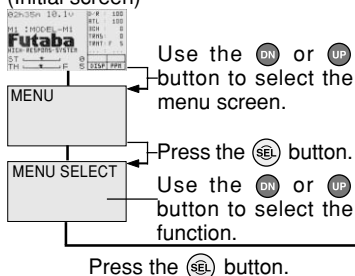

\* When the direct call button is set, the setup screen is also called by the following method:

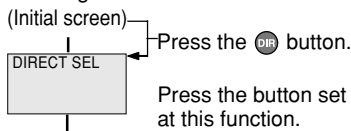

Use the (DN) or (UP) button to select the setup item.  
\* ▶ blinks at the current setup item.



Steering Throttle

## Steering adjustment

(Preparation)

- In the steering side selected state, select the adjustment screen by pressing the (SEL) button.

### 1 (Steering neutral adjustment)

In the neutral setup screen (figure at the right) state, lightly pull the steering wheel and then press the (SEL) button in the state in which the wheel is not being touched.

### 2 (Steering throw adjustment)

In the throw setup screen (figure at the right) state, lightly turn the wheel fully to the left and right and press the (SEL) button.

### 3 (Correction execution)

At the check screen (figure at the right), check if neutral is near "0%" and that the left and right

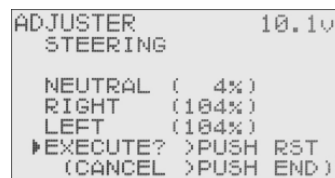
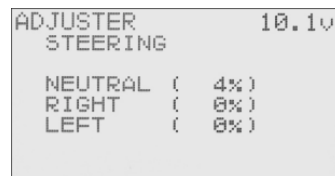
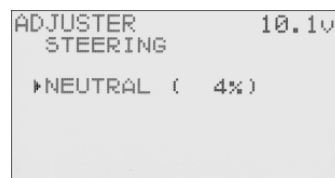



throws are near "100%" and press the (+) and (-) buttons simultaneously. Internal checks are performed automatically and when each adjustment point is in a fixed range, correction is performed and "SUCCESSFUL!" (figure at the right) is displayed.

```

ADJUSTER          10.1V
STEERING

NEUTRAL ( 4%) OK
RIGHT  (104%) OK
LEFT   (104%) OK

SUCCESSFUL!
  
```

(To terminate execution, press the (END) button.)

If an adjustment point is not within a fixed range, an error is displayed (figure at the right) and the correction data is not updated.

```

ADJUSTER          10.1V
STEERING

NEUTRAL ( 3%) OK
RIGHT  (102%) OK
LEFT   ( 42%) ERR

FAIL! (NOT CHANGED)
  
```

4 When ending adjustment, return to the initial screen by pressing the (END) button 3 times.

## Throttle adjustment

(Preparation)

- In the state in which the throttle side is selected, select the adjustment screen by pressing the (SEL) button.

1 (Throttle neutral adjustment)

In the neutral setup screen (figure at the right) state, lightly pull the throttle trigger and then press the (SEL) button in the state in which the trigger is not touched.

```

ADJUSTER          10.1V
THROTTLE

▶NEUTRAL ( 18%)
  
```

2 (Throttle throw adjustment)

In the throw setup screen (figure at the right) state, lightly operate the trigger fully to the brake side and forward side and press the (SEL) button.

```

ADJUSTER          10.1V
THROTTLE

NEUTRAL ( 18%)
BRAKE   (  0%)
FORWARD (  0%)
  
```

3 (Correction execution)

At the check screen (figure at the right), check if neutral is near "0%" and the brake side and forward side throw are near "100%" and press the (+) and (-) buttons simultaneously. Internal checks are performed automatically, and when each adjustment point is within a fixed range, correction is performed and "SUCCESSFUL!" (figure at the right) is displayed.

```

ADJUSTER          10.1V
THROTTLE

NEUTRAL ( 18%)
BRAKE   ( 99%)
FORWARD (107%)
EXECUTE? >PUSH RST
(CANCEL >PUSH END)
  
```

```

ADJUSTER          10.1V
THROTTLE

NEUTRAL ( 18%) OK
BRAKE   ( 99%) OK
FORWARD (107%) OK

SUCCESSFUL!
  
```

(To abort execution, press the (END) button.)

If an adjustment point is not within a fixed range, an error is displayed (figure at the right) and the correction data are not updated.

```

ADJUSTER          10.1V
THROTTLE

NEUTRAL ( 18%) OK
BRAKE   (100%) OK
FORWARD ( 32%) ERR

FAIL! (NOT CHANGED)
  
```

4 When ending adjustment, return to the initial screen by pressing the (END) button 3 times.

## Ratings

\*Specifications and ratings are subject to change without prior notice.

### Transmitter T3PK

- (Wheel system, 3 channels)
- Transmitting frequencies 27, 29, 40, 41 or 75MHz band  
(PK-FM RF module used)
  - Modulation FM  
(HRS/PCM/PPM switching possible)
  - Power requirement  
(Ni-cad battery)  
NT8F700B Ni-cad battery (9.6V)  
(Dry cell battery)  
Penlight x 8 (12V)
  - Current drain 250mA or less

### Servo S

- (Coreless/High Output servo)
- Output torque 8.0kg-cm (111.1oz-in)
  - Speed 0.10 sec/60 degree
  - Power requirement 4.8V or 6V
  - Size 40.5x20x37.5mm  
(1.59x0.78x1.48in)
  - Weight 55g (1.9oz)

### Servo S

- (Coreless/High Torque servo)
- Output torque 5.0kg-cm (69.4oz-in)
  - Speed 0.22 sec/60 degree
  - Power requirement 4.8V or 6V
  - Size 40.5x20x35.5mm  
(1.59x0.78x1.40in)
  - Weight 50g (1.76oz)

### Receiver R113iP

- (3 channels, PCM receiver)
- Receiving frequencies 27, 29, 40, 41 or 75MHz band
  - Intermediate frequency 455kHz
  - Power requirement 4.8V or 6V  
(shared with servos)
  - Current drain 18mA
  - Size 42.7x28.7x16.0mm  
(1.69x1.13x0.63in)
  - Weight 21g (0.74oz)

### Receiver R203HF

- (3 channels, HRS receiver)
- Receiving frequencies 27, 29, 40, 41 or 75MHz band
  - Intermediate frequency 455kHz
  - Power requirement 6.0V  
(shared with servos)
  - Current drain 14mA
  - Size 25.6x37.7x14.3mm
  - Weight 17g



## Caution



In case of the High Response System (H.R.S) receiver R203HF, always use only the following conditions:

**Servo; 6V type Digital Servo only**  
**Power supply; 6V Nicd battery**  
**Transmitter setting; "HRS" mode**

If the conditions are different, control is impossible.  
And **Fail Safe Unit (FSUI)** is not available.

## Optional Parts

The following parts are available as 3PK options. Purchase them to match your application. For other optional parts, refer our catalog.

### Crystal Set

#### <Types of Crystals>

There are crystals for FM and AM, depending on the modulation mode, and crystals for single conversion and dual conversion, depending on the receiver circuitry. Use FM and single conversion crystal sets with R113iP/R203HF.

#### **Warning**

 Use only genuine Futaba crystal.

The use of other than Futaba crystal will result in decrease of range as well as loss of control.

### Transmitter Ni-cad Battery

When purchasing a transmitter Ni-cad battery as a spare, etc., use the following:

#### Part name

**NT8F700B**



(9.6V/700mAh)

## Battery Holder (Transmitter)

This battery holder is necessary when using the transmitter with a dry cell battery. For a description of how to install the battery holder to the transmitter, see "Ni-cad Replacement" on page .

### Part name

#### 3PK transmitter battery holder

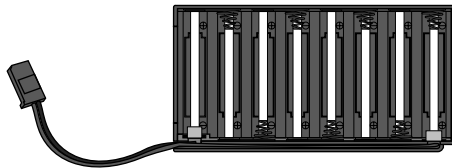

(Penlight cell x 8)

### Caution



Insert the batteries in the correct polarity.

If the polarity is incorrect, the transmitter may be damaged.



When the transmitter is not in use, remove the batteries.

If the battery electrolyte leaks, wipe off the case and contacts.

### <Check>

Turn on the power switch and check the LCD battery voltage display. When the batteries are new, the voltage should be about 12V.

If the voltage does not rise, check for faulty contact or incorrect polarity.

### <Processing the Dry Cell Batteries>

The method of processing used dry cell batteries depends on the area in which you reside. Process the batteries in accordance with the processing method for your area.

## Data Pac (DP-16K)

When the Data Pac is used, the model data for ten model can be saved, in addition to the ten model memories provided with the transmitter. Since the Data Pac can be freely carried as a separate unit, the saved data can also be used with other 3PK transmitters. DP-64K can not be used for T3PK.

### Part Name

DP-16K

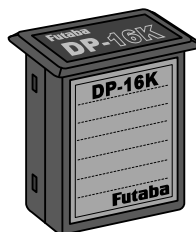

## DSC cord

When the T3PK transmitter and R113iP or R203HF receiver are connected with the DSC cord, the servos can be operated without transmitting a signal. (DSC function)

### Part name

#### DSC cord for 3PK



### Connection

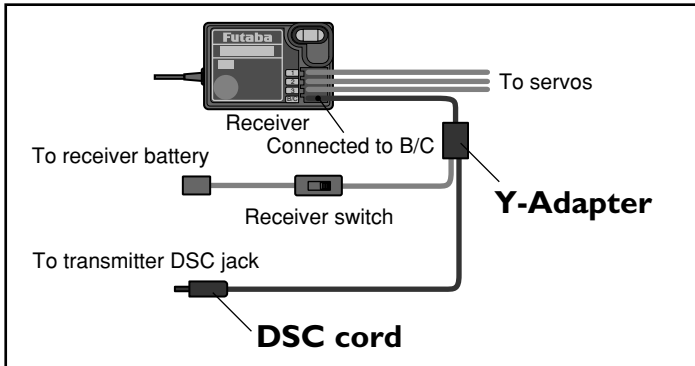

DSC jack  
(Interior)

- When used fully up to channel 3, the Y-Adapter must be purchased separately.

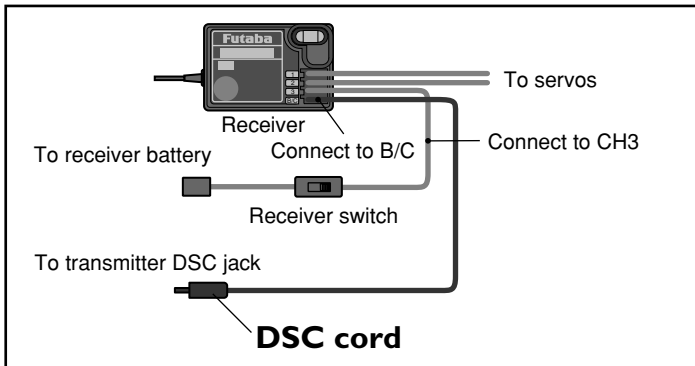

- When channel 3 is not used, connect the receiver switch to CH3 and connect the DSC cord to the B/C terminal.

# Troubleshooting

If your system fails to operate or you experience a short range problem or erratic control. Check the table below for reasons you may be having these problems. After you followed the suggestions listed and the problem is not corrected return the system to our service department for inspection and repair.

## (Item Check)

### Transmitter

#### Battery

Dead battery -> Change the batteries. Charge the Nicad

Batteries inserted incorrectly. -> Reload the batteries in accordance with the polarity markings

Faulty contact -> Check to see if the contacts are bent and not making good contact

Dirty contacts -> Clean the contacts and check for corrosion.

#### Antenna

Loose -> Be sure the antenna is screwed in tightly

Not fully extended -> Fully extend the antenna

### Receiver

#### Battery

Dead battery -> Replace or recharge

Wrong polarity -> Check connections

#### Antenna

Near other wiring -> Move away from wiring

Was antenna cut -> Request repair

Is the antenna bundled or coiled -> Keep the antenna straight and as much in the air as possible

#### Crystal

Loose -> Push in firmly

Wrong brand -> Be sure the frequencies match in transmitter and receiver

### Connector connections

Wring incorrect -> Insert all connectors firmly

Loose connections -> Push the connector in firmly

### Linkage

Binding or loose -> Adjust the linkage in model

Is movement stiff -> Adjust linkage in model

### Motor (Electric powered)

Noise problems -> Install capacitors on motor

# Error Displays

## Low Battery Alarm

If the transmitter battery voltage drops to 8.5V or less, an audible alarm will sound and "LOW BATTERY" will be displayed on the LCD screen.

**LCD screen:**

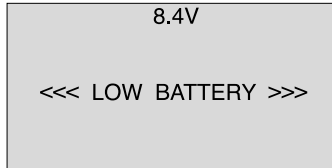

**Audible alarm:**  
**Continuous tone.**

### **Warning**

 When a low battery alarm is generated, cease operation immediately and retrieve the model.

If the battery goes dead while in operation, you will lose control.

## Backup Error

If the data is lost for an unknown reason, an audible alarm will sound and "BACK UP ERROR" will be displayed on the LCD screen.

**LCD screen:**

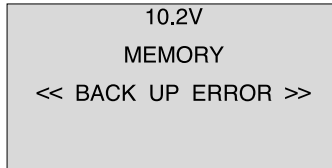

**Audible alarm:**  
**Tone will sound (9 times), then repeat.**

### **Warning**

 When a backup error is generated, immediately stop using the system and request repair from the Futaba Service Center.

If you continue to use the system, the transmitter may malfunction and cause loss of control.

## Model Select Error

If the power is turned back on in the state in which a model No. in the Data Pac was called and the Data Pac is not installed, an audible alarm will sound and "SELECT ERROR" will be displayed on the LCD screen. When any button is pressed, model No. 1 will be forcibly called.

**LCD screen:**

```

EXTERNAL MODEL No.
<< SELECT ERROR >>
ANY KEY > M1 SELECT

```

**Audible alarm:**

**Tone sounds (7 times) and stops (repeated)**

### Data Pac Error

If data transfer with the Data Pac was not performed normally, an audible alarm will sound and "ACCESS ERROR" will be displayed on the LCD screen.

- To stop the alarm, turn off the power.
- Turn the power back on. If the alarm is not generated, there is no problem.

**LCD screen:**

```

10.2V
EXTERNAL MEMORY
<< ACCESS ERROR >>

```

**Audible alarm:**

**Tone sounds (7 times) and stops (repeated)**

### Memory Error

If the data in the transmitter is not transferred normally when the power is turned on, an audible alarm will sound and "ACCESS ERROR" will be displayed on the LCD.

- To stop the alarm, turn off the power.
- Turn the power back on. If the alarm is not generated again, there is no problem.

**LCD screen:**

```

10.2V
MAIN MEMORY
<< ACCESS ERROR >>

```

**Audible alarm:**

**Tone sounds (7 times) and stops (repeated)**

### Idle-Up Warning

When the power switch is turned on while the idle-up function switch is on, an audible alarm will sound and "MIX WARNING" will be displayed on the LCD. When the idle-up function switch is turned off, the alarm will stop.

**LCD screen:**

```

10.2V
IDLE UP
<< MIX WARNING >>

```

**Audible alarm:**

**Tone sounds (7 times) and stops (repeated)**



## When requesting repair

Before requesting repair read this instruction again recheck your system. should the problems continue request as follows.

### **(Information needed for repair)**

Describe the problem in as much detail as possible and send the letter along with the system in question.

- Symptom (Including the conditions and when the problem occurred)
- R/C System (Send transmitter, receiver and servos)
- Model (Type of model, brand name and model number or kit name)
- Detailed packing list (Make a list of all items sent in for repair)
- Your name, address and telephone number.

### **(Warranty)**

Read the Warranty card.

- When requesting warranty service, send the card or some type of dated proof purchase.

*MEGATECH*  
**3PK**

**Futaba®**