

MEGATECH 3PK



3PK INSTRUCTION MANUAL

1M23N11002



Futaba

Digital Proportional R/C System

Thank you for purchasing the Futaba 3PK.
Prior to operating your 3PK, please read this manual thoroughly and use your system in a safe manner.
After reading this manual store it in a safe place.

Application, Export and Reconstruction

1. Use this product in surface models only.

The product described in this manual is subject to regulations of the Ministry of Radio/Telecommunications and is restricted under Japanese law to such purposes.

2. Exportation Precautions

(a) When this product is exported from Japan, its use is to be approved by the Radio Law of the country of the destination.

(b) Use of this product with other than models may be restricted by Export and Trade Control Regulations. An application for export approval must be submitted.

3. Modification, adjustment and replacement of parts.

Futaba is not responsible for unauthorized modification, adjustment and replacement of parts of this product.

THE FOLLOWING STATEMENT APPLIES TO THE RECEIVER (FOR U.S.A.)

This device complies with part 15 of the FCC rules. Operation is subject to the following two conditions.

(1) This device may not cause harmful interference, and

(2) This device must accept any interference received, including interference that may cause undesired operation.

THE RBRC™ SEAL (FOR U.S.A.)

The RBRC™ SEAL on the (easily removable) nickel-cadmium battery contained in Futaba products indicates that Futaba Corporation of America is voluntarily participating in an industry program to collect and recycle these batteries at the end of their useful lives, when taken out of service within the United States. The RBRC™ program provides a convenient alternative to placing used nickel-cadmium batteries into the trash or municipal waste which is illegal in some areas.

Futaba Corporation of America's payments to RBRC™ makes it easy for you to return the spent battery to Futaba for recycling purposes. You may also contact your local recycling center for information on where to return the spent battery. Please call 1-800-8-BATTERY for information on Ni-Cd battery recycling in your area. Futaba Corporation of America's involvement in this program is part of its commitment to protecting our environment and conserving natural resources.



RBRC™ is a trademark of the Rechargeable Battery Recycling Corporation.

-
- No part of this manual may be reproduced in any form without prior permission.
 - The contents of this manual are subject to change without prior notice.
 - This manual has been carefully written, please write to Futaba if you feel that any corrections or clarifications should be made.
 - Futaba is not responsible for the use of this product.

For Your Safety As Well As That Of Others

- Explanation of Symbols
- High Response System (H.R.S) Precautions
- Operation Precautions
- Nicad Battery Handling Precautions
- Storage and Disposal Precautions
- Other Precautions

Before Using

- Features
- Set Contents
- Nomenclature

Installation.....

- Receiver and Servo Connections
- Installation Safety Precautions

Initial Set-Up.....

- Preparations (Transmitter)

Function Map

- Menu Selection
- Direct Selection

Functions

- End Point Adjuster
- Steering EXP
- Steering Speed
- Throttle EXP
- Throttle Speed
- A.B.S. Function
- Throttle Acceleration
- Start Function / Engine Cut
- Brake Mixing
- Idle-Up
- Timer
- Lap List
- Programmable Mixing 1/2
- Boat Mode

Subtrim
Channel Reverse
Fail Safe/Battery Fail Safe (HRS/PCM Mode Only)
Model Select
Model Reset

Model Copy
Model Name
Function Select Dial
Function Select Switch
Dual Rate/Second Dual Rate
ATL Function
Channel 3 Position
HRS/PCM/PPM Select
Level Select
System functions
Direct Selection Button
Servo View
HRS ESC Set Up
Adjuster

**For Your Safety
As Well As
That Of Others**

**Before
Using**

Installation

**Initial
Set-Up**

**Function
Map**

Functions

Reference



Ratings
Optional Parts
Troubleshooting
Error Displays
When requesting repair
Glossary
Glossary (LCD Display)
3PK Data Sheet

Reference

Use this product in a safe manner. Please observe the following safety precautions at all times.

Explanation of Symbols

The parts of this manual indicated by the following symbols are extremely important and must be observed.

Symbols	Explanation
 Danger	Indicates a procedure which could lead to a dangerous situation and may cause death or serious injury if ignored and not performed properly.
 Warning	Indicates procedures which may lead to dangerous situations and could cause death or serious injury as well as superficial injury and physical damage.
 Caution	Indicates procedures that may not cause serious injury, but could lead to physical damage.

Symbols:



; Prohibited



; Mandatory

High Response System (H.R.S) Precautions

Caution

Mandatory Procedures

 In case of the High Response System (H.R.S) receiver R203HF, always use only the following conditions:

Servo; 6V type Digital Servo only

Power supply; 6V Nicd battery

Transmitter setting; "HRS" mode

If the conditions are different, control is impossible.

And **Fail Safe Unit (FSUI)** is not available.

Operation Precautions

Warning

Prohibited Procedures

-  Do not operate two or more models on the same frequency at the same time.

Operating two or more models at same time on the same frequency will cause interference and loss of control of both models.

AM, FM (PPM) and PCM are different methods of modulation. Nonetheless the same frequency can not be used at the same point in time, regardless of the signal format.

-  Do not operate in the following places.

- Near other sites where other radio control activity may occur.
- Near people or roads.
- On any pond when rowboats are present.
- Near high tension power lines or communication broadcasting antennas.

Interference could cause loss of control . Improper installation of your Radio Control System in your model could result in serious injury.

-  Do not operate outdoors on rainy days , run through puddles of water or when visibility is limited.

Should any type of moisture (water or snow) enter any compoment of the system, erratic opereation and loss of control may occur.

-  Do not operate this R/C system when you are tired, not feeling well or under the influence of alcohol or drugs.

Your judgment is impaired and could result in a dangerous situation that may cause serious injury to yourself as well as others.

Mandatory Procedures

-  Extend the transmitter antenna to its full length.

If the transmitter antenna is not fully extended the operating range of the radio will be reduced.

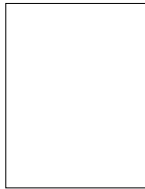

-  Always perform a operating range check prior to use.

Problems with the radio control system as well as improper installation in a model could cause loss of control.

(Simple range test method)

Have a friend hold the model, or clamp it down or place it where the wheels or prop can not come in contact with any object. Walk away and check to see if the servos follow the movement of the controls on the transmitter. Should you notice any abnormal operation, Do not operate the model. Also check to be sure the model memory matches the model in use.

-  Check the transmitter antenna to be sure it is not loose.

If the transmitter antenna works loose, or is disconnected while the model is running signal transmission will be lost. This will cause you to lose control of the model..



Caution

Prohibited Procedures



Do not touch the engine, motor, speed control or any part of the model that will generate heat while the model is operating or immediately after its use.

These parts may be very hot and can cause serious burns.

Mandatory Procedures



Turning on the power switches.
Always check the throttle trigger on the transmitter to be sure it is at the neutral position.

1. Turn on the transmitter power switch.
2. Turn on the receiver or speed control power switch.

Turning off the power switches
Always be sure the engine is not running or the motor is stopped.

1. Turn off the receiver or speed control power switch.
2. Then turn off the transmitter power switch.

If the power switches are turned off in the opposite order the model may unexpectedly run out of control and cause a very dangerous situation.

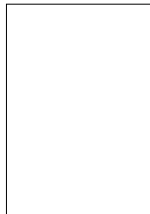

When making adjustments to the model do so with the engine not running or the motor disconnected.

You may unexpectedly lose control and create a dangerous situation.



When operating your model always display a frequency flag on your transmitter antenna.



When adjusting the transmitter on land while preparing to run (cruise), take measures so that the wind will not knock over the transmitter.

If the transmitter is knocked over, the throttle stick may be accidentally set to the operating position and you may lose control.

(Fail safe function) ---H.R.S or PCM mode only



Before running (cruising), check the fail safe function.

Check Method;

Before starting the engine, check the fail safe function as follows:

- 1) Turn on the transmitter and receiver power switches.
- 2) Wait at least one minute, then turn off the transmitter power switch. (The transmitter automatically transfers the fail safe data to the receiver every minute.)
- 3) Check if the fail safe function moves the servos to the preset position when reception fails.

The fail safe function is a safety feature that minimizes set damage by moving the servos to a preset position when reception fails. However, if set to a dangerous position, it has the opposite effect. When the reverse function was used to change the operating direction of a servo, the fail safe function must be reset.

Setting example: Throttle idle or brake position

Nicad Battery Handling Precautions

(Only when Nicad batteries are used)

Warning

Mandatory Procedures

 Always check to be sure your batteries have been charged prior to operating the model.

Should the battery go dead while the model is operating loss of control will occur and create a very dangerous situation.

 When the model is not being used, always remove or disconnect the Nicad battery .

Should the battery be left connected this could create a dangerous situation if someone accidentally turns on the receiver power switch. Loss of control would occur.

 To recharge the transmitter Nicad , use the special charger made for this purpose.

Overcharging could cause the Nicad battery to overheat, leak or explode. This may lead to fire, burns, loss of sight and many other type's of injuries.





Caution

Prohibited Items

 Do not use commercial AA size Nicad batteries.  Use prohibited

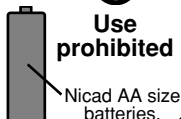
Quick charging may cause the battery contacts to overheat and damage the battery holder.



 Do not short circuit the Nicad battery terminals.

Causing a short circuit across the battery terminals may cause abnormal heating, fire and burns.

 Do not drop the Nicad battery or expose it to strong shocks or vibrations.

The battery may short circuit and overheat, electrolyte may leak out and cause burns or chemical damage.



Storage and Disposal Precautions

Warning

— Prohibited Procedures —

-  Do not leave the radio system or models within the reach of small children.

A small child may accidentally operate the system, this could cause a dangerous situation and injuries. Nicad batteries can be very dangerous when mis-handled and cause chemical damage.

-  Do not throw Nicad batteries into a fire. Do not expose Nicad batteries to extreme heat. Also do not disassemble or modify a Nicad battery pack.

Overheating and breakage will cause the electrolyte to leak from the cells and cause skin burns, loss of sight as well as other injuries.

— Mandatory Procedures —

-  When the system will not be used for any length of time store the system with batteries in a discharged state. Be sure to recharge the batteries prior to the next time the system is used.

If the batteries are repeatedly recharged in a slightly discharged state the memory effect of the nicad battery may considerably reduce the capacity . A reduction in operating time will occur even when the batteries are charged for the recommended time.

<Nicad Battery Electrolyte>

The electrolyte in Nicad batteries is a strong alkali. Should you get even the smallest amount of the electrolyte in your eyes, DO NOT RUB, wash immediately with water, seek medical attention at once. The electrolyte can cause blindness. If electrolyte comes in contact with your skin or clothes, wash with water immediately.

Caution

— Prohibited Procedures —

-  Do not store your R/C system in the following places.
 - Where it is extremely hot or cold.
 - Where the system will be exposed to direct sunlight.
 - Where the humidity is high.
 - Where vibration is prevalent.
 - Where dust is prevalent.
 - Where the system would be exposed to steam and condensation.

Storing your R/C system under adverse conditions could cause deformation and numerous problems with operation.

— Mandatory Procedure —

-  If the system will not be used for a long period of time remove the batteries from the transmitter and model and store in a cool dry place.

If the batteries are left in the transmitter electrolyte may leak and damage the transmitter. This applies to the model also, remove the batteries from it also to prevent damage.

<Nicad Battery Recycling>

A used Nicad battery is valuable resource. Insulate the battery terminals and dispose the battery by taking it to a battery recycling center.

Other Precautions



Caution

— Prohibited Procedures —



Do not expose plastic parts to fuel, motor spray, waste oil or exhaust.

The fuel, motor spray, waste oil and exhaust will penetrate and damage the plastic.

— Mandatory Procedures —



Always use only genuine Futaba transmitters, receivers, servos, FET amps (electronic speed controls), Nicad batteries and other optional accessories.

Futaba will not be responsible for problems caused by the use of other than Futaba genuine parts. Use the parts specified in the instruction manual and catalog.

Features

- High Response System (H.R.S. system)

When used with the H.R.S. system, a speed of triple that of an FM system at average response is realized. (Comparison with other Futaba products) The T3PK transmitter is

compatible with the H.R.S. system, PCM1024 system, and PPM (FM) system.

- 128x64 dot large graphic LCD/with backlighting

EXP curve, throttle curve, servo view, and other graph display and function selection can batch display simple menus and function setup items, and data setup is easy.

Backlighting that can be turned ON/OFF also improves recognition at indoor circuits, etc.

- 10 models memory/+ 10 models by using a data pack

Model names can use up to 10 letters, numbers, and symbols so that easily understood

names can be set. Model copy function simplifies creation of a model memory with different fine setups. An additional 10 models memory can be added by using the optional data pack (DP-16K).

- Two function selection modes: Menu selection and direct call

Setup screens are called from a menu screen. The menu screen can be selected from among 3 levels (LV1/LV2/LV3) to match the level of use.

Frequently used (high urgency) functions can be quickly called by assigning them to direct call buttons. (6 functions)

- Brake mixing for large cars (BRAKE-MIX)

Brake mixing of the front and rear wheels of 1/5GP cars, etc. has delay and balance adjustment functions.

- Second dual rate (2ND D/R)

Steering angle can be switched with one touch while running.

- Anti-skid Braking System (A.B.S.)

This function applies the brakes so that the tires of gasoline engine cars, etc. do not lose their grip on the road even when braking at corners.

- Throttle acceleration (TH-ACCEL)

Gasoline engine cars have a time lag before the clutch and brakes are connected. The TH-ACCEL function minimizes this time lag.

- Throttle speed (TH-SPEED)

Sudden trigger operation on slippery roads only spins the wheels unreasonably and does not accelerate smoothly. Setup the throttle speed function allows smooth and enjoyable operation while at the same time reducing battery consumption.

- Start function (AT-START)

When the throttle trigger is set to full throttle simultaneously with starting on slippery roads, the wheels spin and the vehicle does not accelerate (start). Setup the start function allows smooth starting.

- Steering speed (ST-SPEED)

"When you sense that the steering servo is too fast, etc., the servo operating speed (direction that suppresses the maximum speed) can be adjusted.

- Racing timer (TIMER)

A lap timer can record 99 lap times and the total time. The timer can also be started automatically by trigger operation. The race time and an audible alarm can be set. A navigation timer effective during training runs is provided. Target lap and refueling time can be indicated by audible alarm. Other timers are an up timer and a down timer.

- Digital trim w/reset function

The trim position is constantly displayed on an LCD screen. The operation amount of 1

step can also be adjusted. Steering and throttle trim operations have no on the maximum steering position.

- Function select dial function (FUNC-DIAL)

This function assigns a function to dials (digital trim, grip dial, knob). The step size and operating direction can also be adjusted. Trim positioning at each model call is unnecessary because all the dials are digital.

- Function select switch function (FUNC-SW)

This function assigns a function to the three installed switches. The operating direction can also be set.

- Wheel position can be changed.

The wheel position can be changed by using the offset adapter (supplied). The angle can also be adjusted.

- Adaptable for left-handed operators

The wheel section left and right mounting direction can be reversed.

- Black antenna

- NEW design considers operability and weight balance.

- Tension adjustment function

The wheel tension can be adjusted from the outside.

- Trigger stopper function (Mechanical ATL)

- Display switch

Functions can be set without emitting radio waves.

- Receiver w/DSC is standard equipment (Connection cord is option.)

HRS system: R203HF, PCMN type: R113iP

- 7-color LED pilot lamp

You can select your favorite color.

Set Contents

After opening the box, first check if the contents conform to the following. The contents depend on the set as shown below.

Before Using

Transmitter	T3PK
RF module	PK-FM *Installed in transmitter.
Receiver	R203HF(HRS-FM) or R113iP(PCM)
Servo	
Miscellaneous	Transmitter Ni-cad battery pack NT8F700B or Battery box *Installed in transmitter. Receiver switch Wheel position offset adapter(A.P.A.) Instruction manual

- If any of the set contents are missing, or you have any questions, please contact you dealer.

Caution

 In case of the High Response System (H.R.S) receiver R203HF, always use only the following conditions:

- Servo; 6V type Digital Servo only**
- Power supply; 6V Nicd battery**
- Transmitter setting; "HRS" mode**

If the conditions are different, control is impossible.

And **Fail Safe Unit (FSUI)** is not available.

Caution

 Always use only genuine Futaba transmitter, receiver, FET amp, Ni-cad battery and other optional parts.

Futaba will not be responsible for damage caused by other than genuine Futaba parts and components. Use only the genuine Futaba parts and components listed in the instruction manual and catalog.

Transmitter T3PK

Nomenclature

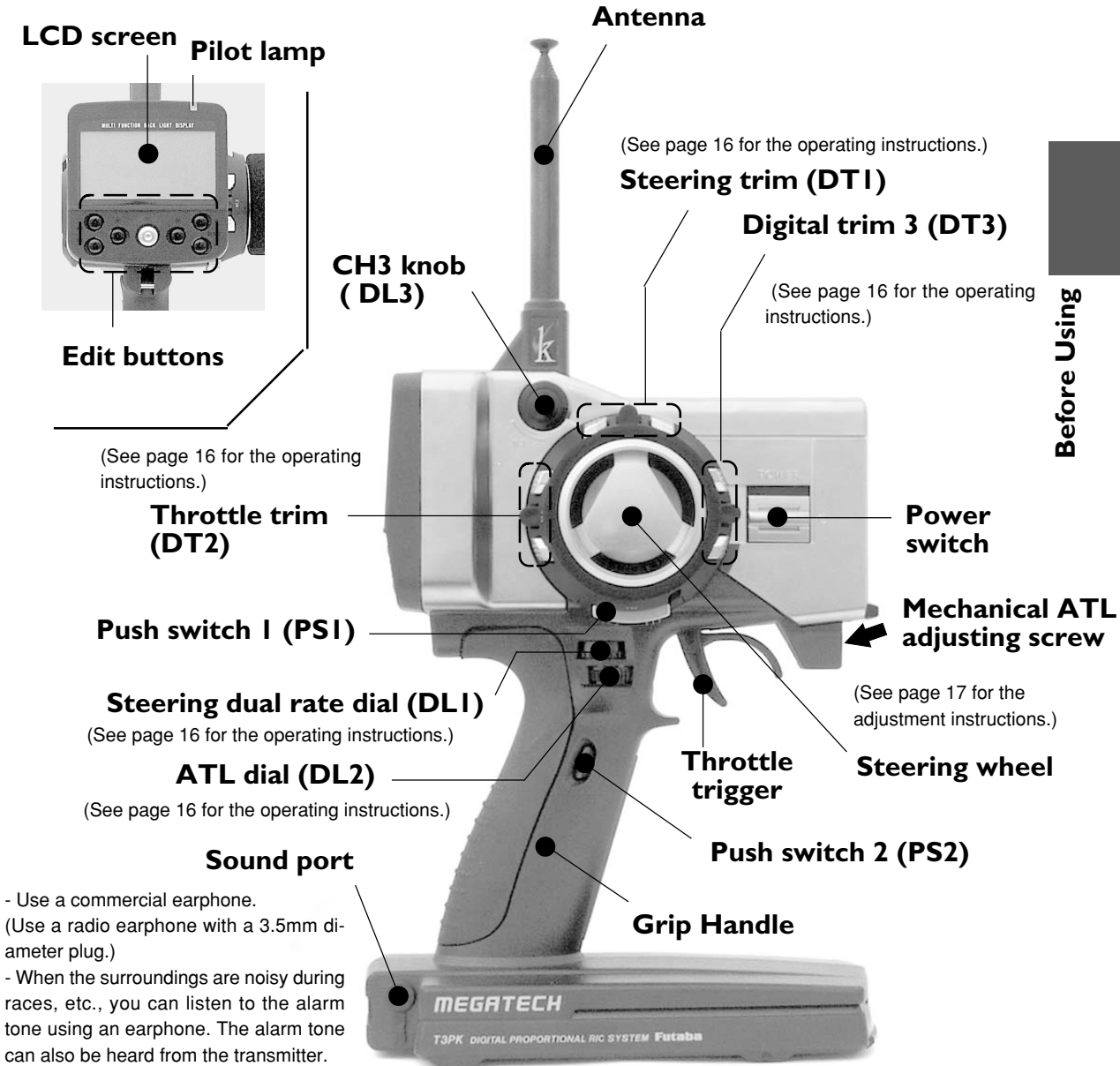

Before Using

- Use a commercial earphone.
(Use a radio earphone with a 3.5mm diameter plug.)
- When the surroundings are noisy during races, etc., you can listen to the alarm tone using an earphone. The alarm tone can also be heard from the transmitter.

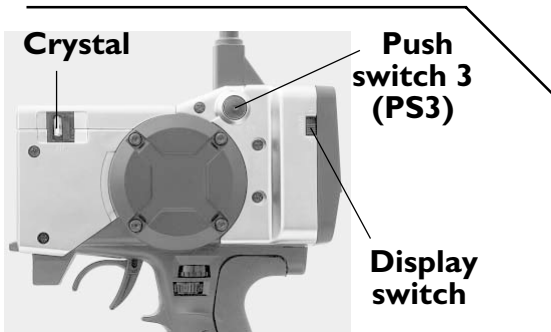

*The switches, knobs, and trimmers in the figure are shown in the initial setting position.

Precautions when turning the power switch on and off.

When the data was changed using the edit keys or trim levers, wait at least two seconds before turning off the power. If the power is turned off within two seconds after the data was changed, the new data will not be written to memory.

Digital Trim Operation

(Initial settings: DT1: Steering trim, DT2: Throttle trim, DT3: -----)

Operating by the lever: Push the lever to the left or right (up or down).

Operating by push button switch: Press the push button switch in the desired direction. The current position is displayed on the LCD screen.

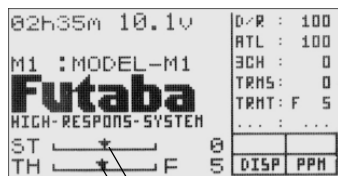
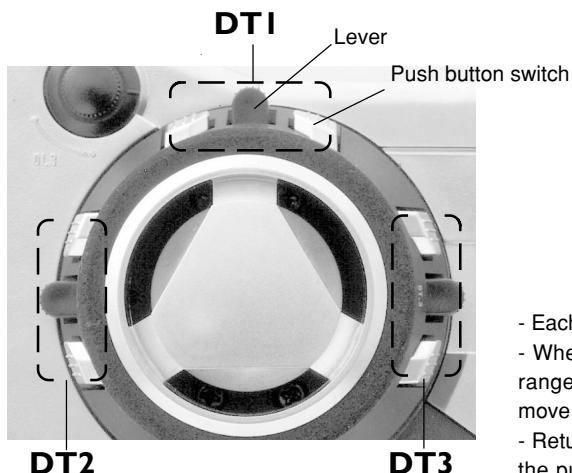

Steering trim display
Throttle trim display

- Each step is indicated by a tone.
- When the trim exceeds the maximum trim adjustment range, the tone will change pitch and the lever will not move any farther.
- Return to the neutral position (center) by pressing both the push button switches simultaneously for about one second.

Trim Operation

With the center trim feature, trim adjustments have no effect on the maximum servo travel. This prevents the linkages from binding when adjustments are made.

Grip dial operation

(Initial settings: DL1=Steering D/R, DL2=ATL)

Operate the dials by turning them. The current set value is displayed on the LCD screen.

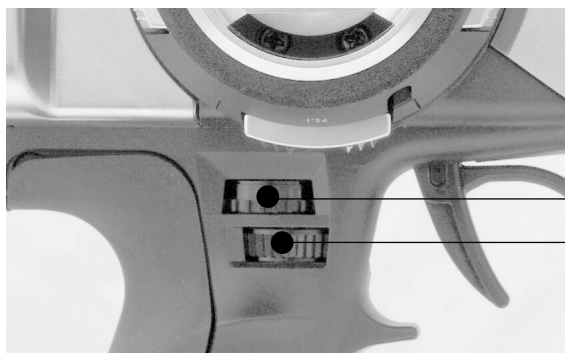

DL1

DL2

- A click sound is made at each step.
- When the maximum position is reached at each side, the tone of the click changes. Thereafter, the set value does not change.

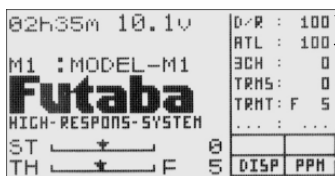

Steering D/R display

ATL display

Mechanical ATL Adjustment

Make this adjustment when you want to make the throttle trigger brake (back) side stroke narrower.

Adjustment

Using a Phillips screwdriver, adjust the trigger brake (back) side stroke by turning the screw through the adjusting hole indicated by the arrow in the figure. (The screw moves the throttle trigger stopper.)

- When the adjusting screw is turned clockwise, the stroke becomes narrower.

**Mechanical ATL
adjusting screw**



Caution

When the stroke was adjusted, the throttle servo travel must be adjusted by data setting.

Before Using

Wheel Tension Adjustment

Make this adjustment when you want to change the steering wheel spring tension.

Adjustment

Turn the screw inside the adjusting hole using a 1.5mm hex wrench.

- Turning the adjusting screw clockwise, increases the spring tension.

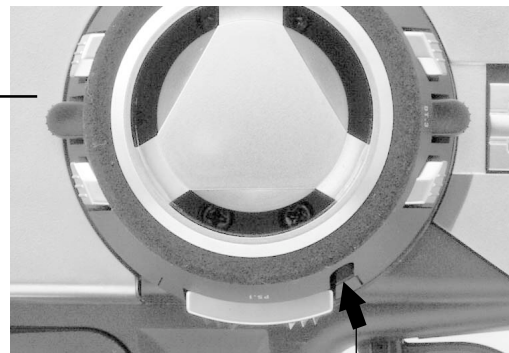

**Tension adjusting
screw**

Caution

If turned too far counterclockwise, the adjusting screw may fall out.

Battery Replacement

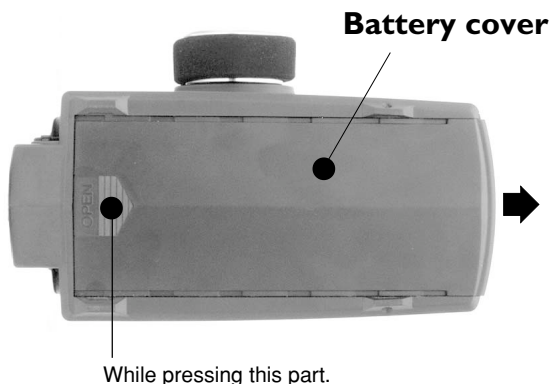

1. Slide the transmitter battery cover in the arrow direction while pressing the part shown in the figure.
2. Replace the Ni-cad battery pack or Dry cell batteries.
3. Slide the battery cover back onto the transmitter.

For dry cell battery system

Load the eight batteries in accordance with the polarity markings on the battery holder.

-Dry cell battery (x8)

For Ni-cad battery system

The Ni-cad battery is connected by a connector so that it can be removed when you will not be using the transmitter for a long time, or when replacing a dead battery with a spare battery.

- Always use an NT8F700B Ni-cad battery.

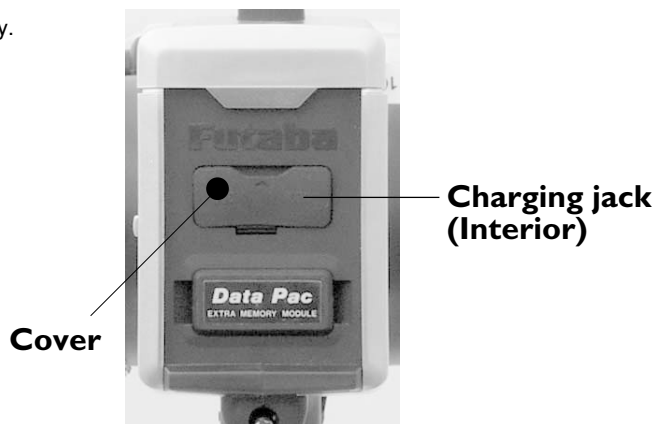

⚠ 注意

❗ 必ず実行する事項

● バッテリーカバーを閉める時は、ニッカド電池のリード線をバッテリーカバーで挟まないよう注意する。

挟んでショートすると、発火や異常発熱等により、やけどしたり、火災の原因となります。

Charging the Ni-cad Battery

Charging

1. Plug the transmitter cord of the special charger into the charging jack on the rear of the transmitter.
2. Plug the charger into an AC outlet.
3. Check that the charging LED lights.

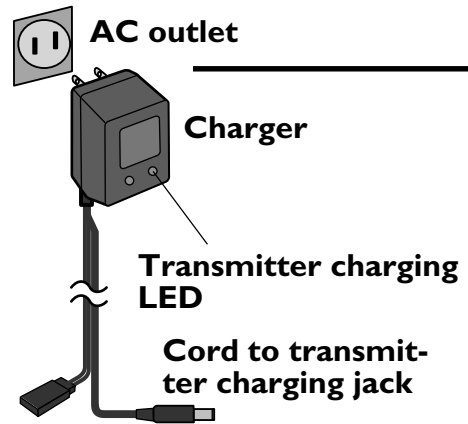

When charging the NT8F700B Ni-cad battery with the special charger, allow about 15 hours for charging. If the transmitter has not been used for some time, cycle the battery by charging and discharging it two or three times.

Over current protection

The transmitter charging circuit is equipped with an over current protection circuits (1.5A). If the battery is charged with a quick charger for other than digital proportional R/C sets, it may not be fully charged.

Warning

⚠ Never plug it into an outlet other than indicated voltage.

Plugging the charger into the wrong outlet may result in an explosion, sparking, or fire.

⚠ Do not insert and remove the charger when you hands are wet.

It may cause an electric shock.

⚠ Always use the special charger or a quick charger for digital proportional R/C sets to charge a digital proportional R/C set Ni-cad battery.

Overcharging a Ni-cad battery can result in burns, fire, injuries, or loss of sight due to overheating, breakage, or electrolyte leakage.



⚠ Use the special charger.

Caution

⚠ Never try to recharge a dry cell battery.

The transmitter may be damaged or the battery electrolyte may leak or the battery may break.

⚠ When the charger is not in use, disconnect it from the AC outlet.

Do this to prevent accidents and to avoid overheating.

Handling the RF module

Removing the RF module

- 1 Remove the RF module cover by sliding it in the arrow direction.
2. Pull the module upward while pushing the left and right claws to the inside.

Inserting the RD module

- 1 Insert the module while being careful that the transmitter side connector pins are not bent.
- 2 Push in until the claws lock with a "click".
- 3 Install the RF module cover by sliding it.

RF module cover

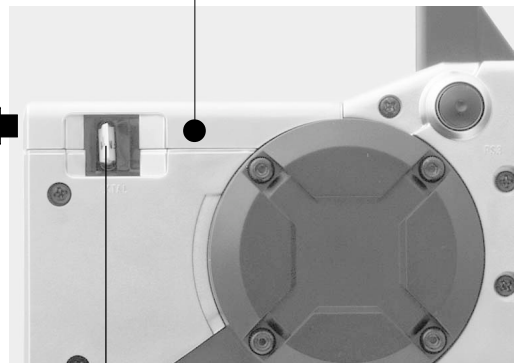

- Crystal can be changed without removing the RF module.
- See page for the crystals that can be used.

RF module temperature rise

When the transmitter is in use, the RF module temperature will rise slightly. This is normal.

Handling the data pack

With the 3PK transmitter, the setup data of 10 models can be stored in the transmitter itself and the setup data of 10- models can be stored in a DP-16 removable data pack (Option).

DP-16K data pack (Option)

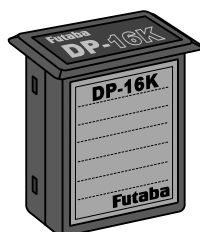

*データパックDP-64Kは使用できません。



Data pack insertion hole

- Hold the dust cap and insert the data pack in all the way.

When inserting and removing the data pack

Always turn off the transmitter power before removing or inserting the data pack.

Data pack initialization

When using the data pack, initialization is necessary so that the data pack can be used with this transmitter. When "INITIALIZE?" is displayed on the screen at power ON, press the (+) button. This automatically initializes the data pack. No further action is necessary.

```
MEMORY MODULE
INITIALIZE ?
YES > +
NO > -
```

When a data pack used with another model has been inserted, and initialization is executed by pressing the (+) button when "INITIALIZE?" is displayed on the screen at power ON, the old data is destroyed so the data pack can be used with the 3PK.

Data interchangeability with other models

Data is not interchangeable with 3PJsuper, 3VC, and other transmitters other than the 3PK.

Set data backup

The set data of each function (transmitter body and data pack) of the 3PK transmitter is stored in a memory element that does not require a backup battery. Therefore, the 3PK transmitter can be used without paying attention to the backup battery life.

Display switch

If the display switch is turned on without turning on the power switch, transmitter side data setup is possible without emitting radio waves.

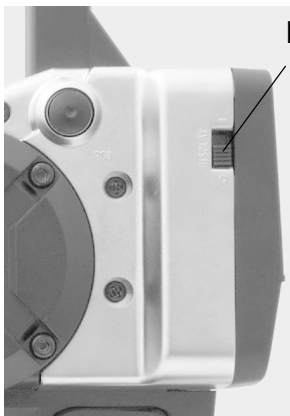

Display switch

ON



OFF

WARNING

() Prohibited item

Never turn on the power switch while this function is in use.

If the power switch is turned on, radio waves will be emitted and interfere with vehicles (boats) operating on the same band (frequency) and is very dangerous.

Display when power switch turned on

Power switch turned on



Beep confirmation sound is generated and the initial screen shown below appears.

Total timer display (H:M)
 Battery voltage display
 Model name (10 characters)
 * Display mode can be changed by using the SYSTEM function. (Page)
 Steering trim display
 Throttle trim display

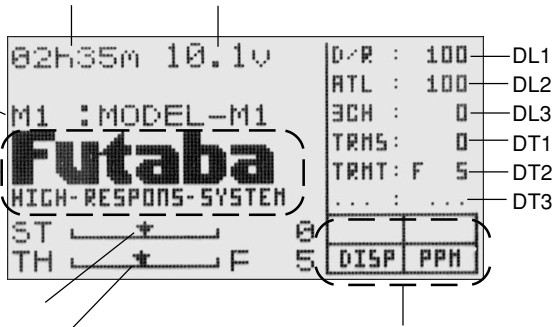

* Function names and rate assigned to dials are displayed.

* Displays whether or not a data pack is inserted. When a data pack is inserted, "DPAC" is displayed.	* "BLHT" is displayed when backlighting is ON.
* When radio waves are being emitted, "RF" is displayed. When radio waves are not being emitted when turned on by display switch and when the DSC function is used, "DISP" is displayed.	* The current operation mode is displayed. ("PPM"/"PCM"/"HRS")

User name display

When the (END) button is held down for 1 second or longer at the initial screen, the Futaba logo and user name are displayed for about 2 seconds.

Total timer

The total timer shows the accumulated time from last reset.

The total time does not change even when the model changes.

Reset method

1 In the initial screen state, hold down the (+) and (-) buttons simultaneously for 1 second.

* The total timer display counts up from 1 minute to 99hours 59 minutes.

LCD Screen Contrast

The LCD screen contrast can be adjusted. (For more information, see page .)

Caution

Do not adjust the contrast so that the LCD is too bright or too dark.
When the display cannot be read due to a temperature change, data cannot be set.

LCD Screen Temperature Change

In the following cases, the LCD may become difficult to read due to a temperature change.

- On hot summer days and cold winter days, the LCD may be easy to read indoors, but difficult to read outdoors.
- If the contrast is too bright or too dark, temperature changes and lighting conditions may cause the screen to become difficult to read.

Contrast adjustment when not called

- 1 Turn on the transmitter power again.
- 2 When the screen is too dark or too bright, adjust to a suitable contrast by pressing the (-) or (+) button, respectively, while pressing the (SEL) button.

Changing wheel position/modifying for left-hand use



- Changing the wheel position

The wheel position can be offset by using the accessory offset adapter. The wheel angle can also be adjusted.

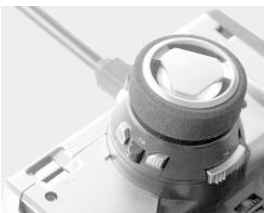

- Modification for left-hand use

The wheel section left and right mounting direction can be reversed.

Removing the steering wheel unit

1. After removing the wheel cap, carefully remove the screw holding the steering wheel.



2. Remove the steering wheel.



3. Remove the 4 screws from the wheel unit cover.



4. Remove the wheel unit cover. Be very careful the wheel shaft will fall out.

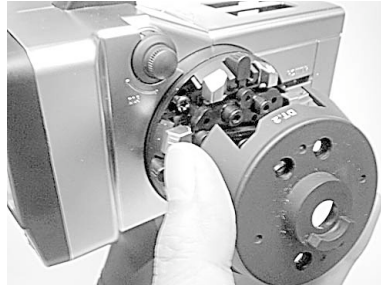

5. Remove the 4 screws from the wheel unit.



6. Disconnect the wheel unit connector.

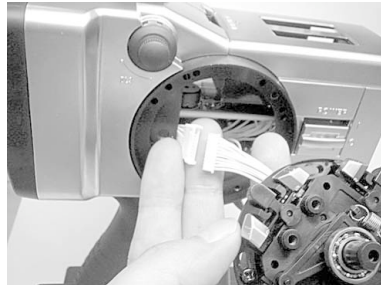

Steering Wheel



Wheel Unit Cover



Wheel Unit



Changing wheel position

1. Connect the wheel unit connector through the offset adapter. Install the adapter using four 2.5mm hex bolts at-
tached.

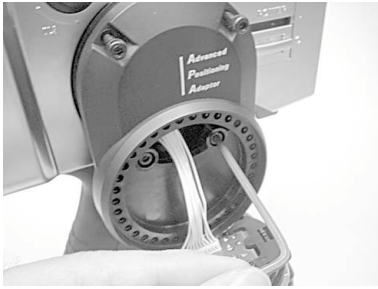

2. Reinstall the wheel unit, wheel unit cover, wheel, and wheel cap in same position as they were removed.



Modifying for left-hand use

1. Remove the wheel back cover using 2.5mm hex wrench.

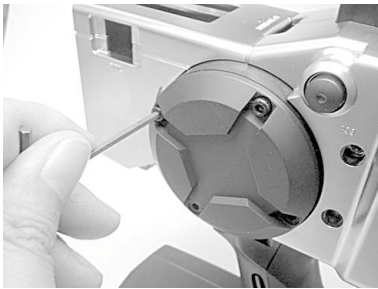

2. Push the wheel unit connector in the opposite side.

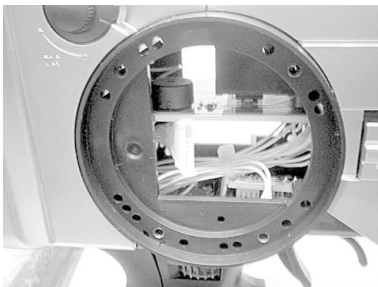

3. In opposite side, connect the wheel unit connector and re-
install the wheel unit, wheel unit cover, wheel, and wheel cap in same position as they were removed.

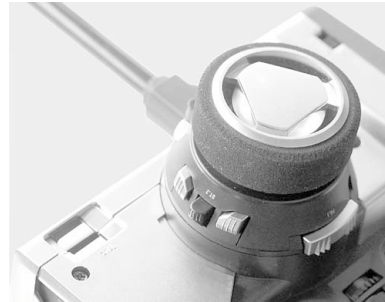

Receiver

Nomenclature

Before Using

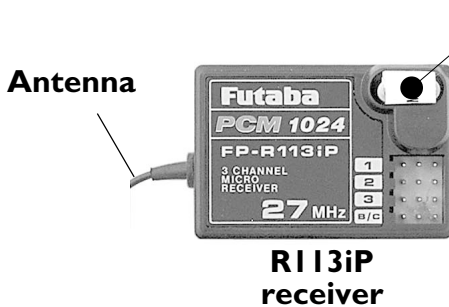

Crystal

When changing the frequency, use the specified Futaba crystal set.

Connectors

- 1: Steering servo (CH1)
- 2: Throttle servo (CH2)
- 3: CH3 servo (CH3)
- B/C: Power connector/DSC connector

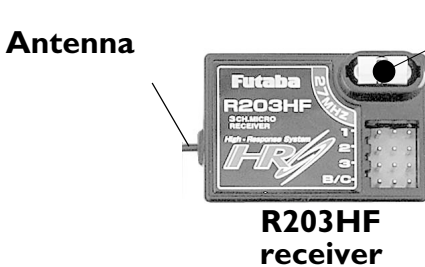

Crystal

When changing the frequency, use the specified Futaba crystal set.

Connectors

- 1: Steering servo (CH1)
- 2: Throttle servo (CH2)
- 3: CH3 servo (CH3)
- B/C: Power connector/DSC connector

For the receiver, servos, and other connections, see page 27. For the DSC cord (option) connections, see page 103.

Servo

Nomenclature

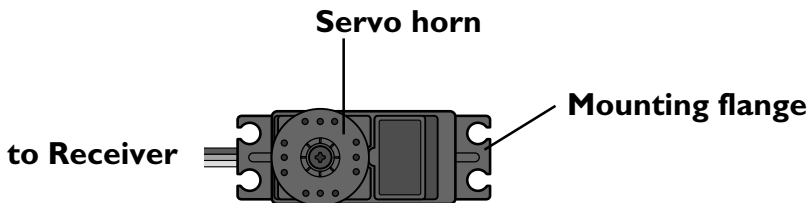

<Accessory>

The following items are provided for setting:

- Spare servo horn
- Parts for servo installation

(For the installation precautions, see page 28.)

Receiver and Servo Connections

When connecting and installing the receiver and servos, read the “Installation Safety Precautions” on the next page.

Installation When An FET Amp Is Used (MC800CFET Amp)

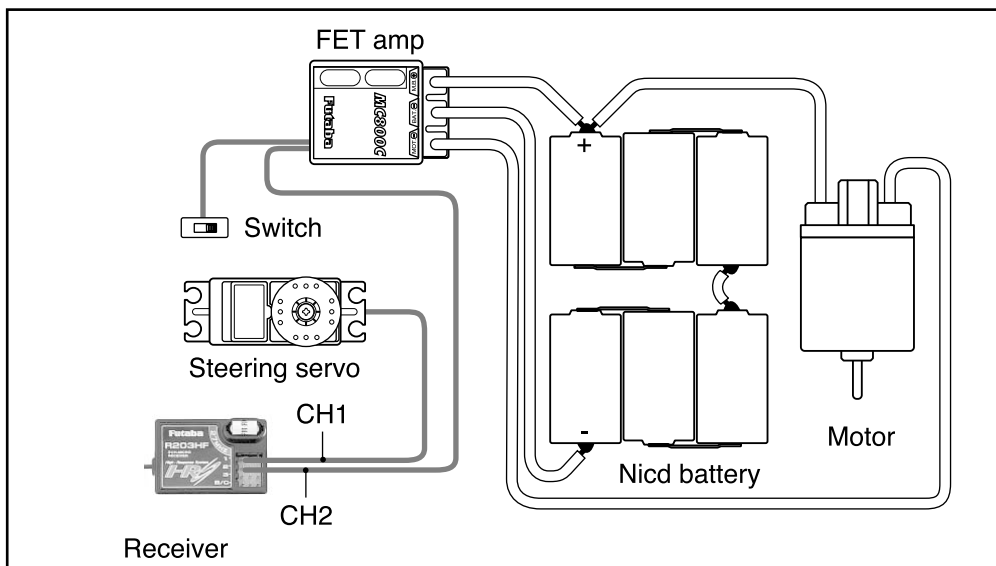

Installation For Gas Powered Models

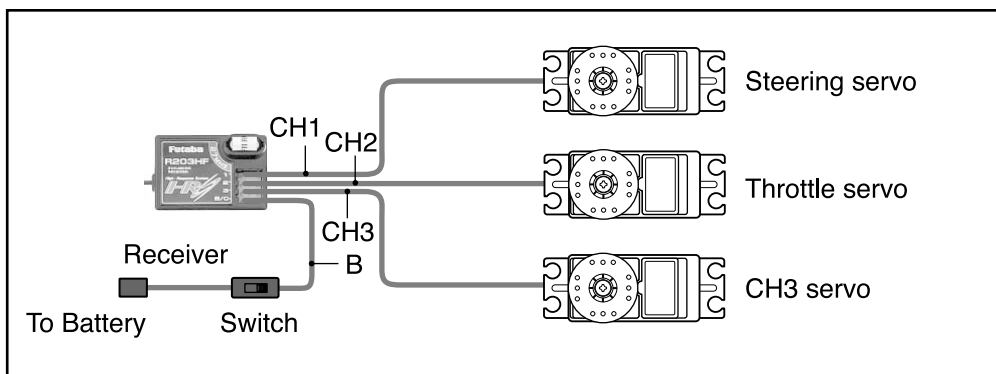

Installation Safety Precautions

Warning

Connector Connections

-  Be sure the receiver, servo, crystal and connectors are fully and firmly connected.

If vibration from the model cause a connector to work loose while the model is in operation. You may lose control .

Receiver Vibration Damping and Waterproofing

(Car)



-  Dampen the vibration to the receiver by mounting to the chassis or mounting plate with thick double sided tape in electric powered models. In gas powered models wrap the receiver in foam and mount it where the vibration is the least prevalent.

(Boat)

-  Dampen the vibration to the receiver by wrapping it in foam. Waterproof by placing it in plastic bag or watertight radio box in model.

If the receiver is subjected to strong vibration or shock erratic or loss of control may occur. If any moisture comes in contact the receiver and servos you may expertise the same result as well as damage to the system.

Receiver Antenna

-  Do not cut or bundle the receiver antenna
-  Do not bundle the receiver antenna together with the servo lead wires
-  Keep the receiver antenna at least 1 inch away from the motor and battery and wires that handle heavy current loads..

Cutting, bundling or routing the receiver antenna near any devise that produce noise will reduce the operating range of the system and result in loss of control.

*Also route the receiver antenna away from metal, carbon fiber and other parts that conduct electricity. These parts can transmit high frequency noise.

Electronic speed control

-  Install the heat sinks where they will not come in contact with aluminum, carbon fiber or other parts that conduct electricity.

If the FET Amp (Electronic speed control) heat sinks touch other materials that conduct electricity a short circuit could occur. This could result in loss of control and damage to the system.

Servo Throw

-  Operate each servo over its full stroke and be sure the linkage does not bind or is loose.

The continuous application of unreasonable force to a servo may cause damage and excessive battery drain.

Servo Installation

-  When you install the servos always use the rubber grommets provided in servo hardware bags. Mount the servos so they do not directly come in contact with the mount.

If the servo case comes in direct contact with the mount vibration will be directly transmitted to the servo.

If this condition continues for a long time the servo may be damaged and control will be lost.

Motor Noise Suppression

-  Always install capacitors to suppress noise when electric motors are used.

If capacitors are not properly installed you could experience erratic operation and reduced range as well as loss of control.

Other Noise Suppression Methods

-  Be sure there are no metal parts in your model which under vibration can come in contact with other metal parts.

Metal to metal contacts under vibration will omit a high frequency noise that will effect the receivers performance. You could experience erratic operation and reduced range as well as loss of control.

Preparations (Transmitter)

Before setting the transmitter functions, check and set items 1 to 3 below.

(Display when power switch turned on)

When the power switch is turned on, the currently selected model number is displayed. Check if this number is the model number you want to set-up. To change the model number, use the Model Select function (page).

Turn on the transmitter power.



(Start screen)

02h35m 10.1v		D/R : 100
M1 : MODEL-M1		ATL : 100
Futaba		3CH : 0
HIGH-RESPONS-SYSTEM		TRMS : 0
ST	← + →	0
TH	← + →	F 5
		DISP PPH

The model number is displayed.

I. RF Output Check

If signals are output normally, RF output monitor "RF" will be displayed on the screen.

If RF is not displayed, check if the transmitter crystal and RF module are installed.

If the transmitter is abnormal or faulty, contact your Futaba dealer.

02h35m 10.1v		D/R : 100
M1 : MODEL-M1		ATL : 100
Futaba		3CH : 0
HIGH-RESPONS-SYSTEM		TRMS : 0
ST	← + →	0
TH	← + →	F 5
		RF PPH

"RF"

2. Modulation Mode Check

The T3PK transmitter output signal format can be changed to match the type of receiver. Check if the modulation mode is set to match the receiver used.

When using an FM receiver (e.g., R133F), the modulation mode must be set to PPM. When using a PCM receiver (e.g., R113iP), the modulation mode must be set to PCM. When using a H.R.S receiver (e.g., R203HF), the modulation mode must be set to HRS. If this setting is incorrect, change it with the HRS/PCM/PPM Select (page) function.

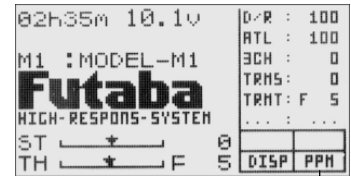

(PPM)

3. Trims Initial Set-Up

- Steering trim (DT1) check

At initial set-up, steering trim is assigned to digital trim DT1 above the steering wheel. Operate the DT1 lever and check if the steering trim display on the screen changes. After checking the trim, set the trim display to the center (N) position.

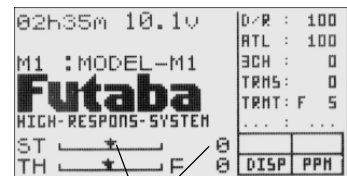

- Throttle trim (DT2) check

At initial set-up, throttle trim is assigned to digital trim DT2 at the left side of the steering wheel. Operate the DT2 lever and check if the throttle trim display on the screen changes. After checking the trim, set the trim display to the center (N) position.

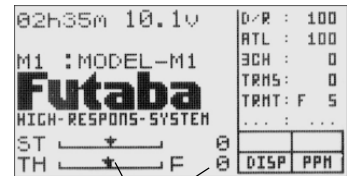

- Steering dual rate (DL1) check

At initial set-up, steering dual rate is assigned to grip dial DL1 (upper) at the grip of the transmitter. Operate the DL1 dial and check if the D/R value displayed on the screen changes. After checking D/R, set the steering dual rate to 100%.

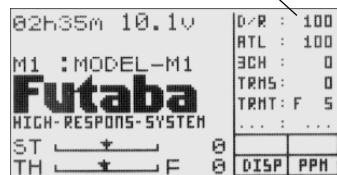

- Throttle ATL (DL2) check

At initial setting, throttle ATL is assigned to grip dial DL2 (lower) at the grip of the transmitter. Operate the DL2 dial and check if the ATL value displayed on the screen changes. After checking ATL, set throttle ATL to 100%.

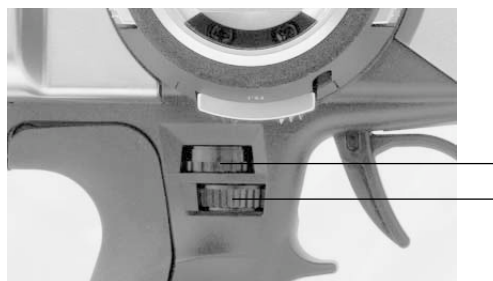
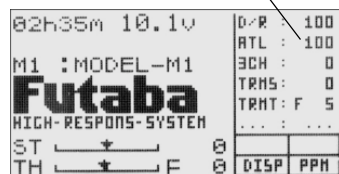

(Set-Up Procedure When Installed In a Car)

When installing the servos in a car, performing function set-up in the following order is recommended.

1. Perform step 3. Trims Initial Set-Up of Preparations on the preceding page.
2. Set the servo direction of operation using the Reverse function. (Page)
The servo installation method and linkage direction depends on the kit. Therefore, the servo operation direction may have to be reversed relative to transmitter operation. Before installing the servo, check the operating direction and set it using the Reverse function.
3. Set the subtrim and adjust the servo neutral point. (Page)
4. Set the trigger travel by adjusting the throttle trigger mechanical ATL to you liking. (Page)
5. Set EPA of each channel and adjust the servo throw (travel). (Pages)

Menu Selection

The function set-up screen can be easily selected from the function menu displayed on the LCD screen.

The function menu can be selected from among the following 3 levels to match the level of use. To select the level, use the Level Select function (page).

- Level 3 (LV3): All functions can be selected. (For expert driver)
- Level 2 (LV2): For middle class driver
- Level 1 (LV1): Basic functions only

Function Menu Screen

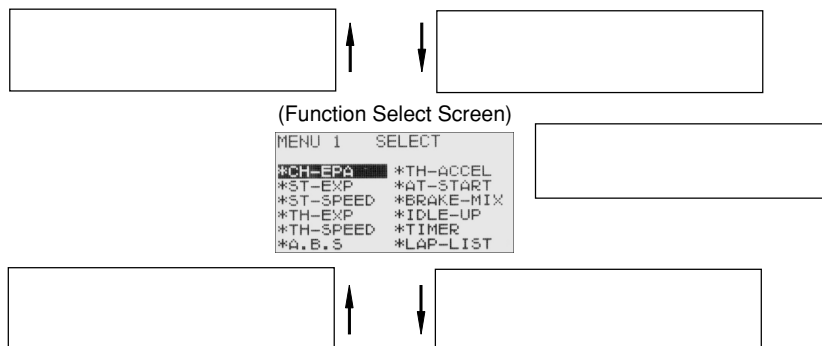
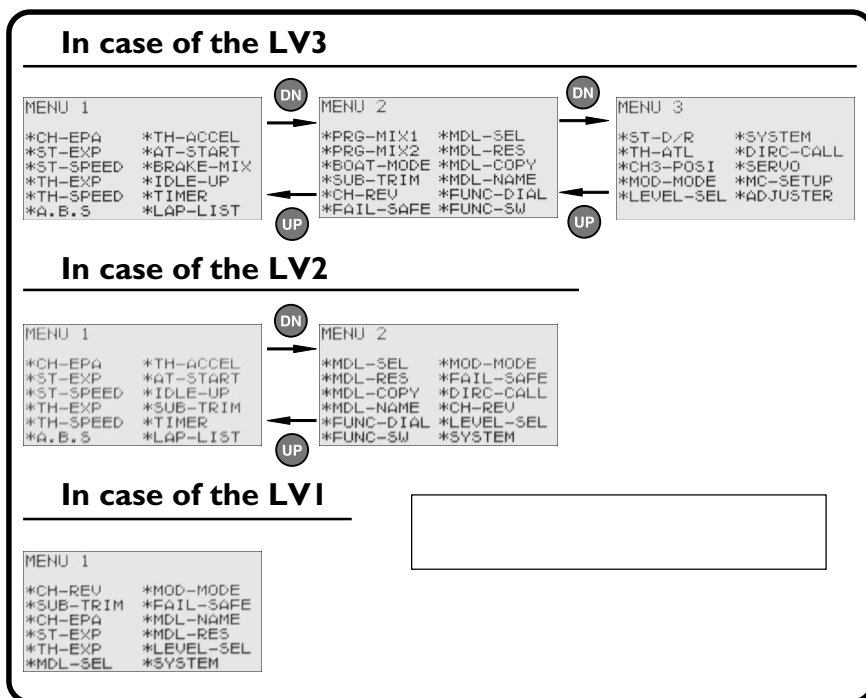
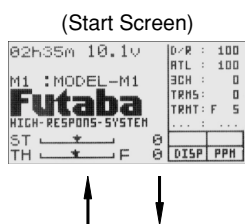

(Function Set-up Screen)

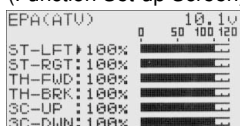

Direct Selection

The Direct Selection allows instant access to the six functions most frequently used. The function set-up screen can be directly and quickly called with the special buttons for each function of the six functions, they can be freely selected as the Direct Selection Button function.

INITIAL SETTING

	Function
1. END	TH-EXP
2. UP	ST-EXP
3. SEL	CHEPA
4. DN	SUB-TRIM
5. +	MDL-SEL
6. -	MDL-NAME

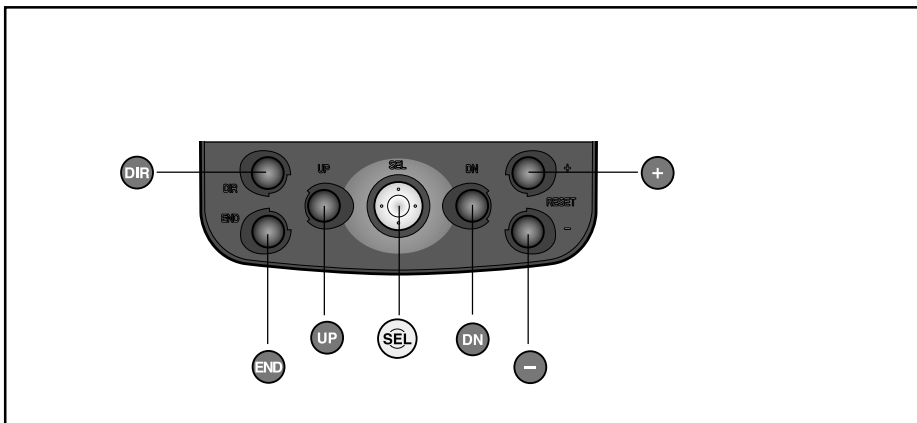
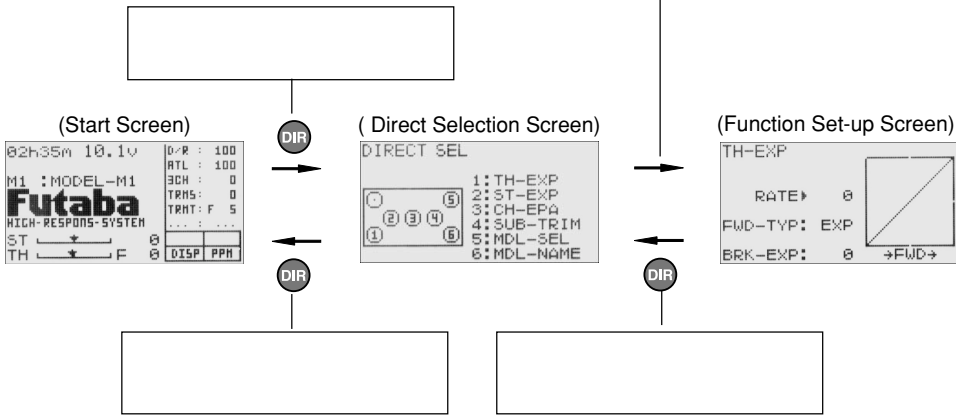

End point adjuster/EPA (All channels)

Use this when performing steering left and right steering angle adjustments, throttle high side/brake side operation amount adjustment, and channel 3 servo up side/down side operation amount adjustment during linkage.

- Corrects the maximum steering angle and left and right steering angles when there is a difference in the turning radius due to the characteristics, etc. of the vehicle.

Maximum steering angle

The EPA function basically determines the maximum steering angle of each channel. The functions shown below may have been adjusted or the operating range set by EPA function may be exceeded. Check the linkage each time the following functions are adjusted.

- Sub trim (all channels)
- Program mixing slave side (all channels)
- Tilt mixing (steering, channel 3)
- Idle up (throttle)
- Throttle preset (throttle)

ATL trim

ATL trim allows adjustment of the brake side operation amount during operation. Therefore, when the operating angle is adjusted with throttle EPA, ATL trim must also be taken into account.

Remark

When the steering angle is insufficient even though EPA is increased to maximum (120%), the steering angle can be increased somewhat by using program mixing. (Setup example: See page .)

WARNING

! Make sure that the knuckle stopper is not contacted during steering operation and that unreasonable force is not applied to the servo during other channel operation.

If unreasonable force is applied to the servo horn at the knuckle stopper during steering operation, the servo may malfunction and the model may run out of control.

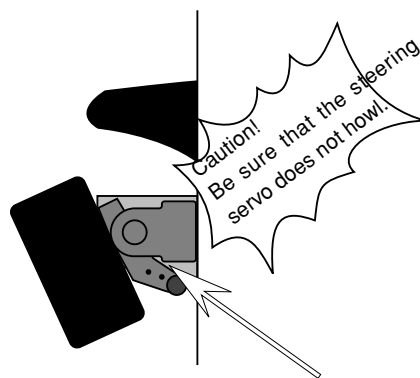

Decide the EPA value at the contact point.

Calling the setup screen

* Calling from menu screen (Initial screen)

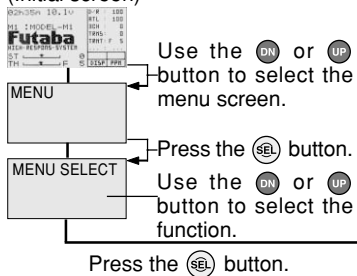

* When the direct call button is set, the setup screen is also called by the following method:

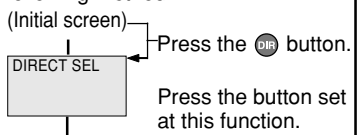

Use the (DN) or (UP) button to select the setup item.

* ▶ blinks at the current setup item.



Setup items

- ST-LFT : Steering (left side)
- ST-RGT : Steering (right side)
- TH-FWD : Throttle (forward side)
- TH-BRK : Throttle (brake side)
- 3C-UP : 3rd channel (up side)
- 3C-DW : 3rd channel (down side)

Adjustment range

0~120% (each channel, each direction)

Adjustment buttons

- Use the (+) and (-) buttons to make adjustments.
- Return to the initial value by pressing the (+) and (-) buttons simultaneously (approx. 1 sec).

Steering wheel steering angle (EPA) adjustment

(Preparation)

- Before setup the steering wheel steering angle, set the steering D/R dial (initial setup: DL1) to the maximum steering angle position 100%.
- Select setup item "ST-LFT" and make the following adjustments:

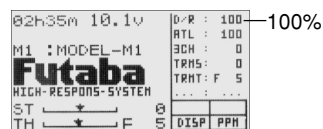

1 Steering (left side) adjustment

Turn the steering wheel fully to the left and use the (+) and (-) buttons to adjust the steering angle.

2 Steering (right side) adjustment

Turn the steering wheel fully to the right and use the (+) and (-) buttons to adjust the steering angle.

3 When adjusting the steering angle of another channel immediately after this, see the adjustment method for that channel. When ending adjustment, return to the initial screen by pressing the (END) button three times.

Setup item switching

- Use the (DN) and (UP) buttons to switch the setup item.
- Others switch the setup item (direction) linked to the steering wheel.

Throttle steering angle (EPA) adjustment

(Preparation)

- Before setting the throttle steering angle, set the throttle ATL dial (initial setup: DL2) to the maximum steering angle position 100%.
- Select setup item "TH-FWD" and make the following adjustments:

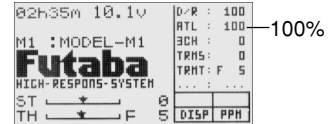

1 Throttle (forward side) adjustment

Pull the throttle trigger fully to the high side and use the (+) and (-) buttons to adjust the steering angle. However, when using an FET amp, set to 100%.

2 Throttle (brake side/reverse side) adjustment

Push the throttle trigger fully to the brake side and use the (+) and (-) buttons to adjust the steering angle. However, when using an FET amp, set to 100%.

3 When adjusting the steering angle of another channel immediately after this, see the adjustment method for that channel. When ending adjustment, return to the initial screen by pressing the (END) button three times.

Setup item switching

- Use the (DN) and (UP) buttons to switch the setup item.
- Others switch the setup item (direction) linked with the throttle trigger.

3rd channel servo steering angle (EPA) adjustment

(Preparation)

- Select setup item "3C-UP" and make the following adjustments:

1 3rd channel servo (up side) adjustment

Set the 3rd channel dial fully to the up side (+ side) and use the (+) and (-) buttons to adjust the steering angle.

2 3rd channel servo (down side) adjustment

Press the (DN) button and select setup item "3C-DWN" and set the 3rd channel dial fully to the down side (-) and use the (+) and (-) buttons to adjust the steering angle.

3 When adjusting the steering angle of another channel immediately after this, see the adjustment method for that channel. When ending adjustment, return to the initial screen by pressing the (END) button 3 times.

Setup item switching

- Use the (DN) or (UP) button to switch the setup item.

Steering EXP/ST-EXP (Steering system)

This function is used to change the sensitivity of the steering servo around the neutral position. It has no effect on the maximum servo travel.

Racers Tip

When the setting is not determined, or the characteristics of the model are unknown, start with 0%. (When EXP is set to 0%, servo movement is linear.)

Calling the setup screen

* Calling from menu screen
(Initial screen)

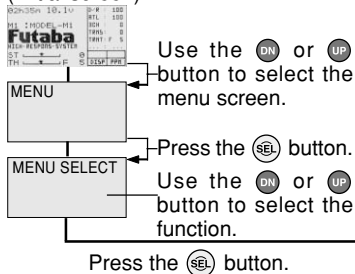

* When the direct call button is set, the setup screen is also called by the following method:

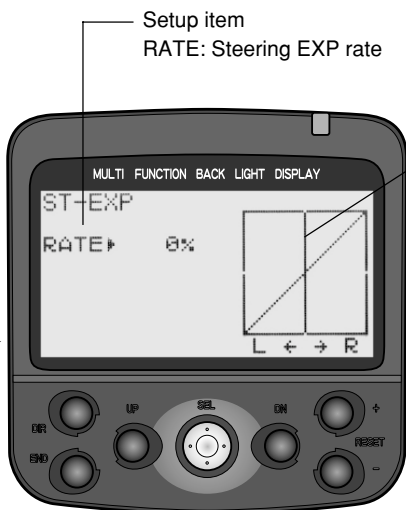
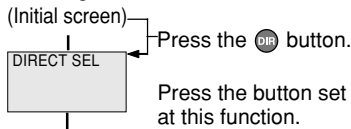

Steering EXP adjustment

- 1 When you want to quicken steering operation, use the (+) button to adjust the + side. When you want to make steering operation milder, use the (-) button to adjust the - side.
- 2 When ending adjustment, return to the initial screen by pressing the (END) button 3 times.

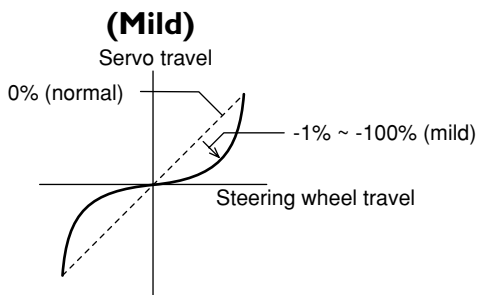
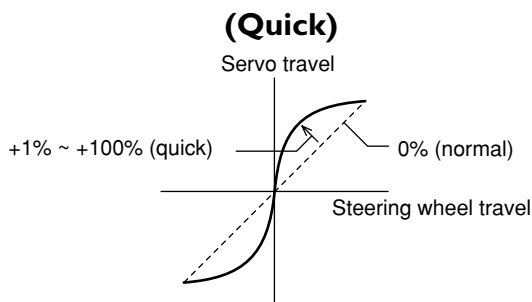

Steering Speed/ST-SPEED (Steering system)

Quick steering operation will cause momentary understeering, loss of speed, or spinning. This function is effective in such cases.

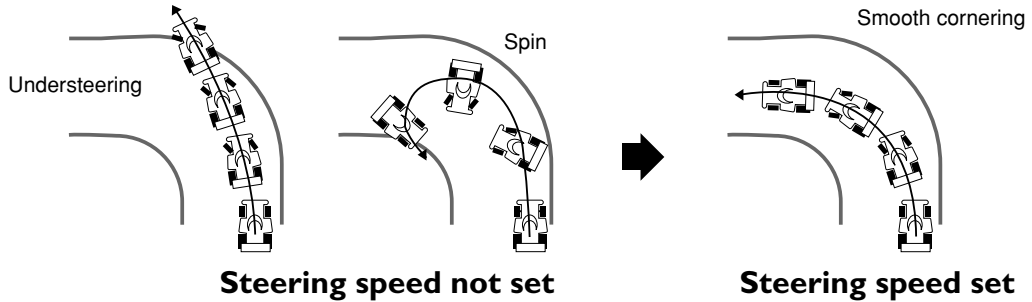

Operation

- This function limits the maximum speed of the steering servo. (Delay function)
- The steering speed when the steering wheel is operated (TURN direction) and returned (RETN direction) can be independently set.
- If the steering wheel is turned slower than the set speed, the steering servo is not affected.

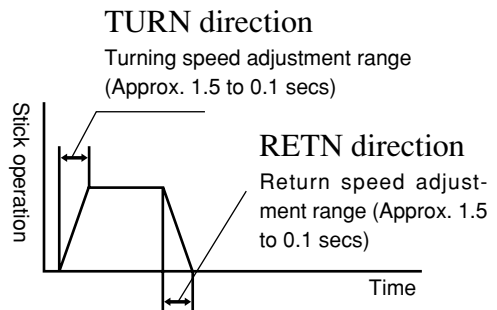

Setting example (Steering servo: S9402) . . . (Setting criteria)

- Onroad TURN side: Approx. 50~80% RETN side: Approx. 60~100%
- Offroad TURN side: Approx. 70~100% RETN side: Approx. 80~100%

Calling the setup screen

* Calling from menu screen (Initial screen)

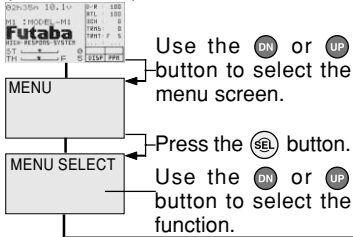

Press the [SEL] button.

* When the direct call button is set, the setup screen is also called by the following method:

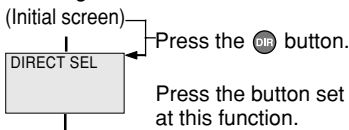

Use the [DN] or [UP] button to select the setup item.

* ▶ blinks at the current setup item.



Setup item
TURN: TURN direction
RETURN: RETURN direction

Adjustment range
1~100% (each direction)

Adjustment buttons
- Use the (+) and (-) buttons to make adjustments.
- Return to the initial value by pressing the (+) and (-) buttons simultaneously (approx. 1 sec).

Steering Speed (ST-SPEED) adjustment

(Preparation)

- Select setup item "TURN" and make the following adjustments:

1 "TURN" direction adjustment

Use the (+) and (-) buttons to adjust the delay amount.

2 3rd channel servo (down side) adjustment

Press the (DN) button and select setup item "RE-TURN" and use the (+) and (-) buttons to adjust the delay amount.

3 When ending adjustment, return to the initial screen by pressing the (END) button 3 times.

Setup item switching

- Use the (DN) or (UP) button to switch the setup item.

Setting range: 1~100%

At 100%, there is no delay.

At 1%, the delay is approximately 1.5 seconds.

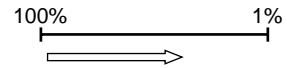

Servo operation is delayed.

Throttle EXP/TH-EXP (Throttle system)

This function makes throttle trigger high side and brake side direction servo operation quicker or milder. It has no effect on the servo maximum operation amount. For the high side, selection from among three kinds of curves (EXP/VTR/CRV) is also possible.

Advice

When the course conditions are good and there is no sense of torque at the power unit, set each curve to the + side (quick side). When the road surface is slippery and the drive wheels do not grip it, set each curve to the - minus (mild) side.

Calling the setup screen

* Calling from menu screen (Initial screen)

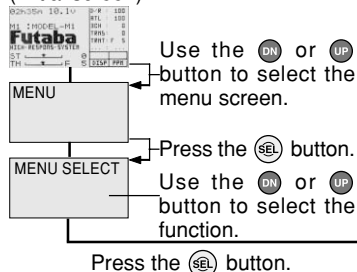

* When the direct call button is set, the setup screen is also called by the following method:

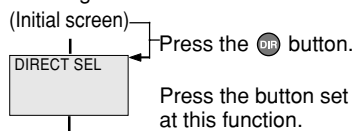

Use the **DN** or **UP** button to select the setup item.
* **▶** blinks at the current setup item.

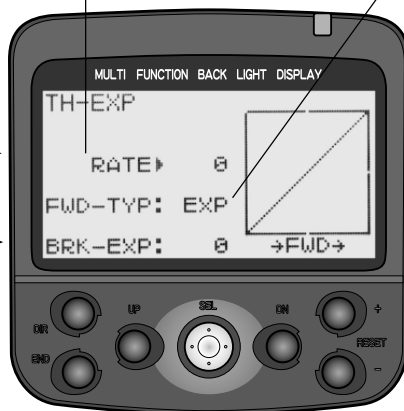

Curve selection

First, select the type of forward side curve at the "FWD-TYP" item. The setup item (screen) varies with the type of curve. The figure at the bottom left is the EXP curve setup screen.

Setup items

RATE : Forward side rate
FWD-TYP : Forward side curve selection
BRK-EXP : Brake side rate

Adjustment range

RATE : -100 ~ 0 ~ +100%
FWD-TYP : EXP, VTR, CRV
BRK-EXP : -100 ~ 0 ~ +100%

Adjustment buttons

- Use the (+) and (-) buttons to make adjustments.
- Return to the initial value by pressing the (+) and (-) buttons simultaneously (approx. 1 sec).

Adjustment method for EXP curve

(Preparation)

- Select "EXP" at setup item "FWD-TYP".
- Select setup item "RATE" and make the following adjustments:

1 Forward side adjustment

Use the (+) button to adjust the + side when you want to quicken the rise and use the (-) button to adjust the - side when you want to make the rise milder.

2 Brake side adjustment

Select "BRK-EXP" by pressing the (DN) button twice, and use the (+) button to adjust the + side

Setup item switching

0 Use the (DN) or (UP) button to switch the setup item.

when you want to quicker the rise and use the (-) button to adjust the - side when you want to make the rise milder.

3 When ending adjustment, return to the initial screen by pressing the (END) button 3 times.

Adjustment method for VTR curve

(Preparation)

- Select "VTR" at setup item "FWD-TYP".
- Select setup item "RATE" and make the following adjustments:

Adjustment range
RATE : -100 ~ 0 ~ +100%
FWD-TYP : EXP, VTR, CRV
BRK-EXP : -100 ~ 0 ~ +100%

Setup items

RATE : Forward rate
TGP : Curve switching point
FWD-TYP : Forward curve selection
BRK-EXP : Brake side rate

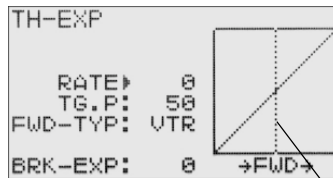

Adjustment buttons

- Use the (+) and (-) buttons to make adjustments.
- Return to the initial value by pressing the (+) and (-) buttons simultaneously (approx. 1 sec).

Setup item switching

- Use the (DN) or (UP) button to switch the setup item.

Switching point

A vertical cursor line that shows the curve switching point is displayed on the setup screen graph.

1 Forward side adjustment

Use the (+) button to adjust at + side when you want to quicken the rise and use the (-) button to adjust the - side when you want to make the rise milder.

2 Curve switching point adjustment

When you want to change the curve switching point relative to the throttle stick, select setup item "TG.P" by pressing the (DN) button and use the (+) and (-) buttons to move to the point you want to set.

3 Brake side adjustment

Select setup item "BRK-EXP" by pressing the (DN) button. When you want to quicken the rise, use the (+) button to adjust the + side and when you want to make the rise milder, use the (-) button to adjust the - side.

For the VTR curve, only the high side can be set. The brake becomes the EXP curve.

4 When ending adjustment, return to the initial screen by pressing the (END) button 3 times.

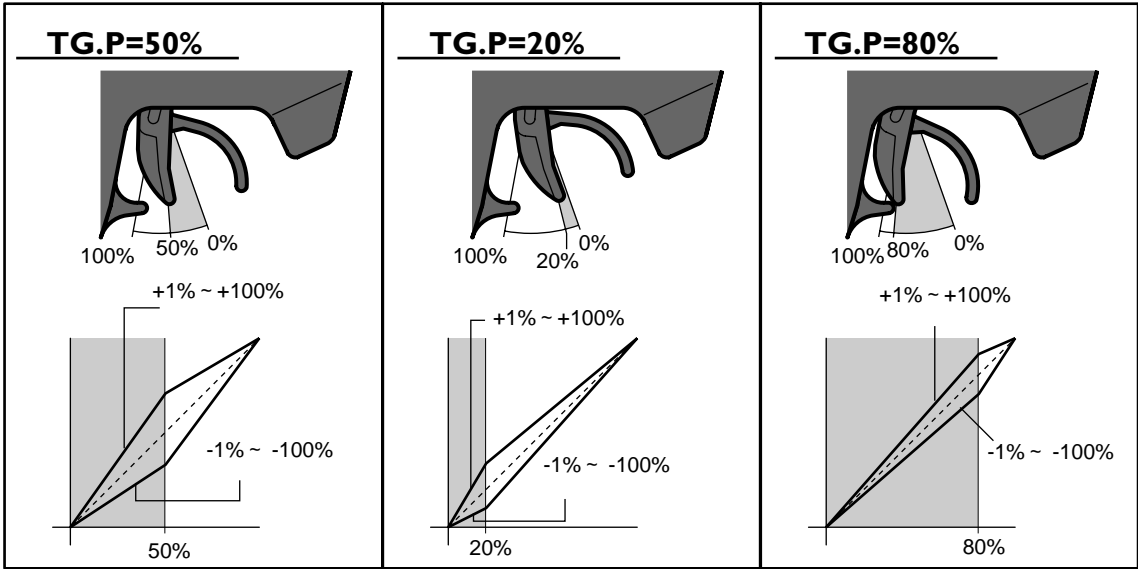

Adjustment method for CRV curve

(Preparation)

- Select "CRV" at setup item "FWD-TYP".

Setup items

1:~5: Curve points 1~5

C:RES : Curve reset

FWD-TYP : Forward side curve selection

BRK-EXP : Brake side rate

Setup item switching

- Use the (DN) or (UP) button to switch the setup item.

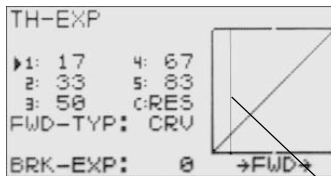

Adjustment range

1: ~ 5: 0 ~ 100%

FWD-TYP : EXP, VTR, CRV

BRK-EXP : -100 ~ 0 ~ +100%

Adjustment buttons

- Use the (+) and (-) buttons to make adjustments.

- Return to the initial value by pressing the (+) and (-) buttons simultaneously (approx. 1 sec).

Point in current setup

A vertical cursor line that shows the point in the current setup is displayed on the setup screen graph.

Returning entire curve to initial value

- Select setup item "C:RES" and return the set value of each point to the initial value by simultaneously pressing (approx. 1 sec) the (+) and (-) buttons.

For the CRV curve, only the high side can be set. The brake becomes the EXP curve.

1 Curve setup

Use the (DN) or (UP) button to select "1:" (1st point), and use the (+) and (-) buttons to set the 1st point.

Set the throttle curve by sequentially setting "2:" (2nd point) ~ "5:" (5th point).

2 Brake adjustment

Select setup item "BRK-EXP" by pressing the (DN) button. When you want to quicken the rise, use the (+) button to adjust the + side and when you want to make the rise milder, use the (-) button to adjust the - side.

3 When ending adjustment, return to the initial screen by pressing the (END) button 3 times.

Throttle curve

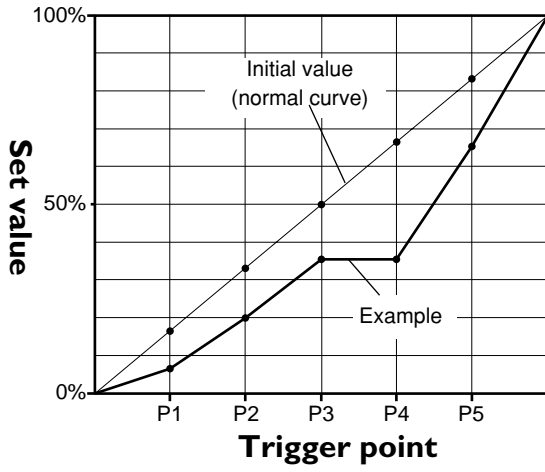

Initial values

P1 : 17%

P2 : 33%

P3 : 50%

P4 : 67%

P5 : 83%

Throttle speed/TH-SPEED (Throttle system)

Sudden trigger operation on a slippery road only causes the wheels to spin and the vehicle cannot accelerate smoothly. Setting the throttle speed function reduces wasteful battery consumption while at the same time permitting smooth, enjoyable operation.

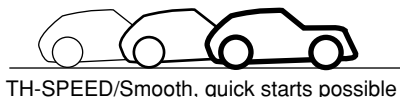

Operation

Throttle servo (amp) operation is delayed so that the drive wheels will not spin even if the trigger is operated more than necessary. This delay function is not performed when the trigger is returned and at brake operation.

- Low side throttle speed (See [Operation range setup].)

Use when adjusting the speed from the neutral position to the set point.

- High side throttle speed (See [Operation range setup].)

Use when adjusting the high side speed from the set point.

Remark: Regarding the throttle speed set value; the actual delay value varies depending on the system (HRS, PCM, PPM). The delay when the HRS system is used is approximately 1/3 that of the PCM and PPM systems.

Switch setting

Use PS1, PS2, or PS3 to switch the throttle speed function ON/OFF.

See the function select switch function (page).

Operation display

* The LED blinks while the throttle speed function is on.

Functions

Calling the setup screen

* Calling from menu screen (Initial screen)

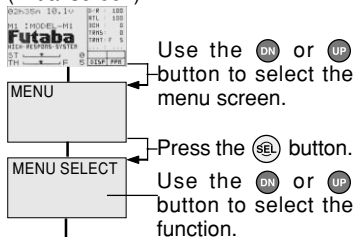

* When the direct call button is set, the setup screen is also called by the following method:

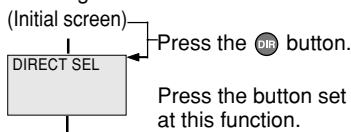

Use the **DN** or **UP** button to select the setup item.
* **▶** blinks at the current setup item.

Setup items
RANGE : Operation range
SPEED : Speed amount
MODE : Function ON/OFF

* The LED blinks while the throttle speed function is on.

* The black part of the bar graph is the operation range.

* Throttle trigger position

* "L40" indicates operation below 40%.

Adjustment buttons
 - Use the **(+)** and **(-)** buttons to make adjustments.
 - Return to the initial value by pressing the **(+)** and **(-)** buttons simultaneously (approx. 1 sec).

Throttle speed adjustment

(Preparation)

- Select setup item "MODE" and make the following adjustments:

1 (Function ON/OFF)

Set the throttle speed function to the "ACT" state by pressing the (+) or (-) button.

Function ON/OFF:
INH(OFF), ACT(ON), ACT(OFF)

"INH(OFF)" : Function OFF

"ACT(ON)" : Function ON

"ACT(OFF)": Switch OFF state when setting switches

2 (Operation range setup)

Select setup item "RANGE" by pressing the (UP) button twice and use the (+) and (-) buttons to set the operation range.

Operation range:
L1 ~ L40 ~ L99, H1 ~ H99, OFF, ALL
Initial value; L40

"L**" : Operate within a range lower than **% (Low side throttle speed)

"H**" : Operation within a range higher than **% (High side throttle speed)

"ALL" : Operate in entire region

"OFF" : Function OFF

3 (Speed amount setup)

Select setup item "SPEED" by pressing the (DN) button twice and use the (+) and (-) buttons to adjust the speed amount.

Speed amount:
0 ~ 100
Initial value;100

"100" : Maximum speed (no delay)

"0" : Maximum delay

Setup example:

Adjust at the entire (0~100%) range according to conditions.

4 When ending adjustment, return to the initial screen by pressing the (END) button 3 times.

A.B.S. Function

When the brakes are applied while cornering with a 4 Wheel Drive or other type of vehicle, understeer may occur. The generation of understeer can be eliminated and corners can be smoothly cleared by using this function.

Operation

- When the brakes are applied, the throttle servo will pulse intermittently. This will have the same effect as pumping the brakes in a full size car.
- The brake return amount, pumping cycle, and brake duty can be adjusted.
- The region over which the ABS is effective can be set according to the steering operation. (Mixing function)

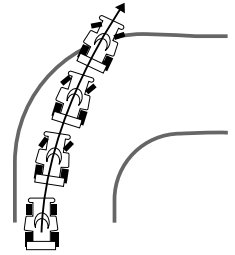

Without A.B.S.

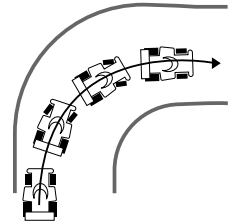

With A.B.S.

Switch Setting

The A.B.S. function ON/OFF switch can be set with the function select switch function. (Page) PS1, PS2, or PS3 can be selected.

Dial / Trim Setting

The brake return amount (AB.P), delay amount (ABS.D) and cycle (CYCL) can be controlled with grip dial DL1, DL2 or digital trim DT3, etc. with the function select dial function. (Page)

Operation Display

When the A.B.S. function is activated, the LED flashes.

Fail Safe Unit

When the 3PK is used with the Futaba fail safe unit (FSU-1), it will operate as described below.

- When the FSU-1 is connected to the throttle channel, and the A.B.S. function has been activated, the FSU-1 LED will flash each time the servo operates. The reason for this is that the FSU-1 responds to sudden data changes caused by A.B.S. function pumping operation. It does not mean that the fail safe function is activated. The servo will not be affected.

Calling the setup screen

* Calling from menu screen (Initial screen)

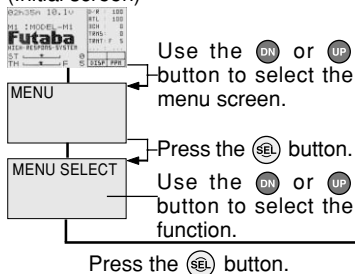

Use the **[DN]** or **[UP]** button to select the menu screen.

Press the **[SEL]** button.

Use the **[DN]** or **[UP]** button to select the function.

* When the direct call button is set, the setup screen is also called by the following method:

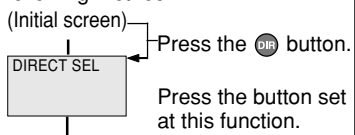

Use the **[DN]** or **[UP]** button to select the setup item.

* **▶** blinks at the current setup item.



Setup items

ABP : Brake return amount

DLY : Delay amount

CYC : Cycle speed

MODE : Function ON/OFF

TGP : Operation point

DTY : Cycle duty ratio

STM : Steering mixing

* When brake operation enters the set range, "*" is displayed in front of the number.

* When steering mixing is set and steering operation enters the set range, "*" is displayed in front of the number. When mixing is OFF, the A.B.S. function can operate over the entire steering range.

* A bar graph that shows the operating position of the throttle trigger appears. During setup, A.B.S. function operation can be checked at this bar graph.

A.B.S. function adjustment

(Preparation)

- Select setup item "MODE" and make the following adjustments:

1 (Function ON/OFF)

Set the function to the active state by pressing the **(+)** or **(-)** button.

"INH(OFF)" : Function OFF

"ACT(ON)" : Function ON

"ACT(OFF)" : Switch OFF when setting switches

Function ON/OFF:

INH(OFF), ACT(ON), ACT(OFF)

2 (Brake return amount adjustment)

Select setup item "ABP" by pressing the **(UP)** button 3 times and use the **(+)** and **(-)** buttons to adjust the return amount.

"0" : No return

"50" : Return to the 50% position of the brake operation amount

"100" : Return to the neutral position.

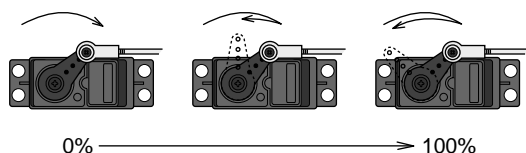

Brake return amount:

0 ~ 50 ~ 100

Initial value; 50

Adjustment buttons

- Use the **(+)** and **(-)** buttons to make adjustments.

- Return to the initial value by pressing the **(+)** and **(-)** buttons simultaneously (approx. 1 sec).

3 (Delay amount setup)

Select setup item "DLY" by pressing the **(DN)** button once and use the **(+)** and **(-)** buttons to adjust the delay amount.

"0" : A.B.S. function performed without any delay

"50" : A.B.S. function performed after an approximate 0.7 sec delay.

"100" : A.B.S. function performed after an approximate 1.7 secs delay.

Delay amount:

0 ~ 100

Initial value; 0

4 (Cycle speed adjustment)

Select setup item "CYC" by pressing the (DN) button once and use the (+) and (-) buttons to adjust the speed.

Cycle speed
1 ~ 30
Initial value; 10

- The lower the set value, the faster the cycle speed.

5 (Operation point setup)

Select set item "TGP" by pressing the (DN) button twice, and use the (+) and (-) buttons to set the operation point.

Operation point
10 ~ 100
Initial value; 30

- Sets the throttle trigger position at which the A.B.S. function is performed. The number is the % display with the brake position made 100.

6 (Cycle duty ratio setup)

Select setup item "DTY" by pressing the (DN) button once, and use the (+) and (-) buttons to adjust the duty ratio.

Duty ratio
-3 ~ 0 ~ +3
Initial value; 0

"-3" : Brake application time becomes shortest. (Brakes lock with difficulty)

"+3" : Brake application time becomes longest (Brakes lock easily)

(Remark) For low grip, set at the - side and for high grip, set at the + side.

7 (Steering mixing setup)

Select setup item "STM" by pressing the (DN) button once, and use the (+) and (-) buttons to set the steering mixing range.

Steering mixing
OFF, N10 ~ N100, E10 ~ E100
Initial value; OFF

- Sets the range within which the A.B.S. function is performed relative to steering wheel operation.

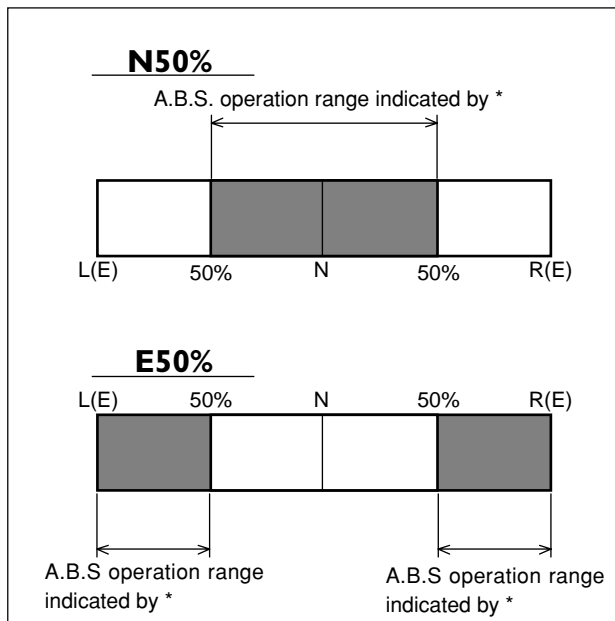

8 When ending adjustment, return to the initial screen by pressing the (END) button 3 times.

Example of A.B.S. function setting when S9402 used (There will be a slight difference depending on the state of the linkage.)

- Basic setting

AB.P: Approx. 30% (If this value is too high, the braking distance will increase.)

CYCL: 5~7

DUTY: 0 (When grip is low: - side, when grip is high: + side)

DLY: 10~15%

TG.P: Approx. 70%

STM: OFF

- When the wheels lock, or the car spins, when the brakes are applied fully

AB.P: Increase from 30%

DUTY: Shift from 0 to - side (-1, -2, -3)

DLY: Reduce the delay

- When the braking effect is poor and the braking distance is long when the brakes are applied fully

AB.P: Decrease from 30%

DUTY: Shift from 0 to + side (+1, +2, +3)

DLY: Increase the delay