

## Instruction Manual

FDK32TU

This instruction manual contains important notices and how to use this product safely. Please be sure to read this instruction manual before you use this product. Please understand the following symbols that are used in this manual before reading this instruction manual.

The symbols are defined as follows:



Indicates a hazard that can cause severe personal injury, death, or substantial property damage if the warning is ignored.



Indicates a hazard that will or can cause minor personal injury, or property damage if the caution is ignored.



此產品須經專業工程人員安裝及設定，始得設置使用，且不得直接販售給一般消費者。  
This product must be installed and set up by professional engineers before it can be set up and used, and it cannot be sold directly to general consumers.

## Compliance Information Statement (for U.S.A.)

This device, trade name Futaba Corporation, model number FDK32TU, complies with part15 of the FCC Rules. Operation is subject to the following two conditions:

- (1) This device may not cause harmful interference, and
- (2) This device must accept any interference received, including interference that may cause undesired operation.

CAUTION: To assure continued FCC compliance

1. Any changes or modifications not expressly approved by the grantee of this device could void the user's authority to operate the equipment.
2. This equipment complies with FCC radiation exposure limits set forth for an uncontrolled environment. This equipment should be installed and operated with minimum distance 20cm between the radiator & your body. The responsible party of this device compliance is:

FUTABA Corporation of America  
2681 Wall Triana Hwy Huntsville, AL 35824, U.S.A.  
Phone:1-256-461-9399  
FAX:1-256-461-1059  
E-mail: [service@futabaUSA.com](mailto:service@futabaUSA.com)

## 低功率射頻器材技術規範警語

取得審驗證明之低功率射頻器材，非經核准，公司、商號或使用者均不得擅自變更頻率、加大功率或變更原設計之特性及功能。低功率射頻器材之使用不得影響飛航安全及干擾合法通信；經發現有干擾現象時，應立即停用，並改善至無干擾時方得繼續使用。前述合法通信，指依電信管理法規定作業之無線電通信。低功率射頻器材須忍受合法通信或工業、科學及醫療用電波輻射性電機設備之干擾。

**▲WARNING**

The following six are extremely important warnings.

1. Be sure to use this product within its specification; otherwise it may cause failures and malfunctions. Especially, pay great attention to temperature range and power source voltage.
2. Do not install this product to the sites where the product is disposed under the direct sunlight and/or under the high temperature. Prior to use this product, please make sure the temperature around the site where you are planning to use this product, because this product is guaranteed at the limited ranges in operating temperature and storage temperature. Operating the product beyond the guaranteed temperature range may cause failure of this product.
3. Do not install this product in a high humidity area. A drop of water on the circuit inside of this product may cause failure of this product.
4. Avoid this product from being watered. If water enters inside this product, it may cause failure of this product
5. The specification of the external interface of this product is different from ordinary one. Please make sure the wire identifications before connecting external equipment.
6. Be sure to confirm that the power switches are off before connecting or disconnecting connectors. Connecting and disconnecting connectors while any power is on may cause failures and malfunctions.

**▲CAUTION**

The following three are very important cautions in handling this product.

1. This product is designed specially for industrial applications. If you are planning to use this product in the area where the use of electromagnetic wave is restricted because medical equipment and airplanes are used near its area, Please confirm that this product does not interfere with those before you use this product. Please do not use this product unless you can confirm that this product does not interfere with those medical equipment and airplanes near the site.
2. Please pay attentions to the electromagnetic conditions around this product. This product uses electromagnetic wave as a communication method. Consequently, if there is a strong source of electromagnetic wave near this product, this product may not able to fully achieve its performance. Please check the electromagnetic conditions around the site where you are planning to use this product prior to use this product.
3. This instruction manual is protected by the law of copyright protects. Futaba Co. is not responsible to any problem and incident that are caused from reprinting this instruction manual by somebody other than Futaba.

**TABLE OF CONTENTS**

1.	INTRODUCTION.....	1
1-1.	Special Features.....	1
1-2.	Names and functions of parts of the mobile station .....	1
1-3.	Names and functions of parts of the coupler unit.....	3
2.	POWER.....	4
2-1.	Before turning on the power.....	4
2-2.	Voltage of the power source .....	4
2-3.	Connector for the power source .....	4
2-4.	Power switch .....	4
3.	INSTALLATION.....	5
3-1.	How to install the modem .....	5
3-2.	How to install the coupler .....	6
3-3.	Connecting the mobile station and the coupler unit .....	7
4.	CONNECTING COMMUNICATION CABLE.....	8
4-1.	Connector for RS-232C/RS-422.....	8
5.	SETTING SWITCHES .....	9
6.	SYSTEM OPERATION .....	10
6-1.	Outline of communication.....	10
6-2.	Preparation of communication on the air .....	10
6-3.	Data communication with serial port of the wireless modem .....	10
6-3-1.	Transmission.....	10
6-3-2.	Receiving.....	10
6-3-3.	Data packet format .....	10
6-3-4.	Communication on 1: n mode .....	10
7.	COMMUNICATION WITH MOBILE STATIONS.....	11
8.	COMMUNICATION COMMAND .....	12
9.	CONTROL COMMAND.....	13
10.	ADDRESS.....	15
11.	INDICATORS .....	16
12.	EXTERNAL RESET.....	17
13.	PRODUCT SPECIFICATION .....	18
13-1.	Communication characteristics of feeder cable.....	18
13-2.	External I/F specification .....	18
13-3.	mobile station's general specification.....	19
14.	FREQUENCY CHANNEL .....	20
14-1.	FSK mode.....	20
14-2.	OFDM mode .....	21

## 1. INTRODUCTION

### 1-1. Special Features

- 1) FDK32TU (mobile station) communicates with the modem FDK01TU (fixed station) through coupler FZE02TJ010 and 200-ohm feeder cable.
- 2) In this system, multiple mobile stations can be allocated to the single feeder cable. And each mobile station can have individual address that can be set externally. As a result, a single fixed station and multiple mobile stations can establish a communication network.
- 3) The interface between the external controller and the fixed station or the one between the external controller and the mobile stations is designed to meet RS-422 and RS232C.
- 4) FDK32TU has 2 operation mode:
  - ① FSK mode (1 ~ 50ch)  
Communication speed is 100kbps.
  - ② OFDM mode (51 ~ 100ch)  
Communication speed is up to 433kbps.

### 1-2. Names and functions of parts of the mobile station

- ① Indicators of signal reception level
- ② Indicator of signal transmission
- ③ Switches to set address
- ④ Switches to set transfer speed
- ⑤ Indicator of power switch

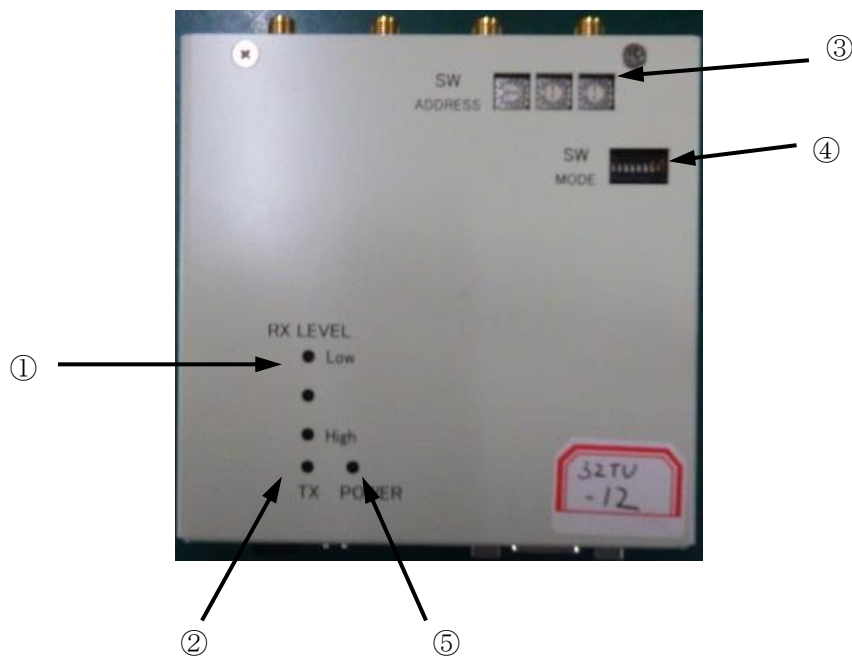

**Fig. 1-1**

- ⑥ Power switch
- ⑦ Connector to the 24V DC power
- ⑧ Connector to the external reset
- ⑨ Interface connector to RS-232C/RS422 (specially defined pin assignment)

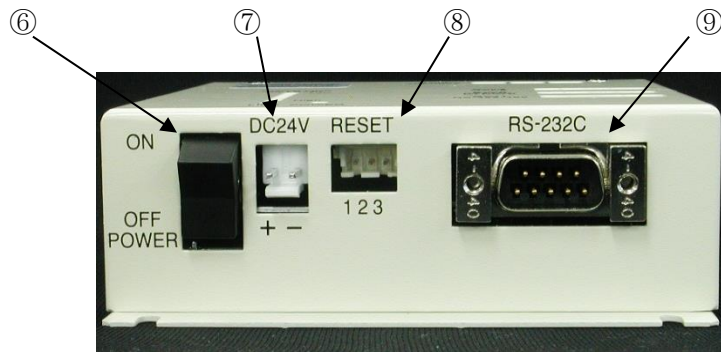

**Fig. 1-2**

- ⑩ R2 : Connector for receiving signal from coupler unit 2
- ⑪ R1 : Connector for receiving signal from coupler unit 1
- ⑫ T2 : Connector for sending signal to coupler unit 2
- ⑬ T1 : Connector for sending signal to coupler unit 1

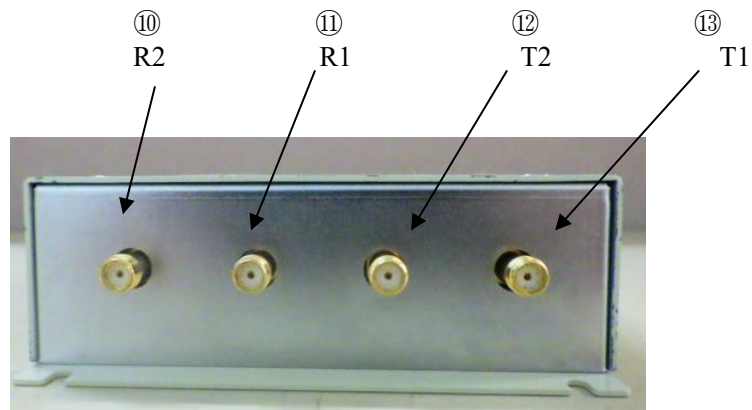

**Fig. 1-3**

1-3. Names and functions of parts of the coupler unit

- ⑭ Connect this terminal to the mobile station's R1 or R2.
- ⑮ Connect this terminal to the mobile station's T1 or T2.

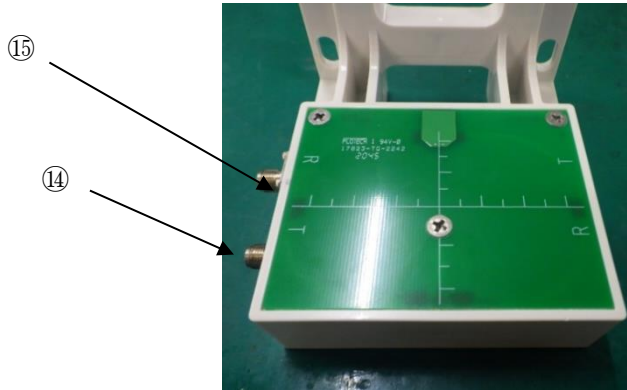

**Fig. 1-4**



## 2. POWER

### 2-1. Before turning on the power

Be sure to read this instruction manual prior to turning on the power of the modems.

Improper operations of the FDK modem may not only cause failures of communication but also cause malfunctions and/or damages of this modem and the external equipment connected to this modem.

In order to establish proper communication between this modem and the fixed station, communication parameters should be set by switches, which should be set before turning on the power switch.

In addition, since Futaba has specially defined the pin-assignment of interface connector for RS-232C/RS-422; please carefully confirm the wire identifications of the interface cable and pin layout.

### 2-2. Voltage of the power source

The input voltage to this modem should be within the range of 20Vdc and 29Vdc. Otherwise, this modem and the external equipment connected to this modem may cause damages or malfunctions.

### 2-3. Connector for the power source

The type of the connector used for this modem is S2P-VH made by J.S.T. Mfg Co., Ltd. Supply the voltage anywhere between 24V +/- 10% to the "+" marked terminal and connect the ground wire to the "-" marked terminal.

Connector for the power source

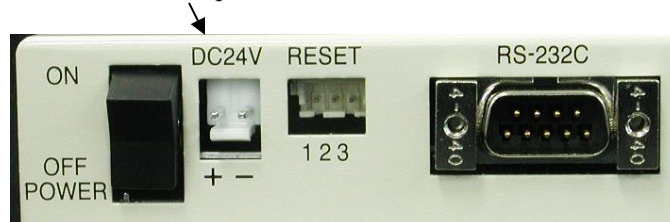

**Fig. 2-1**

### 2-4. Power switch

The label "POWER" is printed beside the power switch of this modem. (See Fig. 2-2)

Pushing this switch toward "ON" will turn on the power switch and the LED indicator of the power on top of the unit turns on green. On the other hand pushing the switch toward "OFF" will turn off the power. The picture 2-4 shows "OFF" state.

Power switch

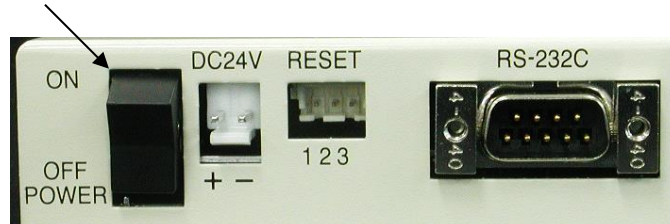

**Fig. 2-2**

### 3. INSTALLATION

The modem and coupler are mounted on a cart used in semiconductor plants.

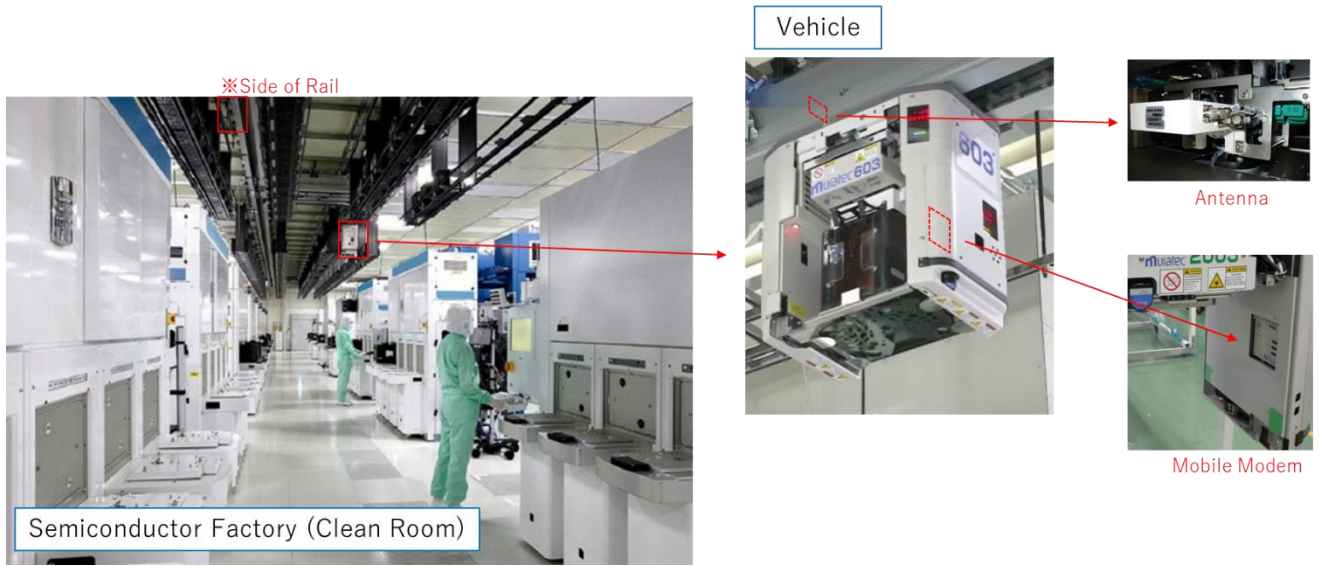

**Fig. 3-1**

#### 3-1. How to install the modem

Fasten the modem by screwing the four corners with four M3 screws.

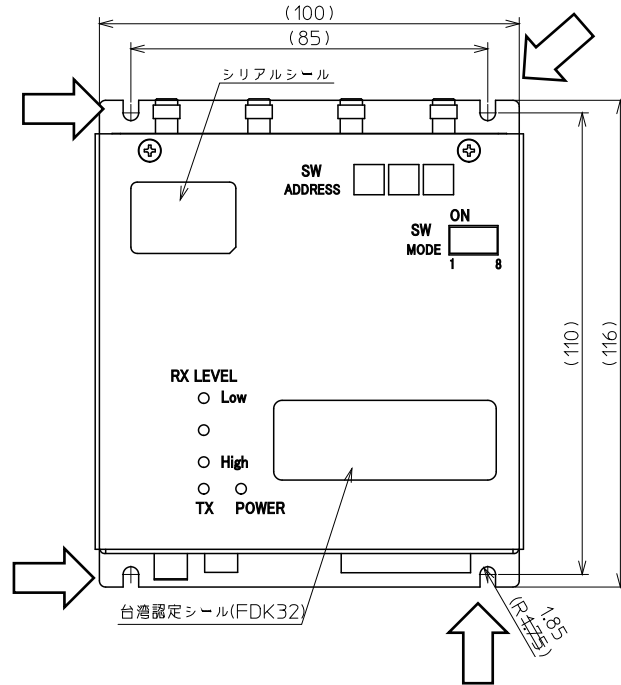

**Fig. 3-2**

3-2. How to install the coupler

Fasten the coupler by screwing the below points with four M5 screws.

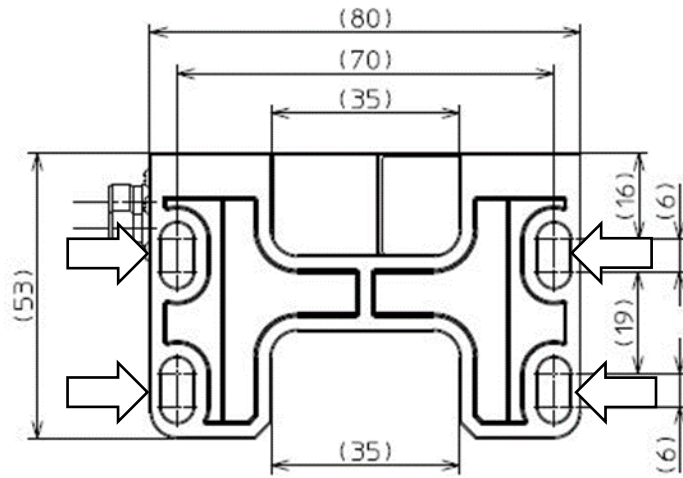

**Fig. 3-3**

The coupler should be installed in the following manner relative to the orientation of the feeder cable.

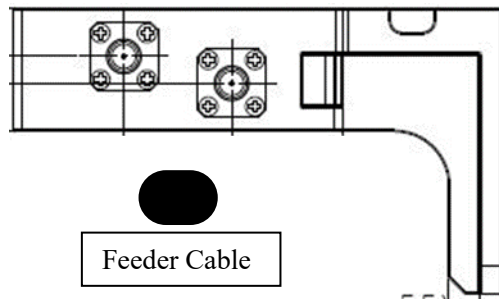

**Fig. 3-4**

3-3. Connecting the mobile station and the coupler unit

此產品須經專業工程人員安裝及設定, 始得設置使用, 且不得直接販售給一般消費者。

**CAUTION**

This product must be installed and set up by professional engineers before it can be set up and used, and it cannot be sold directly to general consumers.

A mobile station has four 50-ohm impedance SMA connectors.

Two connectors are for transmission and the other two are for reception.

Connections between a mobile station and the two units of couplers are shown in figure 3-1. T1 and R1 of a mobile station should be connected to one unit of two couplers. T2 and R2 of the mobile station should be connected to the other like Fig. 3-5.

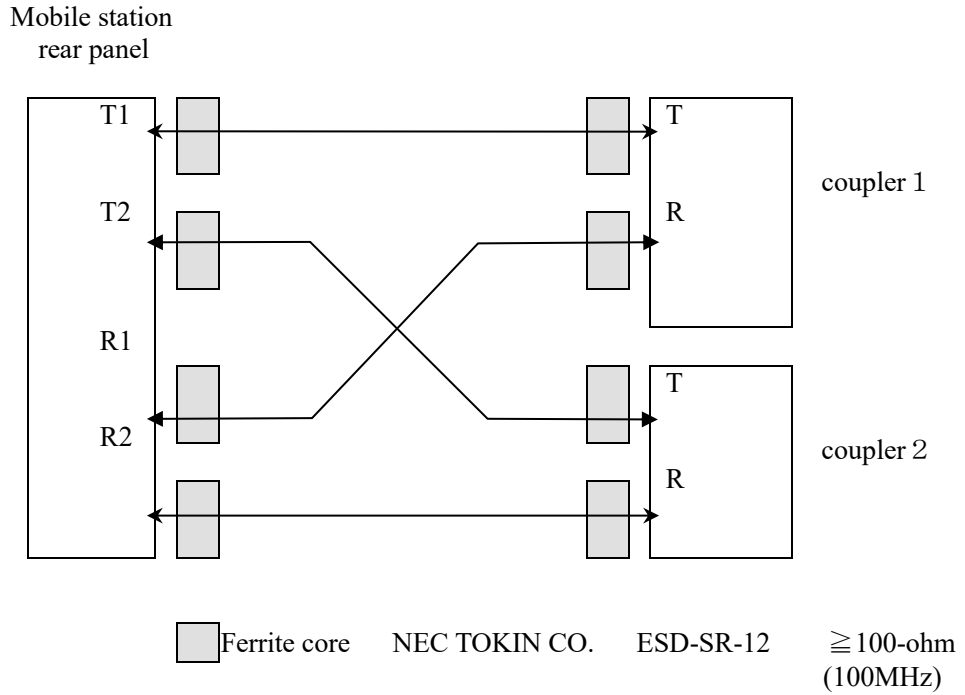

**Fig. 3-5**

## 4. CONNECTING COMMUNICATION CABLE

### 4-1. Connector for RS-232C/RS-422

Connector model: Hirose Electric Co., Ltd. RDED-9P-LN (4-40) (50)

Please select one out of RS-232C and RS-422.

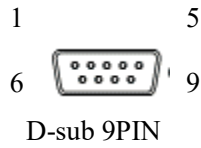

PIN No.	Signal name	Note
1	NC	RS-232C transfer data
2	TD	
3	RD	
4	NC	
5	GND	Signal ground
6	RD+	RS422
7	RD-	↓
8	TD+	
9	TD-	

RS-232C uses the pins 2, 3 and 5.

RS-422 use the pins 5 through 9.

SW 1 on top of the unit can select either RS-422 and can either connect the termination resistors or disconnect them.

SW2 is the common switch for RS-232C and RS-422 to set parameters of communication speed and so on.

Please refer to the next section for further detail.

**5. SETTING SWITCHES**

The functions of the dipswitches and a rotary switch are follows:

**Table 5-1 SW (DIP-8)**

bit	item	ON	OFF
1	Select RS-232C or RS-422	RS-422	RS-232C
2	Reserved		
3			
4			
5			
6			
7	Transfer speed	Refer to Table 5-2.	
8			

**Table 5-2 Setting of transfer speed**

No.	SW		Transfer speed
	Bit7	Bit8	
1	ON	ON	921.6kbps
2	OFF	ON	115.2kbps
3	OFF	OFF	19.2kbps

**Table 5-3 Address SW (3 sets of 16-step rotary switch)**

Item	Effective value	note
Own address	400h to FFFh	Default value is 400h 000h through FFFh are prohibited.

## 6. SYSTEM OPERATION

### 6-1. Outline of communication

FDK32TU is the wireless modem unit to communicate with FDK31TU. To send data to FDK31TU through serial port (RS-232C, 422) of FDK32TU, apply command @TXT or @TBN. Refer to the instruction manual about detail of @TXT or @TBN command. Communications on the air through feeder line and coupler are performed with packet data transmission mode.

### 6-2. Preparation of communication on the air

Before making communication on the air with FDK31TU, it is necessary to chose frequency and chose the port of two couplers of transmitter and receiver. The frequency of each FDK32TU and FDK31TU must be same. To select the port of two couplers of transmitter and receiver, use @COP command. @COP command is used in case of branching the 200 ohms feeder line, and so on. FDK32TU has no automatic selection function of the coupler, such as diversity mode.

### 6-3. Data communication with serial port of the wireless modem

#### 6-3-1. Transmission

To send data to FDK31TU through serial port (RS-232C, 422) of FDK32TU, apply command @TXT or @TBN. If there was respond ACK from FDK31TU on the air, FDK32TU make OK output to its serial port (RS-232C, 422). If there was no ACK from FDK31TU on the air, then FDK32TU make NG output through its serial port (RS-232C, 422).

#### 6-3-2. Receiving

FDK32TU calculate CRC and make address recognition and make data output through its serial port (RS-232C, 422).

#### 6-3-3. Data packet format

Data packet format is described below.

Preamble	Header	Data	CRC
----------	--------	------	-----

Preamble : 32 times repetition of 1 and 0.

Header : address of recipient, and address of transmitter, number of retransmission, number of packet, and so on.

Data : data to be sent up to 1024 bytes.

CRC : CRC16 calculated with Header to Data.

#### 6-3-4. Communication on 1: n mode

One FDK31TU able to perform 1: n communication with defined number of FDK32TU. To make 1:n communication, define plural address on address part of @TXT or @TBN command. Addresses input through serial port (RS-232C, 422) of FDK31TU will be added to its header.

## 7. COMMUNICATION WITH MOBILE STATIONS

Communication procedure (an example)

- 1) Set parameters of fixed station, and make it effective to communicate with mobile stations.
- 2) Connect to the power source.
- 3) Connect the external interface (One of RS-232C and RS422)
- 4) Connect to the matching/distributing unit.  
(The order between ② and ④ can be changed freely.)
- 5) Turn on the fixed station and mobile stations.  
(The order to turn on the powers is free.)
- 6) Wait more than 1 second and then set frequency channel.  
After receiving a response of "OK", forward to the next step.
- 7) Send command/data in format of @TXT or @TBN.  
If "OK" is returned, the communication is completed.

If "NG" is returned, possible reasons of the failure are insufficient signal strength and improper settings of communication cable, switches and frequencies.

Send @PNG command and read the value of RSSI. If the value is 57 or larger, please confirm the setting condition again.

If "OK" is returned, it is possible to continue communication by repeating ⑦.



## 8. COMMUNICATION COMMAND

Input and output between external control equipment and mobile stations are carried out by packet method. The data format of the packet method is either in the sequence of "@TXT (address) (user data) [CR] [LF]" or in the sequence of "@TBN (address) (data length) (user data)"

Binary data method is useful to avoid communication errors when a control code matches exactly a part of user data.

---

Text data      @TXT (address) (user data) [CR] [LF]

---

Address        : ASCII code, hexadecimal 3-digits  
                   (For instance, 4 is "34h" in ASCII.)  
 Data            : ASCII code, hexadecimal  
 The data length : Arbitrary but no more than 1024 bytes.  
 [CR]           : 0Dh in hexadecimal  
 [LF]           : 0Ah in hexadecimal

Example        :    Sending "ABCDEFGH" to a mobile station whose address is 001.

@TXT001ABCDEFGH [CR] [LF]

---

Binary data    @TBN (address) (data length) (user data)

---

Address        : ASCII code, hexadecimal 3-digits  
 Data length    : "001" to "400"    (0 to 1024 bytes)  
                   The number of bytes should be expressed by hexadecimal 3-digits in  
                   ASCII code.  
 [CR][LF]      : not necessary

If data length is longer than predetermined data length, the surplus of the data will slide in front of the next instruction. Therefore "NG [CR] [LF]" may be returned to the data sender.

Example        :    Sending 7 bytes of binary data to a mobile station whose address is 001.

@TBN001007 (7 bytes of binary data)

Taking into consideration the manual input through terminal software, the text data method can delete a character by recognizing backspace key while the binary data method treats backspace key as data.

In the case that transmission and reception of all the data is completed properly, the sender will output the message "OK [CR] [LF]" after receiving ACK of the last packet.

On the other hand, the receiver will output the same character string that was sent from the sender from the headfirst. In case of @TBN command, the receiver will output the data that is within the range determined by the user data length, otherwise surplus of the data will not be outputted.

In case of communication error, if ACK is not returned from the destination after repeating retransmission up to the preset number, the sender will stop sending data and output "NG [CR] [LF]" immediately after detection of the end of input data.

In case of failure while sending a packet due to communication error, the sender will output the partial data that the sender could properly receive from the external interface of the receiver.

## 9. CONTROL COMMAND

Control commands are used for controlling the fixed station.

**Table 9-1 Command table**

No.	Command string	content
1	FRQ	Write or read frequency channel number
2	PNG	Request response & read the reception intensity of the destination
3	RST	Reset software
4	COP	Setting of the coupler or readout

**@FRQ** : Write or read frequency channel number

---

1) Input : @FRQpp[CR][LF]

ppp : Input a number between 1 and 50 (ASCII code) or input nothing for ppp.

(Note)

Inputting a single digit is allowed for 1 through 9.

Do not input space between "FRQ" and "ppp".

2) Processing : If there is no input for "ppp", the current frequency channel number will be outputted.  
Response message

FRQ = ppp [CR] [LF]

(Note)

pp: 00 to 120 (ASCII code)

Spaces are necessary in front of and afterwards of "=".

If a channel number is inputted in "ppp", this modem will return "OK" message to the host computer after changing the SRAM register and reassign the frequency number,.

3) Frequency channel at the booting

At the booting this modem and resetting the software, the frequency channel is 0.

**@PNG** : Request response & read the reception intensity of the destination

---

1) Input : @PNG[CR][LF]

2) Processing : Receiving this command, this modem returns as a response message the signal intensity of the last packet that this modem has received.

Response message

RSSI = nn [CR] [LF]

nn: Hexadecimal number of signal intensity in [dBm]

**@RST** : Reset software

---

- 1) Input : @RST[CR][LF]
- 2) Processing : Receiving this command, software will be reset.  
 This command restarts the exerciser program from the start address.  
 Also the SRAM register will be reset to the condition when this modem was turned on.  
 In addition, this command will initialize not only the software but also the hardware of this modem.  
 It takes about 300ms.  
 After the completion of initialization, a response message of "OK" will be returned to the host computer.

**@COP** : Setting of the coupler or readout (valid only for mobile stations)

---

- 1) Input : @COPp[CR][LF]  
 "p" should be 1 or 2 in ASCII code, or enter nothing.  
 Do not input space between "COP" and "p".
- 2) Processing : in case of no value for "p";  
 The current status of the coupler is read out.  
  
 The message will be;  
 COP = p [CR] [LF]  
 p= 1 or 2 in ASCII code  
 A space code (0x20) will be added to either side of the "=".  
 : In case that some value is inputted for "p":  
 Coupler units will be switched.
- 3) Default setting  
 COP = 1
- 4) Timing of command execution  
 Receiving a command from external I/F, the mobile terminal will carry out the command and return its end message immediately after the disconnection of the coupler is completed. This command will be carried out regardless of the communication status on the feeder.

## 10. ADDRESS

The effective addresses for mobile stations are from 400 through FFF.

Use rotary switch for setting.

Set the address at "001" when sending data to the fixed station from mobile stations.

**11. INDICATORS**

POWER	When green LED is on, the power is on.
TX	When green LED is off, there is no packet. When green LED is on, packets have been sent to feeder cables.
RX LEVEL	Combinations of eight LEDs indicate the levels of the signal intensity. 1 LEDs ON : < -80dBm 2 LEDs ON : < -70dBm 3 LEDs ON : > =-70dBm

## 12. EXTERNAL RESET

The following connector is equipped with this modem so that the hardware of this modem can be reset externally.

Connector type : J.S.T. Mfg Co., Ltd S3B-XH-SM3-TB

In order to reset this modem externally, short #2 and #3 pins of the RESET connector in the picture 11-1 more than 10ms: then disconnect them.

**13. PRODUCT SPECIFICATION****13-1. Communication characteristics of feeder cable**

Item	Notes
<b>【FSK mode】</b>	
Down link frequency band (receiver)	230 MHz ~ 235 MHz
Up link frequency band (transmitter)	151 MHz ~ 156 MHz
Frequency band per channel	100 kHz
Interval between frequency channels	100 kHz
Number of frequency channels	50
Communication speed	100 kbps
<b>【OFDM mode】</b>	
frequency band (transmitter / receiver)	302 MHz ~ 322 MHz
Frequency band per channel	400 kHz
Interval between frequency channels	400 kHz
Number of frequency channels	50
Communication speed	433 kbps
<b>【Common to All mode】</b>	
Emission power	FCC part15 Class B $\leq 46\text{dB } \mu\text{V/m at 3m}$
Reception signal intensity	-87dBm (at 100kbs, PER $\leq 10^{-1}$ )
Addresses for mobile modems (own address)	400h~FFFh(3072 addresses)
Communication mode	Full-Duplex Packet mode

**13-2. External I/F specification**

Item	Notes
Connector	D-sub 9 pins
Communication standards	RS-232C, RS-422(Specially defined pin assignments are used for this product.)
Communication speed	19.2kbps, 115.2kbps, 921.6kbps
Communication method	RS-232C,RS-422 Full-Duplex Packet mode

## 13-3. mobile station's general specification

Item	Notes
Voltage of the power source	DC 24V +/- 10%
Consumption power	$\leq 7.5W$
Outer dimensions	102(D) x 116(W) x 35(H) mm
Weight	Approx. 450g
Material of the chassis	Iron (1 mm thickness)
Surface treatment of the chassis and color	Surface treatment : Coating on bonded steel Color : DIC 546 1/2 (Dainippon Ink)
Operating temperature range	-10C to +50C
Storage temperature range	-20C to +70C
Operating humidity rage	35%RH to 95%RH (under no condensation)
Storage humidity range	35%RH to 95%RH (under no condensation)
Anti-vibration	The product should survive the following vibration test; Vibration amplitude : 3.5mm Frequency : 10Hz 2 hours for back and forth 2 hours for left and right 4 hours for up and down
Anti-shock	The product should survive the following shock test; Acceleration : 500 m/s <sup>2</sup> 3 times along with 3 axis, total 9 times 500 m/s <sup>2</sup>
Anti-electro static	Apply following high voltage Input/output : $\pm 2kV$ (contact discharge) There should be no malfunction after test. : $\pm 4kV$ (contact discharge) There should be no damage after test. The test follows IEC61000-4-2



**14. FREQUENCY CHANNEL****14-1. FSK mode**

Channel No.	Frequency		Channel No.	Frequency	
	Down-link [MHz]	Up-link [MHz]		Down-link [MHz]	Up-link [MHz]
1	230.05	151.05	26	232.55	153.55
2	230.15	151.15	27	232.65	153.65
3	230.25	151.25	28	232.75	153.75
4	230.35	151.35	29	232.85	153.85
5	230.45	151.45	30	232.95	153.95
6	230.55	151.55	31	233.05	154.05
7	230.65	151.65	32	233.15	154.15
8	230.75	151.75	33	233.25	154.25
9	230.85	151.85	34	233.35	154.35
10	230.95	151.95	35	233.45	154.45
11	231.05	152.05	36	233.55	154.55
12	231.15	152.15	37	233.65	154.65
13	231.25	152.25	38	233.75	154.75
14	231.35	152.35	39	233.85	154.85
15	231.45	152.45	40	233.95	154.95
16	231.55	152.55	41	234.05	155.05
17	231.65	152.65	42	234.15	155.15
18	231.75	152.75	43	234.25	155.25
19	231.85	152.85	44	234.35	155.35
20	231.95	152.95	45	234.45	155.45
21	232.05	153.05	46	234.55	155.55
22	232.15	153.15	47	234.65	155.65
23	232.25	153.25	48	234.75	155.75
24	232.35	153.35	49	234.85	155.85
25	232.45	153.45	50	234.95	155.95

## 14-2. OFDM mode

Channel No.	Frequency [MHz]	Channel No.	Frequency [MHz]
51	302.2	76	312.2
52	302.6	77	312.6
53	303.0	78	313.0
54	303.4	79	313.4
55	303.8	80	313.8
56	304.2	81	314.2
57	304.6	82	314.6
58	305.0	83	315.0
59	305.4	84	315.4
60	305.8	85	315.8
61	306.2	86	316.2
62	306.6	87	316.6
63	307.0	88	317.0
64	307.4	89	317.4
65	307.8	90	317.8
66	308.2	91	318.2
67	308.6	92	318.6
68	309.0	93	319.0
69	309.4	94	319.4
70	309.8	95	319.8
71	310.2	96	320.2
72	310.6	97	320.6
73	311.0	98	321.0
74	311.4	99	321.4
75	311.8	100	321.8