

EUT Internal Photos

*Figure 19
Internal View*

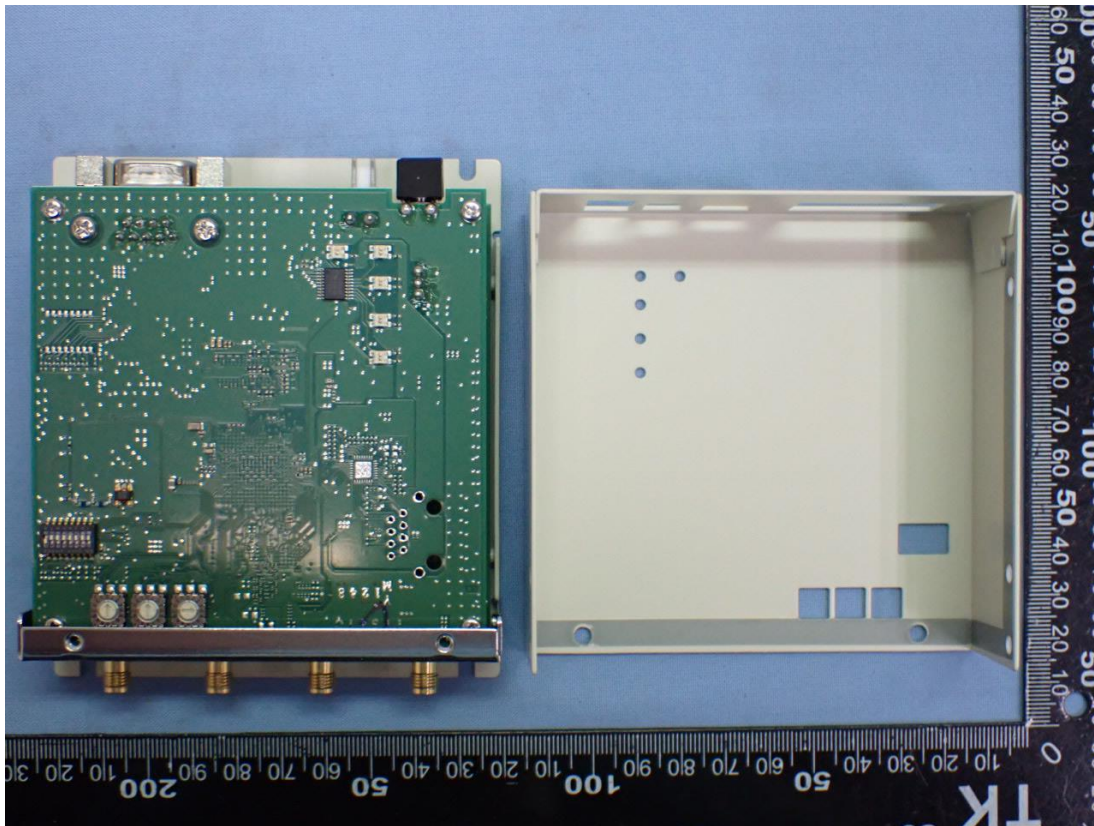

*Figure 20
Internal View*

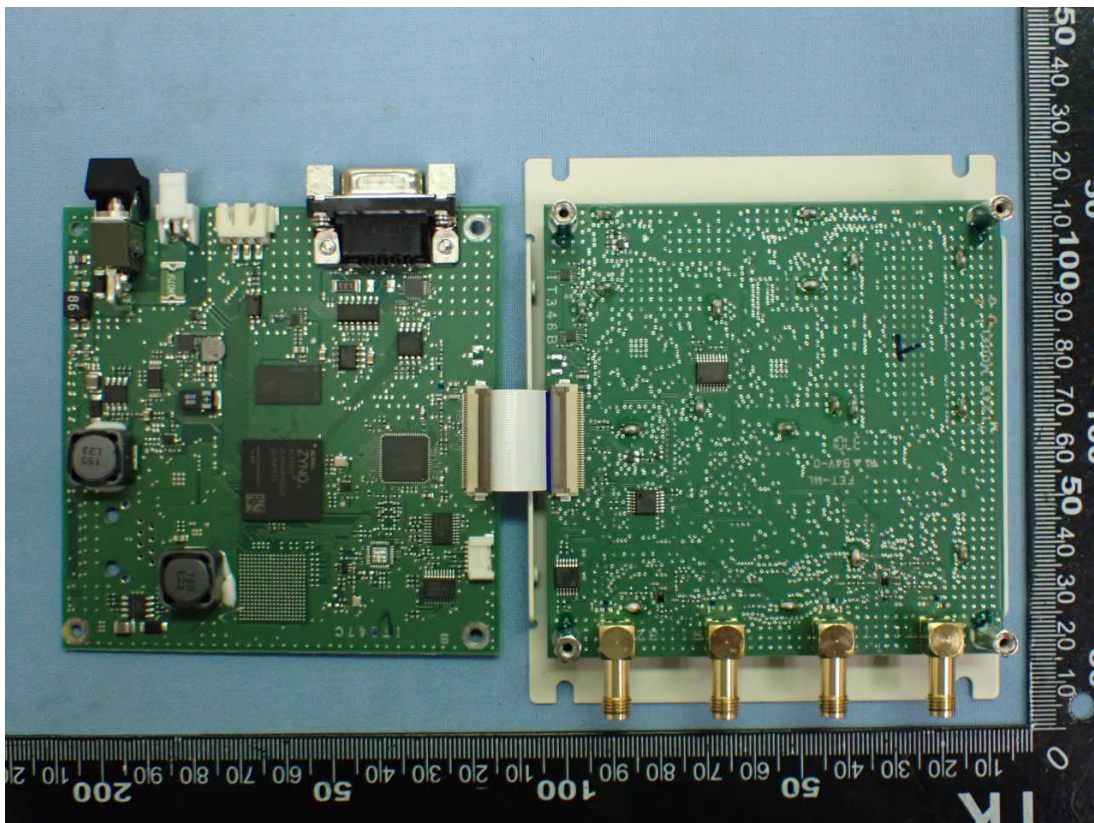

Figure 21
Internal View

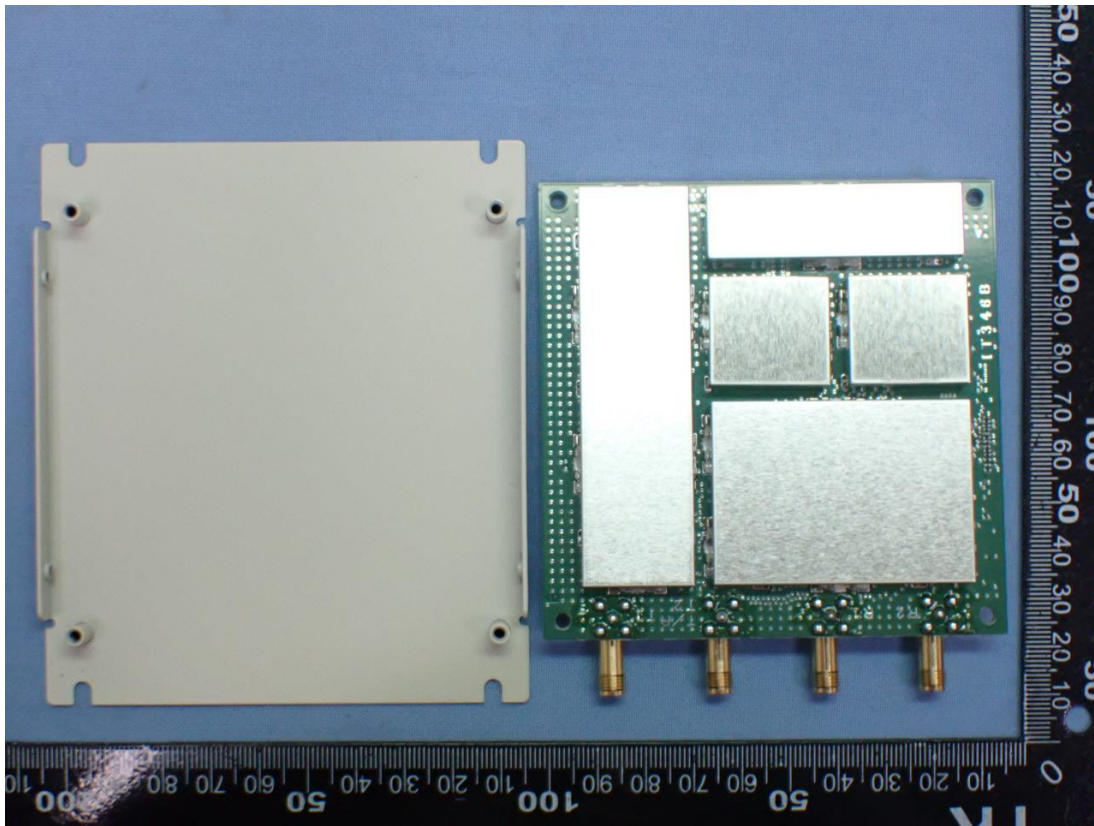

Figure 22
Internal View

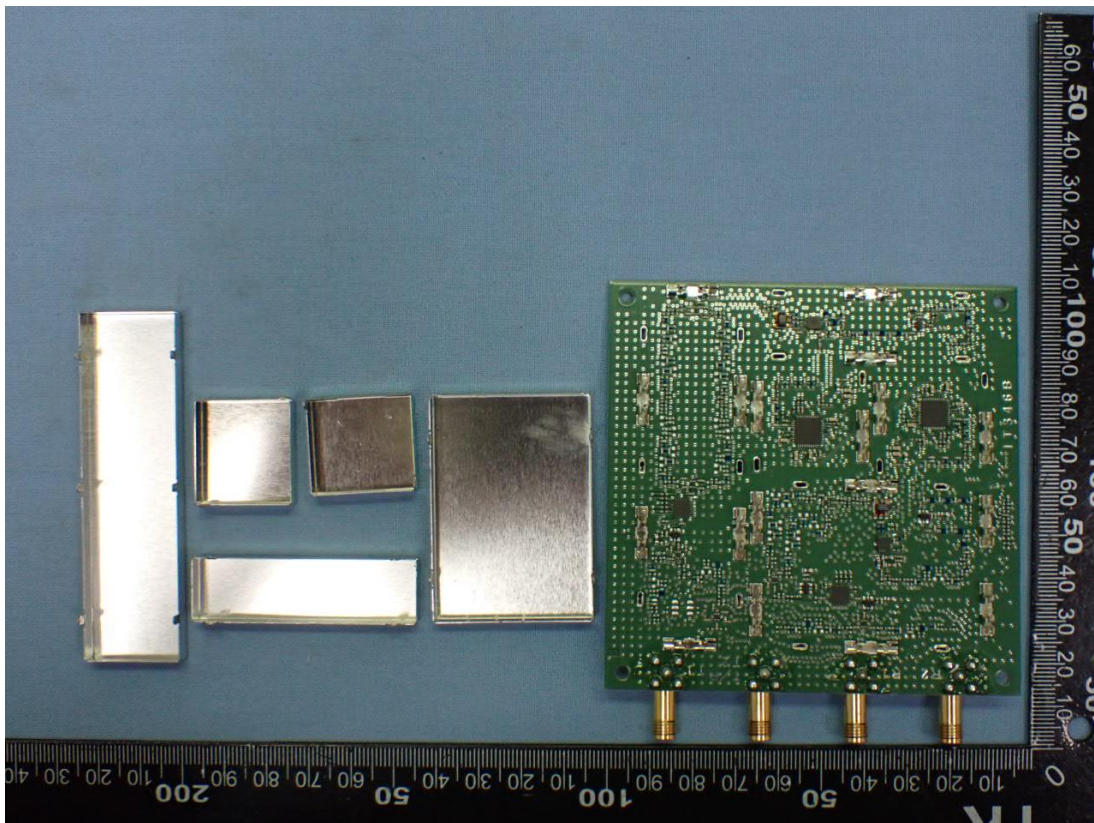

Figure 23
PCB, Front View

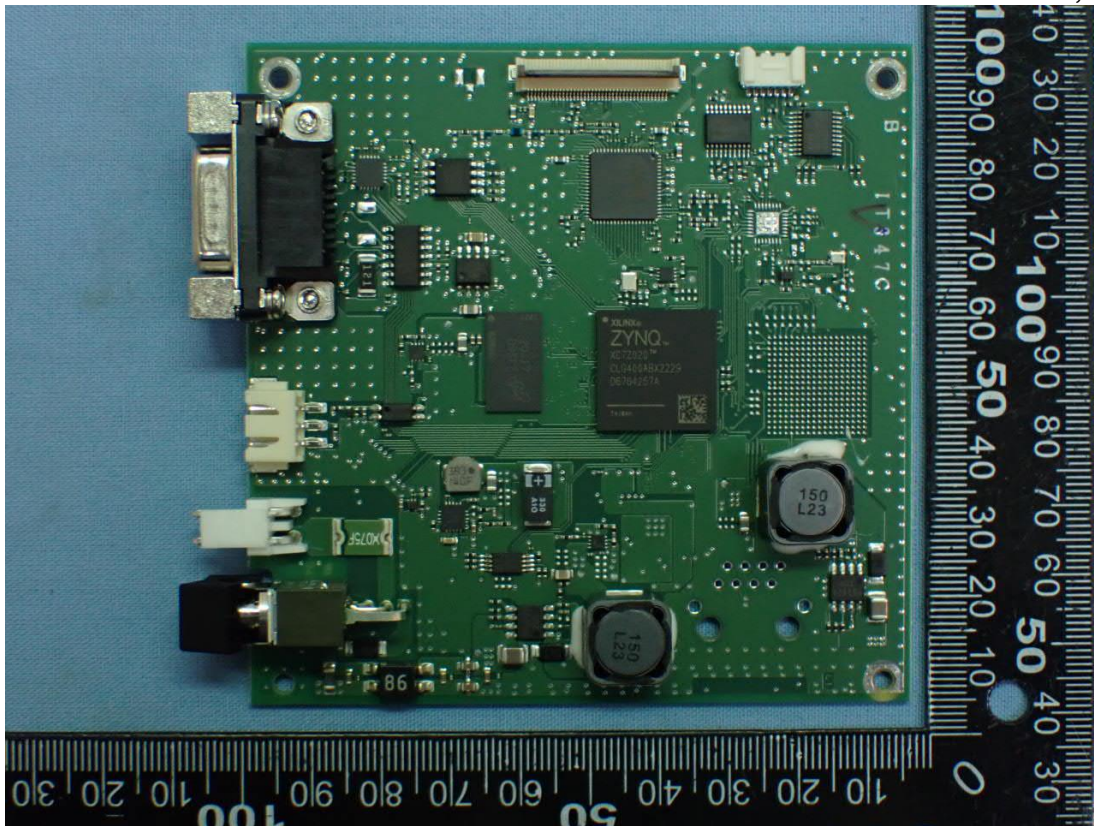

Figure 24
PCB, Back View

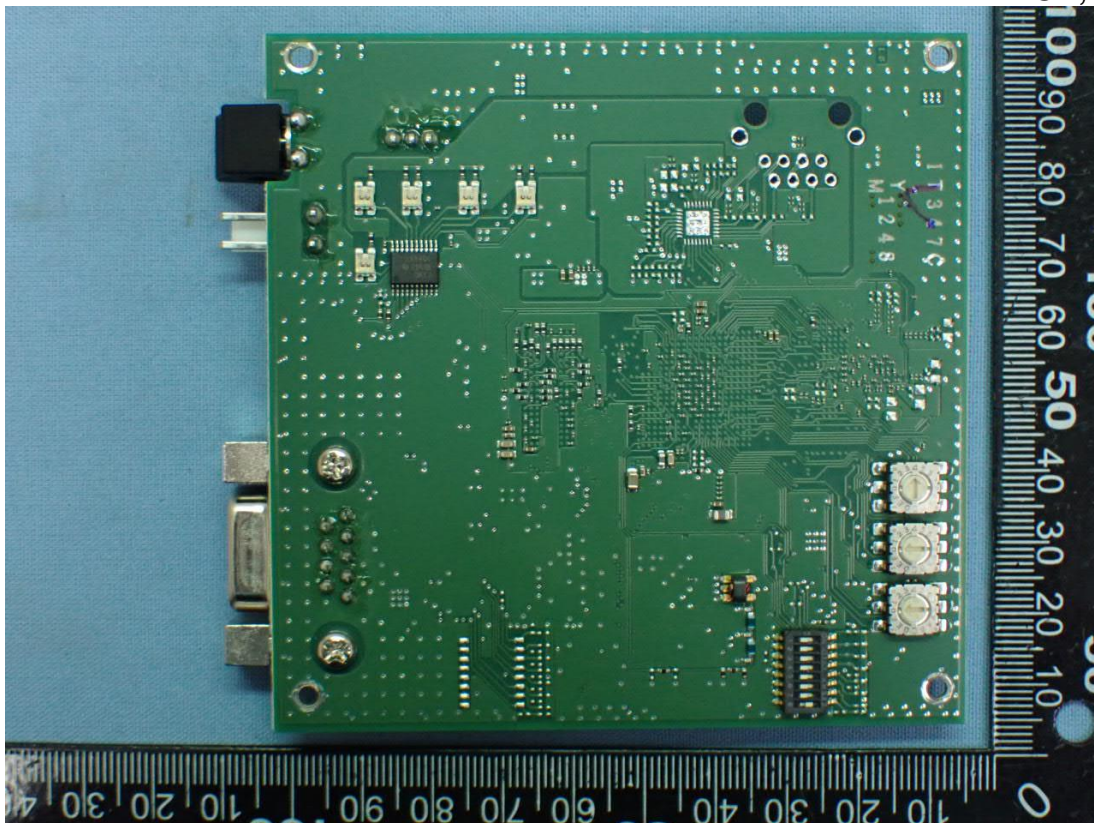

Figure 25
PCB, Front View

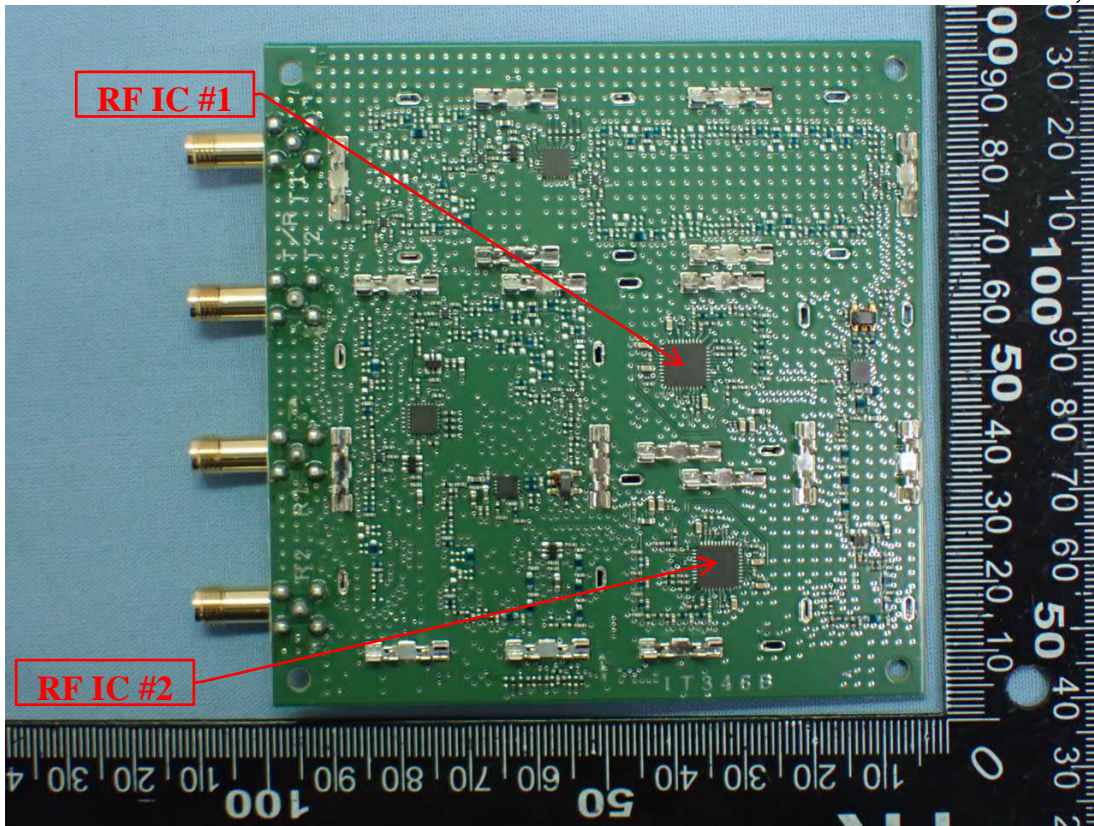

Figure 26
PCB, Back View

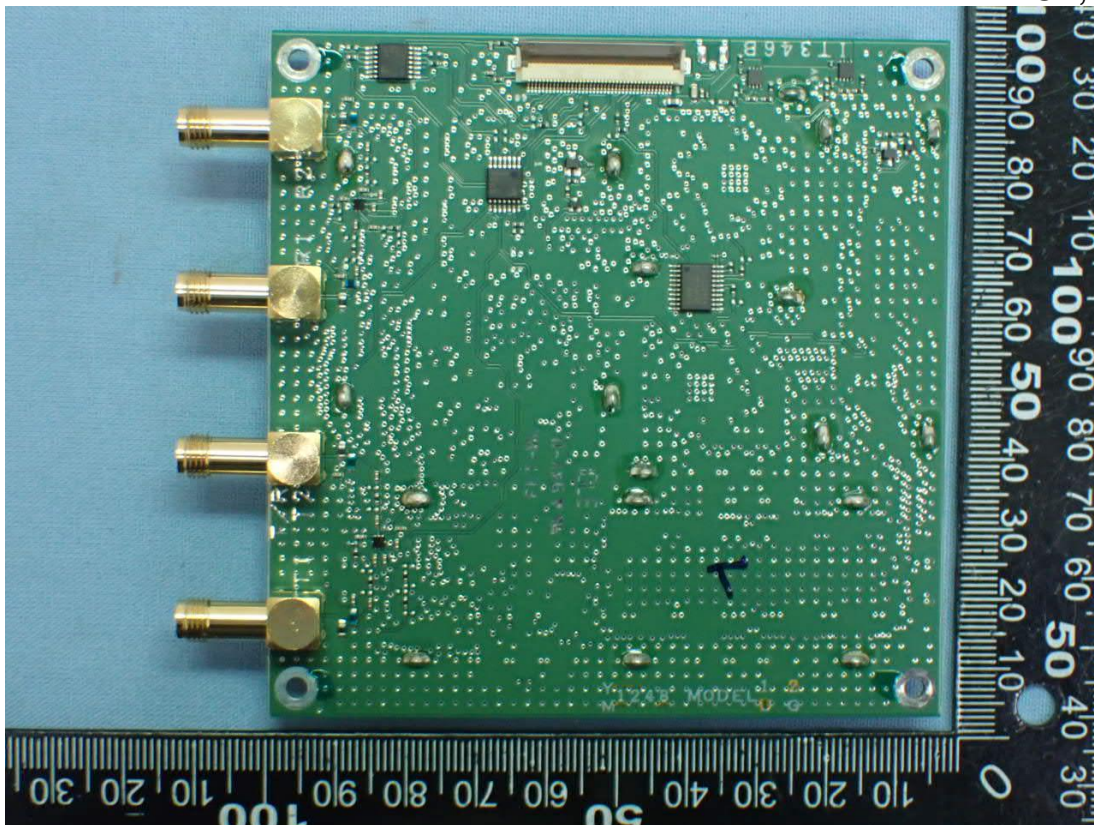

Figure 27
RF IC#1: LMX2572



Figure 28
RF IC#2: LMX2572

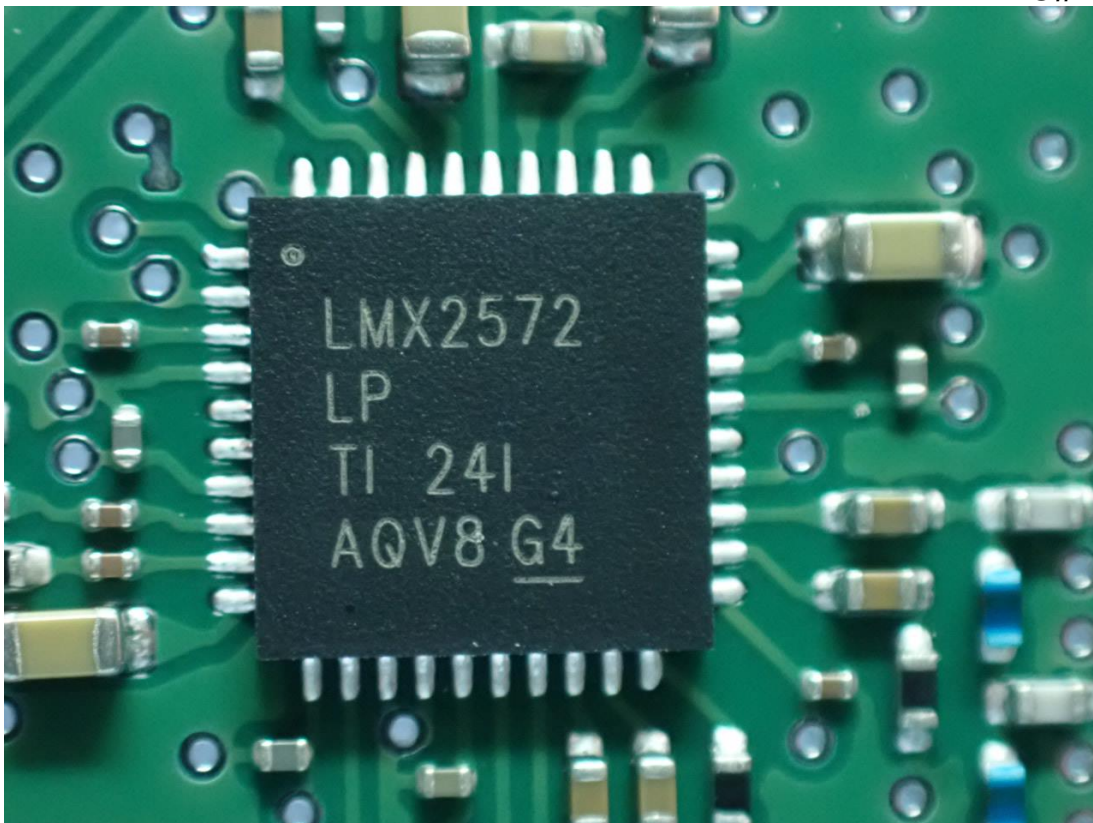

Figure 29
Oscillator View

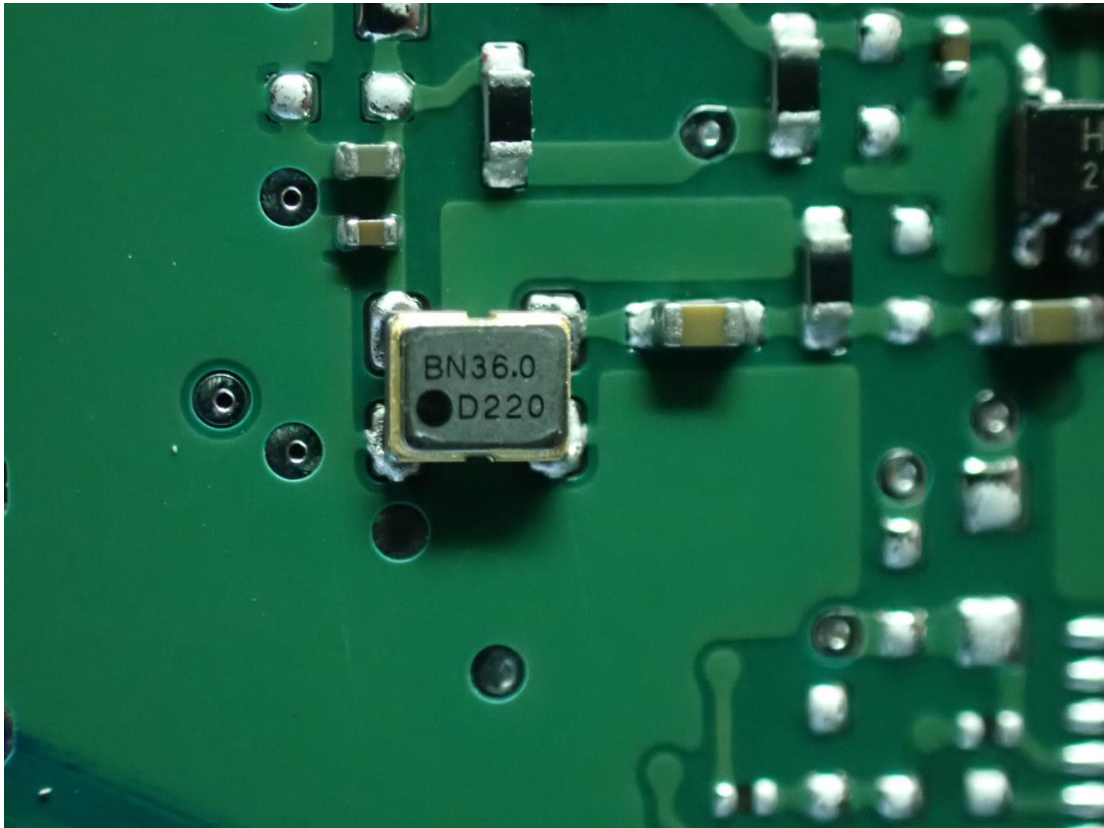

Figure 30
Oscillator View

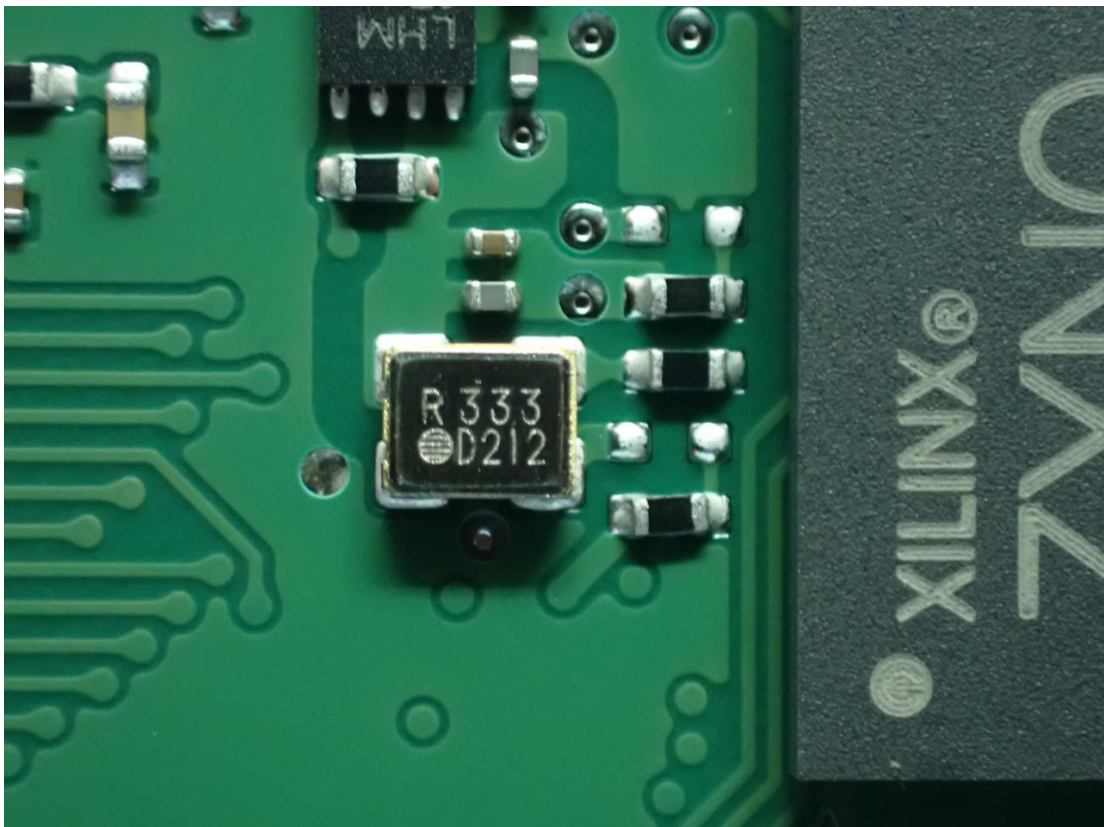

Figure 31
Antenna#1 (Internal View)

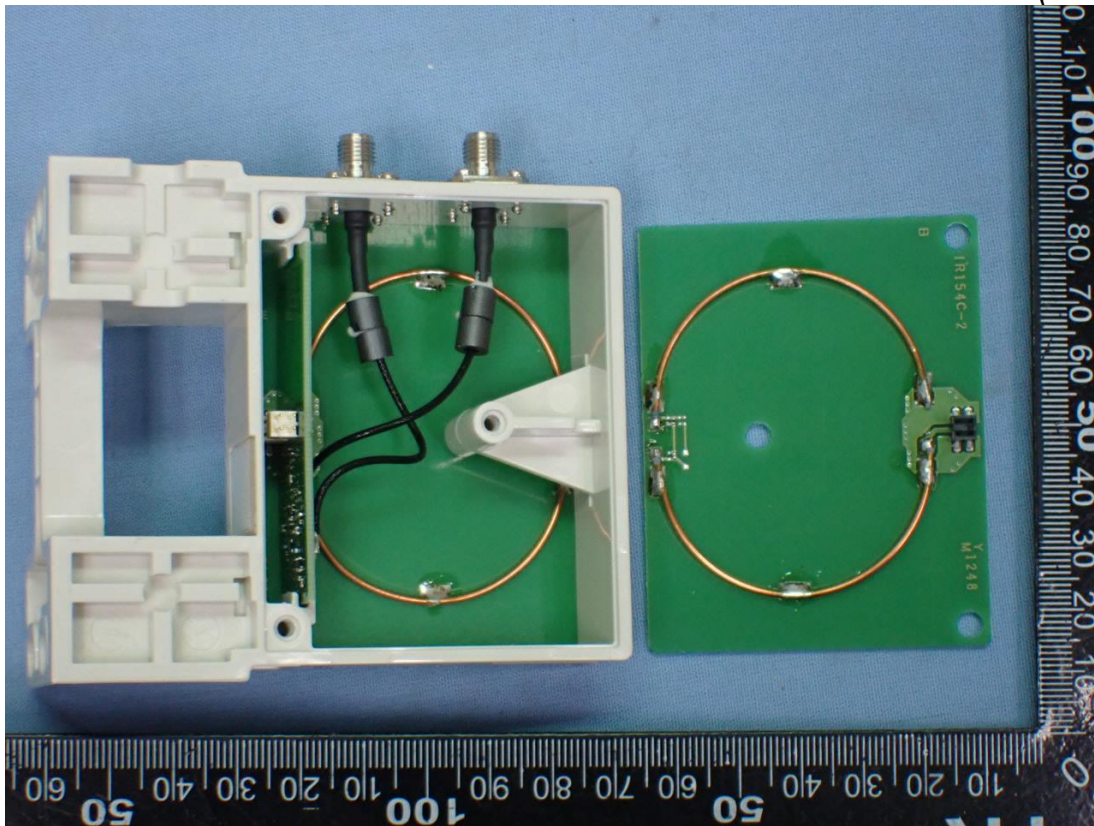

Figure 32
Antenna#1 (Internal View)

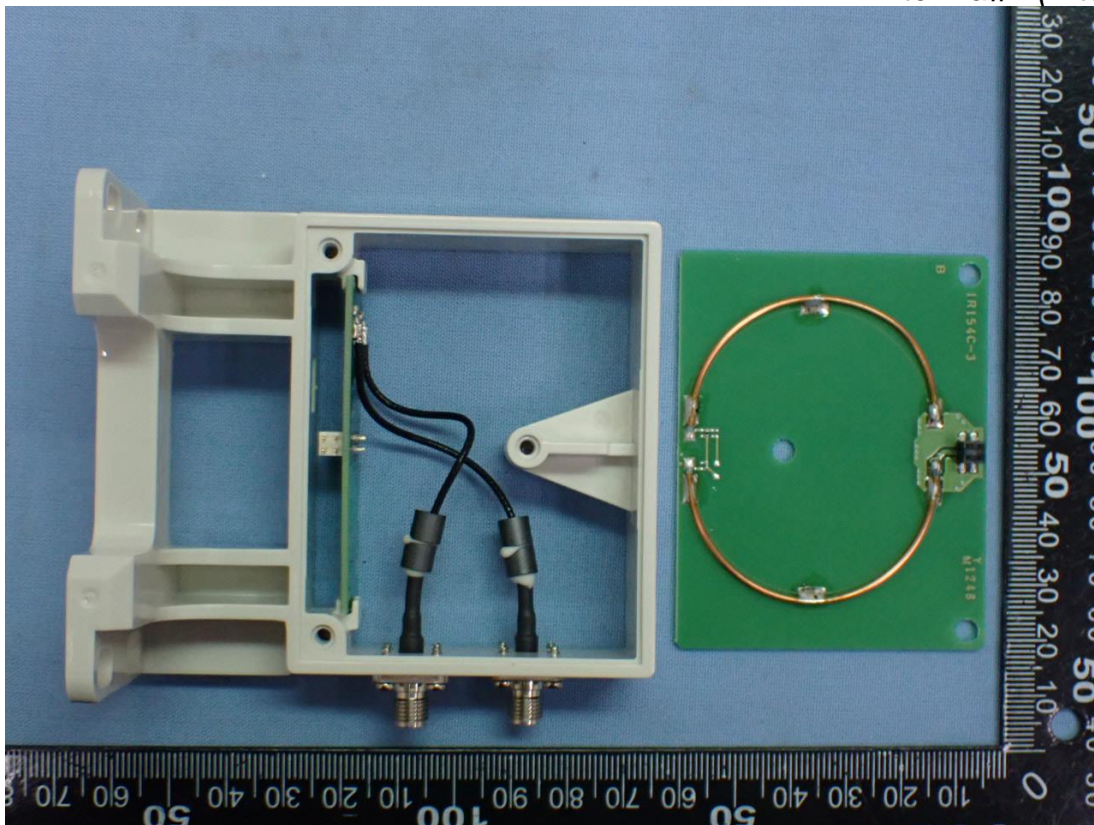

Figure 33
Antenna#1, PCB, Front View

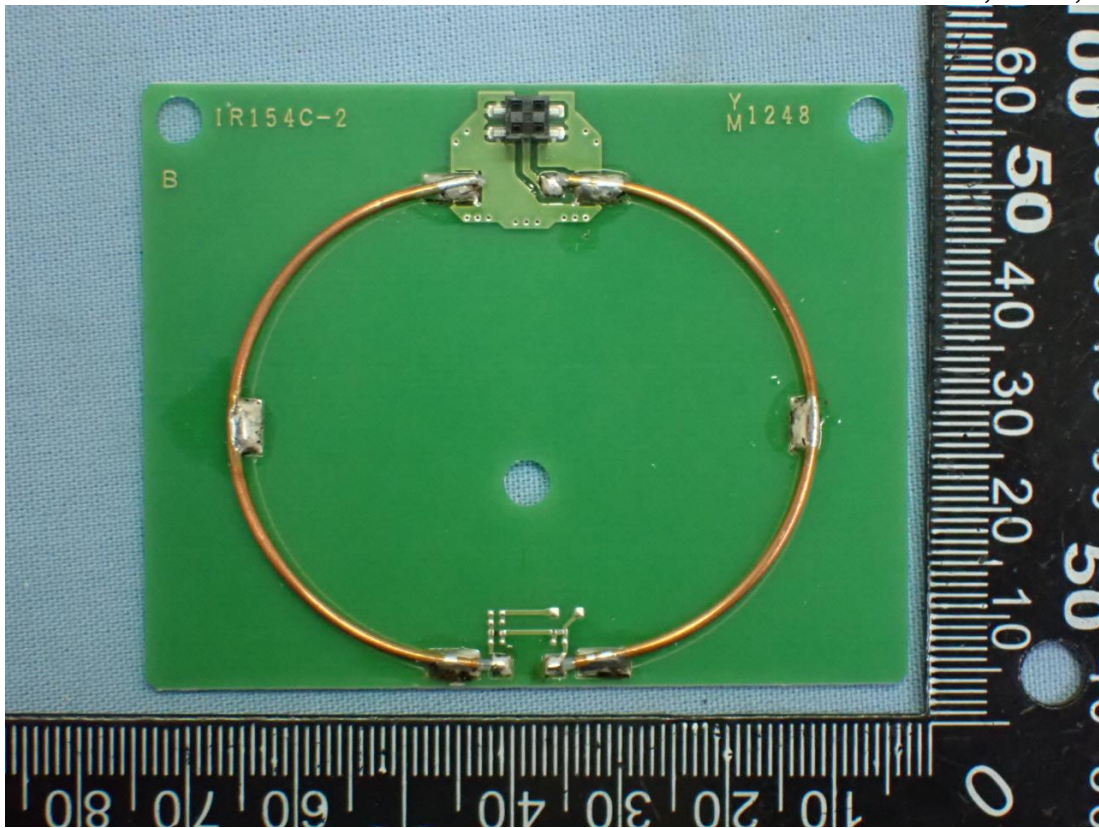

Figure 34
Antenna#1, PCB, Back View

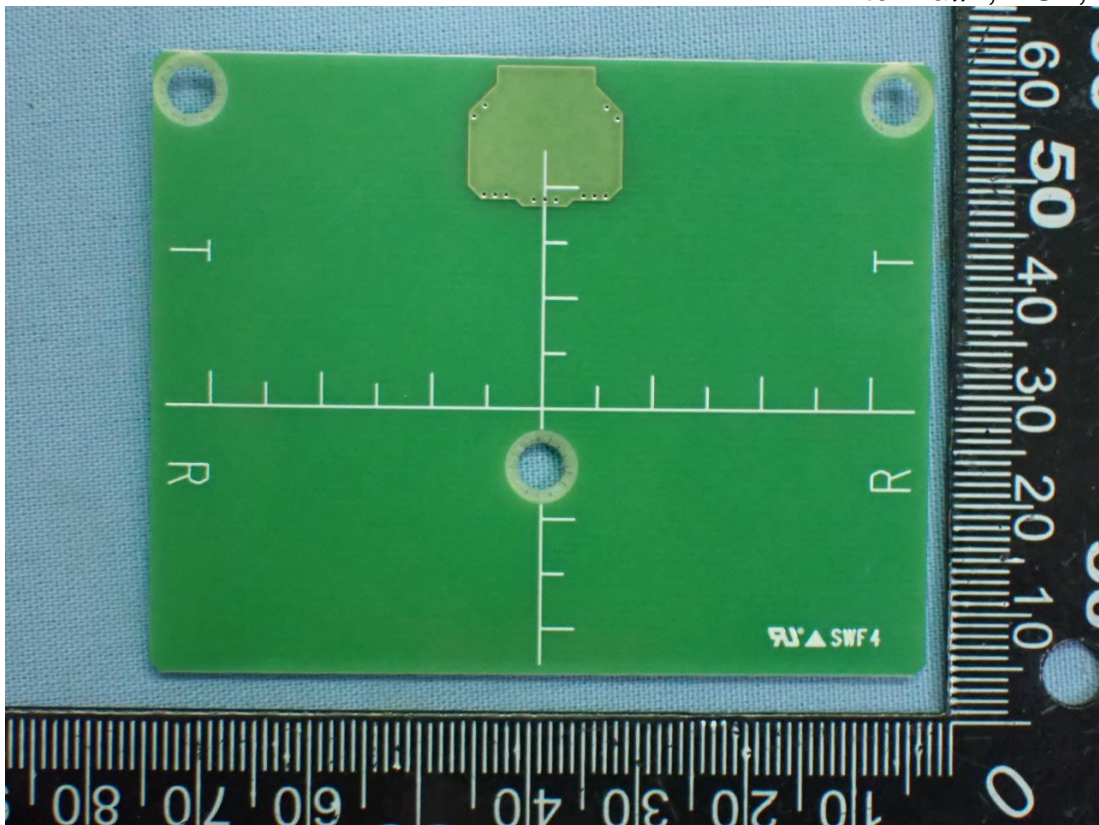

Figure 35
Antenna#1, PCB, Front View

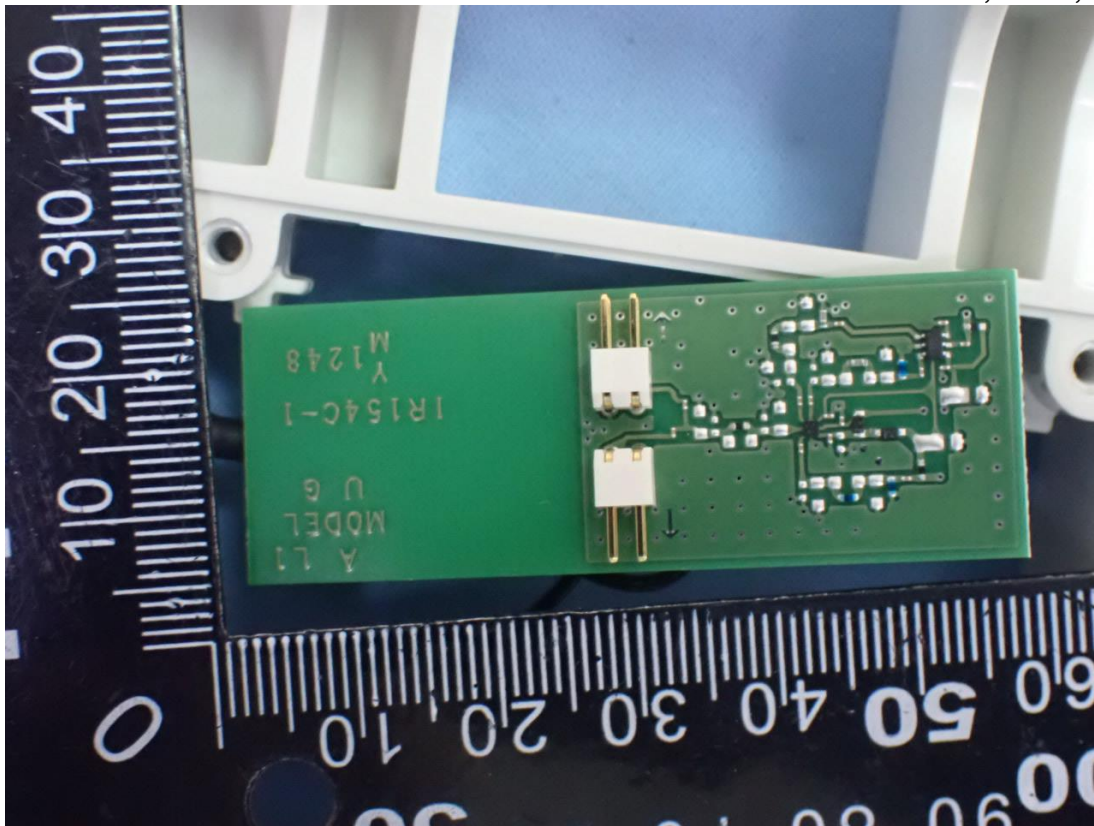

Figure 36
Antenna#1, PCB, Back View

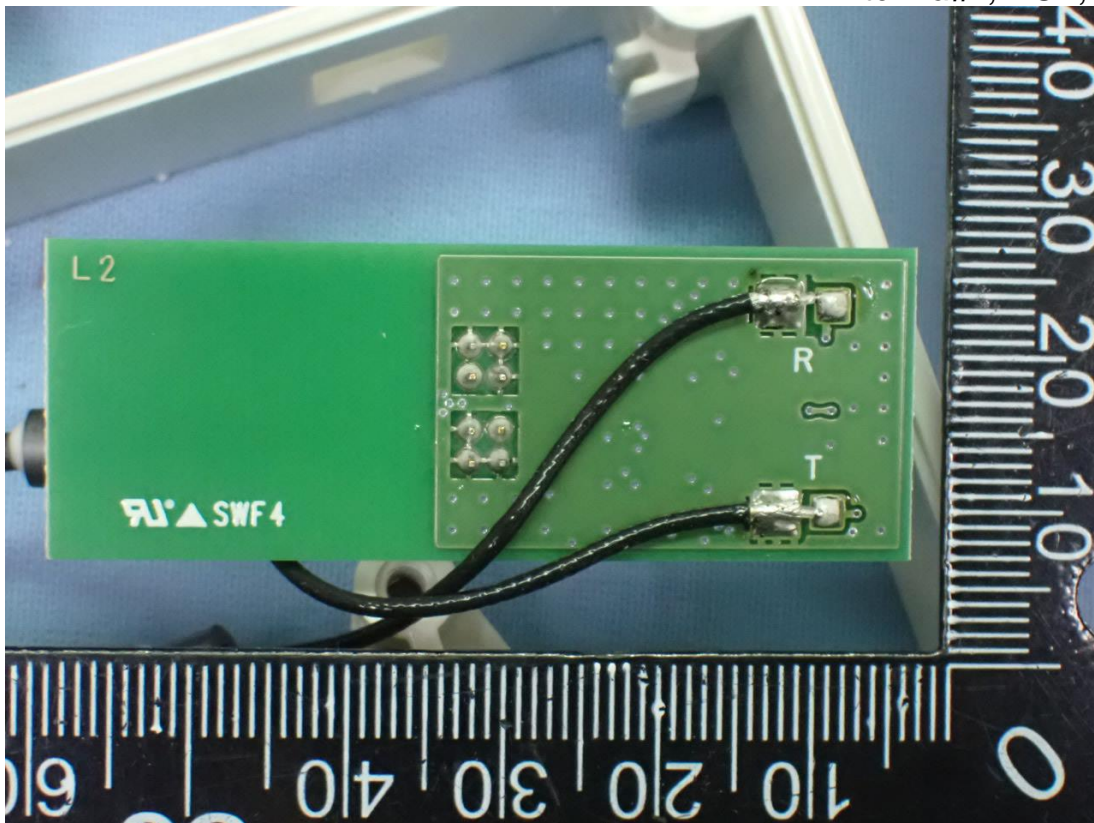

Figure 37
Antenna#2 (Internal View)

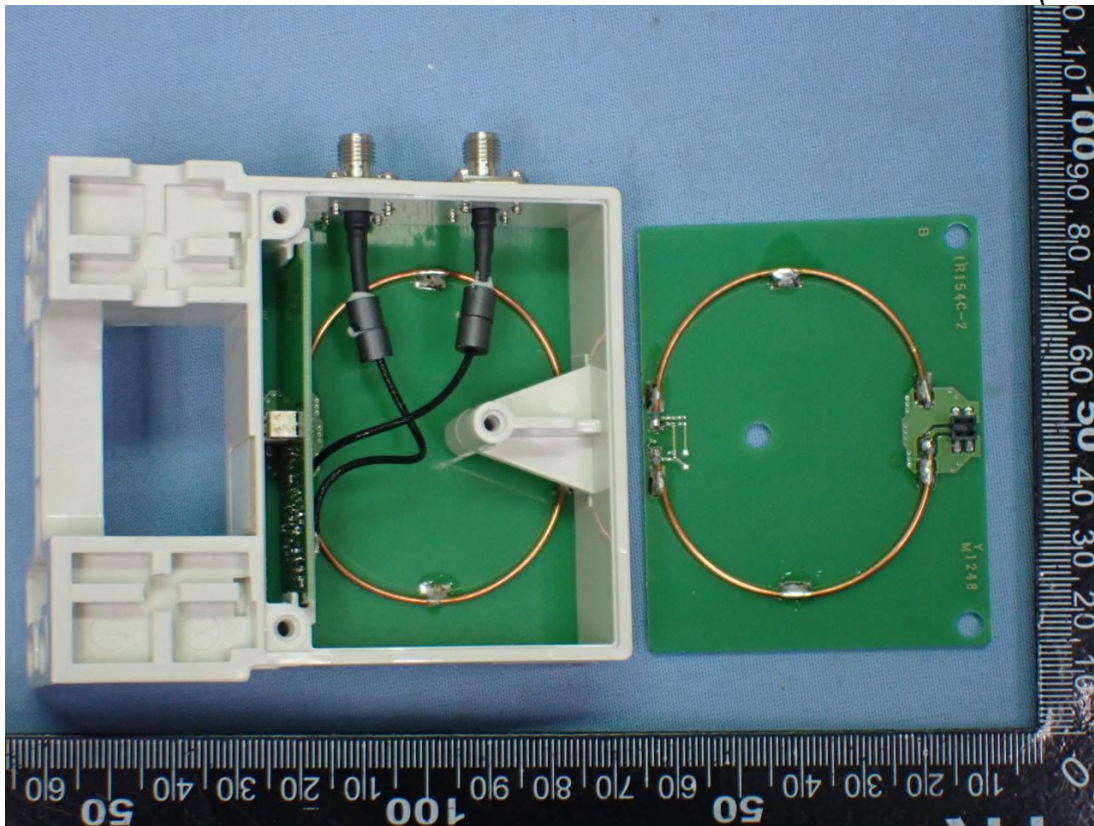

Figure 38
Antenna#2 (Internal View)

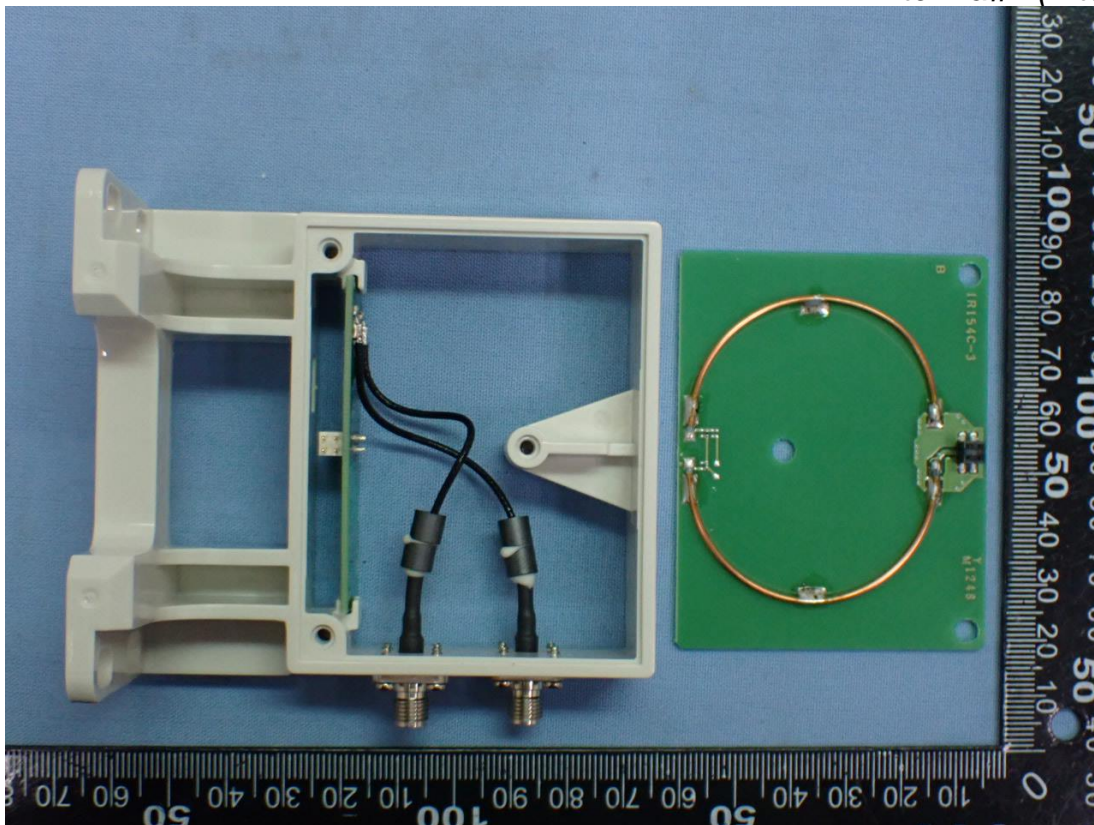

Figure 39
Antenna#2, PCB, Front View

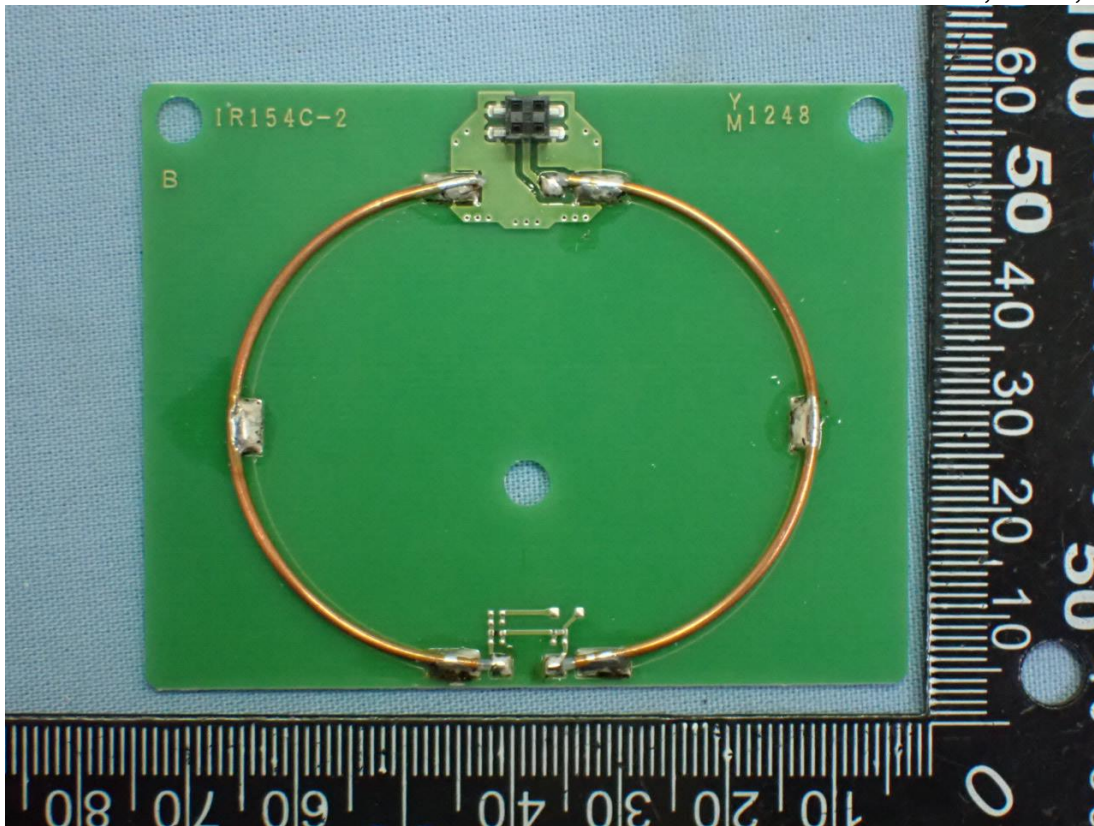

Figure 40
Antenna#2, PCB, Back View

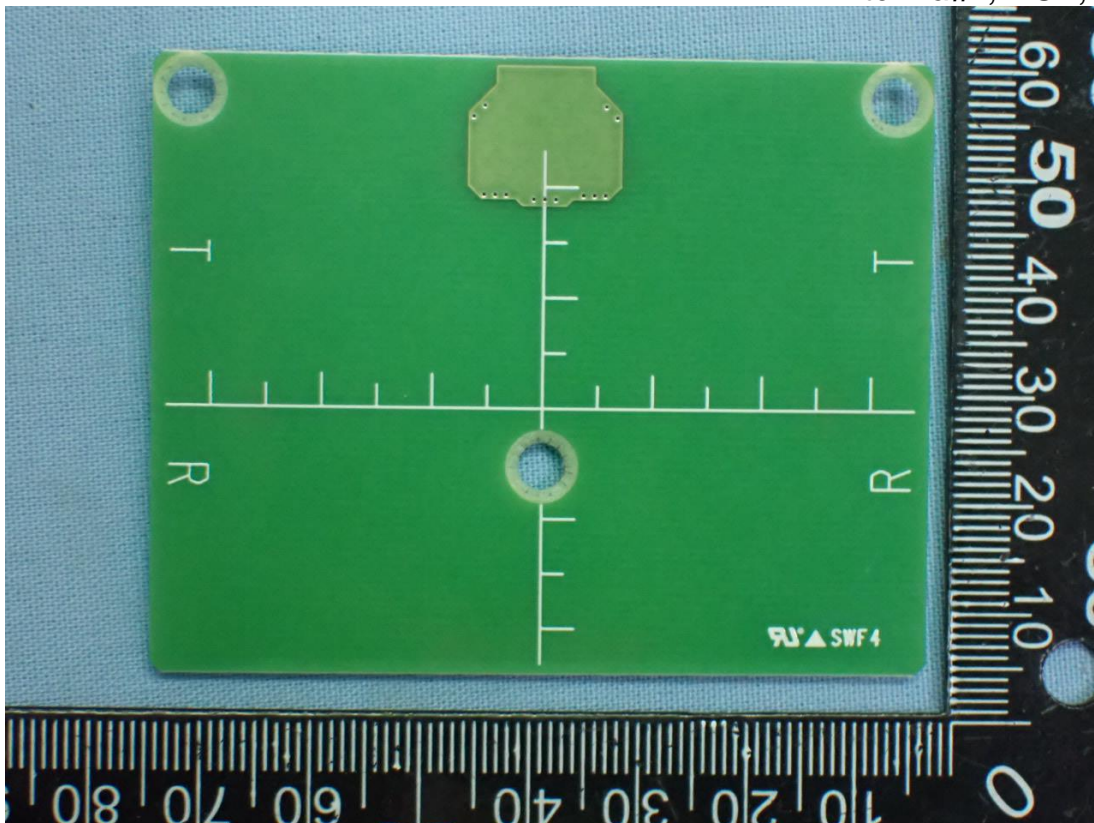

Figure 41
Antenna#2, PCB, Front View

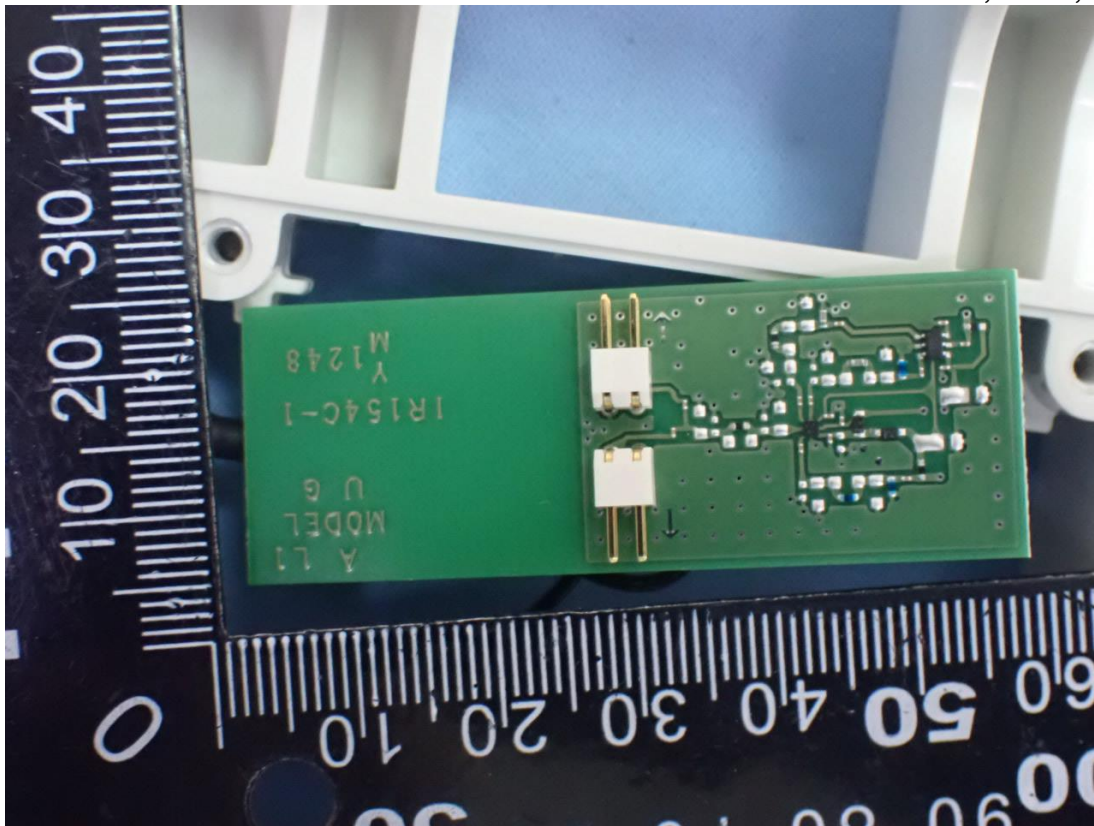

Figure 42
Antenna#2, PCB, Back View

