

APPENDIX 1: Photographs of EUT and SAR test setup

Appendix 1-1: Photograph of Platform (camera, model: DS126836) and antenna position

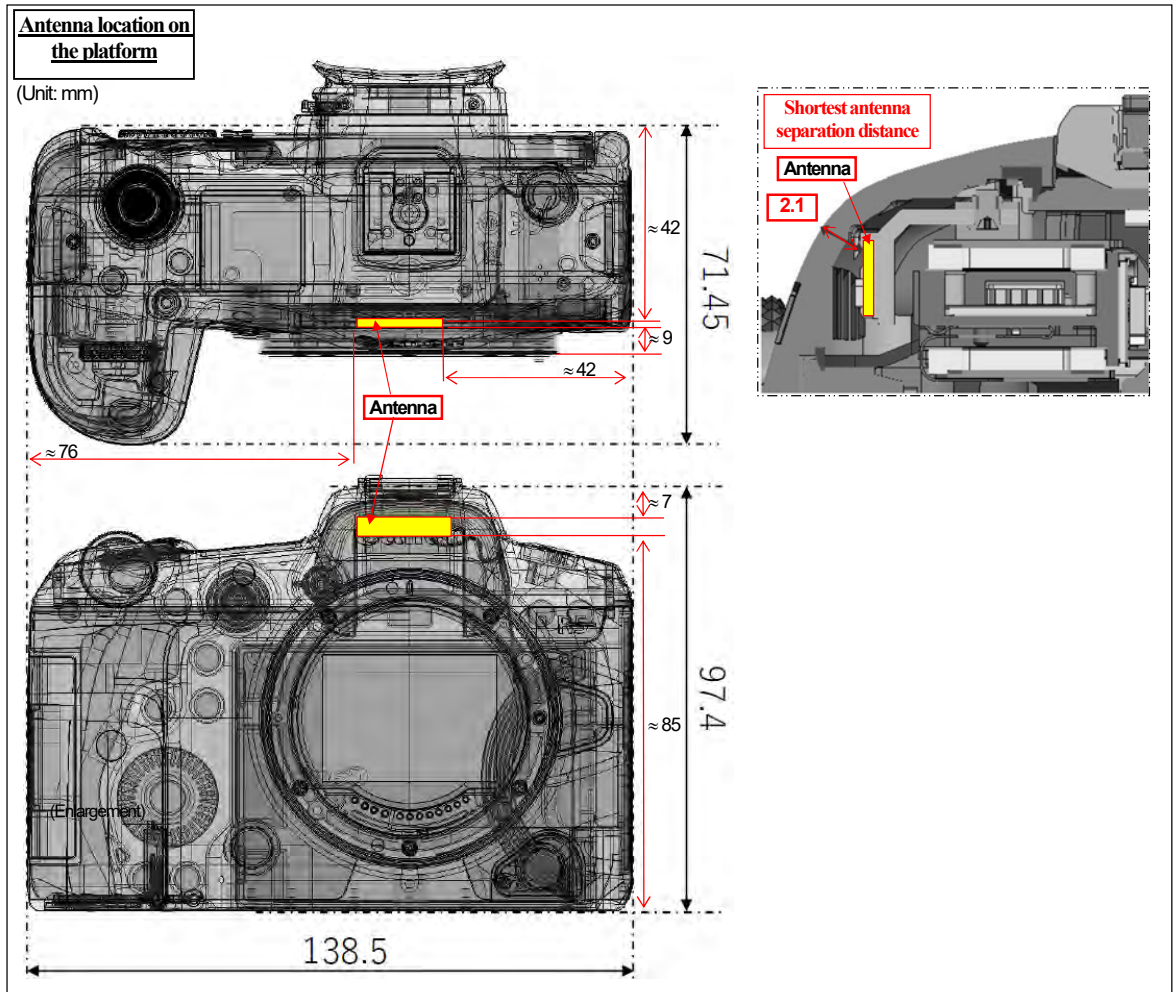

Appendix 1-2: EUT, Platform and support equipment

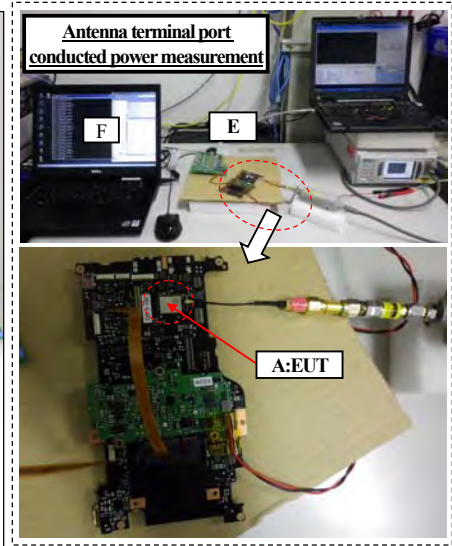
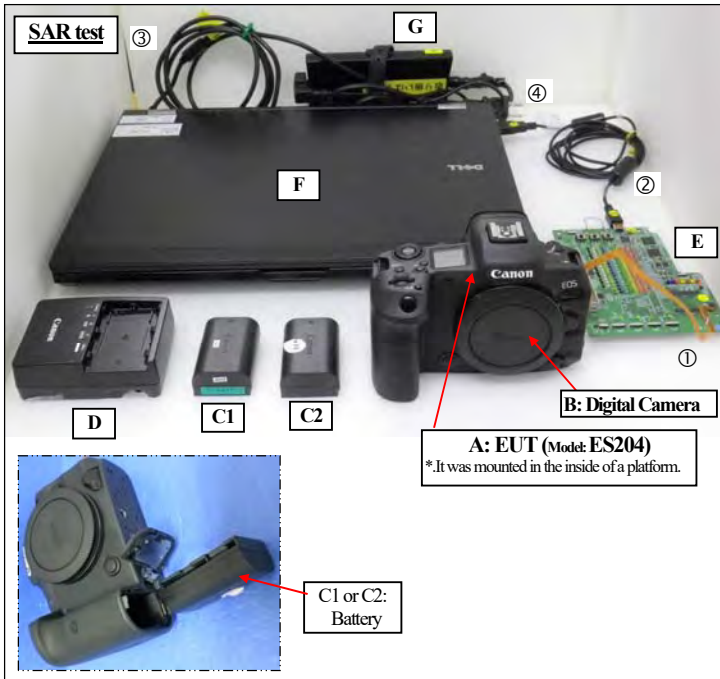

Description of EUT and Support Equipment







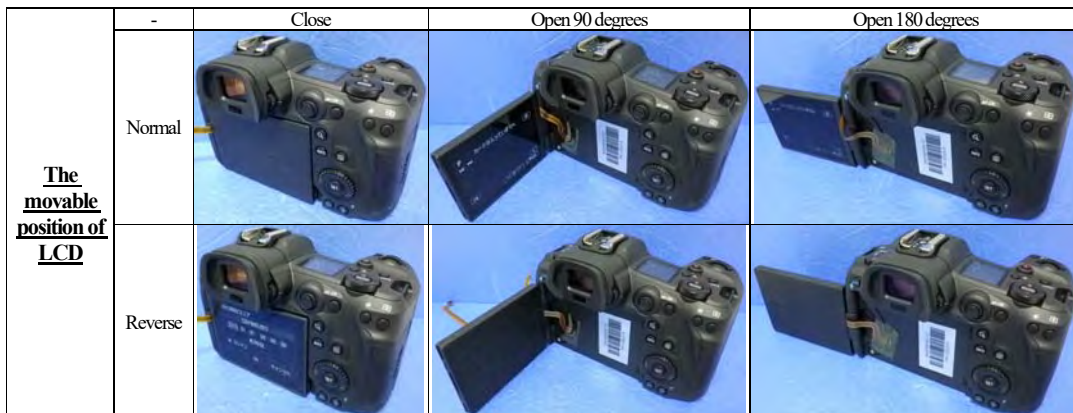







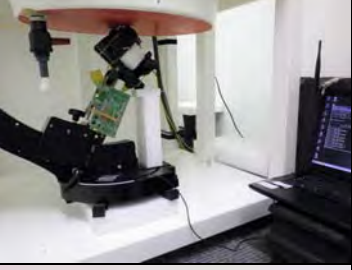

No.	Item	Model number	Serial number	Manufacturer	Remark
A	Wireless LAN /Bluetooth Combo Module	ES204	DE1-C-012	Canon Inc.	EUT
B	Digital Camera	DS126836	3	Canon Inc.	ES204's platform.
C1	Battery Pack (Li-ion)	LP-E6	#58	Canon Inc.	Accessory. Battery ID: #58
C2	DC 7.2 V, 1800 mAh, 13 Wh		#59		Accessory. Battery ID: #59
D	Battery Charger	LC-E6	#58	Canon Inc.	Support equipment.
E	Jig PCB	21-36MINI	#58	Canon Inc.	Support equipment.
F	Laptop PC (SPC-S03)	Latitude E6500	30326706285	DELL	Support equipment. (Host PC)
G	AC Adaptor	FA90PE0-00	-	DELL	Support equipment.

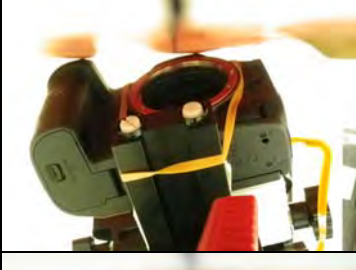
List of cables used

No.	Name	Length (m)	Shield	No.	Name	Length (m)	Shield
①	Ribbon flat cable	0.25	Unshielded	③	DC cable (AC adaptor) (PC)	1.7	Unshielded
②	USB cable (control no.: BC01)	1.9	Shielded	④	AC cable (AC adaptor) (PC)	0.9	Unshielded

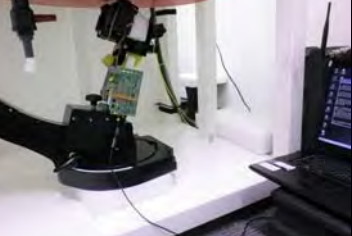

Appendix 1-3: Photograph of test setup

Position	Setup photographs (2.4 GHz band)		
Front-top-edge (Touch)			
			
Front-upper (Touch)			
			
Top-front (Touch)			
			

Appendix 1-3: Photograph of test setup (cont'd)

Position	Setup photographs (2.4 GHz band)		
Front (Lens) (Touch)			
			
Rear (LCD) (Touch)			

Appendix 1-3: Photograph of test setup (cont'd)

Position	Setup photographs (5 GHz band)		
Front-top-edge (Touch)			
Front-upper (Touch)			
Top-front (Touch)			

Appendix 1-3: Photograph of test setup (cont'd)

Position	Setup photographs (5 GHz band)		
Front (Lens) (Touch)			
			
Rear (LCD) (Touch)			