



# RADIO TEST REPORT

**Test Report No. : 12699044S-AJ-R1**

**Applicant** : Canon Inc  
**Type of Equipment** : Wireless module  
**Model No.** : ES203  
**FCC ID** : AZD240  
**Test regulation** : FCC Part 15 Subpart C: 2019  
**Test Result** : Complied (Refer to SECTION 3.2)

1. This test report shall not be reproduced in full or partial, without the written approval of UL Japan, Inc.
2. The results in this report apply only to the sample tested.
3. This sample tested is in compliance with the limits of the above regulation.
4. The test results in this test report are traceable to the national or international standards.
5. This test report must not be used by the customer to claim product certification, approval, or endorsement by any agency of the Federal Government.
6. This test report covers Radio technical requirements.  
It does not cover administrative issues such as Manual or non-Radio test related Requirements. (if applicable)
7. The all test items in this test report are conducted by UL Japan, Inc. Shonan EMC Lab.
8. The opinions and the interpretations to the result of the description in this report are outside scopes where UL Japan has been accredited.
9. The information provided from the customer for this report is identified in SECTION 1.
10. This report is a revised version of 12699044S-AJ. 12699044S-AJ is replaced with this report.

**Date of test:** February 9 to June 3, 2019

**Representative test engineer:** *H. Sato*  
Hiromasa Sato  
Engineer  
Consumer Technology Division

**Approved by:** *T. Amamura*  
Toyokazu Imamura  
Leader  
Consumer Technology Division



CERTIFICATE 1266.03

- The testing in which "Non-accreditation" is displayed is outside the accreditation scopes in UL Japan.  
 There is no testing item of "Non-accreditation".

**UL Japan, Inc.**  
**Shonan EMC Lab.**

1-22-3 Megumigaoka, Hiratsuka-shi, Kanagawa-ken, 259-1220 JAPAN  
Telephone : +81 463 50 6400  
Facsimile : +81 463 50 6401

# REVISION HISTORY

**Original Test Report No.: 12699044S-AJ**

Revision	Test report No.	Date	Page revised	Contents
- (Original)	12699044S-AJ	September 6, 2019	-	-
1	12699044S-AJ-R1	October 21, 2019	8	Correction of description: The EUT has a unique coupling/antenna connector (MS-180 and U.FL). Therefore the equipment complies with the requirement of 15.203. ↓ For antenna A: The antenna is not removable from the EUT. Therefore, the equipment complies with the antenna requirement of Section 15.203. For antenna B: The EUT has a unique coupling/antenna connector (U.FL). Therefore the equipment complies with the requirement of 15.203.
			15	Correction of test distance: 0.01 m → 3.99 m
			25 - 27	Modification of data and sample calculation of CDD, by considering Directional Gain Correction of data: Using Antenna gain → Directional gain
			36 - 37	Addition of remarks on the data: “Duty > 98 %”
			38 - 56	Adjustment of decimal places to limit of the RE data: two decimal places → one decimal places

## Reference: Abbreviations (Including words undescribed in this report)

A2LA	The American Association for Laboratory Accreditation	NS	No signal detect.
AC	Alternating Current	NSA	Normalized Site Attenuation
AFH	Adaptive Frequency Hopping	NVLAP	National Voluntary Laboratory Accreditation Program
AM	Amplitude Modulation	OBW	Occupied Band Width
Amp, AMP	Amplifier	OFDM	Orthogonal Frequency Division Multiplexing
ANSI	American National Standards Institute	P/M	Power meter
Ant, ANT	Antenna	PCB	Printed Circuit Board
AP	Access Point	PER	Packet Error Rate
Atten., ATT	Attenuator	PHY	Physical Layer
AV	Average	PK	Peak
BPSK	Binary Phase-Shift Keying	PN	Pseudo random Noise
BR	Bluetooth Basic Rate	PRBS	Pseudo-Random Bit Sequence
BT	Bluetooth	PSD	Power Spectral Density
BT LE	Bluetooth Low Energy	QAM	Quadrature Amplitude Modulation
BW	BandWidth	QP	Quasi-Peak
Cal Int	Calibration Interval	QPSK	Quadri-Phase Shift Keying
CCK	Complementary Code Keying	RBW	Resolution Band Width
Ch., CH	Channel	RDS	Radio Data System
CISPR	Comite International Special des Perturbations Radioelectriques	RE	Radio Equipment
CW	Continuous Wave	RF	Radio Frequency
DBPSK	Differential BPSK	RMS	Root Mean Square
DC	Direct Current	RSS	Radio Standards Specifications
DFS	Dynamic Frequency Selection	Rx	Receiving
DQPSK	Differential QPSK	SA, S/A	Spectrum Analyzer
DSSS	Direct Sequence Spread Spectrum	SG	Signal Generator
EDR	Enhanced Data Rate	SVSWR	Site-Voltage Standing Wave Ratio
EIRP, e.i.r.p.	Equivalent Isotropically Radiated Power	TR	Test Receiver
EMC	ElectroMagnetic Compatibility	Tx	Transmitting
EMI	ElectroMagnetic Interference	VBW	Video BandWidth
EN	European Norm	Vert.	Vertical
ERP, e.r.p.	Effective Radiated Power	WLAN	Wireless LAN
EU	European Union		
EUT	Equipment Under Test		
Fac.	Factor		
FCC	Federal Communications Commission		
FHSS	Frequency Hopping Spread Spectrum		
FM	Frequency Modulation		
Freq.	Frequency		
GFSK	Gaussian Frequency-Shift Keying		
GNSS	Global Navigation Satellite System		
GPS	Global Positioning System		
Hori.	Horizontal		
ICES	Interference-Causing Equipment Standard		
IEC	International Electrotechnical Commission		
IEEE	Institute of Electrical and Electronics Engineers		
IF	Intermediate Frequency		
ILAC	International Laboratory Accreditation Conference		
ISED	Innovation, Science and Economic Development Canada		
ISO	International Organization for Standardization		
JAB	Japan Accreditation Board		
LAN	Local Area Network		
LIMS	Laboratory Information Management System		
MCS	Modulation and Coding Scheme		
MRA	Mutual Recognition Arrangement		
NIST	National Institute of Standards and Technology		

<b>CONTENTS</b>	<b>PAGE</b>
<b>SECTION 1: Customer information.....</b>	<b>5</b>
<b>SECTION 2: Equipment under test (E.U.T.).....</b>	<b>5</b>
<b>SECTION 3: Test specification, procedures &amp; results.....</b>	<b>7</b>
<b>SECTION 4: Operation of E.U.T. during testing.....</b>	<b>11</b>
<b>SECTION 5: Conducted Emission.....</b>	<b>13</b>
<b>SECTION 6: Radiated Spurious Emission .....</b>	<b>14</b>
<b>SECTION 7: Antenna Terminal Conducted Tests.....</b>	<b>16</b>
<b>APPENDIX 1: Test data .....</b>	<b>17</b>
6 dB Bandwidth and 99 % Occupied Bandwidth.....	18
Maximum Peak Output Power .....	25
Radiated Spurious Emission .....	38
Conducted Spurious Emission .....	59
Power Density .....	60
<b>APPENDIX 2: Test instruments .....</b>	<b>72</b>
<b>APPENDIX 3: Photographs of test setup .....</b>	<b>75</b>
Conducted Emission .....	75
Radiated Spurious Emission .....	76
Pre-check of the Worst Case Position.....	77

## **SECTION 1: Customer information**

Company Name : Canon Inc  
Address : 30-2, Shimomaruko 3-chome, Ohta-ku, Tokyo 146-8501 Japan  
Telephone Number : +81-3-3757-6798  
Facsimile Number : +81-3-5482-4053  
Contact Person : Tomohiro Suzuki

The information provided from the customer is as follows;

- Applicant, Type of Equipment, Model No., FCC ID on the cover and other relevant pages
  - Operating/Test Mode(s) (Mode(s)) on all the relevant pages
  - SECTION 1: Customer information
  - SECTION 2: Equipment under test (E.U.T.)
  - SECTION 4: Operation of E.U.T. during testing
- \* The laboratory is exempted from liability of any test results affected from the above information in SECTION 2 and 4.

## **SECTION 2: Equipment under test (E.U.T.)**

### **2.1 Identification of E.U.T.**

Type of Equipment : Wireless module  
Model No. : ES203  
Serial No. : Refer to SECTION 4, SECTION 4.2  
Rating : DC 3.3 V  
Receipt Date of Sample : January 25, 2019  
(Information from test lab.)  
Country of Mass-production : China, Japan  
Condition of EUT : Engineering prototype  
(Not for Sale: This sample is equivalent to mass-produced items.)  
Modification of EUT : No Modification by the test lab

### **2.2 Product Description**

Model: ES203 (referred to as the EUT in this report) is a Wireless module.

## Radio Specification

WLAN module : ES203  
Radio Type : Transceiver  
Clock frequency (Maximum) : 40 MHz

### WLAN

	IEEE802.11b	IEEE802.11g	IEEE802.11n (20 MHz band)	IEEE802.11n (40 MHz band)
Frequency of operation	2412 MHz - 2462 MHz	2412 MHz - 2462 MHz	2412 MHz - 2462 MHz 5180 MHz - 5240 MHz 5260 MHz - 5320 MHz 5500 MHz - 5700 MHz 5745 MHz - 5825 MHz	2422 MHz - 2452 MHz 5190 MHz - 5230 MHz 5270 MHz - 5310 MHz 5510 MHz - 5670 MHz 5755 MHz - 5795 MHz
Channel spacing	5 MHz		2.4 GHz band 5 MHz 5 GHz band 20 MHz	2.4 GHz band 5 MHz 5 GHz band 40 MHz
Modulation	DSSS: DBPSK, DQPSK, CCK		OFDM: BPSK, QPSK, 16QAM, 64QAM	
	IEEE802.11a	IEEE802.11ac (20 MHz band)	IEEE802.11ac (40 MHz band)	IEEE802.11ac (80 MHz band)
Frequency of operation	5180 MHz - 5240 MHz 5260 MHz - 5320 MHz 5500 MHz - 5700 MHz 5745 MHz - 5825 MHz	5180 MHz - 5240 MHz 5260 MHz - 5320 MHz 5500 MHz - 5700 MHz 5745 MHz - 5825 MHz	5190 MHz - 5230 MHz 5270 MHz - 5310 MHz 5510 MHz - 5670 MHz 5755 MHz - 5795 MHz	5210 MHz 5290 MHz 5530 MHz - 5610 MHz 5775 MHz
Channel spacing	20 MHz	20 MHz	40 MHz	80 MHz
Modulation	OFDM: BPSK, QPSK, 16QAM, 64QAM, 256QAM (*256QAM is only for IEEE802.11ac 80 MHz band)			

Antenna	Antenna A	Antenna B
Antenna quantity	2 pcs. (*. Separation distance between the antenna A and the antenna B: ~5 mm) *. The single antenna transmitting mode could not be allowed.	
Antenna type / connector type	Invert-L Pattern antenna / Printed on the PCB.	Invert-L Flexible printed circuit (FPC) antenna / PCB side: U.FL, Antenna side: soldered
Antenna gain	-1.77 dBi (2.4GHz band), 1.52 dBi (U-NII-1 band), 1.78 dBi (U-NII-2A band), 2.04 dBi (U-NII-2C band), 2.26 dBi (U-NII-3 band), (*.including cable loss)	-3.92 dBi (2.4GHz band), 1.39 dBi (U-NII-1 band), 1.59 dBi (U-NII-2A band), 0.79 dBi (U-NII-2C band), 1.42 dBi (U-NII-3 band), (*.including cable loss)

### **SECTION 3: Test specification, procedures & results**

#### **3.1 Test Specification**

Test Specification : FCC Part 15 Subpart C  
FCC Part 15 final revised on July 19, 2019 and effective August 19, 2019 except 15.258

\* The revisions made after testing date do not affect the test specification applied to the EUT.

Title : FCC 47CFR Part15 Radio Frequency Device Subpart C Intentional Radiators  
Section 15.207 Conducted limits  
Section 15.247 Operation within the bands 902-928MHz,  
2400-2483.5MHz, and 5725-5850MHz

### 3.2 Procedures and results

Item	Test Procedure	Specification	Worst margin	Results	Remarks
Conducted Emission	FCC: ANSI C63.10-2013 6. Standard test methods ----- IC: RSS-Gen 8.8	FCC: Section 15.207 ----- IC: RSS-Gen 8.8	16.3 dB, 4.94196 MHz, N, AV	Complied a)	-
6dB Bandwidth	FCC: KDB 558074 D01 15.247 Meas Guidance v05 ----- IC: -	FCC: Section 15.247(a)(2) ----- IC: RSS-247 5.2(a)	See data.	Complied b)	Conducted
Maximum Peak Output Power	FCC: KDB 558074 D01 15.247 Meas Guidance v05 ----- IC: RSS-Gen 6.12	FCC: Section 15.247(b)(3) ----- IC: RSS-247 5.4(d)		Complied c)	Conducted
Power Density	FCC: KDB 558074 D01 15.247 Meas Guidance v05 ----- IC: -	FCC: Section 15.247(e) ----- IC: RSS-247 5.2(b)		Complied d)	Conducted
Spurious Emission Restricted Band Edges	FCC: KDB 558074 D01 15.247 Meas Guidance v05 ----- IC: RSS-Gen 6.13	FCC: Section 15.247(d) ----- IC: RSS-247 5.5 RSS-Gen 8.9 RSS-Gen 8.10		2.6 dB 9748.000 MHz, AV, Hori. Tx 11g 2437 MHz	Complied# e), f)

Note: UL Japan, Inc.'s EMI Work Procedures No. 13-EM-W0420 and 13-EM-W0422.

\*1) Radiated test was selected over 30 MHz based on section 15.247(d) and KDB 558074 D01 15.247 Meas Guidance v05 8.5 and 8.6.

- a) Refer to APPENDIX 1 (data of Conducted Emission)
- b) Refer to APPENDIX 1 (data of 6 dB Bandwidth and 99 % Occupied Bandwidth)
- c) Refer to APPENDIX 1 (data of Maximum Peak Output Power)
- d) Refer to APPENDIX 1 (data of Power Density)
- e) Refer to APPENDIX 1 (data of Conducted Spurious Emission)
- f) Refer to APPENDIX 1 (data of Radiated Spurious Emission)

Symbols:

Complied The data of this test item has enough margin, more than the measurement uncertainty.

Complied# The data of this test item meets the limits unless the measurement uncertainty is taken into consideration.

\* In case any questions arise about test procedure, ANSI C63.10: 2013 is also referred.

#### **FCC Part 15.31 (e)**

The RF Module has its own regulator. The RF Module is constantly provided voltage through the regulator regardless of input voltage. Therefore, this EUT complies with the requirement.

#### **FCC Part 15.203/212 Antenna requirement**

For antenna A: The antenna is not removable from the EUT. Therefore, the equipment complies with the antenna requirement of Section 15.203.

For antenna B: The EUT has a unique coupling/antenna connector (U.FL). Therefore the equipment complies with the requirement of 15.203.

**UL Japan, Inc.**

**Shonan EMC Lab.**

1-22-3 Megumigaoka, Hiratsuka-shi, Kanagawa-ken, 259-1220 JAPAN

Telephone : +81 463 50 6400

Facsimile : +81 463 50 6401



### 3.3 Addition to standard

Item	Test Procedure	Specification	Worst margin	Results	Remarks
99% Occupied Bandwidth	RSS-Gen 6.7	IC: -	N/A	- a)	Conducted

Note: UL Japan, Inc.'s EMI Work Procedures No. 13-EM-W0420 and 13-EM-W0422.

\*1) Radiated test was selected over 30 MHz based on section 15.247(d) and KDB 558074 D01 15.247 Meas Guidance v05 8.5 and 8.6.

a) Refer to APPENDIX 1 (data of 6 dB Bandwidth and 99 % Occupied Bandwidth)

Symbols:

Complied The data of this test item has enough margin, more than the measurement uncertainty.

Complied# The data of this test item meets the limits unless the measurement uncertainty is taken into consideration.

Other than above, no addition, exclusion nor deviation has been made from the standard.

### 3.4 Uncertainty

#### EMI

There is no applicable rule of uncertainty in this applied standard. Therefore, the following results are derived depending on whether or not laboratory uncertainty is applied.

The following uncertainties have been calculated to provide a confidence level of 95 % using a coverage factor  $k=2$ .

Shonan EMC Lab.

Item	Frequency range	Uncertainty (+/-)			
		No. 1 SAC / SR	No. 2 SAC / SR	No. 3 SAC / SR	No. 4 SAC / SR
Conducted emission (AC Mains) LISN	150 kHz-30 MHz	2.9 dB	2.8 dB	2.9 dB	2.9 dB
Radiated emission (Measurement distance: 3 m)	9 kHz-30 MHz	3.0 dB	3.0 dB	3.1 dB	-
	30 MHz-200 MHz	4.6 dB	4.6 dB	4.7 dB	-
	200 MHz-1 GHz	6.0 dB	6.0 dB	6.1 dB	-
	1 GHz-6 GHz	4.8 dB	4.8 dB	4.8 dB	-
	6 GHz-18 GHz	5.4 dB	5.4 dB	5.4 dB	-
Radiated emission (Measurement distance: 1 m)	18 GHz-40 GHz	5.6 dB	5.6 dB	5.6 dB	-
	1 GHz-18 GHz	5.7 dB	5.7 dB	5.7 dB	-
	18 GHz-40 GHz	5.9 dB	5.9 dB	5.9 dB	-

SAC=Semi-Anechoic Chamber

SR= Shielded Room is applied besides radiated emission

Antenna terminal test	Uncertainty (+/-)
Power Measurement above 1 GHz (Average Detector)_SPM-06	0.81 dB
Power Measurement above 1 GHz (Peak Detector)_SPM-06	1.53 dB
Power Measurement above 1 GHz (Average Detector)_SPM-07	0.95 dB
Power Measurement above 1 GHz (Peak Detector)_SPM-07	1.21 dB
Power Measurement above 1 GHz (Average Detector)_SPM-13	0.90 dB
Power Measurement above 1 GHz (Peak Detector)_SPM-13	1.04 dB
Spurious emission (Conducted) below 1GHz	1.8 dB
Spurious emission (Conducted) 1 GHz-3 GHz	1.7 dB
Spurious emission (Conducted) 3 GHz-18 GHz	2.3 dB
Spurious emission (Conducted) 18 GHz-26.5 GHz	2.4 dB
Spurious emission (Conducted) 26.5 GHz-40 GHz	2.4 dB
Bandwidth Measurement	0.61 %
Duty cycle and Time Measurement	0.012 %

**UL Japan, Inc.**

**Shonan EMC Lab.**

1-22-3 Megumigaoka, Hiratsuka-shi, Kanagawa-ken, 259-1220 JAPAN

Telephone : +81 463 50 6400

Facsimile : +81 463 50 6401

### 3.5 Test Location

UL Japan, Inc. Shonan EMC Lab.

1-22-3, Megumigaoka, Hiratsuka-shi, Kanagawa-ken 259-1220 JAPAN

Telephone: +81 463 50 6400, Facsimile: +81 463 50 6401

A2LA Certificate Number: 1266.03 (FCC Test Firm Registration Number: 626366, ISED Lab Company Number: 2973D)

Test site	Width x Depth x Height (m)	Size of reference ground plane (m) / horizontal conducting plane	Maximum measurement distance
No.1 Semi-anechoic chamber	20.6 x 11.3 x 7.65	20.6 x 11.3	10 m
No.2 Semi-anechoic chamber	20.6 x 11.3 x 7.65	20.6 x 11.3	10 m
No.3 Semi-anechoic chamber	12.7 x 7.7 x 5.35	12.7 x 7.7	5 m
No.4 Semi-anechoic chamber	8.1 x 5.1 x 3.55	8.1 x 5.1	-
No.1 Shielded room	6.8 x 4.1 x 2.7	6.8 x 4.1	-
No.2 Shielded room	6.8 x 4.1 x 2.7	6.8 x 4.1	-
No.3 Shielded room	6.3 x 4.7 x 2.7	6.3 x 4.7	-
No.4 Shielded room	4.4 x 4.7 x 2.7	4.4 x 4.7	-
No.5 Shielded room	7.8 x 6.4 x 2.7	7.8 x 6.4	-
No.6 Shielded room	7.8 x 6.4 x 2.7	7.8 x 6.4	-
No.8 shielded room	3.45 x 5.5 x 2.4	3.45 x 5.5	-
No.1 Measurement room	2.55 x 4.1 x 2.5	-	-

### 3.6 Test data, Test instruments, and Test set up

Refer to APPENDIX.

---

**UL Japan, Inc.**

**Shonan EMC Lab.**

1-22-3 Megumigaoka, Hiratsuka-shi, Kanagawa-ken, 259-1220 JAPAN

Telephone : +81 463 50 6400

Facsimile : +81 463 50 6401

## **SECTION 4: Operation of E.U.T. during testing**

### **4.1 Operating Mode(s)**

Test operating mode was determined as follows according to “Section 1 of 6 802.11 a/b/g/n testing - Managing Complex Regulatory Approvals - ” of TCB Council Workshop October 2009.

<b>Mode</b>	<b>Remarks*</b>
IEEE 802.11b (11b)	11 Mbps, PN9
IEEE 802.11g (11g)	48 Mbps, PN9
IEEE 802.11n 20 MHz BW CDD (11n-20 CDD)	MCS 2, PN9
IEEE 802.11n 20 MHz BW MIMO (11n-20 MIMO)	MCS 14, PN9
IEEE 802.11n 40 MHz BW CDD (11n-40 CDD)	MCS 0, PN9
IEEE 802.11n 40 MHz BW MIMO (11n-40 MIMO)	MCS 9, PN9
*The worst condition was determined based on the test result of Maximum Peak Output Power (Mid Channel)	
*Power of the EUT was set by the software as follows; Power settings: 7 dBm Software: Tera Term, Version 4.87 Any conditions under the normal use do not exceed the condition of setting. In addition, end users cannot change the settings of the output power of the product.	

\*The details of Operating mode(s)

<b>Test Item</b>	<b>Operating Mode</b>	<b>Tested Antenna</b>	<b>Tested frequency</b>
Conducted Emission	11n-20 MIMO Tx	A + B	2412 MHz
Spurious Emission	11b Tx 11g Tx	A + B	2412 MHz 2437 MHz 2462 MHz
	11n-20 MIMO Tx *1)	A + B	2412 MHz 2437 MHz 2462 MHz
	11n-40 MIMO Tx *1)	A + B	2422 MHz 2437 MHz 2452 MHz
6 dB Bandwidth 99 % Occupied Bandwidth	11b Tx 11g Tx 11n-20 CDD Tx 11n-20 MIMO Tx	B	2412 MHz 2437 MHz 2462 MHz
	11n-40 CDD Tx 11n-40 MIMO Tx	B	2422 MHz 2437 MHz 2452 MHz
Maximum Peak Output Power Power Density	11b Tx 11g Tx 11n-20 CDD Tx 11n-20 MIMO Tx	A + B	2412 MHz 2437 MHz 2462 MHz
	11n-40 CDD Tx 11n-40 MIMO Tx	A + B	2422 MHz 2437 MHz 2452 MHz

\*1) The test was performed with MIMO as a representative mode.

**UL Japan, Inc.**

**Shonan EMC Lab.**

1-22-3 Megumigaoka, Hiratsuka-shi, Kanagawa-ken, 259-1220 JAPAN

Telephone : +81 463 50 6400

Facsimile : +81 463 50 6401

## 4.2 Configuration and peripherals

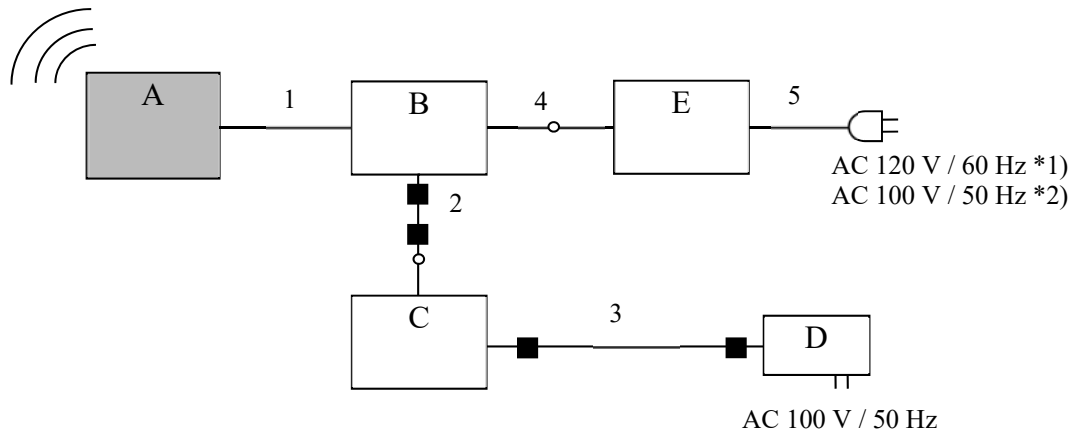

■ : Standard Ferrite Core

\*1) For Conducted emission test

\*2) For Antenna Terminal conducted test and Radiated emission test

\* Cabling and setup(s) were taken into consideration and test data was taken under worse case conditions.

### Description of EUT and Support equipment

No.	Item	Model number	Serial number	Manufacturer	Remark
A	Wireless module	ES203	1 *3) 9 *4)	Canon	EUT
B	Jig Board	W-USB-JIG	-	-	-
C	Jig Board	-	-	-	-
D	AC Adaptor	AD-A60P228	-	XIAMEN UME ELECTRONIC Co.Ltd	-
E	DC Power Supply	PAN60-10A	002383	KIKUSUI	-

\*3) Used for Radiated Emission tests

\*4) Used for Antenna Terminal Conducted tests

### List of cables used

No.	Name	Length (m)	Shield		Remark
			Cable	Connector	
1	Signal	0.1	Unshielded	Unshielded	-
2	USB	1.4 + 2.0	Shielded	Shielded	-
3	DC	1.4	Unshielded	Unshielded	-
4	DC	1.0 + 1.5	Unshielded	Unshielded	-
5	AC	3.0	Unshielded	Unshielded	-

**UL Japan, Inc.**

**Shonan EMC Lab.**

1-22-3 Megumigaoka, Hiratsuka-shi, Kanagawa-ken, 259-1220 JAPAN

Telephone : +81 463 50 6400

Facsimile : +81 463 50 6401

## **SECTION 5: Conducted Emission**

### **Test Procedure and conditions**

EUT was placed on a urethane platform of nominal size, 1.0 m by 1.5 m, raised 0.8 m above the conducting ground plane.

The rear of tabletop was located 40 cm to the vertical conducting plane. The rear of EUT, including peripherals aligned and flushed with rear of tabletop. All other surfaces of tabletop were at least 80cm from any other grounded conducting surface. EUT was located 80 cm from a Line Impedance Stabilization Network (LISN) / Artificial mains Network (AMN) and excess AC cable was bundled in center.

#### 1) For the tests on EUT with other peripherals (as a whole system)

I/O cables that were connected to the peripherals were bundled in center. They were folded back and forth forming a bundle 30 cm to 40 cm long and were hanged at a 40 cm height to the ground plane. All unused 50ohm connectors of the LISN (AMN) were resistivity terminated in 50 ohm when not connected to the measuring equipment.

The AC Mains Terminal Continuous disturbance Voltage has been measured with the EUT in a Shielded room.

The EUT was connected to a LISN (AMN).

An overview sweep with peak detection has been performed.

The test results and limit are rounded off to one decimal place, so some differences might be observed.

<b>Detector</b>	<b>: QP and CISPR AV</b>
<b>Measurement range</b>	<b>: 0.15 MHz - 30 MHz</b>
<b>Test data</b>	<b>: APPENDIX</b>
<b>Test result</b>	<b>: Pass</b>

**Figure 1: Test Setup**

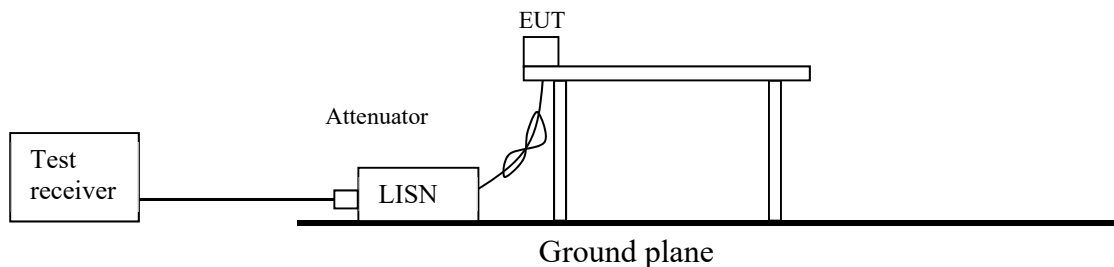

## **SECTION 6: Radiated Spurious Emission**

### **Test Procedure**

It was measured based on "8.5 and 8.6 of KDB 558074 D01 15.247 Meas Guidance v05".

[For below 1 GHz]

EUT was placed on a urethane platform of nominal size, 1.0 m by 2.0 m, raised 0.8 m above the conducting ground plane. The Radiated Electric Field Strength has been measured in a Semi Anechoic Chamber with a ground plane.

[For above 1 GHz]

EUT was placed on a urethane platform of nominal size, 0.5 m by 0.5 m, raised 1.5 m above the conducting ground plane.

The Radiated Electric Field Strength has been measured in a Semi Anechoic Chamber with absorbent materials lined on a ground plane.

The height of the measuring antenna varied between 1 and 4 m and EUT was rotated a full revolution in order to obtain the maximum value of the electric field strength.

Test antenna was aimed at the EUT for receiving the maximum signal and always kept within the illumination area of the 3 dB beamwidth of the antenna.

The measurements were performed for both vertical and horizontal antenna polarization with the Test Receiver, or the Spectrum Analyzer.

The measurements were made with the following detector function of the test receiver and the Spectrum analyzer (in linear mode).

The test was made with the detector (RBW/VBW) in the following table.

When using Spectrum analyzer, the test was made with adjusting span to zero by using peak hold.

#### **Test Antennas are used as below;**

Frequency	30 MHz to 200 MHz	200 MHz to 1 GHz	Above 1 GHz
Antenna Type	Biconical	Logperiodic	Horn

In any 100 kHz bandwidth outside the restricted band in which the spread spectrum intentional radiator is operating, the radio frequency power that is produced by the intentional radiator confirmed 20 dB below that in the 100 kHz bandwidth within the band that contains the highest level of the desired power, based on a radiated measurement.

#### **20 dBc was applied to the frequency over the limit of FCC 15.209 / Table 4 of RSS-Gen 8.9(IC) and outside the restricted band of FCC15.205 / Table 6 of RSS-Gen 8.10 (IC).**

Frequency	Below 1 GHz	Above 1 GHz		20 dBc
Instrument used	Test Receiver	Spectrum Analyzer		Spectrum Analyzer
Detector	QP	PK	AV *1)	PK
IF Bandwidth	BW 120 kHz	RBW: 1 MHz VBW: 3 MHz	11.12.2.5.2 RBW: 1 MHz VBW: 3 MHz Detector: Power Averaging (Linear voltage) Trace: 100 traces Duty factor was added to the results.	RBW: 100 kHz VBW: 300 kHz

\*1) Average Power Measurement was performed based on ANSI C63.10-2013.

**Figure 2: Test Setup**

Below 1 GHz

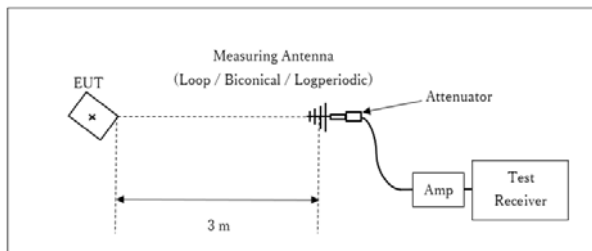

× : Center of turn table

Test Distance: 3 m

1 GHz - 13 GHz

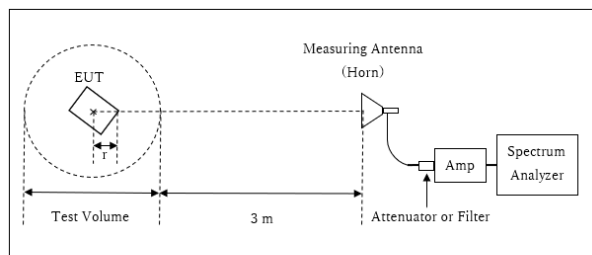

r : Radius of an outer periphery of EUT  
× : Center of turn table

Distance Factor:  $20 \times \log(3.99 \text{ m} / 3.0 \text{ m}) = 2.48 \text{ dB}$   
\* Test Distance:  $(3 + \text{Test Volume} / 2) - r = 3.99 \text{ m}$

Test Volume : 2 m  
(Test Volume has been calibrated based on CISPR 16-1-4.)  
r = 0.01 m

13 GHz - 26.5 GHz

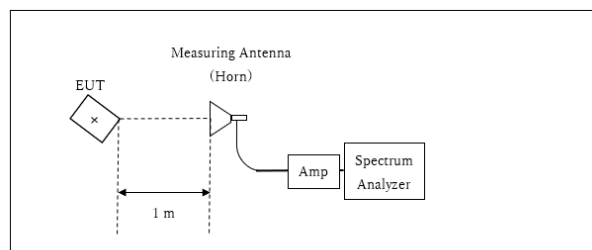

× : Center of turn table

Distance Factor:  $20 \times \log(1.0 \text{ m} / 3.0 \text{ m}) = -9.54 \text{ dB}$   
\*Test Distance: 1 m

- The carrier level and noise levels were confirmed at each position of X, Y and Z axes of EUT to see the position of maximum noise, and the test was made at the position that has the maximum noise.

**Combinations of the worst case**

Antenna polarization	Frequency	Spurious				
		Below 1 GHz	1 GHz – 2.8 GHz	2.8 GHz – 13 GHz	13 GHz-18 GHz	18 GHz-26.5 GHz
Horizontal		Z	Y	Y	X	X
Vertical		Z	Z	Z	X	Z

The test results and limit are rounded off to one decimal place, so some differences might be observed.

Measurement range : 30 MHz - 26.5 GHz  
Test data : APPENDIX  
Test result : Pass

## **SECTION 7: Antenna Terminal Conducted Tests**

### **Test Procedure**

The tests were made with below setting connected to the antenna port.

<b>Test</b>	<b>Span</b>	<b>RBW</b>	<b>VBW</b>	<b>Sweep time</b>	<b>Detector</b>	<b>Trace</b>	<b>Instrument used</b>
6 dB Bandwidth	Enough width to display emission skirts	100 kHz	300 kHz	Auto	Peak	Max Hold	Spectrum Analyzer
99 % Occupied Bandwidth *1)	Enough width to display emission skirts	1 to 5 % of OBW	Three times of RBW	Auto	Peak	Max Hold	Spectrum Analyzer
Maximum Peak Output Power	-	-	-	Auto	Peak/ Average *2)	-	Power Meter (Sensor: 160 MHz BW)
Peak Power Density	1.5 times the 6dB Bandwidth	3 kHz	9.1 kHz	Auto	Peak	Max Hold	Spectrum Analyzer *3)
Conducted Spurious Emission *4)	9kHz to 150kHz	200 Hz	620 Hz	Auto	Peak	Max Hold	Spectrum Analyzer
	150kHz to 30MHz	10 kHz	30 kHz				

\*1) Peak hold was applied as Worst-case measurement.

\*2) Reference data

\*3) Section 11.10.2 Method PKPSD (peak PSD) of "ANSI C63.10-2013".

\*4) In the frequency range below 30MHz, RBW was narrowed to separate the noise contents.

Then, wide-band noise near the limit was checked separately, however the noise was not detected as shown in the chart.

(9 kHz - 150 kHz: RBW = 200 Hz, 150 kHz - 30 MHz: RBW = 10 kHz)

The test results and limit are rounded off to two decimals place, so some differences might be observed.  
The equipment and cables were not used for factor 0 dB of the data sheets.

**Test data** : APPENDIX  
**Test result** : Pass



**APPENDIX 1: Test data**

**Conducted Emission**

**DATA OF CONDUCTED EMISSION TEST**

UL Japan, Inc. Shonan EMC Lab. No.2 Shielded Room  
Date : 2019/03/14

Mode : Tx\_11n-20\_2412 MHz, MIMO

Power : AC 120 V / 60 Hz  
Temp./Humi. : 22 deg.C / 36 %RH

Limit : FCC\_Part 15 Subpart C(15.207)

Engineer : Takahiro Suzuki

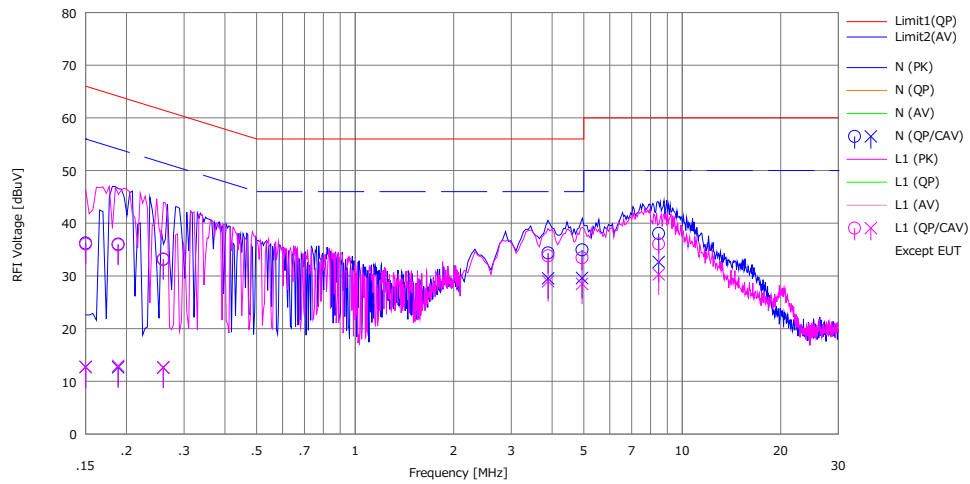

No.	Freq. [MHz]	Reading		C.Fac	Results		Limit		Margin		Phase	Comment
		<QP> [dBuV]	<CAV> [dBuV]		<QP> [dBuV]	<CAV> [dBuV]	<QP> [dBuV]	<AV> [dBuV]	<QP> [dB]	<AV> [dB]		
1	0.15000	23.82	0.29	12.41	36.23	12.70	66.00	56.00	29.7	43.3	N	
2	0.18871	23.61	0.23	12.43	36.04	12.66	64.09	54.09	28.0	41.4	N	
3	0.25916	20.73	0.18	12.43	33.16	12.61	61.46	51.46	28.3	38.8	N	
4	3.88862	21.75	16.92	12.62	34.37	29.54	56.00	46.00	21.6	16.4	N	
5	4.94196	22.27	16.94	12.68	34.95	29.62	56.00	46.00	21.0	16.3	N	
6	8.46737	25.25	19.83	12.81	38.06	32.64	60.00	50.00	21.9	17.3	N	
7	0.15000	23.63	0.34	12.41	36.04	12.75	66.00	56.00	29.9	43.2	L1	
8	0.18871	23.46	0.51	12.43	35.89	12.94	64.09	54.09	28.2	41.1	L1	
9	0.25916	20.78	0.24	12.43	33.21	12.67	61.46	51.46	28.2	38.7	L1	
10	3.88862	21.19	16.38	12.62	33.81	29.00	56.00	46.00	22.1	17.0	L1	
11	4.94196	20.76	15.83	12.68	33.44	28.51	56.00	46.00	22.5	17.4	L1	
12	8.46737	23.25	17.48	12.81	36.06	30.29	60.00	50.00	23.9	19.7	L1	

Calculation: Result[dBuV]=Reading[dBuV]+C.Fac(LISN+Cable+ATT)[dB]  
LISN: SLS-03

**6 dB Bandwidth and 99 % Occupied Bandwidth**

Report No. 12699044S-AJ-R1  
Test place Shonan EMC Lab. No.5 Shielded Room  
Date May 31, 2019 June 3, 2019  
Temperature / Humidity 25 deg. C / 47 % RH 25 deg. C / 42 % RH  
Engineer Kazuya Noda Yosuke Ishikawa  
Mode Tx

Mode	Frequency [MHz]	99% Occupied Bandwidth [kHz]	6dB Bandwidth [MHz]	Limit for 6dB Bandwidth [MHz]
11b	2412	13370.8	10.060	> 0.5000
	2437	13374.8	10.075	> 0.5000
	2462	13394.3	10.071	> 0.5000
11g	2412	16817.7	16.489	> 0.5000
	2437	16793.3	16.498	> 0.5000
	2462	16790.5	16.494	> 0.5000
11n-20 CDD	2412	17810.8	17.653	> 0.5000
	2437	17808.3	17.692	> 0.5000
	2462	17800.8	17.623	> 0.5000
11n-20 MIMO	2412	17804.5	17.714	> 0.5000
	2437	17810.6	17.700	> 0.5000
	2462	17759.3	17.673	> 0.5000
11n-40 CDD	2422	36306.0	35.508	> 0.5000
	2437	36352.3	35.862	> 0.5000
	2452	36405.1	35.435	> 0.5000
11n-40 MIMO	2422	36404.0	35.772	> 0.5000
	2437	36373.4	35.601	> 0.5000
	2452	36376.4	35.772	> 0.5000

**99%Occupied Bandwidth**

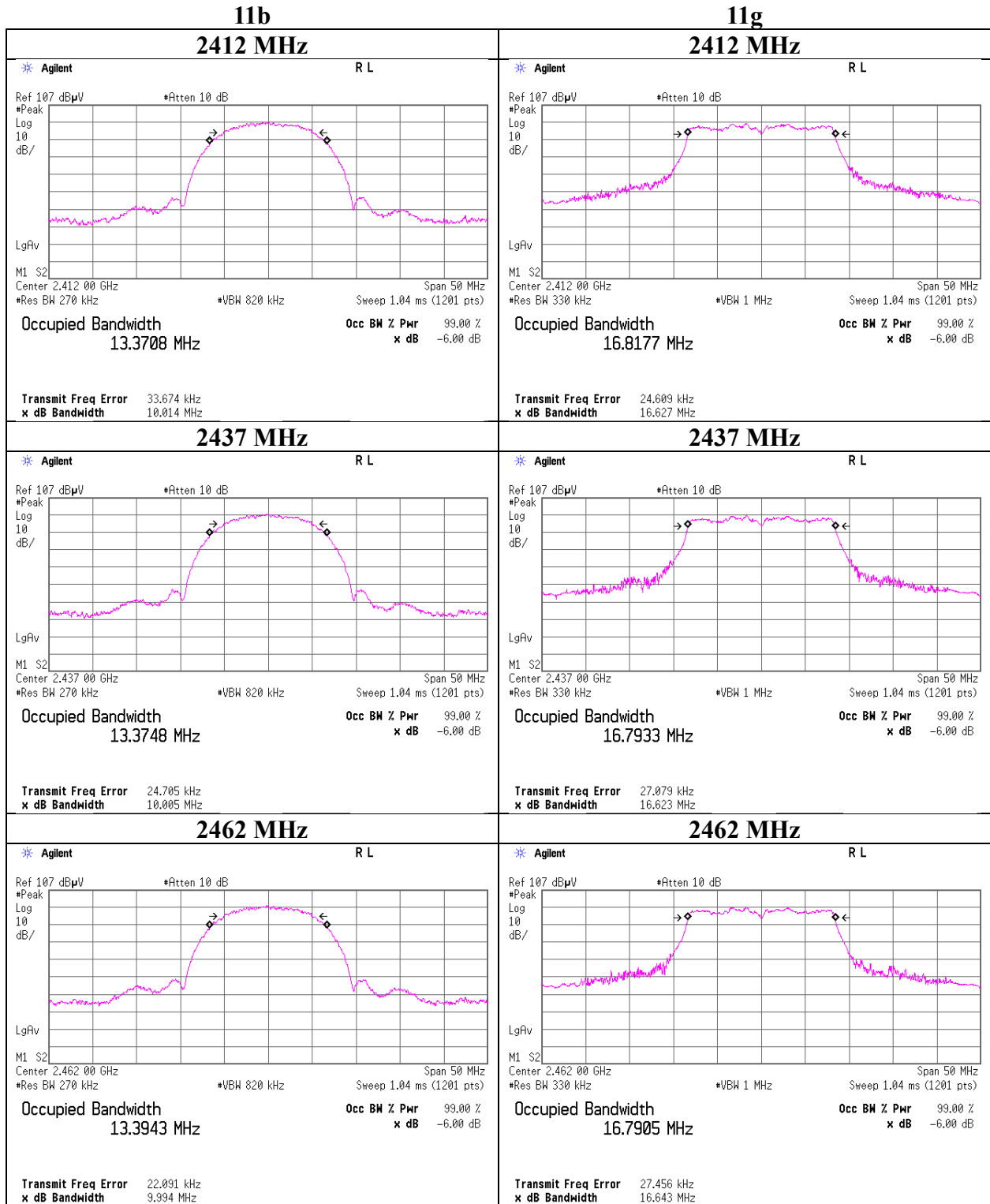

**99% Occupied Bandwidth**

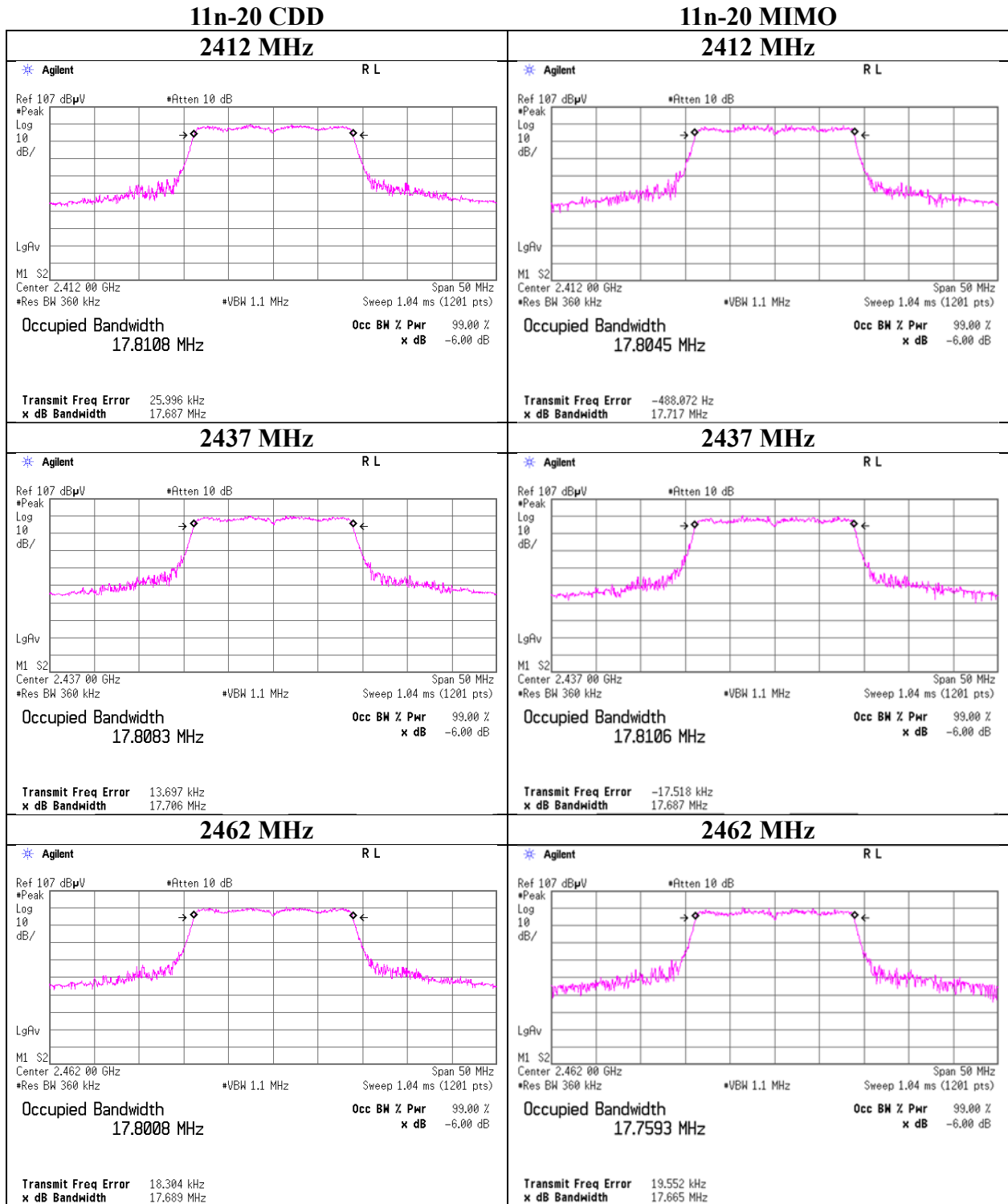

**99% Occupied Bandwidth**

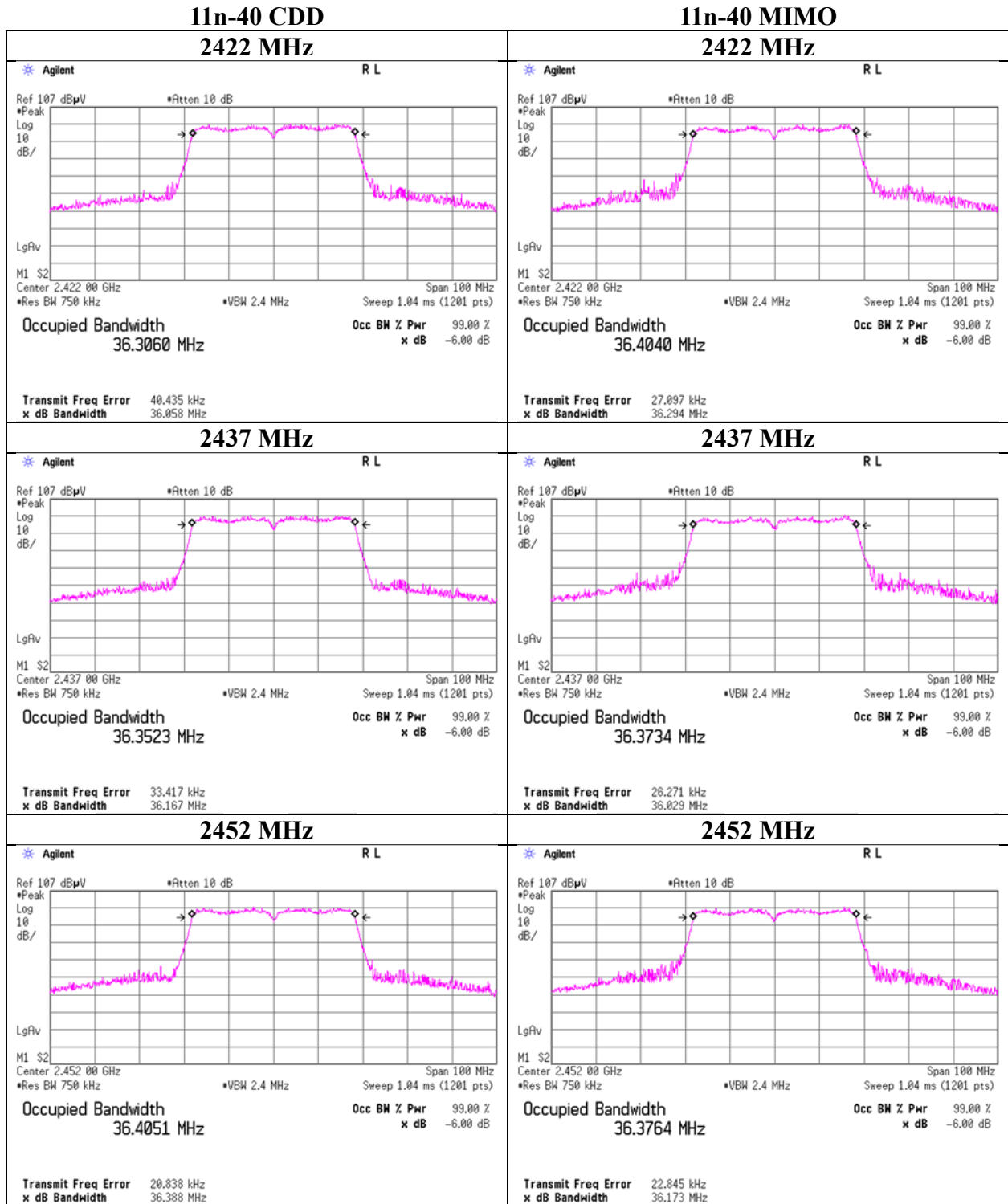

**UL Japan, Inc.**

**Shonan EMC Lab.**

1-22-3 Megumigaoka, Hiratsuka-shi, Kanagawa-ken, 259-1220 JAPAN

Telephone : +81 463 50 6400

Facsimile : +81 463 50 6401

### 6dB Bandwidth

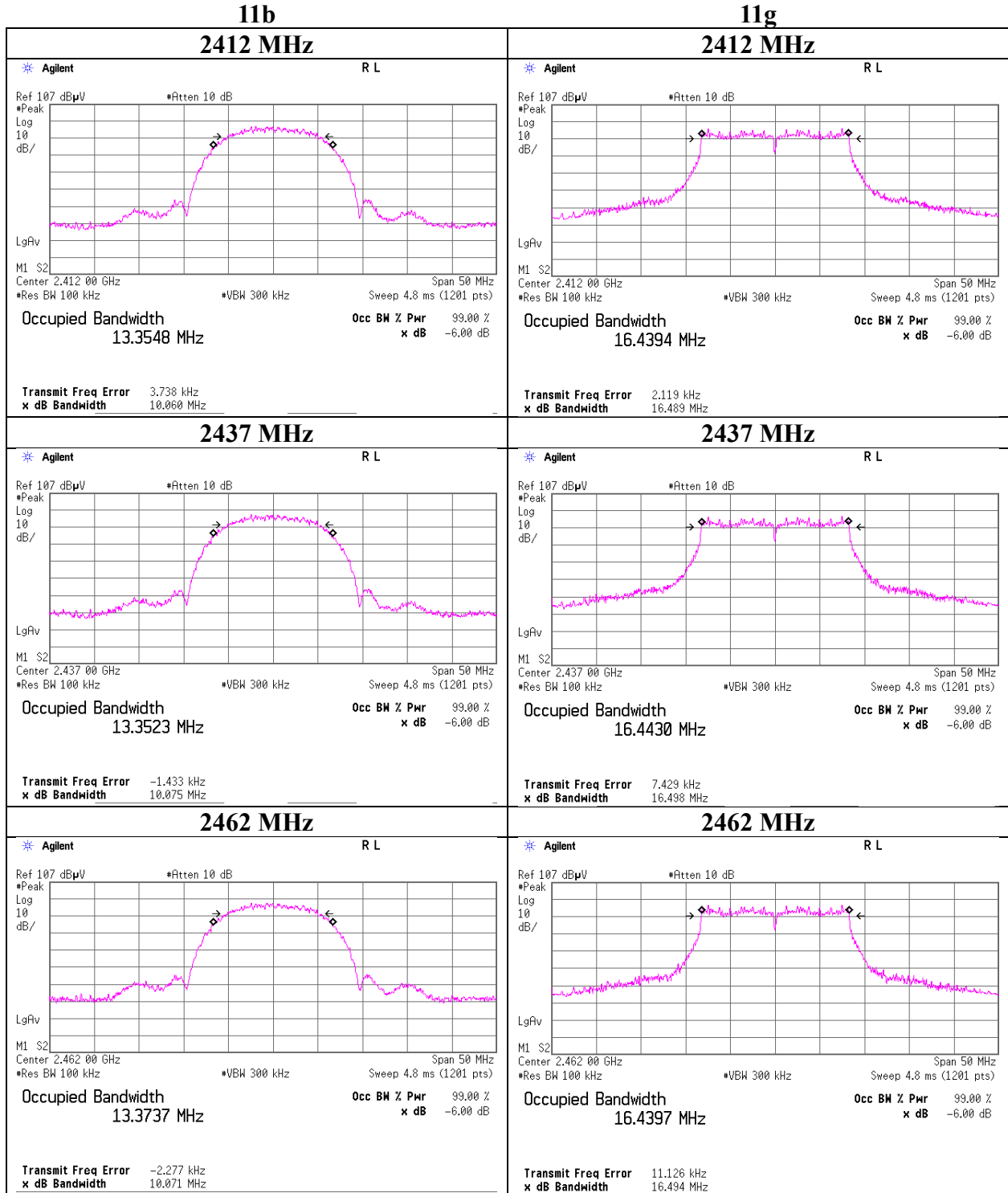

**6dB Bandwidth**

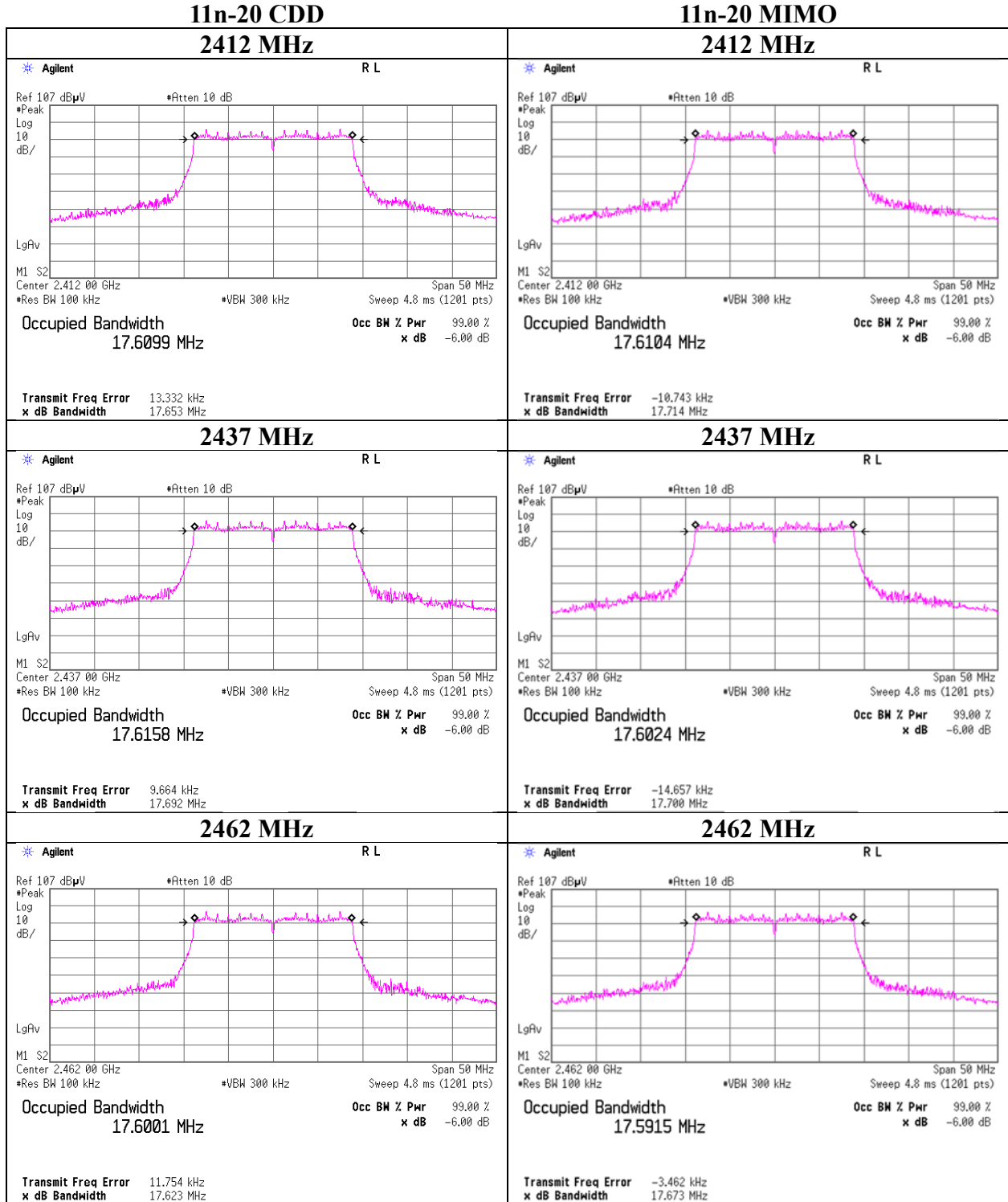

### 6dB Bandwidth

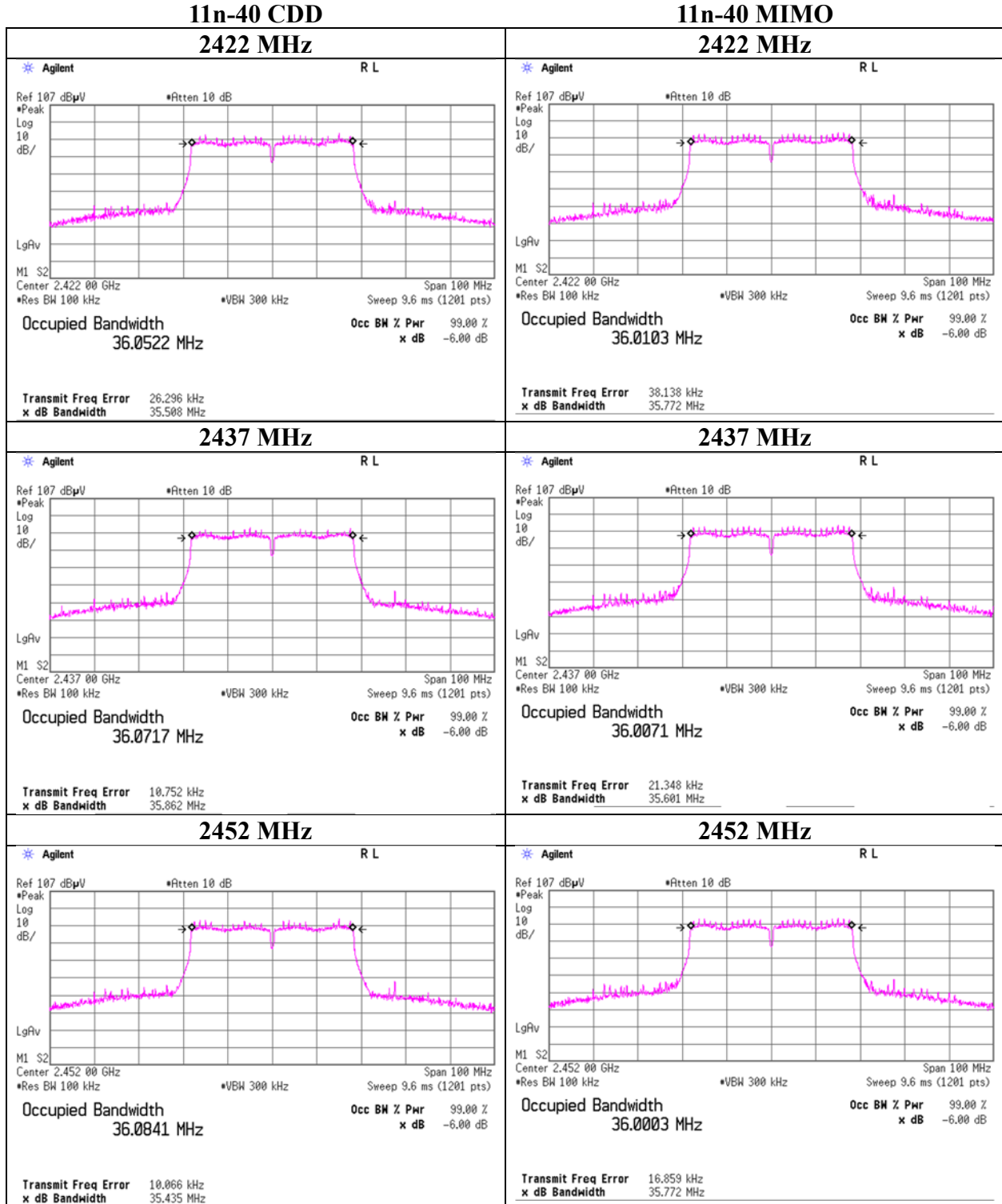

**UL Japan, Inc.**

**Shonan EMC Lab.**

1-22-3 Megumigaoka, Hiratsuka-shi, Kanagawa-ken, 259-1220 JAPAN

Telephone : +81 463 50 6400

Facsimile : +81 463 50 6401



## Maximum Peak Output Power

Report No. 12699044S-AJ-R1  
Test place Shonan EMC Lab. No.5 Shielded Room  
Date May 15, 2019  
Temperature / Humidity 24 deg. C / 51 % RH  
Engineer Kazuya Noda  
Mode Tx 11b

Antenna A + Antenna B

Freq.	Conducted Power					e.i.r.p.				
	Result		Limit		Margin	Result		Limit		Margin
[MHz]	[dBm]	[mW]	[dBm]	[mW]	[dB]	[dBm]	[mW]	[dBm]	[mW]	[dB]
2412	13.10	20.40	30.00	1000	16.90	11.33	13.57	36.02	4000	24.70
2437	13.43	22.03	30.00	1000	16.57	11.66	14.66	36.02	4000	24.36
2462	13.62	23.04	30.00	1000	16.38	11.85	15.33	36.02	4000	24.17

Sample Calculation:

Result = Antenna 1 Result + Antenna 2 Result

e.i.r.p. Result = Antenna A Result (e.i.r.p.) + Antenna B Result (e.i.r.p.)

Antenna A

Freq.	Reading	Cable Loss	Atten. Loss	Result		Directional Gain	Result	
				[dBm]	[mW]		[dBm]	[mW]
[MHz]	[dBm]	[dB]	[dB]	[dBm]	[mW]	[dBi]	[dBm]	[mW]
2412	-1.05	1.25	9.92	10.12	10.28	-1.77	8.35	6.84
2437	-0.83	1.25	9.92	10.34	10.81	-1.77	8.57	7.19
2462	-0.76	1.26	9.92	10.42	11.02	-1.77	8.65	7.33

Antenna B

Freq.	Reading	Cable Loss	Atten. Loss	Result		Directional Gain	Result	
				[dBm]	[mW]		[dBm]	[mW]
[MHz]	[dBm]	[dB]	[dB]	[dBm]	[mW]	[dBi]	[dBm]	[mW]
2412	-0.71	0.94	9.82	10.05	10.12	-1.77	8.28	6.73
2437	-0.27	0.95	9.82	10.50	11.22	-1.77	8.73	7.46
2462	0.02	0.96	9.82	10.80	12.02	-1.77	9.03	8.00

Sample Calculation:

Result = Reading + Cable Loss (including the cable(s) customer supplied) + Attenuator Loss

Result(e.i.r.p.) = Result + Directional Gain

Directional Gain = G ANT + Array Gain

G ANT = Set equal to the gain of the antenna having the highest gain

Array Gain = 0 dB(i.e.,no array gain) for N ANT < 4

N ANT = number of transmit antennas = 2

Worst Rate Check of Conducted Power (2437 MHz)

Rate	Antenna port A					Antenna port B					Total Result Power		Remark
	Reading	Cable Loss	Atten. Loss	Result		Reading	Cable Loss	Atten. Loss	Result		[dBm]	[mW]	
[Mbps]	[dBm]	[dB]	[dB]	[dBm]	[mW]	[dBm]	[dB]	[dB]	[dBm]	[mW]	[dBm]	[mW]	
1	-0.87	1.25	9.92	10.30	10.72	-0.29	0.95	9.82	10.48	11.17	13.40	21.88	
2	-0.95	1.25	9.92	10.22	10.52	-0.35	0.95	9.82	10.42	11.02	13.33	21.54	
5.5	-0.88	1.25	9.92	10.29	10.69	-0.28	0.95	9.82	10.49	11.19	13.40	21.88	
11	-0.83	1.25	9.92	10.34	10.81	-0.27	0.95	9.82	10.50	11.22	13.43	22.03	

\*Worst Rate

Sample Calculation:

Each port Result = Reading + Cable Loss (including the cable(s) customer supplied) + Attenuator Loss

Total Result = Antenna port A Result + Antenna port B Result

Worst Rate Check of e.i.r.p. (2437 MHz)

Rate	Antenna port A					Antenna port B					Total Result Power		Remark	
	Reading	Cable Loss	Atten. Loss	Directional Gain	Result (e.i.r.p.)	Reading	Cable Loss	Atten. Loss	Directional Gain	Result (e.i.r.p.)	[dBm]	[mW]		
[Mbps]	[dBm]	[dB]	[dB]	[dBi]	[dBm]	[dBm]	[dB]	[dB]	[dBi]	[dBm]	[mW]	[dBm]	[mW]	
1	-0.87	1.25	9.92	-1.77	8.53	7.13	-0.29	0.95	9.82	-1.77	8.71	7.43	11.63	14.56
2	-0.95	1.25	9.92	-1.77	8.45	7.00	-0.35	0.95	9.82	-1.77	8.65	7.33	11.56	14.33
5.5	-0.88	1.25	9.92	-1.77	8.52	7.11	-0.28	0.95	9.82	-1.77	8.72	7.45	11.63	14.56
11	-0.83	1.25	9.92	-1.77	8.57	7.19	-0.27	0.95	9.82	-1.77	8.73	7.46	11.66	14.66

\*Worst Rate

Sample Calculation:

Each port Result (e.i.r.p.) = Reading + Cable Loss (including the cable(s) customer supplied) + Attenuator Loss + Directional Gain

Total Result (e.i.r.p.) = Antenna port A Result + Antenna port B Result

Directional Gain = G ANT + Array Gain

G ANT = Set equal to the gain of the antenna having the highest gain

Array Gain = 0 dB(i.e.,no array gain) for N ANT < 4

N ANT = number of transmit antennas = 2

**UL Japan, Inc.**

**Shonan EMC Lab.**

1-22-3 Megumigaoka, Hiratsuka-shi, Kanagawa-ken, 259-1220 JAPAN

Telephone : +81 463 50 6400

Facsimile : +81 463 50 6401

## Maximum Peak Output Power

Report No. 12699044S-AJ-R1  
Test place Shonan EMC Lab. No.5 Shielded Room  
Date May 15, 2019  
Temperature / Humidity 24 deg. C / 51 % RH  
Engineer Kazuya Noda  
Mode Tx 11g

Antenna A + Antenna B

Freq. [MHz]	Conducted Power					e.i.r.p.				
	Result		Limit		Margin [dB]	Result		Limit		Margin [dB]
	[dBm]	[mW]	[dBm]	[mW]		[dBm]	[mW]	[dBm]	[mW]	
2412	20.68	117.01	30.00	1000	9.32	18.91	77.84	36.02	4000	17.11
2437	21.19	131.54	30.00	1000	8.81	19.42	87.51	36.02	4000	16.60
2462	21.33	135.69	30.00	1000	8.67	19.56	90.27	36.02	4000	16.47

Sample Calculation:

Result = Antenna 1 Result + Antenna 2 Result

e.i.r.p. Result = Antenna A Result (e.i.r.p.) + Antenna B Result (e.i.r.p.)

Antenna A

Freq. [MHz]	Reading [dBm]	Cable Loss [dB]	Atten. Loss [dB]	Result		Directional Gain [dBi]	Result (e.i.r.p.)	
				[dBm]	[mW]		[dBm]	[mW]
				2412	6.37		1.25	9.92
2437	6.79	1.25	9.92	17.96	62.52	-1.77	16.19	41.59
2462	6.92	1.26	9.92	18.10	64.57	-1.77	16.33	42.95

Antenna B

Freq. [MHz]	Reading [dBm]	Cable Loss [dB]	Atten. Loss [dB]	Result		Directional Gain [dBi]	Result (e.i.r.p.)	
				[dBm]	[mW]		[dBm]	[mW]
				2412	7.04		0.94	9.82
2437	7.62	0.95	9.82	18.39	69.02	-1.77	16.62	45.92
2462	7.74	0.96	9.82	18.52	71.12	-1.77	16.75	47.32

Sample Calculation:

Result = Reading + Cable Loss (including the cable(s) customer supplied) + Attenuator Loss

Result(e.i.r.p.) = Result + Directional Gain

Directional Gain = G ANT + Array Gain

G ANT = Set equal to the gain of the antenna having the highest gain

Array Gain = 0 dB(i.e.,no array gain) for N ANT < 4

N ANT = number of transmit antennas = 2

Worst Rate Check of Conducted Power (2437 MHz)

Rate [Mbps]	Antenna port A					Antenna port B					Total Result Power		Remark
	Reading [dBm]	Cable Loss [dB]	Atten. Loss [dB]	Result		Reading [dBm]	Cable Loss [dB]	Atten. Loss [dB]	Result		[dBm]	[mW]	
				[dBm]	[mW]				[dBm]	[mW]			
6	6.69	1.25	9.92	17.86	61.09	7.44	0.95	9.82	18.21	66.22	21.05	127.32	
9	6.69	1.25	9.92	17.86	61.09	7.45	0.95	9.82	18.22	66.37	21.05	127.47	
12	6.52	1.25	9.92	17.69	58.75	7.46	0.95	9.82	18.23	66.53	20.98	125.28	
18	6.68	1.25	9.92	17.85	60.95	7.37	0.95	9.82	18.14	65.16	21.01	126.12	
24	6.58	1.25	9.92	17.75	59.57	7.54	0.95	9.82	18.31	67.76	21.05	127.33	
36	6.72	1.25	9.92	17.89	61.52	7.65	0.95	9.82	18.42	69.50	21.17	131.02	
48	6.79	1.25	9.92	17.96	62.52	7.62	0.95	9.82	18.39	69.02	21.19	131.54	*
54	6.76	1.25	9.92	17.93	62.09	7.51	0.95	9.82	18.28	67.30	21.12	129.38	

\*Worst Rate

Sample Calculation:

Each port Result = Reading + Cable Loss (including the cable(s) customer supplied) + Attenuator Loss

Total Result = Antenna port A Result + Antenna Port B Result

Worst Rate Check of e.i.r.p. (2437 MHz)

Rate [Mbps]	Antenna port A					Antenna port B					Total Result Power (e.i.r.p.)		Remark		
	Reading [dBm]	Cable Loss [dB]	Atten. Loss [dB]	Directional Gain [dBi]	Result (e.i.r.p.)		Reading [dBm]	Cable Loss [dB]	Atten. Loss [dB]	Directional Gain [dBi]	Result (e.i.r.p.)			[dBm]	[mW]
					[dBm]	[mW]					[dBm]	[mW]			
6	6.69	1.25	9.92	-1.77	16.09	40.64	7.44	0.95	9.82	-1.77	16.44	44.06	19.28	84.70	
9	6.69	1.25	9.92	-1.77	16.09	40.64	7.45	0.95	9.82	-1.77	16.45	44.16	19.28	84.80	
12	6.52	1.25	9.92	-1.77	15.92	39.08	7.46	0.95	9.82	-1.77	16.46	44.26	19.21	83.34	
18	6.68	1.25	9.92	-1.77	16.08	40.55	7.37	0.95	9.82	-1.77	16.37	43.35	19.24	83.90	
24	6.58	1.25	9.92	-1.77	15.98	39.63	7.54	0.95	9.82	-1.77	16.54	45.08	19.28	84.71	
36	6.72	1.25	9.92	-1.77	16.12	40.93	7.65	0.95	9.82	-1.77	16.65	46.24	19.40	87.16	
48	6.79	1.25	9.92	-1.77	16.19	41.59	7.62	0.95	9.82	-1.77	16.62	45.92	19.42	87.51	
54	6.76	1.25	9.92	-1.77	16.16	41.30	7.51	0.95	9.82	-1.77	16.51	44.77	19.35	86.08	

\*Worst Rate

Sample Calculation:

Each port Result (e.i.r.p.) = Reading + Cable Loss (including the cable(s) customer supplied) + Attenuator Loss + Directional Gain

Total Result (e.i.r.p.) = Antenna port A Result + Antenna port B Result

Directional Gain = G ANT + Array Gain

G ANT = Set equal to the gain of the antenna having the highest gain

Array Gain = 0 dB(i.e.,no array gain) for N ANT < 4

N ANT = number of transmit antennas = 2

**UL Japan, Inc.**

**Shonan EMC Lab.**

1-22-3 Megumigaoka, Hiratsuka-shi, Kanagawa-ken, 259-1220 JAPAN

Telephone : +81 463 50 6400

Facsimile : +81 463 50 6401

## Maximum Peak Output Power

Report No. 12699044S-AJ-R1  
Test place Shonan EMC Lab. No.5 Shielded Room  
Date May 15, 2019  
Temperature / Humidity 24 deg. C / 51 % RH  
Engineer Kazuya Noda  
Mode Tx 11n-20 CDD

Antenna A + Antenna B

Freq. [MHz]	Conducted Power					e.i.r.p.				
	Result		Limit		Margin [dB]	Result		Limit		Margin [dB]
	[dBm]	[mW]	[dBm]	[mW]		[dBm]	[mW]	[dBm]	[mW]	
2412	21.93	155.90	30.00	1000	8.07	20.16	103.72	36.02	4000	15.86
2437	22.20	165.83	30.00	1000	7.80	20.43	110.32	36.02	4000	15.59
2462	22.39	173.20	30.00	1000	7.61	20.62	115.23	36.02	4000	15.41

Sample Calculation:

Result = Antenna A Result + Antenna B Result

e.i.r.p. Result = Antenna A Result (e.i.r.p.) + Antenna B Result (e.i.r.p.)

Antenna A

Freq. [MHz]	Reading [dBm]	Cable Loss [dB]	Atten. Loss [dB]	Result		Directional Gain [dBi]	Result (e.i.r.p.)	
				[dBm]	[mW]		[dBm]	[mW]
				2412	7.58		1.25	9.92
2437	7.91	1.25	9.92	19.08	80.91	-1.77	17.31	53.83
2462	8.15	1.26	9.92	19.33	85.70	-1.77	17.56	57.02

Antenna B

Freq. [MHz]	Reading [dBm]	Cable Loss [dB]	Atten. Loss [dB]	Result		Directional Gain [dBi]	Result (e.i.r.p.)	
				[dBm]	[mW]		[dBm]	[mW]
				2412	8.32		0.94	9.82
2437	8.52	0.95	9.82	19.29	84.92	-1.77	17.52	56.49
2462	8.64	0.96	9.82	19.42	87.50	-1.77	17.65	58.21

Sample Calculation:

Result = Reading + Cable Loss (including the cable(s) customer supplied) + Attenuator Loss

Result(e.i.r.p.) = Result + Directional Gain

Directional Gain = G ANT + Array Gain

G ANT = Set equal to the gain of the antenna having the highest gain

Array Gain = 0 dB(i.e.,no array gain) for N ANT < 4

N ANT = number of transmit antennas = 2

Worst MCS Check of Conducted Power (2437 MHz)

MCS Number	Antenna port A					Antenna port B					Total Result Power		Remark
	Reading [dBm]	Cable Loss [dB]	Atten. Loss [dB]	Result		Reading [dBm]	Cable Loss [dB]	Atten. Loss [dB]	Result		[dBm]	[mW]	
				[dBm]	[mW]				[dBm]	[mW]			
0	6.77	1.25	9.92	17.94	62.23	7.49	0.95	9.82	18.26	66.99	21.11	129.22	
1	7.13	1.25	9.92	18.30	67.61	7.80	0.95	9.82	18.57	71.94	21.45	139.55	
2	7.91	1.25	9.92	19.08	80.91	8.52	0.95	9.82	19.29	84.92	22.20	165.83	*
3	7.32	1.25	9.92	18.49	70.63	8.02	0.95	9.82	18.79	75.68	21.65	146.32	
4	7.29	1.25	9.92	18.46	70.15	7.91	0.95	9.82	18.68	73.79	21.58	143.94	
5	7.40	1.25	9.92	18.57	71.94	8.07	0.95	9.82	18.84	76.56	21.72	148.50	
6	7.24	1.25	9.92	18.41	69.34	7.99	0.95	9.82	18.76	75.16	21.60	144.50	
7	6.82	1.25	9.92	17.99	62.95	7.62	0.95	9.82	18.39	69.02	21.20	131.97	

\*Worst MCS

Sample Calculation:

Each port Result = Reading + Cable Loss (including the cable(s) customer supplied) + Attenuator Loss

Total Result = Antenna port A Result + Antenna port B Result

Worst MCS Check of e.i.r.p. (2437 MHz)

MCS Number	Antenna port A					Antenna port B					Total Result Power		Remark		
	Reading [dBm]	Cable Loss [dB]	Atten. Loss [dB]	Directional Gain [dBi]	Result (e.i.r.p.)		Reading [dBm]	Cable Loss [dB]	Atten. Loss [dB]	Directional Gain [dBi]	Result (e.i.r.p.)			Result Power (e.i.r.p.)	
					[dBm]	[mW]					[dBm]	[mW]		[dBm]	[mW]
0	6.77	1.25	9.92	-1.77	16.17	41.40	7.49	0.95	9.82	-1.77	16.49	44.57	19.34	85.97	
1	7.13	1.25	9.92	-1.77	16.53	44.98	7.80	0.95	9.82	-1.77	16.80	47.86	19.68	92.84	
2	7.91	1.25	9.92	-1.77	17.31	53.83	8.52	0.95	9.82	-1.77	17.52	56.49	20.43	110.32	*
3	7.32	1.25	9.92	-1.77	16.72	46.99	8.02	0.95	9.82	-1.77	17.02	50.35	19.88	97.34	
4	7.29	1.25	9.92	-1.77	16.69	46.67	7.91	0.95	9.82	-1.77	16.91	49.09	19.81	95.76	
5	7.40	1.25	9.92	-1.77	16.80	47.86	8.07	0.95	9.82	-1.77	17.07	50.93	19.95	98.80	
6	7.24	1.25	9.92	-1.77	16.64	46.13	7.99	0.95	9.82	-1.77	16.99	50.00	19.83	96.14	
7	6.82	1.25	9.92	-1.77	16.22	41.88	7.62	0.95	9.82	-1.77	16.62	45.92	19.43	87.80	

\*Worst Rate

Sample Calculation:

Each port Result (e.i.r.p.) = Reading + Cable Loss (including the cable(s) customer supplied) + Attenuator Loss + Directional Gain

Total Result (e.i.r.p.) = Antenna port A Result + Antenna port B Result

Result(e.i.r.p.) = Result + Directional Gain

Directional Gain = G ANT + Array Gain

G ANT = Set equal to the gain of the antenna having the highest gain

Array Gain = 0 dB(i.e.,no array gain) for N ANT < 4

N ANT = number of transmit antennas = 2

**UL Japan, Inc.**

**Shonan EMC Lab.**

1-22-3 Megumioka, Hiratsuka-shi, Kanagawa-ken, 259-1220 JAPAN

Telephone : +81 463 50 6400

Facsimile : +81 463 50 6401

## Maximum Peak Output Power

Report No. 12699044S-AJ-R1  
Test place Shonan EMC Lab. No.5 Shielded Room  
Date May 15, 2019  
Temperature / Humidity 24 deg. C / 51 % RH  
Engineer Kazuya Noda  
Mode Tx 11n-20 MIMO

Antenna A + Antenna B

Freq. [MHz]	Conducted Power					e.i.r.p.				
	Result		Limit		Margin [dB]	Result		Limit		Margin [dB]
	[dBm]	[mW]	[dBm]	[mW]		[dBm]	[mW]	[dBm]	[mW]	
2412	21.56	143.15	30.00	1000	8.44	18.74	74.75	36.02	4000	17.28
2437	22.05	160.46	30.00	1000	7.95	19.26	84.28	36.02	4000	16.76
2462	22.17	164.86	30.00	1000	7.83	19.34	85.93	36.02	4000	16.68

Sample Calculation:

Result = Antenna A Result + Antenna B Result

e.i.r.p. Result = Antenna A Result (e.i.r.p.) + Antenna B Result (e.i.r.p.)

Antenna A

Freq. [MHz]	Reading [dBm]	Cable Loss [dB]	Atten. Loss [dB]	Result		Antenna Gain [dBi]	Result (e.i.r.p.)	
				[dBm]	[mW]		[dBm]	[mW]
2412	6.91	1.25	9.92	18.08	64.27	-1.77	16.31	42.76
2437	7.52	1.25	9.92	18.69	73.96	-1.77	16.92	49.20
2462	7.48	1.26	9.92	18.66	73.45	-1.77	16.89	48.87

Antenna B

Freq. [MHz]	Reading [dBm]	Cable Loss [dB]	Atten. Loss [dB]	Result		Antenna Gain [dBi]	Result (e.i.r.p.)	
				[dBm]	[mW]		[dBm]	[mW]
2412	8.21	0.94	9.82	18.97	78.89	-3.92	15.05	31.99
2437	8.60	0.95	9.82	19.37	86.50	-3.92	15.45	35.08
2462	8.83	0.96	9.82	19.61	91.41	-3.92	15.69	37.07

Sample Calculation:

Result = Reading + Cable Loss (including the cable(s) customer supplied) + Attenuator Loss

Worst MCS Check of Conducted Power (2437 MHz)

MCS Number	Antenna port A					Antenna port B					Total Result Power		Remark
	Reading [dBm]	Cable Loss [dB]	Atten. Loss [dB]	Result		Reading [dBm]	Cable Loss [dB]	Atten. Loss [dB]	Result		[dBm]	[mW]	
				[dBm]	[mW]				[dBm]	[mW]			
8	6.89	1.25	9.92	18.06	63.97	7.86	0.95	9.82	18.63	72.95	21.36	136.92	
9	6.63	1.25	9.92	17.80	60.26	8.02	0.95	9.82	18.79	75.68	21.33	135.94	
10	7.04	1.25	9.92	18.21	66.22	7.75	0.95	9.82	18.52	71.12	21.38	137.34	
11	7.14	1.25	9.92	18.31	67.76	8.06	0.95	9.82	18.83	76.38	21.59	144.15	
12	7.41	1.25	9.92	18.58	72.11	7.52	0.95	9.82	18.29	67.45	21.45	139.56	
13	6.59	1.25	9.92	17.76	59.70	7.42	0.95	9.82	18.19	65.92	20.99	125.62	
14	7.52	1.25	9.92	18.69	73.96	8.60	0.95	9.82	19.37	86.50	22.05	160.46	*
15	6.95	1.25	9.92	18.12	64.86	8.72	0.95	9.82	19.49	88.92	21.87	153.78	

\*Worst MCS

Sample Calculation:

Each port Result = Reading + Cable Loss (including the cable(s) customer supplied) + Attenuator Loss

Total Result = Antenna port A Result + Antenna port B Result

Worst MCS Check of e.i.r.p. (2437 MHz)

MCS Number	Antenna port A					Antenna port B					Total Result Power		Remark		
	Reading [dBm]	Cable Loss [dB]	Atten. Loss [dB]	Result (e.i.r.p.)		Reading [dBm]	Cable Loss [dB]	Atten. Loss [dB]	Result (e.i.r.p.)		[dBm]	[mW]			
				[dBm]	[mW]				[dBm]	[mW]					
8	6.89	1.25	9.92	-1.77	16.29	42.56	7.86	0.95	9.82	-3.92	14.71	29.58	18.58	72.14	
9	6.63	1.25	9.92	-1.77	16.03	40.09	8.02	0.95	9.82	-3.92	14.87	30.69	18.50	70.78	
10	7.04	1.25	9.92	-1.77	16.44	44.06	7.75	0.95	9.82	-3.92	14.60	28.84	18.63	72.90	
11	7.14	1.25	9.92	-1.77	16.54	45.08	8.06	0.95	9.82	-3.92	14.91	30.97	18.81	76.06	
12	7.41	1.25	9.92	-1.77	16.81	47.97	7.52	0.95	9.82	-3.92	14.37	27.35	18.77	75.33	
13	6.59	1.25	9.92	-1.77	15.99	39.72	7.42	0.95	9.82	-3.92	14.27	26.73	18.22	66.45	
14	7.52	1.25	9.92	-1.77	16.92	49.20	8.60	0.95	9.82	-3.92	15.45	35.08	19.26	84.28	*
15	6.95	1.25	9.92	-1.77	16.35	43.15	8.72	0.95	9.82	-3.92	15.57	36.06	18.99	79.21	

\*Worst MCS

Sample Calculation:

Each port Result (e.i.r.p.) = Reading + Cable Loss (including the cable(s) customer supplied) + Attenuator Loss + Antenna Gain

Total Result (e.i.r.p.) = Antenna port A Result + Antenna port B Result

**UL Japan, Inc.**

**Shonan EMC Lab.**

1-22-3 Megumigaoka, Hiratsuka-shi, Kanagawa-ken, 259-1220 JAPAN

Telephone : +81 463 50 6400

Facsimile : +81 463 50 6401

## Maximum Peak Output Power

Report No. 12699044S-AJ-R1  
Test place Shonan EMC Lab. No.5 Shielded Room  
Date May 15, 2019  
Temperature / Humidity 24 deg. C / 51 % RH  
Engineer Kazuya Noda  
Mode Tx 11n-40 CDD

Antenna A + Antenna B

Freq. [MHz]	Conducted Power					e.i.r.p.				
	Result		Limit		Margin [dB]	Result		Limit		Margin [dB]
	[dBm]	[mW]	[dBm]	[mW]		[dBm]	[mW]	[dBm]	[mW]	
2422	22.59	181.66	30.00	1000	7.41	20.82	120.85	36.02	4000	15.20
2437	22.73	187.62	30.00	1000	7.27	20.96	124.82	36.02	4000	15.06
2452	22.92	195.83	30.00	1000	7.08	21.15	130.28	36.02	4000	14.87

Sample Calculation:

Result = Antenna A Result + Antenna B Result

e.i.r.p. Result = Antenna A Result (e.i.r.p.) + Antenna B Result (e.i.r.p.)

Antenna A

Freq. [MHz]	Reading [dBm]	Cable Loss [dB]	Atten. Loss [dB]	Result		Directional Gain [dBi]	Result (e.i.r.p.)	
				[dBm]	[mW]		[dBm]	[mW]
				2422	8.27		1.25	9.92
2437	8.29	1.25	9.92	19.46	88.31	-1.77	17.69	58.75
2452	8.56	1.25	9.92	19.73	93.97	-1.77	17.96	62.52

Antenna B

Freq. [MHz]	Reading [dBm]	Cable Loss [dB]	Atten. Loss [dB]	Result		Directional Gain [dBi]	Result (e.i.r.p.)	
				[dBm]	[mW]		[dBm]	[mW]
				2422	8.96		0.94	9.82
2437	9.20	0.95	9.82	19.97	99.31	-1.77	18.20	66.07
2452	9.31	0.95	9.82	20.08	101.86	-1.77	18.31	67.76

Sample Calculation:

Result = Reading + Cable Loss (including the cable(s) customer supplied) + Attenuator Loss

Result(e.i.r.p.) = Result + Directional Gain

Directional Gain = G ANT + Array Gain

G ANT = Set equal to the gain of the antenna having the highest gain

Array Gain = 0 dB(i.e.,no array gain) for N ANT < 4

N ANT = number of transmit antennas = 2

Worst MCS Check of Conducted Power (2437 MHz)

MCS Number	Antenna port A					Antenna port B					Total Result Power		Remark
	Reading [dBm]	Cable Loss [dB]	Atten. Loss [dB]	Result		Reading [dBm]	Cable Loss [dB]	Atten. Loss [dB]	Result		[dBm]	[mW]	
				[dBm]	[mW]				[dBm]	[mW]			
0	8.29	1.25	9.92	19.46	88.31	9.20	0.95	9.82	19.97	99.31	22.73	187.62	*
1	7.92	1.25	9.92	19.09	81.10	8.53	0.95	9.82	19.30	85.11	22.21	166.21	
2	7.34	1.25	9.92	18.51	70.96	8.05	0.95	9.82	18.82	76.21	21.68	147.17	
3	7.42	1.25	9.92	18.59	72.28	7.88	0.95	9.82	18.65	73.28	21.63	145.56	
4	7.24	1.25	9.92	18.41	69.34	7.99	0.95	9.82	18.76	75.16	21.60	144.50	
5	6.80	1.25	9.92	17.97	62.66	7.42	0.95	9.82	18.19	65.92	21.09	128.58	
6	7.22	1.25	9.92	18.39	69.02	8.18	0.95	9.82	18.95	78.52	21.69	147.55	
7	7.54	1.25	9.92	18.71	74.30	8.22	0.95	9.82	18.99	79.25	21.86	153.55	

\*Worst MCS

Sample Calculation:

Each port Result = Reading + Cable Loss (including the cable(s) customer supplied) + Attenuator Loss

Total Result = Antenna port A Result + Antenna port B Result

Worst MCS Check of e.i.r.p. (2437 MHz)

MCS Number	Antenna port A					Antenna port B					Total Result Power		Remark		
	Reading [dBm]	Cable Loss [dB]	Atten. Loss [dB]	Directional Gain [dBi]	Result (e.i.r.p.)		Reading [dBm]	Cable Loss [dB]	Atten. Loss [dB]	Antenna Gain [dBi]	Result (e.i.r.p.)			Result Power (e.i.r.p.)	
					[dBm]	[mW]					[dBm]	[mW]		[dBm]	[mW]
0	8.29	1.25	9.92	-1.77	17.69	58.75	9.20	0.95	9.82	-1.77	18.20	66.07	20.96	124.82	*
1	7.92	1.25	9.92	-1.77	17.32	53.95	8.53	0.95	9.82	-1.77	17.53	56.62	20.44	110.57	
2	7.34	1.25	9.92	-1.77	16.74	47.21	8.05	0.95	9.82	-1.77	17.05	50.70	19.91	97.91	
3	7.42	1.25	9.92	-1.77	16.82	48.08	7.88	0.95	9.82	-1.77	16.88	48.75	19.86	96.84	
4	7.24	1.25	9.92	-1.77	16.64	46.13	7.99	0.95	9.82	-1.77	16.99	50.00	19.83	96.14	
5	6.80	1.25	9.92	-1.77	16.20	41.69	7.42	0.95	9.82	-1.77	16.42	43.85	19.32	85.54	
6	7.22	1.25	9.92	-1.77	16.62	45.92	8.18	0.95	9.82	-1.77	17.18	52.24	19.92	98.16	
7	7.54	1.25	9.92	-1.77	16.94	49.43	8.22	0.95	9.82	-1.77	17.22	52.72	20.09	102.15	

\*Worst MCS

Sample Calculation:

Each port Result (e.i.r.p.) = Reading + Cable Loss (including the cable(s) customer supplied) + Attenuator Loss + Directional Gain

Total Result (e.i.r.p.) = Antenna port A Result + Antenna port B Result

Result(e.i.r.p.) = Result + Directional Gain

Directional Gain = G ANT + Array Gain

G ANT = Set equal to the gain of the antenna having the highest gain

**UL Japan, Inc.**

**Shonan EMC Lab.**

1-22-3 Megumigaoka, Hiratsuka-shi, Kanagawa-ken, 259-1220 JAPAN

Telephone : +81 463 50 6400

Facsimile : +81 463 50 6401

## Maximum Peak Output Power

Report No. 12699044S-AJ-R1  
Test place Shonan EMC Lab. No.5 Shielded Room  
Date May 15, 2019  
Temperature / Humidity 24 deg. C / 51 % RH  
Engineer Kazuya Noda  
Mode Tx 11n-40 MIMO

Antenna A + Antenna B

Freq. [MHz]	Conducted Power						e.i.r.p.				
	Result		Limit		Margin [dB]	Result		Limit		Margin [dB]	
	[dBm]	[mW]	[dBm]	[mW]		[dBm]	[mW]	[dBm]	[mW]		
2422	22.15	163.94	30.00	1000	7.85	19.41	87.21	36.02	4000	16.62	
2437	22.38	173.14	30.00	1000	7.62	19.63	91.77	36.02	4000	16.39	
2452	22.50	177.75	30.00	1000	7.50	19.75	94.34	36.02	4000	16.27	

Sample Calculation:

Result = Antenna A Result + Antenna B Result

e.i.r.p. Result = Antenna 1 Result (e.i.r.p.) + Antenna 2 Result (e.i.r.p.)

Antenna A

Freq. [MHz]	Reading [dBm]	Cable Loss [dB]	Atten. Loss [dB]	Result		Antenna Gain [dBi]	Result (e.i.r.p.)	
				[dBm]	[mW]		[dBm]	[mW]
				2422	7.85		1.25	9.92
2437	8.02	1.25	9.92	19.19	82.99	-1.77	17.42	55.21
2452	8.16	1.25	9.92	19.33	85.70	-1.77	17.56	57.02

Antenna B

Freq. [MHz]	Reading [dBm]	Cable Loss [dB]	Atten. Loss [dB]	Result		Antenna Gain [dBi]	Result (e.i.r.p.)	
				[dBm]	[mW]		[dBm]	[mW]
				2422	8.49		0.94	9.82
2437	8.78	0.95	9.82	19.55	90.16	-3.92	15.63	36.56
2452	8.87	0.95	9.82	19.64	92.04	-3.92	15.72	37.33

Sample Calculation:

Result = Reading + Cable Loss (including the cable(s) customer supplied) + Attenuator Loss

Worst MCS Check of Conducted Power (2437 MHz)

MCS Number	Antenna port A					Antenna port B					Total Result Power		Remark
	Reading [dBm]	Cable Loss [dB]	Atten. Loss [dB]	Result		Reading [dBm]	Cable Loss [dB]	Atten. Loss [dB]	Result		[dBm]	[mW]	
				[dBm]	[mW]				[dBm]	[mW]			
8	7.44	1.25	9.92	18.61	72.61	7.91	0.95	9.82	18.68	73.79	21.66	146.40	
9	8.02	1.25	9.92	19.19	82.99	8.78	0.95	9.82	19.55	90.16	22.38	173.14	*
10	7.36	1.25	9.92	18.53	71.29	7.65	0.95	9.82	18.42	69.50	21.49	140.79	
11	7.98	1.25	9.92	19.15	82.22	7.79	0.95	9.82	18.56	71.78	21.88	154.00	
12	7.24	1.25	9.92	18.41	69.34	7.92	0.95	9.82	18.69	73.96	21.56	143.30	
13	7.42	1.25	9.92	18.59	72.28	8.16	0.95	9.82	18.93	78.16	21.77	150.44	
14	7.22	1.25	9.92	18.39	69.02	8.29	0.95	9.82	19.06	80.54	21.75	149.56	
15	7.98	1.25	9.92	19.15	82.22	8.61	0.95	9.82	19.38	86.70	22.28	168.92	

\*Worst MCS

Sample Calculation:

Each port Result = Reading + Cable Loss (including the cable(s) customer supplied) + Attenuator Loss

Total Result = Antenna port A Result + Antenna port B Result

Worst MCS Check of e.i.r.p. (2437 MHz)

MCS Number	Antenna port A					Antenna port B					Total Result Power		Remark		
	Reading [dBm]	Cable Loss [dB]	Atten. Loss [dB]	Result (e.i.r.p.)		Reading [dBm]	Cable Loss [dB]	Atten. Loss [dB]	Result (e.i.r.p.)		[dBm]	[mW]			
				[dBm]	[mW]				[dBm]	[mW]					
8	7.44	1.25	9.92	-1.77	16.84	48.31	7.91	0.95	9.82	-3.92	14.76	29.92	18.93	78.23	
9	8.02	1.25	9.92	-1.77	17.42	55.21	8.78	0.95	9.82	-3.92	15.63	36.56	19.63	91.77	*
10	7.36	1.25	9.92	-1.77	16.76	47.42	7.65	0.95	9.82	-3.92	14.50	28.18	18.79	75.61	
11	7.98	1.25	9.92	-1.77	17.38	54.70	7.79	0.95	9.82	-3.92	14.64	29.11	19.23	83.81	
12	7.24	1.25	9.92	-1.77	16.64	46.13	7.92	0.95	9.82	-3.92	14.77	29.99	18.82	76.12	
13	7.42	1.25	9.92	-1.77	16.82	48.08	8.16	0.95	9.82	-3.92	15.01	31.70	19.02	79.78	
14	7.22	1.25	9.92	-1.77	16.62	45.92	8.29	0.95	9.82	-3.92	15.14	32.66	18.95	78.58	
15	7.98	1.25	9.92	-1.77	17.38	54.70	8.61	0.95	9.82	-3.92	15.46	35.16	19.54	89.86	

\*Worst MCS

Sample Calculation:

Each port Result (e.i.r.p.) = Reading + Cable Loss (including the cable(s) customer supplied) + Attenuator Loss + Antenna Gain

Total Result (e.i.r.p.) = Antenna port A Result + Antenna port B Result

**UL Japan, Inc.**

**Shonan EMC Lab.**

1-22-3 Megumigaoka, Hiratsuka-shi, Kanagawa-ken, 259-1220 JAPAN

Telephone : +81 463 50 6400

Facsimile : +81 463 50 6401

**Average Output Power**  
**(Reference data for RF Exposure)**

Report No. 12699044S-AJ-R1  
Test place Shonan EMC Lab. No.5 Shielded Room  
Date May 15, 2019  
Temperature / Humidity 24 deg. C / 51 % RH  
Engineer Kazuya Noda  
Mode Tx

**11b 1 Mbps**

Antenna A + Antenna B

Freq. [MHz]	Antenna A	Antenna B	Result (Burst Power Average)	
	Result [mW]	Result [mW]	[dBm]	[mW]
2412	5.43	5.27	10.30	10.70
2437	5.64	6.04	10.67	11.68
2462	5.75	6.46	10.87	12.21

Sample Calculation:

Result = Antenna A + Antenna B

Antenna A

Freq. [MHz]	Reading [dBm]	Cable Loss [dB]	Atten. Loss [dB]	Duty Factor [dB]	Result	
					[dBm]	[mW]
2412	-3.82	1.25	9.92	0.00	7.35	5.43
2437	-3.66	1.25	9.92	0.00	7.51	5.64
2462	-3.58	1.26	9.92	0.00	7.60	5.75

Antenna B

Freq. [MHz]	Reading [dBm]	Cable Loss [dB]	Atten. Loss [dB]	Duty Factor [dB]	Result	
					[dBm]	[mW]
2412	-3.54	0.94	9.82	0.00	7.22	5.27
2437	-2.96	0.95	9.82	0.00	7.81	6.04
2462	-2.68	0.96	9.82	0.00	8.10	6.46

Sample Calculation:

Result = Reading + Cable Loss (including the cable(s) customer supplied) + Attenuator Loss + Duty Factor

**11g 6 Mbps**

Antenna A + Antenna B

Freq. [MHz]	Antenna A	Antenna B	Result (Burst Power Average)	
	Result [mW]	Result [mW]	[dBm]	[mW]
2412	5.24	5.24	10.20	10.47
2437	5.52	5.79	10.54	11.32
2462	5.58	6.19	10.71	11.78

Sample Calculation:

Result = Antenna A + Antenna B

Antenna A

Freq. [MHz]	Reading [dBm]	Cable Loss [dB]	Atten. Loss [dB]	Duty Factor [dB]	Result	
					[dBm]	[mW]
2412	-3.99	1.25	9.92	0.01	7.19	5.24
2437	-3.76	1.25	9.92	0.01	7.42	5.52
2462	-3.72	1.26	9.92	0.01	7.47	5.58

Antenna B

Freq. [MHz]	Reading [dBm]	Cable Loss [dB]	Atten. Loss [dB]	Duty Factor [dB]	Result	
					[dBm]	[mW]
2412	-3.58	0.94	9.82	0.01	7.19	5.24
2437	-3.15	0.95	9.82	0.01	7.63	5.79
2462	-2.87	0.96	9.82	0.01	7.92	6.19

Sample Calculation:

Result = Reading + Cable Loss (including the cable(s) customer supplied) + Attenuator Loss + Duty Factor

**The average output power was measured with the lowest order modulation and lowest data rate configuration in each IEEE 802.11 mode based on KDB 248227 D01.**

**UL Japan, Inc.**

**Shonan EMC Lab.**

1-22-3 Megumigaoka, Hiratsuka-shi, Kanagawa-ken, 259-1220 JAPAN

Telephone : +81 463 50 6400

Facsimile : +81 463 50 6401

**Average Output Power**  
**(Reference data for RF Exposure)**

Report No. 12699044S-AJ-R1  
Test place Shonan EMC Lab. No.5 Shielded Room  
Date May 15, 2019  
Temperature / Humidity 24 deg. C / 51 % RH  
Engineer Kazuya Noda  
Mode Tx

**11n-20 CDD MCS 0**

Antenna A + Antenna B

Freq. [MHz]	Antenna A	Antenna B	Result (Burst Power Average)	
	Result [mW]	Result [mW]	[dBm]	[mW]
2412	5.43	5.31	10.31	10.74
2437	5.71	5.96	10.67	11.67
2462	5.89	6.58	10.96	12.47

Sample Calculation:

Result = Antenna A + Antenna B

Antenna A

Freq. [MHz]	Reading [dBm]	Cable Loss [dB]	Atten. Loss [dB]	Duty Factor [dB]	Result	
					[dBm]	[mW]
2412	-3.82	1.25	9.92	0.00	7.35	5.43
2437	-3.60	1.25	9.92	0.00	7.57	5.71
2462	-3.48	1.26	9.92	0.00	7.70	5.89

Antenna B

Freq. [MHz]	Reading [dBm]	Cable Loss [dB]	Atten. Loss [dB]	Duty Factor [dB]	Result	
					[dBm]	[mW]
2412	-3.51	0.94	9.82	0.00	7.25	5.31
2437	-3.02	0.95	9.82	0.00	7.75	5.96
2462	-2.60	0.96	9.82	0.00	8.18	6.58

Sample Calculation:

Result = Reading + Cable Loss (including the cable(s) customer supplied) + Attenuator Loss + Duty Factor

**11n-20 MIMO MCS 8**

Antenna A + Antenna B

Freq. [MHz]	Antenna A	Antenna B	Result (Burst Power Average)	
	Result [mW]	Result [mW]	[dBm]	[mW]
2412	5.37	5.32	10.29	10.69
2437	5.69	6.00	10.68	11.69
2462	5.83	6.44	10.89	12.28

Sample Calculation:

Result = Antenna A + Antenna B

Antenna A

Freq. [MHz]	Reading [dBm]	Cable Loss [dB]	Atten. Loss [dB]	Duty Factor [dB]	Result	
					[dBm]	[mW]
2412	-3.89	1.25	9.92	0.02	7.30	5.37
2437	-3.64	1.25	9.92	0.02	7.55	5.69
2462	-3.54	1.26	9.92	0.02	7.66	5.83

Antenna B

Freq. [MHz]	Reading [dBm]	Cable Loss [dB]	Atten. Loss [dB]	Duty Factor [dB]	Result	
					[dBm]	[mW]
2412	-3.52	0.94	9.82	0.02	7.26	5.32
2437	-3.01	0.95	9.82	0.02	7.78	6.00
2462	-2.71	0.96	9.82	0.02	8.09	6.44

Sample Calculation:

Result = Reading + Cable Loss (including the cable(s) customer supplied) + Attenuator Loss + Duty Factor

**The average output power was measured with the lowest order modulation and lowest data rate configuration in each IEEE 802.11 mode based on KDB 248227 D01.**

**UL Japan, Inc.**

**Shonan EMC Lab.**

1-22-3 Megumigaoka, Hiratsuka-shi, Kanagawa-ken, 259-1220 JAPAN

Telephone : +81 463 50 6400

Facsimile : +81 463 50 6401



**Average Output Power**  
**(Reference data for RF Exposure)**

Report No. 12699044S-AJ-R1  
Test place Shonan EMC Lab. No.5 Shielded Room  
Date May 15, 2019  
Temperature / Humidity 24 deg. C / 51 % RH  
Engineer Kazuya Noda  
Mode Tx

**11n-40 CDD MCS 0**

Antenna A + Antenna B

Freq. [MHz]	Antenna A	Antenna B	Result (Burst Power Average)	
	Result [mW]	Result [mW]	[dBm]	[mW]
2422	5.51	5.46	10.40	10.97
2437	5.65	5.82	10.60	11.47
2452	5.69	6.12	10.72	11.81

Sample Calculation:

Result = Antenna A + Antenna B

Antenna A

Freq. [MHz]	Reading [dBm]	Cable Loss [dB]	Atten. Loss [dB]	Duty Factor [dB]	Result	
					[dBm]	[mW]
2422	-3.78	1.25	9.92	0.02	7.41	5.51
2437	-3.67	1.25	9.92	0.02	7.52	5.65
2452	-3.64	1.25	9.92	0.02	7.55	5.69

Antenna B

Freq. [MHz]	Reading [dBm]	Cable Loss [dB]	Atten. Loss [dB]	Duty Factor [dB]	Result	
					[dBm]	[mW]
2422	-3.41	0.94	9.82	0.02	7.37	5.46
2437	-3.14	0.95	9.82	0.02	7.65	5.82
2452	-2.92	0.95	9.82	0.02	7.87	6.12

Sample Calculation:

Result = Reading + Cable Loss (including the cable(s) customer supplied) + Attenuator Loss + Duty Factor

**11n-40 MIMO MCS 8**

Antenna A + Antenna B

Freq. [MHz]	Antenna A	Antenna B	Result (Burst Power Average)	
	Result [mW]	Result [mW]	[dBm]	[mW]
2422	5.50	5.53	10.43	11.03
2437	5.66	5.96	10.65	11.62
2452	5.74	6.32	10.82	12.07

Sample Calculation:

Result = Antenna A + Antenna B

Antenna A

Freq. [MHz]	Reading [dBm]	Cable Loss [dB]	Atten. Loss [dB]	Duty Factor [dB]	Result	
					[dBm]	[mW]
2422	-3.81	1.25	9.92	0.04	7.40	5.50
2437	-3.68	1.25	9.92	0.04	7.53	5.66
2452	-3.62	1.25	9.92	0.04	7.59	5.74

Antenna B

Freq. [MHz]	Reading [dBm]	Cable Loss [dB]	Atten. Loss [dB]	Duty Factor [dB]	Result	
					[dBm]	[mW]
2422	-3.37	0.94	9.82	0.04	7.43	5.53
2437	-3.06	0.95	9.82	0.04	7.75	5.96
2452	-2.80	0.95	9.82	0.04	8.01	6.32

Sample Calculation:

Result = Reading + Cable Loss (including the cable(s) customer supplied) + Attenuator Loss + Duty Factor

**The average output power was measured with the lowest order modulation and lowest data rate configuration in each IEEE 802.11 mode based on KDB 248227 D01.**

**UL Japan, Inc.**

**Shonan EMC Lab.**

1-22-3 Megumigaoka, Hiratsuka-shi, Kanagawa-ken, 259-1220 JAPAN

Telephone : +81 463 50 6400

Facsimile : +81 463 50 6401

**Burst rate confirmation (for Average Output Power)**

Report No. 12699044S-AJ-R1  
 Test place Shonan EMC Lab. No.5 Shielded Room  
 Date June 3, 2019  
 Temperature / Humidity 25 deg. C / 42 % RH  
 Engineer Yosuke Ishikawa  
 Mode Tx

**11b 1 Mbps**

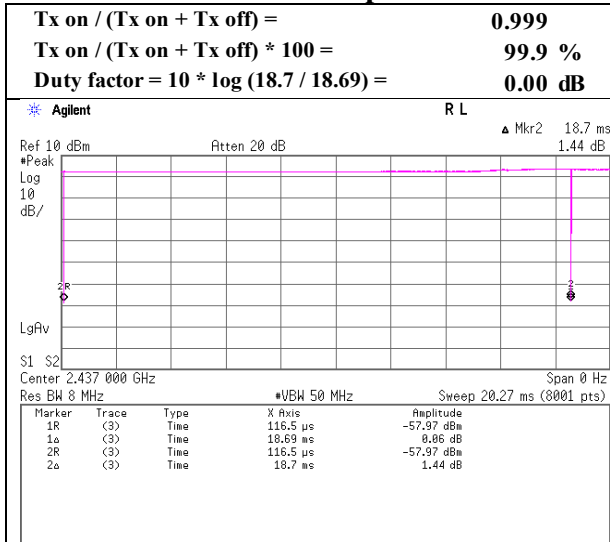

**11g 6 Mbps**

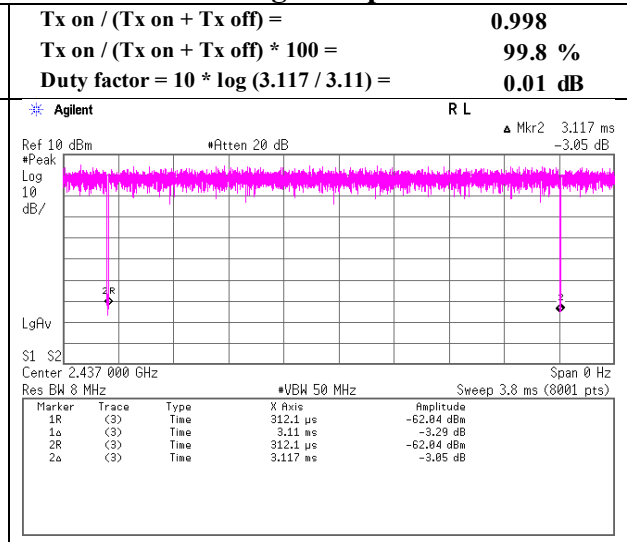

**11n-20 CDD MCS 0**

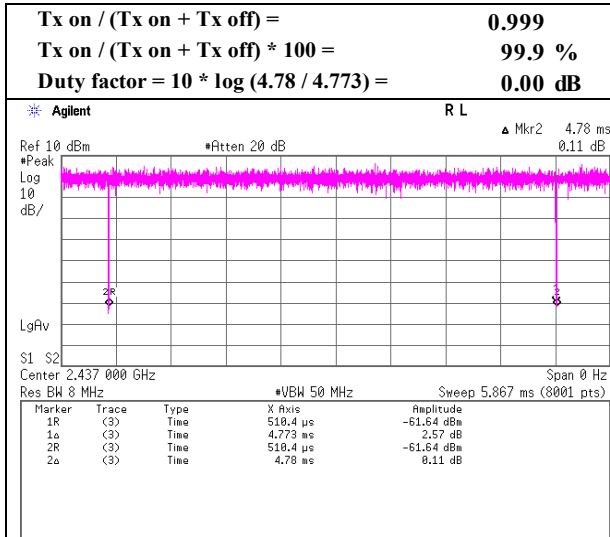

**11n-20 MIMO MCS 8**

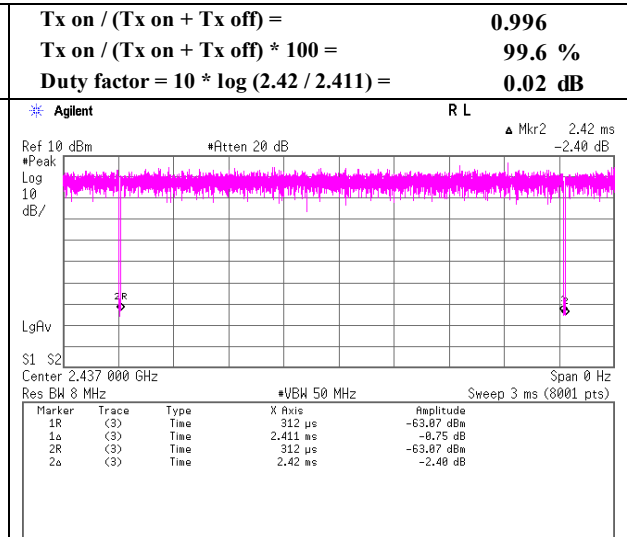

**Burst rate confirmation (for Average Output Power)**

Report No. 12699044S-AJ-R1  
 Test place Shonan EMC Lab. No.5 Shielded Room  
 Date June 3, 2019  
 Temperature / Humidity 25 deg. C / 42 % RH  
 Engineer Yosuke Ishikawa  
 Mode Tx

**11n-40 CDD MCS 0**

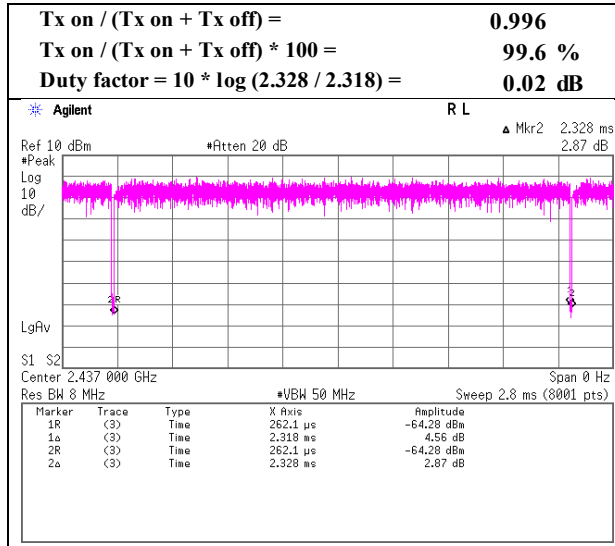

**11n-40 MIMO MCS 8**

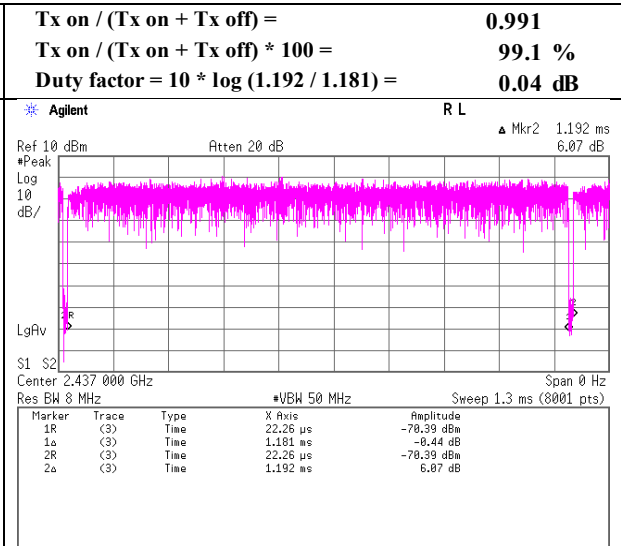

\* Since the burst rate is not different between the channels, the data has been obtained on the representative channel.

### Burst rate confirmation (for Radiated Spurious Emission)

Report No. 12699044S-AJ-R1  
 Test place Shonan EMC Lab. No.5 Shielded Room  
 Date June 3, 2019  
 Temperature / Humidity 25 deg. C / 42 % RH  
 Engineer Yosuke Ishikawa  
 Mode Tx

#### 11b 11 Mbps

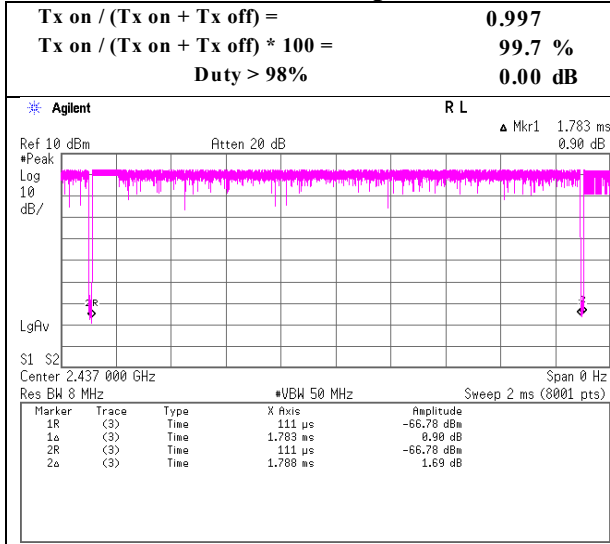

#### 11g 48 Mbps

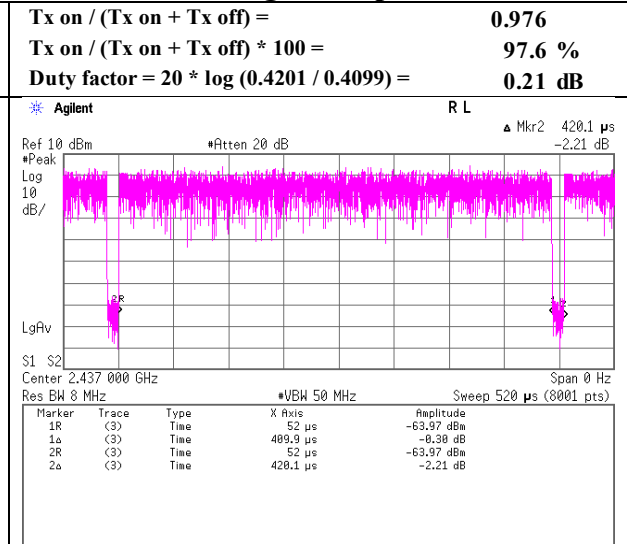

#### 11n-20 CDD MCS 2

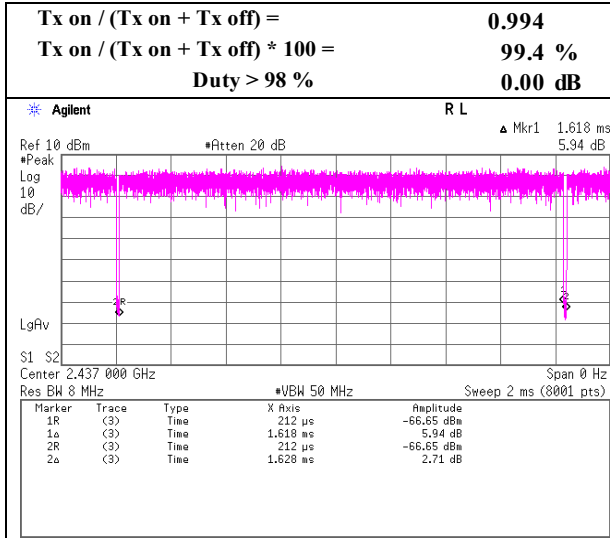

#### 11n-20 MIMO MCS 14

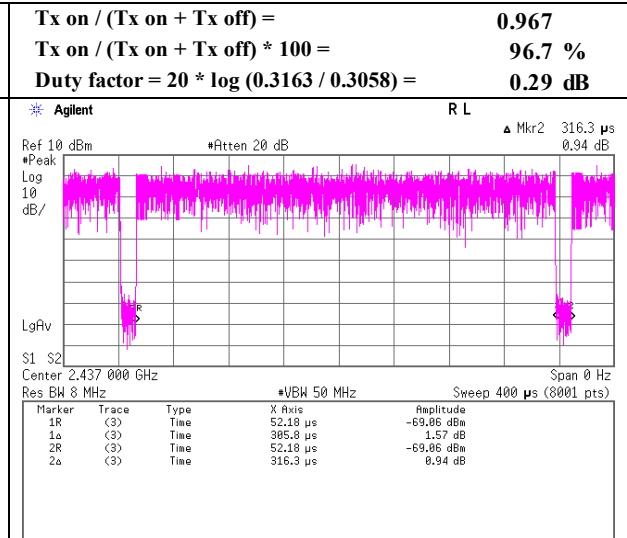

**Burst rate confirmation (for Radiated Spurious Emission)**

Report No. 12699044S-AJ-R1  
 Test place Shonan EMC Lab. No.5 Shielded Room  
 Date June 3, 2019  
 Temperature / Humidity 25 deg. C / 42 % RH  
 Engineer Yosuke Ishikawa  
 Mode Tx

**11n-40 CDD MCS 0**

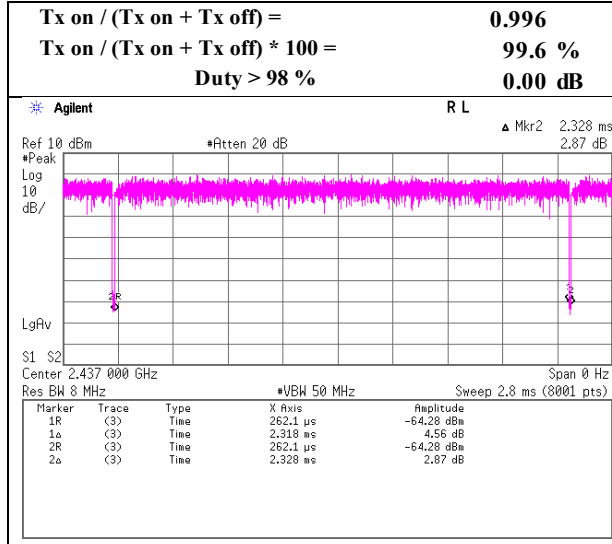

**11n-40 MIMO MCS 9**

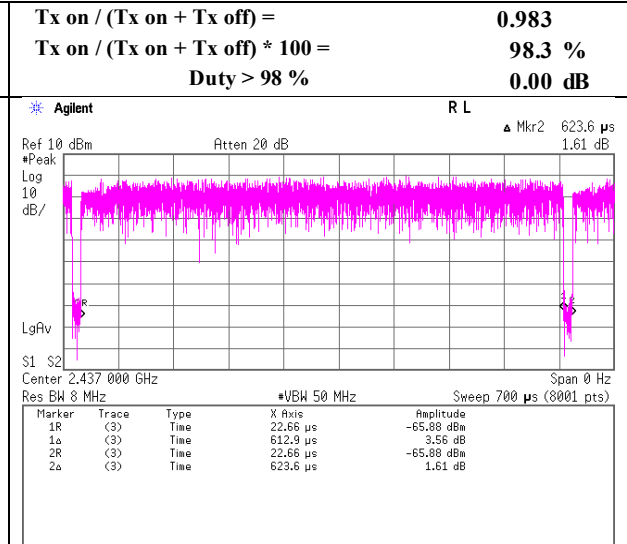

\* Since the burst rate is not different between the channels, the data has been obtained on the representative channel.

## Radiated Spurious Emission

Report No. 12699044S-AJ-R1  
Test place Shonan EMC Lab.  
Semi Anechoic Chamber No.3

Date	June 3, 2019	February 9, 2019	February 10, 2019	February 11, 2019
Temperature / Humidity	26 deg. C / 54 % RH	23 deg. C / 38 % RH	21 deg. C / 36 % RH	20 deg. C / 35 % RH
Engineer	Hiomasa Sato	Takahiro Suzuki	Makoto Hosaka	Yasumasa Owaki
	(1 GHz - 2.8 GHz)	(2.8 GHz - 13 GHz)	(13 GHz - 18 GHz)	(18 GHz - 26.5 GHz)
Mode	Tx 11b 2412 MHz			

(\* PK: Peak, AV: Average, QP: Quasi-Peak)

Polarity	Frequency [MHz]	Detector	Reading [dBuV]	Ant.Fac. [dB/m]	Loss [dB]	Gain [dB]	Distance Factor [dB]	Result [dBuV/m]	Limit [dBuV/m]	Margin [dB]	Height [cm]	Angle [deg]	Remark
Hori.	2390.000	PK	48.49	27.86	13.56	41.59	2.48	50.80	73.9	23.1	393	115	
Hori.	4824.000	PK	55.87	31.46	6.46	42.88	2.48	53.39	73.9	20.5	131	120	
Hori.	7236.000	PK	49.69	36.85	8.13	42.98	2.48	54.17	73.9	19.7	125	39	
Hori.	9648.000	PK	48.71	38.64	9.30	43.13	2.48	56.00	73.9	17.9	133	116	
Hori.	12060.000	PK	48.67	39.27	10.66	42.27	2.48	58.81	73.9	15.0	293	125	
Hori.	19296.000	PK	47.44	40.30	12.30	45.31	-9.54	45.19	73.9	28.7	140	33	
Hori.	21708.000	PK	51.22	40.16	13.11	46.69	-9.54	48.26	73.9	25.6	137	36	
Hori.	24120.000	PK	48.77	39.90	13.98	48.67	-9.54	44.44	73.9	29.4	140	301	
Hori.	2390.000	AV	38.10	27.86	13.56	41.59	2.48	40.41	53.9	13.4	393	115	
Hori.	4824.000	AV	44.14	31.46	6.46	42.88	2.48	41.66	53.9	12.2	131	120	
Hori.	7236.000	AV	41.97	36.85	8.13	42.98	2.48	46.45	53.9	7.4	125	39	
Hori.	9648.000	AV	40.34	38.64	9.30	43.13	2.48	47.63	53.9	6.2	133	116	
Hori.	12060.000	AV	38.72	39.27	10.66	42.27	2.48	48.86	53.9	5.0	293	125	
Hori.	19296.000	AV	41.11	40.30	12.30	45.31	-9.54	38.86	53.9	15.0	140	33	
Hori.	21708.000	AV	42.22	40.16	13.11	46.69	-9.54	39.26	53.9	14.6	137	36	
Hori.	24120.000	AV	38.81	39.90	13.98	48.67	-9.54	34.48	53.9	19.4	140	301	
Vert.	2390.000	PK	48.93	27.86	13.56	41.59	2.48	51.24	73.9	22.6	206	274	
Vert.	4824.000	PK	54.16	31.46	6.46	42.88	2.48	51.68	73.9	22.2	155	74	
Vert.	7236.000	PK	51.60	36.85	8.13	42.98	2.48	56.08	73.9	17.8	101	355	
Vert.	9648.000	PK	48.97	38.64	9.30	43.13	2.48	56.26	73.9	17.6	262	66	
Vert.	12060.000	PK	48.14	39.27	10.66	42.27	2.48	58.28	73.9	15.6	148	234	
Vert.	19296.000	PK	47.51	40.30	12.30	45.31	-9.54	45.26	73.9	28.6	138	56	
Vert.	21708.000	PK	49.86	40.16	13.11	46.69	-9.54	46.90	73.9	27.0	142	76	
Vert.	24120.000	PK	45.31	39.90	13.98	48.67	-9.54	40.98	73.9	32.9	138	343	
Vert.	2390.000	AV	39.63	27.86	13.56	41.59	2.48	41.94	53.9	11.9	206	274	
Vert.	4824.000	AV	43.14	31.46	6.46	42.88	2.48	40.66	53.9	13.2	155	74	
Vert.	7236.000	AV	41.83	36.85	8.13	42.98	2.48	46.31	53.9	7.5	101	355	
Vert.	9648.000	AV	39.65	38.64	9.30	43.13	2.48	46.94	53.9	6.9	262	66	
Vert.	12060.000	AV	38.82	39.27	10.66	42.27	2.48	48.96	53.9	4.9	148	234	
Vert.	19296.000	AV	40.25	40.30	12.30	45.31	-9.54	38.00	53.9	15.9	138	56	
Vert.	21708.000	AV	40.17	40.16	13.11	46.69	-9.54	37.21	53.9	16.6	142	76	
Vert.	24120.000	AV	35.66	39.90	13.98	48.67	-9.54	31.33	53.9	22.5	138	343	

Result = Reading + Ant.Fac. + Loss (Cable+(Attenuator or Filter)(below 18 GHz)) - Gain(Amplifier) + Distance factor

Distance factor : 1 GHz - 13 GHz : 20log(3.99 m / 3.0 m) = 2.48 dB

13 GHz - 40 GHz : 20log(1.0 m / 3.0 m) = -9.54 dB

### 20 dBc Data Sheet (RBW 100 kHz, VBW 300 kHz)

Polarity	Frequency [MHz]	Detector	Reading [dBuV]	Ant.Fac. [dB/m]	Loss [dB]	Gain [dB]	Distance Factor [dB]	Result [dBuV/m]	Limit [dBuV/m]	Margin [dB]	Remark
Hori.	2412.000	PK	90.53	27.85	13.57	41.60	2.48	92.83	-	-	Carrier
Hori.	2396.950	PK	41.07	27.86	13.56	41.59	2.48	43.38	72.83	29.4	
Hori.	2400.000	PK	41.06	27.86	13.57	41.60	2.48	43.37	72.83	29.4	
Vert.	2412.000	PK	91.12	27.85	13.57	41.60	2.48	93.42	-	-	Carrier
Vert.	2397.210	PK	40.99	27.86	13.56	41.60	2.48	43.29	73.42	30.1	
Vert.	2400.000	PK	41.25	27.86	13.57	41.60	2.48	43.56	73.42	29.8	

Result = Reading + Ant.Fac. + Loss (Cable+(Attenuator or Filter)(below 18 GHz)) - Gain(Amplifier) + Distance factor

Distance factor : 1 GHz - 13 GHz : 20log(3.99 m / 3.0 m) = 2.48 dB

13 GHz - 40 GHz : 20log(1.0 m / 3.0 m) = -9.54 dB

**UL Japan, Inc.**

**Shonan EMC Lab.**

1-22-3 Megumigaoka, Hiratsuka-shi, Kanagawa-ken, 259-1220 JAPAN

Telephone : +81 463 50 6400

Facsimile : +81 463 50 6401

**Radiated Spurious Emission**  
**(Reference Plot for band-edge)**

Report No. 12699044S-AJ-R1  
Test place Shonan EMC Lab.  
Semi Anechoic Chamber No.3  
Date June 3, 2019  
Temperature / Humidity 26 deg. C / 54 % RH  
Engineer Hiromasa Sato  
(1 GHz - 2.8 GHz)  
Mode Tx 11b 2412 MHz

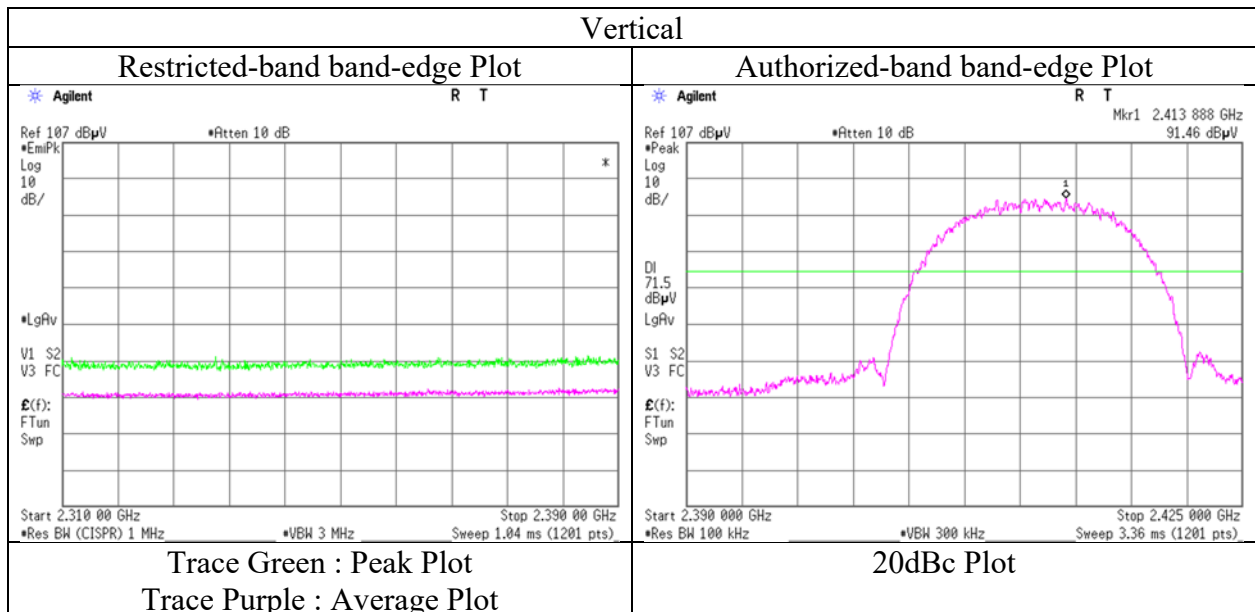
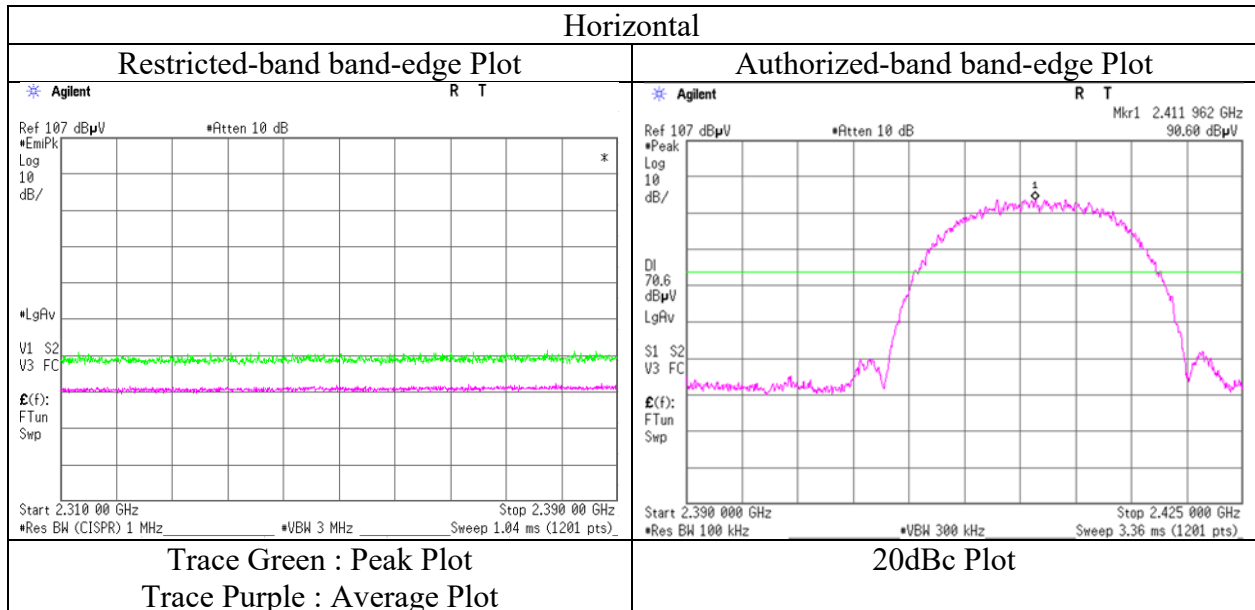

\* The measurement was conducted for a sufficiently long enough time to detect any possible spurious emissions. Final result of restricted band edge was shown in tabular data.

## Radiated Spurious Emission

Report No. 12699044S-AJ-R1  
Test place Shonan EMC Lab.  
Semi Anechoic Chamber No.3  
Date June 3, 2019 February 9, 2019 February 10, 2019 February 11, 2019  
Temperature / Humidity 26 deg. C / 54 % RH 23 deg. C / 38 % RH 21 deg. C / 36 % RH 20 deg. C / 35 % RH  
Engineer Hiromasa Sato Takahiro Suzuki Makoto Hosaka Yasumasa Owaki  
(1 GHz - 2.8 GHz) (2.8 GHz - 13 GHz) (13 GHz - 18 GHz) (18 GHz - 26.5 GHz)  
Mode Tx 11b 2437 MHz

(\* PK: Peak, AV: Average, QP: Quasi-Peak)

Polarity	Frequency [MHz]	Detector	Reading [dBuV]	Ant.Fac. [dB/m]	Loss [dB]	Gain [dB]	Distance Factor [dB]	Result [dBuV/m]	Limit [dBuV/m]	Margin [dB]	Height [cm]	Angle [deg]	Remark
Hori.	4874.000	PK	53.68	31.40	7.33	42.89	2.48	52.00	73.9	21.9	175	87	
Hori.	7311.000	PK	49.18	36.99	8.13	43.13	2.48	53.65	73.9	20.2	133	74	
Hori.	9748.000	PK	48.32	38.92	10.47	43.02	2.48	57.17	73.9	16.7	359	133	
Hori.	12185.000	PK	46.36	39.26	11.72	42.20	2.48	57.62	73.9	16.2	310	112	
Hori.	19496.000	PK	46.94	40.18	12.47	45.24	-9.54	44.81	73.9	29.0	139	318	
Hori.	21933.000	PK	49.43	40.19	13.21	46.91	-9.54	46.38	73.9	27.5	134	49	
Hori.	24370.000	PK	48.18	39.97	14.15	48.74	-9.54	44.02	73.9	29.8	145	300	
Hori.	4874.000	AV	46.89	31.40	7.33	42.89	2.48	45.21	53.9	8.6	175	87	
Hori.	7311.000	AV	40.88	36.99	8.13	43.13	2.48	45.35	53.9	8.5	133	74	
Hori.	9748.000	AV	42.21	38.92	10.47	43.02	2.48	51.06	53.9	2.8	359	133	
Hori.	12185.000	AV	38.03	39.26	11.72	42.20	2.48	49.29	53.9	4.6	310	112	
Hori.	19496.000	AV	39.32	40.18	12.47	45.24	-9.54	37.19	53.9	16.7	139	318	
Hori.	21933.000	AV	39.97	40.19	13.21	46.91	-9.54	36.92	53.9	16.9	134	49	
Hori.	24370.000	AV	37.69	39.97	14.15	48.74	-9.54	33.53	53.9	20.3	145	300	
Vert.	4874.000	PK	53.27	31.40	7.33	42.89	2.48	51.59	73.9	22.3	164	88	
Vert.	7311.000	PK	50.25	36.99	8.13	43.13	2.48	54.72	73.9	19.1	102	355	
Vert.	9748.000	PK	48.35	38.92	10.47	43.02	2.48	57.20	73.9	16.7	100	32	
Vert.	12185.000	PK	45.37	39.26	11.72	42.20	2.48	56.63	73.9	17.2	100	331	
Vert.	19496.000	PK	49.03	40.18	12.47	45.24	-9.54	46.90	73.9	27.0	135	332	
Vert.	21933.000	PK	48.26	40.19	13.21	46.91	-9.54	45.21	73.9	28.6	143	77	
Vert.	24370.000	PK	45.80	39.97	14.15	48.74	-9.54	41.64	73.9	32.2	137	350	
Vert.	4874.000	AV	44.91	31.40	7.33	42.89	2.48	43.23	53.9	10.6	164	88	
Vert.	7311.000	AV	41.00	36.99	8.13	43.13	2.48	45.47	53.9	8.4	102	355	
Vert.	9748.000	AV	40.27	38.92	10.47	43.02	2.48	49.12	53.9	4.7	100	32	
Vert.	12185.000	AV	37.11	39.26	11.72	42.20	2.48	48.37	53.9	5.5	100	331	
Vert.	19496.000	AV	43.28	40.18	12.47	45.24	-9.54	41.15	53.9	12.7	135	332	
Vert.	21933.000	AV	39.64	40.19	13.21	46.91	-9.54	36.59	53.9	17.3	143	77	
Vert.	24370.000	AV	35.25	39.97	14.15	48.74	-9.54	31.09	53.9	22.8	137	350	

Result = Reading + Ant.Fac. + Loss (Cable+(Attenuator or Filter)(below 18 GHz)) - Gain(Amplifier) + Distance factor

Distance factor : 1 GHz - 13 GHz : 20log(3.99 m / 3.0 m) = 2.48 dB

13 GHz - 40 GHz : 20log(1.0 m / 3.0 m) = -9.54 dB

**UL Japan, Inc.**

**Shonan EMC Lab.**

1-22-3 Megumigaoka, Hiratsuka-shi, Kanagawa-ken, 259-1220 JAPAN

Telephone : +81 463 50 6400

Facsimile : +81 463 50 6401



## Radiated Spurious Emission

Report No. 12699044S-AJ-R1  
Test place Shonan EMC Lab.  
Semi Anechoic Chamber No.3  
Date June 3, 2019 February 9, 2019 February 10, 2019 February 11, 2019  
Temperature / Humidity 26 deg. C / 54 % RH 23 deg. C / 38 % RH 21 deg. C / 36 % RH 20 deg. C / 35 % RH  
Engineer Hiromasa Sato Takahiro Suzuki Makoto Hosaka Yasumasa Owaki  
(1 GHz - 2.8 GHz) (2.8 GHz - 13 GHz) (13 GHz - 18 GHz) (18 GHz - 26.5 GHz)  
Mode Tx 11b 2462 MHz

(\* PK: Peak, AV: Average, QP: Quasi-Peak)

Polarity	Frequency [MHz]	Detector	Reading [dBuV]	Ant.Fac. [dB/m]	Loss [dB]	Gain [dB]	Distance Factor [dB]	Result [dBuV/m]	Limit [dBuV/m]	Margin [dB]	Height [cm]	Angle [deg]	Remark
Hori.	2483.500	PK	48.46	27.65	13.63	41.62	2.48	50.60	73.9	23.3	237	81	
Hori.	4924.000	PK	53.07	31.37	7.36	42.90	2.48	51.38	73.9	22.5	100	332	
Hori.	7386.000	PK	51.16	37.01	8.14	43.28	2.48	55.51	73.9	18.3	178	64	
Hori.	9848.000	PK	48.86	39.12	10.41	42.92	2.48	57.95	73.9	15.9	100	54	
Hori.	12310.000	PK	48.93	38.94	11.76	42.13	2.48	59.98	73.9	13.9	100	23	
Hori.	19696.000	PK	49.09	40.12	12.49	45.32	-9.54	46.84	73.9	27.0	145	315	
Hori.	22158.000	PK	50.03	40.18	13.35	47.20	-9.54	46.82	73.9	27.0	137	38	
Hori.	24620.000	PK	51.11	40.01	14.25	48.74	-9.54	47.09	73.9	26.8	139	300	
Hori.	2483.500	AV	39.64	27.65	13.63	41.62	2.48	41.78	53.9	12.1	237	81	
Hori.	4924.000	AV	42.96	31.37	7.36	42.90	2.48	41.27	53.9	12.6	100	332	
Hori.	7386.000	AV	42.57	37.01	8.14	43.28	2.48	46.92	53.9	6.9	178	64	
Hori.	9848.000	AV	39.96	39.12	10.41	42.92	2.48	49.05	53.9	4.8	100	54	
Hori.	12310.000	AV	39.05	38.94	11.76	42.13	2.48	50.10	53.9	3.8	100	23	
Hori.	19696.000	AV	42.43	40.12	12.49	45.32	-9.54	40.18	53.9	13.7	145	315	
Hori.	22158.000	AV	40.82	40.18	13.35	47.20	-9.54	37.61	53.9	16.2	137	38	
Hori.	24620.000	AV	40.58	40.01	14.25	48.74	-9.54	36.56	53.9	17.3	139	300	
Vert.	2483.500	PK	48.75	27.65	13.63	41.62	2.48	50.89	73.9	23.0	392	43	
Vert.	4924.000	PK	53.14	31.37	7.36	42.90	2.48	51.45	73.9	22.4	124	275	
Vert.	7386.000	PK	50.84	37.01	8.14	43.28	2.48	55.19	73.9	18.7	122	13	
Vert.	9848.000	PK	49.42	39.12	10.41	42.92	2.48	58.51	73.9	15.3	100	34	
Vert.	12310.000	PK	47.02	38.94	11.76	42.13	2.48	58.07	73.9	15.8	247	322	
Vert.	19696.000	PK	47.20	40.12	12.49	45.32	-9.54	44.95	73.9	28.9	164	354	
Vert.	22158.000	PK	47.42	40.18	13.35	47.20	-9.54	44.21	73.9	29.6	133	76	
Vert.	24620.000	PK	46.47	40.01	14.25	48.74	-9.54	42.45	73.9	31.4	149	163	
Vert.	2483.500	AV	39.79	27.65	13.63	41.62	2.48	41.93	53.9	11.9	392	43	
Vert.	4924.000	AV	43.13	31.37	7.36	42.90	2.48	41.44	53.9	12.4	124	275	
Vert.	7386.000	AV	42.58	37.01	8.14	43.28	2.48	46.93	53.9	6.9	122	13	
Vert.	9848.000	AV	41.26	39.12	10.41	42.92	2.48	50.35	53.9	3.5	100	34	
Vert.	12310.000	AV	38.29	38.94	11.76	42.13	2.48	49.34	53.9	4.5	247	322	
Vert.	19696.000	AV	41.14	40.12	12.49	45.32	-9.54	38.89	53.9	15.0	164	354	
Vert.	22158.000	AV	37.93	40.18	13.35	47.20	-9.54	34.72	53.9	19.1	133	76	
Vert.	24620.000	AV	36.58	40.01	14.25	48.74	-9.54	32.56	53.9	21.3	149	163	

Result = Reading + Ant.Fac. + Loss (Cable+(Attenuator or Filter)(below 18 GHz)) - Gain(Amplifier) + Distance factor

Distance factor : 1 GHz - 13 GHz : 20log(3.99 m / 3.0 m) = 2.48 dB

13 GHz - 40 GHz : 20log(1.0 m / 3.0 m) = -9.54 dB

**UL Japan, Inc.**

**Shonan EMC Lab.**

1-22-3 Megumigaoka, Hiratsuka-shi, Kanagawa-ken, 259-1220 JAPAN

Telephone : +81 463 50 6400

Facsimile : +81 463 50 6401

**Radiated Spurious Emission**  
**(Reference Plot for band-edge)**

Report No. 12699044S-AJ-R1  
Test place Shonan EMC Lab.  
Semi Anechoic Chamber No.3  
Date June 3, 2019  
Temperature / Humidity 26 deg. C / 54 % RH  
Engineer Hiromasa Sato  
(1 GHz - 2.8 GHz)  
Mode Tx 11b 2462 MHz

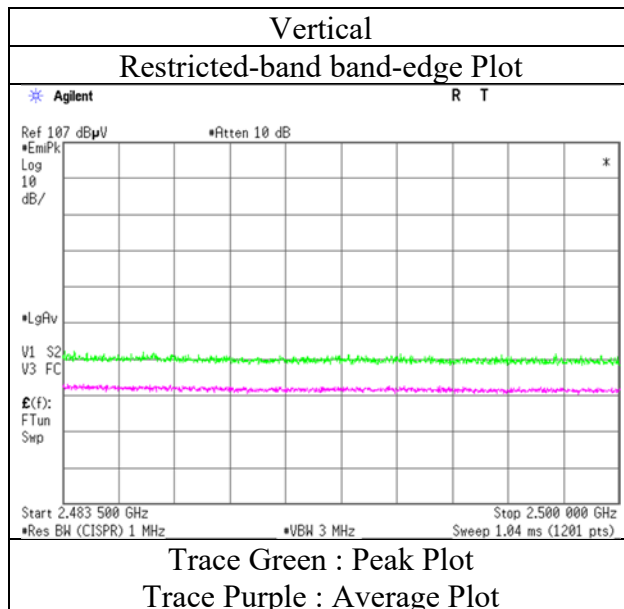
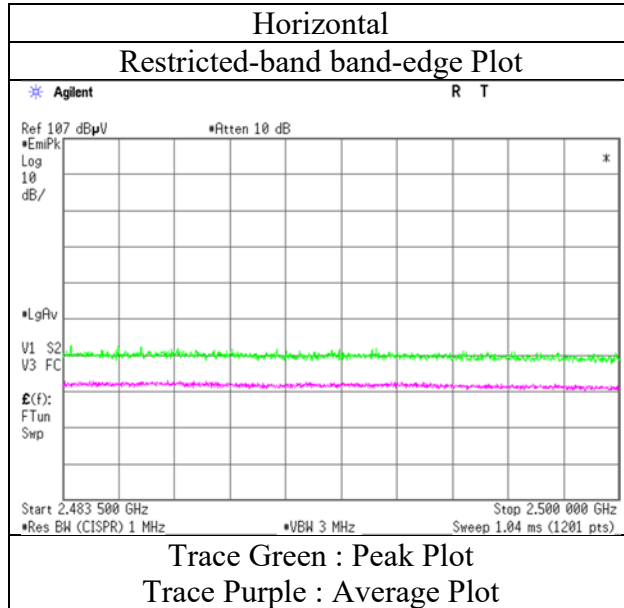

\* The measurement was conducted for a sufficiently long enough time to detect any possible spurious emissions. Final result of restricted band edge was shown in tabular data.

## Radiated Spurious Emission

Report No. 12699044S-AJ-R1  
Test place Shonan EMC Lab.  
Semi Anechoic Chamber No.3

Date June 3, 2019 February 9, 2019 February 10, 2019 February 7, 2019  
Temperature / Humidity 26 deg. C / 54 % RH 23 deg. C / 38 % RH 21 deg. C / 36 % RH 23 deg. C / 31 % RH  
Engineer Hiromasa Sato Takahiro Suzuki Makoto Hosaka Makoto Hosaka  
(1 GHz - 2.8 GHz) (2.8 GHz - 13 GHz) (13 GHz - 18 GHz) (18 GHz - 26.5 GHz)

Mode Tx 11g 2412 MHz

(\* PK: Peak, AV: Average, QP: Quasi-Peak)

Polarity	Frequency [MHz]	Detector	Reading [dBuV]	Ant.Fac. [dB/m]	Loss [dB]	Gain [dB]	Distance Factor [dB]	Result [dBuV/m]	Limit [dBuV/m]	Margin [dB]	Height [cm]	Angle [deg]	Remark
Hori.	2389.703	PK	55.38	27.86	13.56	41.59	2.48	57.69	73.9	16.2	131	66	
Hori.	2390.000	PK	54.93	27.86	13.56	41.59	2.48	57.24	73.9	16.6	131	66	
Hori.	4824.000	PK	53.79	31.46	7.30	42.88	2.48	52.15	73.9	21.7	117	58	
Hori.	7236.000	PK	49.86	36.85	8.13	42.98	2.48	54.34	73.9	19.5	112	60	
Hori.	9648.000	PK	49.18	38.64	10.53	43.13	2.48	57.70	73.9	16.2	140	306	
Hori.	12060.000	PK	48.32	39.27	11.68	42.27	2.48	59.48	73.9	14.4	100	85	
Hori.	19296.000	PK	42.62	40.30	12.30	45.31	-9.54	40.37	73.9	33.5	145	320	
Hori.	21708.000	PK	47.45	40.16	13.11	46.69	-9.54	44.49	73.9	29.4	133	62	
Hori.	24120.000	PK	44.49	39.90	13.98	48.67	-9.54	40.16	73.9	33.7	150	0	
Vert.	2389.671	PK	56.02	27.86	13.56	41.59	2.48	58.33	73.9	15.5	147	53	
Vert.	2390.000	PK	56.55	27.86	13.56	41.59	2.48	58.86	73.9	15.0	147	53	
Vert.	4824.000	PK	54.25	31.46	7.30	42.88	2.48	52.61	73.9	21.2	135	176	
Vert.	7236.000	PK	50.34	36.85	8.13	42.98	2.48	54.82	73.9	19.0	103	3	
Vert.	9648.000	PK	50.33	38.64	10.53	43.13	2.48	58.85	73.9	15.0	259	159	
Vert.	12060.000	PK	49.91	39.27	11.68	42.27	2.48	61.07	73.9	12.8	168	324	
Vert.	19296.000	PK	44.21	40.30	12.30	45.31	-9.54	41.96	73.9	31.9	135	11	
Vert.	21708.000	PK	48.75	40.16	13.11	46.69	-9.54	45.79	73.9	28.1	144	78	
Vert.	24120.000	PK	45.94	39.90	13.98	48.67	-9.54	41.61	73.9	32.2	127	351	

Result = Reading + Ant.Fac. + Loss (Cable+(Attenuator or Filter)(below 18 GHz)) - Gain(Amplifier) + Distance factor

Distance factor : 1 GHz - 13 GHz : 20log(3.99 m / 3.0 m) = 2.48 dB

13 GHz - 40 GHz : 20log(1.0 m / 3.0 m) = -9.54 dB

### Average measurement value with duty factor

Polarity	Frequency [MHz]	Detector	Reading [dBuV]	Ant.Fac. [dB/m]	Loss [dB]	Gain [dB]	Duty Factor [dB]	Distance Factor [dB]	Result [dBuV/m]	Limit [dBuV/m]	Margin [dB]	Remark
Hori.	2389.703	AV	40.90	27.86	13.56	41.59	0.21	2.48	43.42	53.9	10.4	
Hori.	2390.000	AV	40.79	27.86	13.56	41.59	0.21	2.48	43.31	53.9	10.5	*1)
Hori.	4824.000	AV	44.24	31.46	7.30	42.88	0.21	2.48	42.81	53.9	11.0	
Hori.	7236.000	AV	41.51	36.85	8.13	42.98	0.21	2.48	46.20	53.9	7.7	
Hori.	9648.000	AV	39.95	38.64	10.53	43.13	0.21	2.48	48.68	53.9	5.2	
Hori.	12060.000	AV	38.32	39.27	11.68	42.27	0.21	2.48	49.69	53.9	4.2	
Hori.	19296.000	AV	34.54	40.30	12.30	45.31	0.21	-9.54	32.50	53.9	21.4	
Hori.	21708.000	AV	37.34	40.16	13.11	46.69	0.21	-9.54	34.59	53.9	19.3	
Hori.	24120.000	AV	35.24	39.90	13.98	48.67	0.21	-9.54	31.12	53.9	22.7	
Vert.	2389.671	AV	40.61	27.86	13.56	41.59	0.21	2.48	43.13	53.9	10.7	
Vert.	2390.000	AV	40.75	27.86	13.56	41.59	0.21	2.48	43.27	53.9	10.6	*1)
Vert.	4824.000	AV	43.97	31.46	7.30	42.88	0.21	2.48	42.54	53.9	11.3	
Vert.	7236.000	AV	41.64	36.85	8.13	42.98	0.21	2.48	46.33	53.9	7.5	
Vert.	9648.000	AV	40.42	38.64	10.53	43.13	0.21	2.48	49.15	53.9	4.7	
Vert.	12060.000	AV	38.51	39.27	11.68	42.27	0.21	2.48	49.88	53.9	4.0	
Vert.	19296.000	AV	35.22	40.30	12.30	45.31	0.21	-9.54	33.18	53.9	20.7	
Vert.	21708.000	AV	37.83	40.16	13.11	46.69	0.21	-9.54	35.08	53.9	18.8	
Vert.	24120.000	AV	35.95	39.90	13.98	48.67	0.21	-9.54	31.83	53.9	22.0	

Result = Reading + Ant.Fac. + Loss (Cable+(Attenuator or Filter)(below 18 GHz)) - Gain(Amplifier) + Duty factor + Distance factor

Distance factor : 1 GHz - 13 GHz : 20log(3.99 m / 3.0 m) = 2.48 dB

13 GHz - 40 GHz : 20log(1.0 m / 3.0 m) = -9.54 dB

Duty factor refer to "Duty factor Calculation chart" sheet.

\*1) Not out of band emission (Leakage Power)

### 20 dBc Data Sheet (RBW 100 kHz, VBW 300 kHz)

Polarity	Frequency [MHz]	Detector	Reading [dBuV]	Ant.Fac. [dB/m]	Loss [dB]	Gain [dB]	Distance Factor [dB]	Result [dBuV/m]	Limit [dBuV/m]	Margin [dB]	Remark
Hori.	2412.000	PK	89.78	27.85	13.57	41.60	2.48	92.08	-	-	Carrier
Hori.	2398.636	PK	45.78	27.86	13.56	41.60	2.48	48.08	72.08	24.0	
Hori.	2400.000	PK	49.52	27.86	13.57	41.60	2.48	51.83	72.08	20.2	
Vert.	2412.000	PK	90.14	27.85	13.57	41.60	2.48	92.44	-	-	Carrier
Vert.	2395.341	PK	45.18	27.86	13.56	41.59	2.48	47.49	72.44	24.9	
Vert.	2400.000	PK	49.86	27.86	13.57	41.60	2.48	52.17	72.44	20.2	

Result = Reading + Ant.Fac. + Loss (Cable+(Attenuator or Filter)(below 18 GHz)) - Gain(Amplifier) + Distance factor

Distance factor : 1 GHz - 13 GHz : 20log(3.99 m / 3.0 m) = 2.48 dB

13 GHz - 40 GHz : 20log(1.0 m / 3.0 m) = -9.54 dB

**UL Japan, Inc.**

**Shonan EMC Lab.**

1-22-3 Megumigaoka, Hiratsuka-shi, Kanagawa-ken, 259-1220 JAPAN

Telephone : +81 463 50 6400

Facsimile : +81 463 50 6401

## Radiated Spurious Emission (Reference Plot for band-edge)

Report No. 12699044S-AJ-R1  
Test place Shonan EMC Lab.  
Semi Anechoic Chamber No.3  
Date June 3, 2019  
Temperature / Humidity 26 deg. C / 54 % RH  
Engineer Hiromasa Sato  
(1 GHz - 2.8 GHz)  
Mode Tx 11g 2412 MHz

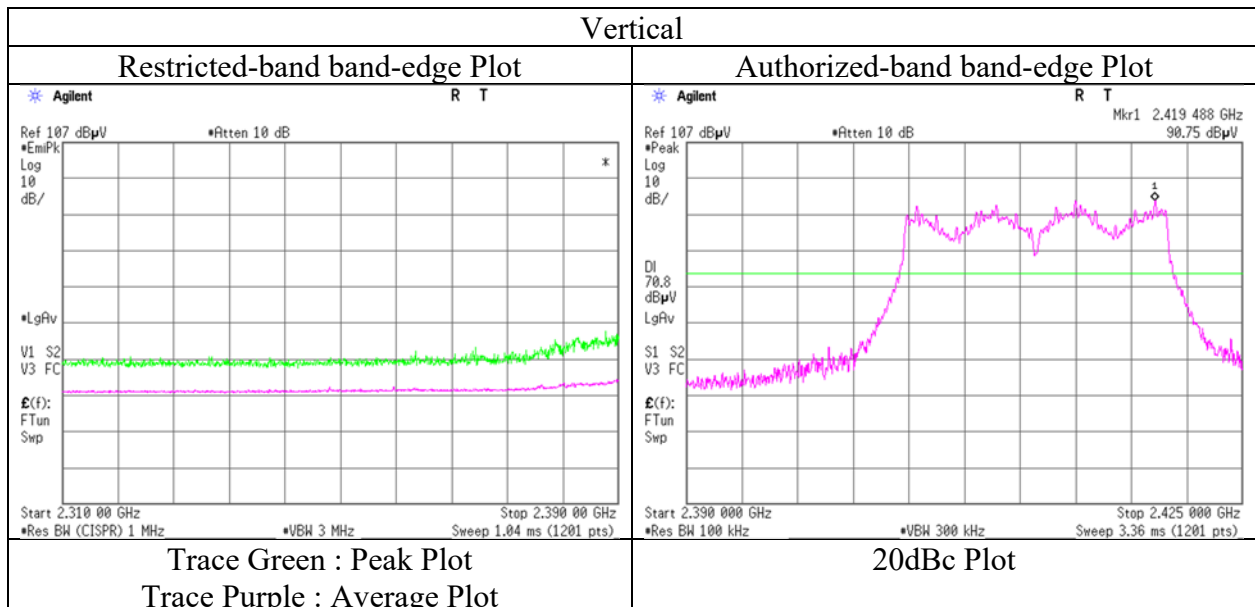
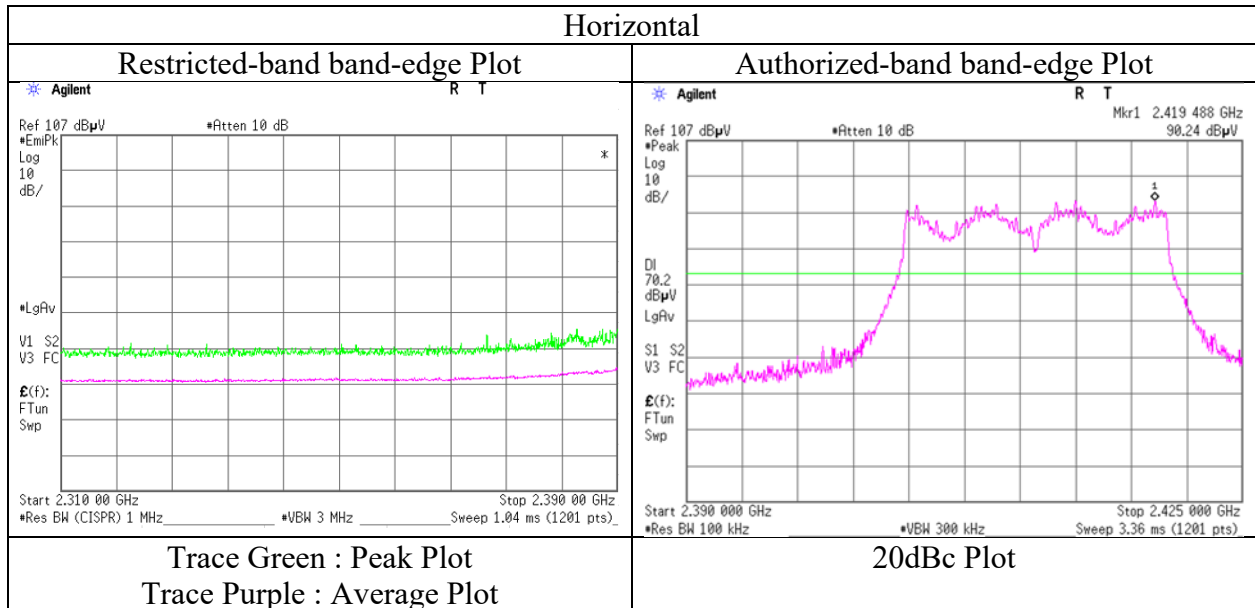

\* The measurement was conducted for a sufficiently long enough time to detect any possible spurious emissions. Final result of restricted band edge was shown in tabular data.

## Radiated Spurious Emission

Report No. 12699044S-AJ-R1  
Test place Shonan EMC Lab.  
Semi Anechoic Chamber No.3  
Date June 3, 2019 February 9, 2019 February 10, 2019 February 11, 2019  
Temperature / Humidity 26 deg. C / 54 % RH 23 deg. C / 38 % RH 21 deg. C / 36 % RH 20 deg. C / 35 % RH  
Engineer Hiromasa Sato Takahiro Suzuki Makoto Hosaka Yasumasa Owaki  
(1 GHz - 2.8 GHz) (2.8 GHz - 13 GHz) (13 GHz - 18 GHz) (18 GHz - 26.5 GHz)  
Mode Tx 11g 2437 MHz

(\* PK: Peak, AV: Average, QP: Quasi-Peak)

Polarity	Frequency [MHz]	Detector	Reading [dBuV]	Ant.Fac. [dB/m]	Loss [dB]	Gain [dB]	Distance Factor [dB]	Result [dBuV/m]	Limit [dBuV/m]	Margin [dB]	Height [cm]	Angle [deg]	Remark
Hori.	4874.000	PK	53.68	31.40	7.33	42.89	2.48	52.00	73.9	21.9	175	87	
Hori.	7311.000	PK	51.14	36.99	8.13	43.13	2.48	55.61	73.9	18.2	138	62	
Hori.	9748.000	PK	48.32	38.92	10.47	43.02	2.48	57.17	73.9	16.7	359	133	
Hori.	12185.000	PK	46.36	39.26	11.72	42.20	2.48	57.62	73.9	16.2	310	112	
Hori.	19496.000	PK	43.59	40.18	12.47	45.24	-9.54	41.46	73.9	32.4	140	332	
Hori.	21933.000	PK	47.66	40.19	13.21	46.91	-9.54	44.61	73.9	29.2	141	38	
Hori.	24370.000	PK	43.13	39.97	14.15	48.74	-9.54	38.97	73.9	34.9	150	0	
Vert.	4874.000	PK	53.27	31.40	7.33	42.89	2.48	51.59	73.9	22.3	164	88	
Vert.	7311.000	PK	49.11	36.99	8.13	43.13	2.48	53.58	73.9	20.3	100	3	
Vert.	9748.000	PK	48.35	38.92	10.47	43.02	2.48	57.20	73.9	16.7	100	32	
Vert.	12185.000	PK	45.37	39.26	11.72	42.20	2.48	56.63	73.9	17.2	100	331	
Vert.	19496.000	PK	41.90	40.18	12.47	45.24	-9.54	39.77	73.9	34.1	178	2	
Vert.	21933.000	PK	47.01	40.19	13.21	46.91	-9.54	43.96	73.9	29.9	135	78	
Vert.	24370.000	PK	43.67	39.97	14.15	48.74	-9.54	39.51	73.9	34.3	110	297	

Result = Reading + Ant.Fac. + Loss (Cable+(Attenuator or Filter)(below 18 GHz)) - Gain(Amplifier) + Distance factor

Distance factor : 1 GHz - 13 GHz : 20log(3.99 m / 3.0 m) = 2.48 dB

13 GHz - 40 GHz : 20log(1.0 m / 3.0 m) = -9.54 dB

### Average measurement value with duty factor

Polarity	Frequency [MHz]	Detector	Reading [dBuV]	Ant.Fac. [dB/m]	Loss [dB]	Gain [dB]	Duty Factor [dB]	Distance Factor [dB]	Result [dBuV/m]	Limit [dBuV/m]	Margin [dB]	Remark
Hori.	4874.000	AV	46.89	31.40	7.33	42.89	0.21	2.48	45.42	53.9	8.4	
Hori.	7311.000	AV	42.40	36.99	8.13	43.13	0.21	2.48	47.08	53.9	6.8	
Hori.	9748.000	AV	42.21	38.92	10.47	43.02	0.21	2.48	51.27	53.9	2.6	
Hori.	12185.000	AV	38.03	39.26	11.72	42.20	0.21	2.48	49.50	53.9	4.4	
Hori.	19496.000	AV	34.94	40.18	12.47	45.24	0.21	-9.54	33.02	53.9	20.8	
Hori.	21933.000	AV	37.33	40.19	13.21	46.91	0.21	-9.54	34.49	53.9	19.4	
Hori.	24370.000	AV	34.88	39.97	14.15	48.74	0.21	-9.54	30.93	53.9	22.9	
Vert.	4874.000	AV	44.91	31.40	7.33	42.89	0.21	2.48	43.44	53.9	10.4	
Vert.	7311.000	AV	40.60	36.99	8.13	43.13	0.21	2.48	45.28	53.9	8.6	
Vert.	9748.000	AV	40.27	38.92	10.47	43.02	0.21	2.48	49.33	53.9	4.5	
Vert.	12185.000	AV	37.11	39.26	11.72	42.20	0.21	2.48	48.58	53.9	5.3	
Vert.	19496.000	AV	33.52	40.18	12.47	45.24	0.21	-9.54	31.60	53.9	22.3	
Vert.	21933.000	AV	36.65	40.19	13.21	46.91	0.21	-9.54	33.81	53.9	20.0	
Vert.	24370.000	AV	35.02	39.97	14.15	48.74	0.21	-9.54	31.07	53.9	22.8	

Result = Reading + Ant.Fac. + Loss (Cable+(Attenuator or Filter)(below 18 GHz)) - Gain(Amplifier) + Duty factor + Distance factor

Distance factor : 1 GHz - 13 GHz : 20log(3.99 m / 3.0 m) = 2.48 dB

13 GHz - 40 GHz : 20log(1.0 m / 3.0 m) = -9.54 dB

Duty factor refer to "Duty factor Calculation chart" sheet.

**UL Japan, Inc.**

**Shonan EMC Lab.**

1-22-3 Megumigaoka, Hiratsuka-shi, Kanagawa-ken, 259-1220 JAPAN

Telephone : +81 463 50 6400

Facsimile : +81 463 50 6401

## Radiated Spurious Emission

Report No. 12699044S-AJ-R1  
Test place Shonan EMC Lab.  
Semi Anechoic Chamber No.3  
Date June 3, 2019 February 9, 2019 February 10, 2019 February 7, 2019  
Temperature / Humidity 26 deg. C / 54 % RH 23 deg. C / 38 % RH 21 deg. C / 36 % RH 23 deg. C / 31 % RH  
Engineer Hiromasa Sato Takahiro Suzuki Makoto Hosaka Makoto Hosaka  
(1 GHz - 2.8 GHz) (2.8 GHz - 13 GHz) (13 GHz - 18 GHz) (18 GHz - 26.5 GHz)  
Mode Tx 11g 2462 MHz

(\* PK: Peak, AV: Average, QP: Quasi-Peak)

Polarity	Frequency [MHz]	Detector	Reading [dBuV]	Ant.Fac. [dB/m]	Loss [dB]	Gain [dB]	Distance Factor [dB]	Result [dBuV/m]	Limit [dBuV/m]	Margin [dB]	Height [cm]	Angle [deg]	Remark
Hori.	2483.500	PK	54.82	27.65	13.63	41.62	2.48	56.96	73.9	16.9	237	81	
Hori.	2483.622	PK	54.33	27.65	13.63	41.62	2.48	56.47	73.9	17.4	237	81	
Hori.	4924.000	PK	53.84	31.37	7.36	42.90	2.48	52.15	73.9	21.7	111	95	
Hori.	7386.000	PK	50.18	37.01	8.14	43.28	2.48	54.53	73.9	19.3	102	72	
Hori.	9848.000	PK	48.75	39.12	10.41	42.92	2.48	57.84	73.9	16.0	180	325	
Hori.	12310.000	PK	47.46	38.94	11.76	42.13	2.48	58.51	73.9	15.3	135	154	
Hori.	19696.000	PK	44.18	40.12	12.49	45.32	-9.54	41.93	73.9	31.9	136	299	
Hori.	22158.000	PK	46.39	40.18	13.35	47.20	-9.54	43.18	73.9	30.7	141	36	
Hori.	24620.000	PK	45.97	40.01	14.25	48.74	-9.54	41.95	73.9	31.9	150	0	
Vert.	2483.500	PK	54.38	27.65	13.63	41.62	2.48	56.52	73.9	17.3	250	107	
Vert.	2483.671	PK	54.21	27.65	13.63	41.62	2.48	56.35	73.9	17.5	250	107	
Vert.	4924.000	PK	56.68	31.37	7.36	42.90	2.48	54.99	73.9	18.9	165	104	
Vert.	7386.000	PK	49.01	37.01	8.14	43.28	2.48	53.36	73.9	20.5	100	5	
Vert.	9848.000	PK	48.26	39.12	10.41	42.92	2.48	57.35	73.9	16.5	183	314	
Vert.	12310.000	PK	47.45	38.94	11.76	42.13	2.48	58.50	73.9	15.4	160	28	
Vert.	19696.000	PK	43.29	40.12	12.49	45.32	-9.54	41.04	73.9	32.8	170	4	
Vert.	22158.000	PK	45.87	40.18	13.35	47.20	-9.54	42.66	73.9	31.2	141	91	
Vert.	24620.000	PK	46.44	40.01	14.25	48.74	-9.54	42.42	73.9	31.4	123	344	

Result = Reading + Ant.Fac. + Loss (Cable+(Attenuator or Filter)(below 18 GHz)) - Gain(Amplifier) + Distance factor

Distance factor : 1 GHz - 13 GHz : 20log(3.99 m / 3.0 m) = 2.48 dB

13 GHz - 40 GHz : 20log(1.0 m / 3.0 m) = -9.54 dB

### Average measurement value with duty factor

Polarity	Frequency [MHz]	Detector	Reading [dBuV]	Ant.Fac. [dB/m]	Loss [dB]	Gain [dB]	Duty Factor [dB]	Distance Factor [dB]	Result [dBuV/m]	Limit [dBuV/m]	Margin [dB]	Remark
Hori.	2483.500	AV	39.76	27.65	13.63	41.62	0.21	2.48	42.11	53.9	11.7	*1)
Hori.	2483.622	AV	39.50	27.65	13.63	41.62	0.21	2.48	41.85	53.9	12.0	
Hori.	4924.000	AV	43.05	31.37	7.36	42.90	0.21	2.48	41.57	53.9	12.3	
Hori.	7386.000	AV	39.59	37.01	8.14	43.28	0.21	2.48	44.15	53.9	9.7	
Hori.	9848.000	AV	39.63	39.12	10.41	42.92	0.21	2.48	48.93	53.9	4.9	
Hori.	12310.000	AV	38.51	38.94	11.76	42.13	0.21	2.48	49.77	53.9	4.1	
Hori.	19696.000	AV	35.14	40.12	12.49	45.32	0.21	-9.54	33.10	53.9	20.8	
Hori.	22158.000	AV	36.60	40.18	13.35	47.20	0.21	-9.54	33.60	53.9	20.3	
Hori.	24620.000	AV	36.41	40.01	14.25	48.74	0.21	-9.54	32.60	53.9	21.3	
Vert.	2483.500	AV	40.03	27.65	13.63	41.62	0.21	2.48	42.38	53.9	11.5	*1)
Vert.	2483.671	AV	39.88	27.65	13.63	41.62	0.21	2.48	42.23	53.9	11.6	
Vert.	4924.000	AV	44.33	31.37	7.36	42.90	0.21	2.48	42.85	53.9	11.0	
Vert.	7386.000	AV	40.11	37.01	8.14	43.28	0.21	2.48	44.67	53.9	9.2	
Vert.	9848.000	AV	39.54	39.12	10.41	42.92	0.21	2.48	48.84	53.9	5.0	
Vert.	12310.000	AV	38.02	38.94	11.76	42.13	0.21	2.48	49.28	53.9	4.6	
Vert.	19696.000	AV	35.31	40.12	12.49	45.32	0.21	-9.54	33.27	53.9	20.6	
Vert.	22158.000	AV	35.80	40.18	13.35	47.20	0.21	-9.54	32.80	53.9	21.1	
Vert.	24620.000	AV	36.65	40.01	14.25	48.74	0.21	-9.54	32.84	53.9	21.0	

Result = Reading + Ant.Fac. + Loss (Cable+(Attenuator or Filter)(below 18 GHz)) - Gain(Amplifier) + Duty factor + Distance factor

Distance factor : 1 GHz - 13 GHz : 20log(3.99 m / 3.0 m) = 2.48 dB

13 GHz - 40 GHz : 20log(1.0 m / 3.0 m) = -9.54 dB

Duty factor refer to "Duty factor Calculation chart" sheet.

\*1) Not out of band emission (Leakage Power)

**UL Japan, Inc.**

**Shonan EMC Lab.**

1-22-3 Megumigaoka, Hiratsuka-shi, Kanagawa-ken, 259-1220 JAPAN

Telephone : +81 463 50 6400

Facsimile : +81 463 50 6401

**Radiated Spurious Emission**  
**(Reference Plot for band-edge)**

Report No. 12699044S-AJ-R1  
Test place Shonan EMC Lab.  
Semi Anechoic Chamber No.3  
Date June 3, 2019  
Temperature / Humidity 26 deg. C / 54 % RH  
Engineer Hiromasa Sato  
(1 GHz - 2.8 GHz)  
Mode Tx 11g 2462 MHz

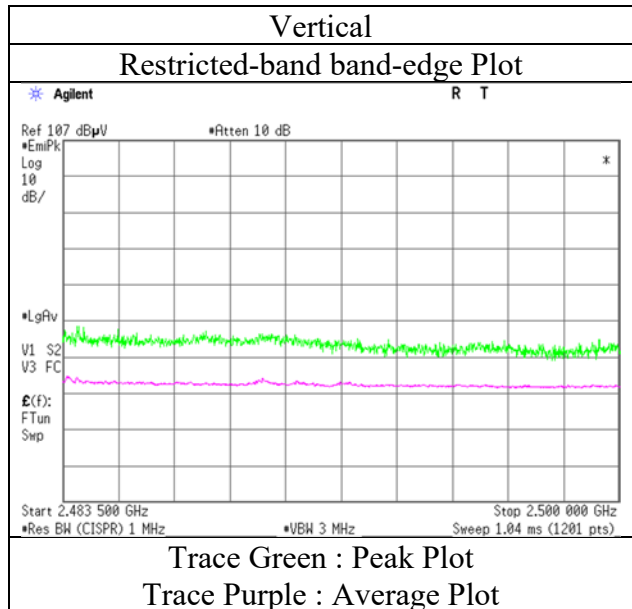
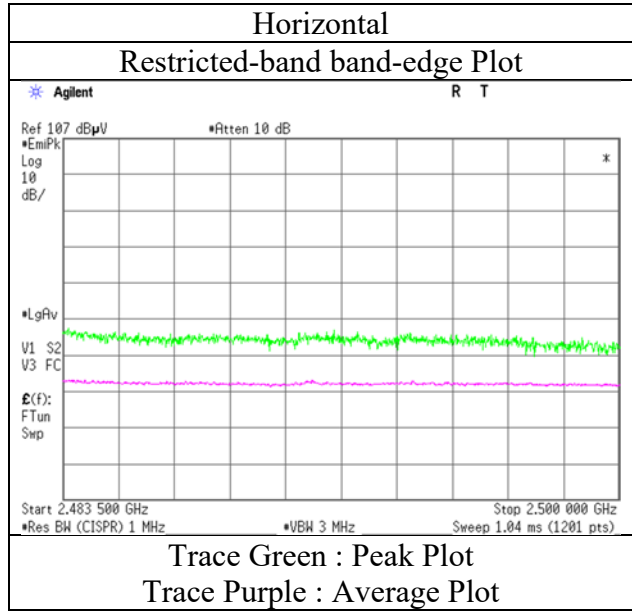

\* The measurement was conducted for a sufficiently long enough time to detect any possible spurious emissions. Final result of restricted band edge was shown in tabular data.

## Radiated Spurious Emission

Report No.	12699044S-AJ-R1			
Test place	Shonan EMC Lab.			
Semi Anechoic Chamber	No.3	No.3	No.1	No.3
Date	March 13, 2019	June 3, 2019	March 12, 2019	March 14, 2019
Temperature / Humidity	23 deg. C / 39 % RH	26 deg. C / 54 % RH	21 deg. C / 39 % RH	21 deg. C / 45 % RH
Engineer	Takahiro Suzuki	Hirosama Sato	Kazuya Noda	Hirosama Sato
	(30 MHz - 1 GHz)	(1 GHz - 2.8 GHz)	(2.8 GHz - 13 GHz)	(13 GHz - 26.5 GHz)
Mode	Tx 11n-20 2412 MHz			

(\* PK: Peak, AV: Average, QP: Quasi-Peak)

Polarity	Frequency [MHz]	Detector	Reading [dBuV]	Ant.Fac. [dB/m]	Loss [dB]	Gain [dB]	Distance Factor [dB]	Result [dBuV/m]	Limit [dBuV/m]	Margin [dB]	Height [cm]	Angle [deg]	Remark
Hori.	244.702	QP	38.68	11.71	8.34	32.02	0.00	26.71	46.0	19.2	100	89	
Hori.	725.048	QP	30.44	20.18	10.49	31.84	0.00	29.27	46.0	16.7	160	143	
Hori.	875.005	QP	30.26	22.15	11.02	31.24	0.00	32.19	46.0	13.8	186	175	
Hori.	960.012	QP	30.16	22.22	11.28	30.57	0.00	33.09	53.9	20.8	157	157	
Hori.	2389.583	PK	57.41	27.86	13.56	41.59	2.48	59.72	73.9	14.1	151	62	
Hori.	2390.000	PK	56.83	27.86	13.56	41.59	2.48	59.14	73.9	14.7	151	62	
Hori.	4824.000	PK	53.34	31.34	6.52	39.50	2.48	54.18	73.9	19.7	151	44	
Hori.	7236.000	PK	49.62	36.85	8.13	42.98	2.48	54.10	73.9	19.8	127	52	
Hori.	9648.000	PK	46.43	38.26	8.92	39.49	2.48	56.60	73.9	17.3	175	276	
Hori.	12060.000	PK	46.55	39.21	10.46	38.74	2.48	59.96	73.9	13.9	150	0	
Vert.	31.630	QP	40.26	18.07	6.48	32.20	0.00	32.61	40.0	7.3	100	147	
Vert.	32.184	QP	41.32	17.84	6.50	32.20	0.00	33.46	40.0	6.5	100	25	
Vert.	33.348	QP	40.79	17.38	6.52	32.20	0.00	32.49	40.0	7.5	100	169	
Vert.	34.550	QP	42.35	16.94	6.54	32.20	0.00	33.63	40.0	6.3	100	176	
Vert.	56.118	QP	42.53	9.24	6.70	32.19	0.00	26.28	40.0	13.7	100	6	
Vert.	83.050	QP	42.64	6.87	7.58	32.17	0.00	24.92	40.0	15.0	100	155	
Vert.	2389.740	PK	56.81	27.86	13.56	41.59	2.48	59.12	73.9	14.7	148	56	
Vert.	2390.000	PK	56.57	27.86	13.56	41.59	2.48	58.88	73.9	15.0	148	56	
Vert.	4824.000	PK	52.57	31.34	6.52	39.50	2.48	53.41	73.9	20.4	134	28	
Vert.	7236.000	PK	48.26	36.85	8.13	42.98	2.48	52.74	73.9	21.1	104	7	
Vert.	9648.000	PK	46.56	38.26	8.92	39.49	2.48	56.73	73.9	17.1	166	29	
Vert.	12060.000	PK	46.61	39.21	10.46	38.74	2.48	60.02	73.9	13.8	150	0	

Result = Reading + Ant.Fac. + Loss (Cable+(Attenuator or Filter)(below 18 GHz)) - Gain(Amplifier) + Distance factor  
Distance factor : 1 GHz - 13 GHz :  $20\log(3.99\text{ m} / 3.0\text{ m}) = 2.48\text{ dB}$   
13 GHz - 40 GHz :  $20\log(1.0\text{ m} / 3.0\text{ m}) = -9.54\text{ dB}$

### Average measurement value with duty factor

Polarity	Frequency [MHz]	Detector	Reading [dBuV]	Ant.Fac. [dB/m]	Loss [dB]	Gain [dB]	Duty Factor [dB]	Distance Factor [dB]	Result [dBuV/m]	Limit [dBuV/m]	Margin [dB]	Remark
Hori.	2389.583	AV	41.08	27.86	13.56	41.59	0.29	2.48	43.68	53.9	10.2	
Hori.	2390.000	AV	41.01	27.86	13.56	41.59	0.29	2.48	43.61	53.9	10.2	*1)
Hori.	4824.000	AV	41.61	31.34	6.52	39.50	0.29	2.48	42.74	53.9	11.1	
Hori.	7236.000	AV	40.91	36.85	8.13	42.98	0.29	2.48	45.68	53.9	8.2	
Hori.	9648.000	AV	37.11	38.26	8.92	39.49	0.29	2.48	47.57	53.9	6.3	
Hori.	12060.000	AV	36.96	39.21	10.46	38.74	0.29	2.48	50.66	53.9	3.2	
Vert.	2389.740	AV	40.66	27.86	13.56	41.59	0.29	2.48	43.26	53.9	10.6	
Vert.	2390.000	AV	40.95	27.86	13.56	41.59	0.29	2.48	43.55	53.9	10.3	*1)
Vert.	4824.000	AV	40.73	31.34	6.52	39.50	0.29	2.48	41.86	53.9	12.0	
Vert.	7236.000	AV	39.71	36.85	8.13	42.98	0.29	2.48	44.48	53.9	9.4	
Vert.	9648.000	AV	37.13	38.26	8.92	39.49	0.29	2.48	47.59	53.9	6.3	
Vert.	12060.000	AV	37.02	39.21	10.46	38.74	0.29	2.48	50.72	53.9	3.1	

Result = Reading + Ant.Fac. + Loss (Cable+(Attenuator or Filter)(below 18 GHz)) - Gain(Amplifier) + Duty factor + Distance factor  
Distance factor : 1 GHz - 13 GHz :  $20\log(3.99\text{ m} / 3.0\text{ m}) = 2.48\text{ dB}$   
13 GHz - 40 GHz :  $20\log(1.0\text{ m} / 3.0\text{ m}) = -9.54\text{ dB}$

Duty factor refer to "Duty factor Calculation chart" sheet.

\*1) Not out of band emission (Leakage Power)

### 20 dBc Data Sheet (RBW 100 kHz, VBW 300 kHz)

Polarity	Frequency [MHz]	Detector	Reading [dBuV]	Ant.Fac. [dB/m]	Loss [dB]	Gain [dB]	Distance Factor [dB]	Result [dBuV/m]	Limit [dBuV/m]	Margin [dB]	Remark
Hori.	2412.000	PK	90.23	27.85	13.57	41.60	2.48	92.53	-	-	Carrier
Hori.	2398.310	PK	46.96	27.86	13.56	41.60	2.48	49.26	72.53	23.2	
Hori.	2400.000	PK	49.53	27.86	13.57	41.60	2.48	51.84	72.53	20.6	
Vert.	2412.000	PK	88.63	27.85	13.57	41.60	2.48	90.93	-	-	Carrier
Vert.	2398.117	PK	48.40	27.86	13.56	41.60	2.48	50.70	70.93	20.2	
Vert.	2400.000	PK	47.98	27.86	13.57	41.60	2.48	50.29	70.93	20.6	

Result = Reading + Ant.Fac. + Loss (Cable+(Attenuator or Filter)(below 18 GHz)) - Gain(Amplifier) + Distance factor  
Distance factor : 1 GHz - 13 GHz :  $20\log(3.99\text{ m} / 3.0\text{ m}) = 2.48\text{ dB}$   
13 GHz - 40 GHz :  $20\log(1.0\text{ m} / 3.0\text{ m}) = -9.54\text{ dB}$

**UL Japan, Inc.**

**Shonan EMC Lab.**

1-22-3 Megumigaoka, Hiratsuka-shi, Kanagawa-ken, 259-1220 JAPAN

Telephone : +81 463 50 6400

Facsimile : +81 463 50 6401



**Radiated Spurious Emission**  
**(Reference Plot for band-edge)**

Report No. 12699044S-AJ-R1  
Test place Shonan EMC Lab.  
Semi Anechoic Chamber No.3  
Date June 3, 2019  
Temperature / Humidity 26 deg. C / 54 % RH  
Engineer Hiromasa Sato  
(1 GHz - 2.8 GHz)  
Mode Tx 11n-20 2412 MHz

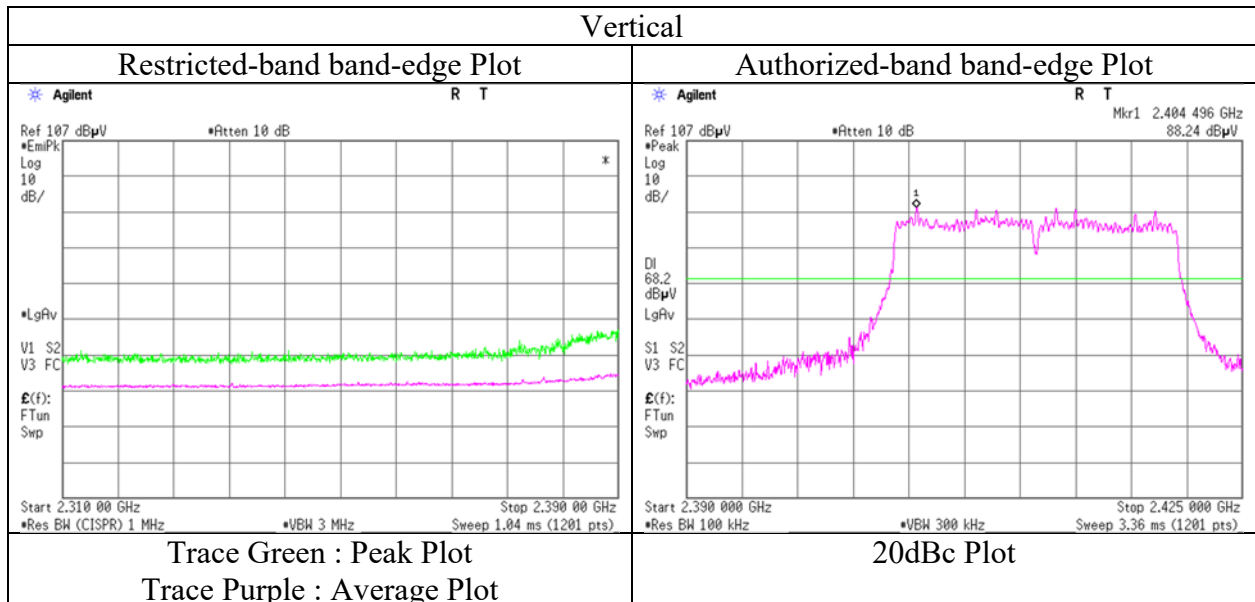
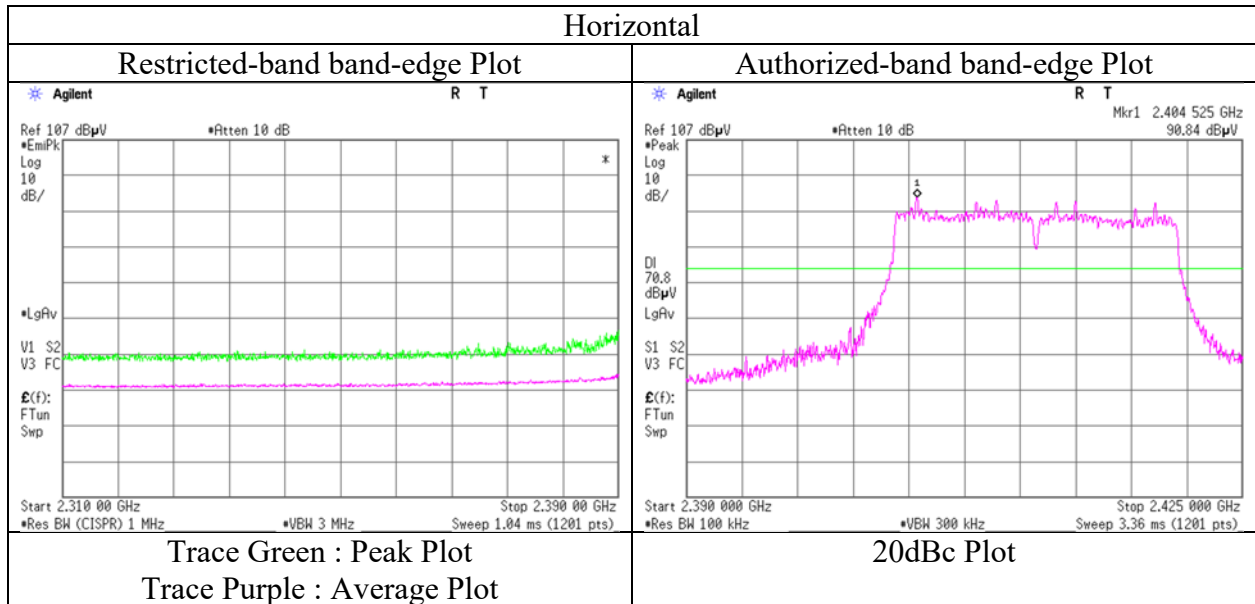

\* The measurement was conducted for a sufficiently long enough time to detect any possible spurious emissions. Final result of restricted band edge was shown in tabular data.

## Radiated Spurious Emission

Report No.	12699044S-AJ-R1			
Test place	Shonan EMC Lab.			
Semi Anechoic Chamber	No.3	No.3	No.1	No.3
Date	June 3, 2019	February 10, 2019	March 12, 2019	March 14, 2019
Temperature / Humidity	26 deg. C / 54 % RH	21 deg. C / 36 % RH	21 deg. C / 39 % RH	21 deg. C / 45 % RH
Engineer	Hiromasa Sato	Makoto Hosaka	Kazuya Noda	Hiromasa Sato
	(1 GHz - 2.8 GHz)	(2.8 GHz - 13 GHz)	(13 GHz - 18 GHz)	(18 GHz - 26.5 GHz)
Mode	Tx 11n-20 2437 MHz			

(\* PK: Peak, AV: Average, QP: Quasi-Peak)

Polarity	Frequency [MHz]	Detector	Reading [dBuV]	Ant.Fac. [dB/m]	Loss [dB]	Gain [dB]	Distance Factor [dB]	Result [dBuV/m]	Limit [dBuV/m]	Margin [dB]	Height [cm]	Angle [deg]	Remark
Hori.	4874.000	PK	50.96	31.22	6.53	39.50	2.48	51.69	73.9	22.2	119	42	
Hori.	7311.000	PK	49.98	36.99	8.13	43.13	2.48	54.45	73.9	19.4	127	63	
Hori.	9748.000	PK	45.56	38.56	8.93	39.42	2.48	56.11	73.9	17.7	154	265	
Hori.	12185.000	PK	44.29	39.23	10.53	38.55	2.48	57.98	73.9	15.9	150	0	
Vert.	4874.000	PK	49.78	31.22	6.53	39.50	2.48	50.51	73.9	23.3	121	22	
Vert.	7311.000	PK	50.43	36.99	8.13	43.13	2.48	54.90	73.9	19.0	100	3	
Vert.	9748.000	PK	45.48	38.56	8.93	39.42	2.48	56.03	73.9	17.8	143	300	
Vert.	12185.000	PK	45.12	39.23	10.53	38.55	2.48	58.81	73.9	15.0	150	0	

Result = Reading + Ant.Fac. + Loss (Cable+(Attenuator or Filter)(below 18 GHz)) - Gain(Amplifier) + Distance factor

Distance factor : 1 GHz - 13 GHz : 20log(3.99 m / 3.0 m) = 2.48 dB

13 GHz - 40 GHz : 20log(1.0 m / 3.0 m) = -9.54 dB

### Average measurement value with duty factor

Polarity	Frequency [MHz]	Detector	Reading [dBuV]	Ant.Fac. [dB/m]	Loss [dB]	Gain [dB]	Duty Factor [dB]	Distance Factor [dB]	Result [dBuV/m]	Limit [dBuV/m]	Margin [dB]	Remark
Hori.	4874.000	AV	40.65	31.22	6.53	39.50	0.29	2.48	41.67	53.9	12.2	
Hori.	7311.000	AV	41.26	36.99	8.13	43.13	0.29	2.48	46.02	53.9	7.8	
Hori.	9748.000	AV	36.66	38.56	8.93	39.42	0.29	2.48	47.50	53.9	6.4	
Hori.	12185.000	AV	35.55	39.23	10.53	38.55	0.29	2.48	49.53	53.9	4.3	
Vert.	4874.000	AV	38.87	31.22	6.53	39.50	0.29	2.48	39.89	53.9	14.0	
Vert.	7311.000	AV	40.68	36.99	8.13	43.13	0.29	2.48	45.44	53.9	8.4	
Vert.	9748.000	AV	36.60	38.56	8.93	39.42	0.29	2.48	47.44	53.9	6.4	
Vert.	12185.000	AV	35.58	39.23	10.53	38.55	0.29	2.48	49.56	53.9	4.3	

Result = Reading + Ant.Fac. + Loss (Cable+(Attenuator or Filter)(below 18 GHz)) - Gain(Amplifier) + Duty factor + Distance factor

Distance factor : 1 GHz - 13 GHz : 20log(3.99 m / 3.0 m) = 2.48 dB

13 GHz - 40 GHz : 20log(1.0 m / 3.0 m) = -9.54 dB

Duty factor refer to "Duty factor Calculation chart" sheet.

## Radiated Spurious Emission

Report No. 12699044S-AJ-R1  
Test place Shonan EMC Lab.  
Semi Anechoic Chamber No.3  
Date June 3, 2019 March 14, 2019  
Temperature / Humidity 26 deg. C / 54 % RH 21 deg. C / 45 % RH  
Engineer Hiromasa Sato Hiromasa Sato  
(1 GHz - 2.8 GHz) (2.8 GHz - 26.5 GHz)  
Mode Tx 11n-20 2462 MHz

(\* PK: Peak, AV: Average, QP: Quasi-Peak)

Polarity	Frequency [MHz]	Detector	Reading [dBuV]	Ant.Fac. [dB/m]	Loss [dB]	Gain [dB]	Distance Factor [dB]	Result [dBuV/m]	Limit [dBuV/m]	Margin [dB]	Height [cm]	Angle [deg]	Remark
Hori.	2483.500	PK	55.43	27.65	13.63	41.62	2.48	57.57	73.9	16.3	236	79	
Hori.	2483.882	PK	55.80	27.65	13.63	41.62	2.48	57.94	73.9	15.9	236	79	
Hori.	4924.000	PK	50.89	31.37	7.49	42.90	2.48	49.33	73.9	24.5	221	92	
Hori.	7386.000	PK	50.27	37.01	8.14	43.28	2.48	54.62	73.9	19.2	129	65	
Hori.	9848.000	PK	48.48	39.12	10.43	42.92	2.48	57.59	73.9	16.3	193	24	
Hori.	12310.000	PK	45.98	38.94	11.30	42.13	2.48	56.57	73.9	17.3	150	0	
Vert.	2483.500	PK	57.70	27.65	13.63	41.62	2.48	59.84	73.9	14.0	146	29	
Vert.	2483.719	PK	56.81	27.65	13.63	41.62	2.48	58.95	73.9	14.9	146	29	
Vert.	4924.000	PK	47.83	31.37	7.49	42.90	2.48	46.27	73.9	27.6	124	74	
Vert.	7386.000	PK	49.20	37.01	8.14	43.28	2.48	53.55	73.9	20.3	100	4	
Vert.	9848.000	PK	48.23	39.12	10.43	42.92	2.48	57.34	73.9	16.5	100	0	
Vert.	12310.000	PK	45.71	38.94	11.30	42.13	2.48	56.30	73.9	17.6	150	0	

Result = Reading + Ant.Fac. + Loss (Cable+(Attenuator or Filter)(below 18 GHz)) - Gain(Amplifier) + Distance factor

Distance factor : 1 GHz - 13 GHz : 20log(3.99 m / 3.0 m) = 2.48 dB

13 GHz - 40 GHz : 20log(1.0 m / 3.0 m) = -9.54 dB

### Average measurement value with duty factor

Polarity	Frequency [MHz]	Detector	Reading [dBuV]	Ant.Fac. [dB/m]	Loss [dB]	Gain [dB]	Duty Factor [dB]	Distance Factor [dB]	Result [dBuV/m]	Limit [dBuV/m]	Margin [dB]	Remark
Hori.	2483.500	AV	40.63	27.65	13.63	41.62	0.29	2.48	43.06	53.9	10.8	*1)
Hori.	2483.882	AV	40.11	27.65	13.63	41.62	0.29	2.48	42.54	53.9	11.3	
Hori.	4924.000	AV	41.85	31.37	7.49	42.90	0.29	2.48	40.58	53.9	13.3	
Hori.	7386.000	AV	41.23	37.01	8.14	43.28	0.29	2.48	45.87	53.9	8.0	
Hori.	9848.000	AV	38.39	39.12	10.43	42.92	0.29	2.48	47.79	53.9	6.1	
Hori.	12310.000	AV	35.89	38.94	11.30	42.13	0.29	2.48	46.77	53.9	7.1	
Vert.	2483.500	AV	40.12	27.65	13.63	41.62	0.29	2.48	42.55	53.9	11.3	*1)
Vert.	2483.719	AV	40.23	27.65	13.63	41.62	0.29	2.48	42.66	53.9	11.2	
Vert.	4924.000	AV	39.69	31.37	7.49	42.90	0.29	2.48	38.42	53.9	15.4	
Vert.	7386.000	AV	40.09	37.01	8.14	43.28	0.29	2.48	44.73	53.9	9.1	
Vert.	9848.000	AV	38.70	39.12	10.43	42.92	0.29	2.48	48.10	53.9	5.8	
Vert.	12310.000	AV	37.92	38.94	11.30	42.13	0.29	2.48	48.80	53.9	5.1	

Result = Reading + Ant.Fac. + Loss (Cable+(Attenuator or Filter)(below 18 GHz)) - Gain(Amplifier) + Duty factor + Distance factor

Distance factor : 1 GHz - 13 GHz : 20log(3.99 m / 3.0 m) = 2.48 dB

13 GHz - 40 GHz : 20log(1.0 m / 3.0 m) = -9.54 dB

Duty factor refer to "Duty factor Calculation chart" sheet.

\*1) Not out of band emission (Leakage Power)

**Radiated Spurious Emission**  
**(Reference Plot for band-edge)**

Report No. 12699044S-AJ-R1  
Test place Shonan EMC Lab.  
Semi Anechoic Chamber No.3  
Date June 3, 2019  
Temperature / Humidity 26 deg. C / 54 % RH  
Engineer Hiromasa Sato  
(1 GHz - 2.8 GHz)  
Mode Tx 11n-20 2462 MHz

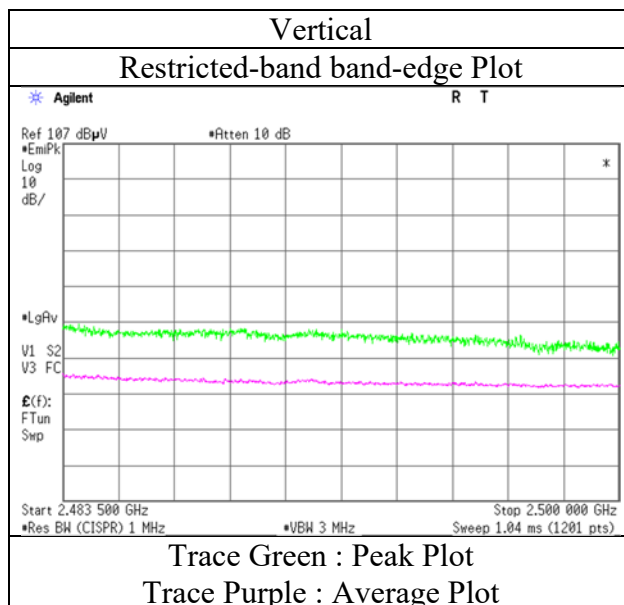
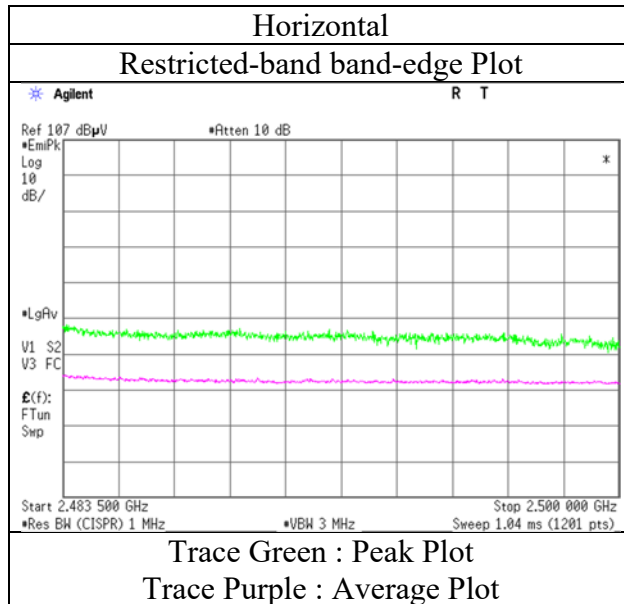

\* The measurement was conducted for a sufficiently long enough time to detect any possible spurious emissions. Final result of restricted band edge was shown in tabular data.

## Radiated Spurious Emission

Report No. 12699044S-AJ-R1  
Test place Shonan EMC Lab.  
Semi Anechoic Chamber No.3  
Date June 3, 2019 March 14, 2019  
Temperature / Humidity 26 deg. C / 54 % RH 21 deg. C / 45 % RH  
Engineer Hiromasa Sato Hiromasa Sato  
(1 GHz - 2.8 GHz) (2.8 GHz - 26.5 GHz)  
Mode Tx 11n-40 2422 MHz

(\* PK: Peak, AV: Average, QP: Quasi-Peak)

Polarity	Frequency [MHz]	Detector	Reading [dBuV]	Ant.Fac. [dB/m]	Loss [dB]	Gain [dB]	Distance Factor [dB]	Result [dBuV/m]	Limit [dBuV/m]	Margin [dB]	Height [cm]	Angle [deg]	Remark
Hori.	2387.100	PK	58.80	27.85	13.56	41.59	2.48	61.10	73.9	12.8	144	74	
Hori.	2390.000	PK	58.60	27.86	13.56	41.59	2.48	60.91	73.9	12.9	144	74	
Hori.	4844.000	PK	49.10	31.49	7.40	42.89	2.48	47.58	73.9	26.3	225	100	
Hori.	7266.000	PK	48.71	36.91	8.13	43.04	2.48	53.19	73.9	20.7	138	70	
Hori.	9688.000	PK	48.90	38.79	10.44	43.08	2.48	57.53	73.9	16.3	130	236	
Hori.	12110.000	PK	47.12	39.32	11.27	42.24	2.48	57.95	73.9	15.9	231	90	
Hori.	2387.100	AV	43.22	27.85	13.56	41.59	2.48	45.52	53.9	8.3	144	74	
Hori.	2390.000	AV	42.77	27.86	13.56	41.59	2.48	45.08	53.9	8.8	144	74	
Hori.	4844.000	AV	39.79	31.49	7.40	42.89	2.48	38.27	53.9	15.6	225	100	
Hori.	7266.000	AV	39.75	36.91	8.13	43.04	2.48	44.23	53.9	9.6	138	70	
Hori.	9688.000	AV	38.41	38.79	10.44	43.08	2.48	47.04	53.9	6.8	130	236	
Hori.	12110.000	AV	37.85	39.32	11.27	42.24	2.48	48.68	53.9	5.2	231	90	
Vert.	2387.740	PK	55.07	27.86	13.56	41.59	2.48	57.38	73.9	16.5	153	96	
Vert.	2390.000	PK	55.52	27.86	13.56	41.59	2.48	57.83	73.9	16.0	153	96	
Vert.	4844.000	PK	49.27	31.49	7.40	42.89	2.48	47.75	73.9	26.1	178	137	
Vert.	7266.000	PK	48.93	36.91	8.13	43.04	2.48	53.41	73.9	20.4	100	2	
Vert.	9688.000	PK	48.17	38.79	10.44	43.08	2.48	56.80	73.9	17.1	171	50	
Vert.	12110.000	PK	47.94	39.32	11.27	42.24	2.48	58.77	73.9	15.1	150	91	
Vert.	2387.740	AV	40.76	27.86	13.56	41.59	2.48	43.07	53.9	10.8	153	96	
Vert.	2390.000	AV	40.54	27.86	13.56	41.59	2.48	42.85	53.9	11.0	153	96	
Vert.	4844.000	AV	40.78	31.49	7.40	42.89	2.48	39.26	53.9	14.6	178	137	
Vert.	7266.000	AV	39.84	36.91	8.13	43.04	2.48	44.32	53.9	9.5	100	2	
Vert.	9688.000	AV	38.74	38.79	10.44	43.08	2.48	47.37	53.9	6.5	171	50	
Vert.	12110.000	AV	37.87	39.32	11.27	42.24	2.48	48.70	53.9	5.2	150	91	

Result = Reading + Ant.Fac. + Loss (Cable+(Attenuator or Filter)(below 18 GHz)) - Gain(Amplifier) + Distance factor

Distance factor : 1 GHz - 13 GHz :  $20\log(3.99\text{ m} / 3.0\text{ m}) = 2.48\text{ dB}$

13 GHz - 40 GHz :  $20\log(1.0\text{ m} / 3.0\text{ m}) = -9.54\text{ dB}$

### 20 dBc Data Sheet (RBW 100 kHz, VBW 300 kHz)

Polarity	Frequency [MHz]	Detector	Reading [dBuV]	Ant.Fac. [dB/m]	Loss [dB]	Gain [dB]	Distance Factor [dB]	Result [dBuV/m]	Limit [dBuV/m]	Margin [dB]	Remark
Hori.	2422.000	PK	87.54	27.83	13.58	41.60	2.48	89.83	-	-	Carrier
Hori.	2396.988	PK	46.66	27.86	13.56	41.59	2.48	48.97	69.83	20.8	
Hori.	2400.000	PK	47.45	27.86	13.57	41.60	2.48	49.76	69.83	20.0	
Vert.	2422.000	PK	88.48	27.83	13.58	41.60	2.48	90.77	-	-	Carrier
Vert.	2399.086	PK	47.32	27.86	13.57	41.60	2.48	49.63	70.77	21.1	
Vert.	2400.000	PK	47.69	27.86	13.57	41.60	2.48	50.00	70.77	20.7	

Result = Reading + Ant.Fac. + Loss (Cable+(Attenuator or Filter)(below 18 GHz)) - Gain(Amplifier) + Distance factor

Distance factor : 1 GHz - 13 GHz :  $20\log(3.99\text{ m} / 3.0\text{ m}) = 2.48\text{ dB}$

13 GHz - 40 GHz :  $20\log(1.0\text{ m} / 3.0\text{ m}) = -9.54\text{ dB}$

**UL Japan, Inc.**

**Shonan EMC Lab.**

1-22-3 Megumigaoka, Hiratsuka-shi, Kanagawa-ken, 259-1220 JAPAN

Telephone : +81 463 50 6400

Facsimile : +81 463 50 6401

**Radiated Spurious Emission**  
**(Reference Plot for band-edge)**

Report No. 12699044S-AJ-R1  
Test place Shonan EMC Lab.  
Semi Anechoic Chamber No.3  
Date June 3, 2019  
Temperature / Humidity 26 deg. C / 54 % RH  
Engineer Hiromasa Sato  
(1 GHz - 2.8 GHz)  
Mode Tx 11n-40 2422 MHz

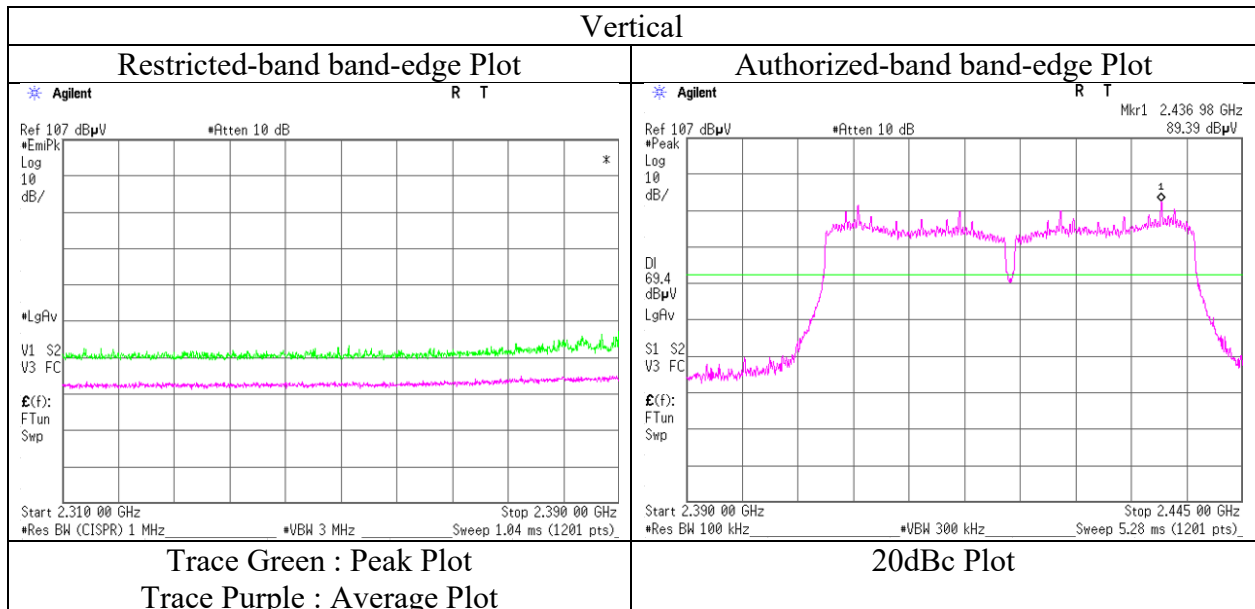
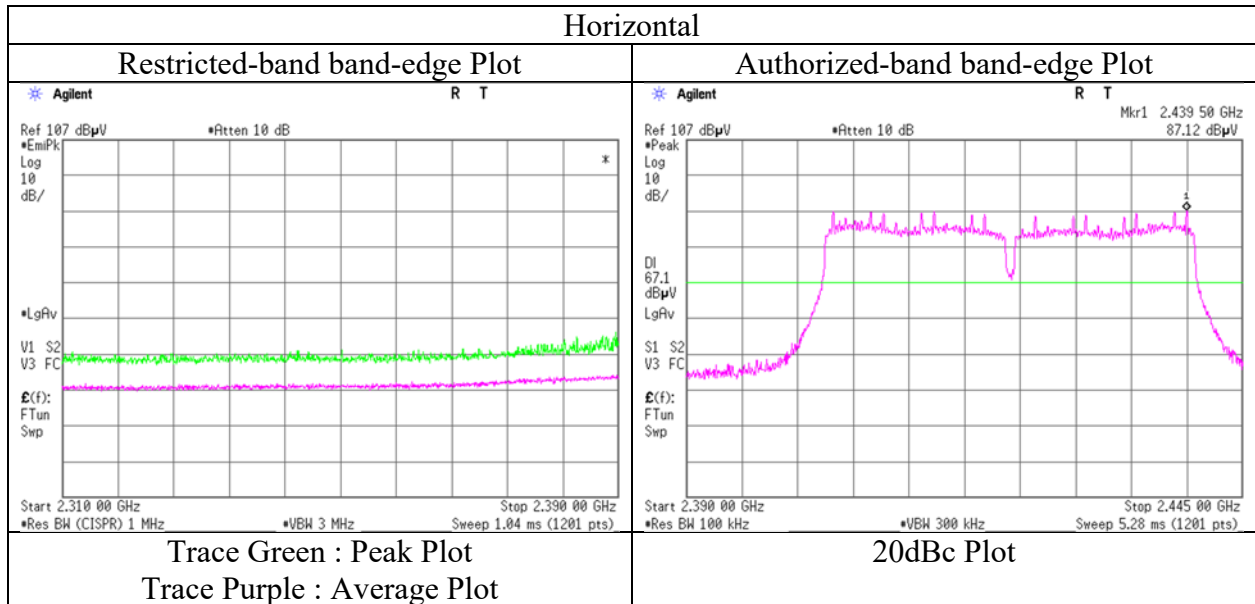

\* The measurement was conducted for a sufficiently long enough time to detect any possible spurious emissions. Final result of restricted band edge was shown in tabular data.

## Radiated Spurious Emission

Report No. 12699044S-AJ-R1  
Test place Shonan EMC Lab.  
Semi Anechoic Chamber No.3  
Date June 3, 2019 March 14, 2019  
Temperature / Humidity 26 deg. C / 54 % RH 21 deg. C / 45 % RH  
Engineer Hiromasa Sato Hiromasa Sato  
(1 GHz - 2.8 GHz) (2.8 GHz - 26.5 GHz)  
Mode Tx 11n-40 2437 MHz

(\* PK: Peak, AV: Average, QP: Quasi-Peak)

Polarity	Frequency [MHz]	Detector	Reading [dBuV]	Ant.Fac. [dB/m]	Loss [dB]	Gain [dB]	Distance Factor [dB]	Result [dBuV/m]	Limit [dBuV/m]	Margin [dB]	Height [cm]	Angle [deg]	Remark
Hori.	4874.000	PK	48.55	31.40	7.43	42.89	2.48	46.97	73.9	26.9	170	153	
Hori.	7311.000	PK	49.75	36.99	8.13	43.13	2.48	54.22	73.9	19.6	108	65	
Hori.	9748.000	PK	48.60	38.92	10.43	43.02	2.48	57.41	73.9	16.4	146	21	
Hori.	12185.000	PK	47.36	39.26	11.28	42.20	2.48	58.18	73.9	15.7	191	32	
Hori.	4874.000	AV	39.52	31.40	7.43	42.89	2.48	37.94	53.9	15.9	170	153	
Hori.	7311.000	AV	40.48	36.99	8.13	43.13	2.48	44.95	53.9	8.9	108	65	
Hori.	9748.000	AV	39.72	38.92	10.43	43.02	2.48	48.53	53.9	5.3	146	21	
Hori.	12185.000	AV	37.73	39.26	11.28	42.20	2.48	48.55	53.9	5.3	191	32	
Vert.	4874.000	PK	48.83	31.40	7.43	42.89	2.48	47.25	73.9	26.6	192	96	
Vert.	7311.000	PK	49.01	36.99	8.13	43.13	2.48	53.48	73.9	20.4	100	4	
Vert.	9748.000	PK	48.97	38.92	10.43	43.02	2.48	57.78	73.9	16.1	244	102	
Vert.	12185.000	PK	47.68	39.26	11.28	42.20	2.48	58.50	73.9	15.4	190	52	
Vert.	4874.000	AV	39.47	31.40	7.43	42.89	2.48	37.89	53.9	16.0	192	96	
Vert.	7311.000	AV	40.32	36.99	8.13	43.13	2.48	44.79	53.9	9.1	100	4	
Vert.	9748.000	AV	39.00	38.92	10.43	43.02	2.48	47.81	53.9	6.1	244	102	
Vert.	12185.000	AV	37.55	39.26	11.28	42.20	2.48	48.37	53.9	5.5	190	52	

Result = Reading + Ant.Fac. + Loss (Cable+(Attenuator or Filter)(below 18 GHz)) - Gain(Amplifier) + Distance factor

Distance factor : 1 GHz - 13 GHz :  $20\log(3.99\text{ m} / 3.0\text{ m}) = 2.48\text{ dB}$

13 GHz - 40 GHz :  $20\log(1.0\text{ m} / 3.0\text{ m}) = -9.54\text{ dB}$

**UL Japan, Inc.**

**Shonan EMC Lab.**

1-22-3 Megumigaoka, Hiratsuka-shi, Kanagawa-ken, 259-1220 JAPAN

Telephone : +81 463 50 6400

Facsimile : +81 463 50 6401

## Radiated Spurious Emission

Report No. 12699044S-AJ-R1  
Test place Shonan EMC Lab.  
Semi Anechoic Chamber No.3  
Date June 3, 2019 March 14, 2019  
Temperature / Humidity 26 deg. C / 54 % RH 21 deg. C / 45 % RH  
Engineer Hiromasa Sato Hiromasa Sato  
(1 GHz - 2.8 GHz) (2.8 GHz - 26.5 GHz)  
Mode Tx 11n-40 2452 MHz

(\* PK: Peak, AV: Average, QP: Quasi-Peak)

Polarity	Frequency [MHz]	Detector	Reading [dBuV]	Ant.Fac. [dB/m]	Loss [dB]	Gain [dB]	Distance Factor [dB]	Result [dBuV/m]	Limit [dBuV/m]	Margin [dB]	Height [cm]	Angle [deg]	Remark
Hori.	2483.500	PK	55.62	27.65	13.63	41.62	2.48	57.76	73.9	16.1	167	76	
Hori.	2488.250	PK	56.24	27.63	13.63	41.63	2.48	58.35	73.9	15.5	167	76	
Hori.	4904.000	PK	48.29	31.30	7.46	42.90	2.48	46.63	73.9	27.2	146	105	
Hori.	7356.000	PK	50.69	37.04	8.13	43.22	2.48	55.12	73.9	18.7	111	66	
Hori.	9808.000	PK	48.68	38.95	10.43	42.96	2.48	57.58	73.9	16.3	201	147	
Hori.	12260.000	PK	47.39	39.12	11.29	42.15	2.48	58.13	73.9	15.7	150	350	
Hori.	2483.500	AV	42.22	27.65	13.63	41.62	2.48	44.36	53.9	9.5	167	76	
Hori.	2488.250	AV	42.52	27.63	13.63	41.63	2.48	44.63	53.9	9.2	167	76	
Hori.	4904.000	AV	39.68	31.30	7.46	42.90	2.48	38.02	53.9	15.8	146	105	
Hori.	7356.000	AV	40.48	37.04	8.13	43.22	2.48	44.91	53.9	8.9	111	66	
Hori.	9808.000	AV	38.75	38.95	10.43	42.96	2.48	47.65	53.9	6.2	201	147	
Hori.	12260.000	AV	38.21	39.12	11.29	42.15	2.48	48.95	53.9	4.9	150	350	
Vert.	2483.500	PK	56.08	27.65	13.63	41.62	2.48	58.22	73.9	15.6	272	97	
Vert.	2488.242	PK	56.34	27.63	13.63	41.63	2.48	58.45	73.9	15.4	272	97	
Vert.	4904.000	PK	48.49	31.30	7.46	42.90	2.48	46.83	73.9	27.0	121	201	
Vert.	7356.000	PK	49.39	37.04	8.13	43.22	2.48	53.82	73.9	20.0	100	5	
Vert.	9808.000	PK	48.56	38.95	10.43	42.96	2.48	57.46	73.9	16.4	161	107	
Vert.	12260.000	PK	47.27	39.12	11.29	42.15	2.48	58.01	73.9	15.8	148	86	
Vert.	2483.500	AV	42.32	27.65	13.63	41.62	2.48	44.46	53.9	9.4	272	97	
Vert.	2488.242	AV	41.98	27.63	13.63	41.63	2.48	44.09	53.9	9.8	272	97	
Vert.	4904.000	AV	38.16	31.30	7.46	42.90	2.48	36.50	53.9	17.4	121	201	
Vert.	7356.000	AV	40.40	37.04	8.13	43.22	2.48	44.83	53.9	9.0	100	5	
Vert.	9808.000	AV	38.11	38.95	10.43	42.96	2.48	47.01	53.9	6.8	161	107	
Vert.	12260.000	AV	38.74	39.12	11.29	42.15	2.48	49.48	53.9	4.4	148	86	

Result = Reading + Ant.Fac. + Loss (Cable+(Attenuator or Filter)(below 18 GHz)) - Gain(Amplifier) + Distance factor

Distance factor : 1 GHz - 13 GHz :  $20\log(3.99\text{ m} / 3.0\text{ m}) = 2.48\text{ dB}$

13 GHz - 40 GHz :  $20\log(1.0\text{ m} / 3.0\text{ m}) = -9.54\text{ dB}$

**UL Japan, Inc.**

**Shonan EMC Lab.**

1-22-3 Megumigaoka, Hiratsuka-shi, Kanagawa-ken, 259-1220 JAPAN

Telephone : +81 463 50 6400

Facsimile : +81 463 50 6401



**Radiated Spurious Emission**  
**(Reference Plot for band-edge)**

Report No. 12699044S-AJ-R1  
Test place Shonan EMC Lab.  
Semi Anechoic Chamber No.3  
Date June 3, 2019  
Temperature / Humidity 26 deg. C / 54 % RH  
Engineer Hiromasa Sato  
(1 GHz - 2.8 GHz)  
Mode Tx 11n-40 2452 MHz

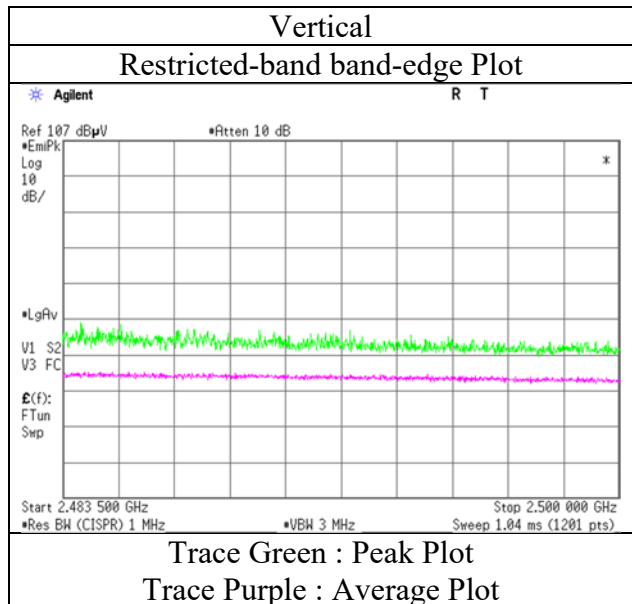
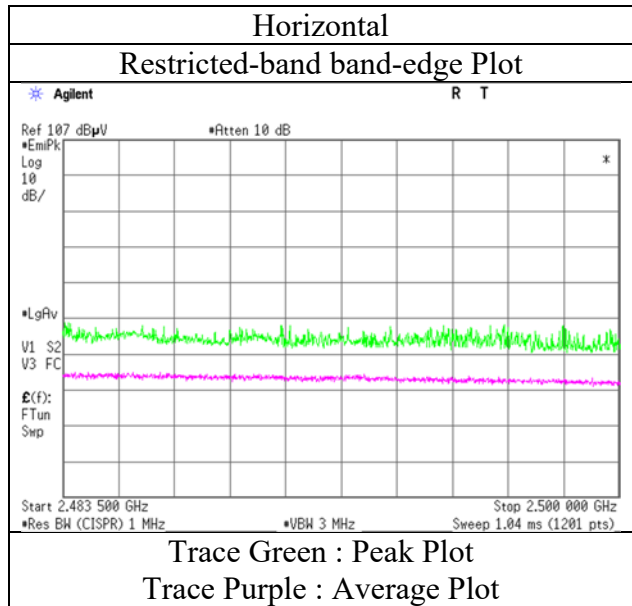

\* The measurement was conducted for a sufficiently long enough time to detect any possible spurious emissions. Final result of restricted band edge was shown in tabular data.

**Radiated Spurious Emission**  
**(Plot data, Worst case)**

Report No.	12699044S-AJ-R1			
Test place	Shonan EMC Lab.			
Semi Anechoic Chamber	No.3	No.3	No.1	No.3
Date	March 13, 2019	June 3, 2019	March 12, 2019	March 14, 2019
Temperature / Humidity	23 deg. C / 39 % RH	26 deg. C / 54 % RH	21 deg. C / 39 % RH	21 deg. C / 45 % RH
Engineer	Takahiro Suzuki (30 MHz - 1 GHz)	Hiromasa Sato (1 GHz - 2.8 GHz)	Kazuya Noda (2.8 GHz - 13 GHz)	Hiromasa Sato (13 GHz - 26.5 GHz)
Mode	Tx 11n-20 2412 MHz			

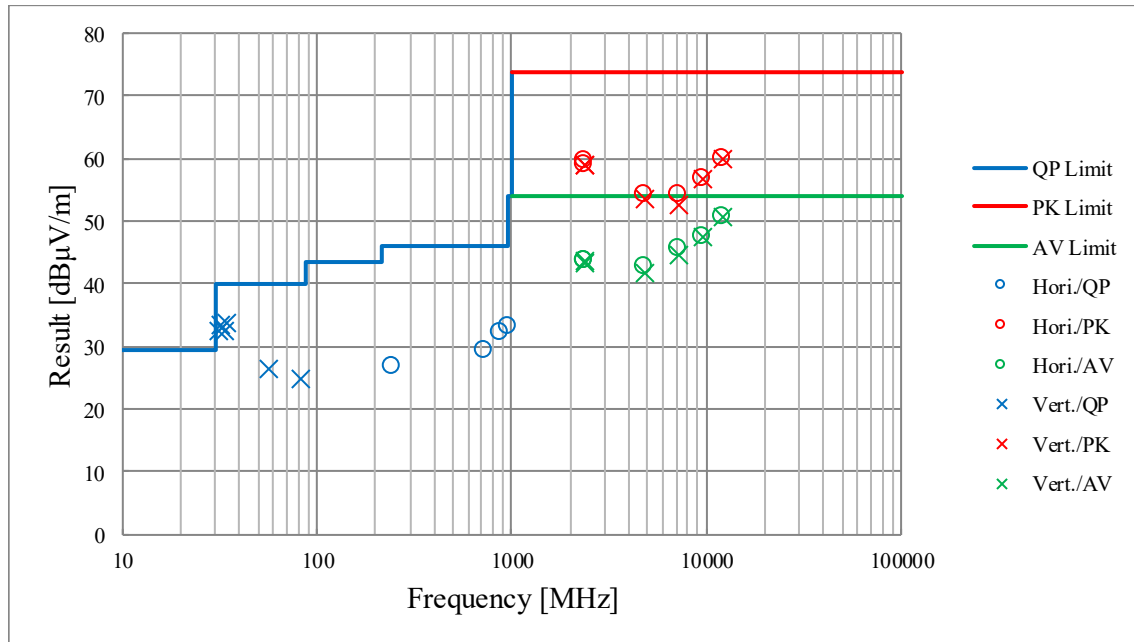

\*These plots data contains sufficient number to show the trend of characteristic features for EUT.

## Conducted Spurious Emission

Report No. 12699044S-AJ-R1  
Test place Shonan EMC Lab. No.5 Shielded Room  
Date June 3, 2019  
Temperature / Humidity 25 deg. C / 42 % RH  
Engineer Yosuke Ishikawa  
Mode Tx 11n-20 MIMO 2412 MHz

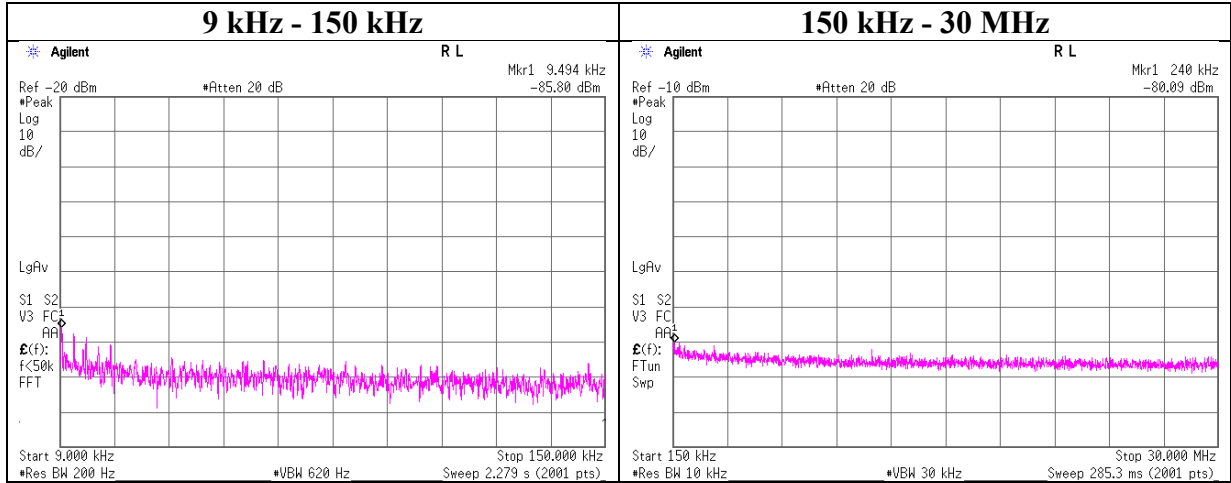

Frequency [kHz]	Reading [dBm]	Cable Loss [dB]	Attenuator Loss [dB]	Antenna Gain* [dBi]	N (Number of Output)	EIRP [dBm]	Distance [m]	Ground bounce [dB]	E (field strength) [dBuV/m]	Limit [dBuV/m]	Margin [dB]	Remark
9.494	-85.80	0.30	9.74	2.0	2	-70.7	300	6.0	-9.5	48.0	57.5	
240	-80.09	0.30	9.74	2.0	2	-65.0	300	6.0	-3.8	20.0	23.8	

$$E \text{ [dBuV/m]} = \text{EIRP [dBm]} - 20 \log (\text{Distance [m]}) + \text{Ground bounce [dB]} + 104.8 \text{ [dBuV/m]}$$

$$\text{EIRP [dBm]} = \text{Reading [dBm]} + \text{Cable loss [dB]} + \text{Attenuator Loss [dB]} + \text{Antenna gain [dBi]} + 10 * \log (N)$$

N: Number of output

\*2.0 dBi was applied to the test result based on KDB 558074 since antenna gain was less than 2.0 dBi.

## Power Density

Report No. 12699044S-AJ-R1  
Test place Shonan EMC Lab. No.5 Shielded Room  
Date May 31, 2019  
Temperature / Humidity 25 deg. C / 47 % RH  
Engineer Kazuya Noda  
Mode Tx 11b

### Antenna A + B

Freq. [MHz]	Antenna A	Antenna B	Result		Limit [dBm]	Margin [dB]
	Result [mW]	Result [mW]	[dBm]	[mW]		
2412.00	0.43	0.44	-0.60	0.87	8.00	8.60
2437.00	0.45	0.49	-0.28	0.94	8.00	8.28
2462.00	0.40	0.37	-1.08	0.78	8.00	9.08

Sample Calculation:

Result = Antenna A Result + Antenna B Result

### Antenna A

Freq. [MHz]	Reading [dBm]	Cable Loss [dB]	Atten. Loss [dB]	Result		Limit [dBm]	Margin [dB]
				[dBm]	[mW]		
2412.00	-14.80	1.25	9.92	-3.63	0.43	8.00	11.63
2437.00	-14.63	1.25	9.92	-3.46	0.45	8.00	11.46
2462.00	-15.11	1.26	9.92	-3.93	0.40	8.00	11.93

### Antenna B

Freq. [MHz]	Reading [dBm]	Cable Loss [dB]	Atten. Loss [dB]	Result		Limit [dBm]	Margin [dB]
				[dBm]	[mW]		
2412.00	-14.36	0.94	9.82	-3.60	0.44	8.00	11.60
2437.00	-13.90	0.95	9.82	-3.13	0.49	8.00	11.13
2462.00	-15.04	0.96	9.82	-4.26	0.37	8.00	12.26

Sample Calculation:

Result = Reading + Cable Loss (including the cable(s) customer supplied) + Attenuator Loss

## Power Density

Report No. 12699044S-AJ-R1  
Test place Shonan EMC Lab. No.5 Shielded Room  
Date May 31, 2019  
Temperature / Humidity 25 deg. C / 47 % RH  
Engineer Kazuya Noda  
Mode Tx 11g

### Antenna A + B

Freq. [MHz]	Antenna A	Antenna B	Result		Limit [dBm]	Margin [dB]
	Result [mW]	Result [mW]	[dBm]	[mW]		
2412.00	0.01	0.02	-15.39	0.03	8.00	23.39
2437.00	0.01	0.02	-14.79	0.03	8.00	22.79
2462.00	0.01	0.02	-15.10	0.03	8.00	23.10

Sample Calculation:

Result = Antenna A Result + Antenna B Result

### Antenna A

Freq. [MHz]	Reading [dBm]	Cable Loss [dB]	Atten. Loss [dB]	Result		Limit [dBm]	Margin [dB]
				[dBm]	[mW]		
2412.00	-29.86	1.25	9.92	-18.69	0.01	8.00	26.69
2437.00	-29.98	1.25	9.92	-18.81	0.01	8.00	26.81
2462.00	-29.73	1.26	9.92	-18.55	0.01	8.00	26.55

### Antenna B

Freq. [MHz]	Reading [dBm]	Cable Loss [dB]	Atten. Loss [dB]	Result		Limit [dBm]	Margin [dB]
				[dBm]	[mW]		
2412.00	-28.89	0.94	9.82	-18.13	0.02	8.00	26.13
2437.00	-27.75	0.95	9.82	-16.98	0.02	8.00	24.98
2462.00	-28.50	0.96	9.82	-17.72	0.02	8.00	25.72

Sample Calculation:

Result = Reading + Cable Loss (including the cable(s) customer supplied) + Attenuator Loss

## Power Density

Report No. 12699044S-AJ-R1  
Test place Shonan EMC Lab. No.5 Shielded Room  
Date May 31, 2019  
Temperature / Humidity 25 deg. C / 47 % RH  
Engineer Kazuya Noda  
Mode Tx 11n-20 CDD

### Antenna A + B

Freq. [MHz]	Antenna A	Antenna B	Result		Limit [dBm]	Margin [dB]
	Result [mW]	Result [mW]	[dBm]	[mW]		
2412.00	0.01	0.02	-15.24	0.03	8.00	23.24
2437.00	0.02	0.02	-14.37	0.04	8.00	22.37
2462.00	0.02	0.02	-14.49	0.04	8.00	22.49

Sample Calculation:

Result = Antenna A Result + Antenna B Result

### Antenna A

Freq. [MHz]	Reading [dBm]	Cable Loss [dB]	Atten. Loss [dB]	Result		Limit [dBm]	Margin [dB]
				[dBm]	[mW]		
2412.00	-29.43	1.25	9.92	-18.26	0.01	8.00	26.26
2437.00	-28.78	1.25	9.92	-17.61	0.02	8.00	25.61
2462.00	-29.05	1.26	9.92	-17.87	0.02	8.00	25.87

### Antenna B

Freq. [MHz]	Reading [dBm]	Cable Loss [dB]	Atten. Loss [dB]	Result		Limit [dBm]	Margin [dB]
				[dBm]	[mW]		
2412.00	-28.99	0.94	9.82	-18.23	0.02	8.00	26.23
2437.00	-27.94	0.95	9.82	-17.17	0.02	8.00	25.17
2462.00	-27.94	0.96	9.82	-17.16	0.02	8.00	25.16

Sample Calculation:

Result = Reading + Cable Loss (including the cable(s) customer supplied) + Attenuator Loss

## Power Density

Report No. 12699044S-AJ-R1  
Test place Shonan EMC Lab. No.5 Shielded Room  
Date June 3, 2019  
Temperature / Humidity 25 deg. C / 42 % RH  
Engineer Yosuke Ishikawa  
Mode Tx 11n-20 MIMO

### Antenna A + B

Freq. [MHz]	Antenna A	Antenna B	Result		Limit [dBm]	Margin [dB]
	Result [mW]	Result [mW]	[dBm]	[mW]		
2412.00	0.02	0.02	-14.58	0.03	8.00	22.58
2437.00	0.02	0.02	-14.21	0.04	8.00	22.21
2462.00	0.02	0.02	-13.88	0.04	8.00	21.88

Sample Calculation:

Result = Antenna A Result + Antenna B Result

### Antenna A

Freq. [MHz]	Reading [dBm]	Cable Loss [dB]	Atten. Loss [dB]	Result		Limit [dBm]	Margin [dB]
				[dBm]	[mW]		
2412.00	-29.10	1.25	9.92	-17.93	0.02	8.00	25.93
2437.00	-28.41	1.25	9.92	-17.24	0.02	8.00	25.24
2462.00	-28.96	1.26	9.92	-17.78	0.02	8.00	25.78

### Antenna B

Freq. [MHz]	Reading [dBm]	Cable Loss [dB]	Atten. Loss [dB]	Result		Limit [dBm]	Margin [dB]
				[dBm]	[mW]		
2412.00	-28.03	0.94	9.82	-17.27	0.02	8.00	25.27
2437.00	-27.97	0.95	9.82	-17.20	0.02	8.00	25.20
2462.00	-26.94	0.96	9.82	-16.16	0.02	8.00	24.16

Sample Calculation:

Result = Reading + Cable Loss (including the cable(s) customer supplied) + Attenuator Loss

## Power Density

Report No. 12699044S-AJ-R1  
Test place Shonan EMC Lab. No.5 Shielded Room  
Date June 3, 2019  
Temperature / Humidity 25 deg. C / 42 % RH  
Engineer Yosuke Ishikawa  
Mode Tx 11n-40 CDD

### Antenna A + B

Freq. [MHz]	Antenna A	Antenna B	Result		Limit [dBm]	Margin [dB]
	Result [mW]	Result [mW]	[dBm]	[mW]		
2422.00	0.01	0.01	-18.15	0.02	8.00	26.15
2437.00	0.01	0.01	-17.71	0.02	8.00	25.71
2452.00	0.01	0.01	-17.78	0.02	8.00	25.78

Sample Calculation:

Result = Antenna A Result + Antenna B Result

### Antenna A

Freq. [MHz]	Reading [dBm]	Cable Loss [dB]	Atten. Loss [dB]	Result		Limit [dBm]	Margin [dB]
				[dBm]	[mW]		
2422.00	-32.33	1.25	9.92	-21.16	0.01	8.00	29.16
2437.00	-31.88	1.25	9.92	-20.71	0.01	8.00	28.71
2452.00	-32.01	1.25	9.92	-20.84	0.01	8.00	28.84

### Antenna B

Freq. [MHz]	Reading [dBm]	Cable Loss [dB]	Atten. Loss [dB]	Result		Limit [dBm]	Margin [dB]
				[dBm]	[mW]		
2422.00	-31.91	0.94	9.82	-21.15	0.01	8.00	29.15
2437.00	-31.50	0.95	9.82	-20.73	0.01	8.00	28.73
2452.00	-31.52	0.95	9.82	-20.75	0.01	8.00	28.75

Sample Calculation:

Result = Reading + Cable Loss (including the cable(s) customer supplied) + Attenuator Loss



## Power Density

Report No. 12699044S-AJ-R1  
Test place Shonan EMC Lab. No.5 Shielded Room  
Date June 3, 2019  
Temperature / Humidity 25 deg. C / 42 % RH  
Engineer Yosuke Ishikawa  
Mode Tx 11n-40 MIMO

### Antenna A + B

Freq. [MHz]	Antenna A	Antenna B	Result		Limit [dBm]	Margin [dB]
	Result [mW]	Result [mW]	[dBm]	[mW]		
2412.00	0.01	0.01	-18.04	0.02	8.00	26.04
2437.00	0.01	0.01	-18.17	0.02	8.00	26.17
2462.00	0.01	0.01	-17.57	0.02	8.00	25.57

Sample Calculation:

Result = Antenna A Result + Antenna B Result

### Antenna A

Freq. [MHz]	Reading [dBm]	Cable Loss [dB]	Atten. Loss [dB]	Result		Limit [dBm]	Margin [dB]
				[dBm]	[mW]		
2412.00	-32.73	1.25	9.92	-21.56	0.01	8.00	29.56
2437.00	-32.72	1.25	9.92	-21.55	0.01	8.00	29.55
2462.00	-31.72	1.25	9.92	-20.55	0.01	8.00	28.55

### Antenna B

Freq. [MHz]	Reading [dBm]	Cable Loss [dB]	Atten. Loss [dB]	Result		Limit [dBm]	Margin [dB]
				[dBm]	[mW]		
2412.00	-31.35	0.94	9.82	-20.59	0.01	8.00	28.59
2437.00	-31.61	0.95	9.82	-20.84	0.01	8.00	28.84
2462.00	-31.39	0.95	9.82	-20.62	0.01	8.00	28.62

Sample Calculation:

Result = Reading + Cable Loss (including the cable(s) customer supplied) + Attenuator Loss

**Power Density**

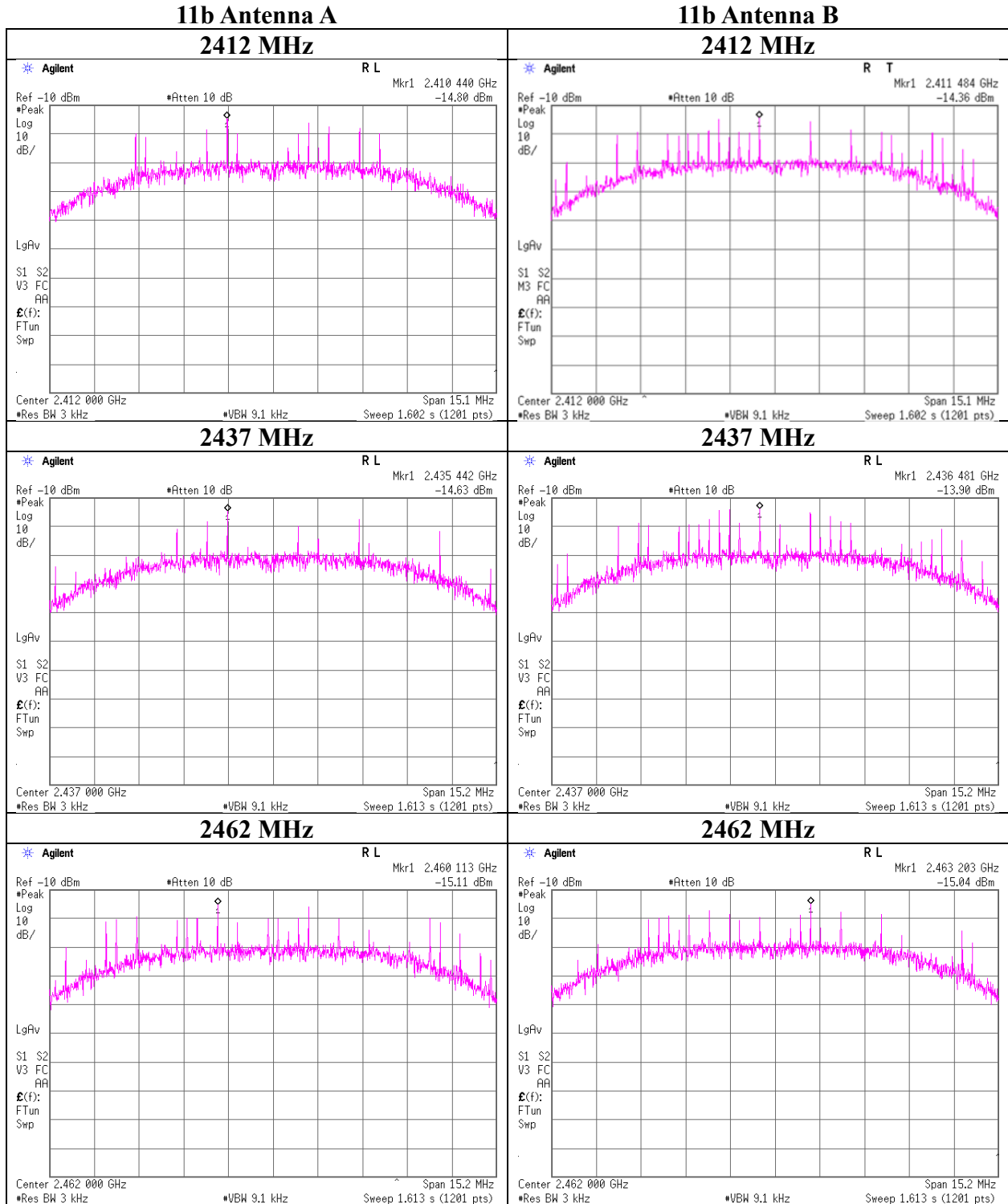

**UL Japan, Inc.**

**Shonan EMC Lab.**

1-22-3 Megumigaoka, Hiratsuka-shi, Kanagawa-ken, 259-1220 JAPAN

Telephone : +81 463 50 6400

Facsimile : +81 463 50 6401

**Power Density**

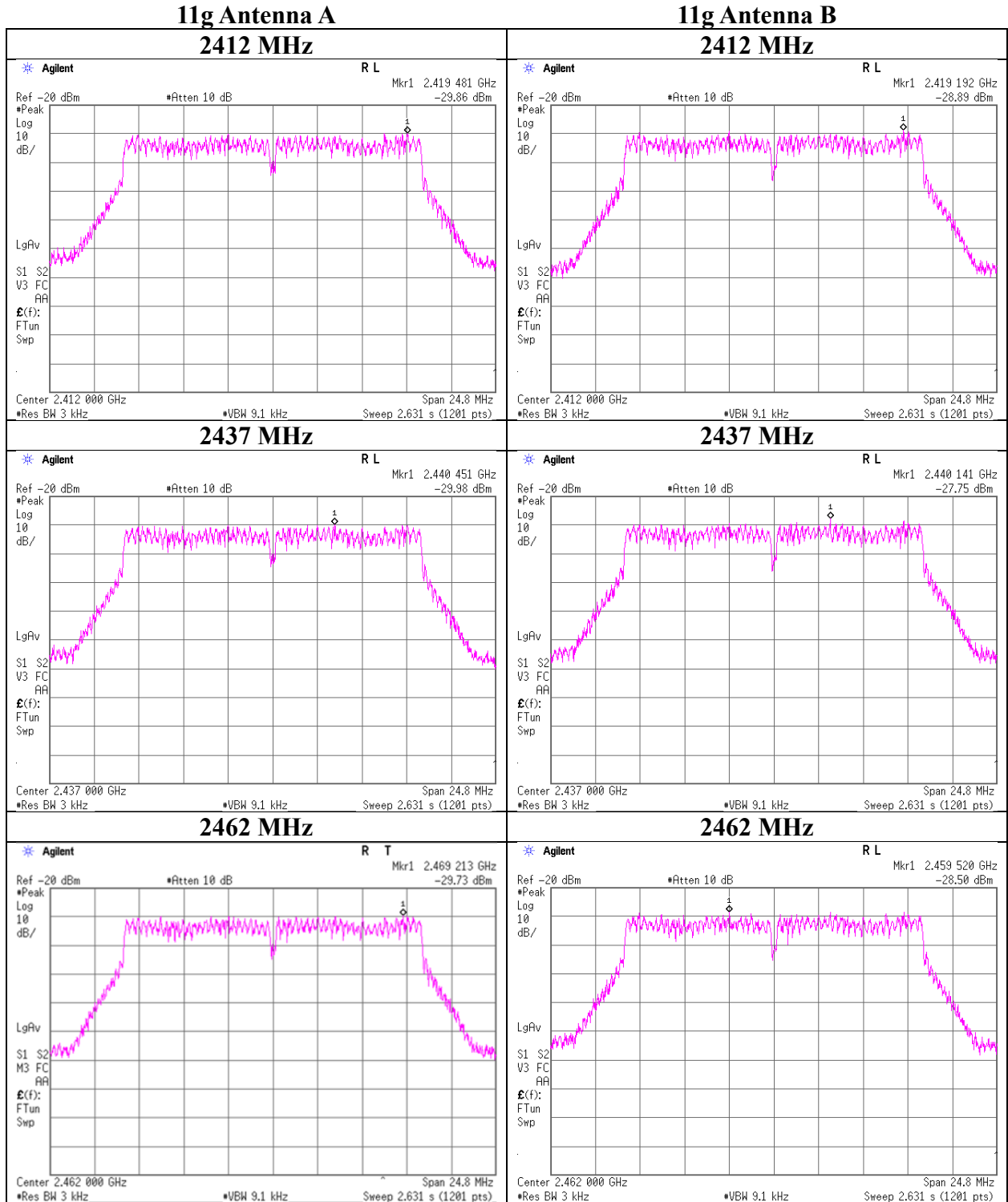

**UL Japan, Inc.**

**Shonan EMC Lab.**

1-22-3 Megumigaoka, Hiratsuka-shi, Kanagawa-ken, 259-1220 JAPAN

Telephone : +81 463 50 6400

Facsimile : +81 463 50 6401

**Power Density**

**11n-20 CDD Antenna A**

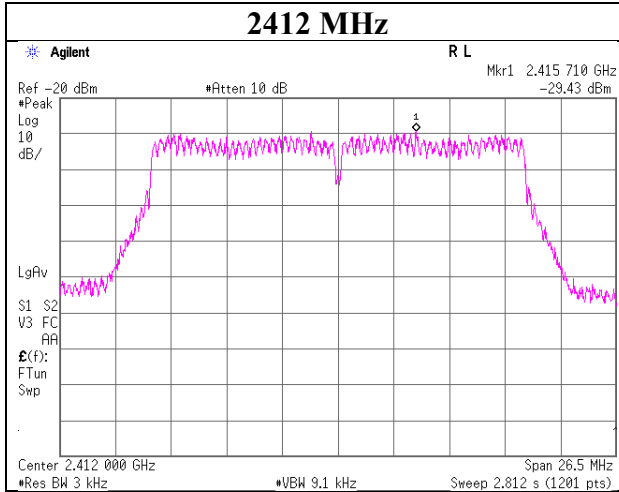

**11n-20 CDD Antenna B**

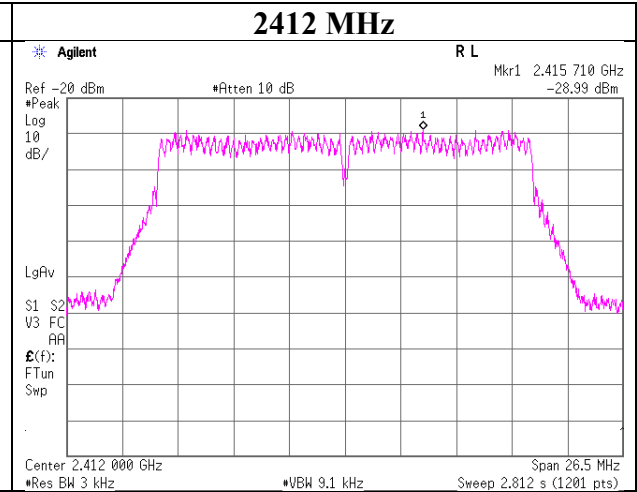

**2437 MHz**

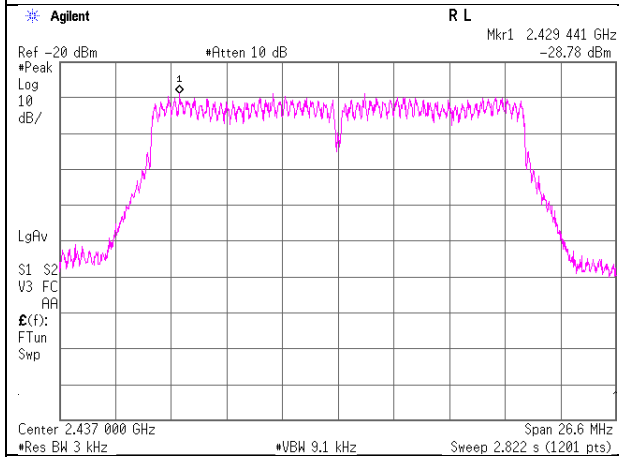

**2437 MHz**

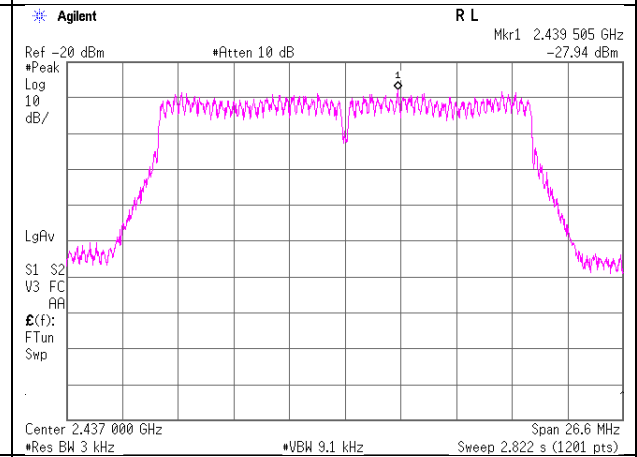

**2462 MHz**

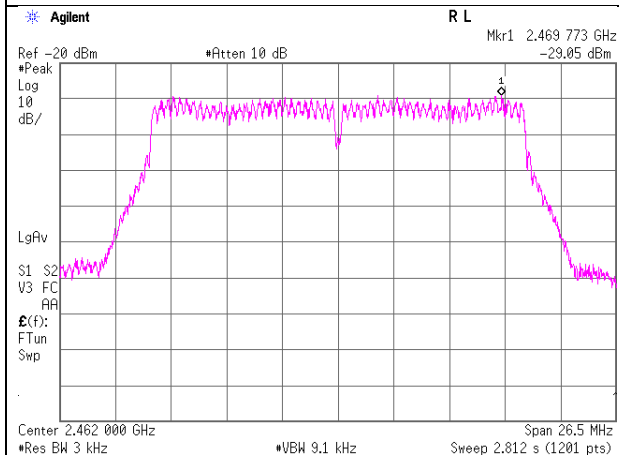

**2462 MHz**

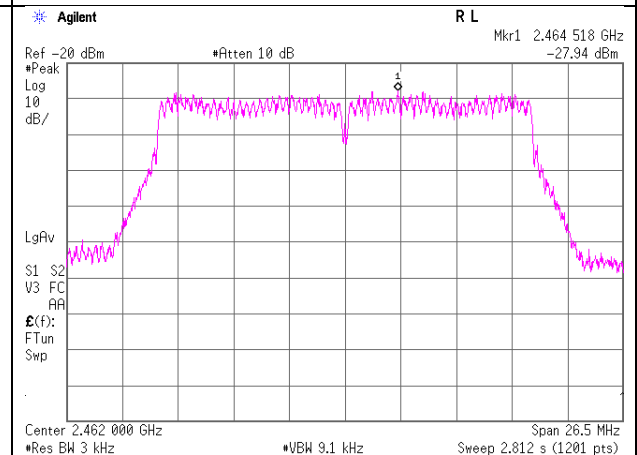

**UL Japan, Inc.**

**Shonan EMC Lab.**

1-22-3 Megumigaoka, Hiratsuka-shi, Kanagawa-ken, 259-1220 JAPAN

Telephone : +81 463 50 6400

Facsimile : +81 463 50 6401

**Power Density**

**11n-20 MIMO Antenna A**

**11n-20 MIMO Antenna B**

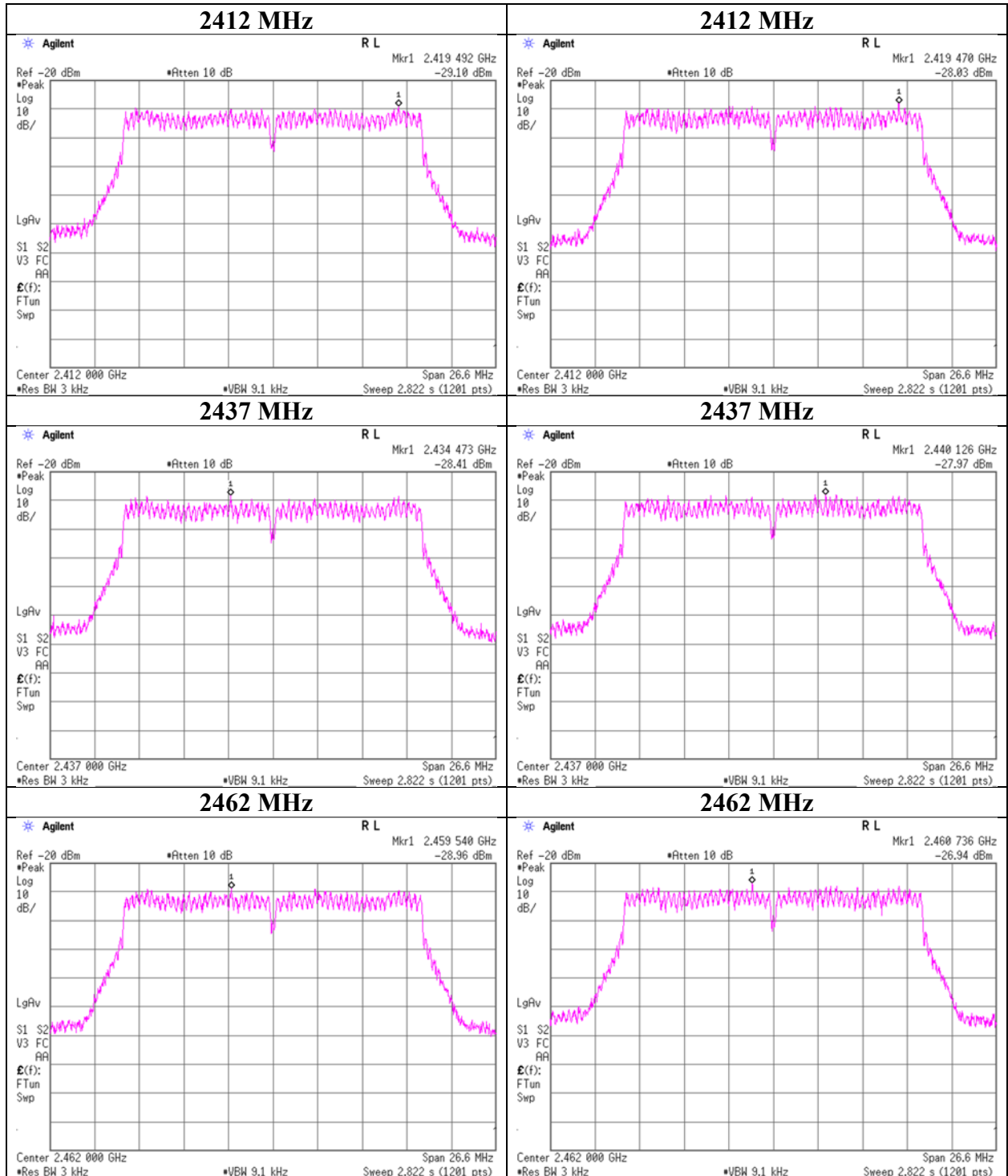

**UL Japan, Inc.**

**Shonan EMC Lab.**

1-22-3 Megumigaoka, Hiratsuka-shi, Kanagawa-ken, 259-1220 JAPAN

Telephone : +81 463 50 6400

Facsimile : +81 463 50 6401

**Power Density**

**11n-40 CDD Antenna A**

**11n-40 CDD Antenna B**

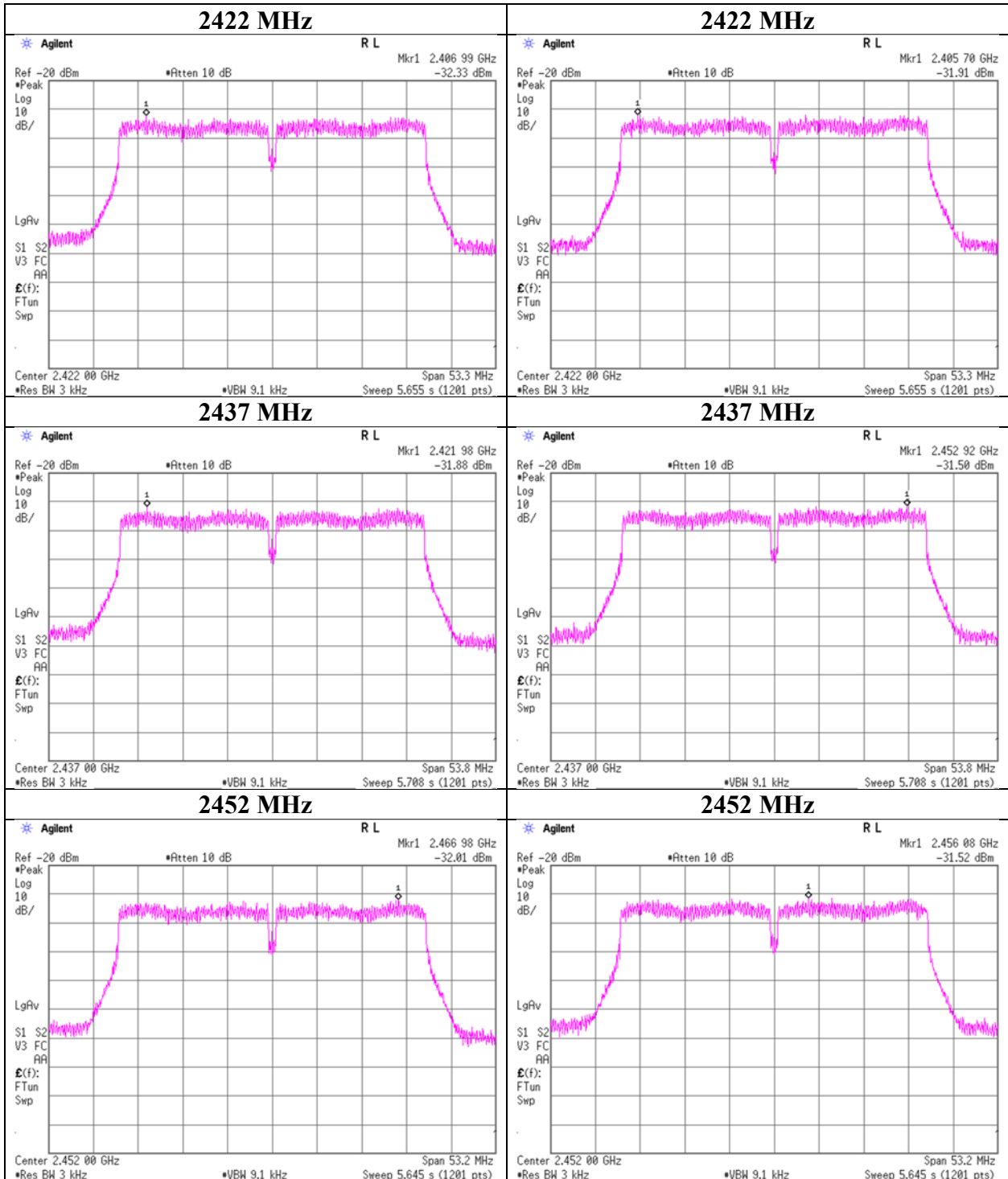

**UL Japan, Inc.**

**Shonan EMC Lab.**

1-22-3 Megumigaoka, Hiratsuka-shi, Kanagawa-ken, 259-1220 JAPAN

Telephone : +81 463 50 6400

Facsimile : +81 463 50 6401

**Power Density**

**11n-40 MIMO Antenna A**

**11n-40 MIMO Antenna B**

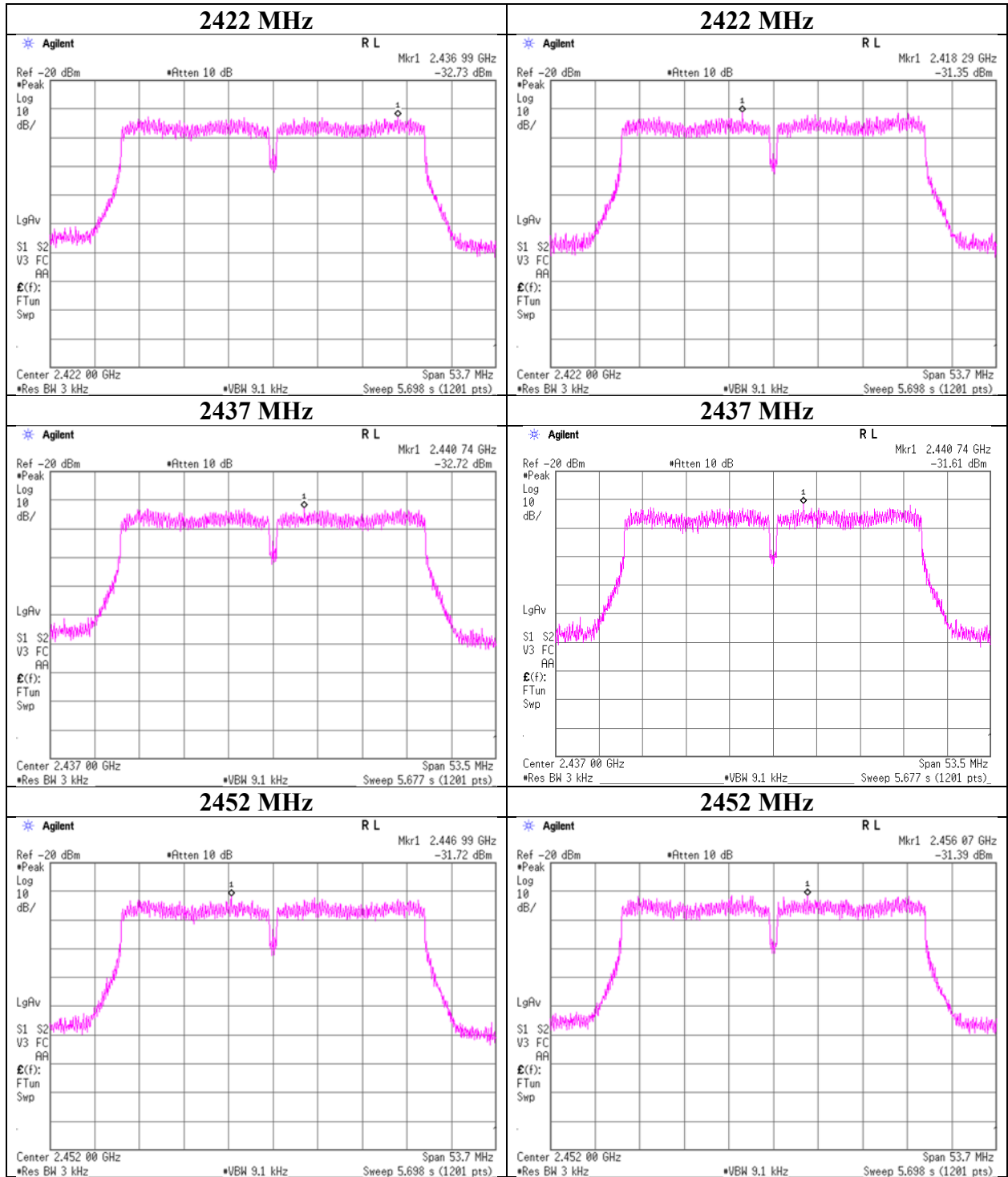

**UL Japan, Inc.**

**Shonan EMC Lab.**

1-22-3 Megumigaoka, Hiratsuka-shi, Kanagawa-ken, 259-1220 JAPAN

Telephone : +81 463 50 6400

Facsimile : +81 463 50 6401

## **APPENDIX 2: Test instruments**

### **Test Instruments (1 / 3)**

Local ID	Test Name	LIMS ID	Description	Manufacturer	Model	Serial	Last Calibration Date	Calibration Due Date	Calibration Interval (Month)
KTS-07	AT	145111	Digital Tester	SANWA	PC500	7019232	2018/10/17	2019/10/31	12
SAT10-12	AT	151609	Attenuator	Weinschel Corp.	54A-10	81601	2019/3/27	2020/3/31	12
SAT10-14	AT	154591	Attenuator	Weinschel Corp.	54A-10	81595	2019/4/16	2020/4/30	12
SCC-G38	AT	151615	Coaxial Cable	Junkosha	MWX241-01000KMSK MS/B	1612Q036	2018/12/25	2019/12/31	12
SCC-G39	AT	151616	Coaxial Cable	Junkosha	MWX241-01000KMSK MS/B	1612Q037	2018/12/25	2019/12/31	12
SOS-19	AT	175823	Humidity Indicator	CUSTOM	CTH-201	-	2018/12/5	2019/12/31	12
SPM-13	AT	169910	Power Meter	EMC Instruments Corporation	8990B	MY51000448	2019/3/6	2020/3/31	12
SPSS-06	AT	169911	Power sensor	EMC Instruments Corporation	N1923A	MY57270004	2019/3/6	2020/3/31	12
SPSS-07	AT	169912	Power sensor	EMC Instruments Corporation	N1923A	MY57290005	2019/3/6	2020/3/31	12
STM-G4	AT	145787	Terminator	Weinschel - API Technologies Corp	M1459A	U6592	2019/7/4	2020/7/31	12
SSA-02	AT,RE	145800	Spectrum Analyzer	AGILENT	E4448A	MY48250106	2019/4/4	2020/4/30	12
KAT3-12	CE	144896	Attenuator	JFW IND. INC.	50HF-003N	-	2019/7/18	2020/7/31	12
SCC-C9	CE	145035	Coaxial Cable	Suhner	RG223U	-	2019/4/19	2020/4/30	12
SJM-09	CE	145336	Measure	PROMART	SEN1935	-	-	-	-
SLS-03	CE	145540	LISN	Rohde & Schwarz	ENV216	100513	2019/2/21	2020/2/29	12
SLS-04	CE	145541	LISN	Rohde & Schwarz	ENV216	100514	2019/2/21	2020/2/29	12
SOS-04	CE	146292	Humidity Indicator	A&D	AD-5681	4061512	2018/12/5	2019/12/31	12
STM-11	CE	145764	Terminator	TME	CT-01 BP	-	2018/12/25	2019/12/31	12
STR-02	CE	145791	Test Receiver	Rohde & Schwarz	ESCI	100575	2018/10/19	2019/10/31	12
STS-02	CE	145793	Digital Hitester	HIOKI	3805-50	80997819	2019/4/2	2020/4/30	12
COTS-SEMI-5	CE,RE	170932	EMI Software	TSJ	TEPTO-DV3(RE,CE,ME,PE)	-	-	-	-
KJM-02	RE	146432	Measure	TAJIMA	GL19-55	-	-	-	-
KJM-09	RE	145929	Measure	KOMELON	KMC-36	-	-	-	-
KSA-08	RE	145089	Spectrum Analyzer	AGILENT	E4446A	MY46180525	2018/10/7	2019/10/31	12

**UL Japan, Inc.**

**Shonan EMC Lab.**

1-22-3 Megumigaoka, Hiratsuka-shi, Kanagawa-ken, 259-1220 JAPAN

Telephone : +81 463 50 6400

Facsimile : +81 463 50 6401



Test Instruments ( 2 / 3 )

Local ID	Test Name	LIMS ID	Description	Manufacturer	Model	Serial	Last Calibration Date	Calibration Due Date	Calibration Interval (Month)
SAEC-01(SVSWR)	RE	145561	Semi-Anechoic Chamber	TDK	SAEC-01(SVSWR)	1	2019/5/6	2020/5/30	12
SAEC-03(NSA)	RE	145565	Semi-Anechoic Chamber	TDK	SAEC-03(NSA)	3	2019/4/8	2020/4/30	12
SAEC-03(SVSWR)	RE	145566	Semi-Anechoic Chamber	TDK	SAEC-03(SVSWR)	3	2019/5/3	2020/5/31	12
SAF-03	RE	145126	Pre Amplifier	SONOMA	310N	290213	2019/2/5	2020/2/29	12
SAF-04	RE	145127	Pre Amplifier	Toyo Corporation	TPA0118-36	2072554	2019/6/4	2020/6/30	12
SAF-06	RE	145005	Pre Amplifier	Toyo Corporation	TPA0118-36	1440491	2019/2/8	2020/2/29	12
SAF-08	RE	145007	Pre Amplifier	Toyo Corporation	HAP18-26W	19	2019/3/5	2020/3/31	12
SAF-09	RE	145008	Pre Amplifier	Toyo Corporation	HAP18-26W	18	2018/9/21	2019/9/30	12
SAT10-05	RE	145136	Attenuator(above1GHz)	AGILENT	8493C-010	74864	2018/11/25	2019/11/30	12
SAT6-13	RE	167094	Attenuator	JFW	50HF-006N	-	2019/2/5	2020/2/29	12
SBA-03	RE	145023	Biconical Antenna	Schwarzbeck	BBA9106	91032666	2019/5/7	2020/5/31	12
SCC-C1/C2/C3/C4/C5/C10/SRSE-03	RE	145171	Coaxial Cable&RF Selector	Fujikura/Fujikura/Suhner/Suhner/Suhner/Suhner/TOYO	8D2W/12DSFA/141PE/141PE/141PE/141P	-/0901-271(RF Selector)	2019/4/19	2020/4/30	12
SCC-G05	RE	145039	Coaxial Cable	Junkosha	J12J102207-00	APR-30-15-037	2019/1/25	2020/1/31	12
SCC-G40	RE	166491	Coaxial Cable	Junkosha	MWX221-01000NFSN MS/B	1612S005	2019/1/25	2020/1/31	12
SCC-G43	RE	156380	Coaxial Cable	HUBER+SUNER	SUCOFLEX_104 E	SN MY 13406/4E	2019/7/3	2020/7/31	12
SCC-G44	RE	168300	Coaxial Cable	HUBER+SUNER	SUCOFLEX 104	800070/4A	2019/3/26	2020/3/31	12
SCC-G45	RE	168301	Coaxial Cable	HUBER+SUNER	SUCOFLEX 102 E	800137/2EA	2019/3/26	2020/3/31	12
SFL-02	RE	145301	Highpass Filter	MICRO-TRONICS	HPM50111	51	2018/11/16	2019/11/30	12
SFL-18	RE	145305	Highpass Filter	MICRO-TRONICS	HPM50111	119	2019/4/16	2020/4/30	12
SHA-01	RE	145383	Horn Antenna	Schwarzbeck	BBHA9120D	9120D-725	2019/5/9	2020/5/31	12
SHA-03	RE	145501	Horn Antenna	Schwarzbeck	BBHA9120D	9120D-739	2019/6/26	2020/6/30	12
SHA-04	RE	145512	Horn Antenna	ETS LINDGREN	3160-09	00094868	2019/6/26	2020/6/30	12
SHA-05	RE	145513	Horn Antenna	ETS LINDGREN	3160-09	00094867	2019/6/26	2020/6/30	12
SLA-07	RE	145529	Logperiodic Antenna	Schwarzbeck	VUSLP9111B	196	2019/5/7	2020/5/31	12
SOS-01	RE	146316	Humidity Indicator	A&D	AD-5681	4062555	2018/10/25	2019/10/31	12
SOS-05	RE	146293	Humidity Indicator	A&D	AD-5681	4062518	2018/10/25	2019/10/31	12
SSA-03	RE	145801	Spectrum Analyzer	AGILENT	E4448A	MY48250152	2018/8/30	2019/8/31	12
STR-08	RE	150463	Test Receiver	Rohde & Schwarz	ESW44	101581	2018/11/28	2019/11/30	12

**UL Japan, Inc.**  
**Shonan EMC Lab.**

1-22-3 Megumigaoka, Hiratsuka-shi, Kanagawa-ken, 259-1220 JAPAN  
Telephone : +81 463 50 6400  
Facsimile : +81 463 50 6401

**Test Instruments (3 / 3)**

Local ID	Test Name	LIMS ID	Description	Manufacturer	Model	Serial	Last Calibration Date	Calibration Due Date	Calibration Interval (Month)
STS-01	RE	145792	Digital Hitester	HIOKI	3805-50	80997812	2018/10/16	2019/10/31	12
STS-03	RE	146210	Digital Hitester	HIOKI	3805-50	80997823	2018/10/16	2019/10/31	12
SCC-G22 *1)	RE	145180	Coaxial Cable	Suhner	SUCOFLEX 104	296199/4	2018/5/11	2019/5/31	12
SCC-G33 *1)	RE	145184	Coaxial Cable	Junkosha	MWX241-01000KMSK MS	-	2018/4/20	2019/4/30	12

**\*1) This test equipment was used for the tests before the expiration date of the calibration.  
It is not used in tests after the calibration due date.**

**\*Hyphens for Last Calibration Date, Calibration Due Date and Cal Int (month) are instruments that Calibration is not required (e.g. software), or instruments checked in advance before use.**

**The expiration date of the calibration is the end of the expired month.  
All equipment is calibrated with valid calibrations. Each measurement data is traceable to the national or international standards.**

**As for some calibrations performed after the tested dates, those test equipment have been controlled by means of an unbroken chains of calibrations.**

**Test item: CE: Conducted Emission test  
RE: Radiated Emission test  
AT: Antenna Terminal Conducted test**