



# EMI TEST REPORT

**Test Report No. : 31CE0052-HO-01-L**

**Applicant** : CANON INC.  
**Type of Equipment** : Wireless Module  
**Model No.** : CH9-1225  
**FCC ID** : AZD214  
**Test regulation** : FCC Part 15 Subpart E: 2011  
Section 15.407(DFS test only)  
**Test Result** : Complied

1. This test report shall not be reproduced in full or partial, without the written approval of UL Japan, Inc.
2. The results in this report apply only to the sample tested.
3. This sample tested is in compliance with above regulation.
4. The test results in this report are traceable to the national or international standards.

**Date of test** : July 21, 2011

**Representative test engineer:**

Tatsuya Arai  
Engineer of WiSE Japan, UL  
Verification Service

**Approved by :**

Toyokazu Imamura  
Assistant Manager of WiSE Japan, UL  
Verification Service

**UL Japan, Inc.**

**Shonan EMC Lab.**

1-22-3 Megumigaoka, Hiratsuka-shi, Kanagawa-ken, 259-1220 JAPAN

Telephone: +81 463 50 6400

Facsimile: +81 463 50 6401

13-EM-F0429

<b>CONTENTS</b>	<b>PAGE</b>
<b>SECTION 1: Customer information.....</b>	<b>3</b>
<b>SECTION 2: Equipment under test (E.U.T.).....</b>	<b>3</b>
<b>SECTION 3: Scope of Report.....</b>	<b>4</b>
<b>SECTION 4: Test specification, procedures &amp; results.....</b>	<b>4</b>
<b>SECTION 5: Operation of E.U.T. during testing.....</b>	<b>9</b>
<b>SECTION 6: In-Service Monitoring for Channel Move Time, Channel Closing Transmission Time.....</b>	<b>16</b>
<b>SECTION 7: In-Service Monitoring for Non-Occupancy Period.....</b>	<b>20</b>
<b>APPENDIX 1: Photographs of test setup.....</b>	<b>22</b>
<b>APPENDIX 2: Data of DFS test.....</b>	<b>23</b>
<b>Parameter Data for Radar Type 5.....</b>	<b>23</b>
<b>APPENDIX 3: Test instruments.....</b>	<b>24</b>

---

**UL Japan, Inc.**

**Shonan EMC Lab.**

1-22-3 Megumigaoka, Hiratsuka-shi, Kanagawa-ken, 259-1220 JAPAN

Telephone: +81 463 50 6400

Facsimile: +81 463 50 6401

## **SECTION 1: Customer information**

Company Name : CANON INC.  
Address : 30-2, Shimomaruko 3-chome, Ohta-ku, Tokyo, 146-8501 Japan  
Telephone Number : +81-3-3757-6798  
Facsimile Number : +81-3-3757-8431  
Contact Person : Kiyoshi Sahoyama

## **SECTION 2: Equipment under test (E.U.T.)**

### **2.1 Identification of E.U.T.**

Type of Equipment : Wireless Module  
Model No. : CH9-1225  
Serial No. : ES4015  
Rating : DC3.3V  
Country of Mass-production : Japan  
Condition of EUT : Production prototype  
(Not for Sale: This sample is equivalent to mass-produced items.)  
Modification of EUT : No modification by the test lab.  
Receipt Date of Sample : July 19, 2011

### **2.2 Product description**

Model: CH9-1225 (referred to as the EUT in this report) is a Wireless Module.

Equipment type : Transceiver  
Frequency of operation : 2412-2462MHz (802.11b, 11g, 11n-HT20)  
2422-2452MHz (802.11n-HT40)  
5180-5320MHz (802.11a, 11n-HT20)  
5190-5310MHz (802.11n-HT40)  
5745-5825MHz (802.11a, 11n-HT20)  
5755-5795MHz (802.11n-HT40)  
Clock frequency : 38.4MHz, 32.768kHz  
Bandwidth & channel spacing : Bandwidth :  
20MHz (802.11b, 11g, 11a, 11n-HT20), 40MHz (802.11n-HT40)  
Channel spacing :  
5MHz (2.4GHz), 20MHz (5GHz)  
Type of modulation : DSSS(IEEE 802.11b)  
OFDM(IEEE 802.11a/g/n)  
Antenna type : Planar Inverted F Antenna  
Antenna gain with cable loss : +1.95 dBi (2400/2450/2500MHz)  
-1.32 dBi (5160/5250/5340MHz)  
-0.43 dBi (5725/5785/5845MHz)  
Antenna connector type : U.FL  
ITU code : D1D, G1D  
Operation temperature range : -20 to +70 deg.C.

\*2) Refer to the test report 31CE0052-HO-01-J for FCC15.247.

FCC Part15.31 (e)

The Wireless Module is provided with stable power supply DC 3.3V from the host device and has power supply regulator which provides DC 2.85V and DC 1.8V, therefore, the equipment complies power supply regulation.

FCC Part15.203 Antenna requirement

The EUT has a unique coupling/antenna connector (U.FL). Therefore the equipment complies with the requirement of 15.203.

---

**UL Japan, Inc.**

**Shonan EMC Lab.**

1-22-3 Megumigaoka, Hiratsuka-shi, Kanagawa-ken, 259-1220 JAPAN

Telephone: +81 463 50 6400

Facsimile: +81 463 50 6401

### **SECTION 3: Scope of Report**

The EUT has the channels from 5180 to 5320MHz.

This report only covers DFS requirement subject to 5250-5350MHz bands, as specified by the following referenced procedures.

### **SECTION 4: Test specification, procedures & results**

#### **4.1 Test Specification**

Test Specification : FCC Part 15 Subpart E: 2011, final revised on July 8, 2011  
and effective August 8, 2011

Title : FCC 47CFR Part15 Radio Frequency Device  
Subpart E Unlicensed National Information Infrastructure Devices  
Section 15.407 General technical requirements

\*The revision on July 8, 2011 does not affect the test specification applied to the EUT.

Test Specification : FCC 06-96 APPENDIX  
Title : COMPLIANCE MEASUREMENT PROCEDURES FOR UNLICENSED-  
NATIONAL INFORMATION INFRASTRUCTURE DEVICES  
OPERATING IN THE 5250-5350 MHz AND 5470-5725MHz BANDS  
INCORPORATING DYNAMIC FREQUENCY SELECTION

## 4.2 Procedures and results

**Table 1: Applicability of DFS Requirements**

Requirement	Operating Mode	Test Procedures & Limits	Deviation	Results
	Client without Radar Detection			
U-NII Detection Bandwidth	Not required	FCC 06-96 Appendix 7.8.1	N/A	N/A
Initial Channel Availability Check Time	Not required	FCC15.407 (h)	N/A	N/A
		FCC 06-96 Appendix 7.8.2.1		
		RSS-210 A9.4		
Radar Burst at the Beginning of the Channel Availability Check Time	Not required	FCC15.407 (h)	N/A	N/A
		FCC 06-96 Appendix 7.8.2.2		
		RSS-210 A9.4		
Radar Burst at the End of the Channel Availability Check Time	Not required	FCC15.407 (h)	N/A	N/A
		FCC 06-96 Appendix 7.8.2.3		
		RSS-210 A9.4		
In-Service Monitoring for Channel Move Time, Channel Closing Transmission Time	Yes	FCC15.407 (h)	N/A	Complied
		FCC 06-96 Appendix 7.8.3		
		RSS-210 A9.4		
In-Service Monitoring for Non-Occupancy period	Yes *	FCC15.407 (h)	N/A	Complied
		FCC 06-96 Appendix 7.8.3		
		RSS-210 A9.4		
Statistical Performance Check	Not required	FCC15.407 (h)	N/A	N/A
		FCC 06-96 Appendix 7.8.4		

\*Although this test was not required in FCC 06-96, it was performed as additional test.

**Table 2: DFS Detection Thresholds for Master Devices and Client Devices With Radar**

Maximum Transmit Power	Value (See Notes 1 and 2)
≥ 200 milliwatt	-64 dBm
< 200 milliwatt	-62 dBm
<p>Note 1: This is the level at the input of the receiver assuming a 0 dBi receive antenna.</p> <p>Note 2: Throughout these test procedures an additional 1 dB has been added to the amplitude of the test transmission waveforms to account for variations in measurement equipment. This will ensure that the test signal is at or above the detection threshold level to trigger a DFS response.</p>	

## UL Japan, Inc. Shonan EMC Lab.

1-22-3 Megumigaoka, Hiratsuka-shi, Kanagawa-ken, 259-1220 JAPAN  
Telephone: +81 463 50 6400  
Facsimile: +81 463 50 6401

**Table 3 DFS Response Requirement Values**

<b>Parameter</b>	<b>Value</b>
Non-occupancy period	Minimum 30 minutes
Channel Availability Check Time	60 seconds
Channel Move Time	10 seconds See Note 1
Channel Closing Transmission Time	200 milliseconds + an aggregate of 60 milliseconds over remaining 10 second period. See Notes 1 and 2
U-NII Detection Bandwidth	Minimum 80% of the U-NII 99% transmission power bandwidth See Note 3
<p><b>Note 1:</b> The instant that the Channel Move Time and the Channel Closing Transmission Time begins is as follows:</p> <ul style="list-style-type: none"> <li>• For the Short Pulse Radar Test Signals this instant is the end of the <i>Burst</i>.</li> <li>• For the Frequency Hopping radar Test Signal, this instant is the end of the last radar <i>Burst</i> generated</li> <li>• For the Long Pulse Radar Test Signal this instant is the end of the 12 second period defining the <i>Radar Waveform</i>.</li> </ul> <p><b>Note 2:</b> The Channel Closing Transmission Time is comprised of 200 milliseconds starting at the beginning of the Channel Move Time plus any additional intermittent control signals required to facilitate a Channel move (an aggregate of 60 milliseconds) during the remainder of the 10 second period. The aggregate duration of control signal will not count quiet periods in between transmissions.</p> <p><b>Note 3:</b> During the U-NII Detection Bandwidth detection test, radar type 1 is used and for each frequency step the minimum percentage of detection is 90 percent. Measurements are performed with no data traffic.</p>	

**Table 4 Short Pulse Radar Test Waveform**

Radar Type	Pulse Width (μsec)	PRI (μsec)	Number of Pulses	Minimum Percentage of Successful Detection	Minimum Number of Trials
1	1	1428	18	60%	30
2	1-5	150-230	23-29	60%	30
3	6-10	200-500	16-18	60%	30
4	11-20	200-500	12-16	60%	30
Aggregate (Rader Types 1-4)				80%	120

**Table 5 Long Pulse Radar Test Waveform**

Radar Type	Pulse Width (μsec)	Chip Width (MHz)	PRI (μsec)	Number of Pulses per Burst	Number of Burst	Minimum Percentage of Successful Detection	Minimum Number of Trials
5	50-100	5-20	1000-2000	1-3	8-20	80%	30

**Table 6 Frequency Hopping Radar Test Waveform**

Radar Type	Pulse Width (μsec)	PRI (μsec)	Pulse per Hop (kHz)	Hopping Rate (kHz)	Hopping Sequence Length (msec)	Minimum Percentage of Successful Detection	Minimum Number of Trials
6	1	333	9	0.333	300	70%	30

#### 4.3 Test Location

UL Japan, Inc. Shonan EMC Lab.  
1-22-3, Megumigaoka, Hiratsuka-shi, Kanagawa-ken 259-1220 JAPAN  
Telephone number : +81 463 50 6400  
Facsimile number : +81 463 50 6401

No.1/ No.2/ No.3 anechoic chamber has been fully described in a report submitted to FCC office, and accepted on April 17, 2009 (Registration No.: 697847).

IC Registration No. : 2973D-1 (No1 anechoic chamber)  
2973D-2 (No2 anechoic chamber)  
2973D-3 (No3 anechoic chamber)

Test room	Width x Depth x Height (m)	Test room	Width x Depth x Height (m)
No.1 Semi-anechoic chamber	20.6 x 11.3 x 7.65 Maximum measurement distance: 10m	No.1 Shielded room	6.8 x 4.1 x 2.7
No.2 Semi-anechoic chamber	20.6 x 11.3 x 7.65 Maximum measurement distance: 10m	No.2 Shielded room	6.8 x 4.1 x 2.7
No.3 Semi-anechoic chamber	12.7 x 7.7 x 5.35 Maximum measurement distance: 5m	No.3 Shielded room	6.3 x 4.7 x 2.7
No.4 Full-anechoic chamber	8.1 x 5.1 x 3.55	No.4 Shielded room	4.4 x 4.7 x 2.7
		No.5 Shielded room	7.8 x 6.4 x 2.7
		No.6 Shielded room	7.8 x 6.4 x 2.7

#### 4.4 Test set up, Data of DFS test, and Test instruments of DFS

Refer to APPENDIX 1 to 3.



## **SECTION 5: Operation of E.U.T. during testing**

### **5.1 Operating Modes**

The EUT, which is a Client Device without Radar detection capability, operates over the 5260-5320MHz (802.11a, 11n-HT20) and 5270-5310MHz (802.11n-HT40).

As for the test, 802.11n-HT20 and 11n-HT-40 were carried out as a representative.

The highest power level is 11.94dBm (11n-HT20) / 11.97dBm (11n-HT40) EIRP in the 5250-5350MHz band.  
The lowest power level is 11.59dBm (11n-HT20) / 11.77dBm (11n-HT40) EIRP in the 5250-5350MHz band.

Power level of the EUT[dBm]

Antenna	Mode	Antenna Gain [dBi]	5250-5350MHz Band	
			Output Power (Min)	Output Power(Max)
Planar Inverted F Antenna *1)	11n-HT20	-1.32	12.91	13.26
	11n-HT40	-1.32	13.09	13.29

\*1) Refer to 31CE0052-HO-01-C, FCC Part 15E (FCC 15.407) report for other parts than DFS.

The lowest antenna assembly gain of all available antenna assemblies is -1.32dBi.

The EUT uses one transmitter connected to two 50-ohm coaxial antenna ports via a diversity switch. Both antenna ports are connected to the test system via a power divider to perform conducted tests.

WLAN traffic is generated by streaming the MPEG Test file "6 ½ Magic Hours" from the Master to the Client in full motion video mode using the media player with the V2.61 Codec package.

The FCC ID for the Master Device used with EUT for DFS testing is LDK102061.

The rated output power of the Master unit is >200mW(23dBm). Therefore the required interference threshold level is -64 dBm. After correction for antenna gain and procedural adjustments, the required conducted threshold at the antenna port is  $-64 + 1 + 3.5 = -59.5$  dBm (threshold level + additional 1dB + antenna gain).

## 5.2 Configuration and peripherals

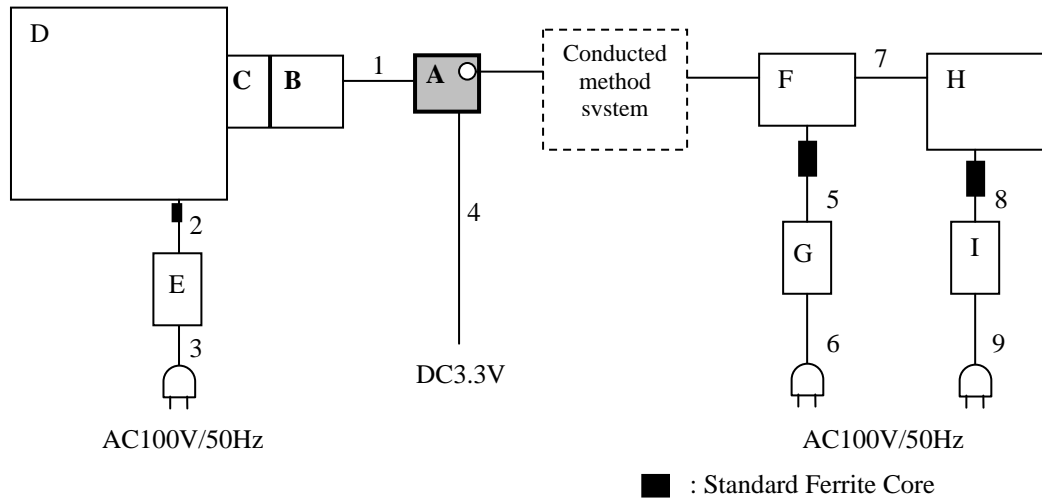

### Description of EUT and Support equipment

No.	Item	Model number	Serial number	Manufacturer	Remarks
A	Wireless Module	CH9-1225	ES4015	CANON	EUT
B	Test Jig	-	-	-	-
C	SDIO Adapter	SK-1520	SK018C041	MARVELL	-
D	PC	CF-F9LWFJDS	0KKSA18275	Panasonic	-
E	AC Adapter	CF-AA6502A M1	6502AM110901414D	Panasonic	-
F	Wireless LAN access point (Master Device)	AIR-AP1252AG-A-K9	FTX130390F4	Cisco Systems	-
G	AC Adapter	EADP-45BB	DTH1241908P	Cisco Systems	-
H	Note PC	DELL Vostro V1510	29090510205	Dell	-
I	ACAdapter	LA65NS1-00	71615-93B-385D	Dell	-

### List of cables used

No.	Name	Length (m)	Shield	
			Cable	Connector
1	IF Cable	0.05	Unshielded	Unshielded
2	DC Cable	1.2	Unshielded	Unshielded
3	AC Cable	0.8	Unshielded	Unshielded
4	DC Cable	1.0	Unshielded	Unshielded
5	Access Point DC Power Cable	1.8	Unshielded	Unshielded
6	Access Point AC Power Cable	2.0	Unshielded	Unshielded
7	NIC Cable	3.0	Unshielded	Unshielded
8	Note PC DC Power Cable	1.8	Unshielded	Unshielded
9	Note PC AC Power Cable	0.7	Unshielded	Unshielded

## UL Japan, Inc. Shonan EMC Lab.

1-22-3 Megumigaoka, Hiratsuka-shi, Kanagawa-ken, 259-1220 JAPAN  
Telephone: +81 463 50 6400  
Facsimile: +81 463 50 6401

### 5.3 Test and Measurement System

#### SYSTEM OVERVIEW

The measurement system is based on a conducted test method.

The software selects waveform parameters from within the bounds of the signal type on a random basis using uniform distribution. The short pulse types 2, 3, and 4, the long pulse type 5, and the frequency hopping type 6 parameters are randomized at run-time.

The signal monitoring equipment consists of a spectrum analyzer with the capacity to display 8001 bins on the horizontal axis. A time-domain resolution of 2 msec/bin is achievable with a 16 second sweep time, meeting the 10 seconds short pulse reporting criteria. The aggregate ON time is calculated by multiplying the number of bins above a threshold during a particular observation period by the dwell time per bin, with the analyzer set to peak detection. A time-domain resolution of 3 msec/bin is achievable with a 24 second sweep time, meeting the 22 second long pulse reporting criteria and allowing a minimum of 10 seconds after the end of the long pulse waveform.

#### FREQUENCY HOPPING RADAR WAVEFORM GENERATING SUBSYSTEM

The first 100 frequencies are selected out of the hopping sequence of the randomized 475 hop frequencies.

Only a *Burst* that has the frequency falling within the receiver bandwidth of the tested U-NII device is selected among those frequencies. (Frequency-domain simulation). The radar waveform generated at the start time of the selected *Burst* (Time-domain simulation) is download to the Signal Generator.

If all of the randomly selected 100 frequencies do not fall within the receiver bandwidth of the U-NII device, the radar waveform is not used for the test.

---

**UL Japan, Inc.**

**Shonan EMC Lab.**

1-22-3 Megumigaoka, Hiratsuka-shi, Kanagawa-ken, 259-1220 JAPAN

Telephone: +81 463 50 6400

Facsimile: +81 463 50 6401

**CONDUCTED METHODS SYSTEM BLOCK DIAGRAM**

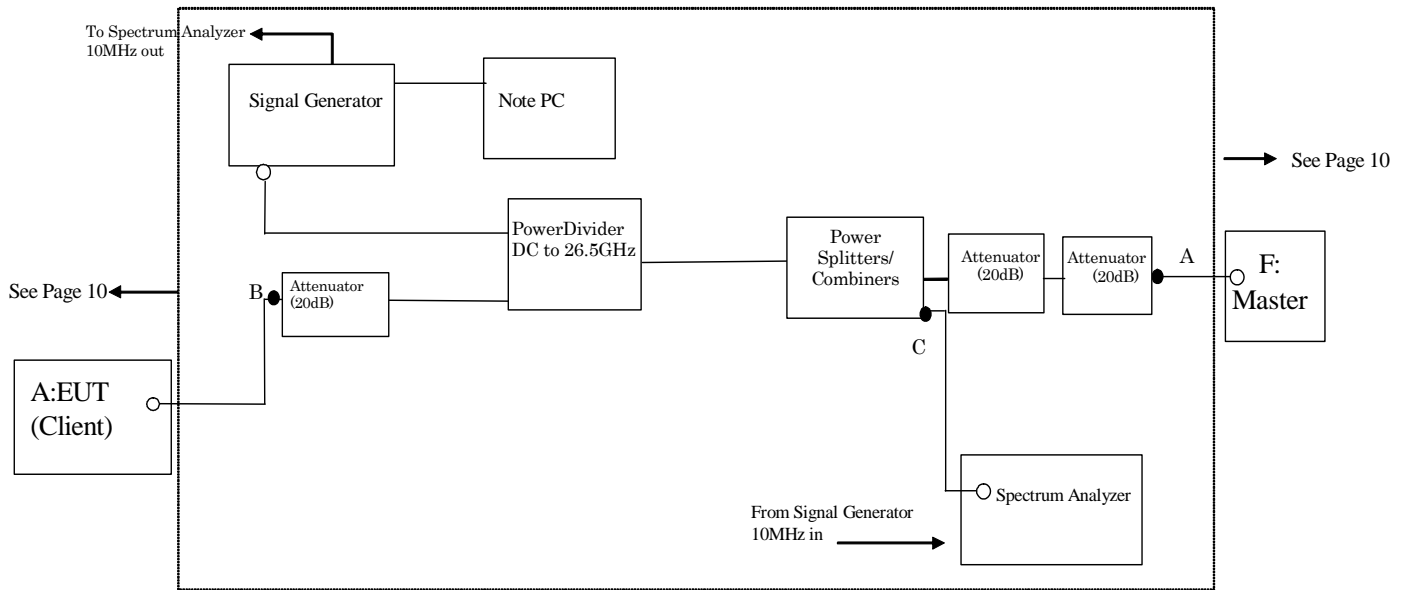

**MEASUREMENT SYSTEM FREQUENCY REFERENCE**

Lock the signal generator and the spectrum analyzer to the same reference sources as follows: Connect the 10MHz OUT on the signal generator to the 10MHz IN on the spectrum analyzer and set the spectrum analyzer 10MHz In to On.

## SYSTEM CALIBRATION

**Step 1:** Set the system as shown in Figure 3 of FCC 06-96 7.2.1.

**Step 2:** Adjust each attenuator to fulfill the following three conditions:

- WLAN can be communicated, and
- Rader detection threshold level is bigger than Client Device traffic level on the spectrum analyzer, and
- Master Device traffic level is not displayed on the spectrum analyzer.

**Step 3:** Terminate 50 ohm at B and C points, and connect the spectrum analyzer to the point A. (See the figure on page 12)

At the point A, adjust the signal generator and spectrum analyzer to the center frequency of the channel to be measured. Download the applicable radar waveforms to the signal generator. Select the radar waveform, trigger a burst manually and measure the amplitude on the spectrum analyzer. Readjust the amplitude of the signal generator as required so that the peak level of the waveform is at a displayed level equal to the required or desired interference detection threshold. Separate signal generator amplitude settings are determined as required for each radar type.

**Step 4:** Without changing any of the instrument settings, restore the system setting to Step 2 and adjust the Reference Level Offset of the spectrum analyzer to the level at Step 3.

By taking the above steps 1 to 4, the spectrum analyzer displays the level of the signal generator as received at the antenna ports of the Master Device.

See Clause 5.4 for Plots of Noise, Rader Waveforms, and WLAN signals.

## 5.4 Plots of Noise, Rader Waveforms, and WLAN signals

Plots of System Noise Floor

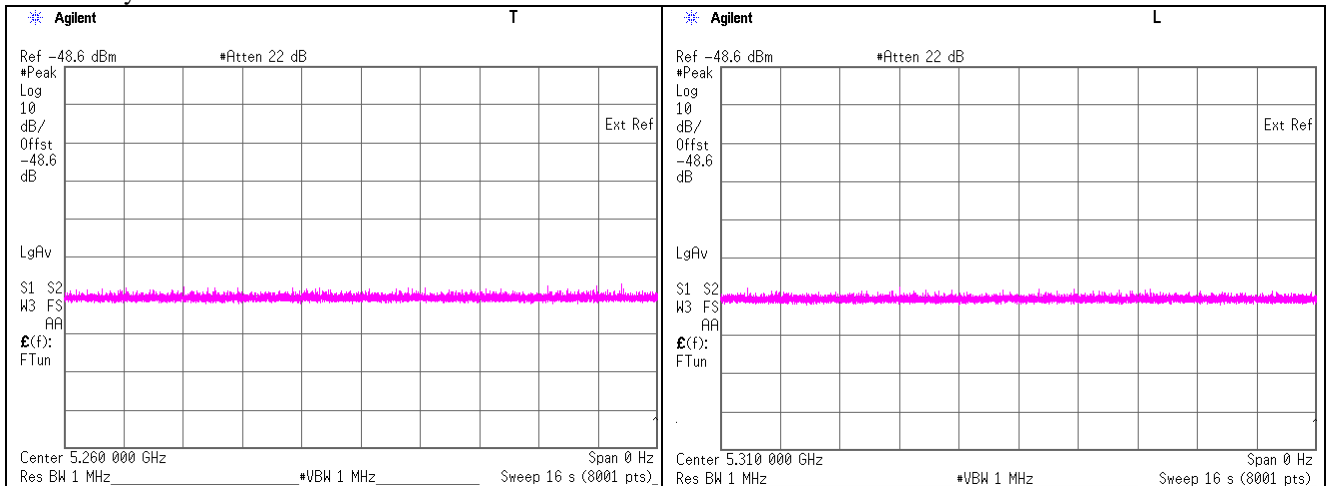

It was confirmed that the EUT did not transmit before having received appropriate control signals from a Master Device.

**UL Japan, Inc.**  
**Shonan EMC Lab.**

1-22-3 Megumigaoka, Hiratsuka-shi, Kanagawa-ken, 259-1220 JAPAN

Telephone: +81 463 50 6400

Facsimile: +81 463 50 6401

Plots of Radar Waveforms

Rader Type 1

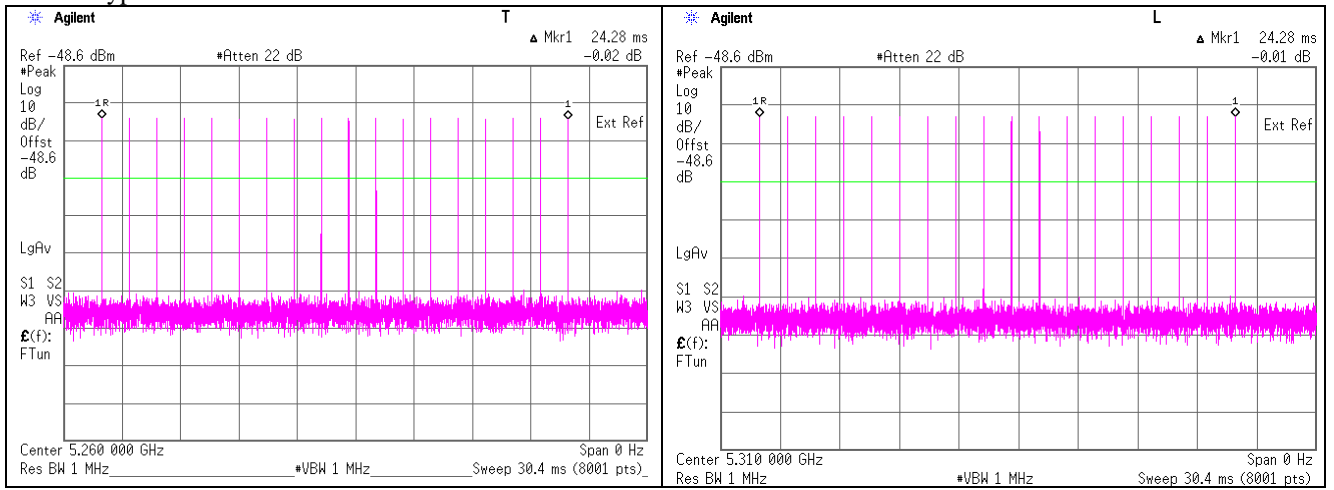

Rader Type 5

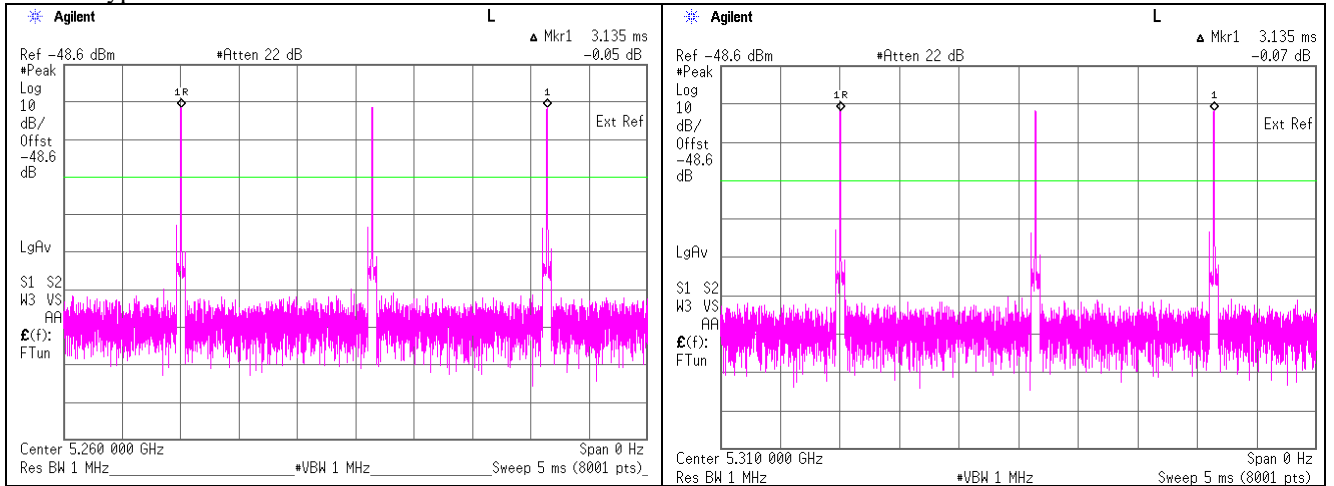

**UL Japan, Inc.**  
**Shonan EMC Lab.**

1-22-3 Megumigaoka, Hiratsuka-shi, Kanagawa-ken, 259-1220 JAPAN

Telephone: +81 463 50 6400

Facsimile: +81 463 50 6401

Plots of WLAN Traffic

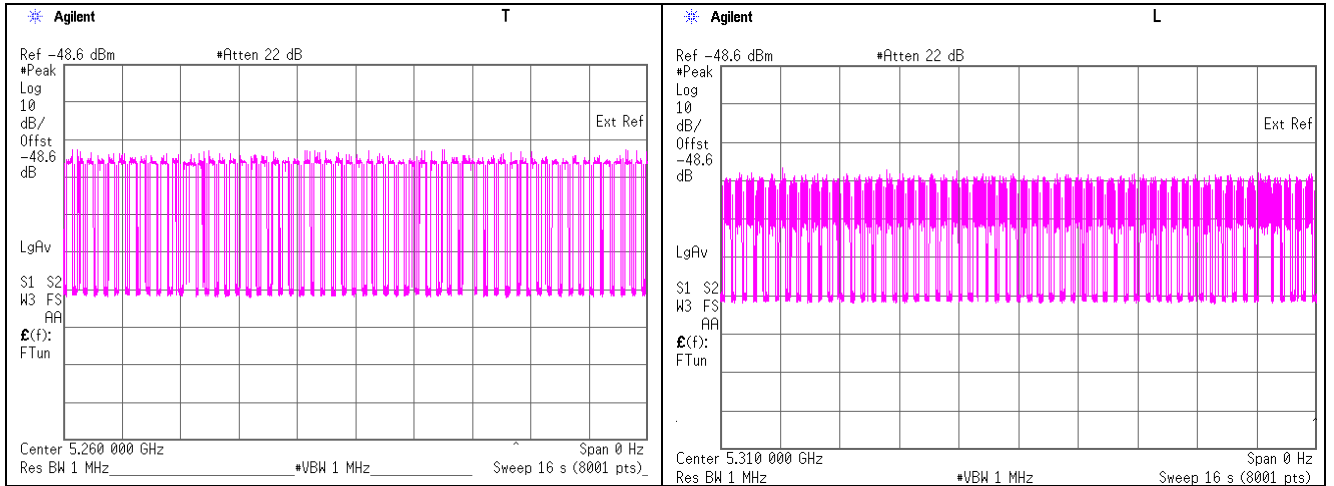

**UL Japan, Inc.**  
**Shonan EMC Lab.**

1-22-3 Megumigaoka, Hiratsuka-shi, Kanagawa-ken, 259-1220 JAPAN

Telephone: +81 463 50 6400

Facsimile: +81 463 50 6401

## **SECTION 6: In-Service Monitoring for Channel Move Time, Channel Closing Transmission Time**

### **6.1 Operating environment**

Test place : No.5 Shielded room  
Temperature : 26 deg.C.  
Humidity : 62 %RH

### **6.2 Test Procedure**

Stream the MPEG test file from the Master Device to the Client Device on the test Channel for the entire period of the test.

The Radar Waveform generator sends a Burst of pulses for one of the Short Pulse Radar Types 1-4 at levels defined , on the Operating Channel. An additional 1 dB is added to the radar test signal to ensure it is at or above the DFS Detection Threshold, accounting for equipment variations/errors.

Observe the transmissions of the EUT at the end of the radar Burst on the Operating Channel for duration greater than 10 seconds.



### 6.3 Test data

#### (1) 802.11n-HT20

Test Item	Unit	Measurement Time	Limit	Results
Channel Move Time *1)	[sec]	0.098	10.000	Pass
Channel Closing Transmission Time *2)	[msec]	0	60	Pass

\*1) Channel Move Time is calculated as follows:

$$(\text{Channel Move Time}) = (\text{End of Transmission}) - (\text{End of Burst}) = 1.886 - 1.788$$

\*2) Channel Closing Transmission Time is calculated from (End of Burst + 200msec) to (End of Burst + 10sec )

$$(\text{Channel Closing Transmission Time}) = (\text{Number of analyzer bins showing transmission}) * (\text{dwell time per bin}) = 0 * 2(\text{msec})$$

#### Radar Type 1

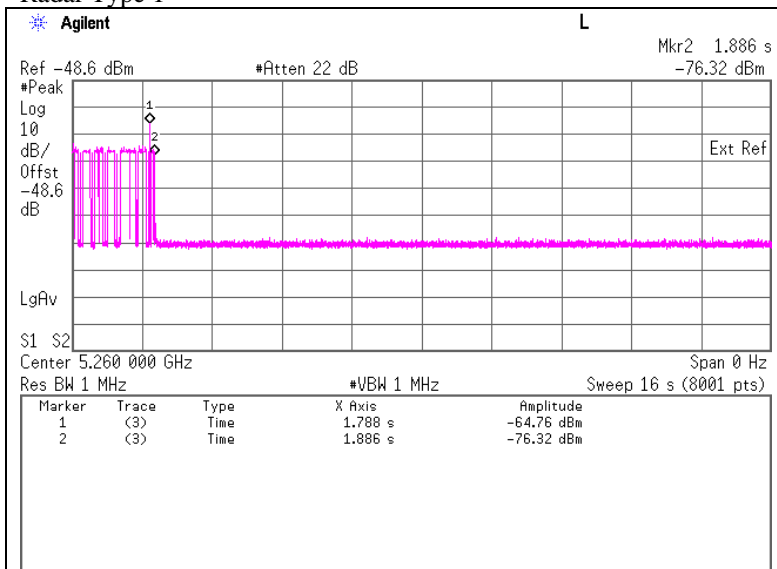

**Marker 1: - End of Burst : 1788 ms**

**Marker 2: - End of Transmission : 1886 ms**

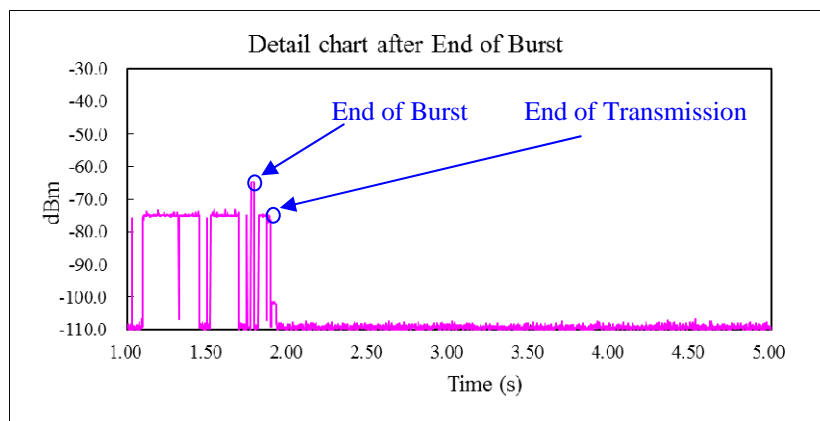

\*) Number of analyzer bins which are occupied in 1-burst from End of Burst to End of Transmission: 36

(2) 802.11n-HT40

Test Item	Unit	Measurement Time	Limit	Results
Channel Move Time *1)	[sec]	0.008	10.000	Pass
Channel Closing Transmission Time *2)	[msec]	0	60	Pass

\*1) Channel Move Time is calculated as follows:

$$(\text{Channel Move Time}) = (\text{End of Transmission}) - (\text{End of Burst}) = 1.662 - 1.654$$

\*2) Channel Closing Transmission Time is calculated from (End of Burst + 200msec) to (End of Burst + 10sec )

$$(\text{Channel Closing Transmission Time}) = (\text{Number of analyzer bins showing transmission}) * (\text{dwell time per bin}) = 0 * 2(\text{msec})$$

Radar Type 1

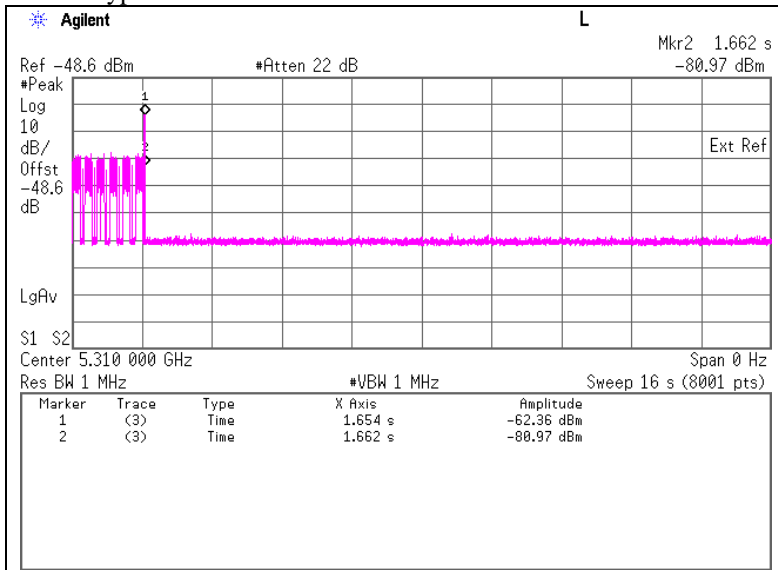

**Marker 1: - End of Burst : 1654 ms**  
**Marker 2: - End of Transmission : 1662 ms**

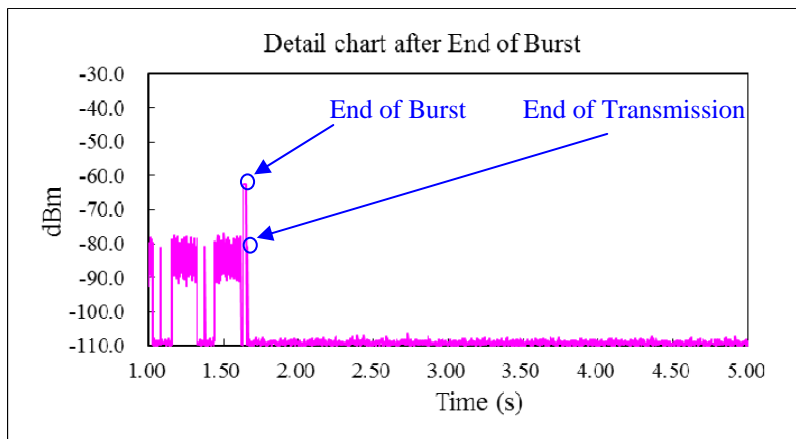

\*) Number of analyzer bins which are occupied in 1-burst from End of Burst to End of Transmission: 1

Radar Type 5

(1) 802.11n-HT20

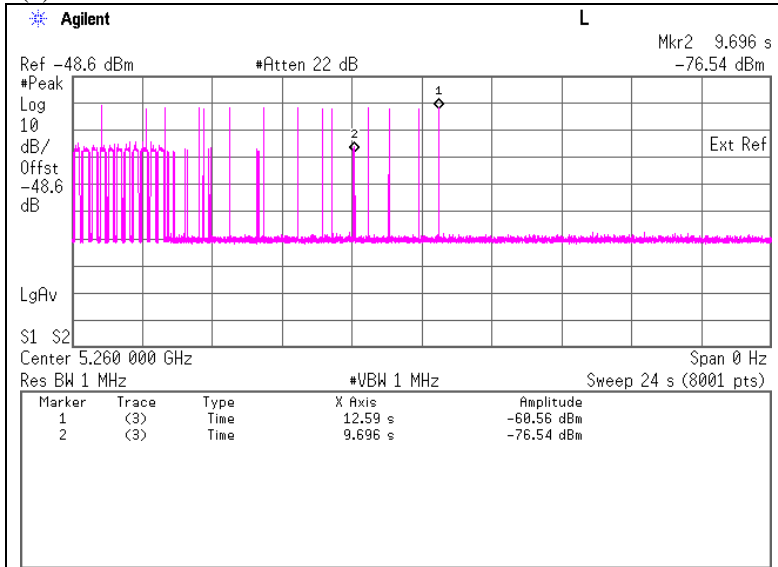

**Marker 1 : End of Burst : 12590 ms**  
**Marker 2 : End of Transmission : 9696 ms**

(2) 802.11n-HT40

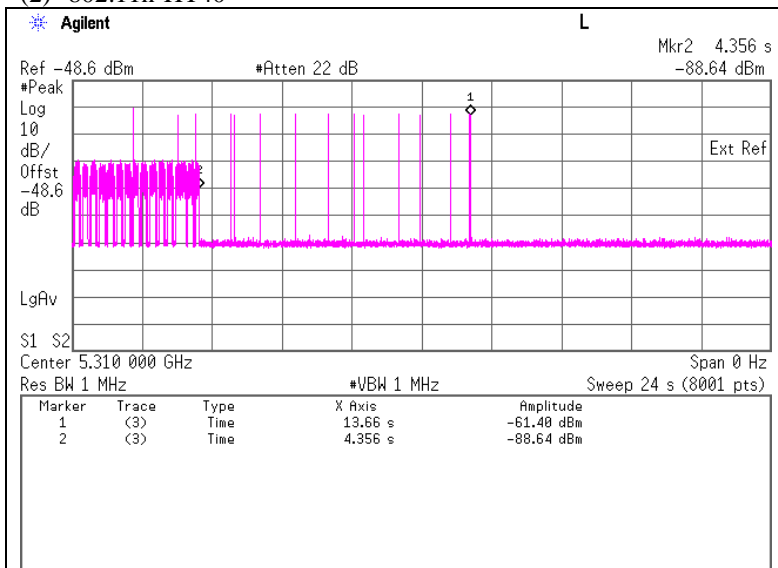

**Marker 1 : End of Burst : 13660 ms**  
**Marker 2 : End of Transmission : 4356 ms**

6.4 Test result

Test result: Pass

Date : July 21, 2011

Test engineer : Tatsuya Arai

**UL Japan, Inc.**  
**Shonan EMC Lab.**

1-22-3 Megumigaoka, Hiratsuka-shi, Kanagawa-ken, 259-1220 JAPAN

Telephone: +81 463 50 6400

Facsimile: +81 463 50 6401

## SECTION 7: In-Service Monitoring for Non-Occupancy Period

### 7.1 Operating environment

Test place : No.5 Shielded room  
Temperature : 26 deg.C.  
Humidity : 62 %RH

### 7.2 Test Procedure

The following two tests are performed:

1).Stream the MPEG test file from the Master Device to the Client Device on the test Channel for the entire period of the test.

The Radar Waveform generator sends a Burst of pulses for one of the Radar Types 1-6 at levels defined on the Operating Channel. An additional 1 dB is added to the radar test signal to ensure it is at or above the DFS Detection Threshold, accounting for equipment variations/errors.

Observe the transmissions of the EUT after the Channel Move Time on the Operating Channel for duration greater than 30 minutes.

2). Stream the MPEG test file from the Master Device to the Client Device on the test Channel for the entire period of the test.

Observe the transmissions of the EUT on the Operating Channel for duration greater than 30 minutes after the Master Device is shut off.

### 7.3 Test data

1).Radar Type 1

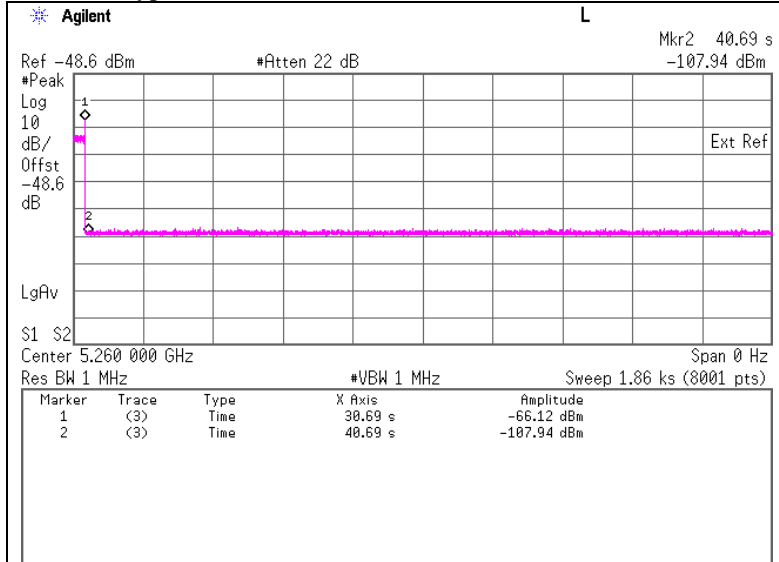

**Marker 1 : End of Burst : 30.69 sec**

**Marker 2 : End of Burst +10sec : 40.69 sec**

**UL Japan, Inc.**  
**Shonan EMC Lab.**

1-22-3 Megumigaoka, Hiratsuka-shi, Kanagawa-ken, 259-1220 JAPAN

Telephone: +81 463 50 6400

Facsimile: +81 463 50 6401

2).Master is shut off

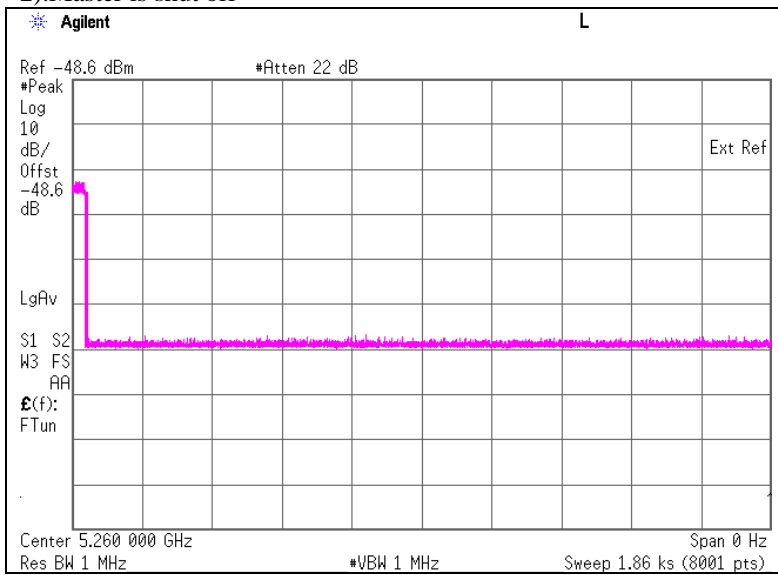

7.4 Test result

Test result: Pass

Date : July 21, 2011

Test engineer : Tatsuya Arai