

FCC Test Report

(Part 90)

Product Name : Module
Model No : RC7611
FCC ID : N7NRC76B

Applicant : SIERRA WIRELESS (ASIA PACIFIC) LIMITED,
TAIWAN BRANCH (HONG KONG)
Address : 7F. (AB,E), NO. 1,3, YUANDONG RD., BANQIAO
DIST., NEW TAIPEI CITY 22063 Taiwan

Date of Receipt : 2019/11/29
Issued Date : 2019/12/31
Report No. : 19B0422R-HPUSP40V00
Report Version : V1.0



The test results relate only to the samples tested.

The test results shown in the test report are traceable to the national/international standard through the calibration of the equipment and evaluated measurement uncertainty herein.

This report must not be used to claim product endorsement by TAF or any agency of the government.

The test report shall not be reproduced without the written approval of DEKRA Testing and Certification Co., Ltd.

Test Report

Issued Date : 2019/12/31

Report No.: 19B0422R-HPUSP40V00



Product Name : Module
Applicant : SIERRA WIRELESS (ASIA PACIFIC) LIMITED, TAIWAN BRANCH (HONG KONG)
Address : 7F. (AB,E), NO. 1,3, YUANDONG RD., BANQIAO DIST., NEW TAIPEI CITY 22063 Taiwan
Manufacturer : SIERRA WIRELESS HONG KONG LIMITED
Trade Name : AirPrime
Model No. : RC7611
EUT Rated Voltage : DC 3.2V-4.3 V
EUT Test Voltage : DC 3.7V
Measurement : FCC CFR Title 47 Part2 90
Standard
Measurement : TIA/EIA 603-E 2016
Reference : KDB 971168 D01V03R01
ANSI C63.26 2015
Test Result : Complied

Documented By : Anny Chou
(Senior Adm. Specialist / Anny Chou)

Tested By : Vorana Chen
(Senior Engineer / Vorana Chen)

Approved By : Vincent Lin
(Director / Vincent Lin)

TABLE OF CONTENTS

Description	Page
1. GENERAL INFORMATION	4
1.1. EUT Description	4
1.2. Antenna List	4
1.3. Operational Description	5
1.4. Configuration of tested System	6
1.5. EUT Setup Procedures	6
1.6. Test Facility	7
1.7. Type of Emission	8
1.8. Voltages and DC currents.....	8
2. Technical Test.....	9
2.1. Summary of test result	9
2.2. List of test Equipment	10
2.3. Measurement Uncertainty	10
3. Conducted Output Power Measurement	11
3.1. Test Specification	11
3.2. Test Setup	11
3.3. Limits.....	11
3.4. Test Procedure.....	11
3.5. Test Result of Maximum Power Output.....	12
3.6. Maximum Conducted Power and ERP/EIRP Power.....	14
4. Occupied Bandwidth.....	15
4.1. Test Specification	15
4.2. Test Setup	15
4.3. Test Procedure.....	15
4.4. Test Result of Occupied Bandwidth	16
5. Spurious Emission At Antenna Terminals (+/-1MHz)	21
5.1. Test Specification	21
5.2. Setup.....	21
5.3. Limits.....	21
5.4. Test Procedure.....	21
5.5. Test Result of Spurious Emission At Antenna Terminals (+/-1MHz).....	22
6. Spurious Emission	29
6.1. Test Specification	29
6.2. Test Setup	29
6.3. Limits.....	30
6.4. Test Procedure.....	30
6.5. Test Result of Spurious Emission	31
7. Frequency Stability Under Temperature & Voltage Variations	63
7.1. Test Specification	63
7.2. Test Setup	63
7.3. Limits.....	63
7.4. Test Procedure.....	63
7.5. Test Result of Frequency Stability Under Temperature Variations.....	64
8. Peak to Average Ratio	72
8.1 Test Specification	72
8.2 Test Setup.....	72
8.3 Limits.....	72
8.4 Test Procedure	72
8.5 Test Result of Spurious Emission	73
Attachment 1: EUT Test Photographs	
Attachment 2: EUT Detailed Photographs	

1. GENERAL INFORMATION

1.1. EUT Description

Product Name	Module
Model No.	RC7611
Trade Name	AirPrime
IMEI No.	35213811
FCC ID	N7NRC76B
Modulation	LTE Band 14: QPSK/16-QAM
TX Frequency	LTE Band 14: 788~798MHz
Rx Frequency	LTE Band 14: 758~768MHz
Bandwidth	LTE Band 14: 5MHz/10MHz
HW Version	1.0
FW Version	SWI9X07H_00.01.05.00 12a738
Antenna Type	Dipole Antenna

1.2. Antenna List

No.	Manufacturer	Part No.	Antenna Type	Peak Gain
1	Pulse	SPDA24617_3900	Dipole	2.26 dBi for 617-960 MHz

1.3. Operational Description

The information contained within this report is intended to show verification of compliance of the 850MHz to the requirements of FCC 47 CFR Part 2, 90.

The EUT provide all functions described as above. The EUT is tested with maximum rated TX power via the Base Station simulator.

DEKRA has verified the construction and function in typical operation. All the test modes were carried out with the EUT in normal operation, which was shown in this test report and defined

as:

Test Mode:	LTE Band 14 (5M)-QPSK/16QAM
	LTE Band 14 (10M)-QPSK/16QAM

Note :

The maximum power levels are chosen in the LTE Band 14, only these modes were used for all tests.

1.4. Configuration of tested System

(a) Configuration of Radiated measurement

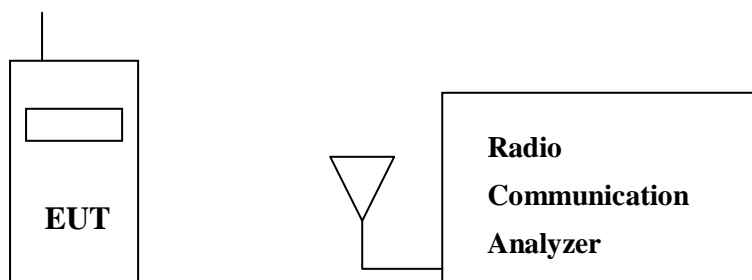

(b) Configuration of Conducted measurement

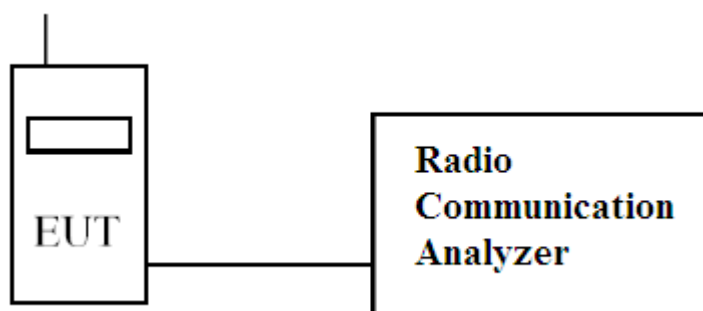

1.5. EUT Setup Procedures

- (1) Setup the EUT and simulators as shown on 1.3
- (2) Turn on the power of all equipments.
- (3) The EUT was set to communicate with MT8820C.
- (4) Repeat the above procedure (3).

1.6. Test Facility

Ambient conditions in the laboratory:

Items	Required (IEC 68-1)	Actual
Temperature (°C)	15-35	20-35
Humidity (%RH)	25-75	50-65
Barometric pressure (mbar)	860-1060	950-1000

USA : FCC Registration Number: TW3023

Canada : IC Registration Number: 4075A

Site Description: Accredited by TAF
Accredited Number: 3023

Test Laboratory: DEKRA Testing and Certification Co., Ltd
Address: No.5-22, Ruishukeng, Linkou Dist., New Taipei City 24451,
Taiwan, R.O.C.

Phone number: 886-2-8601-3788

Fax number: 886-2-8601-3789

Email address: info.tw@dekra.com

Website: <http://www.dekra.com.tw>

1.7. Type of Emission

Band	Bandwidth (MHz)	TX Frequency (MHz)	Modulation	
			QPSK	16QAM
14	5	790.5	4M51G7D	4M51W7D
14	5	793	4M51G7D	4M49W7D
14	5	795.5	4M51G7D	4M50W7D
14	10	793	8M98G7D	8M96W7D

1.8. Voltages and DC currents

LTE Band 14 (5M)	EUT Transmitting (in maximum power) :	DC voltage : 3.7V , DC current : 0.62A
	EUT Standby	: DC voltage : 3.7V , DC current : 0.06A
LTE Band 14 (10M)	EUT Transmitting (in maximum power) :	DC voltage : 3.7V , DC current : 0.64A
	EUT Standby	: DC voltage : 3.7V , DC current : 0.07A

2. Technical Test

2.1. Summary of test result

FCC Standard	Test Item	Result	Note
2.1046	Conducted Output Power	Pass	
90.542			
2.1049	Occupied Bandwidth	Pass	
90.209			
2.1051	Spurious Emission at Antenna Terminals	Pass	
90.543			
2.1051	Conducted Emission	Pass	
90.543			
2.1053	Field Strength of Spurious Radiation	Pass	
90.543			
2.1055	Frequency Stability for Temperature & Voltage	Pass	
90.213			
90.1215	Peak to Average Ratio	Pass	

2.2. List of test Equipment

Conducted /CTR

Instrument	Manufacturer	Type No.	Serial No	Cal. Date
Spectrum Analyzer	Agilent	N9010A	MY54510357	2019/04/29
Directional coupler	Agilent	87300C	MY44300353	2019/12/05
Directional coupler	Agilent	778D-012	50550	2019/12/05
Standard Temperature & Humidity Chamber	WIT	TH-1S-B	EQ-201-00146	2019/02/27
Communication Tester	Agilent	MT8820C	6201091166	2019/03/21

Radiated / Site3

Instrument	Manufacturer	Type No.	Serial No	Cal. Date
Bilog Antenna	Schaffner Chase	CBL6112B	2707	2019/06/23
Horn Antenna	R&S	9120D	556	2019/04/10
Pre-Amplifier	Agilent	87405C	MY55380068	2019/08/09
Spectrum Analyzer	Agilent	N9010A	MY54510357	2019/04/29
Communication Tester	Agilent	MT8820C	6201091166	2019/03/21

2.3. Measurement Uncertainty

Conducted Emission

The measurement uncertainty of confidence of 95% is evaluated as ± 1.52 dB

Radiated Emission (Below 1GHz)

The measurement uncertainty of confidence of 95% is evaluated as ± 4.22 dB .

Radiated Emission (Above 1GHz)

The measurement uncertainty of confidence of 95% is evaluated as ± 4.08 dB

3. Conducted Output Power Measurement

3.1. Test Specification

According to FCC Part 2.1046, 90.542

3.2. Test Setup

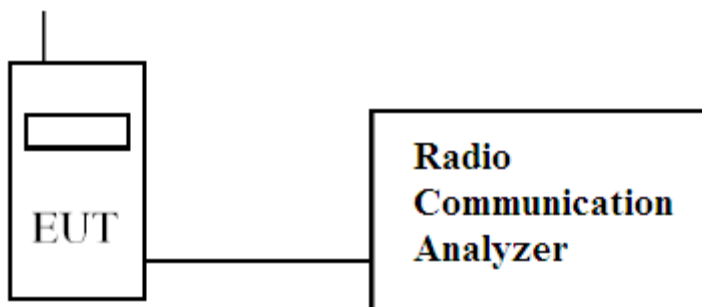

3.3. Limits

Band	Limit
LTE Band 14/800	<3W

3.4. Test Procedure

The EUT is tested with maximum rated TX power via the Base Station simulator, and the output power was measured at the antenna terminals of the EUT.

3.5. Test Result of Maximum Power Output

Band	Channel	Modulation	RB No.	RB Offset	MPR	Max Power (Conducted)	Max Power (W)
Band 14 (800MHz)/5MHz	CH23305 790.5MHz	QPSK	1	#0	0	22.05	0.1603
			1	#Mid	0	22.45	0.1758
			1	#Max	0	22.38	0.1730
			50%	#0	1	21.18	0.1312
			50%	#Mid	1	21.20	0.1318
			50%	#Max	1	21.16	0.1306
			100%	--	1	21.16	0.1306
		16QAM	1	#0	1	21.08	0.1282
			1	#Mid	1	21.38	0.1374
			1	#Max	1	21.13	0.1297
			50%	#0	2	20.16	0.1038
			50%	#Mid	2	20.27	0.1064
			50%	#Max	2	20.21	0.1050
			100%	--	2	20.13	0.1030
	CH23330 793MHz	QPSK	1	#0	0	22.16	0.1644
			1	#Mid	0	22.57	0.1807
			1	#Max	0	22.29	0.1694
			50%	#0	1	21.16	0.1306
			50%	#Mid	1	21.26	0.1337
			50%	#Max	1	21.22	0.1324
			100%	--	1	21.21	0.1321
		16QAM	1	#0	1	21.02	0.1265
			1	#Mid	1	21.36	0.1368
			1	#Max	1	21.19	0.1315
			50%	#0	2	20.26	0.1062
			50%	#Mid	2	20.26	0.1062
			50%	#Max	2	20.18	0.1042
			100%	--	2	20.20	0.1047
	CH23355 795.5MHz	QPSK	1	#0	0	22.26	0.1683
			1	#Mid	0	22.51	0.1782
1			#Max	0	22.19	0.1656	
50%			#0	1	21.19	0.1315	
50%			#Mid	1	21.21	0.1321	
50%			#Max	1	21.18	0.1312	
100%			--	1	21.21	0.1321	
16QAM		1	#0	1	21.00	0.1259	
		1	#Mid	1	21.41	0.1384	
		1	#Max	1	21.12	0.1294	
		50%	#0	2	20.18	0.1042	
		50%	#Mid	2	20.35	0.1084	
		50%	#Max	2	20.17	0.1040	
		100%	--	2	20.25	0.1059	

Band	Frequency Channel	Modulation	RB No.	RB offset	MPR	Max Power (dBm)	Max Power (W)
Band 14 (800MHz)/10MHz	CH23330 793MHz	QPSK	1	#0	0	21.66	0.1466
			1	#Mid	0	22.48	0.1770
			1	#Max	0	22.34	0.1714
			50%	#0	1	21.10	0.1288
			50%	#Mid	1	21.19	0.1315
			50%	#Max	1	21.22	0.1324
			100%	--	1	21.21	0.1321
		16-QAM	1	#0	1	21.00	0.1259
			1	#Mid	1	21.41	0.1384
			1	#Max	1	21.14	0.1300
			50%	#0	2	20.19	0.1045
			50%	#Mid	2	20.25	0.1059
			50%	#Max	2	20.20	0.1047
			100%	--	2	20.21	0.1050

3.6. Maximum Conducted Power and ERP/EIRP Power

According to KDB 412172 D01 Section 1.2 Power Approach

$EIRP = P_T + G_T - L_C = ERP + 2.15 \text{ dB}$, $ERP = EIRP - 2.15 \text{ dB}$

P_T = transmitter output power in dBm

G_T = gain of the transmitting antenna in dBi

L_C = signal attenuation in the connecting cable between the transmitter and antenna in dB

LTE Band	BW	Modulation	Conducted Peak Power (dBm)	Conducted Peak Power (W)	Antenna Gain (dBi)	Maximum ERP (W)	Maximum ERP Limit (W)
14	5M	QPSK	22.57	0.181	2.26	0.185	3
		16QAM	21.41	0.138	2.26	0.142	3
	10M	QPSK	22.48	0.177	2.26	0.182	3
		16QAM	21.41	0.138	2.26	0.142	3

4. Occupied Bandwidth

4.1. Test Secification

According to FCC Part 2.1049, 90.209

4.2. Test Setup

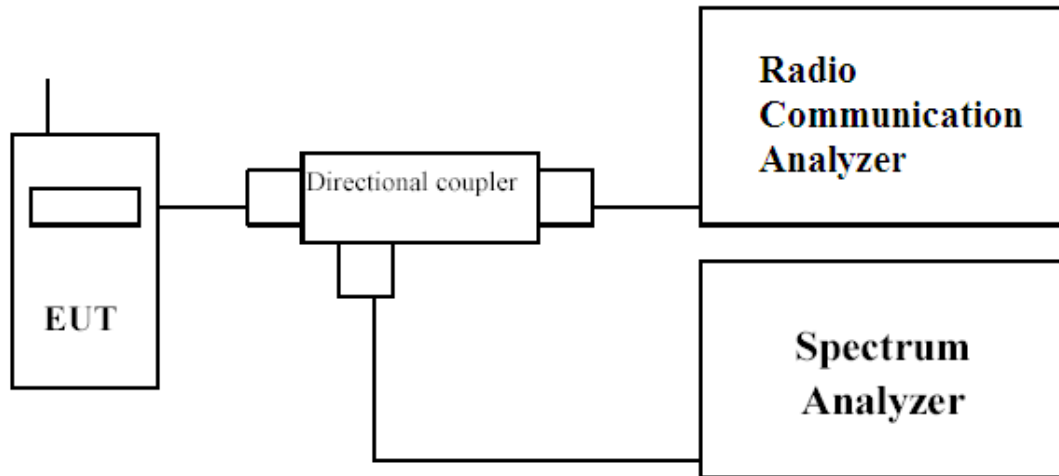

4.3. Test Procedure

The EUT is tested with maximum rated TX power via the Base Station simulator, and the occupied bandwidth was measured at the antenna terminals of the EUT.

The Resolution BW of the analyzer is set to 1 %~5% of the emission bandwidth. The EUT's occupied bandwidth is measured as the width of the signal between two points, one below the carrier center frequency and one above the carrier frequency, outside of which all emissions are attenuated at least 26 dB below the transmitter power.

The plots below show the resultant display from the Spectrum Analyser.

4.4. Test Result of Occupied Bandwidth

Product	Module
Test Mode	Occupied Bandwidth
Test Site	CTR
Environmental	23.2(°C) 51(%RH)

Test Mode	Channel	TX Frequency (MHz)	99% Occupied Bandwidth (MHz)	26 dB bandwidth (MHz)	Result
Band 14 5M QPSK	23305	790.5	4.5101	4.988	Pass
Band 14 5M 16QAM	23305	790.5	4.5089	5.033	Pass
Band 14 5M QPSK	23330	793	4.5139	4.995	Pass
Band 14 5M 16QAM	23330	793	4.4914	4.984	Pass
Band 14 5M QPSK	23355	795.5	4.5081	5.020	Pass
Band 14 5M 16QAM	23355	795.5	4.5001	4.999	Pass
Band 14 10M QPSK	23330	793	8.9834	9.994	Pass
Band 14 10M 16QAM	23330	793	8.9598	9.941	Pass

Product	Module		
Test Mode	Occupied Bandwidth		
Date of Test	2019/12/27	Test Site	CTR
Test Condition	Band 14 5M	Environmental	23.2(°C) 51(%RH)

Band 14 5M QPSK - LTE Mode CH 23305 (790.5MHz)

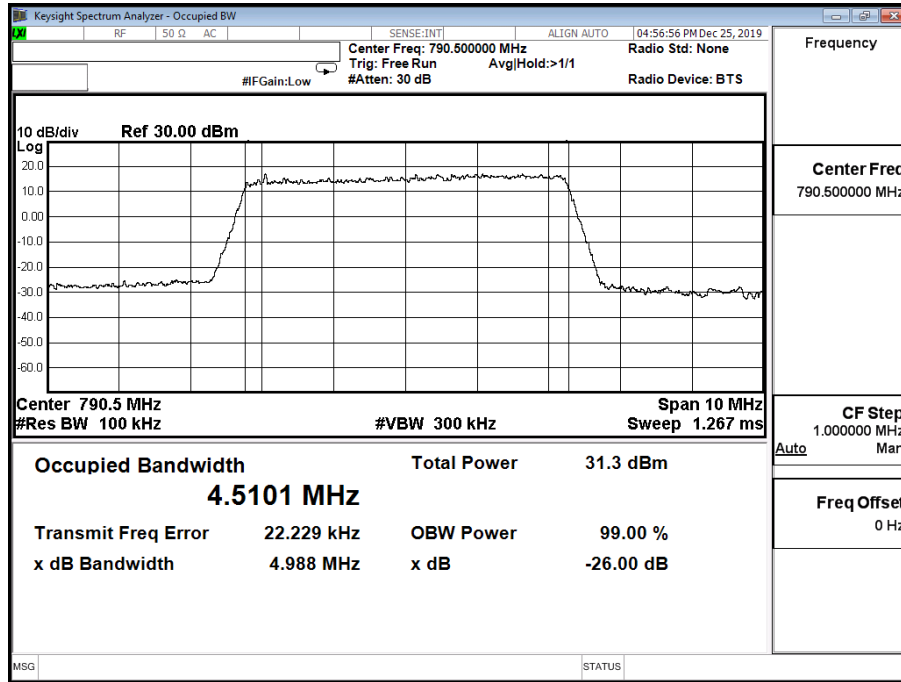

Band 14 5M 16QAM - LTE Mode CH 23305 (790.5MHz)

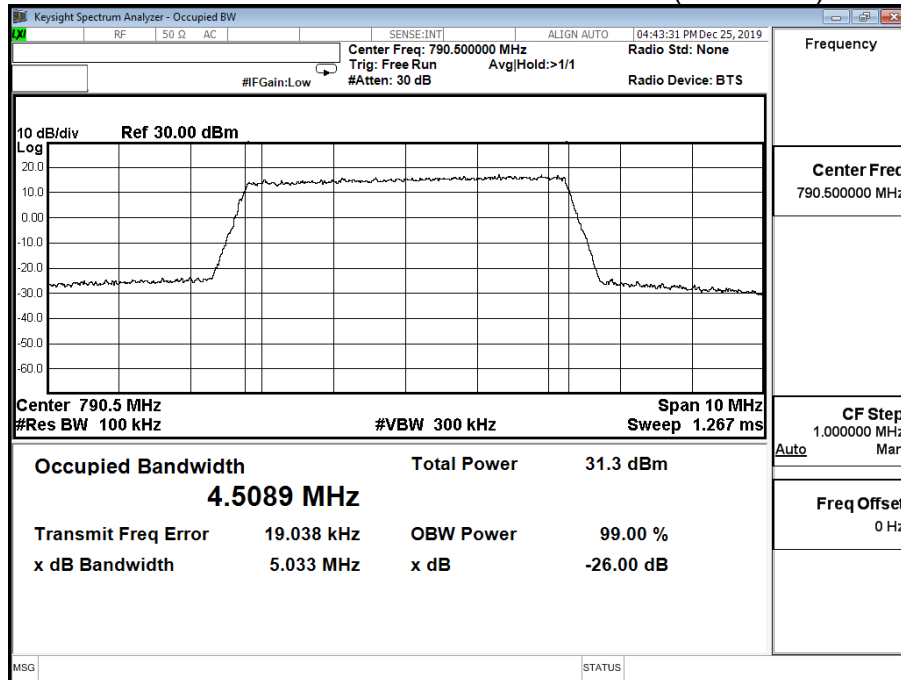

Product	Module		
Test Mode	Occupied Bandwidth		
Date of Test	2019/12/27	Test Site	CTR
Test Condition	Band 14 5M	Environmental	23.2(°C) 51(%RH)

Band 14 5M QPSK - LTE Mode CH 23330 (793MHz)

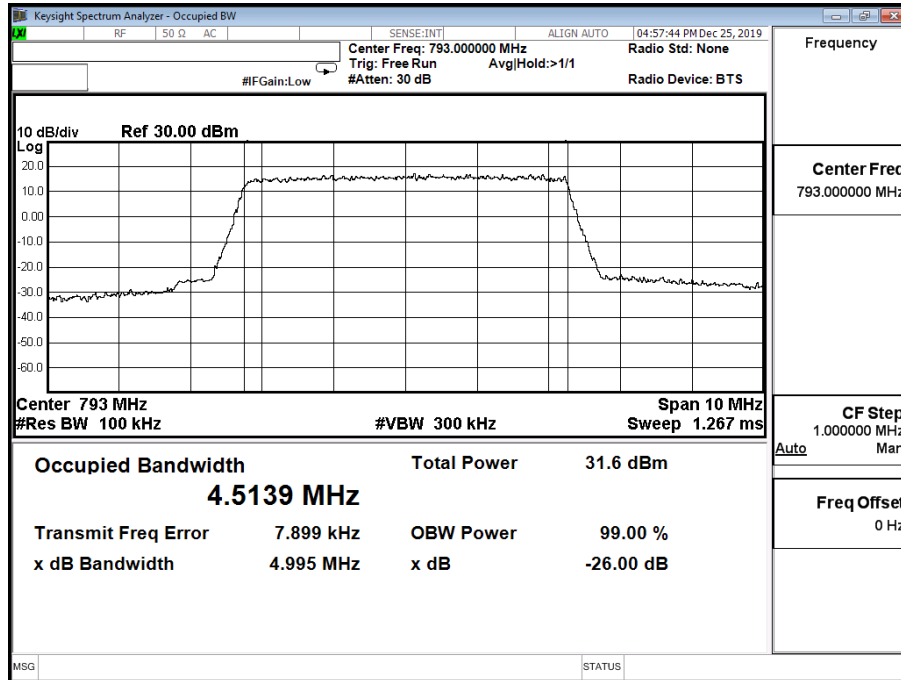

Band 14 5M 16QAM - LTE Mode CH 23330 (793MHz)

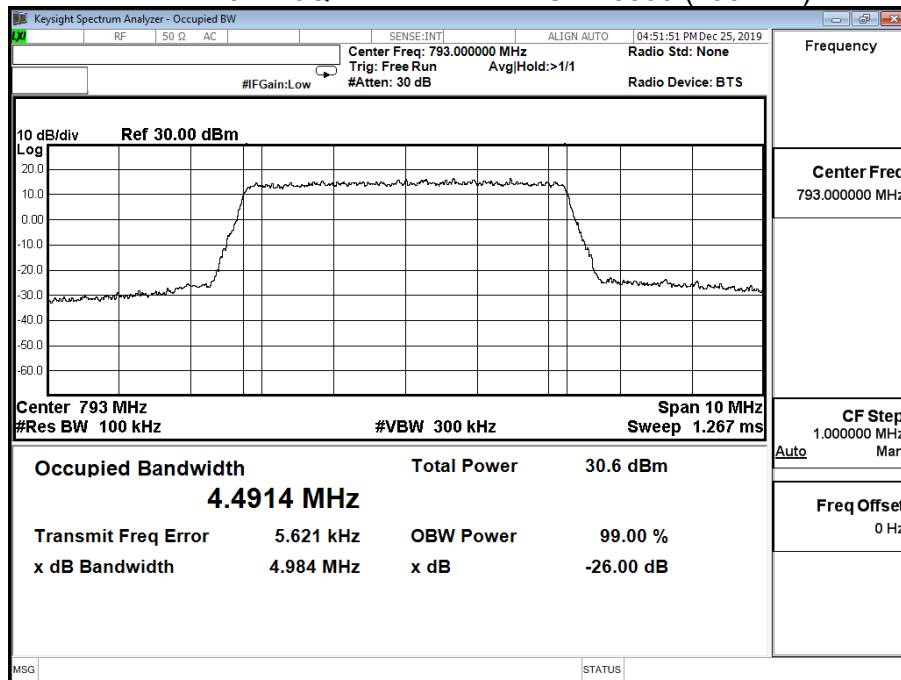

Product	Module		
Test Mode	Occupied Bandwidth		
Date of Test	2019/12/27	Test Site	CTR
Test Condition	Band 14 5M	Environmental	23.2(°C) 51(%RH)

Band 14 5M QPSK - LTE Mode CH 23355 (795.5MHz)

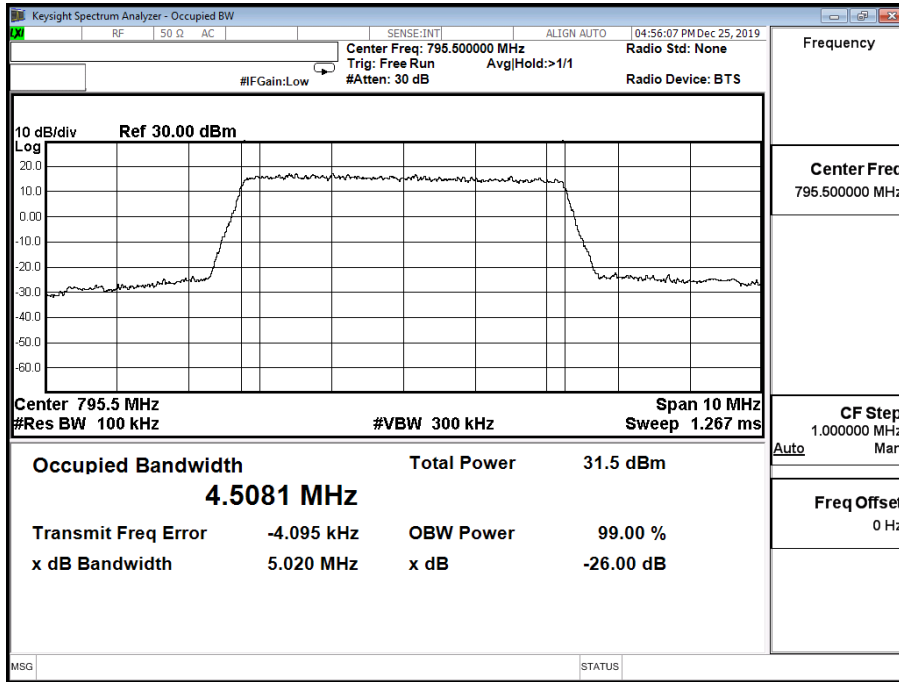

Band 14 5M 16QAM - LTE Mode CH 23355 (795.5MHz)

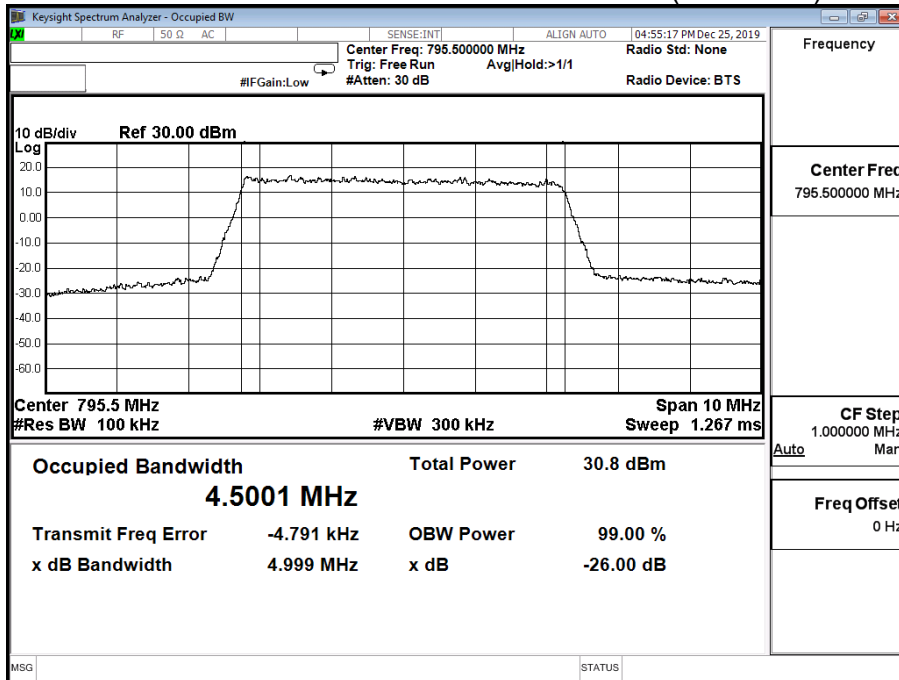

Product	Module		
Test Mode	Occupied Bandwidth		
Date of Test	2019/12/27	Test Site	CTR
Test Condition	Band 14 10M	Environmental	23.2(°C) 51(%RH)

Band 14 10M QPSK - LTE Mode CH 23330 (793MHz)

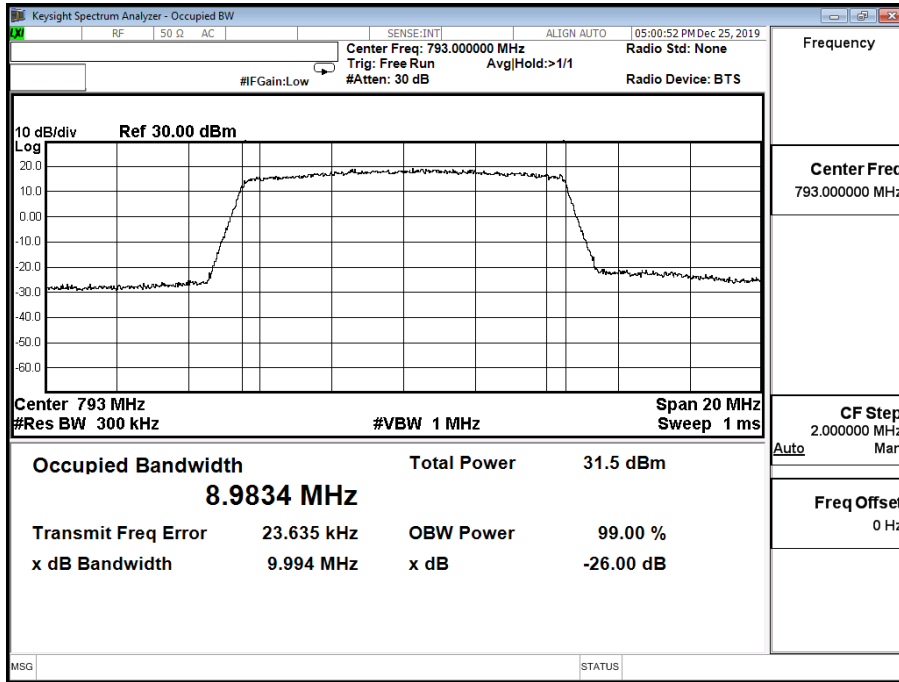

Band 14 10M 16QAM - LTE Mode CH 23330 (793MHz)

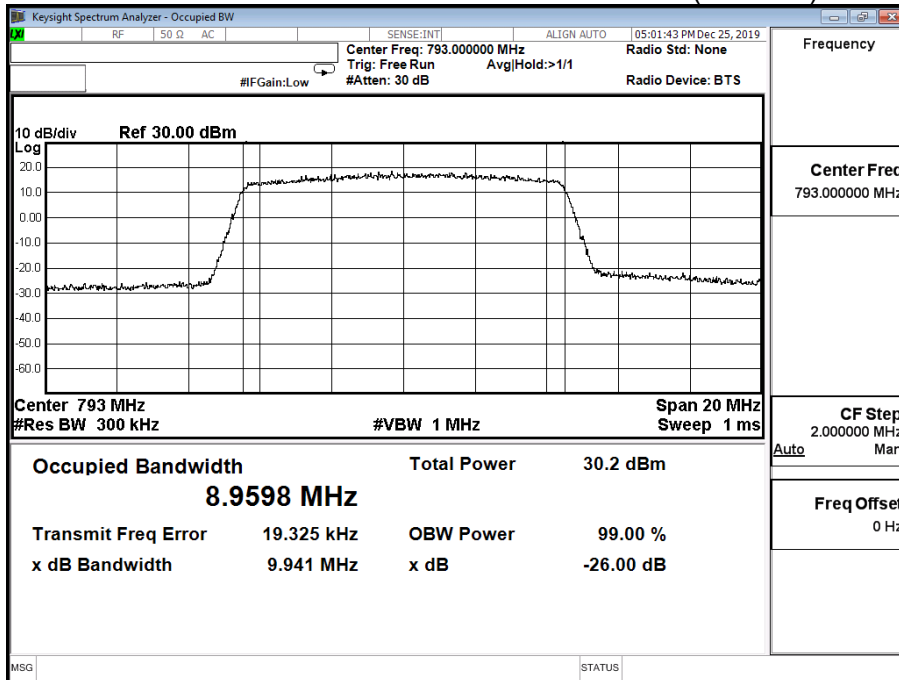

5. Spurious Emission At Antenna Terminals (+/-1MHz)

5.1. Test Specification

According to Part 2.1051, 90.543

5.2. Setup

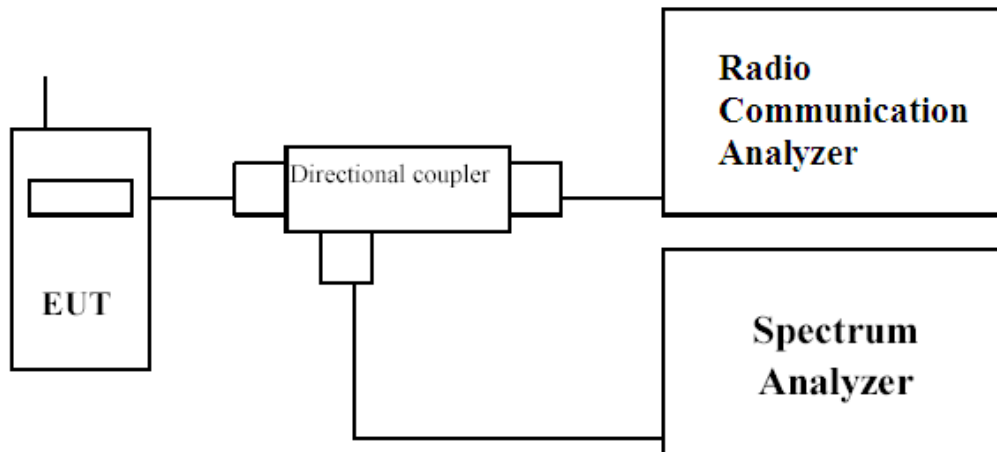

5.3. Limits

The spurious (unwanted) emission limits specified in the individual FCC rule parts applicable to licensed digital transmitters (typically referred to under the heading 'emission limits') normally apply to any and all emissions that are present outside of the authorized frequency band/block and apply to emissions in both the out-of-band and spurious domains. unwanted emissions are required by the licensed rule parts to be attenuated below the transmitter power by a factor of at least $43 + 10\log(P)$ dB on any frequency between 775-788 MHz, above 805 MHz, and below 758 MHz, where P represents the transmitter power expressed in watts.

5.4. Test Procedure

In accordance with Part 90.543 (e)(3) of this section is based on the use of measurement instrumentation employing a resolution bandwidth of 100 kHz or greater. However, in the 100 kHz bands immediately outside and adjacent to the frequency block, a resolution bandwidth of 30 kHz may be employed.

On all frequencies between 769-775 MHz and 799-805 MHz, by a factor not less than $65 + 10 \log(P)$ dB in a 6.25 kHz band segment, for mobile and portable stations

5.5. Test Result of Spurious Emission At Antenna Terminals (+/-1MHz)

Product	Module		
Test Mode	Spurious Emission At Antenna Terminals (+/-1MHz)		
Date of Test	2019/12/27	Test Site	CTR
Test Condition	Block Edge Test (Band 14 (5M))	Environmental	23.2(°C) 51(%RH)

Band 14 (5M) QPSK (1,0) Lower Channel 23305 (790.5MHz)

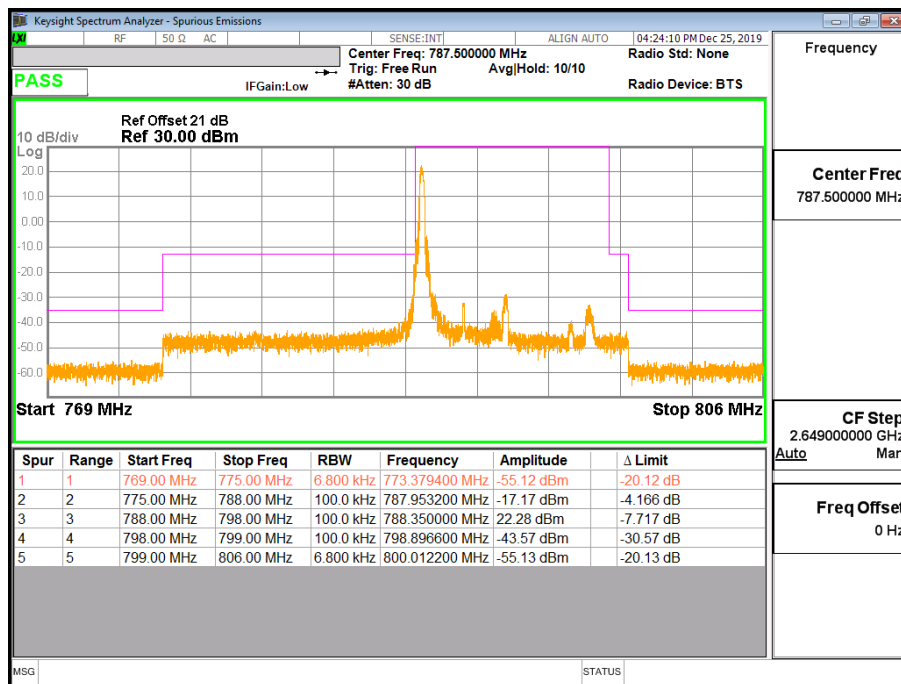

Band 14 (5M) QPSK (1,24) Upper Channel 23355 (795.5MHz)

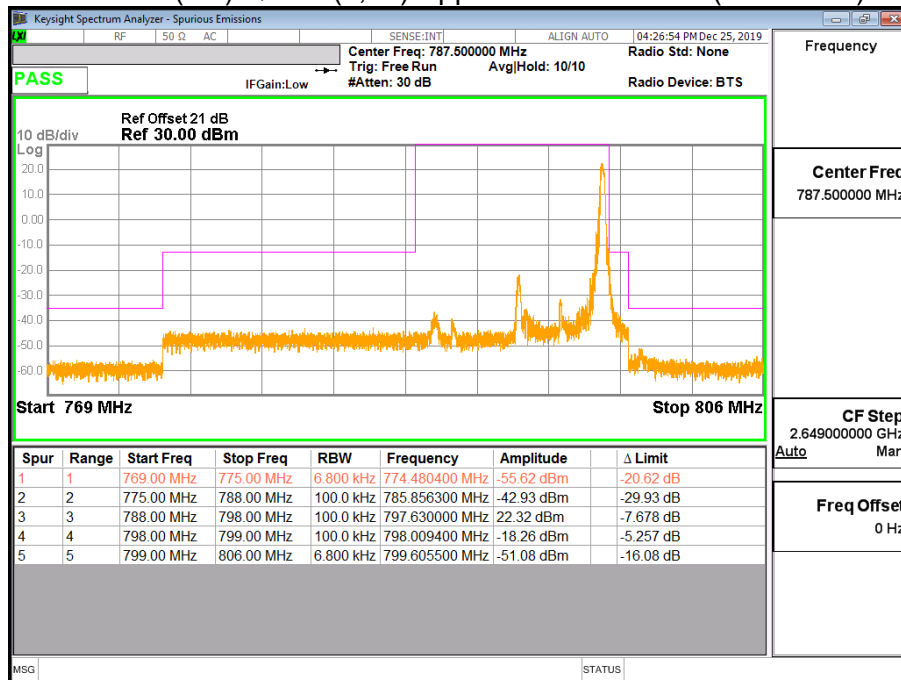

Band 14 (5M) QPSK (25,0) Lower Channel 23305 (790.5MHz)

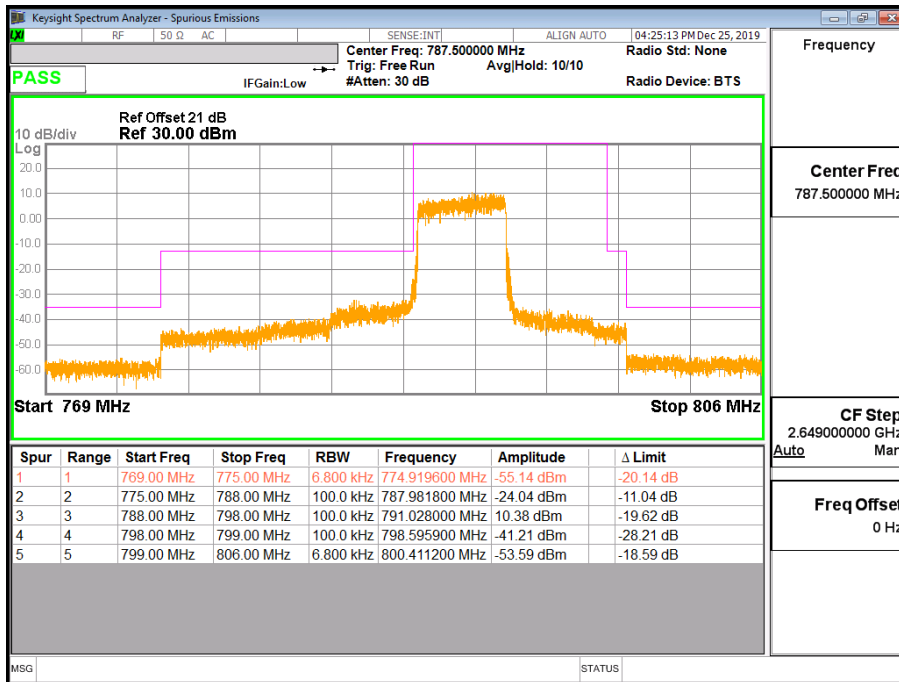

Band 14 (5M) QPSK (25,0) Upper Channel 23335 (795.5MHz)

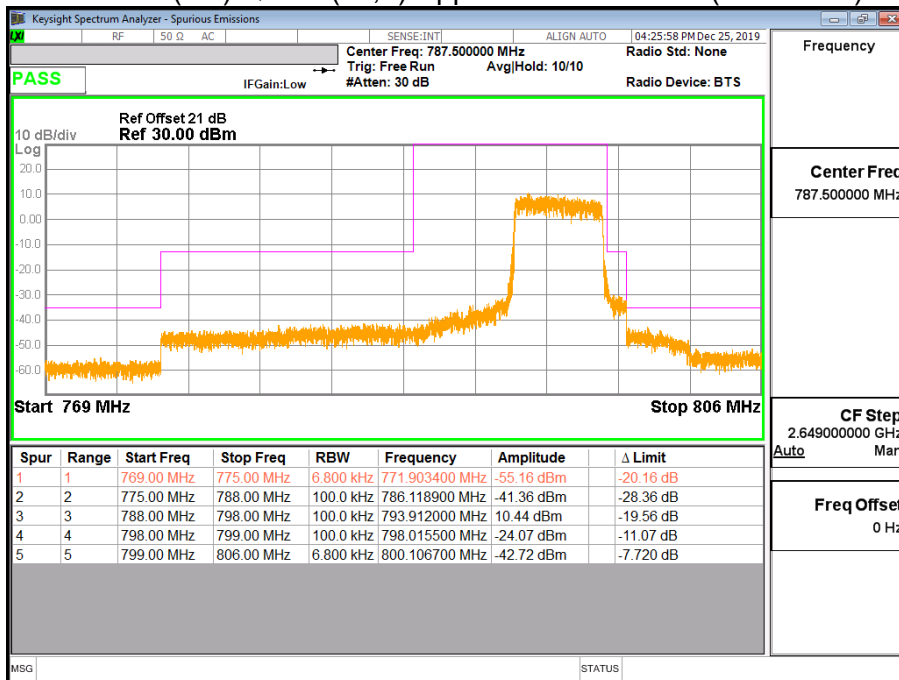

Band 14 (5M) 16QAM (1,0) Lower Channel 23305 (790.5MHz)

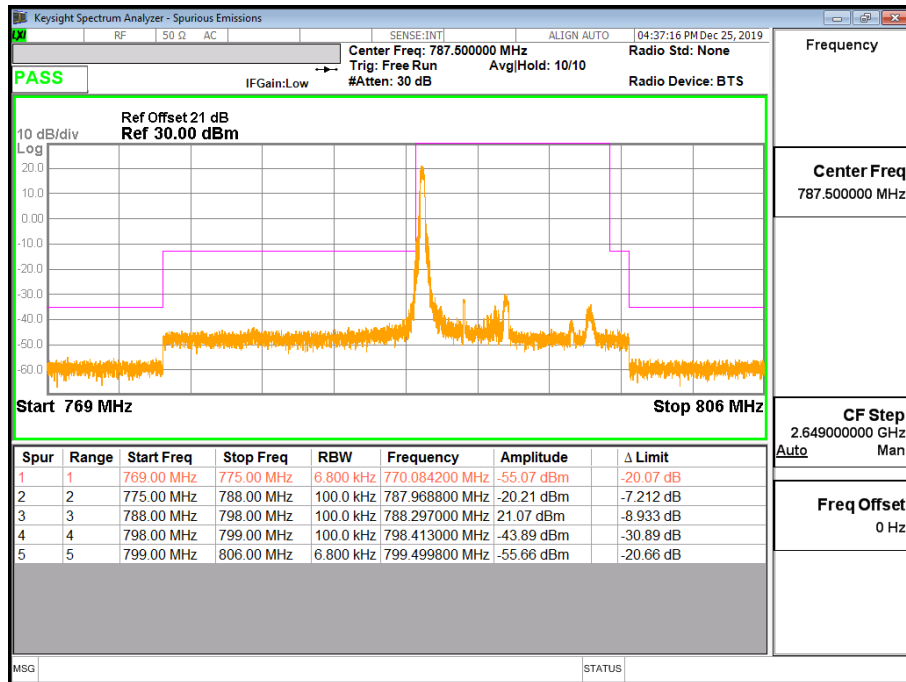

Band 14 (5M) 16QAM (1,24) Upper Channel 23355 (795.5MHz)

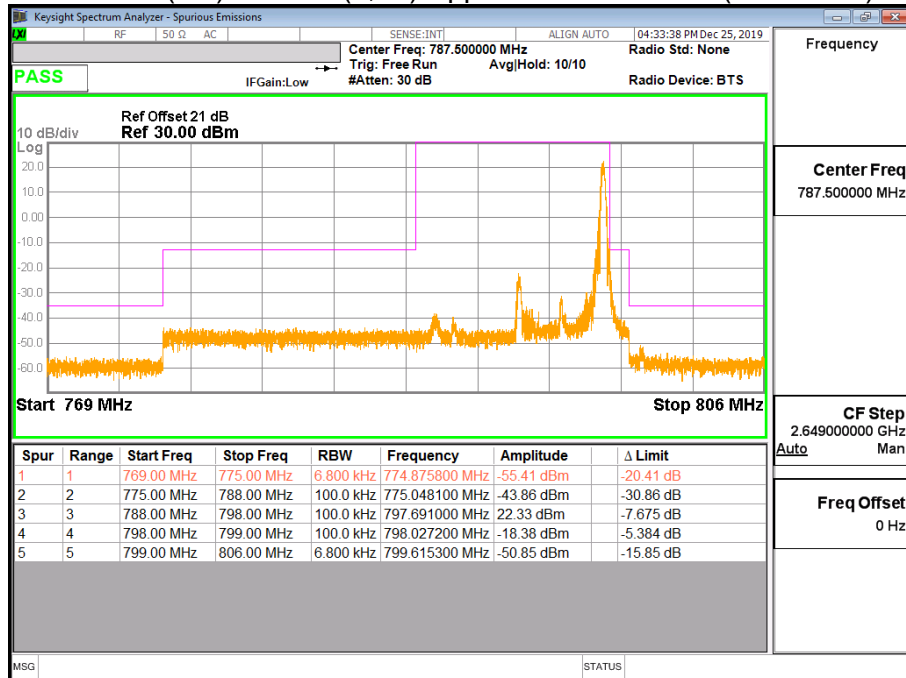

Band 14 (5M) 16QAM (25,0) Lower Channel 23305 (790.5MHz)

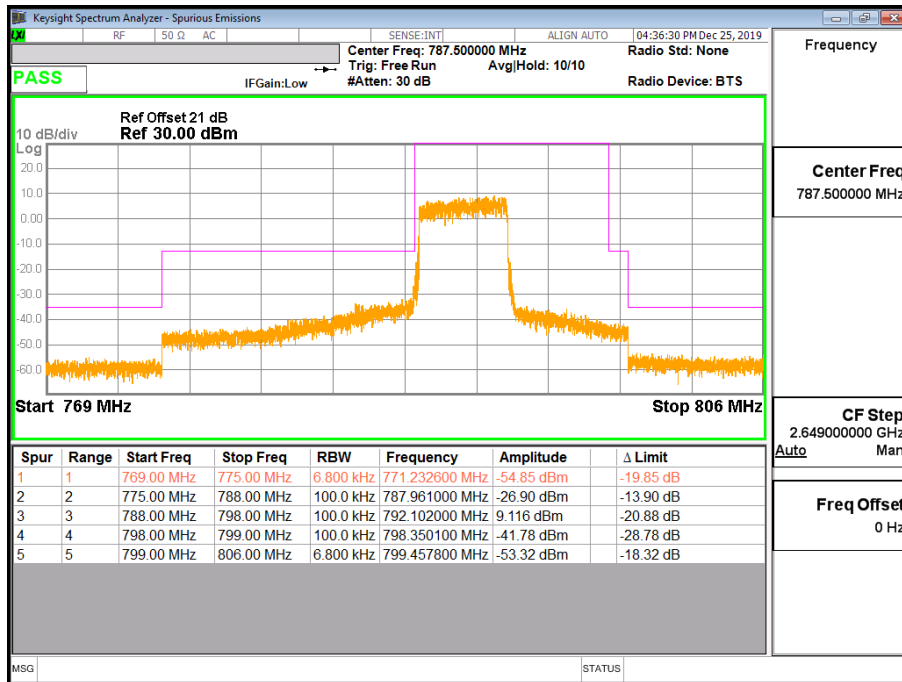

Band 14 (5M) 16QAM (25,0) Upper Channel 23355 (795.5MHz)

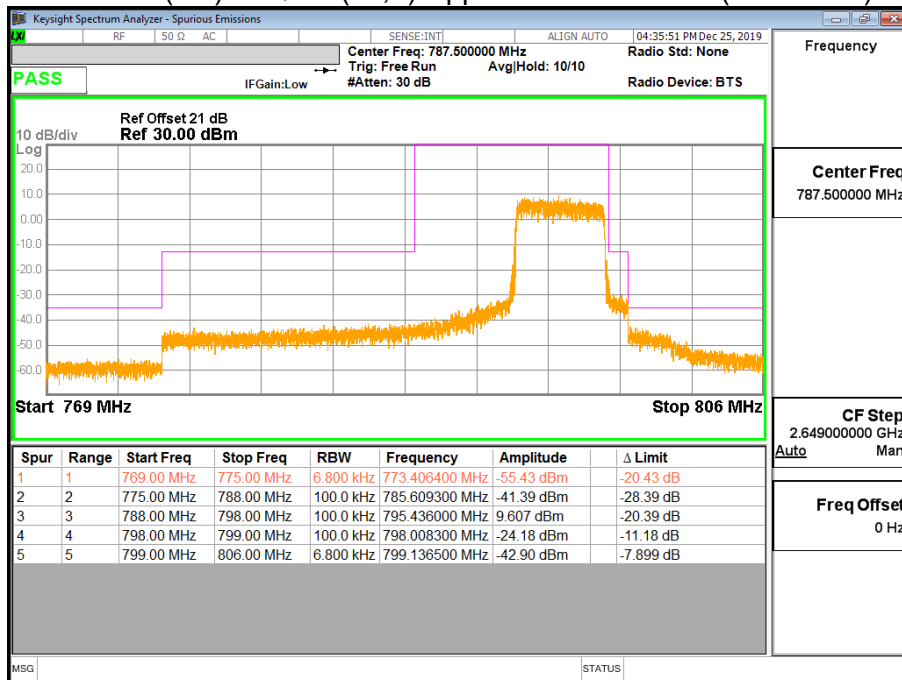

Product	Module		
Test Mode	Spurious Emission At Antenna Terminals (+/-1MHz)		
Date of Test	2019/12/27	Test Site	CTR
Test Condition	Block Edge Test (Band 14 (10M))	Environmental	23.2(°C) 51(%RH)

Band 14 (10M) QPSK (1,0) Lower Channel 23330 (793MHz)

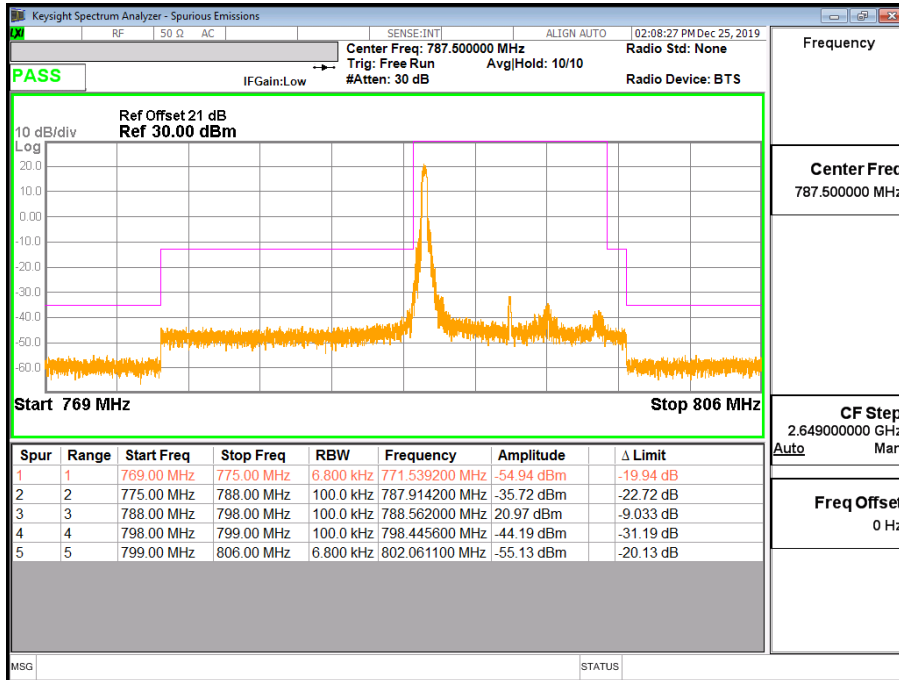

Band 14 (10M) QPSK (1,49) Upper Channel 23330 (793MHz)

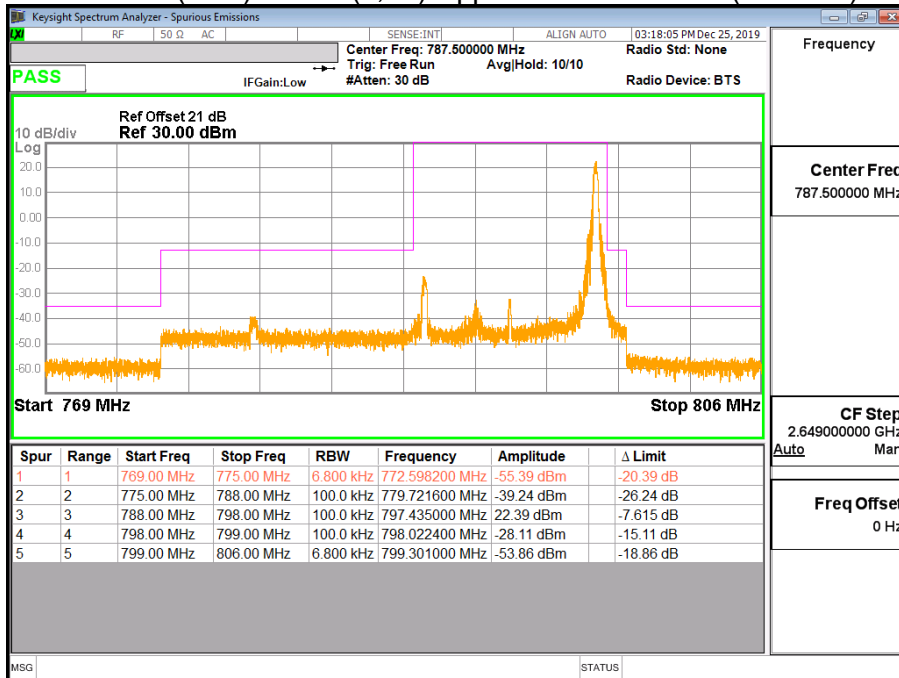

Band 14 (10M) QPSK (50,0) Lower Channel 23330 (793MHz)

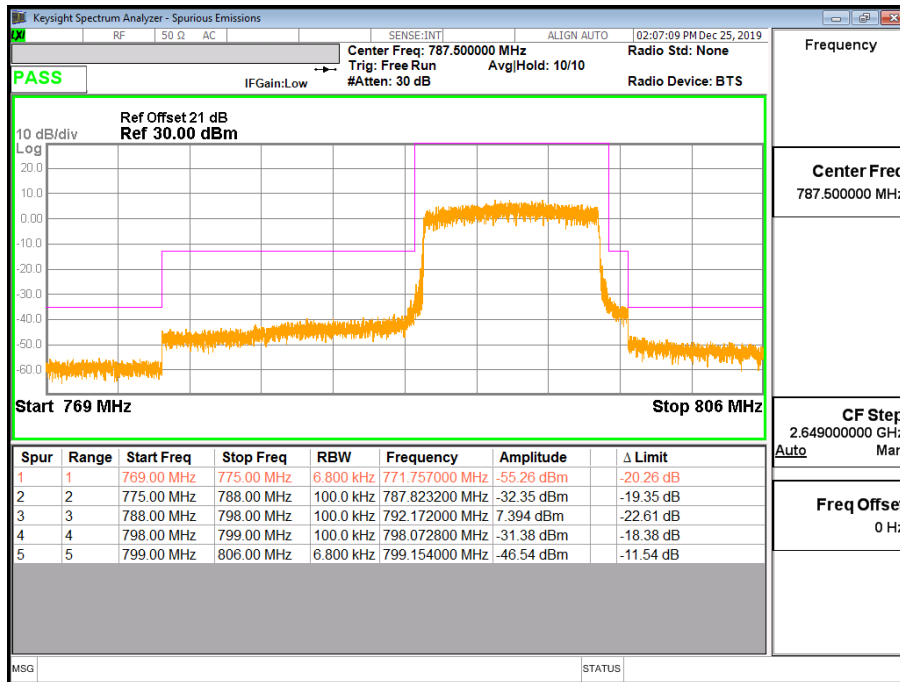

Band 14 (10M) 16QAM (1,0) Lower Channel 23330 (793MHz)

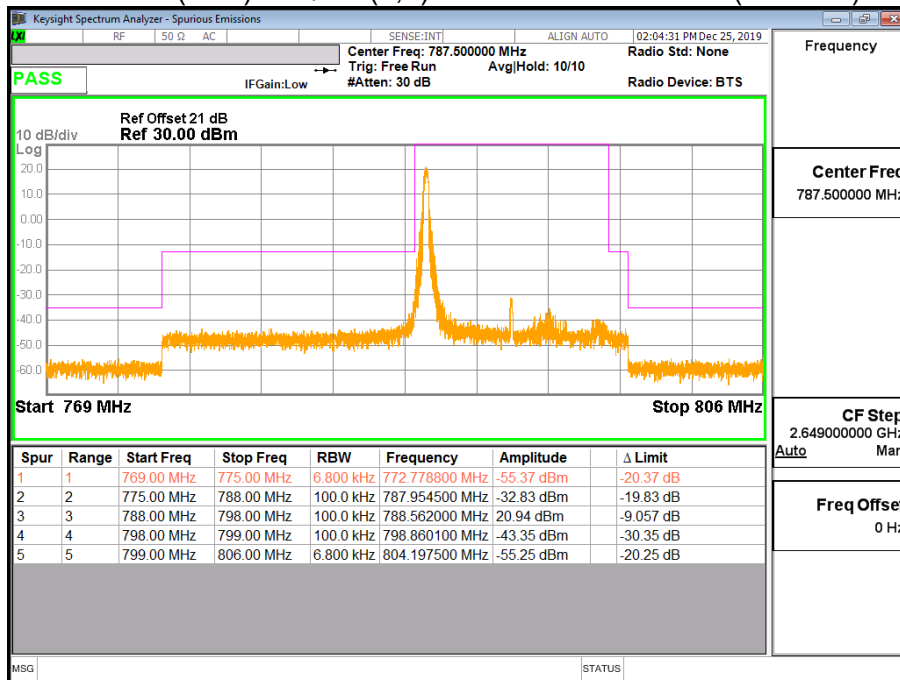

Band 14 (10M) 16QAM (1,49) Upper Channel 23330 (793MHz)

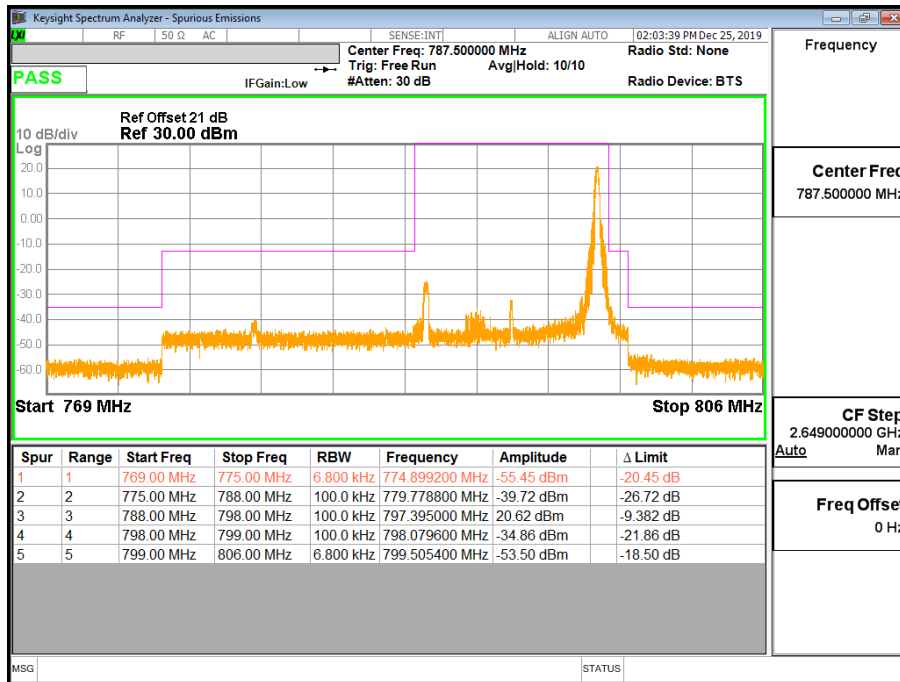

Band 14 (10M) 16QAM (50,0) Lower Channel 23330 (793MHz)

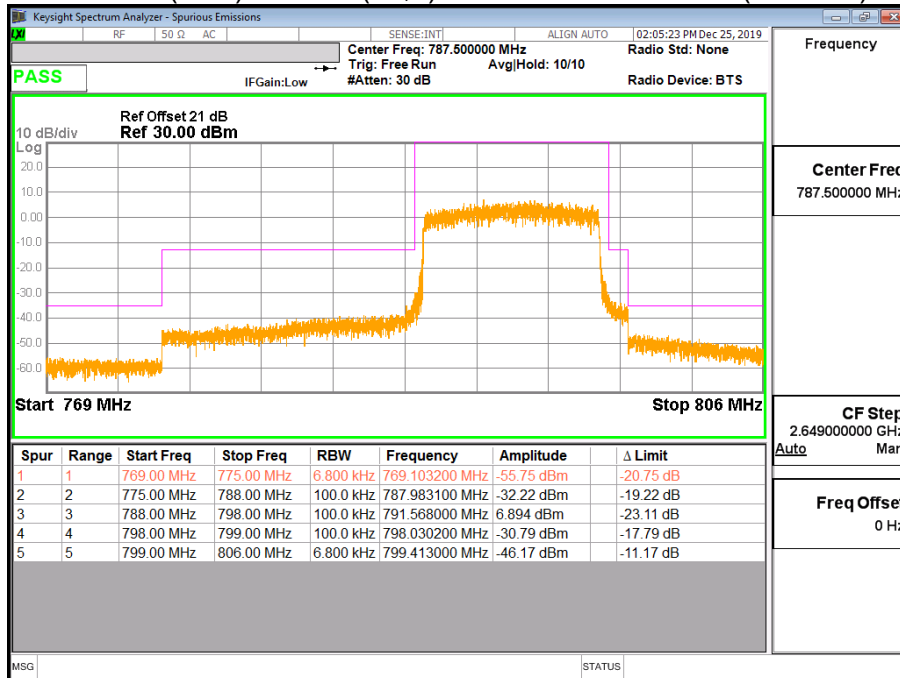

6. Spurious Emission

6.1. Test Specification

According to Part 2.1051, 90.543

6.2. Test Setup

6.2.1 Spurious emissions at antenna terminals.

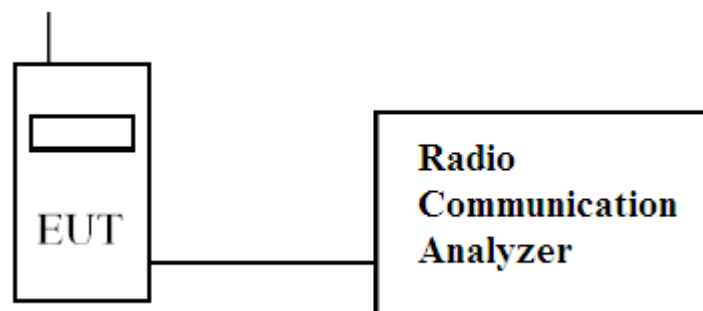

6.2.2 Field strength of spurious radiation.

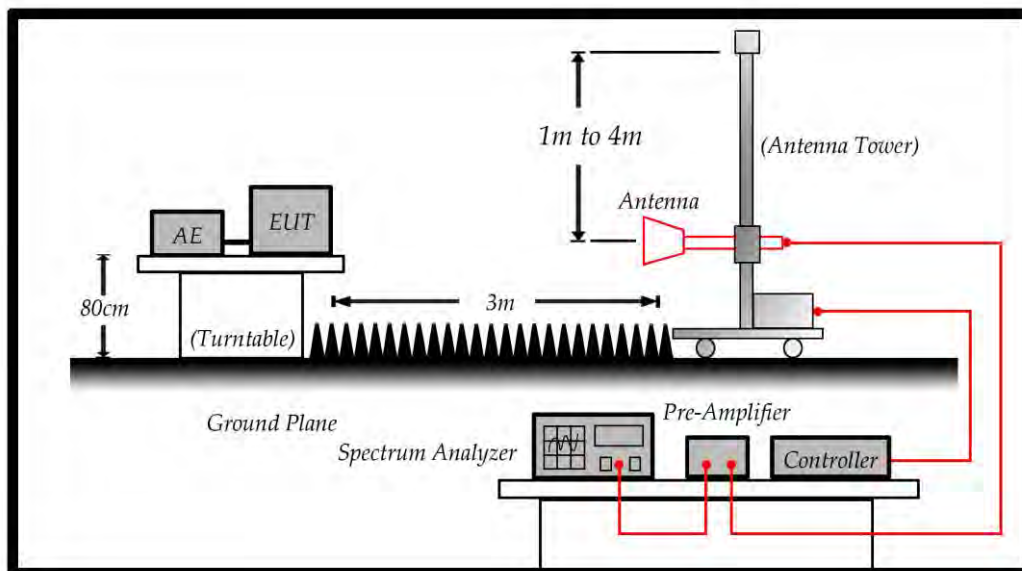

Note: The Worst case Mode is QPSK Mode for Radiated spurious emissions.

6.3. Limits

Limit	<-13dBm
-------	---------

43 + 10Log(P) down on the carrier where P is the power in Watts.

6.4. Test Procedure

In accordance with Part 2.1051, 90.543, the spurious emissions from the antenna terminal were measured. The transmitter output power was attenuated using a combination of filters and attenuators and the frequency spectrum investigated from 30MHz to 10GHz. The EUT was set to transmit on full power. The EUT was tested on Low, middle and High channels for both power levels. The resolution and video bandwidth was set to 1MHz/3MHz in accordance with Part 2.1051, 90.543. The spectrum analyzer detector was set to Max Hold. In addition, measurements were made up to the 10th harmonic of the fundamental. The device was then replaced with a substitution antenna, which input signal was adjusted until the received level matched that of the previously detected emission.

- (1) The EUT is tested with maximum rated TX power via the Base Station simulator.
- (2) The EUT is tested in three orthogonal planes, The worst case was showing in this report.

The EUT is placed on a turn table which is 1.5 meter above ground. The turn table can rotate 360 degrees to determine the position of the maximum emission level. The EUT was positioned such that the distance from antenna to the EUT was 3 meters.

The antenna can move up and down between 1 meter and 4 meters to find out the maximum emission level.

Both horizontal and vertical polarization of the antenna are set on measurement. In order to find the maximum emission, all of the interface cables must be manipulated according to TIA/EIA 603-E on radiated measurement.

90.543(f) For operations in the 758-775 MHz and 788-805 MHz bands, all emissions including harmonics in the band 1559-1610 MHz shall be limited to -70 dBW/MHz equivalent isotropically radiated power (EIRP) for wideband signals, and -80 dBW EIRP for discrete emissions of less than 700 Hz bandwidth.

6.5. Test Result of Spurious Emission

Product	Module		
Test Mode	Spurious Emission (Conducted)	Test Site	CTR
Date of Test	2019/12/27	Test Range	30MHz~10GHz
Test Condition	LTE-Band 14 (5M)	Environmental	23.2(°C) 51(%RH)

LTE-Band 14 (5M) QPSK (1,12) CH23305 (790.5MHz)

Frequency (MHz)	Reading Level (dBm)	Path Loss (dB)	Emission Level (dBm)	Limit (dBm)
1581	-57.752	0.58	-57.172	-40
2372	-54.794	0.70	-54.094	-13
3162	-62.148	1.01	-61.138	-13
3953	-67.241	1.18	-66.061	-13
4743	-64.881	1.23	-63.651	-13
5534	-63.600	1.45	-62.150	-13
6324	-64.644	1.56	-63.084	-13
7115	-64.399	1.59	-62.809	-13
7905	-65.682	1.82	-63.862	-13

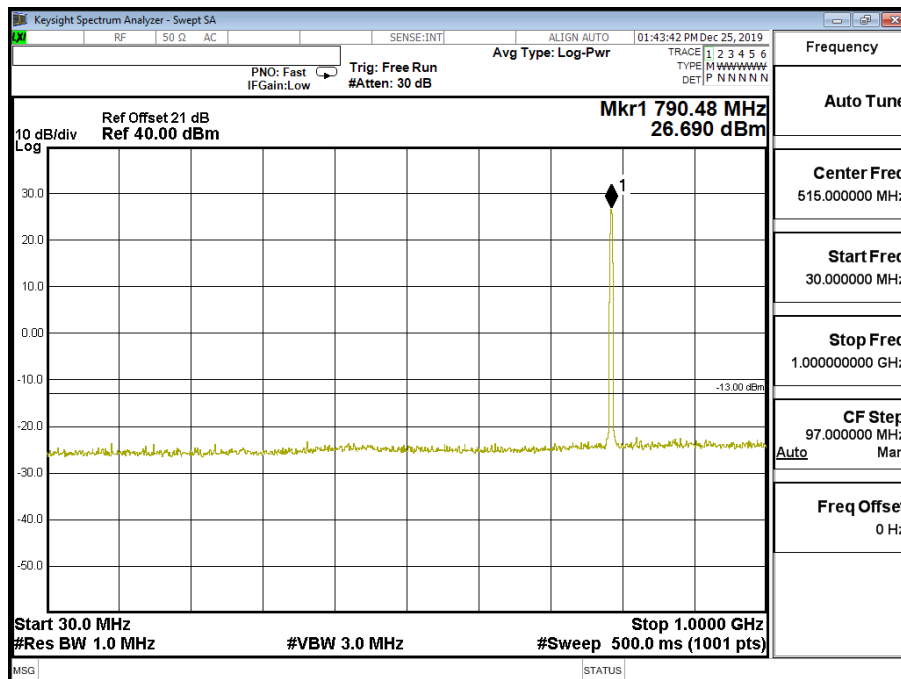

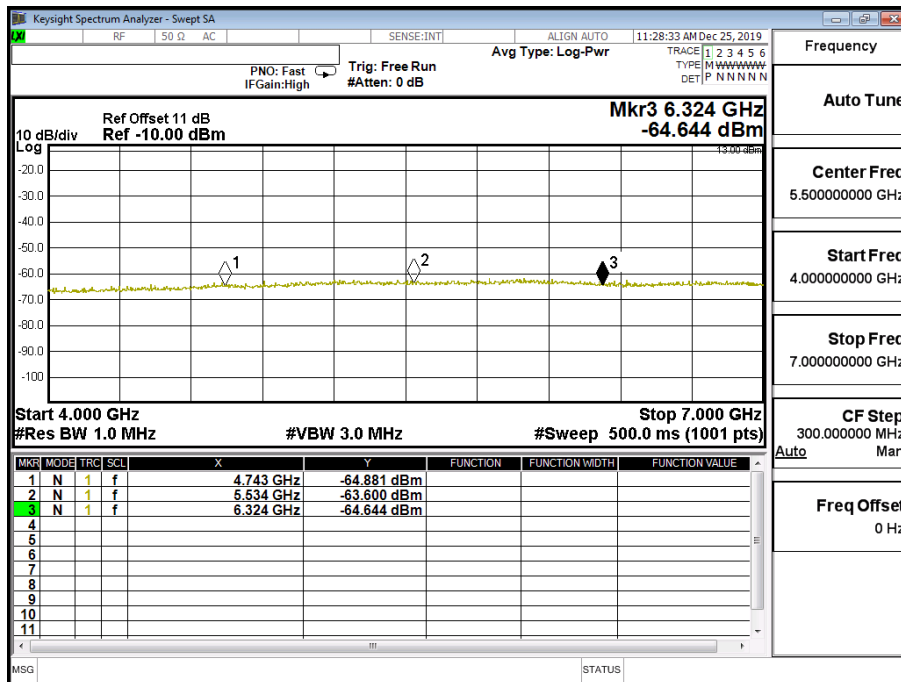
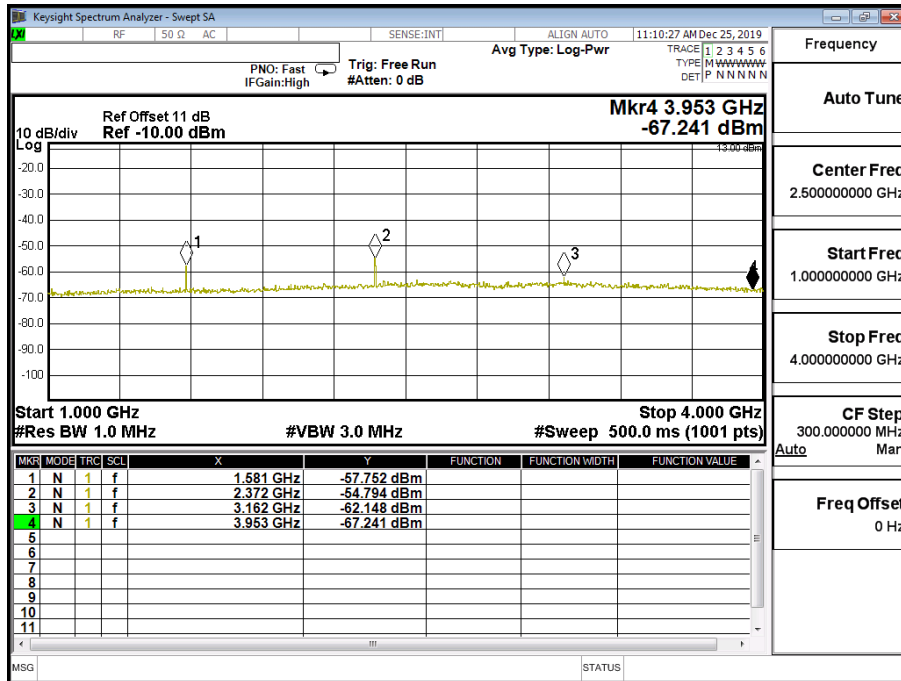

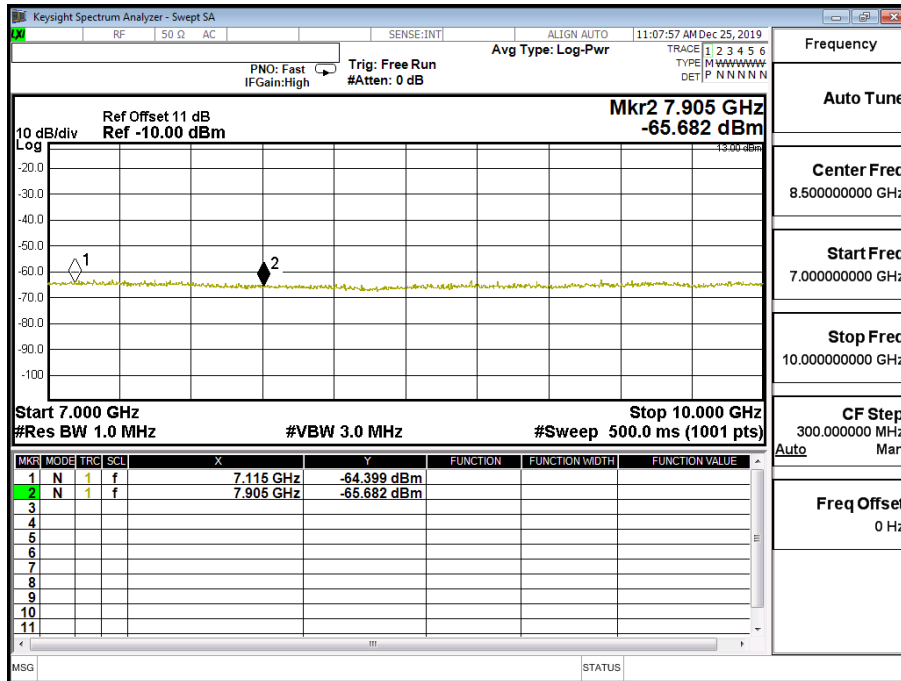

Product	Module		
Test Mode	Spurious Emission (Conducted)	Test Site	CTR
Date of Test	2019/12/27	Test Range	30MHz~10GHz
Test Condition	LTE-Band 14 (5M)	Environmental	23.2(°C) 51(%RH)

LTE- Band 14 (5M) 16QAM (1,12) CH23305 (790.5MHz)

Frequency (MHz)	Reading Level (dBm)	Path Loss (dB)	Emission Level (dBm)	Limit (dBm)
1581	-57.560	0.58	-56.980	-40
2372	-54.755	0.70	-54.055	-13
3162	-61.396	1.01	-60.386	-13
3953	-66.833	1.18	-65.653	-13
4743	-65.084	1.23	-63.854	-13
5534	-64.478	1.45	-63.028	-13
6324	-64.306	1.56	-62.746	-13
7115	-64.966	1.59	-63.376	-13
7905	-66.649	1.82	-64.829	-13

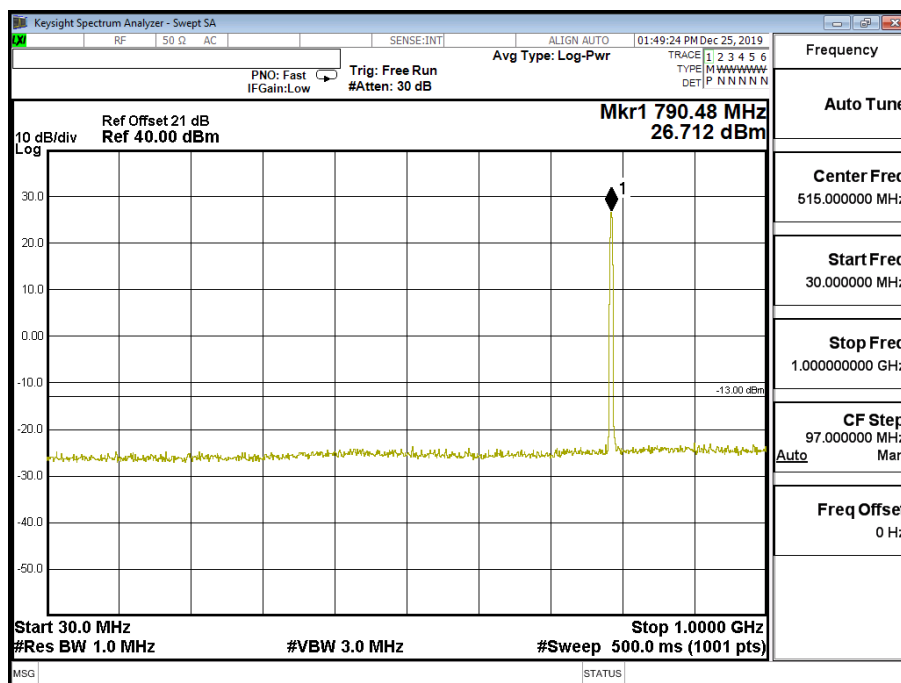

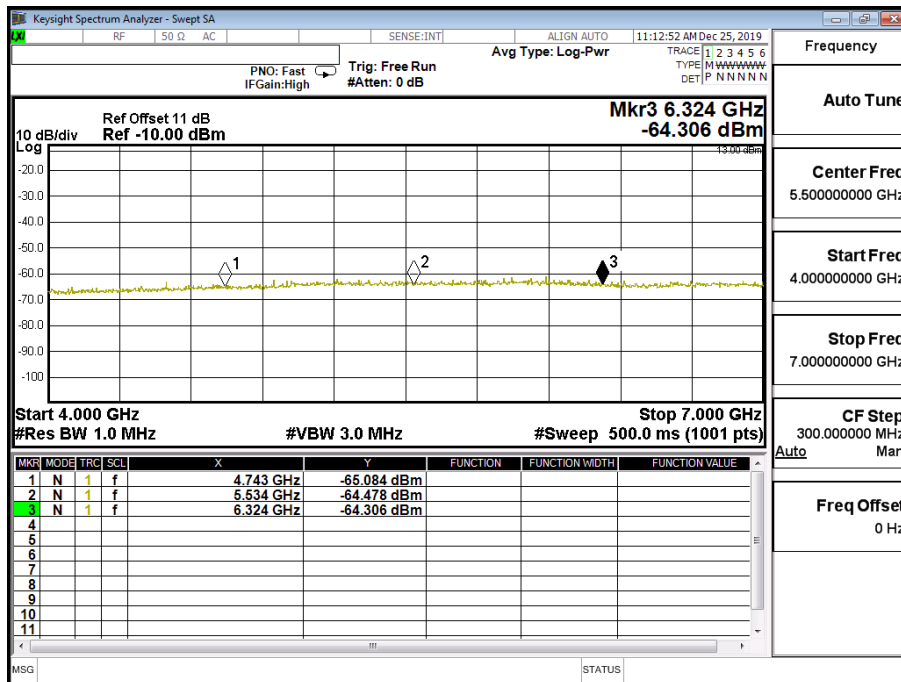
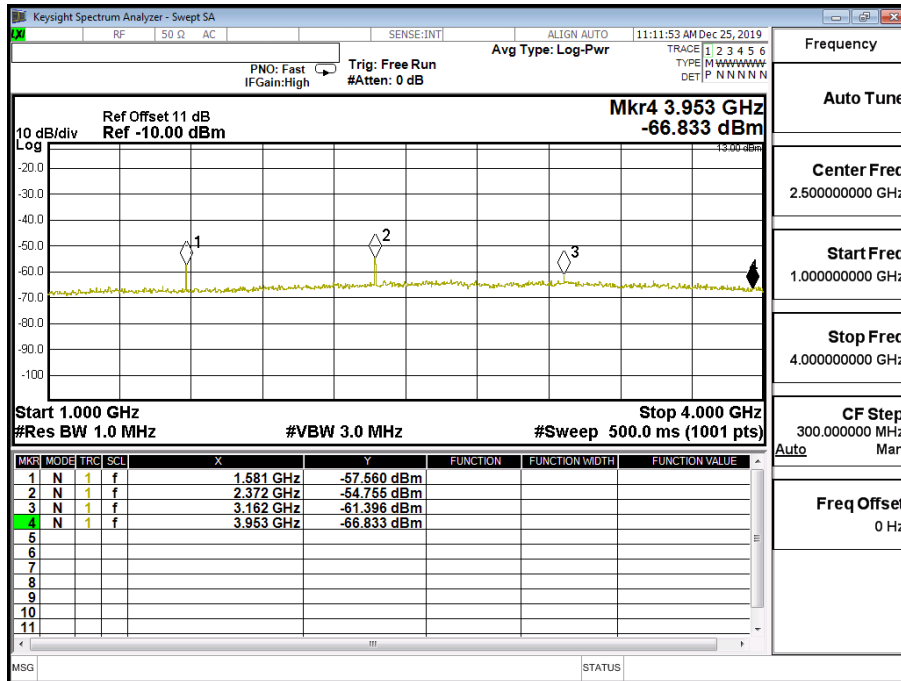

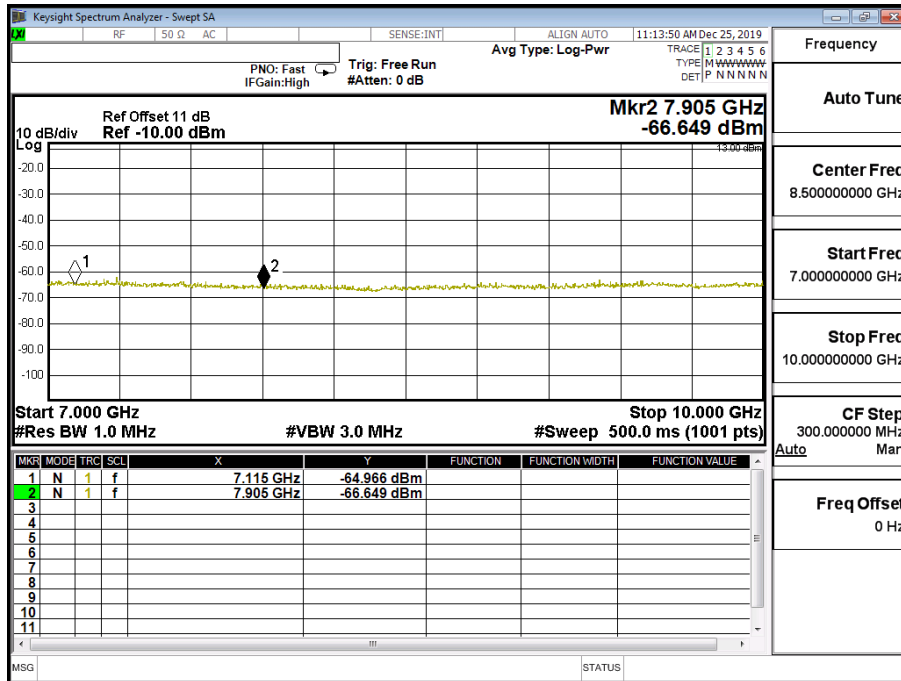

Product	Module		
Test Mode	Spurious Emission (Conducted)	Test Site	CTR
Date of Test	2019/12/27	Test Range	30MHz~10GHz
Test Condition	LTE-Band 14 (5M)	Environmental	23.2(°C) 51(%RH)

LTE-Band 14 (5M) QPSK (1,12) CH23330 (793MHz)

Frequency (MHz)	Reading Level (dBm)	Path Loss (dB)	Emission Level (dBm)	Limit (dBm)
1586	-58.315	0.58	-57.735	-40
2379	-57.012	0.70	-56.312	-13
3172	-62.429	1.01	-61.419	-13
3965	-67.499	1.18	-66.319	-13
4758	-65.403	1.23	-64.173	-13
5551	-63.462	1.45	-62.012	-13
6344	-65.127	1.56	-63.567	-13
7137	-65.223	1.59	-63.633	-13
7930	-66.595	1.82	-64.775	-13

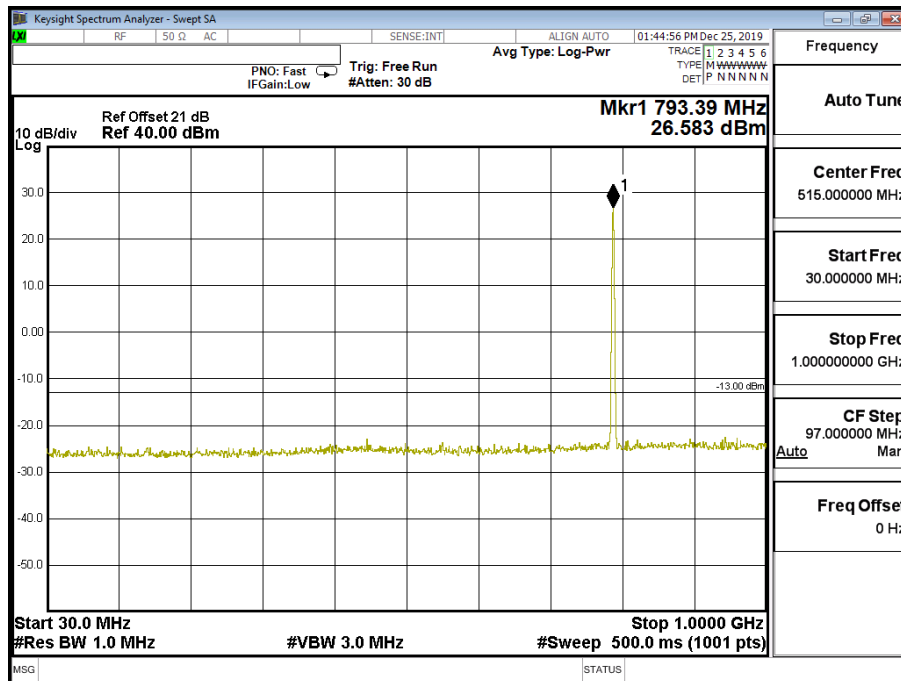

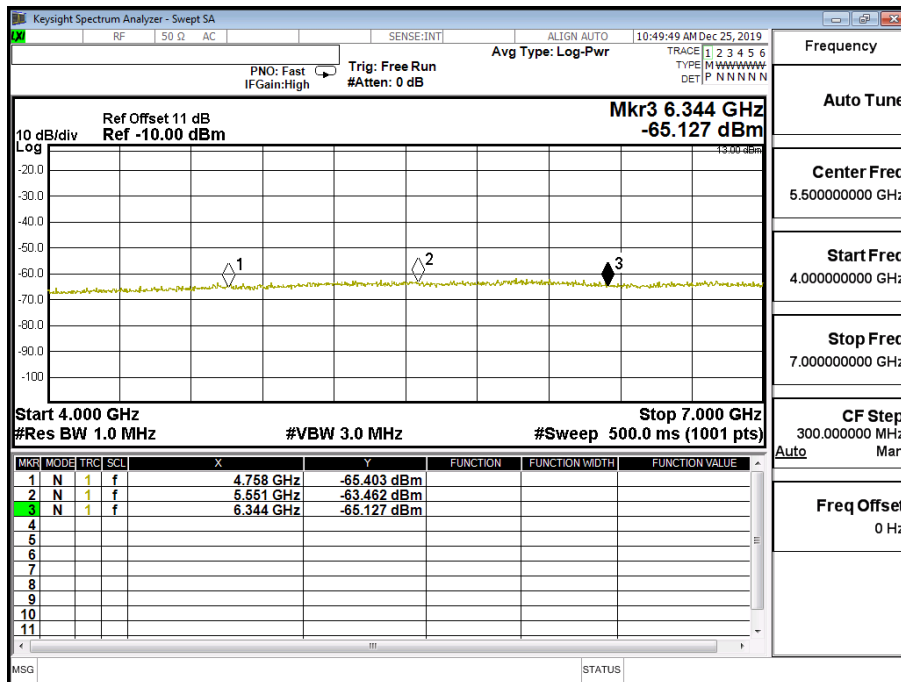
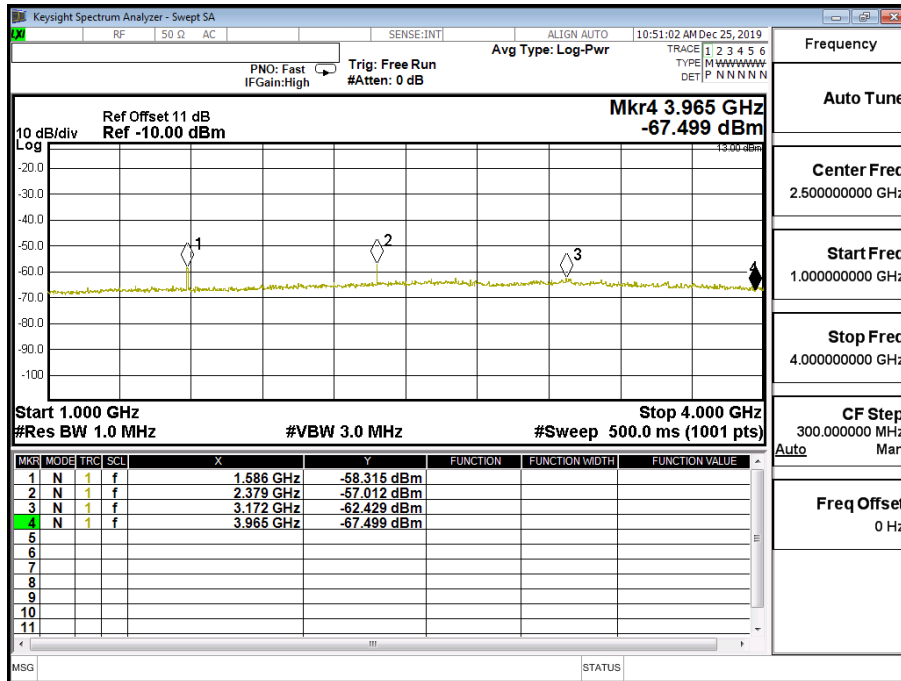

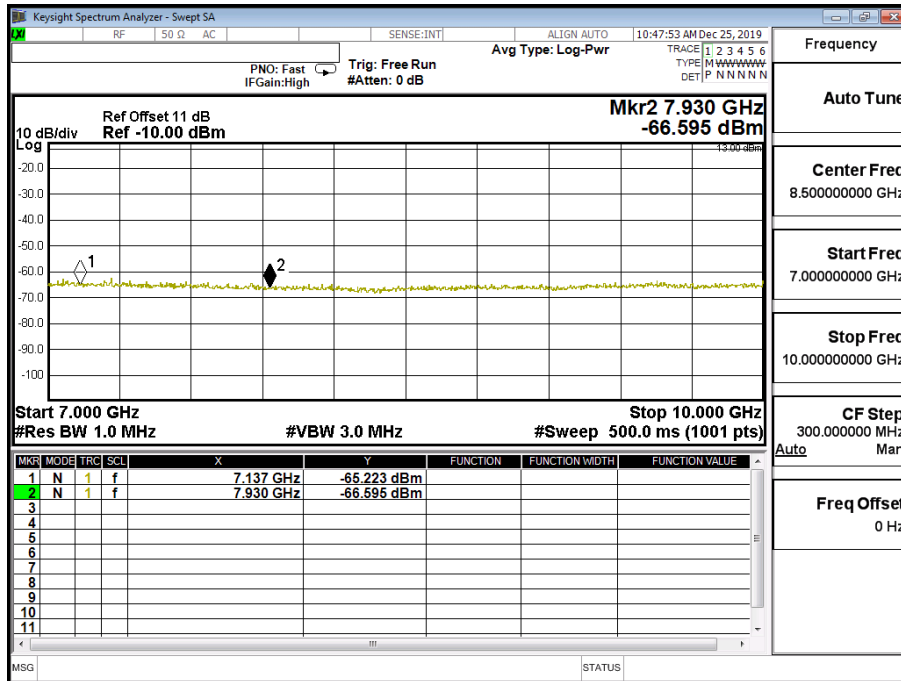

Product	Module		
Test Mode	Spurious Emission (Conducted)	Test Site	CTR
Date of Test	2019/12/27	Test Range	30MHz~10GHz
Test Condition	LTE-Band 14 (5M)	Environmental	23.2(°C) 51(%RH)

LTE- Band 14 (5M) 16QAM (1,12) CH23330 (793MHz)

Frequency (MHz)	Reading Level (dBm)	Path Loss (dB)	Emission Level (dBm)	Limit (dBm)
1586	-58.056	0.58	-57.476	-40
2379	-57.511	0.70	-56.811	-13
3172	-62.558	1.01	-61.548	-13
3965	-66.080	1.18	-64.900	-13
4758	-64.182	1.23	-62.952	-13
5551	-62.287	1.45	-60.837	-13
6344	-64.700	1.56	-63.140	-13
7137	-64.845	1.59	-63.255	-13
7930	-65.820	1.82	-64.000	-13

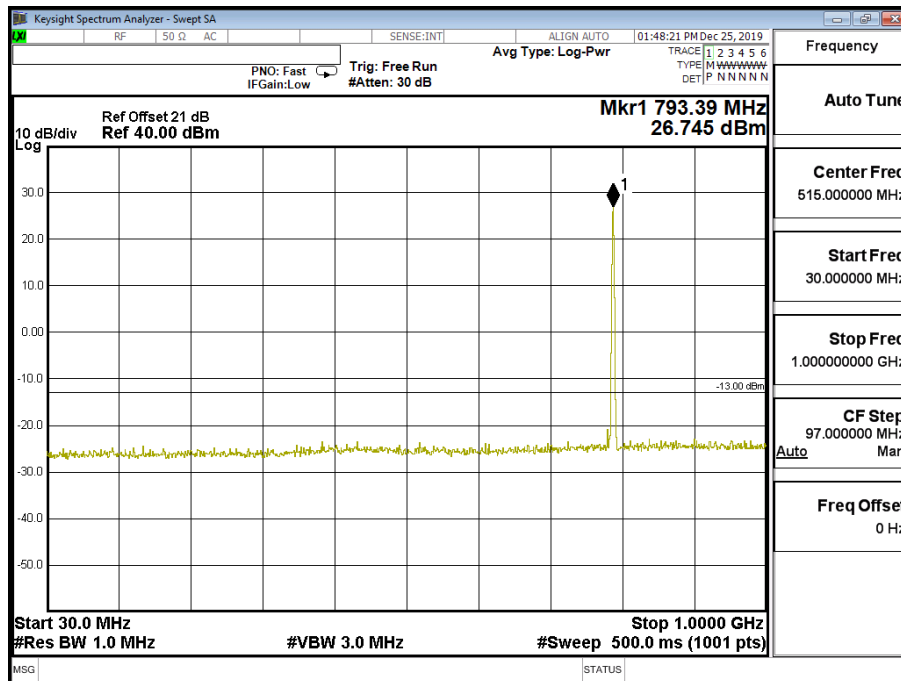

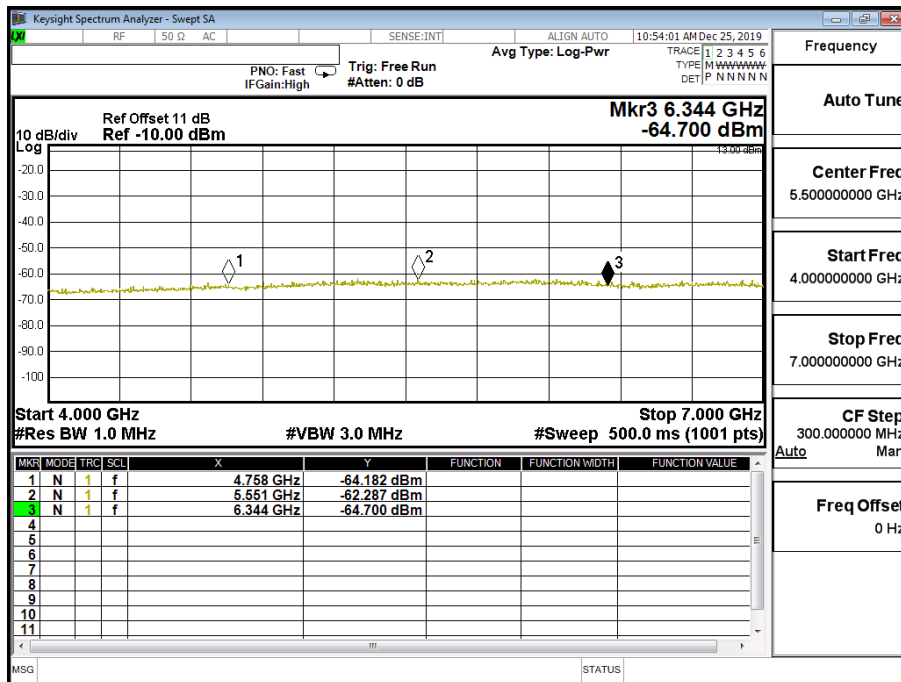
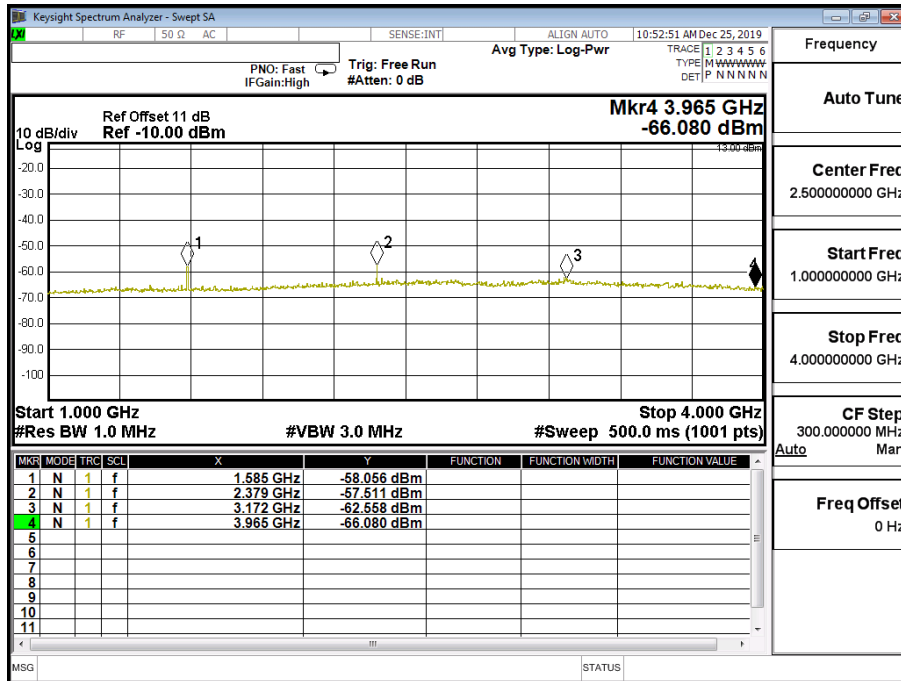

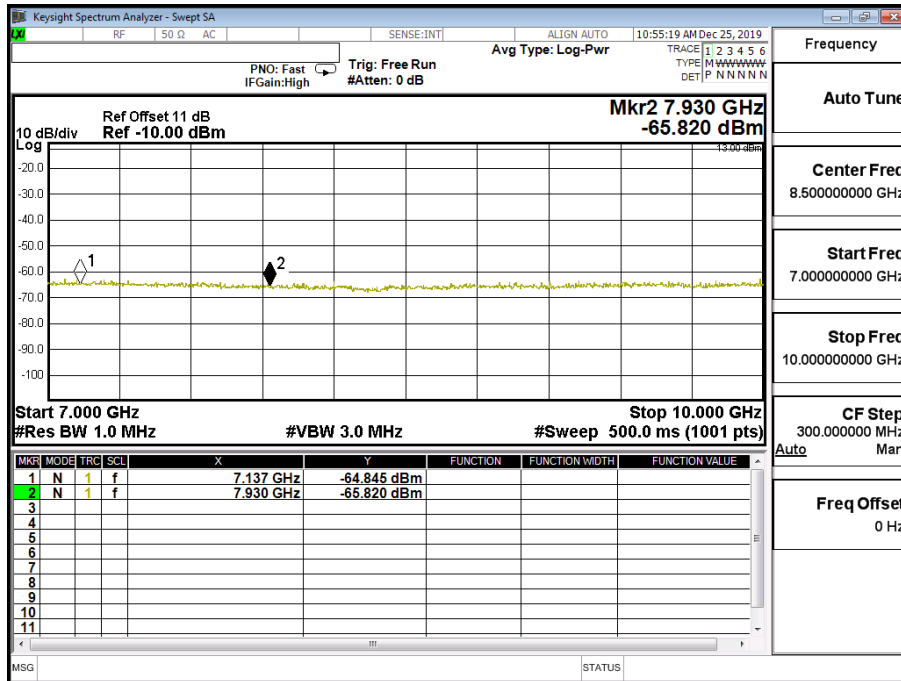

Product	Module		
Test Mode	Spurious Emission (Conducted)	Test Site	CTR
Date of Test	2019/12/27	Test Range	30MHz~10GHz
Test Condition	LTE-Band 14 (5M)	Environmental	23.2(°C) 51(%RH)

LTE-Band 14 (5M) QPSK (1,12) CH23355 (795.5MHz)

Frequency (MHz)	Reading Level (dBm)	Path Loss (dB)	Emission Level (dBm)	Limit (dBm)
1591	-61.420	0.58	-60.840	-40
2387	-59.782	0.70	-59.082	-13
3182	-63.161	1.01	-62.151	-13
3978	-66.689	1.18	-65.509	-13
4773	-65.567	1.23	-64.337	-13
5569	-63.617	1.45	-62.167	-13
6364	-64.314	1.56	-62.754	-13
7160	-64.564	1.59	-62.974	-13
7955	-65.646	1.82	-63.826	-13

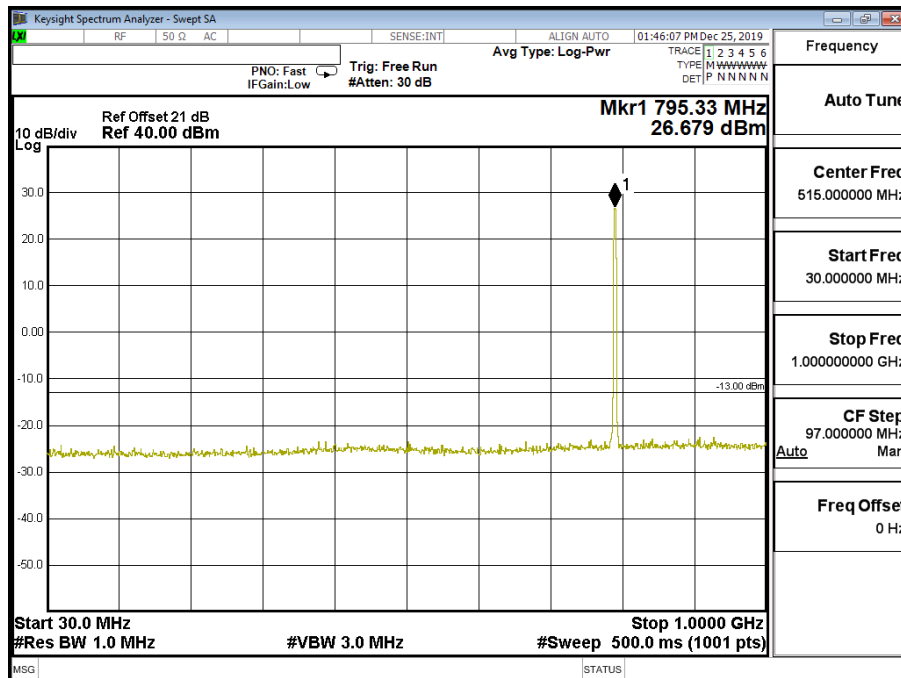

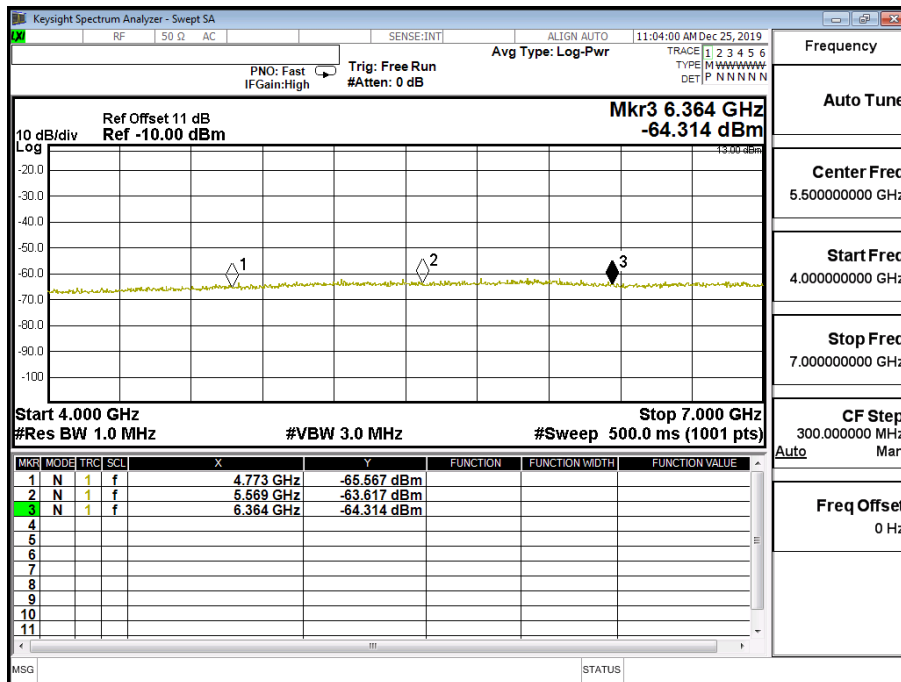
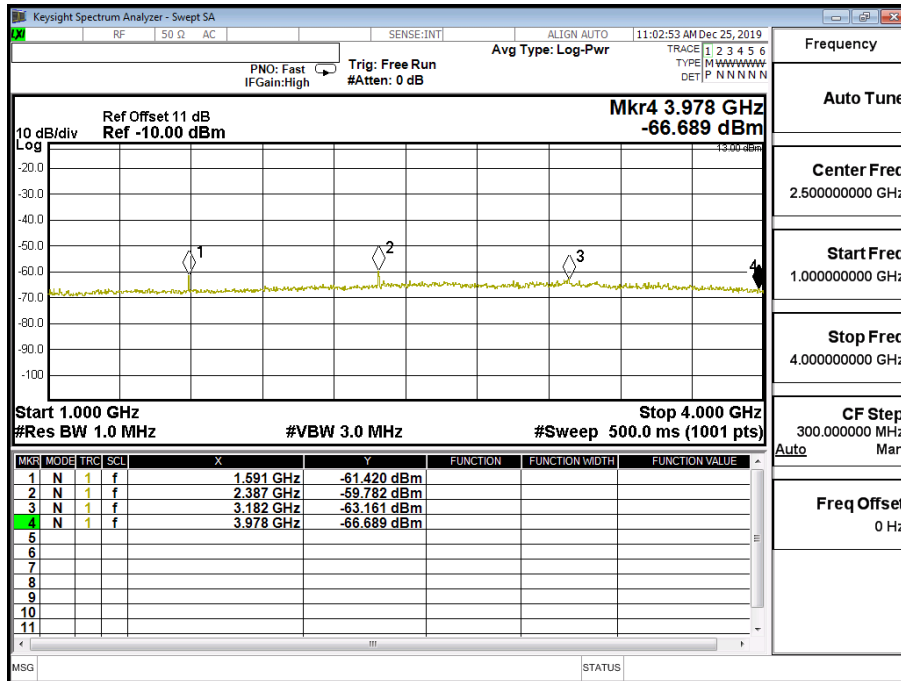

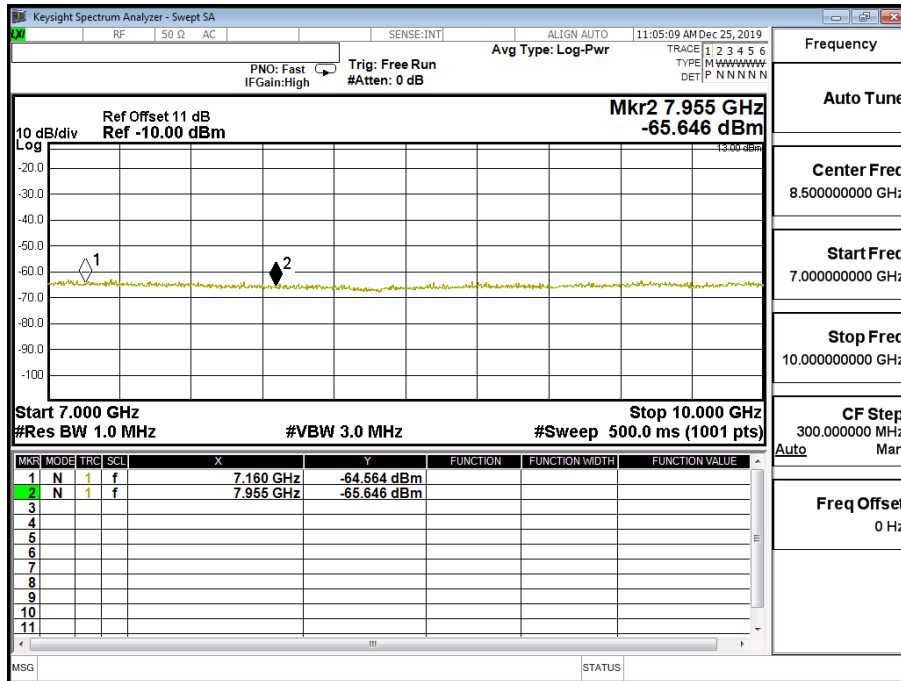

Product	Module		
Test Mode	Spurious Emission (Conducted)	Test Site	CTR
Date of Test	2019/12/27	Test Range	30MHz~10GHz
Test Condition	LTE-Band 14 (5M)	Environmental	23.2(°C) 51(%RH)

LTE- Band 14 (5M) 16QAM (1,0) CH23355 (795.5MHz)

Frequency (MHz)	Reading Level (dBm)	Path Loss (dB)	Emission Level (dBm)	Limit (dBm)
1591	-61.990	0.58	-61.410	-40
2387	-60.487	0.70	-59.787	-13
3182	-62.965	1.01	-61.955	-13
3978	-67.232	1.18	-66.052	-13
4773	-64.855	1.23	-63.625	-13
5569	-64.025	1.45	-62.575	-13
6364	-64.680	1.56	-63.120	-13
7160	-65.587	1.59	-63.997	-13
7955	-65.943	1.82	-64.123	-13

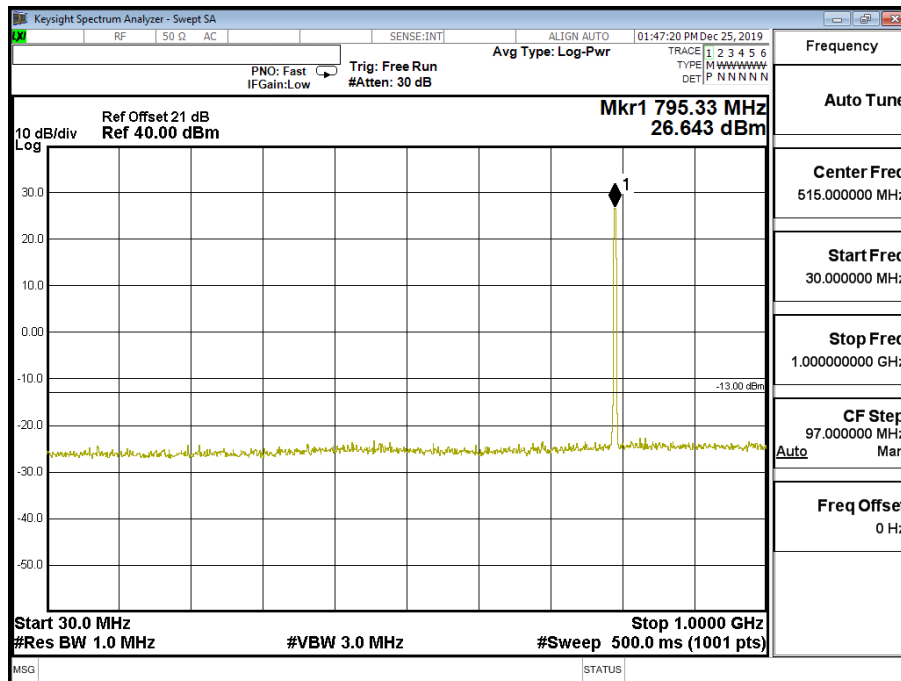

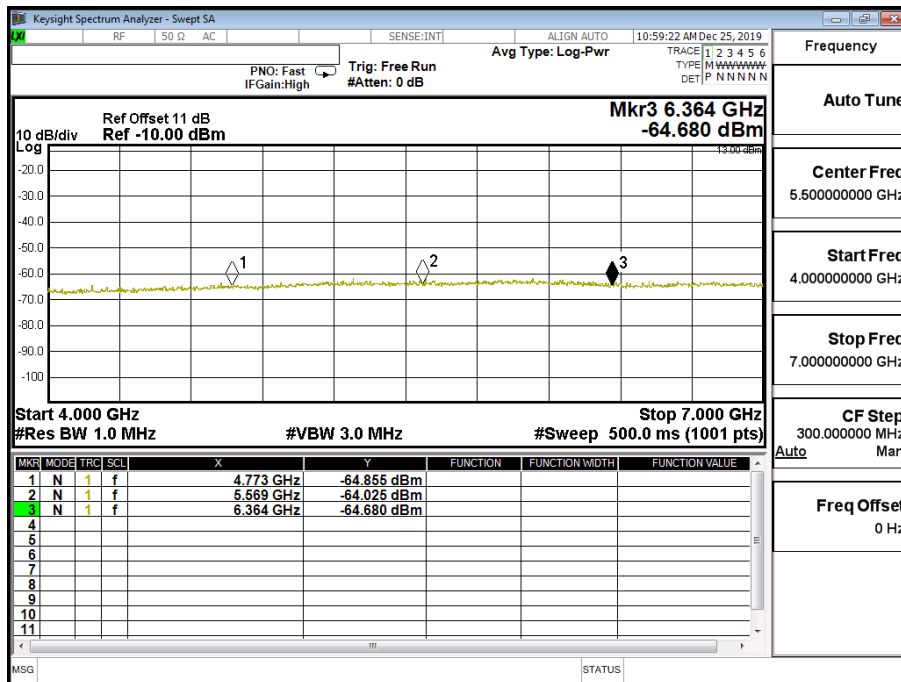
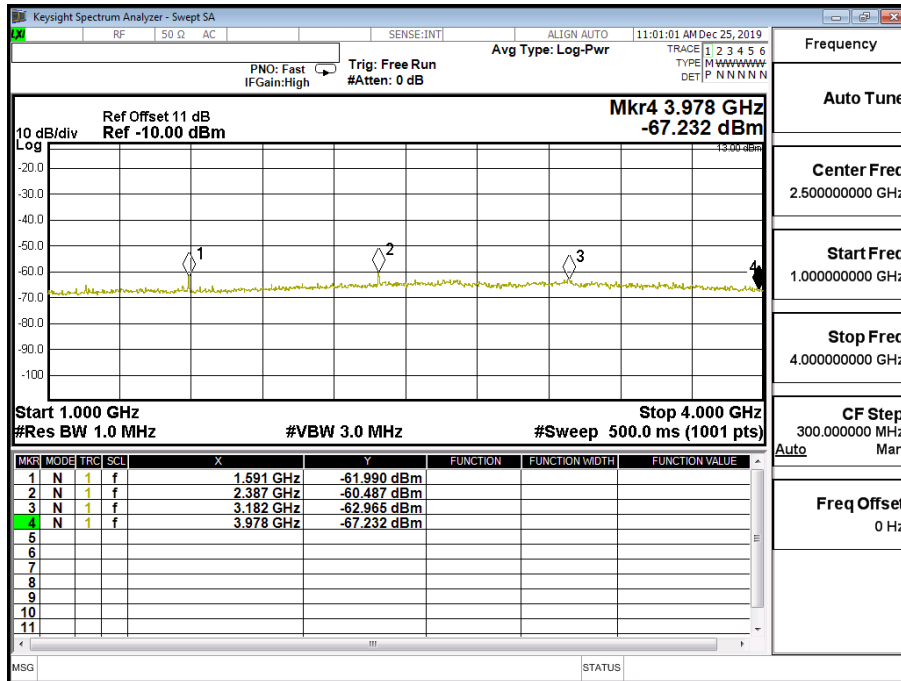

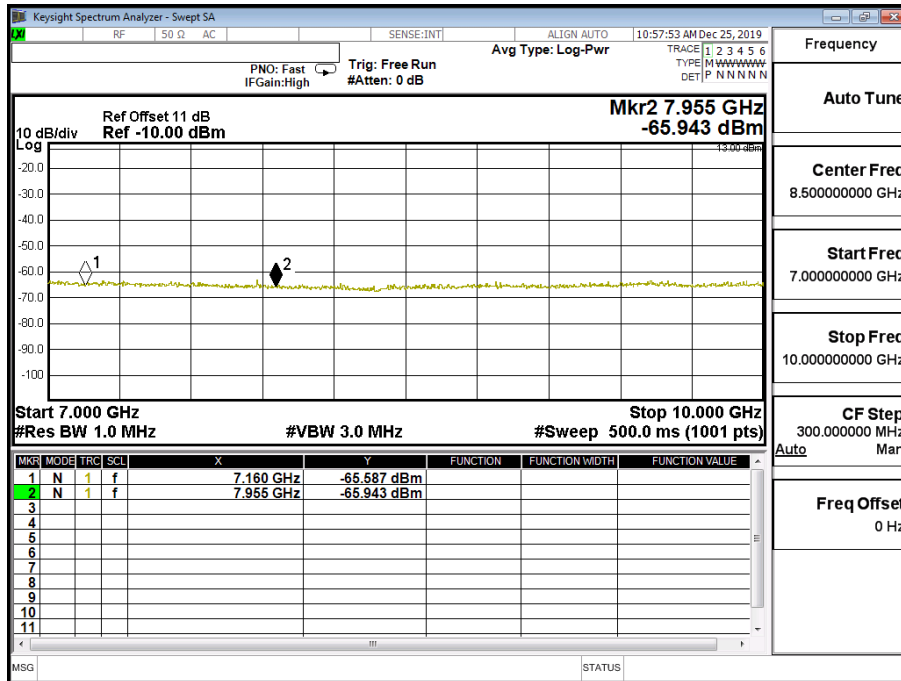

Product	Module		
Test Mode	Spurious Emission (Conducted)	Test Site	CTR
Date of Test	2019/12/27	Test Range	30MHz~10GHz
Test Condition	LTE-Band 14 (10M)	Environmental	23.2(°C) 51(%RH)

LTE- Band 14 (10M) QPSK (1,24) CH23330 (793MHz)

Frequency (MHz)	Reading Level (dBm)	Path Loss (dB)	Emission Level (dBm)	Limit (dBm)
1586	-57.380	0.58	-56.800	-40
2379	-57.177	0.70	-56.477	-13
3172	-62.680	1.01	-61.670	-13
3965	-66.797	1.18	-65.617	-13
4758	-64.370	1.23	-63.140	-13
5551	-63.147	1.45	-61.697	-13
6344	-64.376	1.56	-62.816	-13
7137	-65.374	1.59	-63.784	-13
7930	-65.809	1.82	-63.989	-13

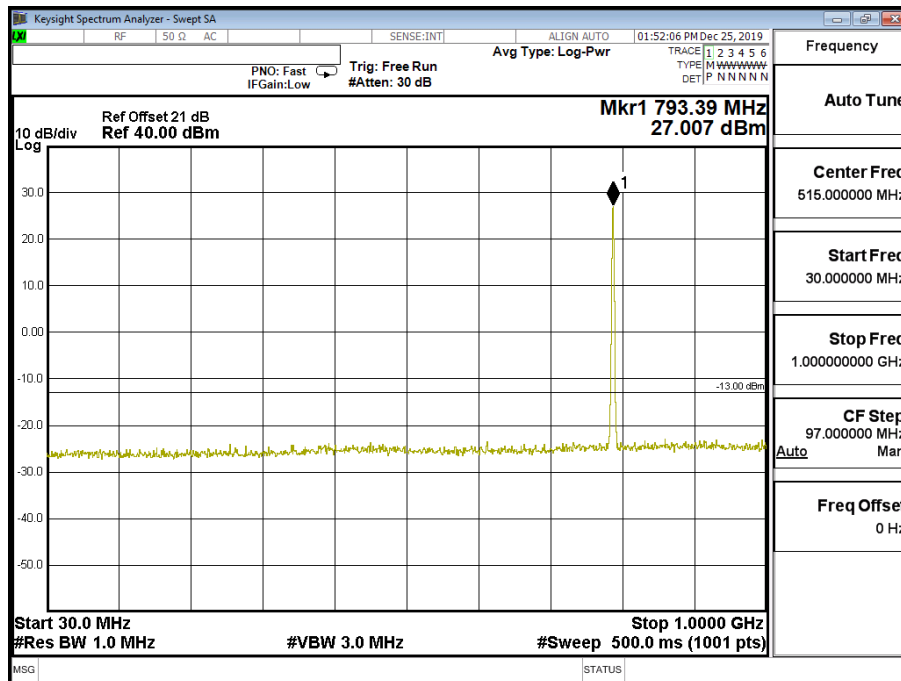

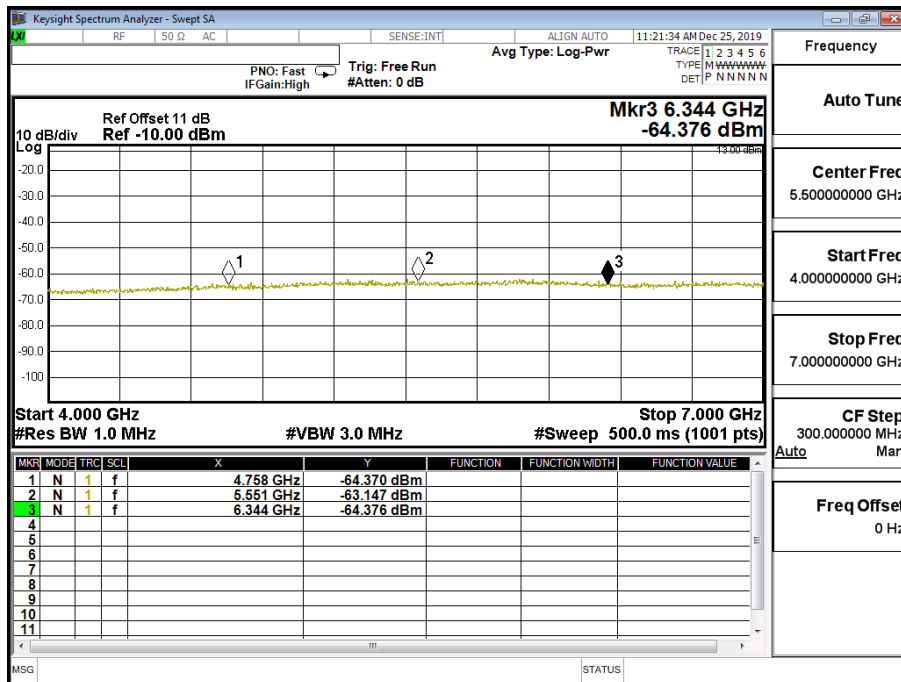
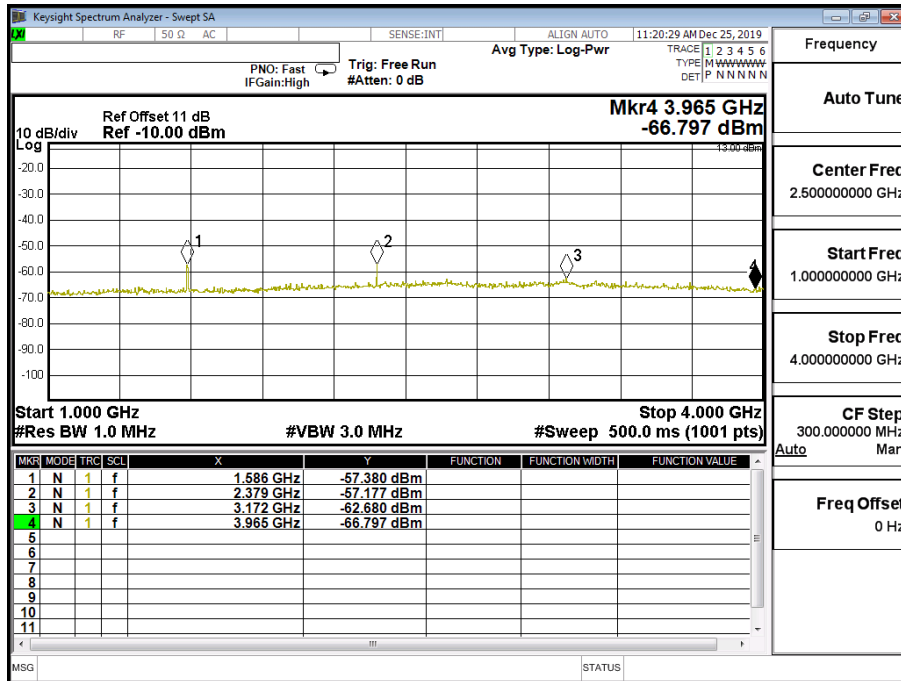

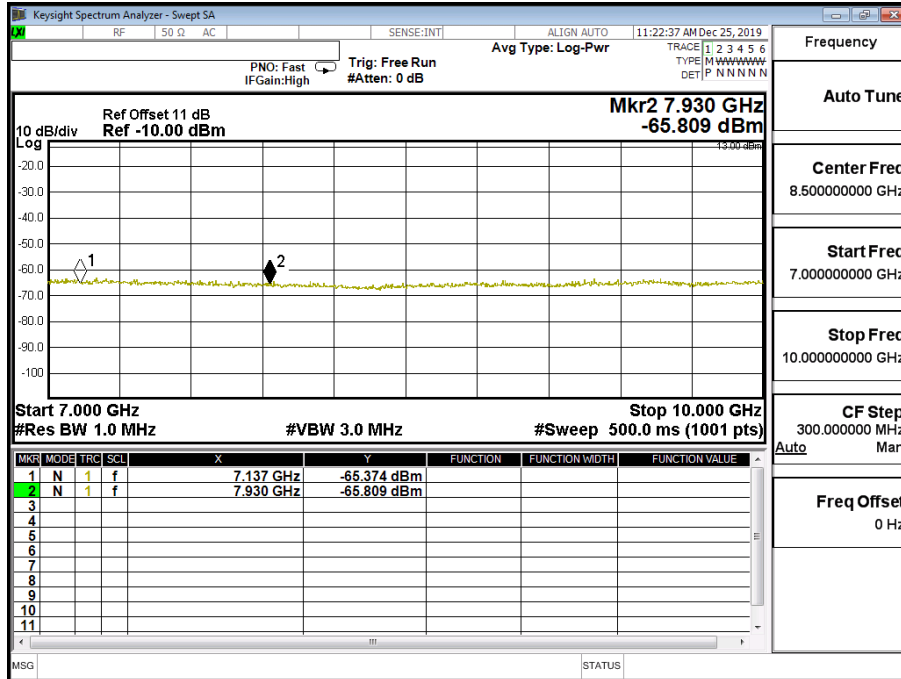

Product	Module		
Test Mode	Spurious Emission (Conducted)	Test Site	CTR
Date of Test	2019/12/27	Test Range	30MHz~10GHz
Test Condition	LTE-Band 14 (10M)	Environmental	23.2(°C) 51(%RH)

LTE- Band 14 10M 16QAM (1,24) CH23330 (793MHz)

Frequency (MHz)	Reading Level (dBm)	Path Loss (dB)	Emission Level (dBm)	Limit (dBm)
1586	-57.995	0.58	-57.415	-40
2379	-57.886	0.70	-57.186	-13
3172	-62.009	1.01	-60.999	-13
3965	-66.708	1.18	-65.528	-13
4758	-65.252	1.23	-64.022	-13
5551	-62.818	1.45	-61.368	-13
6344	-65.155	1.56	-63.595	-13
7137	-64.406	1.59	-62.816	-13
7930	-65.843	1.82	-64.023	-13

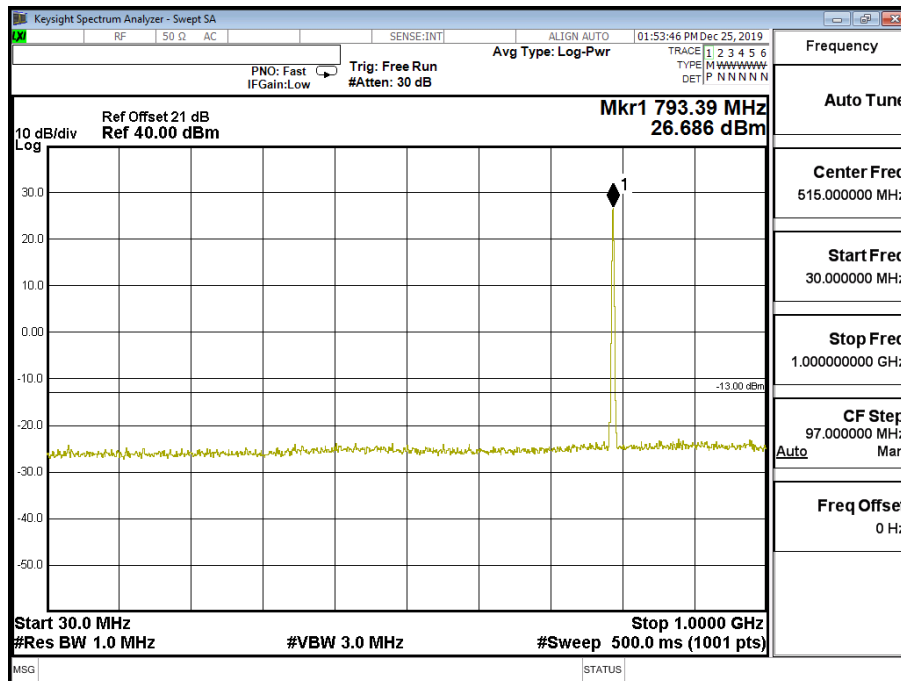

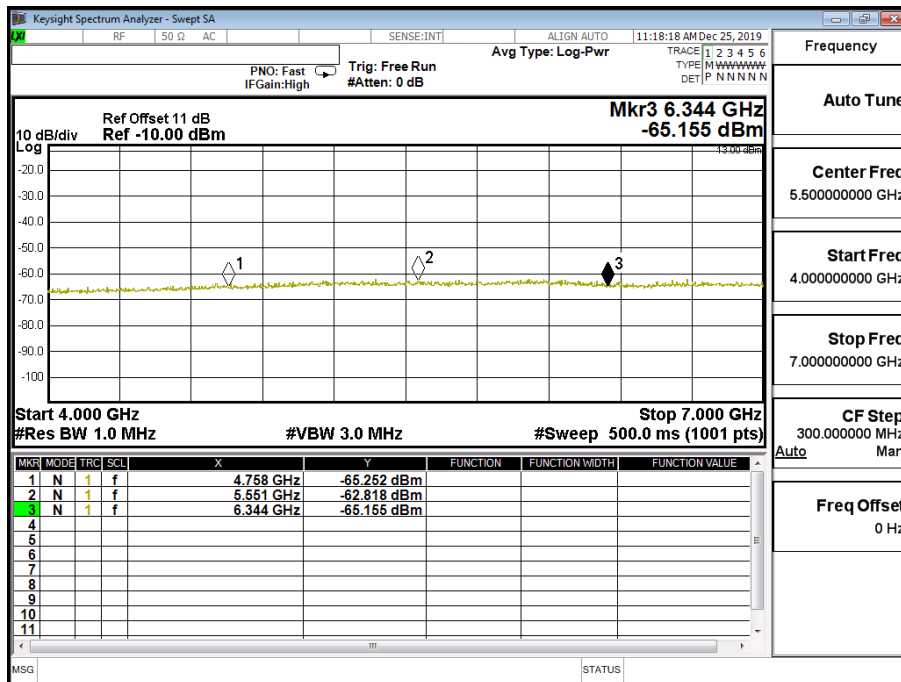
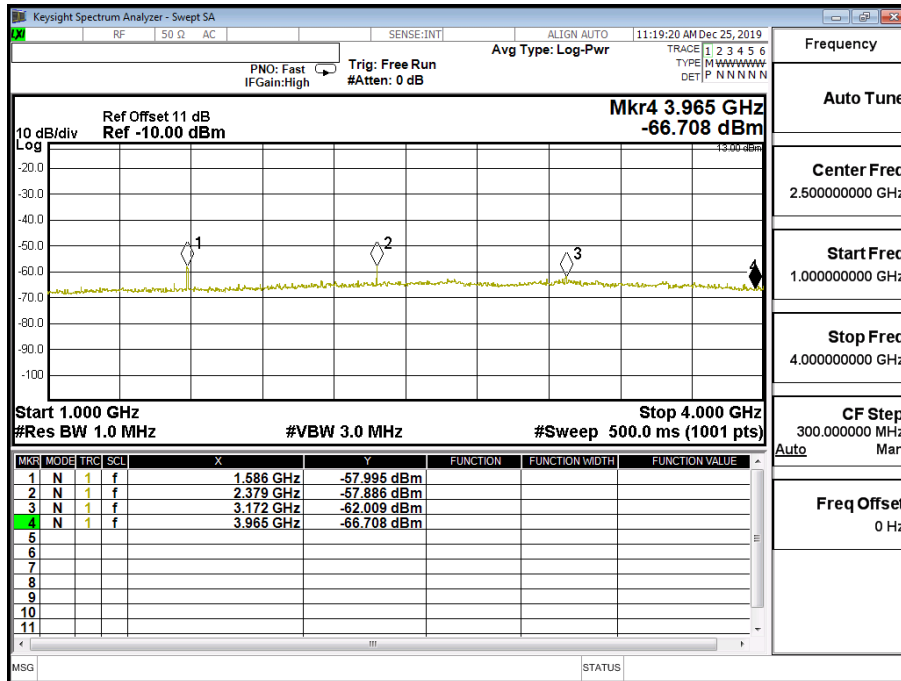

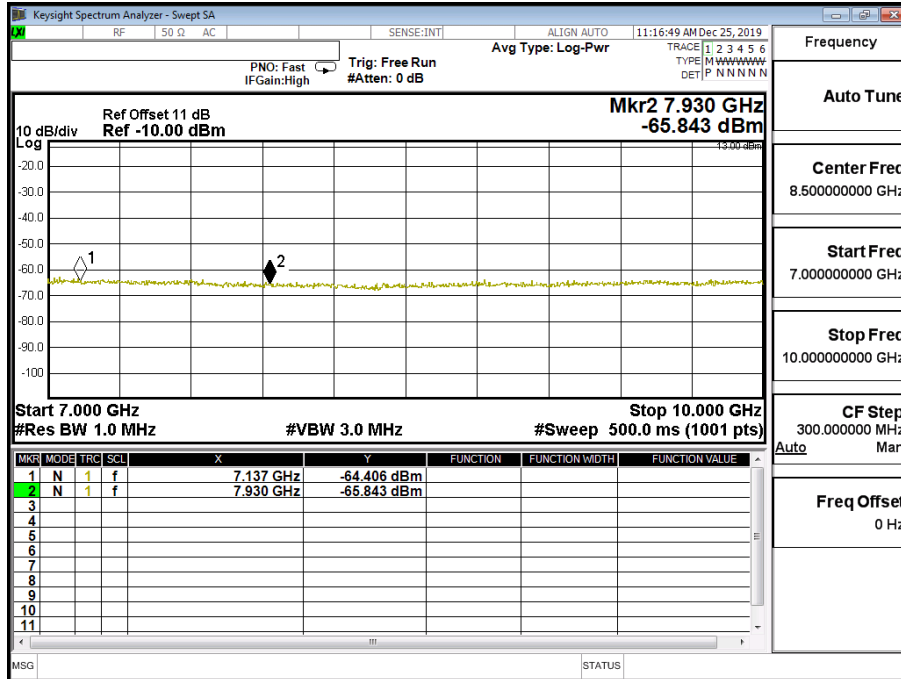

Product	Module		
Test Mode	Spurious Emission (Radiated)	Test Site	Site3
Date of Test	2019/12/26	Test Range	9KHz ~10GHz
Test Condition	Band 14 (5M) QPSK(1,12)	Environmental	22.4(°C) 54(%RH)

Frequency	Reading Level	Signal Generator Level	Cable Loss	Antenna Gain	EIRP Value	Limit
(GHz)	(dBm)	(dBm)	(dB)	(dBi)	(dBm)	(dBm)

Horizontal Emissions Band 14 (5M) QPSK (1,12) CH23305 (790.5MHz)

1582	-52.377	-56.70	1.630	9.800	-48.53	-40
2371	-59.169	-59.70	2.100	10.600	-51.20	-13
3163	-60.599	-61.57	2.350	12.300	-51.62	-13
3952	-60.059	-59.63	2.700	12.600	-49.73	-13
4744	-59.206	-55.69	2.830	12.700	-45.82	-13
5533	-58.864	-55.09	3.200	13.000	-45.29	-13

Vertical Emissions Band 14 (5M) QPSK (1,12) CH23305 (790.5MHz)

1579	-50.195	-53.98	1.630	9.800	-45.81	-40
2371	-60.489	-60.35	2.100	10.600	-51.85	-13
3163	-60.295	-60.35	2.350	12.300	-50.40	-13
3952	-60.137	-58.10	2.700	12.600	-48.20	-13
4744	-58.605	-54.32	2.830	12.700	-44.45	-13
5533	-59.231	-54.90	3.200	13.000	-45.10	-13

Note:

1. Receiver setting (Peak Detector) : RBW:1MHz; VBW:3MHz
2. EIRP Value = Signal Generator Level + Antenna Gain - Cable Loss
3. Spurious emissions past 6 GHz are not shown, due to the magnitude of spurious emissions attenuated more than 20 dB below the limit.

Product	Module		
Test Mode	Spurious Emission (Radiated)	Test Site	Site3
Date of Test	2019/12/26	Test Range	9KHz ~10GHz
Test Condition	Band 14 (5M) 16QAM(1,12)	Environmental	22.4(°C) 54(%RH)

Frequency	Reading Level	Signal Generator Level	Cable Loss	Antenna Gain	EIRP Value	Limit
(GHz)	(dBm)	(dBm)	(dB)	(dBi)	(dBm)	(dBm)

Horizontal Emissions Band 14 (5M) 16QAM (1,12) CH23305 (790.5MHz)

1579	-51.904	-56.26	1.630	9.800	-48.09	-40
2371	-58.649	-59.18	2.100	10.600	-50.68	-13
3163	-59.367	-60.34	2.350	12.300	-50.39	-13
3952	-60.298	-59.87	2.700	12.600	-49.97	-13
4744	-58.532	-55.02	2.830	12.700	-45.15	-13
5533	-59.119	-55.35	3.200	13.000	-45.55	-13

Vertical Emissions Band 14 (5M) 16QAM (1,12) CH23305 (790.5MHz)

1579	-50.680	-54.47	1.630	9.800	-46.30	-40
2371	-60.378	-60.24	2.100	10.600	-51.74	-13
3163	-60.287	-60.34	2.350	12.300	-50.39	-13
3952	-59.597	-57.57	2.700	12.600	-47.67	-13
4744	-58.741	-54.46	2.830	12.700	-44.59	-13
5533	-59.120	-54.79	3.200	13.000	-44.99	-13

Note:

1. Receiver setting (Peak Detector) : RBW:1MHz; VBW:3MHz
2. EIRP Value = Signal Generator Level + Antenna Gain - Cable Loss
3. Spurious emissions past 6 GHz are not shown, due to the magnitude of spurious emissions attenuated more than 20 dB below the limit.

Product	Module		
Test Mode	Spurious Emission (Radiated)	Test Site	Site3
Date of Test	2019/12/26	Test Range	9KHz ~10GHz
Test Condition	Band 14 (5M) QPSK(1,12)	Environmental	22.4(°C) 54(%RH)

Frequency	Reading Level	Signal Generator Level	Cable Loss	Antenna Gain	EIRP Value	Limit
(GHz)	(dBm)	(dBm)	(dB)	(dBi)	(dBm)	(dBm)

Horizontal Emissions Band 14 (5M) QPSK (1,12) CH23330 (793MHz)

1585	-52.068	-56.36	1.630	9.800	-48.19	-40
2380	-60.179	-60.78	2.100	10.600	-52.28	-13
3172	-60.385	-61.33	2.350	12.300	-51.38	-13
3964	-58.700	-58.11	2.700	12.600	-48.21	-13
4759	-59.107	-55.54	2.830	12.700	-45.67	-13
5551	-59.330	-55.70	3.200	13.000	-45.90	-13

Vertical Emissions Band 14 (5M) QPSK (1,12) CH23330 (793MHz)

1585	-50.129	-53.93	1.630	9.800	-45.76	-40
2380	-60.251	-60.20	2.100	10.600	-51.70	-13
3172	-60.048	-60.09	2.350	12.300	-50.14	-13
3964	-59.635	-57.56	2.700	12.600	-47.66	-13
4759	-58.459	-54.12	2.830	12.700	-44.25	-13
5551	-58.768	-54.54	3.200	13.000	-44.74	-13

Note:

1. Receiver setting (Peak Detector) : RBW:1MHz; VBW:3MHz
2. EIRP Value = Signal Generator Level + Antenna Gain - Cable Loss
3. Spurious emissions past 6 GHz are not shown, due to the magnitude of spurious emissions attenuated more than 20 dB below the limit.

Product	Module		
Test Mode	Spurious Emission (Radiated)	Test Site	Site3
Date of Test	2019/12/26	Test Range	9KHz ~10GHz
Test Condition	Band 14 (5M) 16QAM(1,12)	Environmental	22.4(°C) 54(%RH)

Frequency	Reading Level	Signal Generator Level	Cable Loss	Antenna Gain	EIRP Value	Limit
(GHz)	(dBm)	(dBm)	(dB)	(dBi)	(dBm)	(dBm)

Horizontal Emissions Band 14 (5M) QPSK (1,12) CH23330 (793MHz)

1585	-52.693	-56.98	1.630	9.800	-48.81	-40
2380	-60.825	-61.43	2.100	10.600	-52.93	-13
3172	-60.283	-61.23	2.350	12.300	-51.28	-13
3964	-59.944	-59.35	2.700	12.600	-49.45	-13
4759	-57.620	-54.06	2.830	12.700	-44.19	-13
5551	-58.464	-54.84	3.200	13.000	-45.04	-13

Vertical Emissions Band 14 (5M) QPSK (1,12) CH23330 (793MHz)

1585	-50.324	-54.13	1.630	9.800	-45.96	-40
2380	-60.455	-60.40	2.100	10.600	-51.90	-13
3172	-59.830	-59.87	2.350	12.300	-49.92	-13
3964	-58.919	-56.85	2.700	12.600	-46.95	-13
4759	-58.350	-54.02	2.830	12.700	-44.15	-13
5551	-59.237	-55.01	3.200	13.000	-45.21	-13

Note:

1. Receiver setting (Peak Detector) : RBW:1MHz; VBW:3MHz
2. EIRP Value = Signal Generator Level + Antenna Gain - Cable Loss
3. Spurious emissions past 6 GHz are not shown, due to the magnitude of spurious emissions attenuated more than 20 dB below the limit.

Product	Module		
Test Mode	Spurious Emission (Radiated)	Test Site	Site3
Date of Test	2019/12/26	Test Range	9KHz ~10GHz
Test Condition	Band 14 (5M) QPSK(1,12)	Environmental	22.4(°C) 54(%RH)

Frequency	Reading Level	Signal Generator Level	Cable Loss	Antenna Gain	EIRP Value	Limit
(GHz)	(dBm)	(dBm)	(dB)	(dBi)	(dBm)	(dBm)

Horizontal Emissions Band 14 (5M) QPSK (1,12) CH23355 (795.5MHz)

1591	-53.414	-57.63	1.630	9.800	-49.46	-40
2386	-58.194	-58.81	2.100	10.600	-50.31	-13
3181	-59.994	-60.94	2.350	12.300	-50.99	-13
3976	-59.349	-58.60	2.700	12.600	-48.70	-13
4774	-58.368	-54.76	2.830	12.700	-44.89	-13
5569	-58.822	-55.34	3.200	13.000	-45.54	-13

Vertical Emissions Band 14 (5M) QPSK (1,12) CH23355 (795.5MHz)

1591	-51.876	-55.69	1.630	9.800	-47.52	-40
2386	-60.639	-60.64	2.100	10.600	-52.14	-13
3181	-59.619	-59.65	2.350	12.300	-49.70	-13
3976	-59.542	-57.43	2.700	12.600	-47.53	-13
4774	-58.845	-54.46	2.830	12.700	-44.59	-13
5569	-59.863	-55.74	3.200	13.000	-45.94	-13

Note:

1. Receiver setting (Peak Detector) : RBW:1MHz; VBW:3MHz
2. EIRP Value = Signal Generator Level + Antenna Gain - Cable Loss
3. Spurious emissions past 6 GHz are not shown, due to the magnitude of spurious emissions attenuated more than 20 dB below the limit.

Product	Module		
Test Mode	Spurious Emission (Radiated)	Test Site	Site3
Date of Test	2019/12/26	Test Range	9KHz ~10GHz
Test Condition	Band 14 (5M) 16QAM(1,12)	Environmental	22.4(°C) 54(%RH)

Frequency	Reading Level	Signal Generator Level	Cable Loss	Antenna Gain	EIRP Value	Limit
(GHz)	(dBm)	(dBm)	(dB)	(dBi)	(dBm)	(dBm)

Horizontal Emissions Band 14 (5M) 16QAM (1,12) CH23355 (795.5MHz)

1591	-53.285	-57.51	1.630	9.800	-49.34	-40
2386	-58.725	-59.34	2.100	10.600	-50.84	-13
3181	-59.993	-60.94	2.350	12.300	-50.99	-13
3976	-59.507	-58.76	2.700	12.600	-48.86	-13
4774	-58.164	-54.55	2.830	12.700	-44.68	-13
5569	-58.647	-55.17	3.200	13.000	-45.37	-13

Vertical Emissions Band 14 (5M) 16QAM (1,12) CH23355 (795.5MHz)

1591	-52.681	-56.50	1.630	9.800	-48.33	-40
2386	-60.879	-60.88	2.100	10.600	-52.38	-13
3181	-59.652	-59.69	2.350	12.300	-49.74	-13
3976	-59.437	-57.32	2.700	12.600	-47.42	-13
4774	-58.163	-53.78	2.830	12.700	-43.91	-13
5569	-59.765	-55.64	3.200	13.000	-45.84	-13

Note:

1. Receiver setting (Peak Detector) : RBW:1MHz; VBW:3MHz
2. EIRP Value = Signal Generator Level + Antenna Gain - Cable Loss
3. Spurious emissions past 6 GHz are not shown, due to the magnitude of spurious emissions attenuated more than 20 dB below the limit.

Product	Module		
Test Mode	Spurious Emission (Radiated)	Test Site	Site3
Date of Test	2019/12/26	Test Range	9KHz ~10GHz
Test Condition	Band 14 (10M) QPSK(1,24)	Environmental	22.4(°C) 54(%RH)

Frequency	Reading Level	Signal Generator Level	Cable Loss	Antenna Gain	EIRP Value	Limit
(GHz)	(dBm)	(dBm)	(dB)	(dBi)	(dBm)	(dBm)

Horizontal Emissions Band 14 (10M) QPSK (1,24) CH23330 (793MHz)

1585	-51.882	-56.17	1.630	9.800	-48.00	-40
2380	-59.934	-60.54	2.100	10.600	-52.04	-13
3172	-60.075	-61.02	2.350	12.300	-51.07	-13
3964	-60.052	-59.46	2.700	12.600	-49.56	-13
4759	-58.349	-54.79	2.830	12.700	-44.92	-13
5551	-58.864	-55.24	3.200	13.000	-45.44	-13

Vertical Emissions Band 14 (10M) QPSK (1,24) CH23330 (793MHz)

1585	-50.215	-54.02	1.630	9.800	-45.85	-40
2380	-60.515	-60.46	2.100	10.600	-51.96	-13
3172	-60.399	-60.44	2.350	12.300	-50.49	-13
3964	-59.986	-57.91	2.700	12.600	-48.01	-13
4759	-57.834	-53.50	2.830	12.700	-43.63	-13
5551	-59.034	-54.80	3.200	13.000	-45.00	-13

Note:

1. Receiver setting (Peak Detector) : RBW:1MHz; VBW:3MHz
2. EIRP Value = Signal Generator Level + Antenna Gain - Cable Loss
3. Spurious emissions past 6 GHz are not shown, due to the magnitude of spurious emissions attenuated more than 20 dB below the limit.

Product	Module		
Test Mode	Spurious Emission (Radiated)	Test Site	Site3
Date of Test	2019/12/26	Test Range	9KHz ~10GHz
Test Condition	Band 14 (10M) 16QAM(1,24)	Environmental	22.4(°C) 54(%RH)

Frequency	Reading Level	Signal Generator Level	Cable Loss	Antenna Gain	EIRP Value	Limit
(GHz)	(dBm)	(dBm)	(dB)	(dBi)	(dBm)	(dBm)

Horizontal Emissions Band 14 (10M) 16QAM (1,24) CH23330 (793MHz)

1585	-52.273	-56.56	1.630	9.800	-48.39	-40
2380	-60.645	-61.25	2.100	10.600	-52.75	-13
3172	-60.395	-61.34	2.350	12.300	-51.39	-13
3964	-59.232	-58.64	2.700	12.600	-48.74	-13
4759	-57.841	-54.28	2.830	12.700	-44.41	-13
5551	-59.278	-55.65	3.200	13.000	-45.85	-13

Vertical Emissions Band 14 (10M) 16QAM (1,24) CH23330 (793MHz)

1585	-51.446	-55.25	1.630	9.800	-47.08	-40
2380	-60.968	-60.91	2.100	10.600	-52.41	-13
3172	-60.274	-60.32	2.350	12.300	-50.37	-13
3964	-59.582	-57.51	2.700	12.600	-47.61	-13
4759	-58.585	-54.25	2.830	12.700	-44.38	-13
5551	-58.535	-54.31	3.200	13.000	-44.51	-13

Note:

1. Receiver setting (Peak Detector) : RBW:1MHz; VBW:3MHz
2. EIRP Value = Signal Generator Level + Antenna Gain - Cable Loss
3. Spurious emissions past 6 GHz are not shown, due to the magnitude of spurious emissions attenuated more than 20 dB below the limit.

7. Frequency Stability Under Temperature & Voltage Variations

7.1. Test Specification

According to Part 2.1055, 90.213

7.2. Test Setup

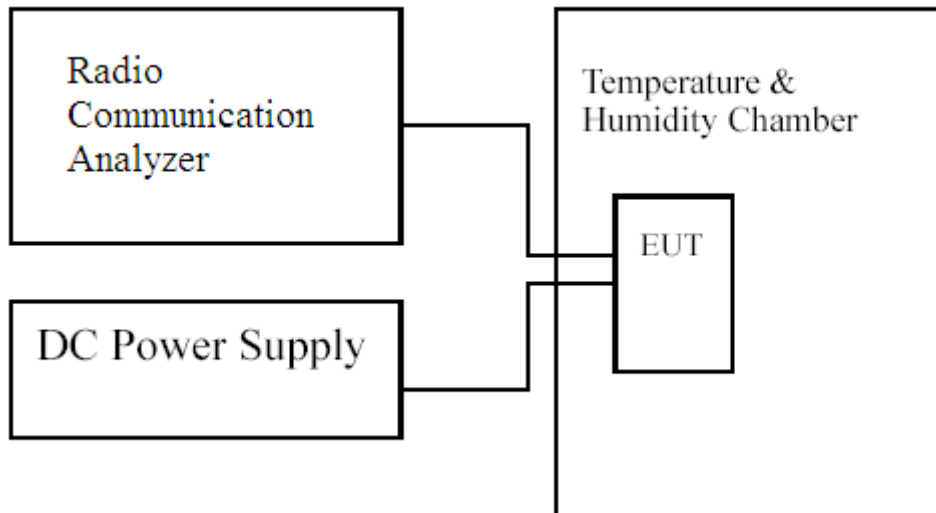

7.3. Limits

Limit	<±2.5ppm
--------------	--------------------

7.4. Test Procedure

The frequency stability of transmitter is measured by:

- (a) Temperature: The temperature is varied from -30 °C to 50 °C in 10 °C increment using a standard temperature & Humidity chamber.
- (b) Primary Supply Voltage: The primary supply voltage is varied 85% to 115% of the nominal value for non hand-carried equipment. For hand-carried, battery-powered equipment, primary supply voltage is reduced to the battery operating endpoint which shall be specified by the manufacturer.

The EUT was connected via the base station simulator. Universal Radio Communication Tester, (MT8820C), was used to measure The Frequency Error. The maximum result of measurements was recorded.

7.5. Test Result of Frequency Stability Under Temperature Variations

Product	Module		
Test Mode	Frequency Stability Under Temperature Variations & Voltage Variations		
Date of Test	2019/12/30	Test Site	CTR
Test Condition	Band 14 (5M) CH23305(790.5MHz) –QPSK	Test Range	-30°C~+50°C

Frequency Stability Under Temperature Variations

Temperature Interval(°C)	Test Frequency (GHz)	Deviation (kHz)	Limit (kHz)
-30	0.791	-0.0050	±1.98
-20	0.791	-0.0035	±1.98
-10	0.791	-0.0047	±1.98
0	0.791	-0.0053	±1.98
10	0.791	-0.0048	±1.98
20	0.791	-0.0051	±1.98
30	0.791	-0.0052	±1.98
40	0.791	-0.0053	±1.98
50	0.791	-0.0045	±1.98
55	0.791	-0.0046	±1.98

Voltage Variations

DC Voltage (V)	Test Frequency (GHz)	Deviation (kHz)	Limit (kHz)
4.3	0.791	-0.0047	±1.98
3.7	0.791	-0.0051	±1.98
3.2	0.791	-0.0049	±1.98

Product	Module		
Test Mode	Frequency Stability Under Temperature Variations & Voltage Variations		
Date of Test	2019/12/30	Test Site	CTR
Test Condition	Band 14 (5M) CH23305(790.5MHz) –16QAM	Test Range	-30°C ~+50°C

Frequency Stability Under Temperature Variations

Temperature Interval(°C)	Test Frequency (GHz)	Deviation (kHz)	Limit (kHz)
-30	0.791	-0.0039	±1.98
-20	0.791	-0.0044	±1.98
-10	0.791	-0.0046	±1.98
0	0.791	-0.0044	±1.98
10	0.791	-0.0043	±1.98
20	0.791	-0.0043	±1.98
30	0.791	-0.0057	±1.98
40	0.791	-0.0045	±1.98
50	0.791	-0.0042	±1.98
55	0.791	-0.0038	±1.98

Voltage Variations

DC Voltage (V)	Test Frequency (GHz)	Deviation (kHz)	Limit (kHz)
4.3	0.791	-0.0041	±1.98
3.7	0.791	-0.0043	±1.98
3.2	0.791	-0.0040	±1.98

Product	Module		
Test Mode	Frequency Stability Under Temperature Variations & Voltage Variations		
Date of Test	2019/12/30	Test Site	CTR
Test Condition	Band 14 (5M) CH23330(793MHz) –QPSK	Test Range	-30°C ~+50°C

Frequency Stability Under Temperature Variations

Temperature Interval(°C)	Test Frequency (GHz)	Deviation (kHz)	Limit (kHz)
-30	0.793	0.0042	±1.98
-20	0.793	0.0042	±1.98
-10	0.793	0.0044	±1.98
0	0.793	0.0042	±1.98
10	0.793	0.0045	±1.98
20	0.793	0.0046	±1.98
30	0.793	-0.0040	±1.98
40	0.793	0.0039	±1.98
50	0.793	0.0036	±1.98
55	0.793	0.0046	±1.98

Voltage Variations

DC Voltage (V)	Test Frequency (GHz)	Deviation (kHz)	Limit (kHz)
4.3	0.793	0.0042	±1.98
3.7	0.793	0.0046	±1.98
3.2	0.793	0.0036	±1.98

Product	Module		
Test Mode	Frequency Stability Under Temperature Variations & Voltage Variations		
Date of Test	2019/12/30	Test Site	CTR
Test Condition	Band 14 (5M) CH23330(793MHz) –16QAM	Test Range	-30°C ~+50°C

Frequency Stability Under Temperature Variations

Temperature Interval(°C)	Test Frequency (GHz)	Deviation (kHz)	Limit (kHz)
-30	0.793	0.0046	±1.98
-20	0.793	-0.0042	±1.98
-10	0.793	0.0047	±1.98
0	0.793	0.0046	±1.98
10	0.793	0.0038	±1.98
20	0.793	0.0044	±1.98
30	0.793	-0.0038	±1.98
40	0.793	-0.0045	±1.98
50	0.793	-0.0041	±1.98
55	0.793	0.0040	±1.98

Voltage Variations

DC Voltage (V)	Test Frequency (GHz)	Deviation (kHz)	Limit (kHz)
4.3	0.793	0.0040	±1.98
3.7	0.793	0.0044	±1.98
3.2	0.793	0.0059	±1.98

Product	Module		
Test Mode	Frequency Stability Under Temperature Variations & Voltage Variations		
Date of Test	2019/12/30	Test Site	CTR
Test Condition	Band 14 (5M) CH23355(795.5MHz) –QPSK	Test Range	-30°C ~+50°C

Frequency Stability Under Temperature Variations

Temperature Interval(°C)	Test Frequency (GHz)	Deviation (kHz)	Limit (kHz)
-30	0.796	0.0047	±1.99
-20	0.796	0.0044	±1.99
-10	0.796	0.0040	±1.99
0	0.796	0.0042	±1.99
10	0.796	0.0045	±1.99
20	0.796	0.0046	±1.99
30	0.796	0.0035	±1.99
40	0.796	-0.0038	±1.99
50	0.796	-0.0037	±1.99
55	0.796	0.0044	±1.99

Voltage Variations

DC Voltage (V)	Test Frequency (GHz)	Deviation (kHz)	Limit (kHz)
4.3	0.796	0.0041	±1.99
3.7	0.796	0.0046	±1.99
3.2	0.796	0.0042	±1.99

Product	Module		
Test Mode	Frequency Stability Under Temperature Variations & Voltage Variations		
Date of Test	2019/12/30	Test Site	CTR
Test Condition	Band 14 (5M) CH23355(795.5MHz) –16QAM	Test Range	-30°C ~+50°C

Frequency Stability Under Temperature Variations

Temperature Interval(°C)	Test Frequency (GHz)	Deviation (kHz)	Limit (kHz)
-30	0.796	0.0040	±1.99
-20	0.796	0.0037	±1.99
-10	0.796	0.0046	±1.99
0	0.796	0.0042	±1.99
10	0.796	0.0044	±1.99
20	0.796	0.0041	±1.99
30	0.796	0.0049	±1.99
40	0.796	-0.0040	±1.99
50	0.796	0.0043	±1.99
55	0.796	0.0048	±1.99

Voltage Variations

DC Voltage (V)	Test Frequency (GHz)	Deviation (kHz)	Limit (kHz)
4.3	0.796	0.0050	±1.99
3.7	0.796	0.0041	±1.99
3.2	0.796	0.0046	±1.99

Product	Module		
Test Mode	Frequency Stability Under Temperature Variations & Voltage Variations		
Date of Test	2019/12/30	Test Site	CTR
Test Condition	Band 14 (10M) CH23330(793MHz)-QPSK	Test Range	-30°C ~+50°C

Frequency Stability Under Temperature Variations

Temperature Interval(°C)	Test Frequency (GHz)	Deviation (kHz)	Limit (kHz)
-30	0.793	0.0049	±1.98
-20	0.793	0.0046	±1.98
-10	0.793	0.0048	±1.98
0	0.793	0.0044	±1.98
10	0.793	0.0059	±1.98
20	0.793	0.0042	±1.98
30	0.793	-0.0035	±1.98
40	0.793	-0.0049	±1.98
50	0.793	0.0040	±1.98
55	0.793	0.0039	±1.98

Voltage Variations

DC Voltage (V)	Test Frequency (GHz)	Deviation (kHz)	Limit (kHz)
4.3	0.793	0.0040	±1.98
3.7	0.793	0.0042	±1.98
3.2	0.793	0.0041	±1.98

Product	Module		
Test Mode	Frequency Stability Under Temperature Variations & Voltage Variations		
Date of Test	2019/12/30	Test Site	CTR
Test Condition	Band 14 (10M) CH23330(793MHz)-16QAM	Test Range	-30°C~+50°C

Frequency Stability Under Temperature Variations

Temperature Interval(°C)	Test Frequency (GHz)	Deviation (kHz)	Limit (kHz)
-30	0.793	0.0036	±1.98
-20	0.793	0.0036	±1.98
-10	0.793	0.0045	±1.98
0	0.793	0.0042	±1.98
10	0.793	-0.0038	±1.98
20	0.793	0.0038	±1.98
30	0.793	-0.0038	±1.98
40	0.793	-0.0036	±1.98
50	0.793	0.0036	±1.98
55	0.793	0.0035	±1.98

Voltage Variations

DC Voltage (V)	Test Frequency (GHz)	Deviation (kHz)	Limit (kHz)
4.3	0.793	0.0033	±1.98
3.7	0.793	0.0038	±1.98
3.2	0.793	0.0037	±1.98

8. Peak to Average Ratio

8.1 Test Specification

According to Part 90.1215

8.2 Test Setup

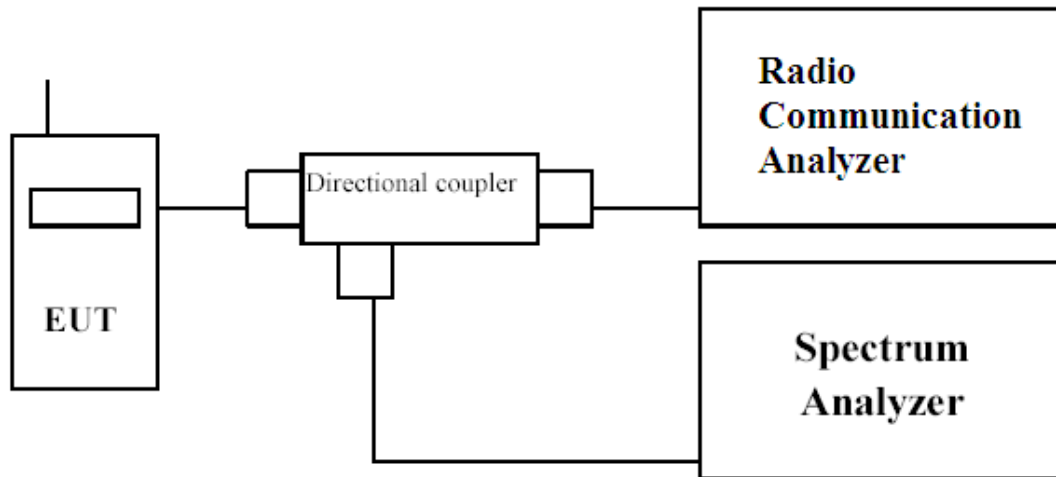

8.3 Limits

The peak-to-average power ratio (PAPR) of the transmitter output power must not exceed 13 dB. The PAPR measurements should be made using either an instrument with complementary cumulative distribution function (CCDF) capabilities to determine that PAPR will not exceed 13 dB for more than 0.1 percent of the time or other Commission approved procedure.

8.4 Test Procedure

- a) Refer to instrument's analyzer instruction manual for details on how to use the power statistics/CCDF function;
- b) Set resolution/measurement bandwidth \geq signal's occupied bandwidth;
- c) Set the number of counts to a value that stabilizes the measured CCDF curve;
- d) Set the measurement interval as follows:
 - 1) for continuous transmissions, set to 1 ms,
 - 2) for burst transmissions, employ an external trigger that is synchronized with the EUT burst timing sequence, or use the internal burst trigger with a trigger level that allows the burst to stabilize and set the measurement interval to a time that is less than or equal to the burst duration.
- e) Record the maximum PAPR level associated with a probability of 0.1%.

8.5 Test Result of Spurious Emission

Product	Module		
Test Mode	Peak to Average Ratio		
Date of Test	2019/12/30	Test Site	CTR
Test Condition	LTE-Band 14	Environmental	23.2(°C) 51(%RH)

Band 14 5M QPSK - LTE Mode CH 23305 (790.5MHz)

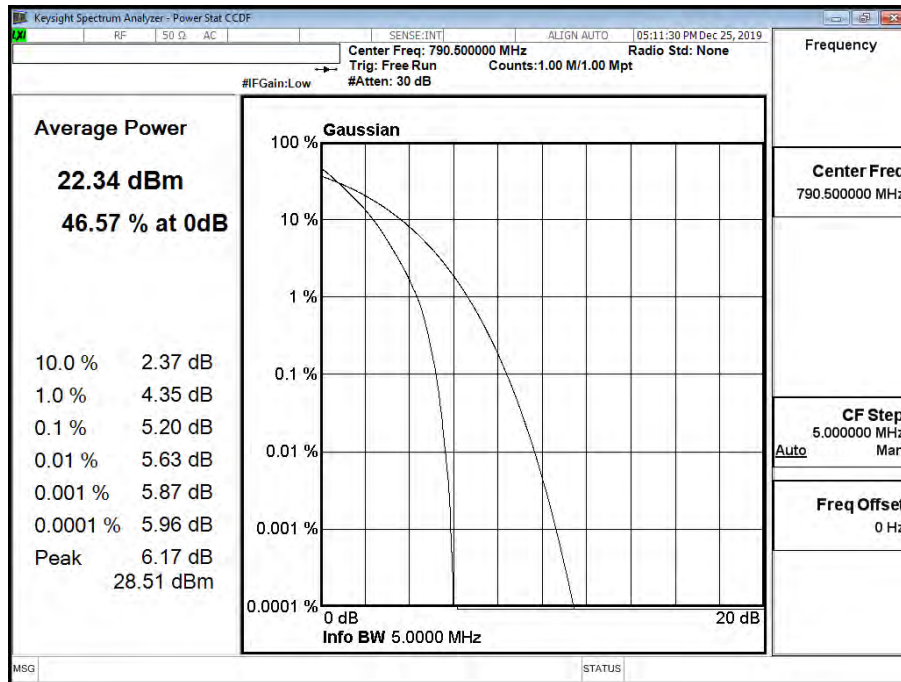

Band 14 5M QPSK - LTE Mode CH 23330 (793MHz)

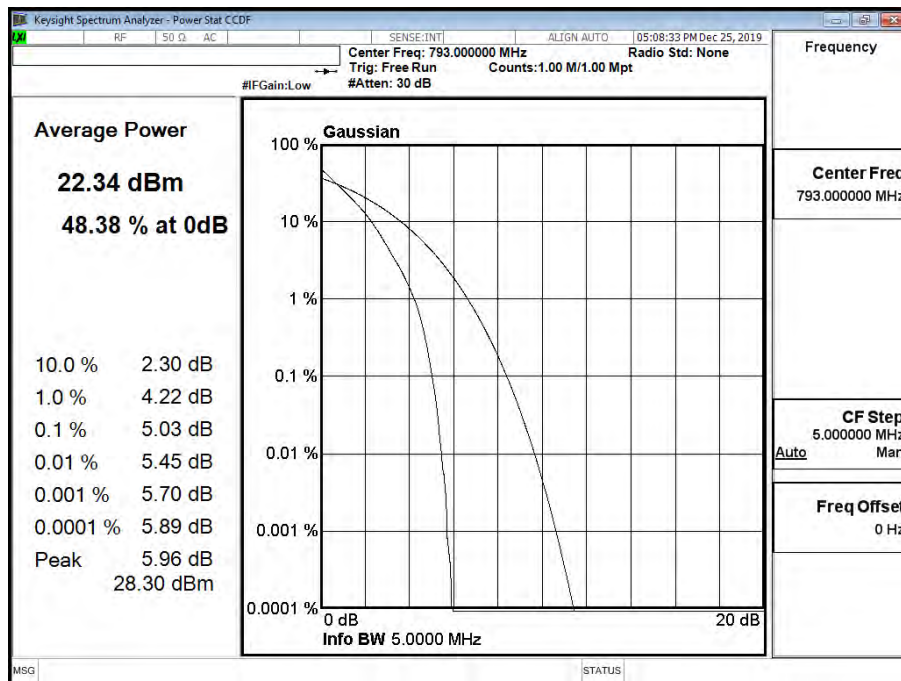

Band 14 5M QPSK - LTE Mode CH 23355 (795.5MHz)

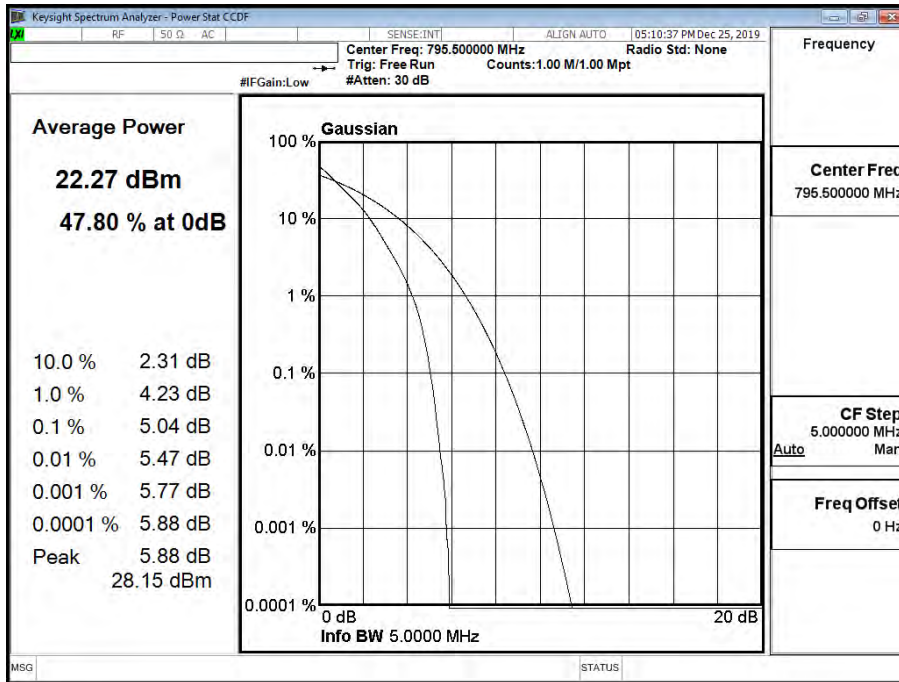

Band 14 10M QPSK - LTE Mode CH 23330 (793MHz)

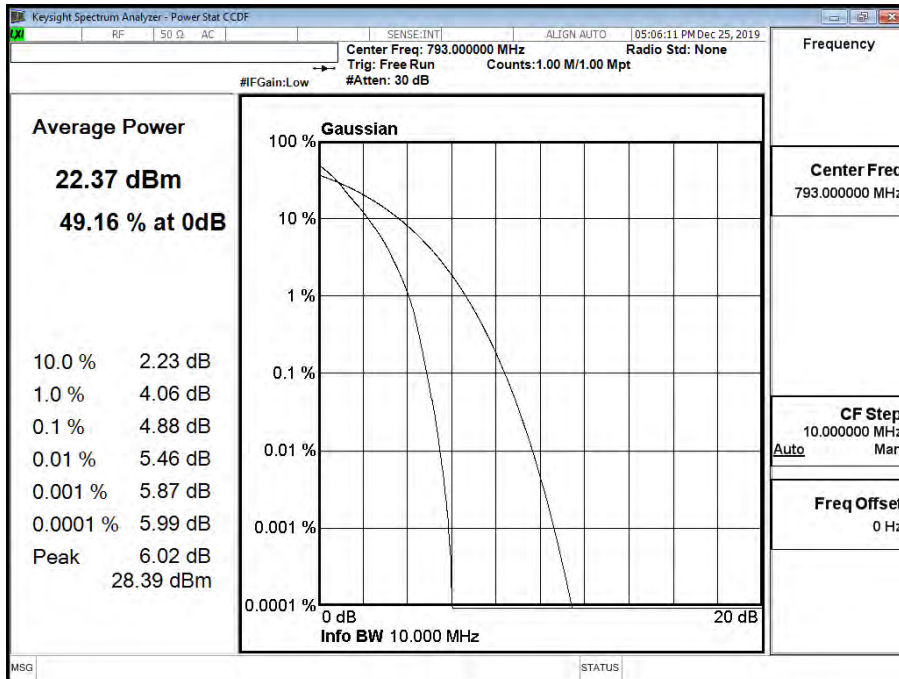

Band 14 5M 16QAM - LTE Mode CH 23305 (790.5MHz)

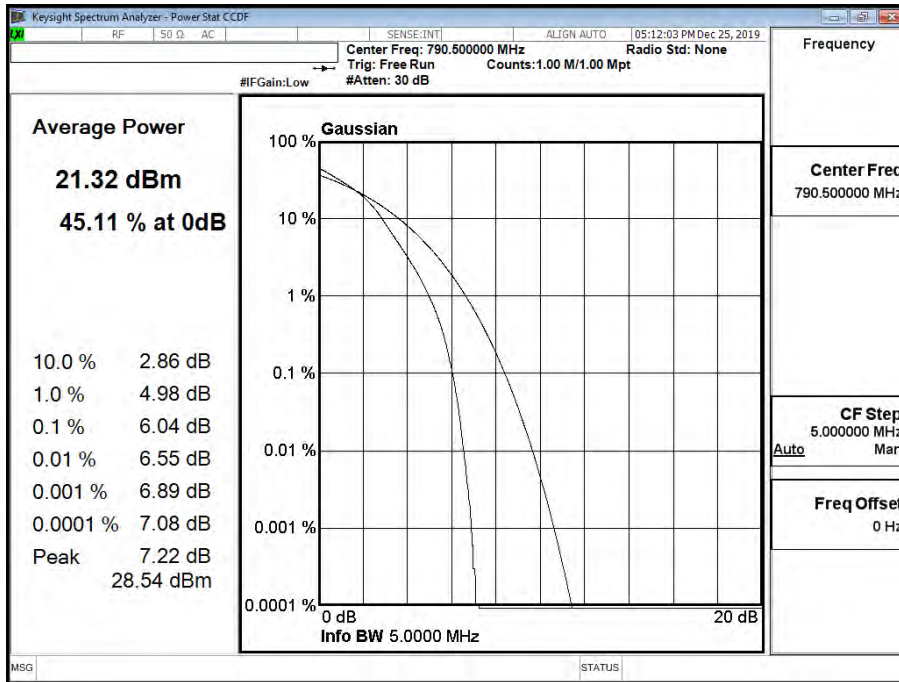

Band 14 5M 16QAM - LTE Mode CH 23330 (793MHz)

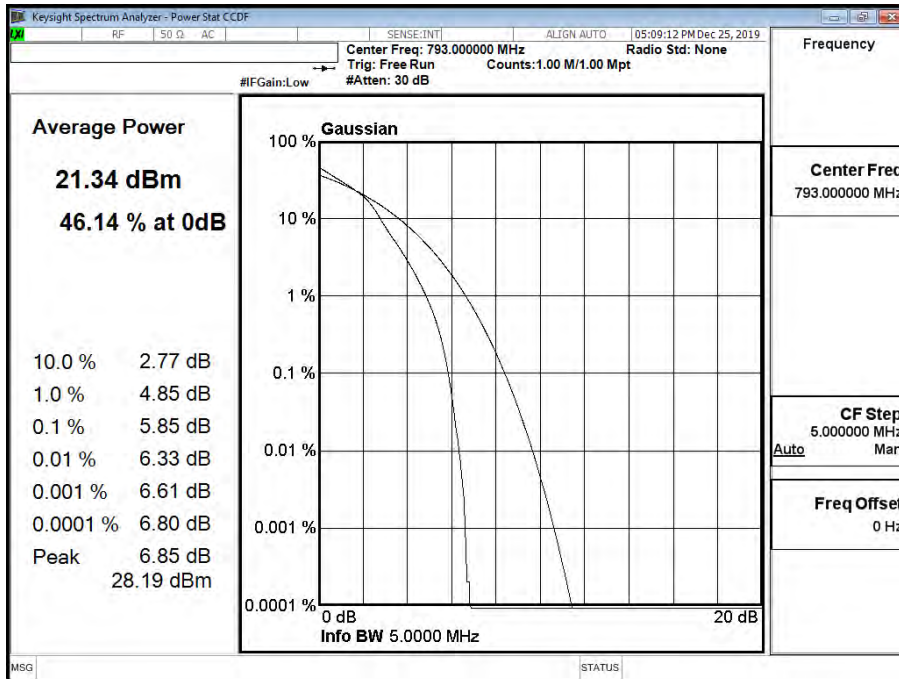

Band 14 5M 16QAM - LTE Mode CH 23355 (795.5MHz)

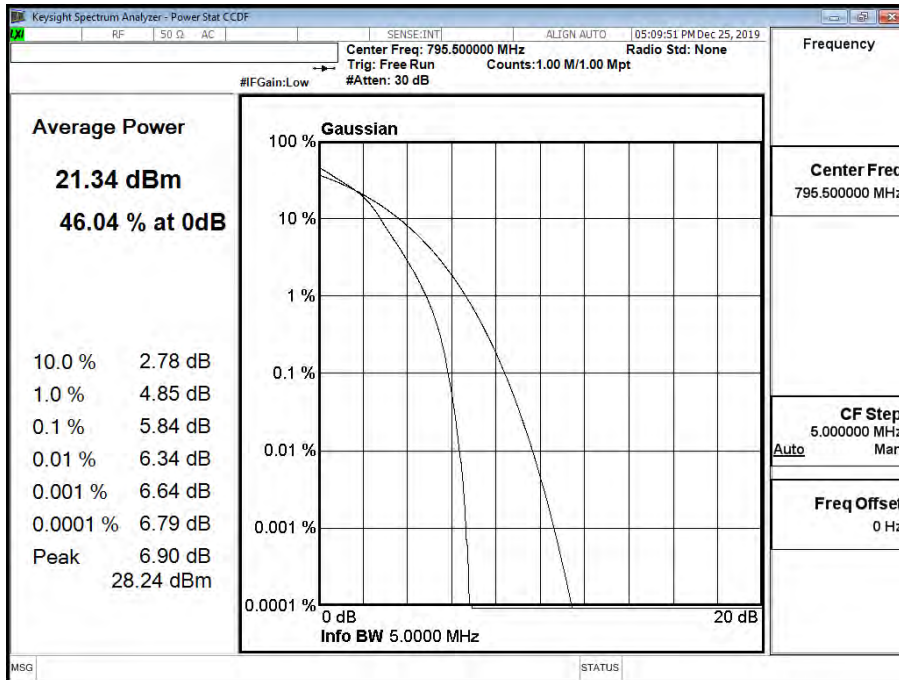

Band 14 10M 16QAM - LTE Mode CH 23330 (793MHz)

