



Material or Methods Specification

Number: PMAN5101A
Issue: A
Date: October 2, 2018

TITLE: APX8500-HP 2.4/5 GHz Covert Glass-Mount BT/WIFI ANTENNA Page 1 of 26

| ISSUE | ORIGINATOR | DETAIL SPEC CHANGES | DATE |
|-------|---|---------------------|-----------------|
| A | HAMMEL, BRANDON; MEHDI MEHRSA; GRADA, SAMUEL; KUPPUSAMY, ANBUSELVAN | PRODUCTION RELEASE | October 2, 2018 |

The information contained in this document is proprietary to Motorola Solutions and shall not be reproduced or used in whole or in part without Motorola Solutions written consent.



Material or Methods Specification

**Number: PMAN5101A
Issue: A
Date: October 2, 2018**

TITLE: APX8500-HP 2.4/5 GHz Covert Glass-Mount BT/WIFI ANTENNA Page 2 of 26

TABLE OF CONTENTS

1. SCOPE..... 3

2. APPLICABLE DOCUMENTS..... 3

3. REQUIREMENTS..... 3

 3.1 GENERAL AND ENVIRONMENTAL 3

4. EXCEPTIONS AND WAIVERS..... 6

5. ANTENNA DIAGRAM 6

6. TYPICAL VSWR FOR REFERENCE 9

7. TYPICAL PEAK GAIN FOR REFERENCE 12

8. TYPICAL EFFICIENCY FOR REFERENCE..... 16

9. TYPICAL RADIATION PATTERNS..... 20

10. OTHER ANTENNA PARAMETERS..... 26

The information contained in this document is proprietary to Motorola Solutions and shall not be reproduced or used in whole or in part without Motorola Solutions written consent.



Material or Methods Specification

Number: PMAN5101A
Issue: A
Date: October 2, 2018

TITLE: APX8500-HP 2.4/5 GHz Covert Glass-Mount BT/WIFI ANTENNA Page 3 of 26

1. SCOPE

This document contains specifications pertinent to the AXP8500-HP 2.4/5 GHz Covert Glass-Mount BT/WIFI antenna for use in mobile radios. It includes General, Mechanical and Electrical Requirements, VQA/Final tests, and Qualification tests.

2. APPLICABLE DOCUMENTS

| | |
|-------------|--|
| 12M02897W18 | Controlled and Reportable Materials Disclosure |
| 12M05022A87 | Motorola Quality Procedure Outsourced Assembled Kits |
| 12M05041A30 | Motorola Barcode and Label Applications Standard |
| 12M80967A78 | Motorola Vendor Material Quality Control |
| 12S10601A | Motorola Packaging Rules for Vendors |
| 12S10616A | Motorola Marking and Containers for Consumer Products Division |
| 12G13933A01 | Motorola Receiving Bar Code Specification for Vendors |

3. REQUIREMENTS

3.1 General

Manufacturer needs to report any change in process/ material that would affect the electrical/ mechanical performance of the antenna.

| 2.4 GHz Covert Glass-Mount BT/WIFI ANTENNA DEFINED IN THIS DOCUMENT | |
|---|--|
| Part Number | Description |
| PMAN5101A | 2.4/5 GHz Covert Glass-Mount BT/WIFI Antenna with 17ft Cable and QMA Connector |

3.1.1 Application: This antenna is used with vehicle mount mobile radios.

The information contained in this document is proprietary to Motorola Solutions and shall not be reproduced or used in whole or in part without Motorola Solutions written consent.



Material or Methods Specification

Number: PMAN5101A
Issue: A
Date: October 2, 2018

TITLE: APX8500-HP 2.4/5 GHz Covert Glass-Mount BT/WIFI ANTENNA Page 4 of 26

3.1.2 Mechanical Requirements: Table 1. See Antenna diagram on page 6.

| Part Number | Description | WIFI Antenna Cable | Install Manual |
|-------------|---|---|--|
| PMAN5101A | 2.4/5 GHz BT/WIFI Glass Mount for vehicle installations | PVC Free RG316 FEP 1ft and PFP-195 16ft with QMA Plug (QMA Plug: Amphenol 134104 or Motorola Approved Equivalent) | Install Manual for Wi-Fi Glass Mount PMLN7726B |

Table 1: Mechanical Requirements

3.1.2 Mechanical:

Random Vibration Test: Per MIL-STD-810E, Method 514.4, Procedure I-3.3

Temperature Cycle Test: In temperature/humidity chamber and perform 5 contiguous cycles of the following temperature cycle:

- Begin test at room temperature (+23°C).
- Ramp up to 70°C in 94 + 15/-0 minutes (0.5°C/min).
- Soak at 70°C for 60 +30/-0 minutes.
- Ramp down to -40°C in 220 + 15 minutes/-0 (0.5°C/min).
- Soak at -40°C for 60 +30/-0 minutes.
- Ramp back to room temperature in 126 + 15 minutes/-0 (0.5°C/min).

Humidity Cycle Test: In temperature/humidity chamber and perform the following 24-hour temperature/humidity profile:

- Begin test at 25°C/50% relative humidity.
- Ramp temperature to 40°C + 5°C and relative humidity to 95% + 5% in 3 hours + 30 minutes/-0.

The information contained in this document is proprietary to Motorola Solutions and shall not be reproduced or used in whole or in part without Motorola Solutions written consent.



Material or Methods Specification

Number: PMAN5101A
Issue: A
Date: October 2, 2018

TITLE: APX8500-HP 2.4/5 GHz Covert Glass-Mount BT/WIFI ANTENNA Page 5 of 26

- c. Hold at 40°C + 5°C and 95% + 5% relative humidity for 6 hours + 30 minutes/-0.
- d. Ramp temperature to 25°C + 5°C and relative humidity to 80% + 5% in 3 hours + 30 minutes/-0.
- e. Ramp relative humidity to 95% + 5% while maintaining temperature at 25°C + 5°C in 3 hours + 30 minutes/-0.
- f. Soak at 25°C + 5°C and 95% + 5% relative humidity for 6 hours.
- g. Ramp temperature to 40°C + 5°C while maintaining relative humidity at 95% + 5% in 3 hours + 30 minutes/-0.
- h. Repeat steps c through g for a total of 6 cycles.

Salt Spray (Fog) Test: Per MIL-STD-810E, Procedure I, Method 509.3

3.1.3 Electrical Requirements:

Table 2: BT/WLAN Specifications

| Motorola P/N | Freq Range (GHz) | Nominal Impedance (Ohms) | Max. Power (Watts) | Nominal Peak Gain (dBi) | Nominal VSWR (over 90 %BW) | MAX. VSWR | Minimum Efficiency (%) |
|--------------|--------------------------|--------------------------|--------------------|---|--|--|------------------------------------|
| PMAN5101A | 2.30- 2.50 4.90– 5.90 | 50 50 | 1 1 | 1.7 – 2.7 ¹ -3.6 – 0.2 ¹ | < 1.65:1 ¹ < 1.35:1 ¹ | < 2:1 ¹ < 2:1 ¹ | 30 ¹ 15 ¹ |

¹ Note: Measured in an anechoic setup/ open space with no interference. The antenna cable was cut to 1-foot length and terminated with SMA Male connector. A 16-foot PFP-195 cable assembly was attached to the antenna pigtail and terminated with Male QMA. The antenna was mounted on a 12 W x 5 H x .25 T - inch glass pane bordered with a metal rim (right side border of the pane).

The information contained in this document is proprietary to Motorola Solutions and shall not be reproduced or used in whole or in part without Motorola Solutions written consent.



Material or Methods Specification

Number: PMAN5101A
Issue: A
Date: October 2, 2018

TITLE: APX8500-HP 2.4/5 GHz Covert Glass-Mount BT/WIFI ANTENNA Page 6 of 26

4. EXCEPTIONS AND WAIVERS

No change shall be allowed on production material, regardless of whether such change affects requirements specified, without prior explicit written permission of Motorola Development Engineering and Purchasing departments.

5. ANTENNA DIAGRAM

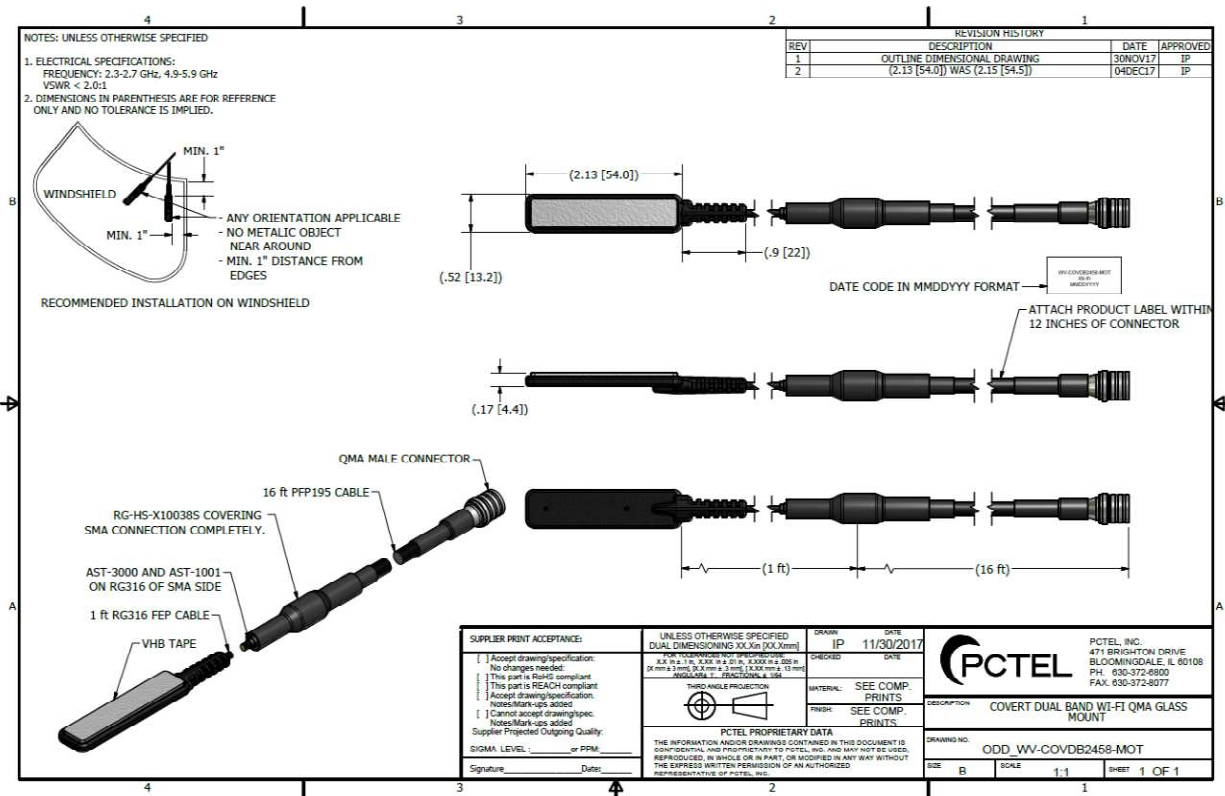

Figure 1A - Spec

The information contained in this document is proprietary to Motorola Solutions and shall not be reproduced or used in whole or in part without Motorola Solutions written consent.



Material or Methods Specification

Number: PMAN5101A
Issue: A
Date: October 2, 2018

TITLE: APX8500-HP 2.4/5 GHz Covert Glass-Mount BT/WIFI ANTENNA Page 7 of 26

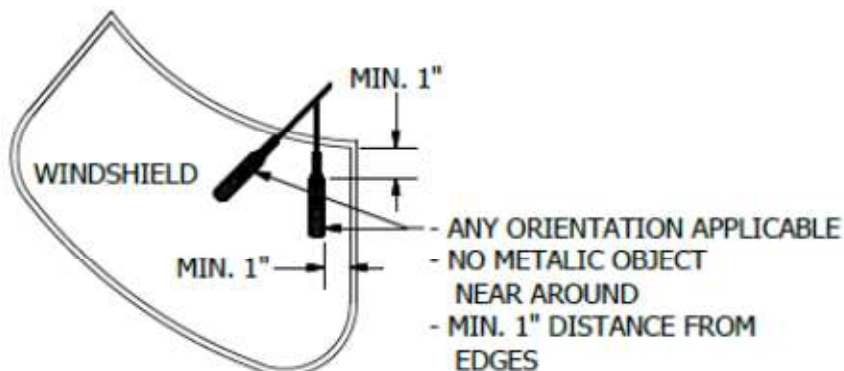

RECOMMENDED INSTALLATION ON WINDSHIELD

Figure 1B – Windshield Installation Diagram

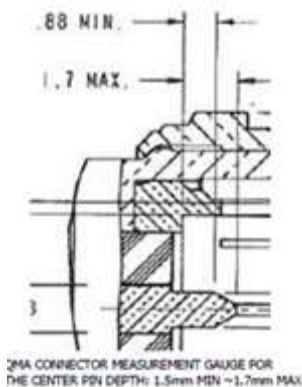

Figure 1C – Tolerance of QMA center pin

PMAN5101A
Note: Dimensions in Millimeters

The information contained in this document is proprietary to Motorola Solutions and shall not be reproduced or used in whole or in part without Motorola Solutions written consent.



Material or Methods Specification

Number: PMAN5101A
Issue: A
Date: October 2, 2018

TITLE: APX8500-HP 2.4/5 GHz Covert Glass-Mount BT/WIFI ANTENNA Page 8 of 26

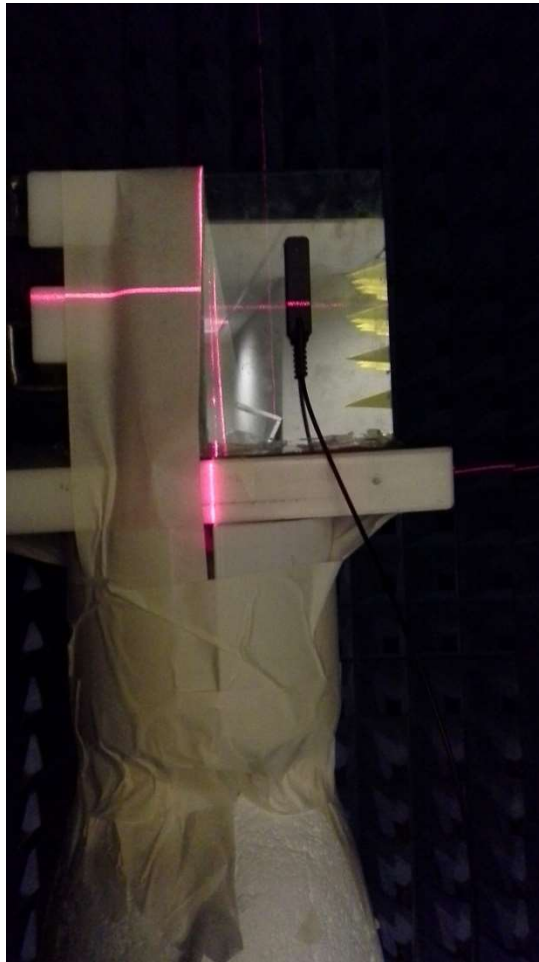

Figure 1D – Antenna picture in the test chamber

6. TYPICAL VSWR FOR REFERENCE

The information contained in this document is proprietary to Motorola Solutions and shall not be reproduced or used in whole or in part without Motorola Solutions written consent.



Material or Methods Specification

Number: PMAN5101A
Issue: A
Date: October 2, 2018

TITLE: APX8500-HP 2.4/5 GHz Covert Glass-Mount BT/WIFI ANTENNA Page 9 of 26

Measured in an anechoic setup/ open space with no interference. The antenna cable was cut to 1-foot length and terminated with SMA Male connector. A 16-foot PFP-195 cable assembly was attached to the antenna pigtail and terminated with Male QMA. The antenna was mounted on a 12 W x 5 H x .25- inch glass pane bordered with a metal rim (right side border of the pane).

(Mounted as shown in Fig 1B, With RG316 FEP 1ft and PFP-195 16ft cable)

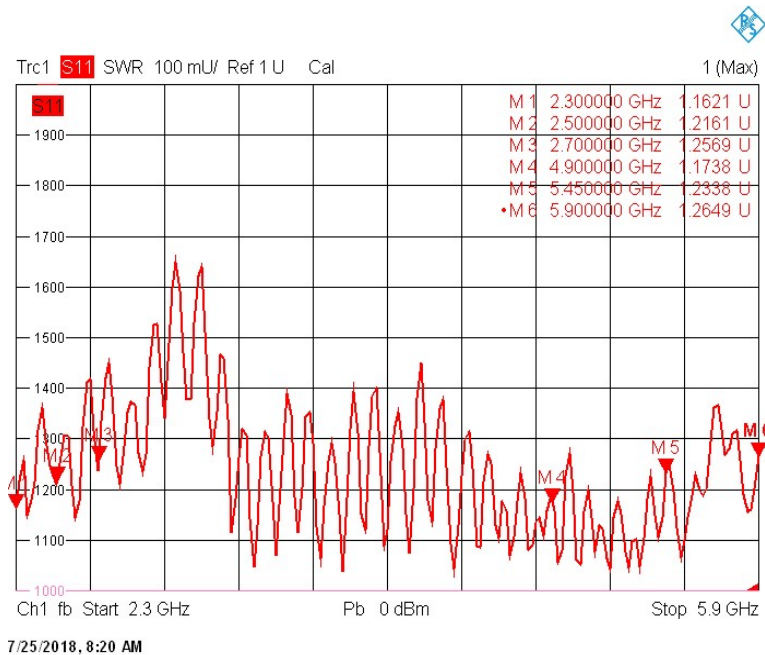

The information contained in this document is proprietary to Motorola Solutions and shall not be reproduced or used in whole or in part without Motorola Solutions written consent.



Material or Methods Specification

Number: PMAN5101A
Issue: A
Date: October 2, 2018

TITLE: APX8500-HP 2.4/5 GHz Covert Glass-Mount BT/WIFI ANTENNA Page 10 of 26

| freq[Hz] | VSWR | freq[Hz] | VSWR | freq[Hz] | VSWR | freq[Hz] | VSWR |
|----------|------|----------|------|----------|------|----------|------|
| 2.30E+09 | 1.16 | 3.20E+09 | 1.64 | 4.10E+09 | 1.12 | 5.00E+09 | 1.19 |
| 2.32E+09 | 1.22 | 3.22E+09 | 1.51 | 4.12E+09 | 1.26 | 5.02E+09 | 1.06 |
| 2.34E+09 | 1.26 | 3.24E+09 | 1.34 | 4.14E+09 | 1.33 | 5.04E+09 | 1.05 |
| 2.35E+09 | 1.15 | 3.25E+09 | 1.28 | 4.15E+09 | 1.35 | 5.05E+09 | 1.16 |
| 2.37E+09 | 1.18 | 3.27E+09 | 1.35 | 4.17E+09 | 1.28 | 5.07E+09 | 1.20 |
| 2.39E+09 | 1.21 | 3.29E+09 | 1.47 | 4.19E+09 | 1.15 | 5.09E+09 | 1.14 |
| 2.41E+09 | 1.32 | 3.31E+09 | 1.46 | 4.21E+09 | 1.07 | 5.11E+09 | 1.08 |
| 2.43E+09 | 1.36 | 3.33E+09 | 1.34 | 4.23E+09 | 1.20 | 5.13E+09 | 1.13 |
| 2.44E+09 | 1.30 | 3.34E+09 | 1.11 | 4.24E+09 | 1.38 | 5.14E+09 | 1.12 |
| 2.46E+09 | 1.25 | 3.36E+09 | 1.18 | 4.26E+09 | 1.45 | 5.16E+09 | 1.06 |
| 2.48E+09 | 1.23 | 3.38E+09 | 1.26 | 4.28E+09 | 1.33 | 5.18E+09 | 1.04 |
| 2.50E+09 | 1.21 | 3.40E+09 | 1.32 | 4.30E+09 | 1.18 | 5.20E+09 | 1.14 |
| 2.52E+09 | 1.26 | 3.42E+09 | 1.31 | 4.32E+09 | 1.14 | 5.22E+09 | 1.18 |
| 2.53E+09 | 1.31 | 3.43E+09 | 1.14 | 4.33E+09 | 1.28 | 5.23E+09 | 1.15 |
| 2.55E+09 | 1.31 | 3.45E+09 | 1.05 | 4.35E+09 | 1.36 | 5.25E+09 | 1.08 |
| 2.57E+09 | 1.21 | 3.47E+09 | 1.13 | 4.37E+09 | 1.38 | 5.27E+09 | 1.04 |
| 2.59E+09 | 1.14 | 3.49E+09 | 1.27 | 4.39E+09 | 1.24 | 5.29E+09 | 1.10 |
| 2.61E+09 | 1.18 | 3.51E+09 | 1.31 | 4.41E+09 | 1.09 | 5.31E+09 | 1.10 |
| 2.62E+09 | 1.32 | 3.52E+09 | 1.30 | 4.42E+09 | 1.04 | 5.32E+09 | 1.05 |
| 2.64E+09 | 1.41 | 3.54E+09 | 1.18 | 4.44E+09 | 1.13 | 5.34E+09 | 1.11 |
| 2.66E+09 | 1.42 | 3.56E+09 | 1.07 | 4.46E+09 | 1.23 | 5.36E+09 | 1.18 |
| 2.68E+09 | 1.32 | 3.58E+09 | 1.17 | 4.48E+09 | 1.30 | 5.38E+09 | 1.23 |
| 2.70E+09 | 1.23 | 3.60E+09 | 1.30 | 4.50E+09 | 1.31 | 5.40E+09 | 1.15 |
| 2.71E+09 | 1.33 | 3.61E+09 | 1.39 | 4.51E+09 | 1.24 | 5.41E+09 | 1.11 |
| 2.73E+09 | 1.42 | 3.63E+09 | 1.35 | 4.53E+09 | 1.09 | 5.43E+09 | 1.14 |
| 2.75E+09 | 1.45 | 3.65E+09 | 1.19 | 4.55E+09 | 1.09 | 5.45E+09 | 1.23 |
| 2.77E+09 | 1.39 | 3.67E+09 | 1.11 | 4.57E+09 | 1.21 | 5.47E+09 | 1.25 |
| 2.79E+09 | 1.25 | 3.69E+09 | 1.20 | 4.59E+09 | 1.27 | 5.49E+09 | 1.20 |

The information contained in this document is proprietary to Motorola Solutions and shall not be reproduced or used in whole or in part without Motorola Solutions written consent.



Material or Methods Specification

Number: PMAN5101A
Issue: A
Date: October 2, 2018

TITLE: APX8500-HP 2.4/5 GHz Covert Glass-Mount BT/WIFI ANTENNA Page 11 of 26

| | | | | | | | |
|----------|------|----------|------|----------|------|----------|------|
| 2.80E+09 | 1.21 | 3.70E+09 | 1.34 | 4.60E+09 | 1.25 | 5.50E+09 | 1.12 |
| 2.82E+09 | 1.29 | 3.72E+09 | 1.35 | 4.62E+09 | 1.13 | 5.52E+09 | 1.06 |
| 2.84E+09 | 1.35 | 3.74E+09 | 1.29 | 4.64E+09 | 1.10 | 5.54E+09 | 1.10 |
| 2.86E+09 | 1.37 | 3.76E+09 | 1.13 | 4.66E+09 | 1.18 | 5.56E+09 | 1.15 |
| 2.88E+09 | 1.37 | 3.78E+09 | 1.06 | 4.68E+09 | 1.16 | 5.58E+09 | 1.19 |
| 2.89E+09 | 1.27 | 3.79E+09 | 1.17 | 4.69E+09 | 1.07 | 5.59E+09 | 1.23 |
| 2.91E+09 | 1.24 | 3.81E+09 | 1.26 | 4.71E+09 | 1.11 | 5.61E+09 | 1.20 |
| 2.93E+09 | 1.27 | 3.83E+09 | 1.29 | 4.73E+09 | 1.18 | 5.63E+09 | 1.19 |
| 2.95E+09 | 1.44 | 3.85E+09 | 1.25 | 4.75E+09 | 1.23 | 5.65E+09 | 1.20 |
| 2.97E+09 | 1.52 | 3.87E+09 | 1.15 | 4.77E+09 | 1.18 | 5.67E+09 | 1.29 |
| 2.98E+09 | 1.53 | 3.88E+09 | 1.04 | 4.78E+09 | 1.08 | 5.68E+09 | 1.36 |
| 3.00E+09 | 1.41 | 3.90E+09 | 1.18 | 4.80E+09 | 1.09 | 5.70E+09 | 1.37 |
| 3.02E+09 | 1.34 | 3.92E+09 | 1.32 | 4.82E+09 | 1.13 | 5.72E+09 | 1.32 |
| 3.04E+09 | 1.45 | 3.94E+09 | 1.39 | 4.84E+09 | 1.15 | 5.74E+09 | 1.27 |
| 3.06E+09 | 1.60 | 3.96E+09 | 1.31 | 4.86E+09 | 1.11 | 5.76E+09 | 1.28 |
| 3.07E+09 | 1.65 | 3.97E+09 | 1.15 | 4.87E+09 | 1.16 | 5.77E+09 | 1.31 |
| 3.09E+09 | 1.59 | 3.99E+09 | 1.12 | 4.89E+09 | 1.19 | 5.79E+09 | 1.32 |
| 3.11E+09 | 1.47 | 4.01E+09 | 1.28 | 4.91E+09 | 1.16 | 5.81E+09 | 1.26 |
| 3.13E+09 | 1.38 | 4.03E+09 | 1.38 | 4.93E+09 | 1.06 | 5.83E+09 | 1.19 |
| 3.15E+09 | 1.38 | 4.05E+09 | 1.40 | 4.95E+09 | 1.08 | 5.85E+09 | 1.16 |
| 3.16E+09 | 1.53 | 4.06E+09 | 1.27 | 4.96E+09 | 1.23 | 5.86E+09 | 1.16 |
| 3.18E+09 | 1.62 | 4.08E+09 | 1.09 | 4.98E+09 | 1.27 | 5.88E+09 | 1.22 |

The information contained in this document is proprietary to Motorola Solutions and shall not be reproduced or used in whole or in part without Motorola Solutions written consent.



Material or Methods Specification

Number: PMAN5101A
Issue: A
Date: October 2, 2018

TITLE: APX8500-HP 2.4/5 GHz Covert Glass-Mount BT/WIFI ANTENNA Page 12 of 26

7. TYPICAL PEAK GAIN FOR REFERENCE

(Mounted as shown in Fig 1B, With RG316 FEP 1ft and PFP-195 16ft cable)

Measured in an anechoic setup/ open space with no interference. The antenna cable was cut to 1-foot length and terminated with SMA Male connector. A 16-foot PFP-195 cable assembly was attached to the antenna pigtail and terminated with Male QMA. The antenna was mounted on a 12 W x 5 H x .25- inch glass pane bordered with a metal rim (right side border of the pane).

Peak Gain (dBi), WIFI 2.4 GHz

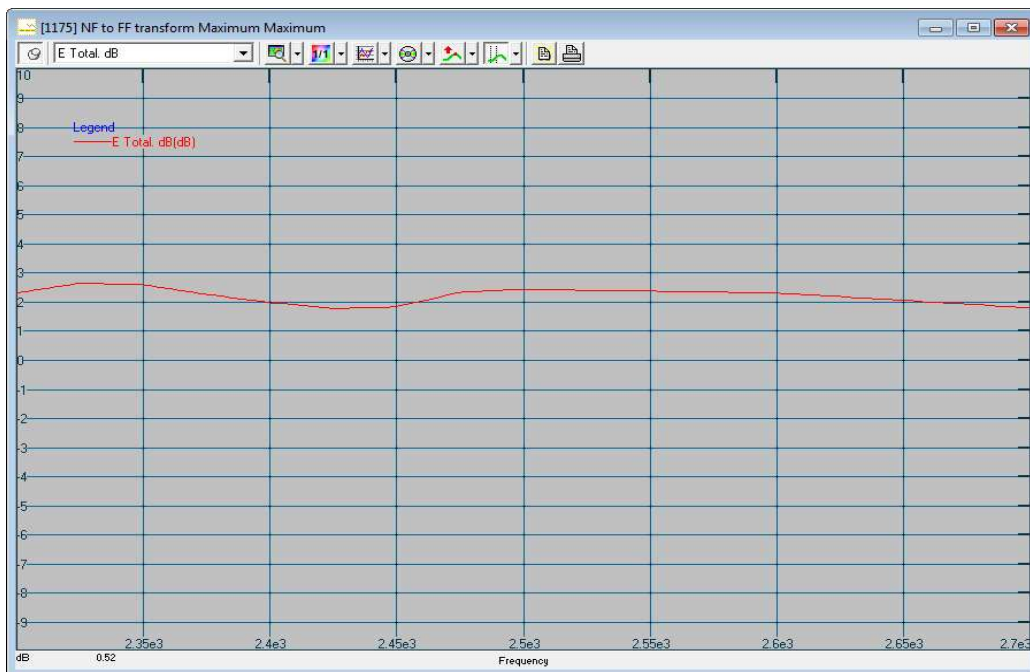

The information contained in this document is proprietary to Motorola Solutions and shall not be reproduced or used in whole or in part without Motorola Solutions written consent.



Material or Methods Specification

Number: PMAN5101A
Issue: A
Date: October 2, 2018

TITLE: APX8500-HP 2.4/5 GHz Covert Glass-Mount BT/WIFI ANTENNA Page 13 of 26

| Frequency | E.Total. dB (dB) |
|-----------|------------------|
| 2300MHz | 2.30958 |
| 2325MHz | 2.64247 |
| 2350MHz | 2.60669 |
| 2375MHz | 2.27192 |
| 2400MHz | 1.98413 |
| 2425MHz | 1.77924 |
| 2450MHz | 1.8418 |
| 2475MHz | 2.34788 |
| 2500MHz | 2.43798 |
| 2600MHz | 2.31923 |
| 2700MHz | 1.80242 |

The information contained in this document is proprietary to Motorola Solutions and shall not be reproduced or used in whole or in part without Motorola Solutions written consent.



Material or Methods Specification

Number: PMAN5101A
Issue: A
Date: October 2, 2018

TITLE: APX8500-HP 2.4/5 GHz Covert Glass-Mount BT/WIFI ANTENNA Page 14 of 26

Peak Gain (dBi), WIFI 5 GHz

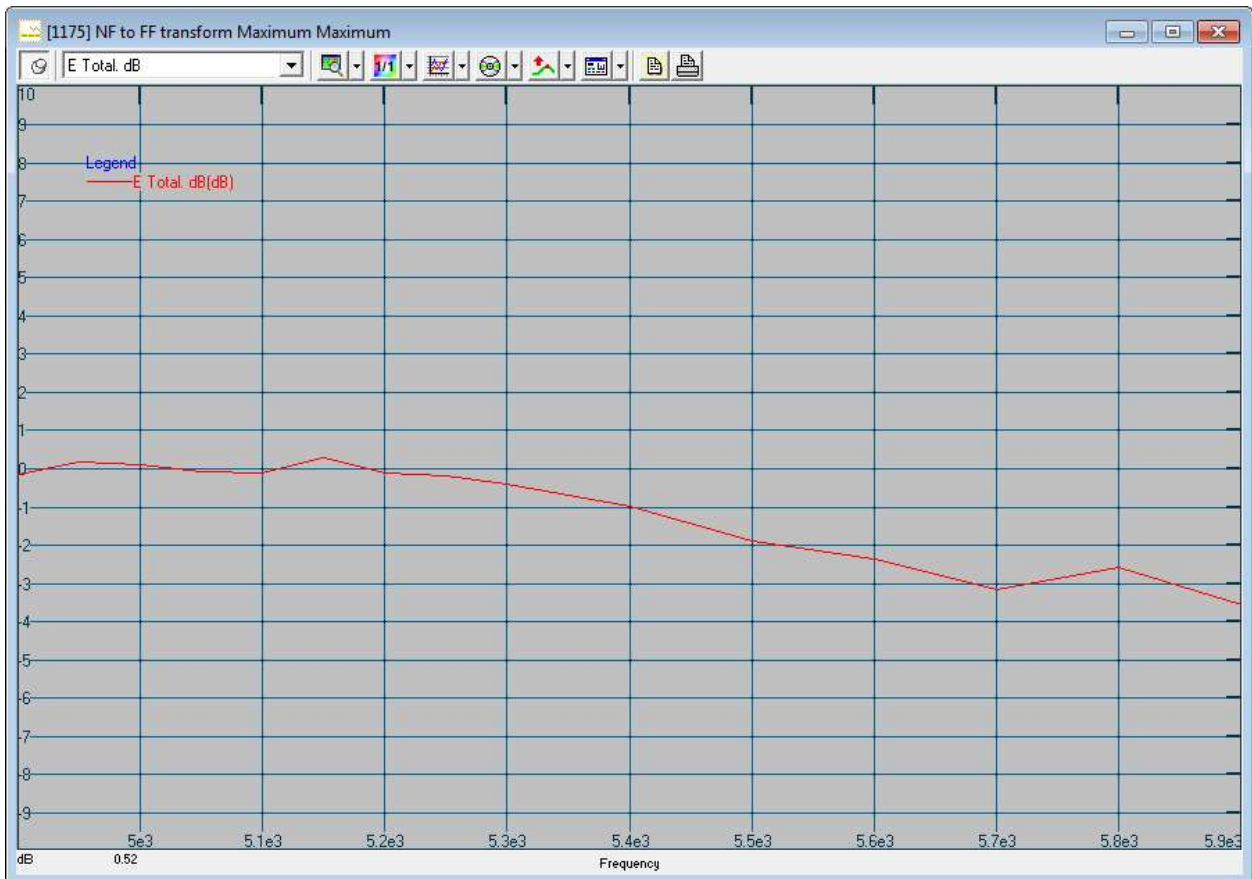

The information contained in this document is proprietary to Motorola Solutions and shall not be reproduced or used in whole or in part without Motorola Solutions written consent.



Material or Methods Specification

Number: PMAN5101A
Issue: A
Date: October 2, 2018

TITLE: APX8500-HP 2.4/5 GHz Covert Glass-Mount BT/WIFI ANTENNA Page 15 of 26

| Frequency | E.Total. dB (dB) |
|-----------|------------------|
| 4900MHz | -1.43E-01 |
| 4950MHz | 1.71E-01 |
| 5000MHz | 1.05E-01 |
| 5050MHz | -7.24E-02 |
| 5100MHz | -1.08E-01 |
| 5150MHz | 2.76E-01 |
| 5200MHz | -9.37E-02 |
| 5250MHz | -1.64E-01 |
| 5300MHz | -4.06E-01 |
| 5400MHz | -9.92E-01 |
| 5500MHz | -1.87295 |
| 5600MHz | -2.35549 |
| 5700MHz | -3.15544 |
| 5800MHz | -2.5779 |
| 5900MHz | -3.57516 |

The information contained in this document is proprietary to Motorola Solutions and shall not be reproduced or used in whole or in part without Motorola Solutions written consent.



Material or Methods Specification

Number: PMAN5101A
Issue: A
Date: October 2, 2018

TITLE: APX8500-HP 2.4/5 GHz Covert Glass-Mount BT/WIFI ANTENNA Page 16 of 26

8. TYPICAL EFFICIENCY FOR REFERENCE

(Mounted as shown in Fig 1B, With RG316 FEP 1ft and PFP-195 16ft cable)

Measured in an anechoic setup/ open space with no interference. The antenna cable was cut to 1-foot length and terminated with SMA Male connector. A 16-foot PFP-195 cable assembly was attached to the antenna pigtail and terminated with Male QMA. The antenna was mounted on a 12 W x 5 H x .25- inch glass pane bordered with a metal rim (right side border of the pane).

Efficiency, WIFI 2.4 GHz

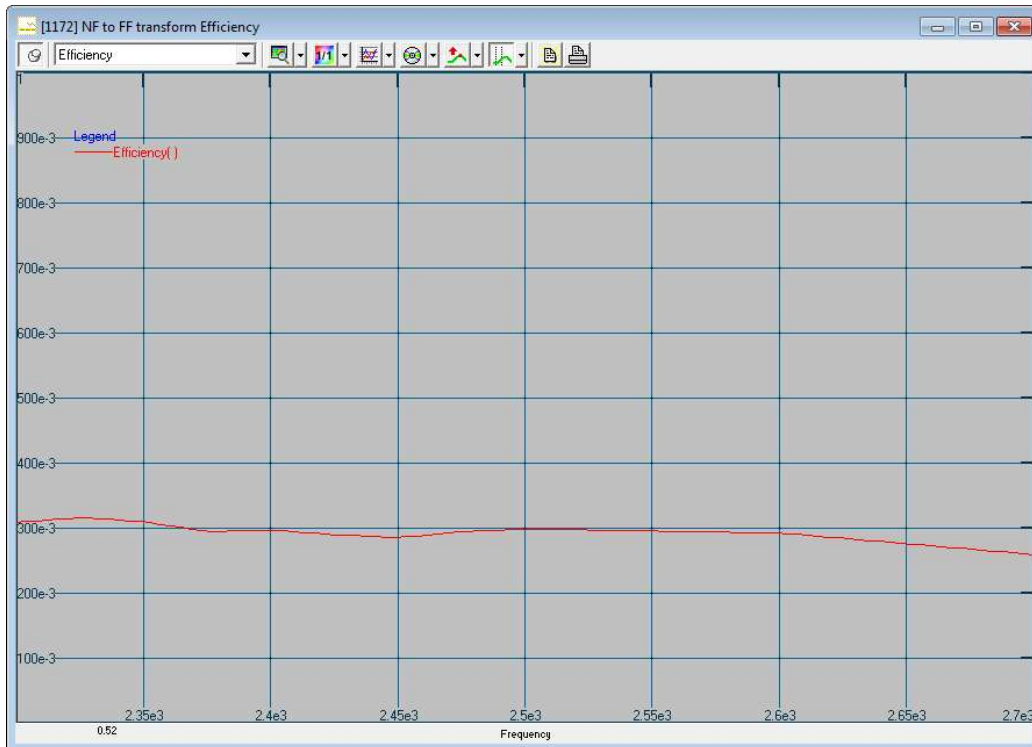

The information contained in this document is proprietary to Motorola Solutions and shall not be reproduced or used in whole or in part without Motorola Solutions written consent.



Material or Methods Specification

Number: PMAN5101A
Issue: A
Date: October 2, 2018

TITLE: APX8500-HP 2.4/5 GHz Covert Glass-Mount BT/WIFI ANTENNA Page 17 of 26

| Frequency | Efficiency |
|-----------|------------|
| 2300MHz | 3.09E-01 |
| 2325MHz | 3.17E-01 |
| 2350MHz | 3.10E-01 |
| 2375MHz | 2.95E-01 |
| 2400MHz | 2.98E-01 |
| 2425MHz | 2.90E-01 |
| 2450MHz | 2.86E-01 |
| 2475MHz | 2.95E-01 |
| 2500MHz | 2.99E-01 |
| 2600MHz | 2.93E-01 |
| 2700MHz | 2.60E-01 |

The information contained in this document is proprietary to Motorola Solutions and shall not be reproduced or used in whole or in part without Motorola Solutions written consent.



Material or Methods Specification

Number: PMAN5101A
Issue: A
Date: October 2, 2018

TITLE: APX8500-HP 2.4/5 GHz Covert Glass-Mount BT/WIFI ANTENNA Page 18 of 26

Efficiency, WIFI 5 GHz

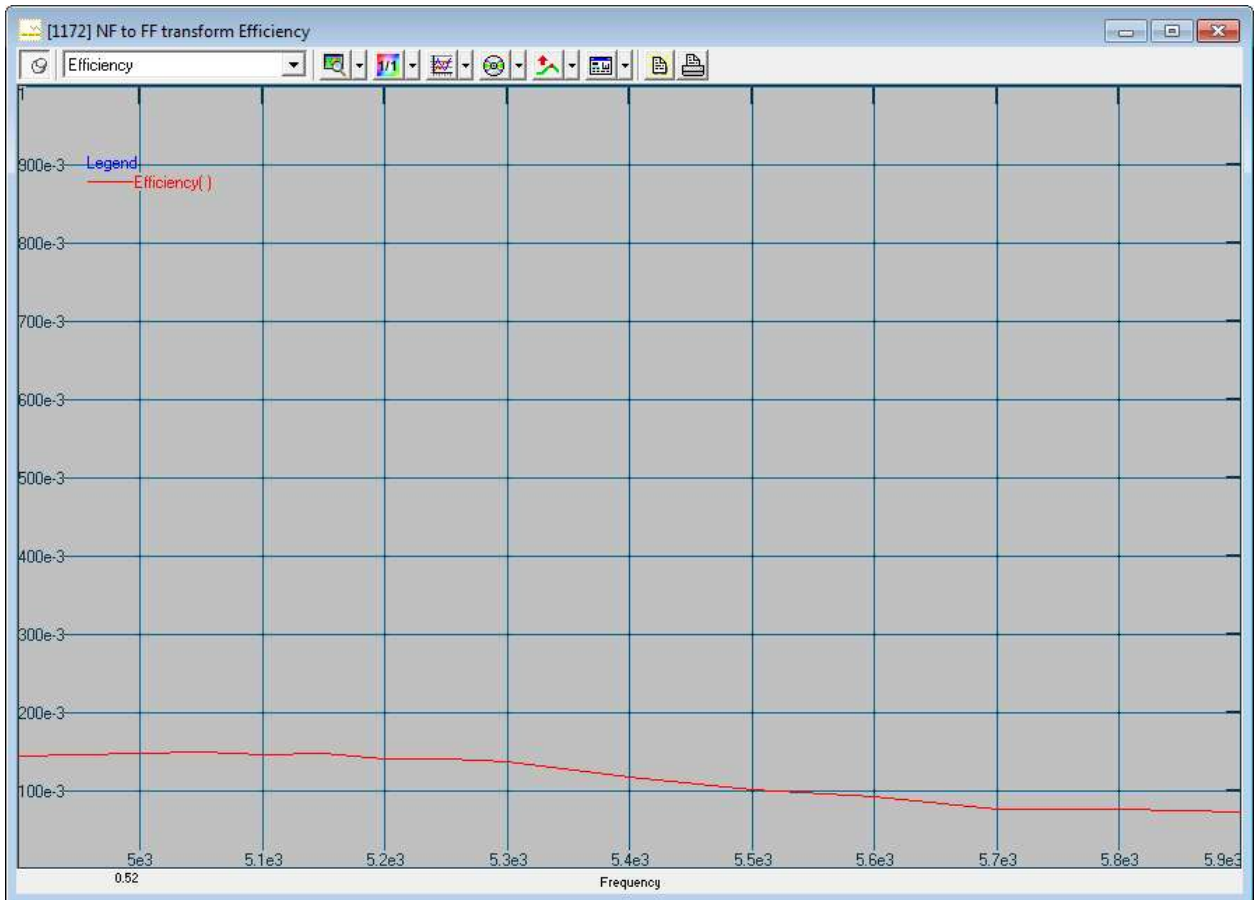

The information contained in this document is proprietary to Motorola Solutions and shall not be reproduced or used in whole or in part without Motorola Solutions written consent.



Material or Methods Specification

Number: PMAN5101A
Issue: A
Date: October 2, 2018

TITLE: APX8500-HP 2.4/5 GHz Covert Glass-Mount BT/WIFI ANTENNA Page 19 of 26

| Frequency | Efficiency |
|-----------|------------|
| 4900MHz | 1.45E-01 |
| 4950MHz | 1.47E-01 |
| 5000MHz | 1.49E-01 |
| 5050MHz | 1.50E-01 |
| 5100MHz | 1.47E-01 |
| 5150MHz | 1.49E-01 |
| 5200MHz | 1.41E-01 |
| 5250MHz | 1.42E-01 |
| 5300MHz | 1.38E-01 |
| 5400MHz | 1.18E-01 |
| 5500MHz | 1.03E-01 |
| 5600MHz | 9.34E-02 |
| 5700MHz | 7.74E-02 |
| 5800MHz | 7.82E-02 |
| 5900MHz | 7.47E-02 |

The information contained in this document is proprietary to Motorola Solutions and shall not be reproduced or used in whole or in part without Motorola Solutions written consent.



Material or Methods Specification

Number: PMAN5101A
Issue: A
Date: October 2, 2018

TITLE: APX8500-HP 2.4/5 GHz Covert Glass-Mount BT/WIFI ANTENNA Page 20 of 26

9. TYPICAL RADIATION PATTERNS

(Mounted as shown in Fig 1B, With RG316 FEP 1ft and PFP-195 16ft cable)

Measured in an anechoic setup/ open space with no interference. The antenna cable was cut to 1-foot length and terminated with SMA Male connector. A 16-foot PFP-195 cable assembly was attached to the antenna pigtail and terminated with Male QMA. The antenna was mounted on a 12 W x 5 H x .25- inch glass pane bordered with a metal rim (right side border of the pane).

2.4 GHz, Phi=0

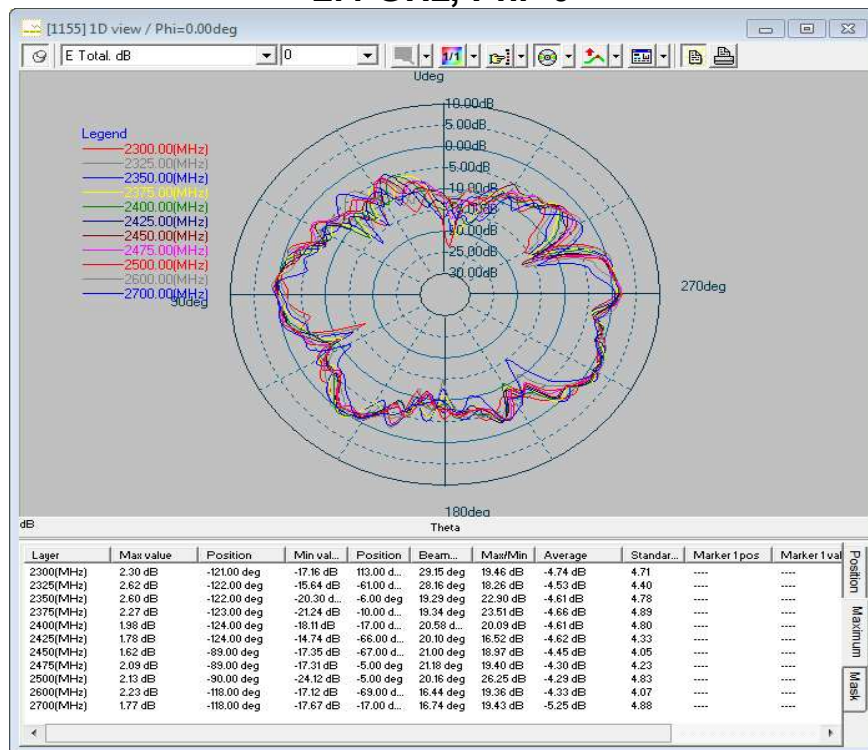

The information contained in this document is proprietary to Motorola Solutions and shall not be reproduced or used in whole or in part without Motorola Solutions written consent.



Material or Methods Specification

Number: PMAN5101A
Issue: A
Date: October 2, 2018

TITLE: APX8500-HP 2.4/5 GHz Covert Glass-Mount BT/WIFI ANTENNA Page 21 of 26

2.4 GHz, Phi=90

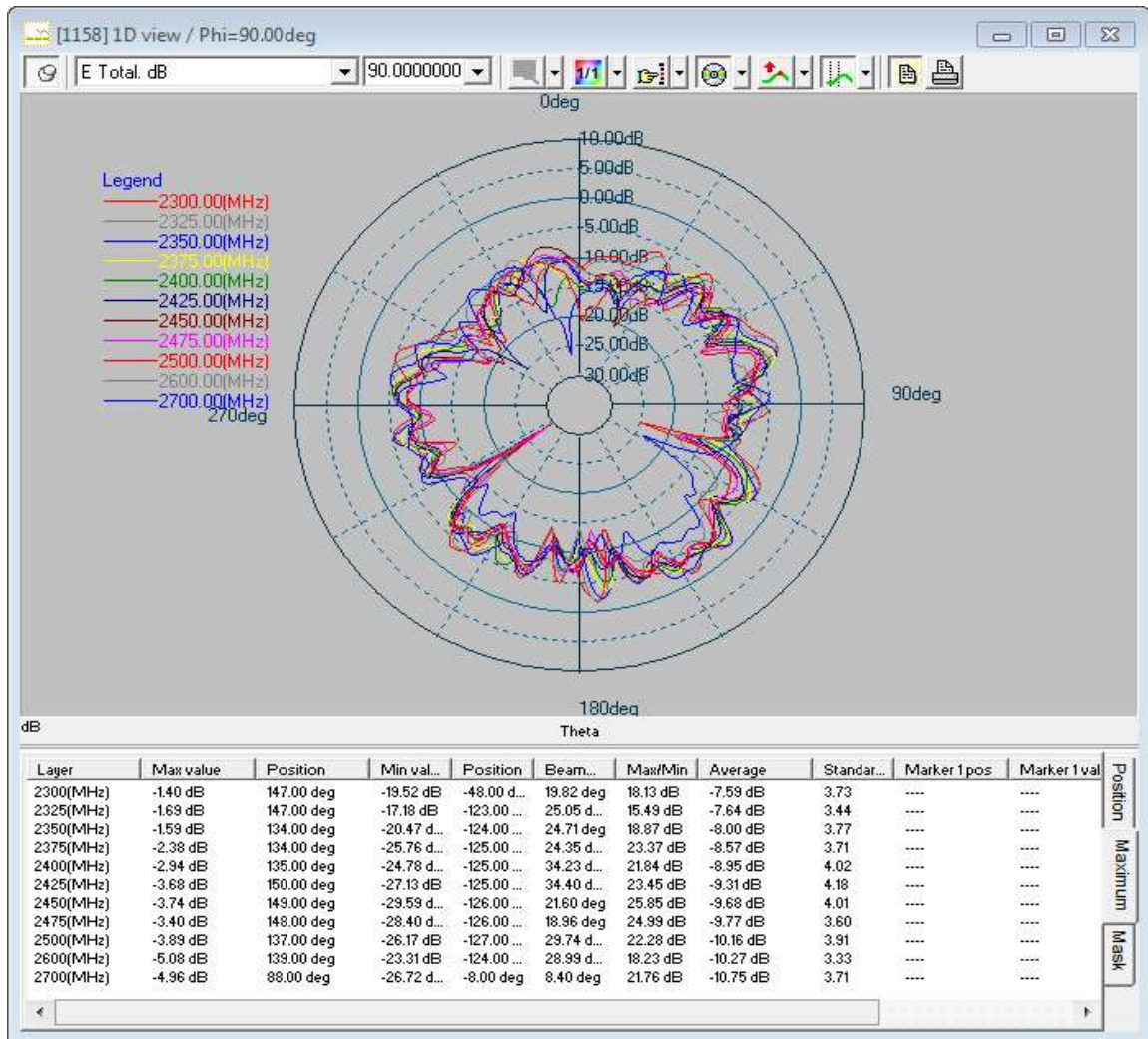

The information contained in this document is proprietary to Motorola Solutions and shall not be reproduced or used in whole or in part without Motorola Solutions written consent.



Material or Methods Specification

Number: PMAN5101A
Issue: A
Date: October 2, 2018

TITLE: APX8500-HP 2.4/5 GHz Covert Glass-Mount BT/WIFI ANTENNA Page 22 of 26

2.4 GHz, Theta=90

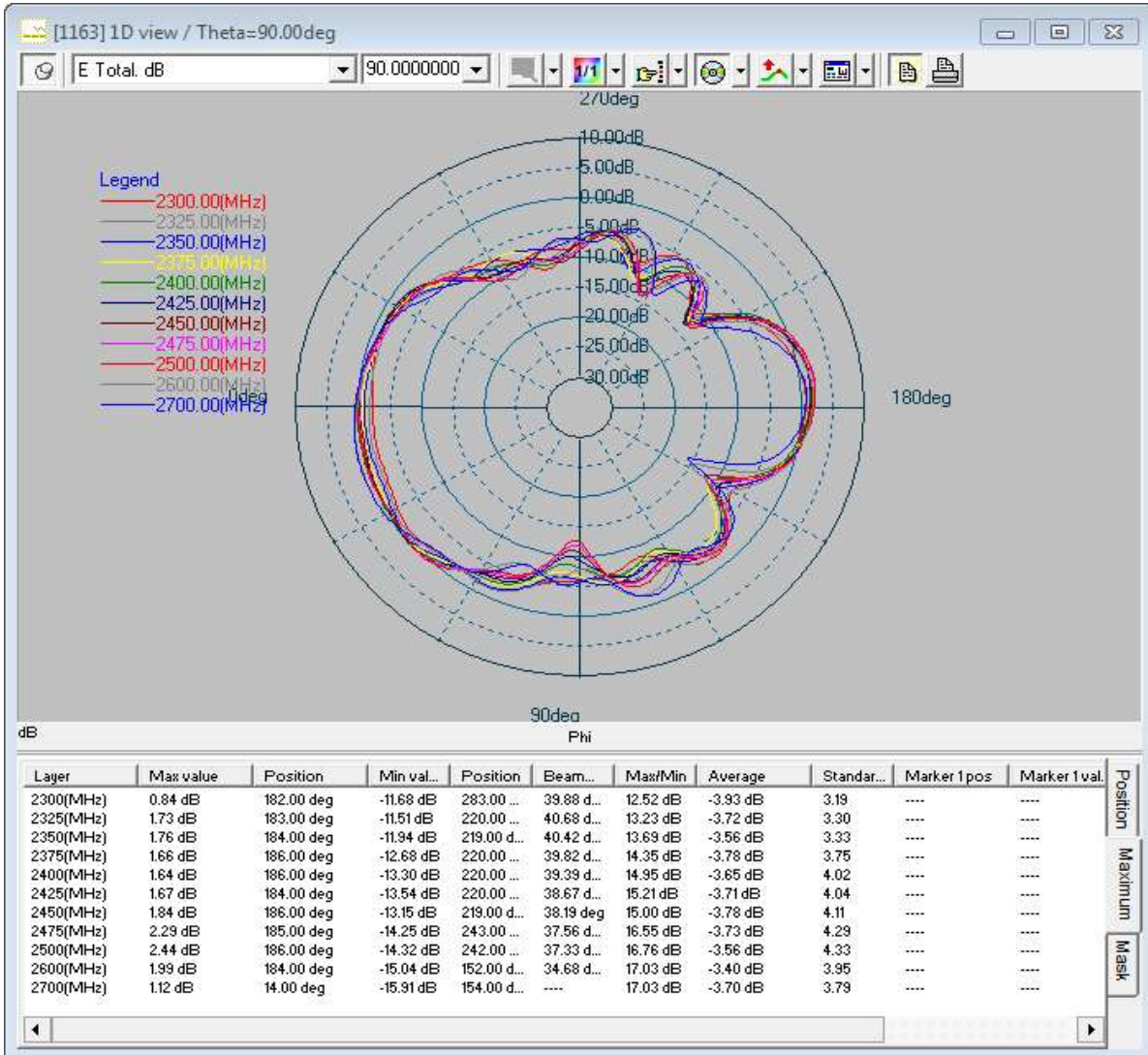

The information contained in this document is proprietary to Motorola Solutions and shall not be reproduced or used in whole or in part without Motorola Solutions written consent.



Material or Methods Specification

Number: PMAN5101A
Issue: A
Date: October 2, 2018

TITLE: APX8500-HP 2.4/5 GHz Covert Glass-Mount BT/WIFI ANTENNA Page 23 of 26

5 GHz, Phi=0

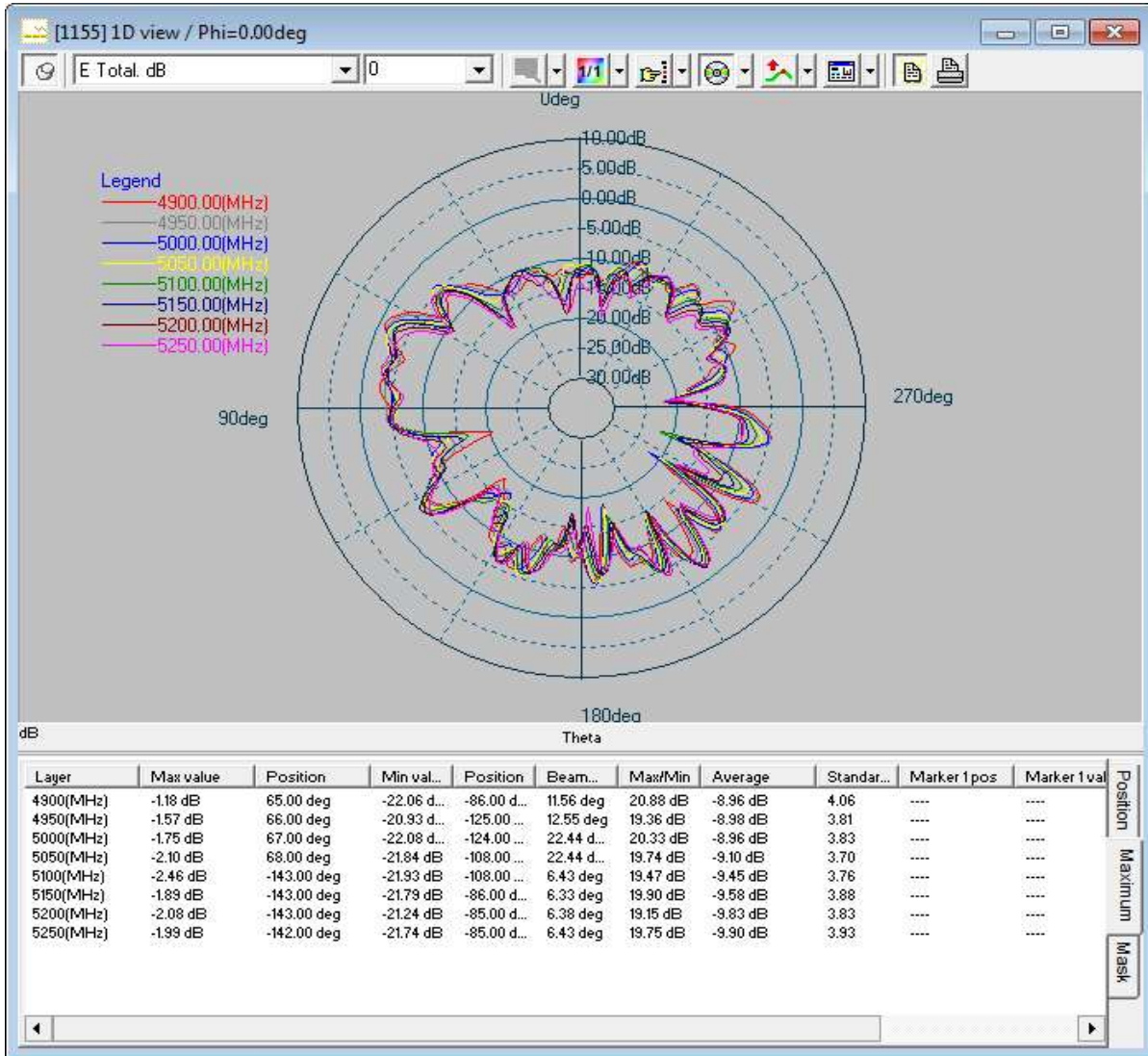

The information contained in this document is proprietary to Motorola Solutions and shall not be reproduced or used in whole or in part without Motorola Solutions written consent.



Material or Methods Specification

Number: PMAN5101A
Issue: A
Date: October 2, 2018

TITLE: APX8500-HP 2.4/5 GHz Covert Glass-Mount BT/WIFI ANTENNA Page 24 of 26

5 GHz, Phi=90

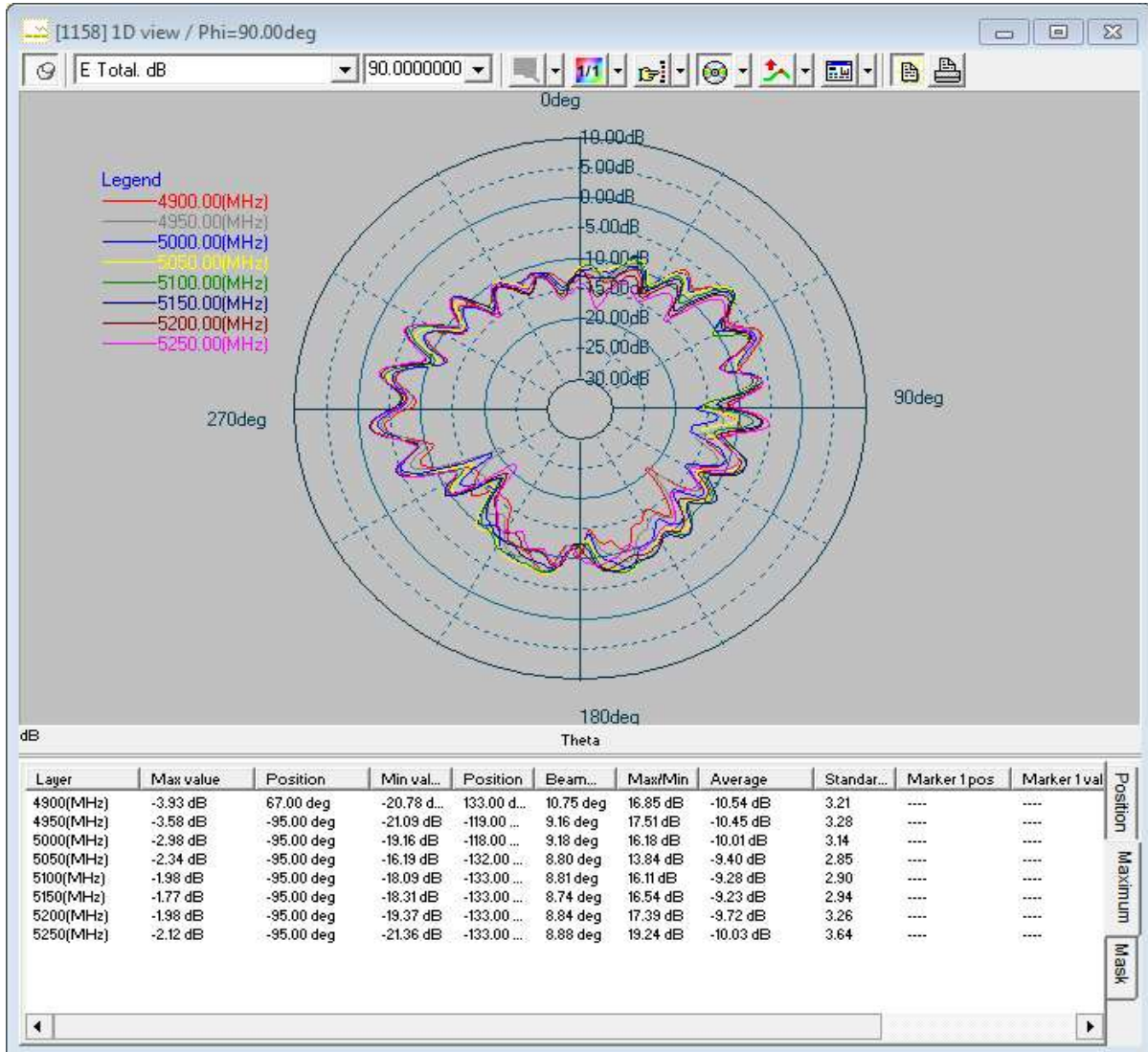

The information contained in this document is proprietary to Motorola Solutions and shall not be reproduced or used in whole or in part without Motorola Solutions written consent.



Material or Methods Specification

Number: PMAN5101A
Issue: A
Date: October 2, 2018

TITLE: APX8500-HP 2.4/5 GHz Covert Glass-Mount BT/WIFI ANTENNA Page 25 of 26

5 GHz, Theta=90

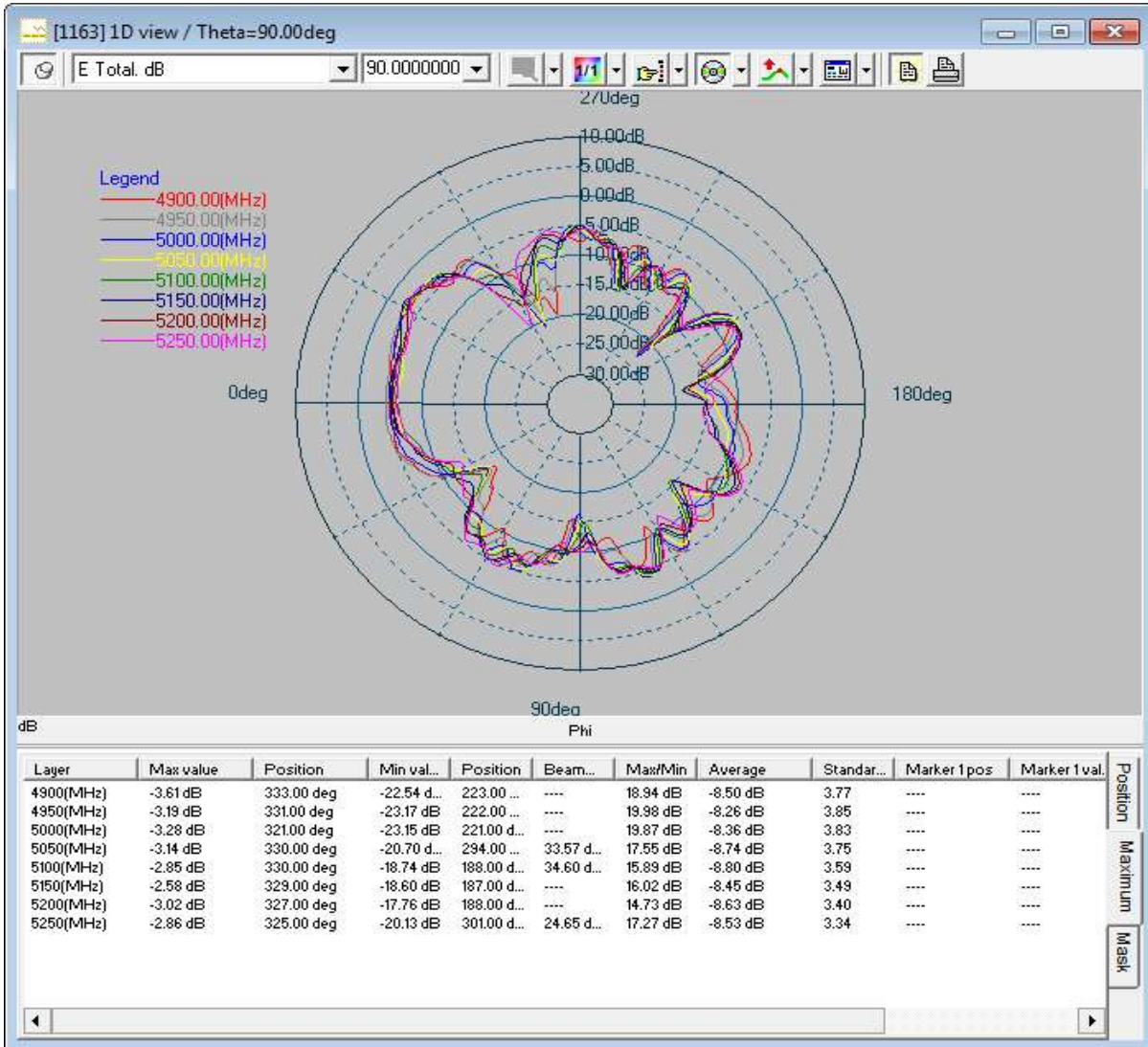

The information contained in this document is proprietary to Motorola Solutions and shall not be reproduced or used in whole or in part without Motorola Solutions written consent.



Material or Methods Specification

Number: PMAN5101A
Issue: A
Date: October 2, 2018

TITLE: APX8500-HP 2.4/5 GHz Covert Glass-Mount BT/WIFI ANTENNA Page 26 of 26

10. OTHER ANTENNA PARAMETERS mounted as shown in Fig 1B

| Band | Frequency (GHz) | 3 dB Vertical Bandwidth (degrees) | Peak Gain Angle from horizon (degrees) |
|---------|-----------------|-----------------------------------|--|
| 2.4 GHz | 2.45 | 25 | 12 |
| 5GHz | 5.3 | 22 | 15 |
| | 5.6 | 22 | 15 |

The information contained in this document is proprietary to Motorola Solutions and shall not be reproduced or used in whole or in part without Motorola Solutions written consent.