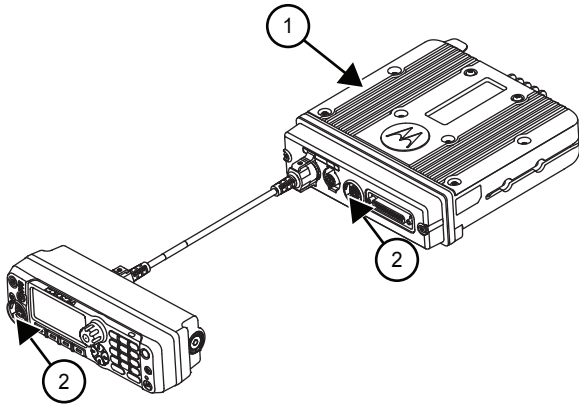
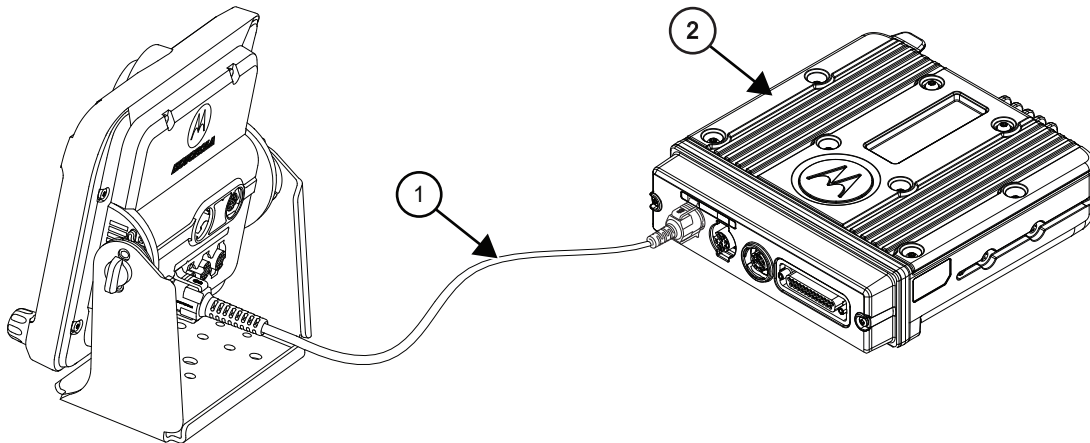

Figure 21: Remote Mount Configuration with Mid Power Transceiver, Transceiver Interface Board, CHIB Rear Assembly, and O7 Control Head



No.	Description
1	ASTRO 25 Subscribers Enhanced Single Band Mobile Radio
2	MMP

Figure 22: Remote Mount Configuration with Mid Power Transceiver, Transceiver Interface Board, and O9 Control Head



No.	Description
1	17 ft Extension Cable
2	ASTRO 25 Subscribers Enhanced Single Band Mobile Radio

Figure 23: Remote Mount Configuration with Mid Power Radio Transceiver, Universal Relay Controller (URC), and O7 Control Head (URC is optional)

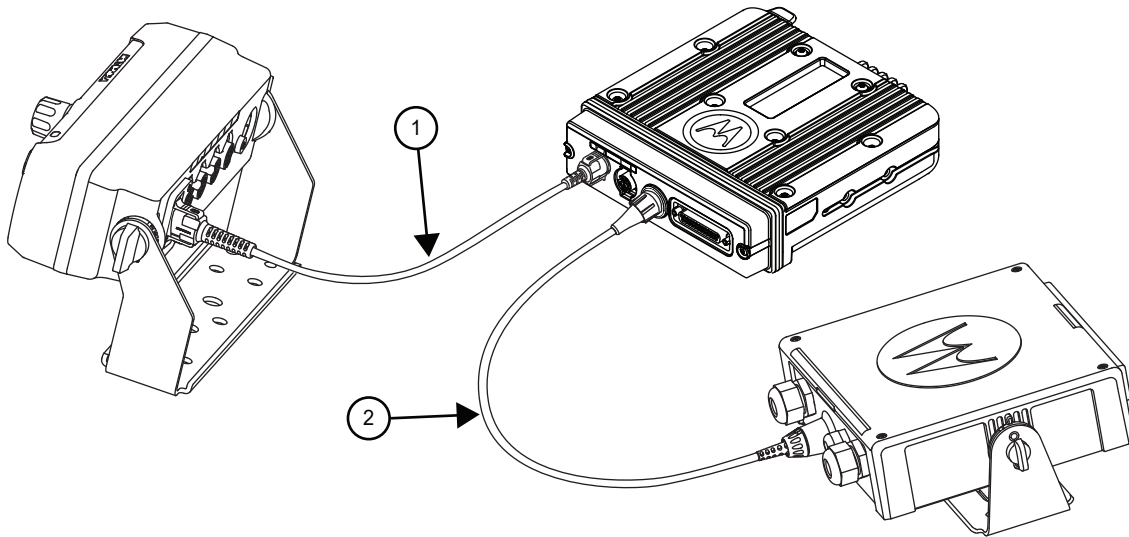

No.	Description
1	17 ft Extension Cable
2	O7 to URC Cable

Figure 24: Remote Mount Configuration with Mid Power Radio Transceiver, Universal Relay Controller (URC), and O9 Control Head (URC is optional)

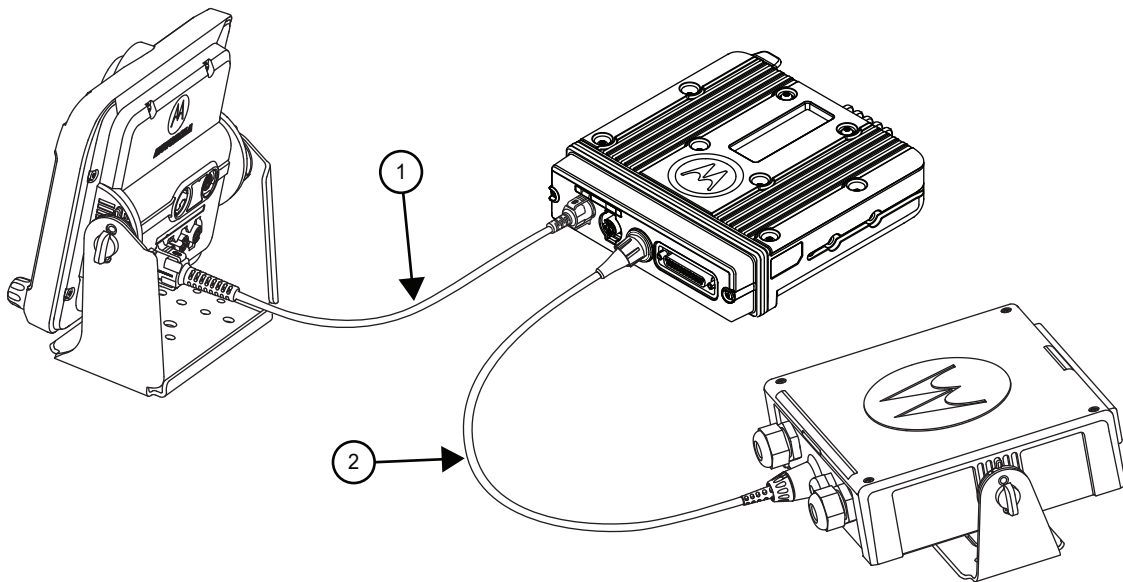

No.	Description
1	17 ft Extension Cable
2	O9 to URC Cable

1.2.3

Multi Control Head

The multi control head option allows separate, remotely operated control heads to operate and control the radio.

For example, a fire truck could have a control head located in the cab and on the rear of the truck so that the radio could be operated from outside the vehicle.



NOTICE: The dual control head can be used together in the future.

1.3

Motorcycle Configurations

The mobile motorcycle radio models provide most of the equipment needed for installing a standard mobile radio on a motorcycle.

Most of this radio system is standard equipment. See [Motorcycle Radio Installation on page 98](#) for further information.



NOTICE: The motorcycle configurations are not applicable O9 control heads.

1.4

Base/Control Stations



NOTICE: The base/control station option is not applicable for O9 control heads.

The antenna installation must comply with the following requirements if mobile radio equipment is installed at a fixed location and operated as a control station or as a fixed unit to ensure optimal performance and compliance with the RF energy exposure limits in the standards and guidelines listed in the 6881095C99 manual:

- The antenna should be mounted outside the building on the roof or a tower if at all possible.
- As with all fixed site antenna installations, it is the responsibility of the licensee to manage the site in accordance with applicable regulatory requirements and may require additional compliance actions such as site survey measurements, signage, and site access restrictions to ensure that exposure limits are not exceeded.

1.5

Tools Required for Radio Installations

These are the tools required for mobile radio installation.

Table 1: Tools Required for Radio Installations

Tool	Part Number
10 mm wrench	–
5 mm Allen wrench	–
Rubber-coated pliers	–
Regular slot screwdriver of Phillips #2	–
Pin removal tool	6680163F01

Tool	Part Number
RF antenna tool	HLN6695_
Wing screw torque tool	HLN6970_

Chapter 2

Standard Configurations

The radio operates only in negative ground electrical systems with a valid operating range of 10.8–16.3 VDC. Before starting the installation, ensure that the ground polarity of the vehicle is correct. Accidentally reversing the polarity could damage the radio and cause the cable fuses to blow.

2.1

Planning the Installation

Planning is the key to fast, easy radio installation. Before starting the installation, inspect the vehicle and determine how and where you intend to mount the antenna, radio, and accessories. Plan wire and cable run to provide maximum protection from pinching, crushing, and overheating.



CAUTION:

Before installing any electrical equipment, check the user manual of the vehicle for warnings or recommendations.

Authorized servicer or installer should complete the installation of this device. Failure to properly install the device may result in damage to the device, or improper operation.

2.1.1

Installation Examples

The mobile two-way radio offers various methods of installation, with accessories placed to the vehicle as desired. The radio can be dash or remote mounted except for the O9 control head, which can only be mounted remotely.

Figure 25: Dash Mount Installation

Dash mount radios mounted in the middle console, on the transmission hump, or under the dash,

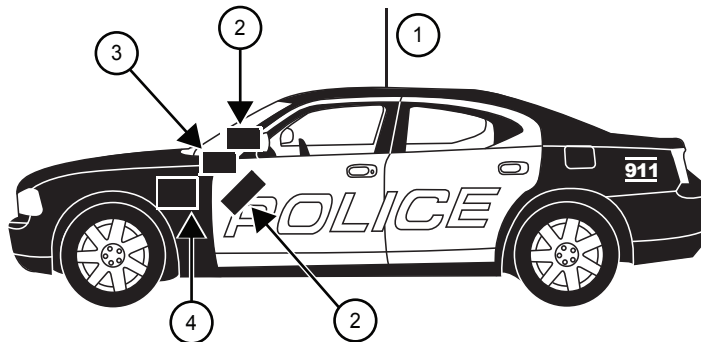

No.	Description
1	Antenna $\frac{1}{4}$ -Wavelength
2	Radio
3	Speaker
4	Battery

Figure 26: Remote Mount Installation

Remote mount radio control heads mounted in the middle console, on the transmission hump, or under the dash.

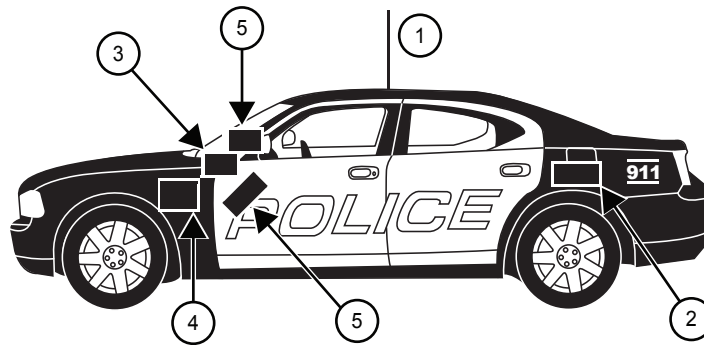

No.	Description
1	Antenna ¼-Wavelength
2	Radio
3	Speaker
4	Battery
5	Control Head

Figure 27: Remote Mount Installation for Radio with O9 Control Head and Universal Relay Controller (URC is optional)

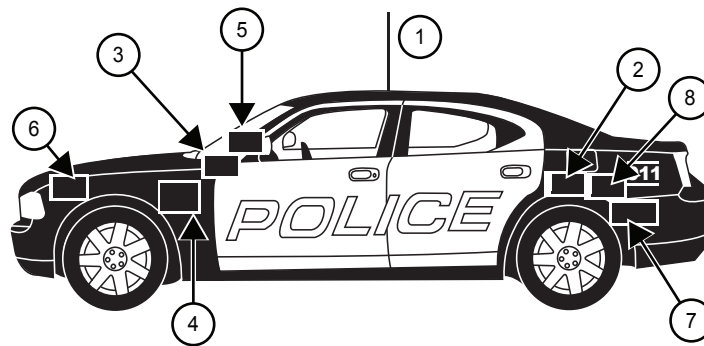

No.	Description
1	Antenna ¼-Wavelength
2	Radio
3	Speaker
4	Battery
5	Control Head
6	Siren Speaker
7	Universal Relay Controller Box
8	Siren Box

2.1.2 Wiring Diagrams

The following figures show the wiring diagrams for all the possible configurations. Identify which of these figures shows the configuration that you are installing, and use the diagram when planning the installation.

For remote mount configuration, refer to [Remote Mount: Power, Ignition, and Emergency Cable Installation on page 45](#) and [Installing Emergency Pushbutton or Footswitch on page 86](#) for further details and recommended wiring of the emergency cables.

Figure 28: Radio Installation (O2 Dash Mount)

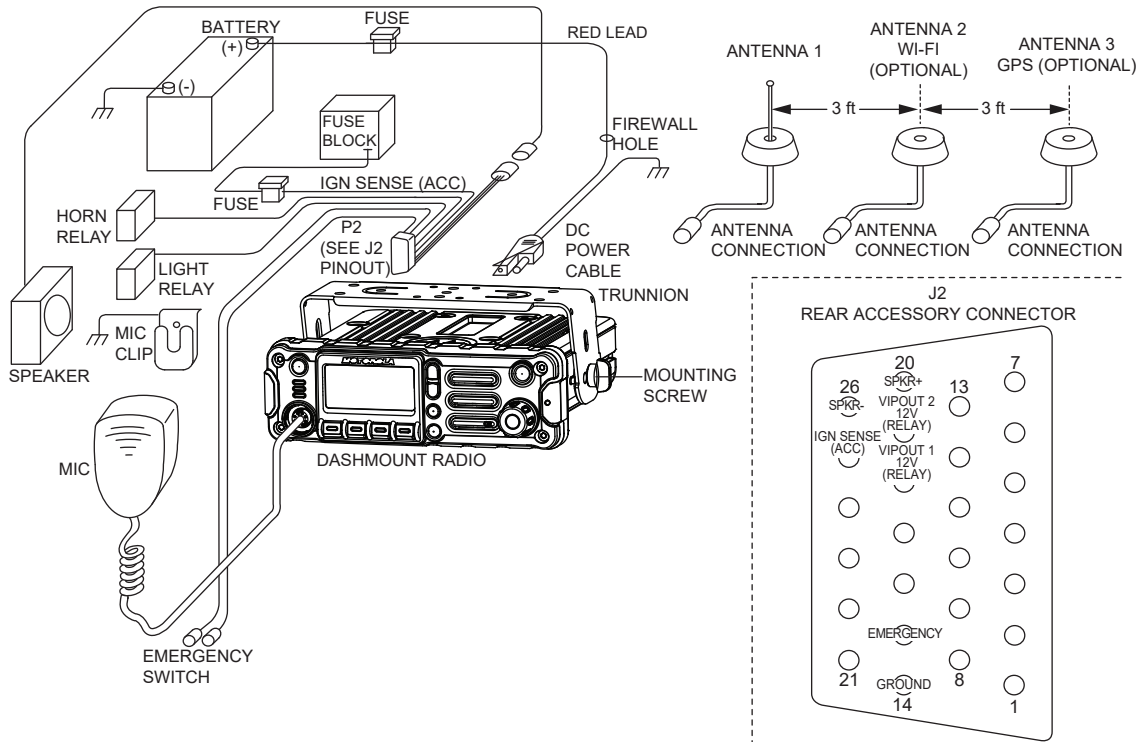

Figure 31: Radio Installation (E5 Dash Mount)

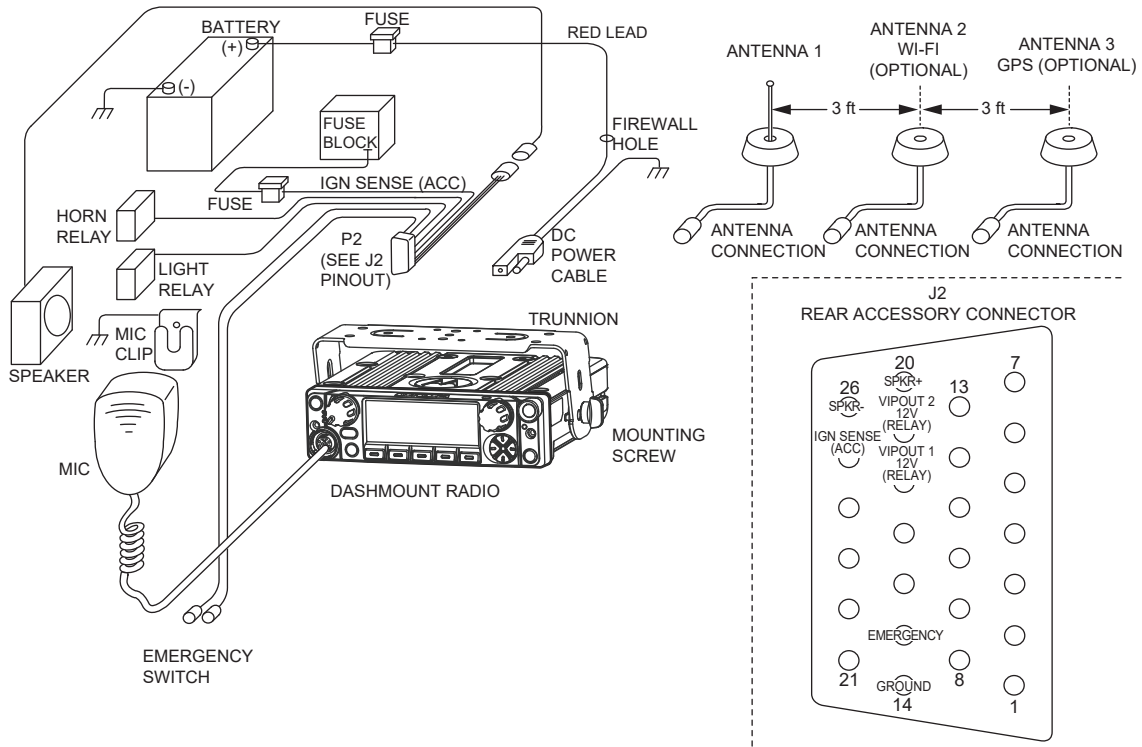
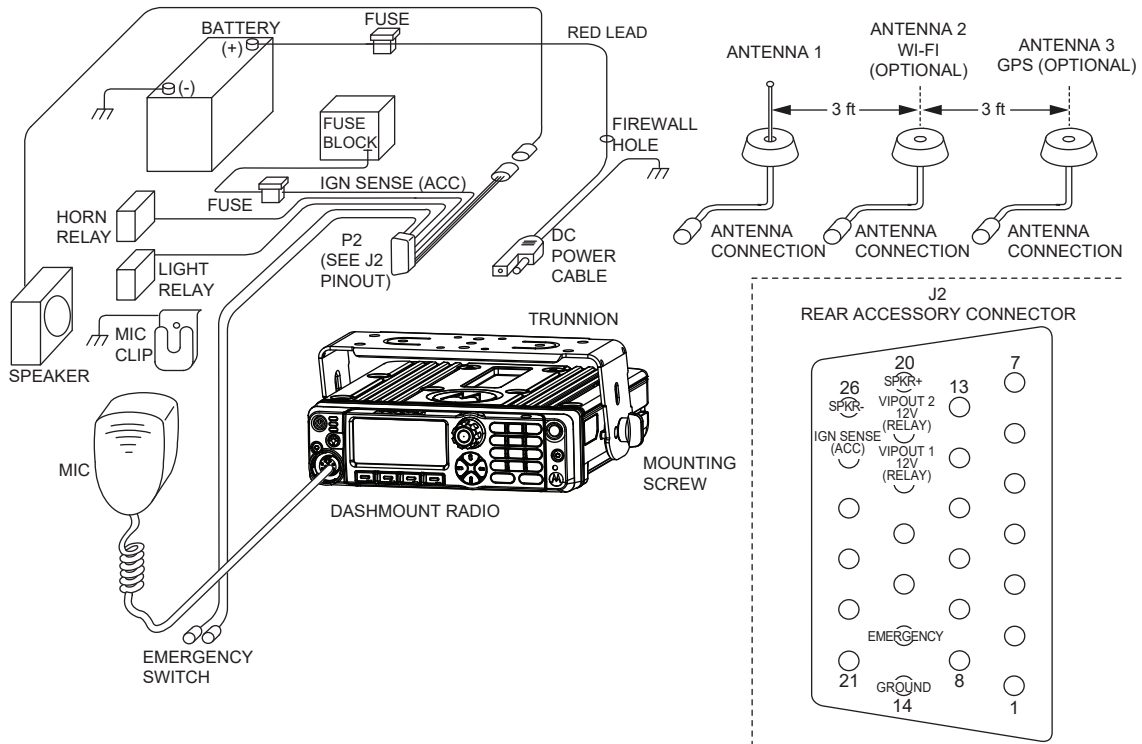

Figure 32: Radio Installation (O7 Dash Mount)



NOTICE: In dash mount configuration, it is mandatory that a rear accessory cable is attached to the back of a mid power radio, to ground the Emergency pin to ground (GND). Or, an emergency footswitch or pushbutton switch must be attached to the back of a mid power radio. If the emergency pin is not grounded, upon the attachment of the A+ cable at the DC connector, the radio detects **HIGH** for the emergency pin state, and assume that emergency has been activated. This condition is an attempt to power on the radio, and results in excessive current draw and incorrect radio operation. Refer to [Dash Mount: Power, Ignition, and Emergency Cable Installation on page 45](#) for further details and recommended wiring of Emergency in dash mount configuration.

Figure 33: Radio Installation (O2 Remote Mount)

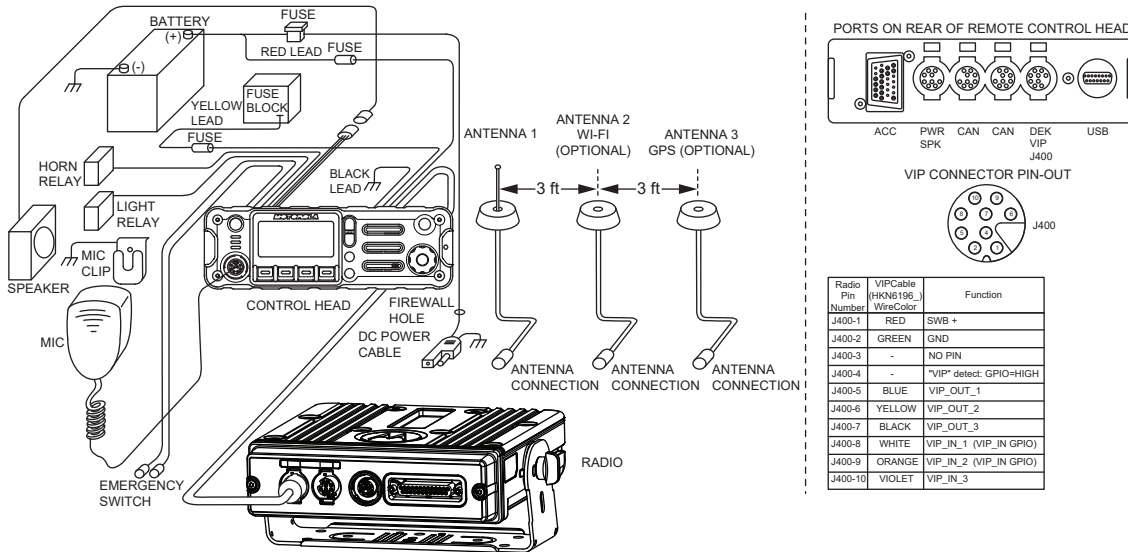

Figure 34: Radio Installation (O3 Remote Mount)

