

EXHIBIT 9

Internal Photographs

(Pursuant to FCC Part 2.1033(b)(7), 2.1033(c)(12) and RSP 100 Annex C)

The following photographs are attached.

	<u>Exhibit</u>
1. RF Board <u>with</u> Shields (Top)	9A
2. RF Board <u>without</u> Shields (Top)	9B
3. RF Board <u>with</u> Shield (Bottom)	9C
4. RF Board <u>without</u> Shield (Bottom)	9D
5. Controller Board (Top)	9E
6. Controller Board (Bottom)	9F
7. Radio Assembly – RF Board (Top View)	9G
8. Radio Assembly – Controller (Bottom View)	9H
9. Exploded View	9I

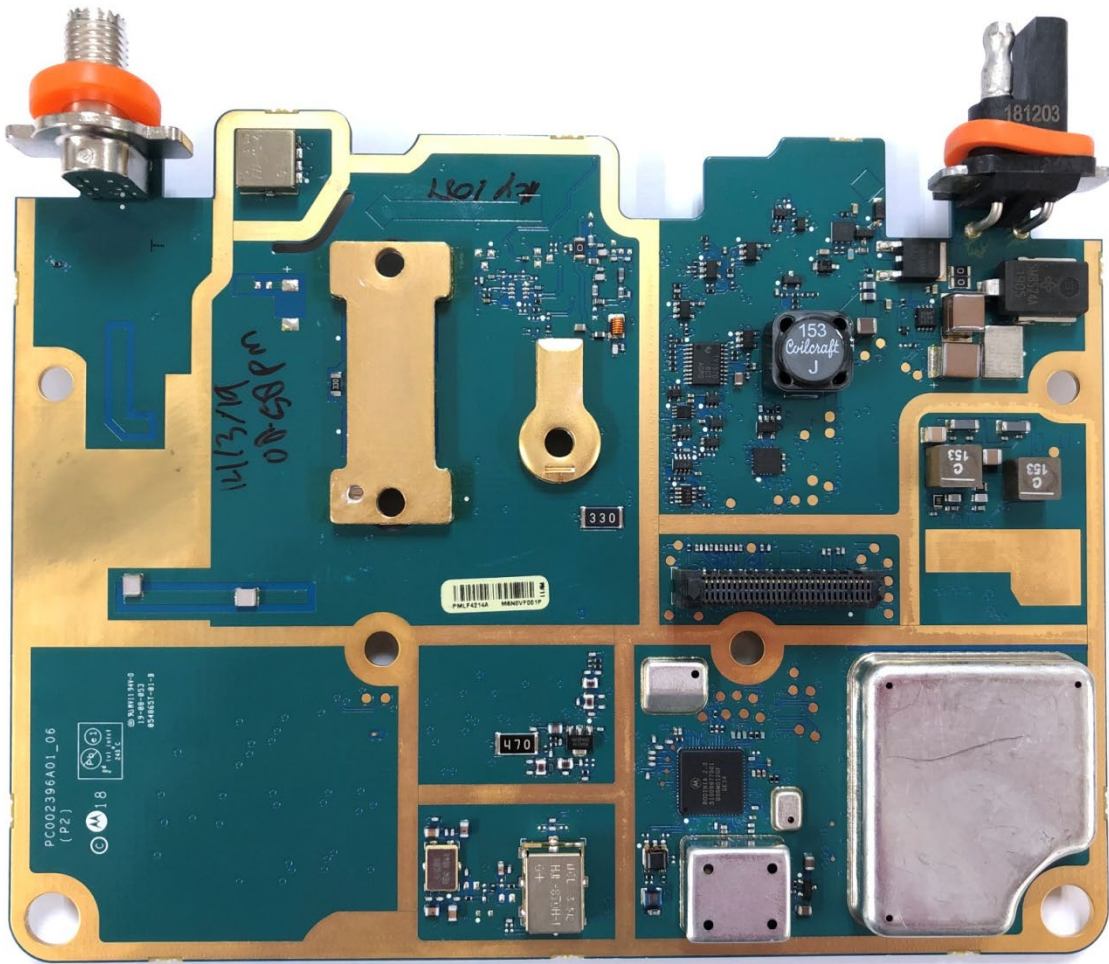

Exhibit 9A: RF Board with Shields (Top)

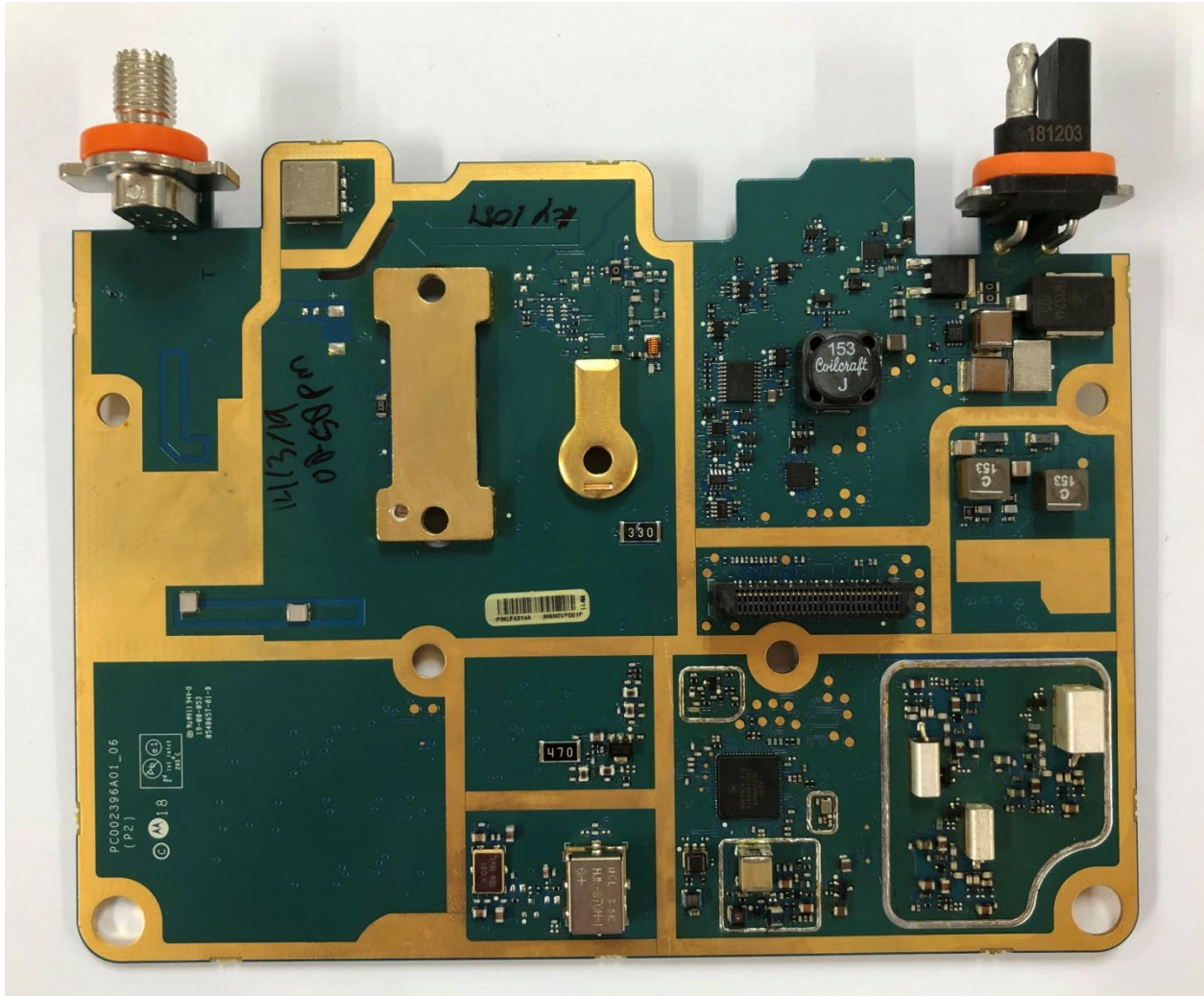

Exhibit 9B: RF Board without Shields (Top)

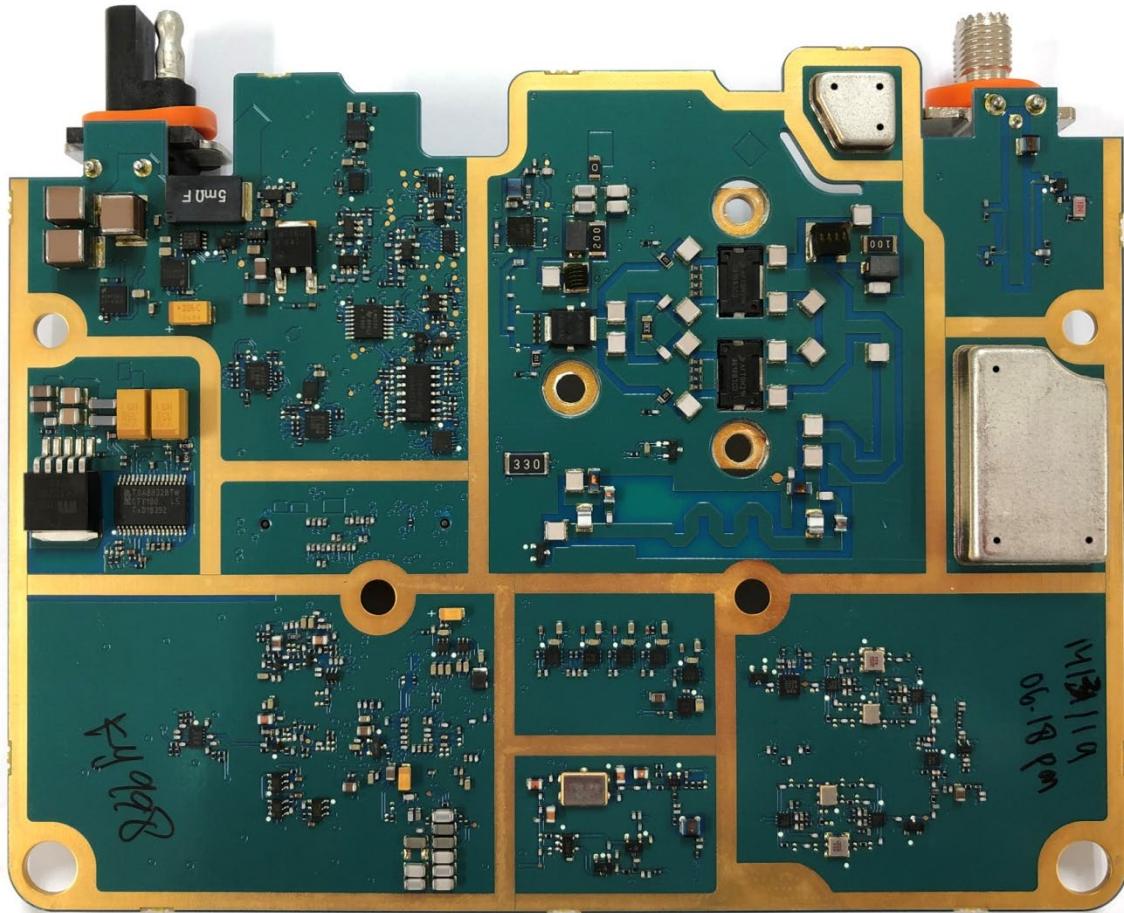

Exhibit 9C: RF Board with Shield (Bottom)

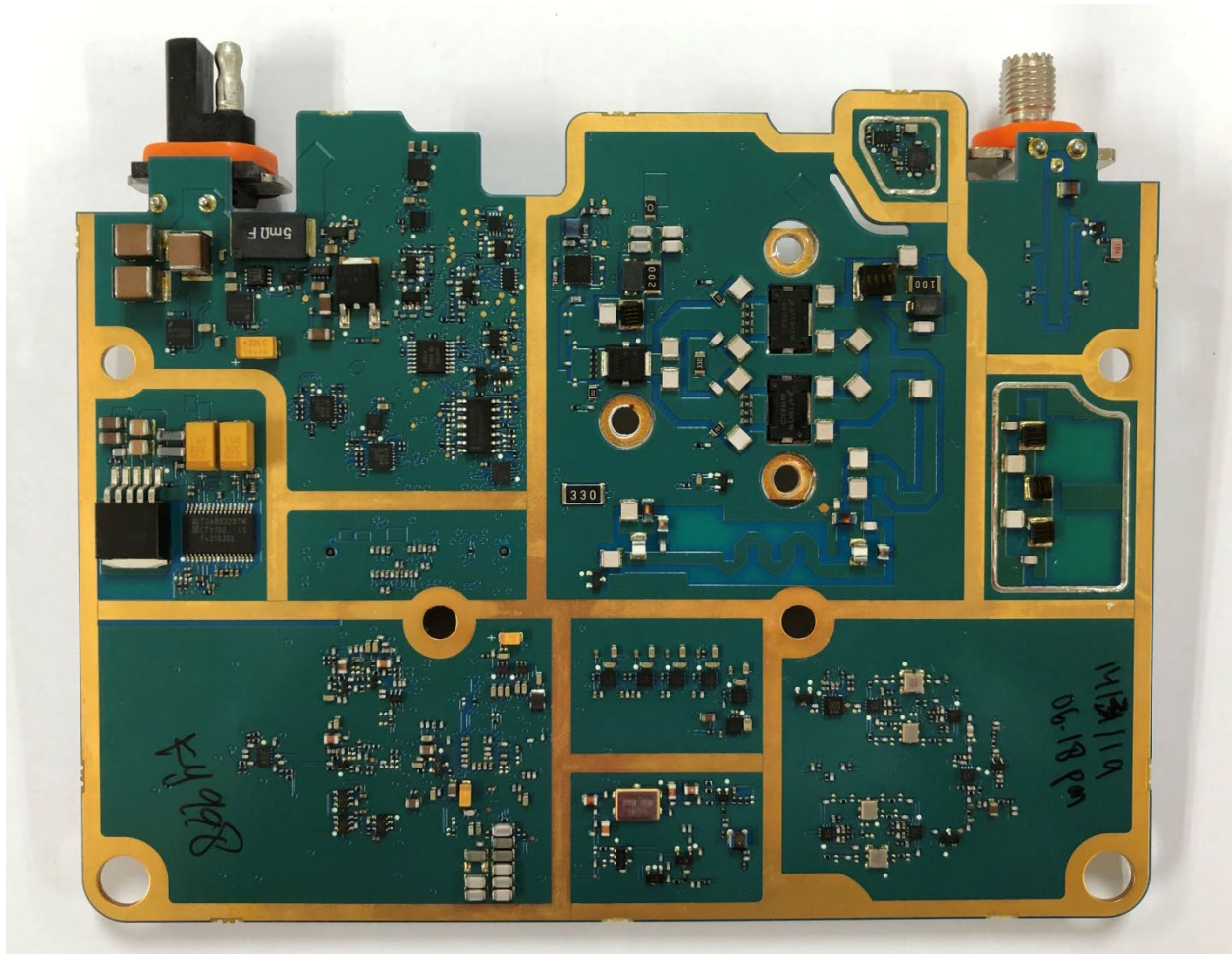

Exhibit 9D: RF Board without Shield (Bottom)

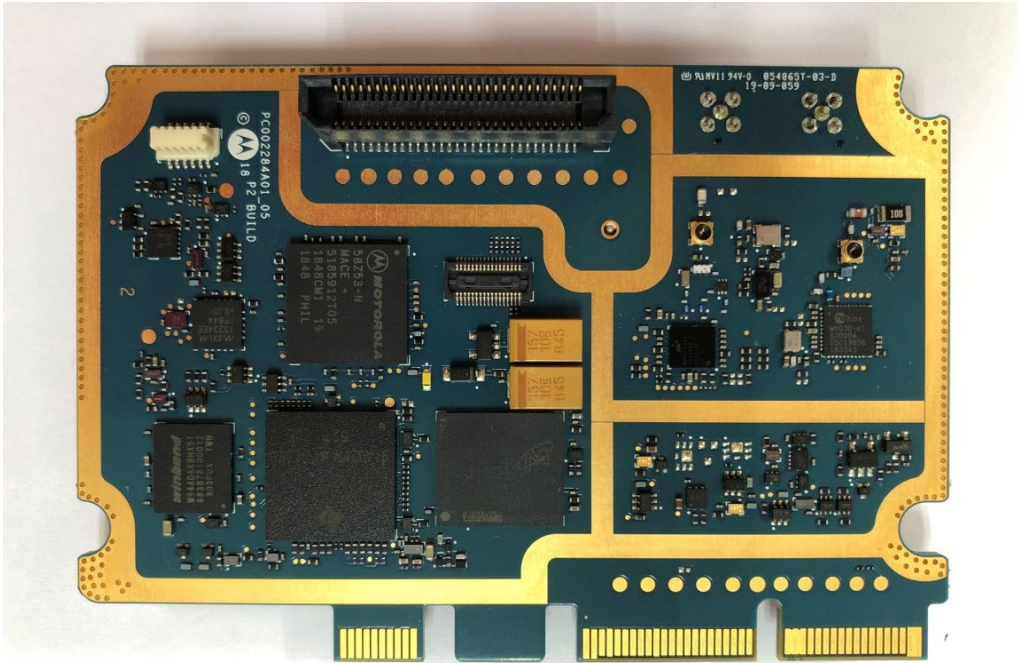

Exhibit 9E: Controller Board (Top)

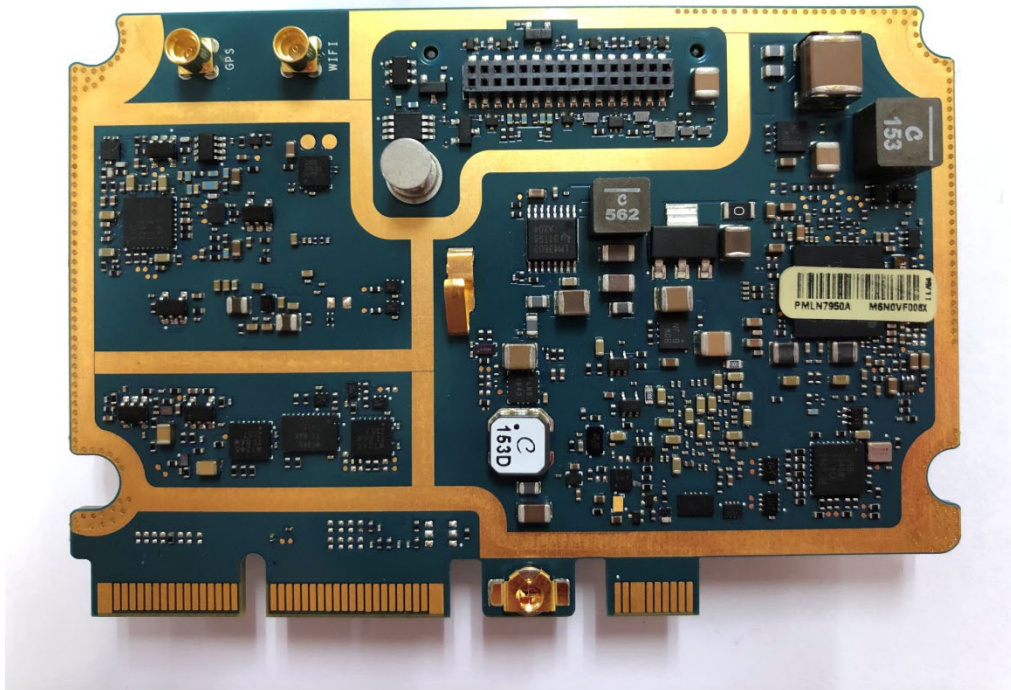

Exhibit 9D: Controller Board (Bottom)

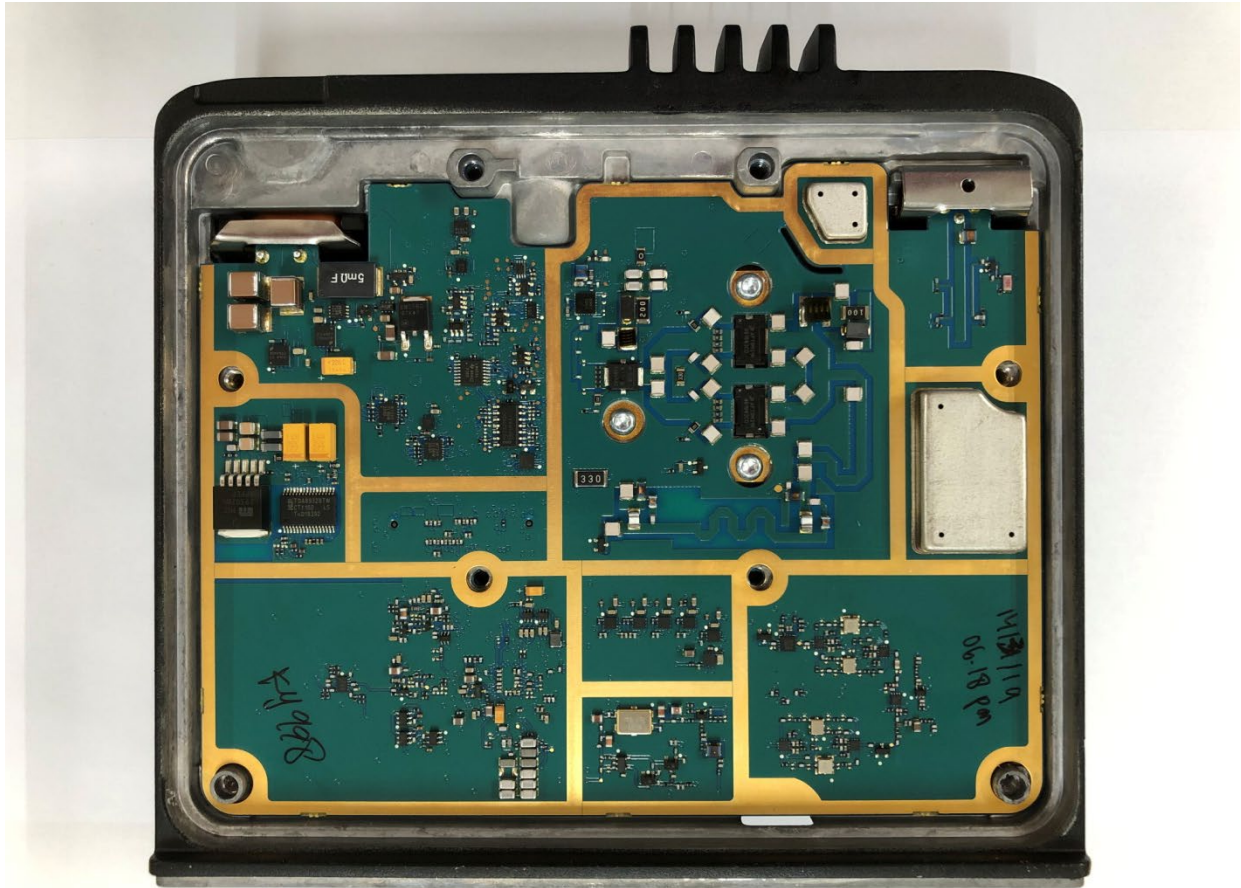

Exhibit 9E: Radio Assembly – RF Board (Top View)



Exhibit 9F: Radio Assembly – Controller Board (Bottom View)

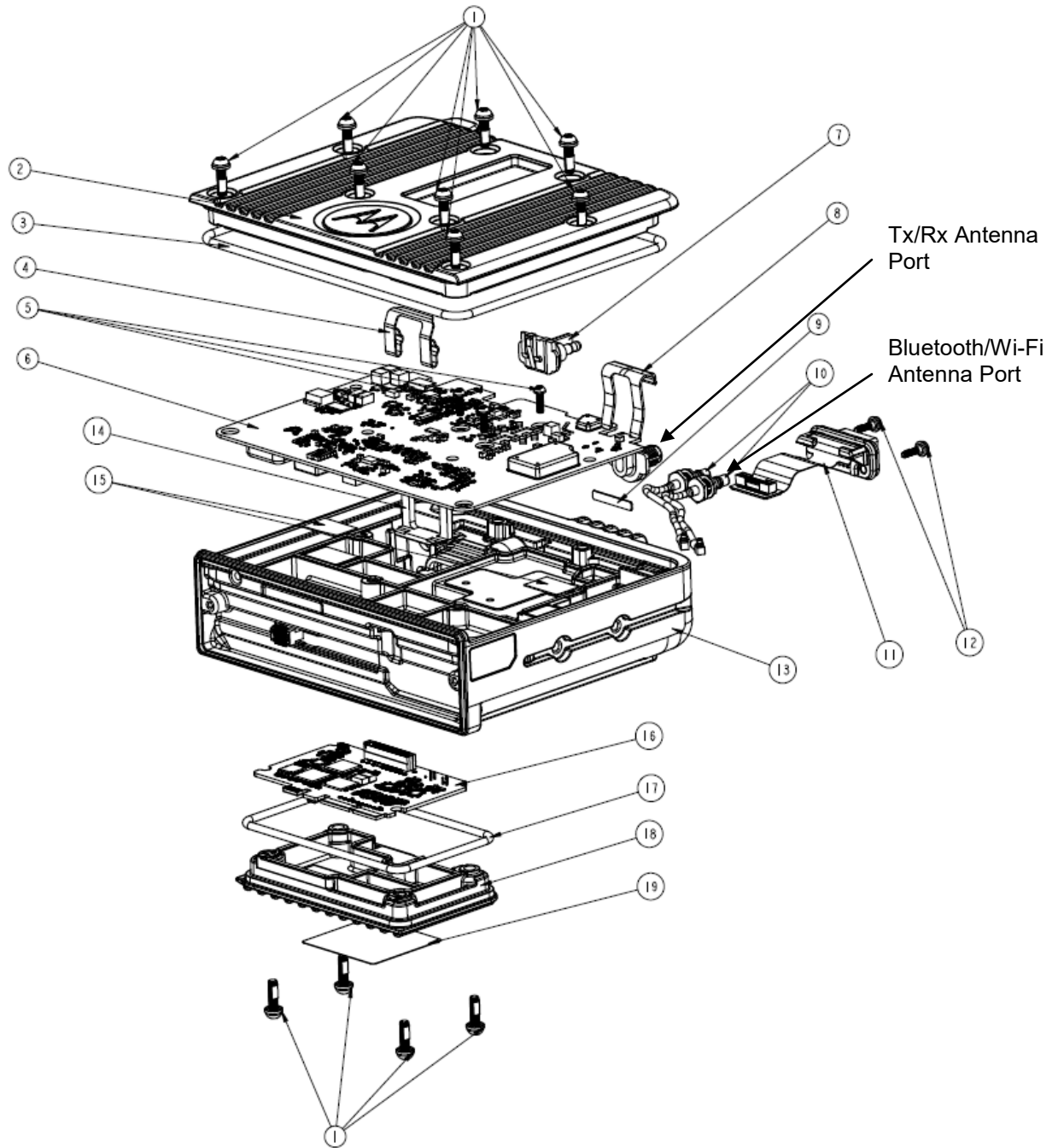

Exhibit 9I: Exploded View