

APX™ TWO-WAY RADIOS

APX MOBILE 05 CONTROL HEAD USER GUIDE



Urdu

Contents

Declaration of Conformity..... 8

Important Safety Information..... 10

**Notice to Users (FCC and
Industry Canada)..... 11**
 Software Version..... 11

**Consignes de sécurité
importantes..... 12**

**Avis aux utilisateurs (FCC et
Industrie Canada)..... 13**
 Version logicielle..... 13

Computer Software Copyrights.... 14

Documentation Copyrights..... 15

Disclaimer..... 16

Getting Started..... 17

 How to Use This Guide..... 17

 Notations Used in This Manual..... 17

 Additional Performance Enhancement..... 17

 ASTRO 25 Enhanced Data..... 18

 Dynamic System Resilience (DSR).... 18

 CrossTalk Prevention..... 18

 Encrypted Integrated Data (EID)..... 18

 SecureNet..... 18

 P25 Digital Vehicular Repeater

 System (DVRS)..... 18

 Conventional Talkgroup and Radio

 Scan Enhancements..... 18

 What Your Dealer/System Administrator

 Can Tell You..... 19

Preparing Your Radio for Use.....20

Turning On the Radio.....	20
Adjusting the Volume.....	21
Validating Compatibility During Power Up.....	21

Identifying Radio Controls..... 22

Radio Parts and Controls.....	22
Control Head and Microphone.....	22
Programmable Features.....	23
Assignable Radio Functions.....	23
Assignable Settings or Utility Functions.....	26
Accessing the Preprogrammed Functions.....	26
Menu Select Buttons.....	27
Advance Programmable Buttons.....	27
Home Button.....	28
4-Way Navigation Button.....	28
Data Feature Button.....	28
Volume Knob.....	29
Using the Mode Knob.....	29
Keypad.....	29
Keypad Characters – Uppercase Mode.....	29

Keypad Characters – Lowercase Mode.....	30
Keypad Characters – Numeric Mode.....	32
Keypad Characters – Hexadecimal Mode.....	33
Push-To-Talk (PTT) Button.....	34

Identifying Status Indicators.....35

Status Icons.....	35
Text Messaging Service (TMS) Indicators.....	38
TMS Status Icons.....	38
TMS Menu Options.....	39
LED Indicator.....	40
Intelligent Lighting Indicators	41
Alert Tones.....	43

General Radio Operation.....46

Selecting a Zone.....	46
Selecting a Radio Channel.....	46
Selecting a Channel via Channel Search Button.....	47
Mode Select Feature.....	47

Saving a Zone and a Channel to a Softkey.....	48	Calling a Phone Not in the List.....	56
Saving a Zone and a Channel to a Button.....	48	Selective Call (ASTRO Conventional Only).....	56
Receiving and Responding to a Radio Call...	49	Talkgroup Call Feature (Conventional Operation Only).....	57
Receiving and Responding to a Talkgroup Call.....	49	Sending a Status Call.....	58
Receiving and Responding to a Private Call (Trunking Only).....	50	Responding to the Dynamic Regrouping Feature (Trunking Only).....	59
Receiving and Responding to a Telephone Call (Trunking Only).....	50	Dynamic Zone Programming (DZP)....	60
Methods to Make a Radio Call.....	51	Multiple Control Head Features.....	62
Making a Talkgroup Call.....	51	Setting the ID of the Initial Control Head.....	62
Making a Private Call (Trunking Only).....	52	All Active Mode.....	63
Making a Telephone Call (Trunking Only).....	53	Activating and Deactivating Intercom in All Active Mode.....	63
Switching Between Repeater or Direct Operation Button.....	54	One Active Mode.....	64
Monitor Feature.....	54	Contacts.....	65
Monitoring a Channel.....	54	Making a Private Call from Contacts...	66
Monitoring Conventional Mode.....	55	Adding a New Contact Entry.....	67
Advanced Features.....	56	Deleting a Contact Entry.....	67
Advanced Call Features.....	56	Adding a Contact to a Call List.....	68
		Methods of Contact Editing in a Call List.....	68
		Scan Lists.....	70
		Viewing a Scan List.....	70
		Editing the Scan List.....	70

Changing the Scan List Status.....	71	Sending an Emergency Call (Trunking Only).....	79
Viewing and Changing the Priority Status.....	72	Sending an Emergency Alarm with Emergency Call.....	80
Scan.....	72	Sending a Silent Emergency Alarm....	80
Turning Scan On or Off.....	72	Special Considerations for Emergencies.....	81
Turning Scan On While Disregarding the Squelch Code (Conventional Channels Only).....	73	Automatic Registration Service (ARS).....	81
Transmitting While the Scan is On.....	73	Selecting or Changing the ARS Mode.....	82
Deleting a Nuisance Channel.....	73	User Login Feature.....	83
Restoring a Nuisance Channel.....	74	Text Messaging Service (TMS).....	85
Changing Priorities Status While Scan is On.....	74	Accessing the Messaging Features....	85
Restoring Priorities in a Scan List.....	74	Composing and Sending a New Text Message.....	86
Using the Hang Up Box (HUB).....	75	Sending a Quick Text Message.....	87
Call Alert Paging.....	75	Priority Status and Request Reply of a New Text Message.....	88
Receiving a Call Alert Page.....	75	Secure Operations.....	95
Sending a Call Alert Page.....	76	Enabling Secure Transmission.....	95
Enabling and Disabling In-Call User Alert.....	77	Accessing the Secure Feature.....	96
Quick Call II (ASTRO P25 Digital Trunking and Conventional).....	78	Managing Encryption.....	96
Initiating a Quick Call II Transmission.....	78	Global Positioning System / Global Navigation Satellite System.....	101
Emergency Operation.....	78	GPS Operation.....	101
Sending an Emergency Alarm.....	79	GPS Performance Enhancement.....	102

The Outdoor Location Feature (Using GPS).....	102	Site Trunking Feature.....	114
Accessing the Outdoor Location Feature.....	103	Locking and Unlocking a Site.....	114
Turning Off GPS.....	103	Site Display and Search Button.....	114
Saving a Waypoint.....	104	Trunked Announcement.....	115
Viewing a Saved Waypoint.....	105	Ignition Switch Options.....	116
Editing the Alias of a Waypoint.....	105	Blank.....	116
Editing the Coordinates of a Waypoint.....	106	Tx Inhibit.....	116
Deleting a Single Saved Waypoint....	107	PTT Tx Inhibit.....	116
Deleting All Saved Waypoints.....	108	Required.....	116
Measuring the Distance and Bearing from a Saved Waypoint..	108	Soft Power Off.....	117
Location Feature in Emergency Mode.....	109	Ignition Only Power Up.....	117
Peer-Location on the Display (ASTRO Conventional only).....	109	Using Emergency Power Up.....	117
Geofence (ASTRO 25 Trunking System)....	110	Auto Power Off Timer.....	118
Entering the Geofence Area.....	111	Voice Announcement.....	118
Mission Critical Geofence.....	112	Site Selectable Alerts (ASTRO 25).....	119
Entering Mission Critical Geofence...	112	Sending SSA Notification to Single Site.....	120
Exiting Mission Critical Geofence....	112	Sending SSA Notification to Single Site Via Manual Entry.....	121
Trunking System Controls.....	113	Sending SSA Notification to All Sites.....	121
Operating in Failsoft System.....	113	Sending SSA Notification to All Available Sites.....	122
Out-of-Range Radio.....	113	Stopping SSA Notification of a Single Site.....	123
SmartZone.....	113	Stopping SSA Notification of a Single Site Via Manual Entry.....	123

Stopping SSA Notification of All Sites.....	124
Stopping SSA Notification of All Available Sites.....	125
Channel Change on Off Hook on All Channels.....	125
Low Voltage Threshold Warning.....	126
Wi-Fi.....	127
Turning Wi-Fi On or Off.....	127
Checking the Wi-Fi Configuration and Status of the Radio.....	128
Utilities.....	129
Viewing Recent Calls.....	129
Selecting the Power Level.....	129
Selecting a Radio Profile.....	130
Controlling the Display Backlight.....	131
Turning the Keypad Tones On or Off.....	131
Turning Voice Mute On or Off.....	132
Using the Time-Out Timer.....	132
Using Conventional Squelch Operation Features.....	132
Using the PL Defeat Feature.....	133
Digital PTT ID Support.....	134
Smart PTT Feature (Conventional Only).....	134
Transmit Inhibit.....	135

General Radio Information.....	136
External Alarms (Horn and Lights)....	139

Helpful Tips..... 142

Radio Care.....	142
Cleaning the External Surface of the Radio.....	142
Cleaning the External Plastic Surface.....	142

Accessories..... 144

Maritime Radio Use in the VHF Frequency Range..... 145

Special Channel Assignments.....	145
Emergency Channel.....	145
Non-Commercial Call Channel.....	145
Operating Frequency Requirements.....	145
Declaration of Compliance for the Use of Distress and Safety Frequencies.....	148
Technical Parameters for Interfacing External Data Sources.....	148

Glossary.....149

Limited Warranty.....155

MOTOROLA COMMUNICATION
 PRODUCTS..... 155
 I. WHAT THIS WARRANTY COVERS
 AND FOR HOW LONG:..... 155
 II. GENERAL PROVISIONS:..... 156
 III. STATE LAW RIGHTS:..... 157
 IV. HOW TO GET WARRANTY SERVICE:. 157
 V. WHAT THIS WARRANTY DOES NOT
 COVER:..... 157
 VI. PATENT AND SOFTWARE
 PROVISIONS:..... 158
 VII. GOVERNING LAW:..... 159
 VIII. For Australia Only..... 159
 SERVICE..... 160

Declaration of Conformity

This declaration is applicable to your radio only if your radio is labeled with the FCC logo shown below.

Declaration of Conformity

Per FCC CFR 47 Part 2 Section 2.1077(a)



Responsible Party

Name: Motorola Solutions, Inc.

Address: 1303 East Algonquin Road, Schaumburg, IL 60196-1078, U.S.A.

Phone Number: 1-800-927-2744

Hereby declares that the product:

Model Name: **APX Mobile**

conforms to the following regulations:

FCC Part 15, subpart B, section 15.107(a), 15.107(d) and section 15.109(a)

Class B Digital Device

As a personal computer peripheral, this device complies with Part 15 of the FCC Rules. This device complies with Industry Canada license-exempt RSS standard(s). Operation is subject to the following two conditions:

- 1 This device may not cause harmful interference, and
- 2 This device must accept any interference received, including interference that may cause undesired operation.



Note:

This equipment has been tested and found to comply with the limits for a Class B digital device, pursuant to part 15 of the FCC Rules and Industry Canada license-exempt RSS standard. These limits are designed to provide reasonable protection against harmful interference in a residential installation. This equipment generates, uses and can radiate radio frequency energy and, if not installed and used in accordance with the instructions, may cause harmful interference to radio communications. However, there is no guarantee that interference will not occur in a particular installation.

If this equipment does cause harmful interference to radio or television reception, which can be determined by turning the equipment off and on, the user is encouraged to try to correct the interference by one or more of the following measures:

- Reorient or relocate the receiving antenna.
- Increase the separation between the equipment and receiver.
- Connect the equipment into an outlet on a circuit different from that to which the receiver is connected.
- Consult the dealer or an experienced radio or TV technician for help.

Important Safety Information

RF Energy Exposure and Product Safety Guide for Mobile Two-Way Radios

ATTENTION!

This radio is restricted to Occupational use only.

Before using the radio, read the RF Energy Exposure and Product Safety Guide for Mobile Two-Way Radios which contains important operating instructions for safe usage and RF energy awareness and control for Compliance with applicable standards and Regulations.

For a list of Motorola Solutions-approved antennas and other accessories, visit the following website:

<http://www.motorolasolutions.com/APX>

Any modification to this device, not expressly authorized by Motorola Solutions, may void the user's authority to operate this device.

Under Industry Canada regulations, this radio transmitter may only operate using an antenna of a type and maximum (or lesser) gain approved for the transmitter by Industry Canada. To reduce potential radio interference to other users, the antenna type

and its gain should be so chosen that the equivalent isotropically radiated power (e.i.r.p.) is not more than that necessary for successful communication.

This radio transmitter has been approved by Industry Canada to operate with Motorola Solutions-approved antenna with the maximum permissible gain and required antenna impedance for each antenna type indicated. Antenna types not included in this list, having a gain greater than the maximum gain indicated for that type, are strictly prohibited for use with this device.



Note:

Setting up the radio as an RF Modem takes complete control of the radio. In this mode, the radio no longer responds to button and **PTT** presses nor will it unmute to voice activity. This mode is designed to receive and pass specifically formatted over the air data to a tethered computer with RF modem enabled applications. This mode can only be exit by reprogramming the radio with Customer Programming Software (CPS) to not operate in RF modem mode and cycling power.

Notice to Users (FCC and Industry Canada)

This device complies with Part 15 of the FCC rules and Industry Canada's license-exempt RSS's per the following conditions:

- This device may not cause harmful interference.
- This device must accept any interference received, including interference that may cause undesired operation.
- Changes or modifications made to this device, not expressly approved by Motorola, could void the authority of the user to operate this equipment.

Software Version

All the features described in the following sections are supported by the software version **R15.00.00** or later.

See [Accessing the Radio Information](#) on page 137 to determine the software version of your radio.

Check with your dealer or system administrator for more details of all the features supported.

Consignes de sécurité importantes

Radios bidirectionnelles mobiles : exposition aux radiofréquences et sécurité du produit

ATTENTION!

Cette radio ne doit être utilisée qu'à des fins professionnelles. Avant d'utiliser la radio, lisez le guide Radios bidirectionnelles mobiles : exposition aux radiofréquences et sécurité du produit, qui contient d'importantes instructions de fonctionnement pour une utilisation sécuritaire et des informations sur l'exposition aux fréquences radioélectriques, dans le but d'assurer votre conformité aux normes et règlements en vigueur.

Visitez le site Web suivant pour obtenir la liste des antennes et des autres accessoires approuvés par Motorola :

<http://www.motorolasolutions.com/APX>

Selon la réglementation d'Industrie Canada, cet émetteur radio ne peut être utilisé qu'avec une antenne dont le type et le gain maximal (ou minimal) sont approuvés par Industrie Canada pour cet émetteur. Afin de limiter les interférences radio pour

les autres utilisateurs, le type et le gain de l'antenne doivent être choisis de façon à ce que la puissance isotrope rayonnée équivalente (P.I.R.E.) ne soit pas plus forte qu'il ne le faut pour établir la communication.

Cet émetteur radio a été approuvé par Industrie Canada pour utilisation avec une antenne approuvée par Motorola offrant le gain maximal autorisé et l'impédance requise pour le type d'antenne indiqué. Il est strictement interdit d'utiliser avec cet appareil tout type d'antenne ne figurant pas dans cette liste et présentant un gain supérieur au maximum indiqué pour le type.

Avis aux utilisateurs (FCC et Industrie Canada)

Cet appareil est conforme à la partie 15 des règles de la FCC et d'Industrie Canada permis exemptés RSS de par la conditions suivantes:

- Ce dispositif ne doit pas causer d'interférences nuisibles.
- Cet appareil doit accepter toute interférence reçue, y compris les interférences qui peuvent perturber le fonctionnement.
- Les changements ou les modifications apportées à ce dispositif, non expressément approuvées par Motorola, peuvent annuler le droit de l'utilisateur à utiliser cet équipement.

Version logicielle

Toutes les fonctions décrites dans les sections suivantes sont prises en charge par la version **R15.00.00** ou les versions ultérieures du logiciel de la radio.

Pour obtenir davantage de renseignements à propos des fonctions prises en charge, adressez-vous à votre détaillant ou à votre administrateur de système.

Computer Software Copyrights

The Motorola products described in this manual may include copyrighted Motorola computer programs stored in semiconductor memories or other media. Laws in the United States and other countries preserve for Motorola certain exclusive rights for copyrighted computer programs including, but not limited to, the exclusive right to copy or reproduce in any form the copyrighted computer program. Accordingly, any copyrighted Motorola computer programs contained in the Motorola products described in this manual may not be copied, reproduced, modified, reverse-engineered, or distributed in any manner without the express written permission of Motorola. Furthermore, the purchase of Motorola products shall not be deemed to grant either directly or by implication, estoppel, or otherwise, any license under the copyrights, patents or patent applications of Motorola, except for the normal non-exclusive license to use that arises by operation of law in the sale of a product.

Documentation Copyrights

No duplication or distribution of this document or any portion thereof shall take place without the express written permission of Motorola. No part of this manual may be reproduced, distributed, or transmitted in any form or by any means, electronic or mechanical, for any purpose without the express written permission of Motorola.

Disclaimer

The information in this document is carefully examined, and is believed to be entirely reliable. However, no responsibility is assumed for inaccuracies. Furthermore, Motorola reserves the right to make changes to any products herein to improve readability, function, or design. Motorola does not assume any liability arising out of the applications or use of any product or circuit described herein; nor does it cover any license under its patent rights, nor the rights of others.

Getting Started

How to Use This Guide

This User Guide covers the basic operation of the APX Mobiles.

However, your dealer or system administrator may have customized your radio for your specific needs. Check with your dealer or system administrator for more information.

Notations Used in This Manual

Throughout the text in this publication, you will notice the use of **Warning**, **Caution**, and **Note**. These notations are used to emphasize that safety hazards exist, and the care that must be taken or observed.



Warning:

An operational procedure, practice, or condition and so on, which may result in injury or death if not carefully observed.



Caution:

An operational procedure, practice, or condition and so on, which may result in



damage to the equipment if not carefully observed.



Note:

An operational procedure, practice, or condition and so on, which is essential to emphasize.

The following special notations identify certain items.

Example	Description
Home button or 	Buttons and keys are shown in bold print or as an icon.
PHONE	Menu entries are shown similar to the way they appear on the display of the radio.
	This means "Press the right side of the 4-Way Navigation Button".

Additional Performance Enhancement

The following performance enhancements are some of the latest creations designed to enhance the security, quality and efficiency of the radios.

ASTRO 25 Enhanced Data

ASTRO 25 Enhanced Data is optimized to handle different message sizes and variable update rates from different applications of the radio. Add Enhanced Data to the Integrated Data system with a software installation to improve data channel efficiency and enable denser network traffic.

Dynamic System Resilience (DSR)

DSR ensures the radio system is seamlessly switched to a backup master site dynamically in case of system failure. DSR also provides additional indication e.g. failure detection, fault recovery, and redundancy within the system to address to the user in need. Mechanisms related to the Integrated Voice and Data (IV&D) or data centric are all supported by DSR.

CrossTalk Prevention

This feature prevents crosstalk scenarios from happening, especially when a wideband antenna is used. This feature allows the adjustment of the internal SSI clock rate of the radio. This subsequently reduces the possibility of radio frequency interfering spurs and prevents the issues of crosstalk.

Encrypted Integrated Data (EID)

EID provides security encryption and authentication of IV&D data bearer service communication between the radio and the Customer Enterprise Network.

SecureNet

SecureNet allows user to perform secured communications on an Analog or Motorola Data Communication (MDC) channel. The MDC Over-the-Air Rekeying (OTAR) feature will allow users to perform OTAR activities on an MDC channel.

P25 Digital Vehicular Repeater System (DVRS)

Motorola Solutions offers an MSI Certified APX compatible, 3rd Party, P25 Digital Vehicular Repeater System (DVRS) that provides low cost portable radio coverage in areas where only mobile radio coverage is available and portable radio coverage is either intermittent or non-existent.

Conventional Talkgroup and Radio Scan Enhancements

A few enhancements have been made to the Conventional Talkgroup at the system. These enhancements improve the Scan feature operation significantly when multiple agencies are using a

single conventional radio frequency channel. These enhancements allow users to use Selective Squelch to operate on only the subset of talkgroups that are relevant to the users rather than all talkgroups on the channel. These Scan improvements have been made to eliminate the audio holes that were present and to turn on the busy LED when activity is present on the channel. Mixed Vote Scan and Standard Conventional Scan configurations are supported. Priority Operation is also supported.

Up to 30 different talkgroups can be supported using conventional channels. A maximum of four talkgroups can be supported when Vote Scan channels are being used.

Smart **PTT** is supported with this enhancement as Smart **PTT** prevents users from transmitting while other users are on the channel.

**Note:**

User Selectable Talkgroups are not compatible with this Conventional Talkgroup Enhancement.

What Your Dealer/System Administrator Can Tell You

Check with your dealer or system administrator, if the radio is to be operated in extremely cold temperatures (less than -30 °C or more than +60 °C), for the correct radio settings to ensure proper operation.

You can consult your dealer or system administrator about the following:

- Is your radio programmed with any preset conventional channels?
- Which buttons have been programmed to access other features?
- What optional accessories may suit your needs?

**Note:**

Specifications may vary for different radio models. Check with your dealer or system administrator for more information.

Preparing Your Radio for Use

This section provides simple instructions to prepare your radio for use.

Turning On the Radio

- 1 Press the **Power On/Off Button**  briefly to power on the radio.

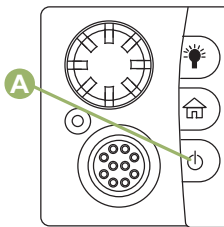

After a short time, the red, yellow and green LEDs light up. The display then shows Zone and channel text, and menu items display on the screen.

The backlight turns on to the last selected dim level.



Note:

Pressing the **Power On/Off Button** before the LED lights up will be ignored.

If FAIL ##/## appears in the display, the radio will not function until the condition has been corrected.

If ERROR ##/## appears, some non-critical data has been changed. If either of these displays appear, if the display goes blank, or if the unit appears to be locked up, see [Helpful Tips](#) on page 142 for more information.

If CH MISMATCH appears, means that either the Control Head has been connected to an incompatible transceiver, or vice versa.

If your radio does not power up, contact your dealer.

- 2 To turn off the radio, press the **Power On/Off Button** after the LEDs light up.



Note:

The duration that user must press and hold the **Power On/Off Button** to turn off the

radio is programmable by a qualified radio technician.

Adjusting the Volume

- 1 To increase the volume, rotate the **Volume Knob** Ⓐ clockwise.

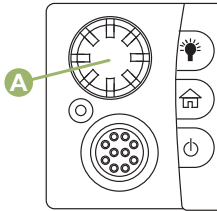

- 2 To decrease the volume, rotate this knob counterclockwise.
-

Validating Compatibility During Power Up

The radio validates and updates the software and hardware of your control head(s) during power up. During validation, the display shows `MAINTENANCE MODE REMOTE DEVICE`; promptly followed by other maintenance statuses.

Press the **Power On/Off** Button to reset when the display shows `UPDATE DONE PLEASE RESET` upon completion, or when the display shows `UPDATE FAILED PLEASE RESET` when it fails to update.

If the software updates are complete, the radio runs the usual power up operation.

If the updates are incomplete, the radio runs the Maintenance Mode and the display shows `MAINTENANCE MODE REMOTE DEVICE`; promptly followed by other maintenance statuses again.



Note:

If `SW INCOMPLETE` appears, use Flashport Recovery Tool to update the control heads before you power on the radio again.

Identifying Radio Controls

Radio Parts and Controls

Control Head and Microphone

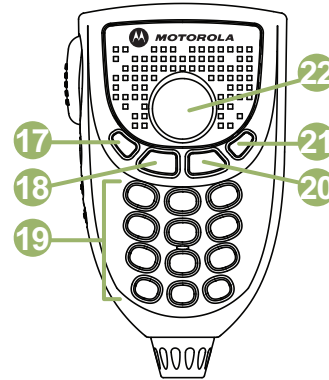
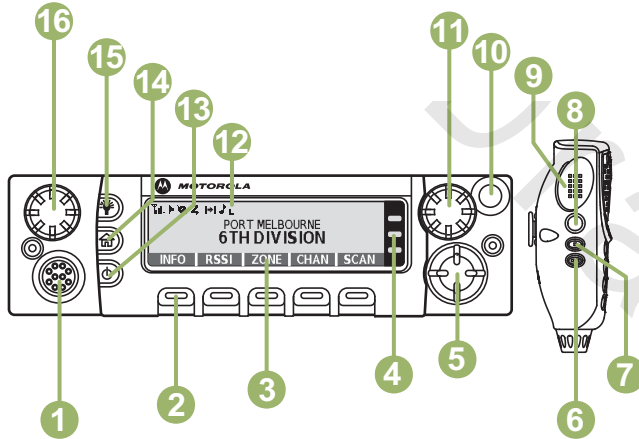

Note:

The microphone is not part of a radio. It is an optional accessory.

1	Accessory Port (Microphone)
2	Menu Select Button ^[1]
3	Menu Entries
4	LED Indicators
5	Navigation Button
6	Accy 2-Dot Button ^[1]
7	Accy 1-Dot Button ^[1]

8	Accy No-Dot Button (Purple) ^[1]
9	Push-to-Talk (PTT) Button
10	Orange Button ^[1]
11	Mode Knob
12	Indicators
13	Power On/Off Button
14	Home Button
15	Dim Button
16	Volume Knob
17	Data Feature Button ^[1]
18	Home Button (Microphone)
19	Keypad Buttons
20	Okay/Select Button (✓)
21	Cancel Button (X)
22	Navigation Button (Microphone)

¹ These radio controls/buttons are programmable.

Programmable Features

Any reference in this manual to controls that are preprogrammed means that a qualified radio technician must use the radio programming software to assign a feature to a control.

Your dealer can program the programmable buttons as shortcuts to radio functions or preset channels/groups depending on the duration of a button press:

Press Pressing and releasing rapidly.

Long press Pressing and holding for the preprogrammed duration (between 0.25 seconds and 3.75 seconds).

Hold down Keeping the button pressed.

Assignable Radio Functions

Call Alert Allows the radio to function like a pager, or to verify if a radio is active on the system.

Call Response	Allows you to answer a private call or phone call.	Internet Protocol Address	Display the Internet Protocol (IP) address, device name and status of the radio.
Channel	Selects a channel.	Location	Determines the current location (latitude, longitude, time and date), and also the distance and bearing to another location. Or, turns the GPS functionality on or off for all locations.
Contacts	Selects the Contacts menu.	Message	Enters the current message list.
Dynamic ID (Conventional Only)	Allows you to edit the ASTRO Individual ID and/or MDC Primary ID of the radio.	Monitor (Conventional Only)	Monitors a selected channel for all radio traffic until function is disabled.
Dynamic Priority (Conventional Only)	Allows any channel in a Scan List (except for the Priority-One channel) to temporarily replace the Priority-Two channel.	Multiple Private Line (Conventional Only)	Selects the Multiple Private Line lists.
Emergency	Depending on the programming, initiates or cancels an emergency alarm or call.	Nuisance Delete	Temporarily removes an unwanted channel, except for priority channels or the designated transmit channel from the scan list.
Information	Displays the information of the radio.		
Intercom	Enables users of multiple control heads to talk to each other via the control heads in a multi-control head setup.		

	Launches a specific feature with one single button-press. You can setup as many as four separately programmed buttons for four different features.		
Phone	Allows you to make and receive calls similar to standard phone calls.	Reprogram Request (Trunking Only)	Notifies the dispatcher you want a new dynamic regrouping assignment.
Private Call (Trunking Only)	Allows a call from an individual radio to another individual radio.	Request-To-Talk (Conventional Only)	Notifies the dispatcher you want to send a voice call.
Radio Profiles	Allows easy access to a set of preprogrammed visual and audio settings of the radio.	Scan	Toggles scan on or off.
Recent Calls	Allows easy access to the list of calls recently received or made.	Scan List Programming	Selects the scan list for editing (by long press on the Scan button).
Rekey Request	Notifies the dispatcher you want a new encryption key.	Secure/Clear	Toggles secure transmission on or off.
Repeater Access Button (RAB) (Conventional Only)	Allows user to manually send a repeater access codeword.	Selective Call (Conventional Only)	Calls an assigned radio.
		Siren	Turns different Siren Tones on or off.
		Site Display/Search (Trunking Only)	Displays the current site ID and RSSI value; performs site search for Automatic Multiple Site Select (AMSS) or SmartZone operation.

Site Lock/Unlock (Trunking Only)	Locks onto a specific site.
Status (Astro 25 Trunking Only)	Sends data calls to the dispatcher about a predefined status.
Talkaround/Direct (Conventional Only)	Toggles between using a repeater and communicating directly with another radio.
Talkgroup (Conventional Only)	Allows a call from an individual radio to a group of radios.
Text Messaging Service (TMS)	Selects the text messaging menu.
TMS Quick Text	Selects a predefined message.
User	Automatically registers with the server.
Zone Down	Toggles downward through the zones in the radio.
Zone Select	Allows selection from a list of zones.
Zone Up	Toggles upward through the zones in the radio.

Assignable Settings or Utility Functions

Dim	Changes the display brightness.
Front/Rear	Switches one of two control heads to be active at one time.
Horns/Lights	Toggles horns and lights feature on or off.
Keypad Lock	Toggles the keypad lock on or off.
Low Power	Toggles transmit power level between high and low.
Voice Announcement	Audibly indicates the current feature mode, Zone or Channel the user has just assigned.
Voice Mute	Toggles voice mute on or off.

Accessing the Preprogrammed Functions

You can access various radio functions through one of the following methods.

- A short or long press of the relevant programmable buttons.
-
- Use the **Menu Select Button** ().
-

Menu Select Buttons



Note:

Check with your dealer or system administrator for the list of features activated in your radio.

Use the **Menu Select** button  to access the menu entry of your radio feature. Your radio may be preprogrammed differently from the following example, but the steps for selecting a channel may appear as shown below:

Press the **Menu Select** button () directly below **CHAN.**

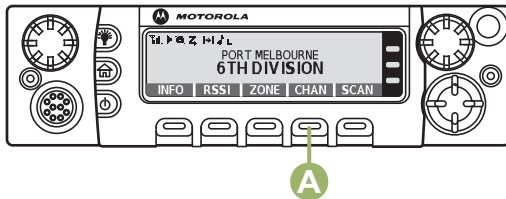

Advance Programmable Buttons

This feature is to help you to shorten the process of applying certain common features.

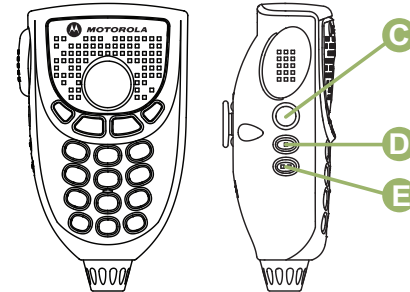
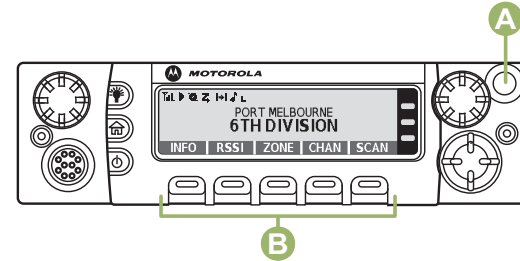



- A Orange Button^[2]
- B Menu Select Buttons^[2]

- C Accy No-Dot Button (Purple)^[2]
- D Accy 1-Dot Button^[2]
- E Accy 2-Dot Button^[2]

**(Quick Access)
One Touch Button**

Enters a menu with a short press on the preprogrammed One Touch button. Features assigned to these buttons are Call, Call Alert, Phone, Repeater Access, MDC RTT Button Access, Status and Message.

Home Button

Pressing the  button returns you to the Home (default) screen. In most cases, this is the current mode. For selected radio features, the  button is also used to save user-edited radio settings or information before returning you to the Home screen.



Note:

Some features do not require you to press  to go to the Home screen. Refer to the individual feature sections in this manual for

further details on saving user-edited radio settings or information.

The  button also can revert to home channel from any other zone and mode in the radio. Check with your dealer or system administrator for more information.

4-Way Navigation Button

Use the **4-Way Navigation Button** to scroll up, down, left or right with one of the following methods.

- Press and release one of the button to scroll from one entry to the next one.
- Press and hold one of the button to have the radio toggles through the list automatically (release the button to stop).

Data Feature Button

Use **Data Feature** button to access data-related features, such as the Text Messaging Service (TMS) feature screen.

² These programmable buttons support the **One Touch Button** feature.

Volume Knob

Use this **Volume Knob** to adjust the volume of the speakers by turning it clockwise or counterclockwise.

Using the Mode Knob

Use this **Mode Knob** to scroll through the channels by turning it clockwise or counterclockwise.

The keypad functions in a manner similar to a standard telephone keypad when entering numeric digits. When the keypad is used to edit a list, each key can generate different characters of the alphabet. The following tables show the number of times a key needs to be pressed to generate the required character.

Keypad

You can use the 3 x 4 alphanumeric keypad on the keypad microphone to access your radio's features.

Keypad Characters – Uppercase Mode

Key	Number of Times Key is Pressed																				
	1	2	3	4	5	6	7	8	9	10	11	12	13	14	15	16	17	18	19	20	21
①	1	.	,	?	!	;	@	_	-	*	#	&	\$	/	+	=	\	"	'	()
② abc	A	B	C																		
③ def	D	E	F																		
④ ghi	G	H	I																		

Key	Number of Times Key is Pressed																				
	1	2	3	4	5	6	7	8	9	10	11	12	13	14	15	16	17	18	19	20	21
<input type="radio"/> 5 jkl	J	K	L																		
<input type="radio"/> 6 mno	M	N	O																		
<input type="radio"/> 7 pqrs	P	Q	R	S																	
<input type="radio"/> 8 tuv	T	U	V																		
<input type="radio"/> 9 wx yz	W	X	Y	Z																	
<input type="radio"/> 0	Toggle between mixed case mode, uppercase mode and lowercase mode.																				
<input type="radio"/> *	Space																				
<input type="radio"/> #	Toggle between numeric and letter mode.																				

Keypad Characters – Lowercase Mode

Key	Number of Times Key is Pressed																				
	1	2	3	4	5	6	7	8	9	10	11	12	13	14	15	16	17	18	19	20	21
<input type="radio"/> 1	1	.	,	?	!	;	@	_	-	*	#	&	\$	/	+	=	\	"	'	()

Key	Number of Times Key is Pressed																				
	1	2	3	4	5	6	7	8	9	10	11	12	13	14	15	16	17	18	19	20	21
2 abc	a	b	c																		
3 def	d	e	f																		
4 ghi	g	h	i																		
5 jkl	j	k	l																		
6 mno	m	n	o																		
7 pqrs	p	q	r	s																	
8 tuv	t	u	v																		
9 wx yz	w	x	y	z																	
0	Toggle between mixed case mode, uppercase mode and lowercase mode.																				
*	Space																				
#	Toggle between numeric and letter mode.																				

Keypad Characters – Numeric Mode

Key	Number of Times Key is Pressed																				
	1	2	3	4	5	6	7	8	9	10	11	12	13	14	15	16	17	18	19	20	21
1	1	.	,	?	!	;	@	_	-	*	#	&	\$	/	+	=	\	“	’	()
2 abc	2																				
3 def	3																				
4 ghi	4																				
5 jkl	5																				
6 mno	6																				
7 pqrs	7																				
8 tuv	8																				
9 wx yz	9																				
0	0																				
*	Space																				
#	Toggle between numeric and letter mode.																				

Keypad Characters – Hexadecimal Mode

Key	Number of Times Key is Pressed																				
	1	2	3	4	5	6	7	8	9	10	11	12	13	14	15	16	17	18	19	20	21
1	1																				
2 abc	2	A	B	C																	
3 def	3	D	E	F																	
4 ghi	4																				
5 jkl	5																				
6 mno	6																				
7 pqrs	7																				
8 tuv	8																				
9 wx yz	9																				
0	0																				
*	Not applicable																				
#	Not applicable																				

Push-To-Talk (PTT) Button

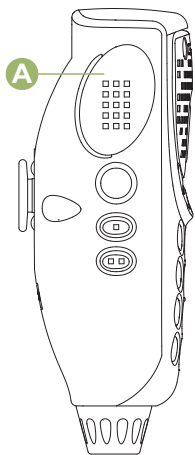

The **PTT** button **A** on the side of the microphone serves two basic purposes:

- While a call is in progress, the **PTT** button allows the radio to transmit to other radios in the call.





Press and hold down **PTT** button to talk. Release the **PTT** button to listen. The microphone is activated when the **PTT** button is pressed.

- While a call is not in progress, the **PTT** button is used to make a new call. See [Methods to Make a Radio Call](#) on page 51 for more information.

Identifying Status Indicators

Status Icons

The liquid crystal display (LCD) of your radio shows the radio status, text entries, and menu entries. The following are the icons that appear on the display of the radio.

	<p>Receiving</p> <p>Radio is receiving a call or data.</p>
	<p>Transmitting</p> <p>Radio is transmitting a call or data.</p>
	<p>Received Signal Strength Indicator (RSSI)</p> <p>The number of bars displayed represents the received signal strength for the current site, for trunking only. The more stripes in the icon, the stronger the signal.</p>
	<p>Direct</p>

On – Radio is currently configured for direct radio-to-radio communication (during conventional operation only).

Off – Radio is connected with other radios through a repeater.



Monitor (Carrier Squelch)

Selected channel is being monitored (during conventional operation only).



In-Call User Alert





On – The feature is enabled. Voice muting of the affiliated trunking talkgroup or selected conventional channel is activated.



Off – The feature is disabled. Voice muting of the affiliated trunking talkgroup or selected conventional channel is deactivated.













Power Level

L – Radio is set at Low power.

	H – Radio is set at High power.
	Scan Radio is scanning a scan list.
	Priority Channel Scan Blinking dot – Radio detects activity on channel designated as Priority-One. Steady dot – Radio detects activity on channel designated as Priority-Two.
	Vote Scan Enabled The vote scan feature is enabled.
	Secure Operation On – Secure operation. Off – Clear operation. Blinking – Receiving an encrypted voice call.
	AES Secure Operation

	On – AES secure operation. Off – Clear operation. Blinking – Receiving an encrypted voice call.
	GPS Signal On – Feature is enabled and signal is available. Off – Feature is disabled. Blinking – Feature is enabled, but no signal is available.
	User Login Indicator (IP Packet Data) On – User is currently associated with the radio. Off – User is currently not associated with the radio. Blinking – Device registration or user registration with the server failed due to an invalid username or pin.

	Inverted – User successfully login to the secured IP Packet Data.
	Data Activity Data activity is present.
	Hexadecimal Indicates that the text entry is currently in hexadecimal mode.
	Numeric Indicates that the text entry is currently in numeric mode.
	Start Case Indicates that the first character of the text entry is capitalized.
	Mixed Case Indicates that the text entry is currently in normal text mode.
	Uppercase

	Indicates that the text entry is currently in uppercase mode.
	Lowercase Indicates that the text entry is currently in lowercase mode.
	Lowercase Predictive Indicates that the text entry is currently in lowercase and with predicted words shown at the bottom of the screen.
	Mixedcase Predictive Indicates that the text entry is currently in mixed case and with predicted words shown at the bottom of the screen.
	Uppercase Predictive Indicates that the text entry is currently in uppercase and with predicted words shown at the bottom of the screen.



The radio Wi-Fi® network is connected. The number of bars displayed represents the signal strength of the Wi-Fi signal.

Text Messaging Service (TMS) Indicators

This feature allows you to send and receive text messages. Status icons and menu options shown here help you to work more efficiently with TMS feature. See [Text Messaging Service \(TMS\)](#) on page 85 for more information.

TMS Status Icons

The following icons appear on the radio's display when you send and receive text messages.



Inbox Full

The Inbox is full.



Message Sent

The text message is sent successfully.



Message Unsent

The text message cannot be sent.



Unread Message

- User receives a new message.
- The selected text message in the Inbox has not been read.



Read Message

The selected text message in the Inbox has been read.



Normal Message

User is composing a message with normal priority and without a request for a reply.



Message Index

Indicates the index of the current message the user is viewing.

Example: If the user is looking at the third message out of a total of 6 messages in

the Inbox folder, the icon is displayed as the icon on the left column.

Priority Status



- The “Priority” feature is toggled on before the message is sent.
- Messages in the Inbox folder are flagged with “Priority”.

Request Reply



- The “Request Reply” feature is toggled on before the message is sent.
- Messages in the Inbox folder are flagged with “Request Reply”.

Priority Status and Request Reply



- User is composing a message with a priority status and a request for a reply.
- Messages in the Inbox folder are flagged with “Priority” and “Request Reply”.

TMS Menu Options

Menu Option	Description/Function
INBX	Brings you to your incoming messages screen.
COMP	Brings you to the compose screen.
DRFT	Brings you to the saved message screen.
BACK	Brings you back to the previous screen.
SAVE	Saves the messages you have edited to the Draft folder.
SENT	Brings you to the sent messages screen.
NEW	Creates a new message.
LIST	Brings you to the predefined messages screen.
IMPT	Toggles the “Priority Status” icon on or off for an outgoing message.
RORP	Toggles “Request Reply” icon on or off for an outgoing message.

Menu Option	Description/Function
CURR	Deletes the current selected message.
ALL	Selects to delete all the messages in the current folder.
DEL	Deletes a message or text.
EDIT	Edits a draft message or key in a target address.
EXIT	Exits to the Home screen.
NO	Cancel the delete all messages options.
OPTN	Brings you to the Options main screen.
RPLY	Replies to a message.
SEL	Selects a predefined message or address.
SEND	Sends the message.
YES	Deletes all the messages in the current folder.

LED Indicator

The LED indicator shows the operational status of your radio.

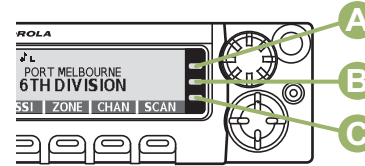

A	Red LED
B	Yellow LED
C	Green LED

Solid red

Radio is transmitting.

Rapidly blinking red

Radio has failed the self test upon powering up or encountered a fatal error.

Solid yellow (Conventional Only)

Channel is busy.

Blinking yellow Radio is receiving a secured transmission.

Solid green Radio is powering up, or is on a non-priority channel while in the Scan List Programming mode.

Blinking green Radio is receiving an individual or telephone call, or is on a Priority-Two channel while in the Scan List Programming mode.

Rapidly blinking green

Radio is on a Priority-One channel while in the Scan List Programming mode.

Intelligent Lighting Indicators

This feature temporarily changes the display backlight color and the alert text background color of the radio to help signal that a radio event has occurred.



Note:

This feature must be preprogrammed by a qualified radio technician.

Backlight and Bar Color	Notification	When
Orange	Emergency Alerts	The radio initiates an emergency alarm or call.
		The radio receives an emergency alarm or call.

Backlight and Bar Color	Notification	When
Red	Critical Alerts	The radio battery is low.
		The radio is out of range.
		The radio enters Failsoft mode.
		The radio is unable to establish a full connection with the system.
		The radio is unable to authenticate or register with the system.
		The radio lost GPS signal or GPS function fails.
Green	Call Alerts	The radio receives a private call.
		The radio receives a phone call.
		The radio receives a call alert.
		The radio receives a selective call.
		The radio enters Geofence.

Alert Tones

Your radio uses alert tones to inform you of the condition of your radio. The following table lists these tones and when they occur.

You Hear	Tone Name	Heard
Short, Low-Pitched Tone	Radio Self Test Fail	When radio fails its power-up self test.
	Reject	When an unauthorized request is made.
	Time-Out Timer Warning	Four seconds before time out.
	No ACK Received	When radio fails to receive an acknowledgment.
	Individual Call Warning Tone	When radio is in an individual call for greater than 6 seconds without any activity.
Long, Low-Pitched Tone	Time-Out Timer Timed Out	After time out.
	Talk Prohibit/PTT Inhibit	(When PTT button is pressed) transmissions are not allowed.
	Lack of Voice PTT Time out	When the radio ends your call after it detected there are lack of voice for 5 seconds after the PTT is pressed and hold. Your radio ends the call to enable your radio to receive calls from other radio users.
	Out of Range	(When PTT button is pressed) the radio is out of range of the system.
	Invalid Mode	When radio is on an unprogrammed channel.

You Hear	Tone Name	Heard
A Group of Low-Pitched Tones	Busy	When system is busy.
	Valid Key-Press	When a correct key is pressed.
Short, Medium-Pitched Tone	Radio Self Test Pass	When radio passes its power-up self test.
	Clear Voice	At beginning of a non-coded communication.
	Priority Channel Received	When activity on a priority channel is received.
	Emergency Alarm /Call Entry	When entering the emergency state.
	Central Echo	When central controller has received a request from a radio.
	Volume Set	When volume is changed on a quiet channel.
Long, Medium-Pitched Tone	Emergency Exit	When exiting the emergency state.
	Failsoft	When the trunking system fails.
A Group of Medium-Pitched Tones	Automatic Call Back	When voice channel is available from previous request.
	Keyfail	When encryption key has been lost.
	Console Acknowledge	When status, emergency alarm, or reprogram request ACK is received.

You Hear	Tone Name	Heard
	Received Individual Call	When Call Alert or Private Call is received.
	Call Alert Sent	When Call Alert is received by the target radio.
	Site Trunking	When a SmartZone trunking system fails.
Short, High-Pitched Tone (Chirp)	Low-Battery Chirp	When battery is below preset threshold value.
Two High-Pitched Tones	GPS Fails	When the GPS signal is lost or when GPS fails.
Ringling	Fast Ringing	When system is searching for target of Private Call.
	Enhanced Call Sent	When waiting for target of Private Call to answer the call.
	Phone Call Received	When a land-to-mobile phone call is received.
Gurgle	Dynamic Regrouping	(When PTT button is pressed) a dynamic ID has been received.
	Talk Permit	(When PTT button is pressed) is verifying with the system for accepting its transmissions.
Unique, Low-Pitched Chirp	New Message	When a new message is received.
Unique, High-Pitched Chirp	Priority Status	When a priority message is received.

General Radio Operation

Selecting a Zone

Your radio must be preprogrammed to allow you to use this feature.

A zone is a group of channels. The following methods are options on how to select a radio zone. The result of all the methods is the same. You can use the options interchangeably depending on your preference and the programmed functions.

- Select a zone via the **Mode Knob**:
 - a) Rotate the **Mode Knob** until the display shows the desired zone.
- Select a zone via the radio menu ZONE:
 - a) ◀ or ▶ to ZONE and press the **Menu Select** button directly below ZONE.
 - b) ◀ or ▶ to the required zone, or use the keypad to enter the zone number.
 - c) Press  or the **PTT** button to confirm the selected zone number.

- d) Press the **PTT** button to transmit on the displayed zone channel.

Selecting a Radio Channel

A channel is a group of radio characteristics, such as transmit/ receive frequency pairs. The following methods are options on how to select a radio channel. The result of all the methods is the same. You can use the options interchangeably depending on your preference and the programmed functions.

- Select a channel via the **Mode knob**:
 - a) Rotate the **Mode knob** until the display shows the desired channel.
 - b) Press the **PTT** button to begin transmitting on the displayed channel.
- Select a channel via the radio menu CHAN:
 - a) ◀ or ▶ to CHAN.
 - b) Press the **Menu Select** button directly below CHAN.
 - c) ◀ or ▶ to the required channel.
 - d) Press the **Menu Select** button directly below SEL to confirm the selected channel.

- e) Press the **PTT** button to transmit on the displayed zone channel.

To exit this procedure, press the **Menu Select** button directly below **CNCL**.

Selecting a Channel via Channel Search Button

This feature allows you to do a quick search for a specific channel in your radio by keying in the alias of the channel. If the name matches, your radio prompts the first found matched channel name.

- 1 Perform one of the following actions:
 - Press the preprogrammed **Channel Search** button.
 - **◀** or **▶** to **CHSR** and press the **Menu Select** button directly below **CHSR**.

A blinking cursor appears on the **Channel Search** screen.

- 2 Use the **keypad** to type or edit your channel name.
- 3 To initiate searching, press the **Menu Select** button directly below **CHSR** once the entry is done.

The display shows **SEARCHING**. Once found, the display shows the matched channel name and the radio changed its transmission to the selected channel.

If the radio is triggered to search for an empty entry, the display shows **INVALID ENTRY**. Repeat step 2 to search again.

If the entry does not match, the display shows **CHANNEL NAME NOT FOUND**. Repeat step 2 to search again; or press **⏏** or the **Menu Select** button directly below **EXIT** to exit.

Mode Select Feature

Mode Select allows a long press to save the current zone and channel of your radio to a programmable button, keypad button, or a softkey; then once programmed, the short-press of that button or softkey changes the transmission to the saved zone and channel.

There are two methods to save the selected zone and channel:

- Softkeys
- Programmable buttons and keypad buttons (digit 0 to 9)



Note:

Your radio must be preprogrammed to allow you to use this feature.

Saving a Zone and a Channel to a Softkey

Five softkeys are available for you to save the frequently used zone and channel.

- 1 Toggle your zone and channel to the required zone and channel.

- 2 ◀|▶ to MS1, MS2 ... or MS5.

- 3 Press and hold the **Menu Select** button directly below one of the softkey (MS1 – MS5).

You hear a short, medium-pitched tone when the zone and channel is saved.



Note:

To change the programmed zone and channel, repeat this procedure.

Short press of the programmed softkey changes your current transmission to the zone and channel programmed in this softkey.

Saving a Zone and a Channel to a Button

You can save the frequent used zone and channel to the programmable buttons and keypad digit 0 to 9 buttons.

- 1 Toggle your zone and channel to the required zone and channel.

- 2 Press and hold the button you desire to program.

You hear a short, medium-pitched tone when the zone and channel is saved.



Note:

Repeat this procedure to change the zone and channel of the programmed button.

Short press of the programmed button changes your current transmission to the zone and channel programmed in this button.

Receiving and Responding to a Radio Call

Once you have selected the required channel and/or zone, you can proceed to receive and respond to calls.

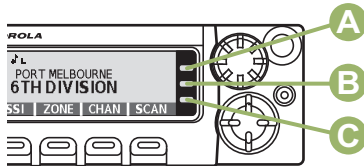

A	Red LED
B	Yellow LED
C	Green LED

The LED lights up solid red while the radio is transmitting. In conventional mode, the LED lights up solid yellow when the radio is receiving a transmission. In trunking mode, there is no LED indication when the radio receives a transmission.

If the radio is receiving a secure transmission, the LED blinks yellow.

Receiving and Responding to a Talkgroup Call

To receive a call from a group of users, your radio must be configured as part of that talkgroup.

When you receive a talkgroup call (while on the Home screen) the radio triggers for your attention with one of the following scenarios depending on the system your radio is configured:

- For ASTRO Conventional system, the LED lights up solid yellow. The display shows the talkgroup alias or ID, and the caller alias or ID.
- For Trunking system, the display shows the caller alias or ID.

- 1 Hold the microphone vertically 1 to 2 inches (2.5 to 5.0 cm) from your mouth.
- 2 Press the **PTT** button to respond to the call. The LED lights up solid red.
- 3 Release the **PTT** button to listen.

See also [Making a Talkgroup Call](#) on page 51 for details on making a Talkgroup Call.

Receiving and Responding to a Private Call (Trunking Only)

A Private Call is a call from an individual radio to another individual radio.

The one-to-one call between the two radios are not heard by the others in the current talkgroup. The calling radio automatically verifies that the receiving radio is active on the system and can display the caller ID.



Note:

With the inactivity timer enabled (optional), when there is no response from the receiving radio, the calling radio exits the call with Menu Inactive Exit tone after the timer expires.

When you receive a Private Call, you hear two alert tones and the LED blinks green. The display shows CALL RECEIVED and the caller alias or ID.

- 1 Press the **Menu Select** button directly below RESP within 20 seconds after the call indicators begin. If the caller alias is in the call list, the display shows the caller alias during the call.

If the caller name is not in the call list, the display shows the caller ID.

- 2 Press and hold the **PTT** button to talk. Release the **PTT** button to listen.

- 3 Press  to hang up and return to the Home screen.



Note:

If you press **PTT** button before pressing the **Menu Select** button directly below RESP, your conversation will be heard by all members of the talk group.

If 20 seconds pass before you press the **Menu Select** button directly below the RESP, you will not respond privately to the call just received. Instead, you initiate a Private Call.

See also [Making a Private Call \(Trunking Only\)](#) on page 52 for details on making a Private Call.

Receiving and Responding to a Telephone Call (Trunking Only)

This feature allows you to receive calls similar to standard phone calls from a landline phone.



Note:

With the inactivity timer enabled (optional), if there is no response to the call after the timer

expires, your radio exits the call with Menu Inactive Exit tone.

When you receive a Telephone Call, you hear a telephone-type ringing and the LED blinks green. The backlight of the screen turns green. The display shows PHONE CALL and the call received icon blinks.

- 1 Press the **Menu Select** button directly below RESP.

- 2 Press and hold the **PTT** button to talk. Release the **PTT** button to listen.

- 3 Press  or the **Menu Select** button directly below EXIT to hang up and return to the Home screen.

See also [Making a Telephone Call \(Trunking Only\)](#) on page 53 for details on making a Telephone Call.

Methods to Make a Radio Call

You can select a zone, channel, subscriber ID, or talkgroup by using:

- The preprogrammed Zone menu.
- The **Mode Knob**.
- A preprogrammed **One Touch** button.

- The Contacts list (see [Contacts](#) on page 65).





Note:

The radio automatically exits the feature, if the feature inactivity timer is enabled, when the radio is left idle and the timer expires. You will hear the Menu Inactive Exit Tone upon feature exit.

Making a Talkgroup Call

To make a call to a group of users, your radio must be configured as part of that talkgroup.

- 1 Perform one of the following actions:
 -  or  to TGRP and press the **Menu Select** button directly below TGRP. The display shows the last-selected talkgroup. Press the **Menu Select** button directly below SEL.
 - Use the **Mode Knob** to select the channel with the desired talkgroup.

- 2 Hold the microphone vertically 1 to 2 inches (2.5 to 5.0 cm) from your mouth.

- 3 Press the **PTT** button to make the call. The radio shows different indicators based on the system the radio is configured.

- For ASTRO Conventional system, the LED lights up solid red. The display shows the talkgroup alias or ID.
- For Trunking system, the LED lights up solid red.

4 Speak clearly into the microphone.

5 Release the **PTT** button to listen.

Making a Private Call (Trunking Only)

Your radio must be preprogrammed to allow you to use this feature.

This feature allows you to send an individual Call Alert or page if there is no answer from the target radio. See [Sending a Call Alert Page](#) on page 76 for more information.

- 1 Perform one of the following actions:
 - To access this feature via a preprogrammed button, press the preprogrammed **Quick Access (One-Touch) Private Call** button to dial the preprogrammed ID (number) and initiate the Private Call. Proceed to step 5.

- To access this feature via the menu, proceed to the next step.
-

2 ◀ or ▶ to **CALL**, and press the **Menu Select** button directly below **CALL**.
The display shows the last transmitted or received ID.

3 To select the required ID, perform one of the following actions:

- Press the **Menu Select** button directly below **CNTS** to scroll through and select the required ID.
 - Press the **Menu Select** button directly below **LIST** to go to the first number of the call list.
 - ◀ or ▶ to the required ID.
 - Use the **keypad** to enter the required ID.
-

4 Press the **PTT** button to initiate the Private Call. A telephone-type ringing sounds if the receiving unit is in service. The display shows **CALLING...** <NUMBER> or **CALLING...** <ALIAS>.

5 Hold the microphone vertically 1 to 2 inches (2.5 to 5.0 cm) from your mouth.

When you are connected, the display shows the ID of the target radio.

If no acknowledgment is received, the display shows NO ACKNOWLEDGE.





If the target radio does not respond before the time out, the display shows NO ANSWER.

-
- 6 Press and hold the **PTT** button to talk. Release the **PTT** button to listen.
-
- 7 Press  to return to the **Home** screen.
-

Making a Telephone Call (Trunking Only)

This feature allows you to make calls similar to standard phone calls to a mobile or landline phone.

- 1 Perform one of the following actions:
 - To access this feature via a preprogrammed button, press the preprogrammed **Quick Access (One-Touch) Phone Call** button to dial the preprogrammed phone number. Proceed to step 5.
 - To access this feature via the menu, proceed to the next step.
-

- 2  or  to PHON, and press the **Menu Select** button directly below PHON.
The display shows the last transmitted or received ID.
-
- 3 To select the required ID, perform one of the following actions:
 - Press the **Menu Select** button directly below CNTS to scroll through and select the required ID.
 - Press the **Menu Select** button directly below LIST to go to the first number of the call list.
 -  or  to the required phone number.
 - Use the keypad to enter the required phone number.
-
- 4 Press the **PTT** button to dial the phone number.
-
- 5 Hold the microphone vertically 1 to 2 inches (2.5 to 5.0 cm) from your mouth.
-
- 6 When your call is answered, press and hold the **PTT** button to talk. Release the **PTT** button to listen.
-

7 Press  to return to the **Home** screen.



See *Alert Tones* on page 43 for more information if your call is NOT answered.

Switching Between Repeater or Direct Operation Button

The **Repeater Operation** increases the radio coverage area by connecting with other radios through a repeater. The transmit and receive frequencies are different.

The **Direct** or “talkaround operation” allows you to bypass the repeater and connect directly to another radio. The transmit and receive frequencies are the same.

Perform one of the following actions:

- Press the preprogrammed **Repeater/Direct** switch to toggle between talkaround and repeater modes.
 -  or  to **DIR** and press the **Menu Select** button directly below **DIR**.
-

The display shows **REPEATER MODE** if the radio is currently in Repeater mode.

The display shows **DIRECT MODE** and the Talkaround icon if the radio is currently in Direct mode (during conventional operation only).

Monitor Feature

Radio users who switch from analog to digital radios often assume that the lack of static on a digital channel is an indication that the radio is not working properly. This is not the case.

Digital technology quiets the transmission by removing the noise from the signal and allows only the clear voice or data information to be heard.

Use the Monitor feature to make sure a channel is clear before transmitting.

Monitoring a Channel

- Monitoring a Channel in Conventional Modes:
 - a) Lift the microphone off hook.
 - b) Listen for activity on that channel.
 - c) Adjust the **Volume Knob** if necessary.

d) If you hear no activity, press and hold the **PTT** button to start your conversation.

- Monitoring a Channel in Trunked Modes:
 - a) Lift the microphone off hook.
 - b) Press the **PTT** button.
 - c) If you hear two, short, high-pitched tones, or if you hear no tone and the  indicator lights steadily, then proceed with your message.
 - d) Release the **PTT** button to receive (listen).
-



If you are not in the range of the system, you may hear a continuous low-pitched tone and the display shows `OUT OF RANGE`.

Monitoring Conventional Mode

This feature must first be enabled by a qualified radio technician or system administrator.

This feature allows you to monitor channel traffic on conventional channels by defeating the coded squelch. Thus, you can listen to another user active on the channel. This way, you may be prevented from talking over someone else's conversation.

1 To activate monitoring, perform one of the following actions:

- At Home mode where the default zone and channel are being displayed,  or  to `MON` and press the **Menu Select** button directly below `MON` momentarily.
- Take the control head off hook.

The display shows `MONITOR ON`. You hear all channel traffic.

2 Press the **Menu Select** button again to deactivate the monitoring.



The display shows `MONITOR OFF`.

`MONITOR ON` shown on the display indicates that the radio is monitoring. Pressing the **Menu Select** button again turns monitor off and you don't hear all channel traffic. If you try to transmit on a receive-only channel, you hear an invalid tone until you release the **PTT** button.

Advanced Features

Advanced Call Features

Calling a Phone Not in the List

- 1  or  to PHON.

- 2 Press the **Menu Select** button directly below PHON.

- 3 Enter the desired phone number on the keypad. The display updates as the numbers are entered.

- 4 Press the  button or the **PTT** button on the keypad microphone to make the call.

- 5 Press and hold the **PTT** button to talk. Release the **PTT** button to listen.

- 6 Press  or **Menu Select** button directly below PHON to exit.

Selective Call (ASTRO Conventional Only)

This feature allows you to receive a call from or to call a specific individual. It is intended to provide privacy

and to eliminate the annoyance of having to listen to conversations that are of no interest to you.

Receiving a Selective Call

When you receive a Selective Call, you hear two alert tones and the LED lights up solid yellow. The call received icons blink and the display alternates between CALL RECEIVED and the home display.

The speaker unmutes.

- 1 Hold the microphone vertically 1 to 2 inches (2.5 to 5.0 cm) from your mouth.

- 2 Press and hold the **PTT** button to talk. Release the **PTT** button to listen.



Note:

If you press **PTT** button before pressing the **Menu Select** button directly below CALL, your conversation is heard by all members of the talk group.

If 20 seconds pass before you press the **Menu Select** button directly below the CALL, you are not responding privately to the call just received. Instead, you initiate a

Selective Call. See [Making a Selective Call](#) on page 57.

Making a Selective Call

- 1 Perform one of the following actions:
 - To access this feature via a preprogrammed button, press the preprogrammed **Quick Access (One-Touch) Selective Call** button to dial the preprogrammed ID. Proceed to step 4.
 - To access this feature via the menu, proceed to the next step.

- 2 ◀ or ▶ to **CALL**, and press the **Menu Select** button directly below **CALL**.
The display shows the last transmitted or received ID.

- 3 To select the required ID, perform one of the following actions:
 - Press the **Menu Select** button directly below **CNTS** to scroll through and select the required ID.
 - Press the **Menu Select** button directly below **LIST** to go to the last number dialed.

- ◀ or ▶ to the required ID.
- Use the keypad to enter the required ID.

- 4 Hold the microphone vertically 1 to 2 inches (2.5 to 5.0 cm) from your mouth.

- 5 Press and hold the **PTT** button to start the Selective Call.
The display shows the ID of the target radio.

- 6 Release the **PTT** button to listen.

- 7 Press  to return to the **Home** screen.

If you do not press  button to hang up, your radio will remain in Selective Call state with the other unit. You will miss all subfleet traffic and incoming phone calls.

Talkgroup Call Feature (Conventional Operation Only)

This feature allows you to define a group of conventional system users so that they can share the use of a conventional channel.

**Note:**

Encryption keys are associated to talkgroups. When talkgroups are associated, encryption keys are changed by changing the active talkgroup. See [Secure Operations](#) on page 95 for more information.

Selecting a Talkgroup

1 ◀ or ▶ to TGRP and press the **Menu Select** button directly below TGRP.
The display shows the last Talkgroup that was selected and stored.

2 Perform one of the following actions:

- ◀ or ▶ to PSET for the preset preprogrammed Talkgroup.
- ◀ or ▶ to the required Talkgroup.

3 Press the **Menu Select** button directly below SEL to save the currently selected Talkgroup and return to the **Home** screen.
If the encryption key associated to the new Talkgroup is erased, you hear a momentary key fail tone and the display shows KEY FAIL.

If the encryption key that is associated to the new Talkgroup is not allowed, you hear a momentary key fail tone and the display shows ILLEGAL KEY.

4 Press  to return to the **Home** screen.

Sending a Status Call

This feature allows you to send data calls to the dispatcher about a predefined status.

Each status can have up to a 14-character name. A maximum of eight status conditions is possible.

**Note:**

The radio automatically exits the feature, if the feature inactivity timer is enabled, when the radio is left idle and the timer expires. You will hear the Menu Inactive Exit Tone upon feature exit.

1 Perform one of the following actions:

- Press the preprogrammed **Status** button.
- ◀ or ▶ to STS and press the **Menu Select** button directly below STS.

The display shows the last acknowledged status call, or the first status in the list.

2 Perform one of the following actions:

- ◀ or ▶ to the required status.
- Use the **keypad** to enter a number corresponding to the location in the status list.

3 Press the **PTT** button to send the status.

When the dispatcher acknowledges, you hear four tones and the display shows **ACK RECEIVED**. The radio returns to normal dispatch operation.

If no acknowledgment is received, you hear a low-pitched tone and the display shows **NO ACKNOWLEDGE**.

4 Press to return to the **Home** screen.

No traffic is heard on trunked channels while Status Calls is selected. If the radio detects no Status Call activity for six seconds, an alert tone sounds until you press  or the **PTT** button.

typically used during special operations and is enabled by a qualified radio technician.

You will not notice whether your radio has this feature enabled until a dynamic regrouping command is sent by the dispatcher.



Note:

If you try to access a zone or channel that has been reserved by the dispatcher as a dynamically regrouped mode for other users, you hear an invalid tone.

When your radio is dynamically regrouped, it automatically switches to the dynamically regrouped channel. You hear a Gurgle tone and the display shows the dynamically regrouped channel's name.

Press the **PTT** button to talk. Release **PTT** button to listen.

When the dispatcher cancels dynamic regrouping, the radio automatically returns to the zone and channel that you were using before the radio was dynamically regrouped.

Requesting a Reprogram (Trunking Only)

This feature allows you to notify the dispatcher when you want a new dynamic regrouping assignment.

Responding to the Dynamic Regrouping Feature (Trunking Only)

This feature allows the dispatcher to temporarily reassign selected radios to a particular channel where they can communicate with each other. This feature is

Perform one of the following actions:

- Press the preprogrammed **Reprogram Request** button to send reprogram request to the dispatcher.
- ◀ or ▶ to **RPGM** then press the **Menu Select** button directly below **RPGM** to send reprogram request to the dispatcher.

The display shows **REPROGRAM RQST** and **PLEASE WAIT**.

If you hear five beeps, the dispatcher has acknowledged the reprogram request. The display shows **ACK RECEIVED** and the radio returns to the **Home** screen.

If the dispatcher does not acknowledge the reprogram request within six seconds, you hear a low-pitched alert tone and the display shows **NO ACKNOWLEDGE**. Try again or press  to cancel and return to the **Home** screen.

Classification of Regrouped Radios

The dispatcher can classify regrouped radios into either of two categories:

Select Enabled

Select-enabled radios are free to change to any available channel, including the dynamic-regrouping channel, once the user has selected the dynamic-regrouping position.

Select Disabled

Select-disabled radios cannot change channels while dynamically regrouped. The dispatcher has forced the radio to remain on the dynamic-regrouping channel.

The Scan or Private Call feature cannot be selected while your radio is Select Disabled.

Dynamic Zone Programming (DZP)



Note:

Your radio must be preprogrammed to allow you to use this feature. This feature works on the condition at least one zone in the radio must be a non-dynamic zone.

This feature provides one or more Dynamic Zones to store frequently used channels be it conventional or trunking. These dynamic channels are saved from pre-existing (non-dynamic) channels in the radio. This saves the time and effort from the regular navigation

around the working zones and channels. User can also delete or update the list in the Dynamic Zone.

Entering the Dynamic Zone to Select a Dynamic Channel

1 ◀ or ▶ to Zone then press the **Menu Select** button directly below Zone.
The display shows the **Zone** screen.

2 ◀ or ▶ to <# Dynamic Zone Channels>

3 Perform one of the following actions:

- Press the **Menu Select** button below Sel to select.
- Press the **Menu Select** button below Exit to exit.

If you have selected one of the Dynamic Zone Channels list, the display returns to **Home** screen with the selected <# Dynamic Zone Channels> shown on the screen.

If you have selected Exit without selecting any Dynamic Zone Channels list, the display returns to **Home** screen without any changes.

Saving a Channel in the Dynamic Zone from List Selection

The radio must be in Dynamic Zone in order to perform this operation.

1 ◀ or ▶ to ZnPr. Press the **Menu Select** button directly below ZnPr to enter **Program Zone** screen.

2 Press the **Menu Select** button directly below Edit.
The display shows **Search Options** screen.

3 ◀ or ▶ to List Selection. Press the **Menu Select** button directly below SEL.
The display shows **Select Zone** screen.



4 ◀ or ▶ to the required zone. Press the **Menu Select** button directly below SEL.
The display shows **Select Chan** screen.



5 ◀ or ▶ to the required channel. Press the **Menu Select** button directly below SEL.
The display shows Channel updated.

- 6 Press the **Menu Select** button directly below `Exit` to return to **Home** screen.

Deleting a Channel in the Dynamic Zone

The radio must be in Dynamic Zone in order to perform this operation.

- 1  or  to `ZnPr` then press the **Menu Select** button directly below `ZnPr` to enter **Program Zone** screen.
The display shows the dynamic channels list.

- 2  or  to the saved dynamic channel then press the **Menu Select** button directly below `Del`.
The display shows **Channel deleted** screen.

- 3 Press the **Menu Select** button below `Exit` to return to **Home** screen.
The **Home** screen shows `<Dynamic Zone Channels>`.

If the channel deleted is the Home channel, the **Home** screen shows `<Zone Name>+"Blank"`.

Multiple Control Head Features

This feature allows your transceiver to control a combination of up to four O5 control heads on APX Mobile (depending on the model). You can use the CAN cables to connect in any configuration that does not exceed 131 feet (40 meters) in combined length. Refer the Control Head Installation Manual (6878215A01) for further information.

The Multiple Control Head (MCH) feature consists of 2 modes that can be programmed via Customer Programming Software (CPS):

- All Active mode
- One Active mode



Note:

If two or more control heads are connected to the system before enabling the MCH feature in the CPS, the radio displays `EXTRA CH` or `CH ID # ERR`. Both errors are FATAL.

Setting the ID of the Initial Control Head

This feature allows you to setup the control head in the **Front Panel Programming (FPP)** mode. During the setup, the control heads are defined as Control

Head Number 1, Control Head Number 2, Control Head Number 3 and Control Head Number 4.

- 1 Power off the radio by pressing the **Power** button.

- 2 Press and hold the left-most **Menu Select** button and the emergency button simultaneously.

- 3 While continuing to depress these two buttons, press the **Power** button to power on the radio and the control head.
The radio and the control head powers on into **FPP** mode. The display shows the ID number of the control head.

- 4 Turn the **Mode** knob to change the ID number of the control head.

- 5 Press the **Power** button to power off the radio and exit **FPP** mode.

- 6 Repeat step 1 to step 5 to set the ID number for the rest of the attached control heads.

All Active Mode

The All Active mode enables all connected control heads attached to the radio to operate concurrently

with each other. When you activate a feature on one control head, the rest of the control heads have the same activated features and indicators on their respective display.



Note:

The multiple control head feature allows only control heads of the same type to be connected. Upon power up, if a control head of a different type is connected to the radio, the display of all the attached control heads shows the FATAL error CH MISMATCH.

Activating and Deactivating Intercom in All Active Mode

This feature only applies to control heads in the All Active mode.

The intercom feature allows one control head user to talk to another control head user in a Multiple Control Head configuration. At any given time, when a control head being operated has priority for the intercom call, all other control heads are blocked until the active control head releases **PTT** button. This can be made on any attached control head.

1 Press the **Menu Select** button directly below **INTC** to activate the intercom feature of any of the control heads.

2 Press the **PTT** button to initiate an intercom transmission.
All control heads that are attached will receive the same intercom call. The display of the control heads receiving the intercom call shows the alias/ID number of the transmitting control head.

3 Press  or the **Menu Select** button directly below **EXIT** to deactivate the intercom feature.

The intercom feature also deactivates when user initiates a mode change. If the radio is on an emergency channel, pressing of the **EMERGENCY** button or the emergency footswitch button on any control head also deactivates the intercom feature.

One Active Mode

The One Active mode enables only one control head to be visibly active at a time in a 2 control head system.



Note:

In the One Active mode, if more than 2 control heads are present upon power up, the radio shows a **FATAL** error **EXTRA CH** on the display of all attached control heads.

The active control head commands the system normally while the inactive control head is in remote mode with its display shows **REMOTE**.

The **Volume** knob, **DIM** button, **Front/Rear (F/R)** softkey and **Emergency** button remain active on the inactive control head, while all other controls are disabled. Emergency footswitch and VIP inputs remain active on the inactive control head. The VIP input control head is configurable in the CPS and VIP should be attached to the control head selected in the CPS.



Note:

Only 2 control heads are supported in the one active mode.

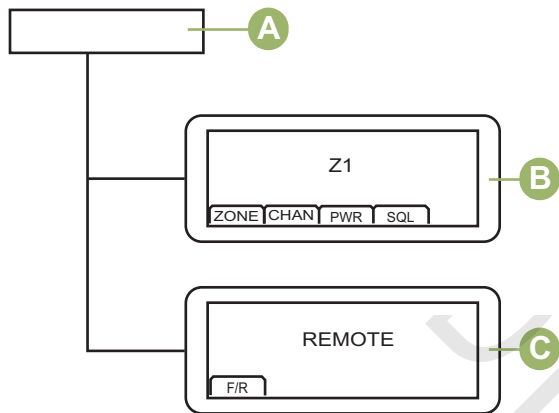

A	Transceiver
B	Active Radio
C	Non-Active Radio

You can change the command between the 2 control heads by pressing the **Menu Select** button directly below F/R, or the **Menu Select** button preprogrammed user button on the keypad microphone.

Contacts

This feature provides “address-book” capabilities on your radio. Each entry corresponds to an alias (name) or ID (number) that you use to initiate a call.

Contact entries are alphabetically sorted according to entry alias. Each alias can have up to five IDs of different call types associated with it.

Additionally, each entry, depending on context (conventional, trunking, or phone), associates with one or more of the four types of calls: Phone Call, Selective Call, Private Call, or Call Alert.

Each entry within Contacts contains the following information:

- Call Alias (Name)
- Call ID (Number)
- Call Type (Icon)
- WACN ID (Astro 25 Trunking IDs only)
- System ID



Note:

Your radio must be preprogrammed to allow you to add, edit, or delete the contact entries.

Your radio also supports a maximum of 50 call lists. Each list can store up to 100 IDs (numbers).



Note:

Your radio is preprogrammed with a number of contacts per Call Lists. Check with your dealer or system administrator for more information.

The radio automatically exits the feature, if the feature inactivity timer is enabled, when the radio is left idle and the timer expires. You hear the Menu Inactive Exit Tone upon feature exit.

Making a Private Call from Contacts

Your radio must be preprogrammed to allow you to use this feature.

- 1 or to CNTS and press the **Menu Select** button directly below CNTS.

The entries are alphabetically sorted.

- 2 or to the required subscriber alias.
-

- 3 Perform one of the following actions:

- Press the **Menu Select** button directly below OPTN and proceed to the next step.

- Press the **Menu Select** button directly below CNTS and proceed to step 6.
-

- 4 or to CALL and press the **Menu Select** button directly below SEL.
-

- 5 or to select the call type.
-

- 6 Hold the microphone vertically 1 to 2 inches (2.5 to 5.0 cm) from your mouth.
-

- 7 Press the **PTT** button to initiate the call. During the call, the display shows the subscriber alias.
-

- 8 Press and hold the **PTT** button to talk. Release the **PTT** button to listen. The LED lights up solid red when the **PTT** button is pressed.
-

If there is no voice activity for a preprogrammed period of time, the call ends.

If the call reaches the maximum ring time, the call ends.

Adding a New Contact Entry

- 1 **◀** or **▶** to CNTS and press the **Menu Select** button directly below CNTS.
The entries are alphabetically sorted.

- 2 **◀** or **▶** to [NEW CONTACT] and press the **Menu Select** button directly below SEL.
The display shows NAME.

- 3 Press the **Menu Select** button directly below EDIT.

- 4 Use the **keypad** to enter the name and press the **Menu Select** button directly below OK once you have entered the name.
To cancel this operation, press the **Menu Select** button directly below CNCL to return to the previous screen.

- 5 **◀** or **▶** to [ADD NUMBER] and press the **Menu Select** button directly below SEL.
The display shows TYPE 1 <DEFAULT TYPE>.

- 6 Press the **Menu Select** button directly below EDIT.

- 7 **◀** or **▶** to the required channel and press the **Menu Select** button directly below OK.

- 8 **◀** or **▶** to NUMBER 1 and press the **Menu Select** button directly below EDIT.
The display shows NUMBER 1 and a blinking cursor appears.

- 9 Use the **keypad** to enter the number and press the **Menu Select** button directly below OK once you have entered the number.
To cancel this operation, press the **Menu Select** button directly below CNCL to return to the previous screen.

- 10 Press the **Menu Select** button directly below DONE once you have finished.
The display shows <ENTRY> STORED, confirming that the contact entry has been added.
The radio returns to the main **Contacts** screen.

Deleting a Contact Entry

- 1 **◀** or **▶** to CNTS and press the **Menu Select** button directly below CNTS.

The entries are alphabetically sorted.

2 ◀ or ▶ to the entry you want to delete and press the **Menu Select** button directly below OPTN.

3 ◀ or ▶ to DEL and press the **Menu Select** button directly below SEL.
The display shows <ENTRY> CONFIRM DEL?.

4 Select the **Menu Select** button directly below YES to delete the entry, or NO to cancel and return to the main screen of Contacts.
The display shows <ENTRY> DELETED and the radio returns to the main screen of Contacts.

Adding a Contact to a Call List

1 ◀ or ▶ to CNTS and press the **Menu Select** button directly below CNTS.
The entries are alphabetically sorted.

2 ◀ or ▶ to the entry you want to add and press the **Menu Select** button directly below OPTN.

3 ◀ or ▶ to ADD TO CALLST or ADD TO PHONLST and press the **Menu Select** button directly below SEL.

4 Perform one of the following actions:

- ◀ or ▶ until the display shows [AVAILABLE] and press the **Menu Select** button directly below ADD to add as a new entry.
- ◀ or ▶ until the display shows <ENTRY> and its associated number and press the **Menu Select** button directly below RPLC to replace the existing entry.

The display shows <ENTRY> ADDED, confirming the addition of the contact to the list.

The radio returns to the main display of **Contacts**.

Methods of Contact Editing in a Call List

Editing an Entry Alias

1 ◀ or ▶ to CNTS and press the **Menu Select** button directly below CNTS.
The entries are alphabetically sorted.

- 2 ◀ or ▶ to the entry you want to edit and press the **Menu Select** button directly below OPTN.

- 3 ◀ or ▶ to EDIT and press the **Menu Select** button directly below SEL.

- 4 ◀ or ▶ to the entry alias you wish to change and press the **Menu Select** button directly below EDIT. A blinking cursor appears.

- 5 Use the **keypad** to edit the name and press the **Menu Select** button directly below OK once you have finished. The display returns to the **Edit Contact** screen.

- 6 Press the **Menu Select** button directly below DONE to save your changes and return to the main screen of **Contacts**.

Editing as Entry ID

- 1 ◀ or ▶ to CNTS and press the **Menu Select** button directly below CNTS. The entries are alphabetically sorted.

- 2 ◀ or ▶ to the entry you want to edit and press the **Menu Select** button directly below OPTN.

- 3 ◀ or ▶ to EDIT and press the **Menu Select** button directly below SEL.

- 4 ◀ or ▶ to the entry ID you wish to change and press the **Menu Select** button directly below EDIT. A blinking cursor appears.

- 5 Use the keypad to edit the number and press the **Menu Select** button directly below OK once you have finished. The display returns to the **Edit Contact** screen.

- 6 Press the **Menu Select** button directly below DONE to save your changes and return to the main screen of **Contacts**.

Editing a Call Type

- 1 ◀ or ▶ to CNTS and press the **Menu Select** button directly below CNTS. The entries are alphabetically sorted.

- 2 ◀ or ▶ to the entry you want to edit and press the **Menu Select** button directly below **OPTN**.

- 3 ◀ or ▶ to **EDIT** and press the **Menu Select** button directly below **SEL**.

- 4 ◀ or ▶ to **TYPE** and press the **Menu Select** button directly below **EDIT**.

- 5 ◀ or ▶ to choose from the list of call types given and press the **Menu Select** button directly below **OK**. The display returns to the **Edit Contact** screen.

- 6 Press the **Menu Select** button directly below **DONE** to save your changes and return to the main screen of **Contacts**.

Scan Lists

Scan lists are created and assigned to individual channels/ groups. Your radio scans for voice activity by cycling through the channel/group sequence specified in the scan list for the current channel/ group.

Your radio supports different types of Scan Lists:

- Trunking Priority Monitor Scan List
- Conventional Scan List
- Talkgroup Scan List

A maximum of 200 Scan Lists can be programmed in your radio. These lists must be preprogrammed by a qualified radio technician.

Viewing a Scan List

- 1 ◀ or ▶ to **SCNL** and press the **Menu Select** button directly below **SCNL**.

- 2 ◀ or ▶ to view the members on the list.

- 3 Press  to exit the current display and return to the Home screen.

Editing the Scan List

This feature lets you change scan list members and priorities.

- 1 ◀ or ▶ to **SCNL** and press the **Menu Select** button directly below **SCNL**. The display shows the lists that can be changed.

- 2 ◀ or ▶ to the entry you want to edit.

- 3 Perform one of the following actions:
 - Press the **Menu Select** button directly below SEL to add and/or change the priority of the currently displayed channel in the scan list.
 - Press the **Menu Select** button directly below DEL to delete the currently displayed channel from the scan list.
 - Press the **Menu Select** button directly below RCL to view the next member of the scan list.

- 4 Perform one of the following actions to select another channel that needs to be added or deleted then repeat step 3. Otherwise, proceed to the next step.
 - ◀ or ▶ to the desired channel.
 - Use the keypad to enter the desired channel name.
 - Use the **Mode Knob** to select the channel.

- 5 Press  to exit scan list programming and return to the Home screen.

See [Viewing and Changing the Priority Status](#) on page 72 for more information on how to add and/or change the priority of the currently displayed channel in the scan list.

Changing the Scan List Status

- 1 Long press the preprogrammed **Scan** side button.

- 2 ◀ or ▶ to the member you want to edit.

- 3 Perform one of the following actions:
 - Press the **Select** button once to add the currently displayed channel to the scan list.
 - Press the **Select** button one or more times to change the scan list status icon of the currently displayed channel.

- 4 Perform one of the following actions:
 - ◀ or ▶ to select more list members whose scan status you want to change.
 - Use the **Mode Knob** to select another scan list member.

- 5 Press  to exit scan list programming and return to the Home screen.

Viewing and Changing the Priority Status

Perform one of the following actions:

- Press the **Menu Select** button directly below **SEL** one or more times to change the priority status of the current displayed channel.
- Press the **Select** button one or more times to toggle between different status of the Scan List status icon of the current displayed channel.

The radio shows one of following priority status icons and scenarios:

- A Scan icon indicates that the current channel is in the scan list as a non-priority channel. The LED lights up solid green.
- A Priority-Two Channel Scan icon indicates that the current channel is in the scan list as the Priority-Two channel. The LED blinks green.
- A Priority-One Channel Scan icon indicates that the current channel is in the scan list as the Priority-One channel. The LED rapidly blinks green. You hear all traffic on the Priority-One channel, regardless of traffic on non-priority channels.

- No icon indicates that the current channel is deleted from the scan list.
-

Scan

This feature allows you to monitor traffic on different channels by scanning a preprogrammed list of channels.

Turning Scan On or Off

Perform one of the following actions:

- Press the preprogrammed **Scan** button to initiate or stop scan.
- **◀** or **▶** to **SCAN** and press the **Menu Select** button directly below **SCAN**.

If the scan is enabled, the display shows **SCAN ON** and the scan status icon.

If the scan is disabled, the display shows **SCAN OFF**.

The radio returns to the Home screen.

Turning Scan On While Disregarding the Squelch Code (Conventional Channels Only)

You can still receive fleetwide, system-wide, dynamic regrouping, incoming telephone interconnect and Private Conversation/Call Alert calls while scanning for activity.

You may respond to these types of calls as you would normally on the selected channel. However, when scanning different channels while in talkgroup scan, incoming Private Conversation/Call Alert calls may be missed.

◀ or ▶ to **MON** and press the **Menu Select** button directly below **MON**.

The brief **MONITOR ON** display indicates that the radio is disregarding the squelch code.

Transmitting While the Scan is On

Transmitting Using Radio Programmed for Talkback Scan

Press the **PTT** button to transmit on the channel indicated by the display.

The radio does not begin scanning again for a predetermined hang time after you release the

PTT button, allowing the other party to respond. If the other party responds within the hang time, scanning does not resume until the full hang time expires after they have finished speaking, allowing the conversation to be completed.

To transmit on the selected channel if another channel is active, first turn scan off by pressing the **Menu Select** button below **SCAN** momentarily.

Transmitting Using Radio Programmed for Non-Talkback Scan

Press the **PTT** button at any time to transmit on the selected channel or fixed channel.

To make a Call Alert page, or Private Conversation call while scanning, press either the **Menu Select** button directly below **PAGE** or **CALL**. The call is entered on the selected channel and scanning is halted until the call is exited by pressing  or pressing the **Menu Select** button below either **PAGE** or **CALL**.

Deleting a Nuisance Channel

If a channel continually generates unwanted calls or noise (termed a “nuisance” channel), you can

temporarily remove the unwanted channel from the scan list.

This capability does not apply to priority channels or the designated transmit channel.

When the radio is locked onto the channel to be deleted, ◀ or ▶ to NUIS and press the **Menu Select** button directly below NUIS.

The radio continues scanning the remaining channels in the list.

Restoring a Nuisance Channel

To restore the deleted nuisance channel, perform one of the following actions:

- Stop and restart a scan.
- Mode change to another channel and back to the original channel.
- Turn off the radio and then turn it on again.

Nuisance mode delete can be disabled by the system administrator.

Changing Priorities Status While Scan is On

While the radio is scanning, the dynamic priority change feature allows you to temporarily change any channel in a scan list (except for the Priority-One channel) to the Priority-Two channel.

This change remains in effect until scan is turned off. Scan then reverts to the preprogrammed (original) setting.

- 1 Press the **Menu Select** button directly below DYNP to change the priority of a non-priority channel in the scan list to Priority-Two.
 - 2 Press  momentarily to exit the scan list and resume scanning.
-

Restoring Priorities in a Scan List

To restore the original channel priorities in a scan list, perform one of the following actions:

- Turn scan off, and then on.
 - Change channels.
 - Turn off the radio, and then turn it back on.
-

Using the Hang Up Box (HUB)

To temporarily suspend Scan Mode operation, remove the control head from the Hang Up Box (HUB).

You are allowed to use the control head while scan is suspended. However, Priority Member scanning is not suspended. This feature applies to all Scan Lists and Scan Types. Scan is resumed once the control head is returned to the holding clip and the preprogrammed hang time has elapsed.

**Note:**

Priority Scan List members are continuously scanned only when the Scan List, **Designated Tx Member** field is set to "Talkback" in the radio programming. Otherwise, all scan mode operation is suspended.

them an individual Call Alert page. You can also verify if a radio is active on the system.

Depending on how your radio is programmed, when you make an Enhanced Private Call, the radio either automatically sends a call alert page if there is no answer after the maximum ring time, or when you press the **PTT** button.

**Note:**

This feature must be preprogrammed by a qualified radio technician.

Receiving a Call Alert Page

When you receive a Call Alert page, you hear four repeating alert tones and the LED blinks green. If Call Alert Tone Auto Reset is enabled, you hear one alert tone and the LED blinks green. The call received icons blinks and the display shows PAGE RECEIVED.

Press the **PTT** button to answer or press any button to clear the Call Alert page.

See [Making a Talkgroup Call](#) on page 51 or [Making a Private Call \(Trunking Only\)](#) on page 52 for more information on returning the call.

Call Alert Paging

This feature allows your radio to work like a pager.

Even if other users are away from their radios, or if they are unable to hear their radios, you can send

Sending a Call Alert Page

The following methods are options on how to send a call alert page. The result of all the methods is the same. You can use the options interchangeably depending on your preference and the programmed functions.



Note:

If the feature inactivity timer is enabled, your radio automatically exits the feature when your radio is left idle long enough for the time to expire. You hear the Menu Inactive Exit Tone upon feature exit.

- Sending a call alert page via the preprogrammed **Quick Access (One-Touch) Call Alert Paging** button:
 - a) Press the preprogrammed **Quick Access (One-Touch) Call Alert Paging** button to send a page to the preprogrammed ID.

The display shows `PAGING... <NUMBER>` or `<ALIAS>`.

If the call alert page is sent successfully, you hear four high-pitched tones and the display

shows `ACK RECEIVED`. The radio returns to the Home screen.

If the call alert page is not acknowledged, you hear a low tone and the display shows `NO ACKNOWLEDGE`. Press the **Menu Select** button directly below `OK` to return to the main screen for Contacts.

-
- Sending a call alert page via the radio menu `PAGE`:
 - a) `◀` or `▶` to `PAGE`.
 - b) Press the **Menu Select** button directly below `PAGE`.
 - c) `◀` or `▶` to select the required ID.
 - d) Press the **PTT** button to send the page.

The display shows `PAGING... <NUMBER>` or `<ALIAS>`.

If the call alert page is sent successfully, you hear four high-pitched tones and the display shows `ACK RECEIVED`. The radio returns to the Home screen.

If the call alert page is not acknowledged, you hear a low tone and the display shows `NO ACKNOWLEDGE`. Press the **Menu Select** button

directly below **OK** to return to the main screen of **Contacts**.

- Sending a call alert page via the radio menu **CALL**:

- a) ◀ or ▶ to **CALL**.
- b) Press the **Menu Select** button directly below **CALL**.
- c) ◀ or ▶ to select the alias or ID, and press the **PTT** button to initiate the call.

If the target radio does not respond after a preprogrammed period of time, the display shows **SEND PAGE?**.

- d) To send the call alert page, press the **Menu Select** button directly below **YES**. To exit the screen without sending the call alert page, press the **Menu Select** button directly below **NO**.

The display shows **PAGING... <ALIAS>**.

If the call alert page is sent successfully, you hear four high-pitched tones and the display shows **ACK RECEIVED**. The radio returns to the Home screen.

If the call alert page is not acknowledged, you hear a low tone and the display shows **NO**

ACKNOWLEDGE. Press the **Menu Select** button directly below **OK** to return to the main screen of **Contacts**.

Enabling and Disabling In-Call User Alert

Make sure you are in Home mode where the default zone and mode are being displayed.

You can enable and disable voice transmission, if needed.

- 1 ◀ or ▶ to scroll to the **UMUT** and press the **Menu Select** button directly below **UMUT**.
Voice mute is activated.

- 2 To turn the feature off, press the **Menu Select** button directly below **UMUT** or the **VMut** preprogrammed button again.

Pressing the **Menu Select** button directly below **UMUT** or the **VMut** programmed button momentarily toggles between Voice mute on and Voice mute off. **VOICE MUTE ON** shown on the display indicates that the radio is muted to all conventional dispatch calls and affiliated trunking group calls.

Quick Call II (ASTRO P25 Digital Trunking and Conventional)

This feature allows the user to broadcast a series of distinct, recognizable tones before a voice transmission from the dispatcher or a radio.

The broadcasting dispatcher or radio user can select this alert tone transmission to be sent to an individual Talkgroup or over the entire system. Specific tone or series of tones are pre-programmed into the radios to allow the dispatcher or supervisor to select a list of tones to broadcast before they make their voice transmission. Each tone is distinctive to indicate different situation or different broadcaster. The transmitting radio also plays back the tones for the broadcaster to listen.



Note:

The receiving radios must be configured with the Quick Call II tone in order for the radio to sound the selected tone and also to sound a preconfigured alert tone after the selected tone has sound.

Initiating a Quick Call II Transmission

The broadcasting or transmitting radio must be pre-programmed to see the tone in the Quick Call II tone list. The receiving radio must also be pre-programmed to decode the tone to broadcast.

- 1 ◀ or ▶ to **QCII**, and press the **Menu Select** button directly below **QCII**.
- 2 ◀ or ▶ to select the tone to broadcast.
- 3 Press the **PTT** to broadcast the selected tone, or press and hold the **PTT** to broadcast the selected tone and transmit with your vocal transmission. You hear the radio sounds the selected tone. You can begin your call after the tone ends.
- 4 Release **PTT** to listen.

Emergency Operation

The Emergency feature is used to indicate a critical situation.

If the **Orange** button is preprogrammed to send an emergency signal, this signal overrides any other communication over the selected channel.

Your radio supports the following Emergency modes:

- Emergency Alarm
- Emergency Call (Trunking Only)
- Emergency Alarm with Emergency Call
- Silent Emergency Alarm
- Special Considerations for Emergencies

Check with your dealer or system administrator for more information on the programming of this feature.

Only **one** of the Emergency modes above can be assigned to the preprogrammed **Emergency** button or the **Emergency** footswitch.



Note:

To exit emergency at any time, press and hold the preprogrammed Emergency button for about a second. This timer is programmable from 0 – 6250 milliseconds by a qualified technician.

Sending an Emergency Alarm

This feature allows you to send a data transmission, which identifies the radio sending the emergency, to the dispatcher.

- 1 Press the preprogrammed **Emergency** button.

A tone sounds and the display alternates **EMERGENCY** and the home display. A dispatcher acknowledgment **ACK RECEIVED** display follows. For trunking system, the radio also sounds a high-pitched tone that indicates the alarm has been received by the trunked system's central controller.

-
- 2 Press and hold the **EMERGENCY** button or the **PTT** button to return to normal operation.
-

Sending an Emergency Call (Trunking Only)

This feature gives your radio priority access to a talkgroup.

- 1 Press the preprogrammed **Emergency** button. One of the following scenarios occurs:
 - A tone sounds and the display alternates **EMERGENCY** and the home display.

- You hear the radio sounds a short low-pitched tone to indicate the selected channel does not support emergency and rejects to launch emergency mode.

-
- 2 Hold the microphone vertically 1 to 2 inches (2.0 to 2.5 cm) from your mouth.

 - 3 Press and hold the **PTT** button. Speak clearly into the microphone.

 - 4 Release the **PTT** button to end the transmission and wait for a response from the dispatcher.

 - 5 To exit Emergency Call, press and hold the preprogrammed **Emergency** button for about a second.

Sending an Emergency Alarm with Emergency Call

This feature gives your radio priority access on a channel for conventional system, and to a talkgroup for trunking system.

If the radio has both emergency call and alarm features enabled, it automatically proceeds to the call mode after the alarm is acknowledged.

- 1 Press the preprogrammed **Emergency** button.

The display alternates **EMERGENCY** and the home display. A high-pitched tone sounds, indicating that the trunked system central controller has received the alarm. A dispatcher acknowledgment (four high-pitched tones) follows, accompanied by an **ACK RECEIVED** display.

-
- 2 Hold the radio vertically 1 to 2 inches (2.5 to 5.0 cm) from your mouth.

 - 3 Press and hold the **PTT** button. Speak clearly into the microphone.

 - 4 Release the **PTT** button to end the transmission and wait for a response from the dispatcher.

 - 5 To exit Emergency Call, press and hold the preprogrammed **Emergency** button for about a second.

Turning off the radio also cancels the emergency state.

Sending a Silent Emergency Alarm

This feature allows you to send an Emergency Alarm to the system without triggering any audio or visual indicators.

This activated microphone state is also known as “hot mic”.



Note:

If you press the **PTT** button during hot mic, and continue to press it after the hot mic duration expires, the radio continues to transmit until you release the **PTT** button.

- 1 Press the preprogrammed **Emergency** button. The display shows no changes, the LED does not light up, and you hear no tones. The silent emergency state continues until you perform the next step.

- 2 Press and hold the emergency button until a tone sounds to exit the silent alarm mode. If silent emergency alarm is used with emergency call, pressing the **PTT** button exits the silent mode and initiates the emergency call.

Special Considerations for Emergencies

- If you press the emergency button while in a channel that has no emergency capability, a low-pitched tone sounds.

- If the unit is out of the range of the system and/or the emergency alarm is not acknowledged, a tone sounds and the display shows **NO ACKNOWLEDGE**.
- If you press the emergency button, then change to a mode that has no emergency capability, the display shows **NO EMERGENCY** and a continuous low-pitched tone sounds until a valid emergency mode is selected or until the emergency is cancelled.
- When an emergency is active, changing to another mode where emergency is enabled (trunked or conventional) causes an emergency alarm and/or emergency call to be active on the new mode.

Automatic Registration Service (ARS)

This feature provides an automated data application registration for the radio. When you turn on the radio, the device automatically registers with the server.

Data applications within the fixed network can determine the presence of a device on the system and send data to the device. For example: Text Messaging Service (TMS).

The Automatic Registration Service for the radio consists of two (2) modes:

- ARS Server Mode (default mode)
- ARS Non-Server Mode



Note:

The default ARS mode can be changed by a qualified radio technician using the radio's programming software.

Selecting or Changing the ARS Mode

The following methods are options on how to select or change the ARS Mode. The result of all the methods is the same. You can use the options interchangeably depending on your preference and the programmed functions.

- Selecting or Changing the ARS mode via the radio menu:
 - a) Press and hold ◀ or ▶ to CHAN.
 - b) Press the **Menu Select** button directly below CHAN.
The display shows the current zone is not blinking, and the channel is blinking.
 - c) ◀ or ▶ or press the **Mode Knob** once and rotate the **Mode Knob** to the desired channel.

One of the following scenarios occur:

- In ARS Server Mode, the display shows the User Login Indicator icon, the zone, and ARS server channel.
 - In ARS Non-Server Mode, the display shows the User Login Indicator icon, the zone, and ARS non-server channel.
 - If the channel or mode selected is unprogrammed, the display shows UNPROGRAMMED. Repeat this step.
- d) Press to confirm the displayed zone and channel.
-
- Selecting the ARS mode via the **Mode Knob**:
 - a) After the zone you want is displayed, toggle until the display shows the required channel. The display shows the current zone is not blinking, and the channel is blinking.
 - b) ◀ or ▶ or press the **Mode Knob** once and rotate the **Mode Knob** to the desired channel.
One of the following scenarios occur:
 - In ARS Server Mode, the display shows the User Login Indicator icon, the zone, and ARS server channel.

- In ARS Non-Server Mode, the display shows the User Login Indicator icon, the zone, and ARS non-server channel.
 - If the channel or mode selected is unprogrammed, the display shows UNPROGRAMMED. Repeat this step.
- c) Press  to confirm the displayed zone and channel.

User Login Feature

This feature allows you as the user to be associated with the radio. With this association, every data application (Example: Text Messaging Service) takes on a friendly username.

You can still send text messages without logging in as a user. The user login feature only enables the recipient of your message to identify you as the sender by assigning a username to your message.









Note:

Valid characters for a username entry are capital letters (A – Z), small letters (a – z), numbers (0 – 9), symbols (*, #, -, /), and the space character.

The maximum length for a username is eight (8) characters. Usernames are not case sensitive in server mode but are case sensitive in non-server mode.

A predefined username may sometimes be invalid because the programming software that is used to set predefined usernames allows you to set usernames comprising of eight (8) characters or more.

Logging In as a User

- 1  or  to **USER** and press the **Menu Select** button directly below **USER**.
The display shows the User Login screen.
- 2 Perform one of the following actions:
 -  or  to **[ID Entry]** and press the **Menu Select** button directly below **Edit** to enter ID. A blinking cursor appears on the screen. Use the **keypad** to type or edit a user name. Press the **Menu Select** button directly below **OK** to submit.
 -  or  to scroll through the list of predefined user names. Press the **Menu Select** button

directly below SEL to select the predefined user name.

- Press and hold ◀ or ▶ to scroll through the list of predefined user names at a fast scroll rate. Press the **Menu Select** button directly below LOGN to select the predefined user name.

If the selected predefined username has more than eight (8) characters, or an invalid character in it, the display momentarily shows INVALID ID.

3 Press the **Menu Select** button directly below PIN. A blinking cursor appears beside PIN.

4 Enter your Personal Identification Number (PIN) number.

The maximum PIN length is 4 digits. The PIN number will appear as asterisks.

5 Press the **Menu Select** button directly below LOGN.

One of the following scenarios occurs:

- In ARS Server Mode, the display shows the User Login Indicator icon, the ID, and IN PROGRESS, with CNCL.

- In ARS Non-Server Mode, the display shows the User Login Indicator icon, the ID, and LOGGED IN, with LOGT and EXIT.
- In non-ARS enabled mode, the display shows OFFLINE, with LOGT and EXIT.

One of the following scenarios occurs:

- If the user name is invalid, login fails and the user login failure indicator (IP indicator) icon blinks. The display also shows momentary LOGIN FAILED.
- If the PIN is invalid, login fails and the user login failure indicator (IP indicator) icon blinks. The display also shows momentary LOGIN FAILED.
- Wait for the logged in confirmation screen. If the login process is successful, the display shows the successful user login indicator (IP indicator) icon and LOGGED IN, with LOGT and EXIT.



Note:

To cancel the login process and return to the initial user login screen, press the **Menu Select** button directly below CNCL.

Logging Out

Once the data application registration is completed, you can log out.

**Note:**

Private data refers to all messages in the text messaging **Inbox**, **Draft**, and **Sent** folder. The next user is able to access the **Inbox**, **Draft** and **Sent** messages if private data is not deleted.

- 1  to LOGT and press the **Menu Select** button directly below LOGT.

The display shows the User Login Indicator icon and CLEAR PRIVATE DATA?.

- 2 Perform one of the following actions:
 - Select YES to clear all your private data. The display shows momentary PRIVATE DATA CLEARED.
 - Select NO to keep your private data.

- A new text message (free form message).
- A predefined message (quick text message).
- An edited quick text message.

The main menu consists of the following options:

- Inbox
- Compose
- Drafts
- Sent

**Note:**

See [Status Icons](#) on page 35 for more information on the TMS icons and [TMS Menu Options](#) on page 39 for more information on each menu option.

Accessing the Messaging Features

- 1 Perform one of the following actions:
 - Press the **Data Feature** button or the preprogrammed **TMS Feature** button to access the TMS feature screen.
 - Press and hold the **Data Feature** button or the preprogrammed **TMS Feature** button to access the Inbox.

Text Messaging Service (TMS)

This features allows you to quickly send and receive messages and run database queries directly from your radios. The maximum length of characters for a text message is 200.

The types of text messages available:

- Follow the procedure described next to access this feature via the radio menu.

2 ◀ or ▶ to TMS.

3 Press the **Menu Select** button directly below TMS to access the TMS feature screen.

4 ◀ or ▶ to scroll through the main menu options.



Note:

The radio automatically exits the feature, if the feature inactivity timer is enabled, when the radio is left idle and the timer expires. You will hear the Menu Inactive Exit Tone upon feature exit.

Press the **Menu Select** button directly below Back at any time to return to the previous screen.

Composing and Sending a New Text Message

During the uppercase and lowercase mode, multi-tapping the keys only scrolls through the letters. For example, A->B->C, a->b->c.

During the numeric mode, except for **1**, pressing the keypad only enters the numeric digits. Subsequent presses of the same key inserts the same digit to the text message (no multi-tap).

1 ◀ or ▶ to TMS.

2 Press the **Menu Select** button directly below TMS to access the TMS feature screen.

3 Press the **Menu Select** button directly below COMP to see the compose options.

4 Press the **Menu Select** button directly below NEW to compose a new message. A blinking cursor appears on the COMPOSE screen.

5 Use the keypad to type or edit your message.

6 Press the **Menu Select** button directly below OPTN once the message is composed.

7 Perform one of the following actions:

- ◀ or ▶ to scroll through the address list and select the required address.

- **◀** or **▶** to [OTHER RECPNT] and press the **Menu Select** button below EDIT. When a blinking cursor appears in the ENTER ADDRESS screen, use the **keypad** to type the address entry.

- 8 Press the **Menu Select** button directly below SEND or press the PTT button to send the message.

The display shows the SEND MESSAGE screen and SENDING MSG.

If the message is sent, you hear a tone and the display shows MSG SENT.

If the message is not sent, you hear a low tone, the display shows SEND FAILED and returns to the main TMS screen.



Note:

You can append a priority status and/or a request reply to your message. See [Priority Status and Request Reply of a New Text Message](#) on page 88 for more information.

You can also select the DRFT option to save your message in the Drafts folder to send it at a later time. See [Accessing the](#)

[Drafts Folder](#) on page 93 for more information.

Sending a Quick Text Message

Quick Text messages are messages that are predefined and usually consist of messages that are used most frequently.

Each Quick Text message has a maximum length of 50 characters.

- 1 Perform one of the following actions:
 - To access this feature via a preprogrammed button, press the preprogrammed **Quick Text** button and proceed to Step 4.
 - To access this feature via the menu, proceed to the next step.
- 2 **◀** or **▶** to TMS and press the **Menu Select** button directly below TMS to access the TMS feature screen.
- 3 Perform one of the following actions:
 - Press the **Menu Select** button directly below COMP to see the compose options.

- Press the **Menu Select** button directly below EXIT to return to the Home screen.
-

4 Press the **Menu Select** button directly below LIST to see the quick text list.

5 ◀ or ▶ to scroll through the list of messages and press the **Menu Select** button directly below SEL to select the required message.
The message appears on the COMPOSE screen, with a blinking cursor at the end of it. Use the keypad to edit the message, if required.

6 Press the **Menu Select** button directly below OPTN.

7 Press the **Menu Select** button directly below SEND.

- 8 Perform one of the following actions:
- ◀ or ▶ to scroll through the address list and select the required address.
 - ◀ or ▶ to [OTHER RECPNT] and press the **Menu Select** button below EDIT. When a blinking

cursor appears on the ENTER ADDRESS screen. Use the keypad to type the address entry.

9 Press the **Menu Select** button directly below SEND or press the PTT button to send the message.

The display shows the SEND MESSAGE screen and SENDING MSG.

If the message is sent, you hear a tone and the display shows MSG SENT.

If the message is not sent, you hear a low tone, the display shows SEND FAILED and returns to the main TMS screen.



Note:

You can append a priority status and/or a request reply to your message. See [Priority Status and Request Reply of a New Text Message](#) on page 88 for more information.

Priority Status and Request Reply of a New Text Message

Before sending your message, you can append a priority status and/or a request reply to your message.

Appending a Priority Status to a Text Message

Ensure that an outgoing message is composed to allow you to perform this procedure. See [Composing and Sending a New Text Message](#) on page 86 for more information.



Note:

The Priority Status icon on a message does not imply that the message gets higher priority over the other messages when it is being transmitted. It is just an indication that can be embedded into a message to let the receiver know that the message is important.

- 1 Press the **Menu Select** button directly below OPTN.

- 2 Press the **Menu Select** button directly below IMPT to indicate the message as important.

The priority status icon appears beside the normal message icon on the label bar.

Removing a Priority Status from a Text Message

Ensure there is an outgoing message composed to allow you to perform this procedure. See [Composing](#)

[and Sending a New Text Message](#) on page 86 for more information.

- 1 Press the **Menu Select** button directly below OPTN.

- 2 Press the **Menu Select** button directly below IMPT to remove the priority status icon.

The display shows the normal message icon on the label bar.

Appending a Request Reply to a Text Message

Ensure that an outgoing message is composed to allow you to perform this procedure. See [Composing and Sending a New Text Message](#) on page 86 for more information

- 1 Press the **Menu Select** button directly below OPTN.

- 2 Press the **Menu Select** button directly below RQRP to request for a reply.

The request reply icon appears beside the normal message icon on the label bar.

Removing a Request Reply from a Text Message

Ensure that an outgoing message is composed to allow you to perform this procedure. See [Composing and Sending a New Text Message](#) on page 86 for more information.

- 1 Press the **Menu Select** button directly below OPTN.

- 2 Press the **Menu Select** button directly below RDRP to remove the reply status icon.

The display shows the normal message icon on the label bar.

Appending a Priority Status and a Reply Request to a Text Message

Ensure that an outgoing message is composed to allow you to perform this procedure. See [Composing and Sending a New Text Message](#) on page 86 for more information.

- 1 Press the **Menu Select** button directly below OPTN.

- 2 Press the **Menu Select** button directly below IMPT to indicate the message as important.

- 3 Press the **Menu Select** button directly below RDRP to request for a reply.

The priority status and request reply icons appear beside the normal message icon on the label bar.

Removing a Priority Status and a Reply Request from a Text Message

Ensure that a outgoing message is composed to allow you to perform this procedure. See [Composing and Sending a New Text Message](#) on page 86 for more information.

- 1 Press the **Menu Select** button directly below OPTN.

- 2 Press the **Menu Select** button directly below IMPT to remove the priority status icon.

- 3 Press the **Menu Select** button directly below RDRP to remove the reply status icon.

The display shows the normal message icon on the label bar.

Receiving a Text Message



Note:

When you receive a message that is flagged with the “Request Reply” icon, you must manually respond to the sender that you have received the message. The system will not automatically send a notification to acknowledge that the message was received.

The following methods are options on how to receive a text message. The result of all the methods is the same. You can use the options interchangeably depending on your preference and the programmed functions.

- Receiving a text message via the **Data Feature** button or the **TMS Feature** button:
 - a) When you receive a message, press and hold the preprogrammed **Data Feature** button or the **TMS Feature** button to access the Inbox. The display shows a list of aliases or IDs, with the sender of the latest received message on top.
-
- Receiving a text message via the radio menu:

- a) When the new message icon appears and the display shows momentary **NEW MSG**, press the **Menu Select** button directly below **TMS** to access the Inbox. The display shows a list of aliases or IDs, with the sender of the latest received message on top.

Viewing a Text Message from the Inbox

The Inbox can hold up to thirty (30) messages.



Note:

◀ or ▶ to read the message if the content fills more than one screen.

- 1 Perform one of the following actions:
 - Press the preprogrammed **Data Feature** button or the **TMS Feature** button to access the TMS feature screen. Press the **Menu Select** button directly below **INBX**.
 - Press and hold the preprogrammed **Data Feature** button or the **TMS Feature** button to access the Inbox.
 - ◀ or ▶ to **TMS** and press the **Menu Select** button directly below **TMS** to access the TMS feature

screen. Press the **Menu Select** button directly below INEX.

The display shows the latest received message.

- 2 While on the view message screen, press the **Menu Select** button directly below RPLY, DEL, or BACK to access the option.

- Select RPLY to reply the message.
- Select DEL to delete the message.
- Select BACK to return to the previous screen.



Note:

The icon at the top right corner of the screen indicates the status of the message. See [Text Messaging Service \(TMS\) Indicators](#) on page 38 for more information.

Replying to a Received Text Message



Note:

The original date and time stamp, address and message content is automatically appended to the reply message.

- 1 Press the **Menu Select** button directly below RPLY to reply to a message.
-

- 2 Perform one of the following actions:

- Press the **Menu Select** button directly below NEW to compose a new message.
- Press the **Menu Select** button directly below LIST to select a predefined message.
- ◀ or ▶ to scroll through the list of predefined messages and press the **Menu Select** button directly below SEL to select the required message.

One of the following scenarios occurs:

- A blinking cursor appears on the Compose screen.
 - The predefined message appears on the Compose screen, with a blinking cursor at the end of it.
-

- 3 Use the keypad to type or edit your message.
-

- 4 Press the **Menu Select** button directly below OPTN once you have completed the message.
-

- 5 Press the **Menu Select** button directly below SEND to send the message.
-

The display shows the **Send Message** screen and **SENDING MSG.**



Note:

Press the **Menu Select** button directly below **BACK** at any time to return to the previous screen.

You can append a priority status and/or a request reply to your message. See [Priority Status and Request Reply of a New Text Message](#) on page 88 for more information.

Accessing the Drafts Folder

This folder stores the messages that were saved previously. The Drafts folder can hold up to 10 messages. The oldest draft in the folder is deleted when the 11th message comes in.

1  or  to TMS.

2 Press the **Menu Select** button directly below TMS to access the TMS feature screen.

3 Press the **Menu Select** button below **DRFT.**

The display shows the latest drafted text message.

4 Press the **Menu Select** button directly below **EDIT**, **DEL**, or **BACK** to access the option.

- Select **EDIT** to edit the message before sending it.
- Select **DEL** to delete the message.
- Select **BACK** to return to the previous screen.

Sent Text Messages

Once a message is sent to another radio, it is saved in the Sent folder. The most recent sent text message is always added to the top of the Sent list.

The Sent folder is capable of storing a maximum of ten (10) last sent messages. When the folder is full, the oldest message in the folder is deleted when the 11th message comes in.

Viewing a Sent Text Message

1 Perform one of the following actions:

- Press the preprogrammed **Data Feature** button or the **TMS Feature** button to access the TMS feature screen.

- ◀ or ▶ to TMS and press the **Menu Select** button directly below TMS to access the TMS feature screen.

2 Press the **Menu Select** button below SEND.

The display shows the latest sent message.

3 While on the view message screen, press the **Menu Select** button directly below OPTN, DEL or BACK to access the option.

- Select OPTN to configure the message settings.
- Select DEL to delete the message.
- Select BACK to return to the previous screen.



Note:

The icon at the top right corner of the screen indicates the status of the message. See [Text Messaging Service \(TMS\) Indicators](#) on page 38 for more information.

Sending a Sent Text Message

- 1 Press the **Menu Select** button directly below OPTN while viewing the message.

- 2 Press the **Menu Select** button directly below SEND.

3 Perform one of the following actions:

- ◀ or ▶ to scroll through the address list and select the required address.
- ◀ or ▶ to [OTHER RECPNT] and press the **Menu Select** button below EDIT. When a blinking cursor appears in the ENTER ADDRESS screen, use the **keypad** to type the address entry.

-
- 4 Press the **Menu Select** button below SEND or the PTT button to send the message.

The display shows the SEND MESSAGE screen and SENDING MSG.





Note:

Press the **Menu Select** button directly below BACK at any time to return to the previous screen.

You can append a priority status and/or a request reply to your message. See [Priority Status and Request Reply of a New Text Message](#) on page 88 for more information.

Deleting Text Messages

- 1 From the Inbox, Draft, or Sent screen,  or  to scroll through the messages.

- 2 Press the **Menu Select** button directly below DEL to view the delete options.



- 3 Perform one of the following actions:
 - Press the **Menu Select** button directly below CURR to delete the current message.
 - Press the **Menu Select** button directly below ALL to delete all the messages.

Secure Operations

Secure radio operation provides the highest commercially available level of voice security on both trunked and conventional channels.

Unlike other forms of security, Motorola digital encryption provides signaling that makes it virtually impossible for others to decode any part of an encrypted message.

Enabling Secure Transmission

- 1  or  to SEC and press the **Menu Select** button directly below SEC.
The display shows  and the current key if multi-key has been enabled.

- 2 Monitor the mode to be sure it is not in use.

- 3 Press **PTT** button to transmit.



Note:

If the selected channel is preprogrammed for clear-only operation – when you press the **PTT** button, an invalid mode tone sounds and the display shows CLEAR TX only.

The radio does not transmit until you disable the secure mode.

The radio can be configured to ignore the clear voice or unsecured transmission when the radio is in secured transmission. Check with your agent for details.

Accessing the Secure Feature

- 1  or  to SEC.
- 2 Press and hold the **Menu Select** button directly below SEC to display Secure feature screen.

The display shows the `Secure` screen.

Managing Encryption

Loading the Encryption Key(s)





Note:

Refer to the key-variable loader (KVL) manual for equipment connections and setup.

- 1 Attach the KVL to your radio.
The display shows `KEYLOADING`, and all other radio functions are locked out, except for power down, and volume.
- 2 Press the **Menu Select** button below `TARGET`.
- 3 Press the **Menu Select** button below `LOAD`.
- 4 Perform one of the following actions:
 - Press the **Menu Select** button below `KEY` for single-key.

- Press the **Menu Select** button below `GROUP` for multikey.

- 5  or  to the required key or group.

- 6 Press the **Menu Select** button below `LOAD` to load the key to your radio.

When the key has been loaded successfully, one of the following scenarios occurs:

- You hear a short tone for single-key radios.
- You hear an alternating tone for multikey radios.

Multikey Feature

This feature allows the radio to be equipped with different encryption keys and supports the DES-OFB algorithm.

There are two types:

Conventional Multikey



The encryption keys can be tied (strapped), on a one-per-channel basis, through Customer Programming Software. In addition, you can have operator-selectable keys, operator-selectable keysets, and operator-selectable key

Trunked Multikey



erasure. If talkgroups are enabled in conventional, then the encryption keys are strapped to the talkgroups.

If the radio is used for both conventional and trunked applications, strap the encryption keys for trunking on a per-talkgroup or announcement-group basis. In addition, a different key can be strapped to other features, such as dynamic regrouping, failsoft, or emergency talkgroup. You can have operator-selectable key erasure.

Selecting an Encryption Key

- 1  or  to KEY.

- 2 Press the **Menu Select** button directly below KEY. The display shows the last user-selected and stored encryption key, and the available menu selections.

- 3  or  to scroll through the encryption keys or use the keypad to enter the number of the desired key.

- 4 Perform one of the following actions:

- Press the **Menu Select** button directly below SEL to save the newly selected key and return to the **Home** screen.
- Press , the **PTT** button, or the **Menu Select** button directly below EXIT.
- Turn the **16-Position Select** knob to exit.



Note:

When the selected key is erased, you hear a momentary keyfail tone and the display shows KEY FAIL.

When the selected key is not allowed, you hear a momentary illegal key tone and the display shows ILLEGAL KEY.

Selecting a Keyset

This feature allows you to select one or more groups of several encryption keys from among the available keys stored in the radio.

For example, you could have a group of three keys structured to one keyset, and another group of three different keys structured to another keyset; by

changing keysets, you would automatically switch from one set of keys to the other.

Every channel to which one of the original keys was tied now has the equivalent new key instead.

- 1 ◀ or ▶ to KSET and press the **Menu Select** button directly below KSET.

The display shows the last user-selected and stored keyset, and the available keyset menu selections.

- 2 ◀ or ▶ to scroll through the keysets or use the keypad to enter the number of the desired keyset.
-

- 3 Press the **Menu Select** button directly below SEL to save the newly selected keyset.
The radio exits keyset selection and returns to the **Home** screen.



Note:

Press , the **PTT** button, or the **EXIT** menu selection to exit this menu at any time without changing the keyset selection.

Erasing the Selected Encryption Keys

This feature allows you to erase all or selected encryption keys.

Erasing the selected encryption keys via the radio menu:

- a) ◀ or ▶ to ERAS and press the **Menu Select** button directly below ERAS.
The display shows the last user-selected and stored encryption key, and the available menu selections.
- b) ◀ or ▶ to the desired encryption key or use the keypad to enter the number of the desired key.
- c) Press the **Menu Select** button directly below ALL to delete all keys, or press the **Menu Select** button directly below SHGL to delete current shown key.



You can abort this screen and return to Home screen by pressing the **Menu Select** button directly below ABRT.

Requesting an Over-the-Air Rekey (ASTRO Conventional Only)

Ensure that the Unique Shadow Key (USK) is loaded into the radio with the key-variable loader (KVL)

before the rekey request can be sent. Refer to your local key management supervisor for more information.

This feature, also known as OTAR, allows the dispatcher to reprogram the encryption keys in the radio remotely. The dispatcher performs the rekey operation upon receiving a rekey request from the user.

- 1  or  to REKY.

- 2 Press the **Menu Select** button directly below REKY.

- 3 Perform one of the following actions:
 - Press the **PTT** button to send the rekey request.
 - Press the **PTT** button again, or the  or **Emergency** button, to exit the feature and transmit in normal mode.

If the rekey operation fails, you hear a bad-key tone and the display shows REKEY FAIL.



Note:

The rekey operation failure indicates that your radio does not contain the Unique Shadow Key (USK).

MDC Over-the-Air Rekeying (OTAR) Page

This feature allows you to view or define MDC Over-the-Air Rekeying (OTAR) features. It is applied only when operating in secure encrypted mode and only for conventional communications. In addition to Rekey Requests, OTAR transmissions include Delayed Acknowledgements, and Power-up Acknowledgements.

Some of the options selected may also need to be set up at the Key Management Controller (KMC) site to work properly.



Note:

This feature must be preprogrammed by a qualified radio technician. Check with your dealer or system administrator for more information.

Infinite UKEK Retention

This feature enables Unique Key Encryption Key (UKEK) to be permanently stored in the radio even

when all of the encryption keys is erased. Without this UKEK key, the radio cannot be rekeyed over the air.



Note:

This feature must be preprogrammed by a qualified radio technician. Check with your dealer or system administrator for more information.

Hear Clear



Note:

This feature must be preprogrammed by a qualified radio technician. Check with your dealer or system administrator for more information.

There are two components of Hear Clear.

Companding Reduces the channel noise, e.g. OTA transmission, that is predominantly present in UHF2 and 900 MHz channel with the following features.

Compressor Reduces the background noise flow and the speech

signal at transmitting radio.

Expander

Expands the speech while the noise flow remains the same at receiving radio.

Random FM Noise Canceller (Flutter Fighter)

Reduces the unwanted effects of random FM noise pulses caused by channel fading under high Signal-to-Noise (S/N) conditions such as in a moving transportation. The fading effects, heard as audio pops and clicks, are cancelled without affecting the desired audio signal.

The Random FM Noise Canceller operates only in receive mode.

Global Positioning System / Global Navigation Satellite System



Note:

This feature is addressed as GPS across the manual as the naming convention of the buttons and strings remain the same as the legacy feature of GPS.

The availability and accuracy of this location information (and the amount of time that it takes to calculate it) varies depending on the environment in which you are using the GPS feature.

For example, GPS location fixes are difficult to obtain indoors, in covered locations, between high buildings, or in situations where you have not established a clear broad view of the sky.

GPS Operation

The GPS technology uses radio signals from earth orbiting satellites to establish location coordinates. Therefore, maximizing your view of unobstructed sky is essential for optimum performance.

Where adequate signals from multiple satellites are not available (usually because you cannot establish a view of a wide area of the sky), the GPS feature of

your radio will not work. Such situations include but are not limited to:

- Underground locations
- Inside buildings, trains, or covered vehicles
- Under any metal, or concrete roof, or structure
- Between tall buildings or under dense tree-cover
- In temperature extremes outside the operating limits of your radio

Even where location information can be calculated in such situations, it may take longer to do so, and your location estimate may not be as accurate. Therefore, in any emergency situation, always report your location to your dispatcher.

Keep in mind that the accuracy of the location information and the time it takes to obtain it varies depending upon circumstances, particularly the ability to receive signals from an adequate number of satellites.



Note:

Even where adequate signals from multiple satellites are available, your GPS feature only provides an approximate location, usually within 10 meters from your actual location, but sometimes farther away.

The satellites used by the GPS feature are controlled by the U.S. government and are subject to changes implemented in accordance with the Department of Defense GPS user policy and the Federal Radio Navigation Plan. These changes may affect the performance of the GPS feature on your radio.

GPS Performance Enhancement

Sometimes, the GPS feature may be unable to complete a location calculation successfully. You then see a message indicating that your radio cannot connect to enough visible satellites.

To maximize the ability of your radio to determine a fix, take note of the following guidelines:

- For your initial fix, hold the radio in the face position.
- Stay in the open. The GPS feature works best where there is nothing between your radio and the open sky.

The Outdoor Location Feature (Using GPS)

This feature allows you to determine your current location using a location menu, as well as your current distance and bearing in relation to another

location. Radio location may be requested and reported over-the-air.

Your radio stores up to a maximum of sixty (60) programmable location coordinates, also known as waypoints. When the memory is full, the next waypoints automatically replaces the oldest waypoints in the radio.

The radio also stores four (4) preprogrammed waypoints. These coordinates cannot be deleted.

The following table shows the differences between programmable waypoints and preprogrammed waypoints.

Programmable Waypoints	Preprogrammed Waypoints
User-configurable location coordinates.	Fixed location coordinates: <ul style="list-style-type: none"> • Home • Emergency • Last Known Location • Destination

Programmable Way-points	Preprogrammed Way-points
Only the alias is editable, not the coordinates.	The Home and Destination coordinates are editable.
Coordinates can be deleted one at a time, or all at once.	Coordinates cannot be deleted.

**Note:**

The radio automatically exits the feature, if the feature inactivity timer is enabled, when the radio is left idle and the timer expires. You hear the Menu Inactive Exit Tone upon feature exit.

Accessing the Outdoor Location Feature

**Note:**

An **ON** radio menu may be present on the Location menu screen if it is preprogrammed by the dealer or system administrator.

- 1 ◀ or ▶ to LOC.
- 2 Press the **Menu Select** button directly below LOC.

The display shows LOCATION OFF <LATITUDE>.

- 3 Press the **Menu Select** button directly below On to turn on the GPS.
The display shows PREVIOUS LOC <LATITUDE>.
- 4 ◀ or ▶ to check the longitude, time and date of the last successful location fix.
- 5 To obtain a new location fix, press the **Menu Select** button directly below RFSH.
The top line temporarily displays PLEASE WAIT while the new location is being determined. While the new location is being determined, the location signal can be a solid or blinking icon. The location coordinates are updated automatically every 5 seconds while the location signal is present.
- 6 To return to the **Home** screen, press , the **PTT** button, or the **Menu Select** button directly below EXIT.

Turning Off GPS

- 1 ◀ or ▶ to LOC.
- 2 Press the **Menu Select** button directly below LOC.

The display shows PREVIOUS LOC <LATITUDE>.

3 ◀or▶ to check the time and date of the last successful location fix.

4 Press the **Menu Select** button directly below OPTN.

5 ◀or▶ to TURN OFF GPS (if preprogrammed).

6 Press the **Menu Select** button directly below SEL to turn off the GPS.
The display shows LOCATION OFF.

7 To return to the **Home** screen, press , the **PTT** button, or the **Menu Select** button directly below EXIT.

Saving a Waypoint

Ensure that your radio shows the current location on the screen.

1 Press the **Menu Select** button directly below OPTN.

2 Perform one of the following actions:

- ◀or▶ to SAVE AS WAYPT and press the **Menu Select** button directly below SEL.
- ◀or▶ to SAVE AS HOME and press the **Menu Select** button directly below SEL and proceed to step 5.
- ◀or▶ to SAVE AS DEST. and press the **Menu Select** button directly below SEL and proceed to step 5.

A blinking cursor appears in the screen.

3 Use the **keypad** to edit the auto-generated waypoint, if required, or press the **Menu Select** button directly below CNCL to return to the Location main screen.







4 Press the **Menu Select** button directly below OK once you are done.
One of the following scenarios occur:



- The display shows SAVED AS <WAYPOINT NAME>.
 - The display shows SAVED AS HOME.
 - The display shows SAVED AS DEST..
-

- 5 To return to the Home screen, press , the **PTT** button, the preprogrammed **GPS** button or the **Menu Select** button directly below **EXIT**.

Viewing a Saved Waypoint

Ensure your radio shows the current location on the screen.







- 1 Press the **Menu Select** button directly below **OPTN**.
- 2  or  to **WAYPOINTS** and press the **Menu Select** button directly below **SEL**.
The display shows a list of waypoints.
- 3 Perform one of the following actions:
 -  or  to scroll through the list.
 -  or  to select a waypoint to view the location information in full.
- 4 Press the **Menu Select** button directly below **OPTN**.

- 5 To view the longitude, time and date of the selected waypoint,  or  to **VIEW** and press the **Menu Select** button directly below **SEL**.

- 6 To return to the previous screen, press the **Menu Select** button directly below **BACK**, or to return to the Home screen, press  or the **PTT** button.

Editing the Alias of a Waypoint

Ensure your radio shows the current location on the screen.

- 1 Press the **Menu Select** button directly below **OPTN**.
- 2  or  to **WAYPOINTS** and press the **Menu Select** button directly below **SEL**.
The display shows a list of waypoints.
- 3  or  to the required saved waypoint, and press the **Menu Select** button directly below **OPTN**.
- 4  or  to **EDIT NAME** and press the **Menu Select** button directly below **SEL**.

A blinking cursor appears in the EDIT NAME screen.

- 5 Use the **keypad** to edit the alias.
 - 6 Perform one of the following actions:
 - Press the **Menu Select** button directly below OK once you are done.
 - Press the **Menu Select** button directly below CNCL to return to the Waypoints main screen.
-

7 The display shows <WAYPOINT NAME> UPDATED and the radio returns to the Waypoints main screen.

- 8 Perform one of the following actions:
 - Press the **Menu Select** button directly below BACK to return to the previous screen.
 - Press  or the **PTT** button to return to the Home screen.
-





Editing the Coordinates of a Waypoint



Note:

Only the preprogrammed coordinates of Home and Destination can be edited by the user.

Ensure your radio shows the current location on the screen.

- 1 Press the **Menu Select** button directly below OPTN.
- 2  or  to WAYPOINTS and press the **Menu Select** button directly below SEL.
The display shows a list of waypoints.
- 3 Perform one of the following actions:
 - or to [HOME] and press the **Menu Select** button directly below OPTN.
 - or to [DESTINATION] and press the **Menu Select** button directly below OPTN.
- 4  or  to EDIT LOCATION and press the **Menu Select** button directly below SEL.
The first number blinks.
- 5 Utilize the following control buttons to select the number/coordinates if required, then press the **Menu Select** button directly below EDIT to change the number/coordinates.

- Press **◀** to move to the previous number/coordinates.
- Press **▶** to move to the next number/coordinates.
- Press **▲** or **▼** to change the North (N), South (S), East (E) or West (W) direction.

A blinking cursor appears in the EDIT LOCATION screen.

- 6** Utilize the following control buttons or menu to change the number/coordinates if required then press the **Menu Select** button directly below **OK** once.

- Press **◀** to move one space to the left.
- Press **▶** to move one space to the right.
- Press the **Menu Select** button directly below **DEL** to delete any unwanted characters.
- Press the **Menu Select** button directly below **CNCL** to return to the previous screen

- 7** Press the **Menu Select** button directly below **OK** once complete setting up the new Home or Destination.

One of the following scenarios occurs:

- The display shows [HOME] UPDATED and the radio returns to the Waypoints main screen.
- The display shows [DESTINATION] UPDATED and the radio returns to the Waypoints main screen.

Deleting a Single Saved Waypoint

Ensure your radio shows the current location on the screen.

- 1** Press the **Menu Select** button directly below **OPTN**.
- 2** **◀** or **▶** to **WAYPOINTS** and press the **Menu Select** button directly below **SEL**.
The display shows a list of waypoints.
- 3** Perform one of the following actions:
 - **◀** or **▶** to the required saved waypoint, and press the **Menu Select** **OPTN**. **◀** or **▶** to **Edit name** and press the **Menu Select** button directly below **Del**.
 - Press the **Menu Select** button directly below **Del**.

- 4 The display shows <WAYPOINT NAME> CONFIRM DEL?.

- 5 Press the **Menu Select** button directly below YES to delete the waypoint or press the **Menu Select** button directly below NO to return to the Waypoints main screen.

The display shows <WAYPOINT NAME> DELETED .

Deleting All Saved Waypoints

Ensure your radio shows the current location on the screen.



Note:

You cannot delete any of the preprogrammed waypoints.

- 1 Press the **Menu Select** button directly below OPTN.

- 2 ◀ or ▶ to WAYPOINTS and press the **Menu Select** button directly below SEL.
The display shows a list of waypoints.

- 3 ◀ or ▶ to the required saved waypoint, and press the **Menu Select** button directly below OPTN.

- 4 ◀ or ▶ to DELETE ALL and press the **Menu Select** button directly below SEL.
The display shows ALL SAVED WAYP CONFIRM DEL?.

- 5 Press the **Menu Select** button directly below YES to delete all waypoints or press the **Menu Select** button directly below NO to return to the Waypoints main screen.

The display shows ALL SAVED WAYP DELETED.

Measuring the Distance and Bearing from a Saved Waypoint

Ensure your radio shows the current location on the screen.

- 1 Press the **Menu Select** button directly below OPTN.

- 2 ◀ or ▶ to DIST FRM HERE and press the **Menu Select** button directly below SEL.
The display shows a list of waypoints.

- 3 ◀ or ▶ to the required waypoint and press the **Menu Select** button directly below SEL.

The display shows the distance and bearing from the current to the selected coordinates.

Location Feature in Emergency Mode

When the Emergency feature is activated by pressing the emergency button, the radio exits the Location menu and returns to the Home (default) screen so that you can see which channel the emergency signal is going out on.

However, you may re-enter the Location menu while still in emergency mode, provided that Silent Emergency has not been activated.

If you have turned Location off using the **ON/OFF** menu key, it automatically turns back on when Emergency is activated.

If there is a solid location signal during Emergency, the current location and the location information received is saved as Emergency and Last Known Location waypoints, respectively.

Peer-Location on the Display (ASTRO Conventional only)

This feature is only available for radio-to-radio voice transmissions, dispatch call and selective call in conventional ASTRO system. For radio-to-radio

transmission, in order to allow the radio to show peer-location, the voice should be directly sent from one radio to another radio without passing through any infrastructure facility such as repeaters, phone or DVRS system. Both the transmitting radio and receiving radio must be configured to enable them to send and/or receive the GPS coordinates. You can check with your nearest qualified technician for more details.



Note:

If the receiving radio is operating in a Mixed Mode channel, and the voice transmission is via conventional ASTRO system then the radio can receive the location coordinates of its peers.

This feature is also operable in a Scan Active channel or Scan Talkback channel.

Upon receiving a voice transmission with GPS coordinates enabled on the receiving radio, the display shows the coordinates available in full or in short coordinates. There are two different formats available. Refer to the following list for the details shown in the Peer-Location quick text. Consult your agent to pick the best format to configure to your radio.

Full location coordinates

- PTT ID (This is optional.)
- Longitude and latitude
- Relative distance or direction.

Short location coordinates

- PTT ID (This is optional.)
- Longitude and latitude

**Note:**

If the transmitting radio is stale at its location after a period of time, the receiving radio display shows `LAST KNOWN LOC:`
`<Coordinates> <distance>` on top of
`ID:<PTT ID>`. The `PTT ID` seen here is optional to be shown on the display per requirement of usage.

If the transmitting radio does not have GPS or the receiving radio could not decode the GPS signal of the received signal, the receiving radio display shows `UNKNOWN LOC` on top of
`ID:<PTT ID>`. If the radio is not configured to show `PTT ID`, you see only `UNKNOWN LOC`.

Geofence (ASTRO 25 Trunking System)

Geofence is a virtual perimeter based on the GPS to define a geographical area on earth.

Check with your dealer or qualified technician to programme the geofence coordinates and actions.

When the radio enters the predefined Geofence area, your radio receives the Dynamic Regroup command from the system and immediately connects to a Dynamic Regroup talkgroup. The radio display shows the new selected Dynamic Regrouped talkgroup with green intelligent light for your attention.

On top of that, additional features are Voice Announcement of the new channel, and also direct content display of a text message to indicate that you are currently at Geofence area. Check with your nearest qualified technician on the requirements for these enhancements to work in Geofence.

Any new text messages received at Geofence shall have its content displayed immediately on the radio display.

**Note:**

If the radio is set up in DVRS, only mobile radio is supported for this feature.

Entering the Geofence Area

The Voice Announcement and TMS display in this feature are optional. They must be configured to enable you to hear and see these indicators.

When the radio enters a Geofence area, the radio immediately sends a message ACK back to the system.

The radio searches the current zone for the channel with same talkgroup assigned as the Dynamic Talkgroup and also with same system ID of current trunk system. Once matched, the radio display shows the first matched and connected channel alias.

If there is no channel with matching Talkgroup ID and trunk system ID, the radio display shows the channel alias of <DYNAMIC talkgroup>.

Once the radio is connected, you hear a dynamic regroup tone, the radio display shows <DYNAMIC channel> with temporary green color intelligent backlight and you hear a Voice Announcement.



Note:

When the radio loses the GPS signal, the GPS icon blinks and the radio sounds two high-pitched tones repetitively to indicate that the

GPS has failed to operate. The radio display shows the red intelligent light.



Note:

If the first matched channel is not configured with Voice Announcement, no Voice Announcement is played.

The system sends a message to your radio. The radio display shows a direct text message content without any user operation. This message indicates you are currently present in a Geofence area. This TMS remains open on the display until user presses exit/home to exit this screen.



Note:

If there is another incoming text message before you exit the previous message, the message screen shall be refreshed to show the latest message.

The following procedure guides you to exit the text message received.

Press the **Menu Select** button below EXIT or  to return to **Home** screen.

The other operations are the same as normal dynamic regroup command.

When the radio exits the Geofence area, your radio reverts to original channel or newly assigned talkgroup. The radio display shows the new channel together with Voice Announcement to indicate the changes. Voice Announcement of the new channel only works if that channel is configured with Voice Announcement.

Mission Critical Geofence

This feature allows the radio to use the GPS receiver to determine radio location at frequent intervals.

This feature also allows the radio to evaluate if the radio is within the Geofence area in real time.

Check with your dealer or qualified technician to programme the geofence coordinates and actions.

Entering Mission Critical Geofence

When the radio enters the predefined Geofence area, the radio displays <Geofence Alias> with intelligent backlight and the user hears a Voice Announcement. Zone and channel alias of the Geofence area is displayed. If the radio is set to manual, the user can choose either to proceed with zone and channel change or cancel the change.

The radio then connects to the designated talkgroup. The radio displays the talkgroup alias and dynamic regroup tone sounds. The transmit power level changes and the radio shows a direct text message content without any user operation.



Note:

Depending on how your radio is programmed, you may or may not be alerted by Voice Announcement (VA), TMS display, Intelligent Backlight, and the Transmit Power Level. The user will be alerted only if these indicators are configured in the radio. The VA can be programmed to alert continuously or momentarily.



Note:

If Site Selectable Alert (SSA) is enabled, the radio mutes any alert that is received when entering the Geofence area and unmutes when exiting.

Exiting Mission Critical Geofence

When the radio exits the Geofence area, the radio reverts to the original transmit power level, intelligent lighting, channel or newly assigned talkgroup. Voice announcement is cancelled or the user hears a pre-programmed VA tone. The radio displays the new

channel and a message is received to indicate the changes.

Trunking System Controls

Operating in Failsoft System

The failsoft system ensures continuous radio communication during a trunked system failure. If a trunking system fails completely, the radio goes into failsoft operation and automatically switches to its failsoft channel.

During failsoft operation, your radio transmits and receives in conventional operation on a predetermined frequency. You hear a medium-pitched tone and the display shows FAILSOFT.

When the trunking system returns to normal operation, your radio automatically leaves failsoft operation and returns to trunked operation.

To continue in Failsoft and to communicate with other talkgroups, refer to the following procedure.

- 1 Rotate the **Mode Knob** to change to a different repeater frequency.
-

- 2 Press the **PTT** button to talk, and release the button to listen.
-

Out-of-Range Radio

When your radio goes out of the range of the system, it can no longer lock onto a control channel.

You hear a low-pitched tone and/or the display shows the currently selected zone/channel combination and OUT OF RANGE. Your radio remains in this out-of-range condition until it locks onto a control channel, it locks onto a failsoft channel, or it is turned off.

SmartZone

The SmartZone™ feature extends communications beyond the reach of a single-trunked site (antenna location) when operating in a SmartZone system. SmartZone units provide expanded wide-area coverage.

SmartZone automatically switches the radio to a different site when the current site signal becomes unacceptable. This usually happens when the vehicle in which the radio is located is driven out of the range of one site, and into the range of another.

Under normal conditions, a SmartZone-enabled radio functions invisibly to the operator. However, the operator does have some manual controls on the Control Head – the **RSSI** menu entry. This button can be used to check, or change, the SmartZone operation.

Site Trunking Feature

If the zone controller loses communication with any site, that site reverts to site trunking.

The display shows the currently selected zone/channel combination and **SITE TRUNKING**.



Note:

When this occurs, you can communicate only with other radios within your trunking site.

Locking and Unlocking a Site

This feature allows your radio to lock onto a specific site and not roam among wide-area talkgroup sites. This feature should be used with caution, since it inhibits roaming to another site in a wide-area system.

You can toggle the lock state between locked and unlocked by pressing the preprogrammed **Site Lock/Unlock** button.

Follow the procedure to lock and unlock a site via the radio menu.

1  or  to **SITE**.

2 Press the **Menu Select** button directly below **SITE**.

3 Perform one of the following actions:

- To lock the site, press the **Menu Select** button directly below **LOCK**. The display shows **SITE LOCKED**.
 - To unlock the site, press the **Menu Select** button directly below **UNLK**. The display shows **SITE UNLOCKED**.
-

The radio saves the new site lock state and returns to the Home screen.

Site Display and Search Button

The **Site Display** and **Site Search** button allows you to view the name of the current site or force your radio to change to a new one.

Viewing the Current Site

Perform one of the following actions:

- Press the preprogrammed **Site Search** button.
- ◀ or ▶ to **RSSI** and press the **Menu Select** button directly below **RSSI**.

The display shows momentarily the name of the current site and its corresponding received signal strength indicator (RSSI).

Changing the Current Site

Perform one of the following actions:

- Press and hold down the preprogrammed **Site Search** button.
- Press and hold down the **Menu Select** button directly below **RSSI**.

You hear a tone and the display shows momentary **SCANNING SITE**.

When the radio finds a new site, it returns to the Home screen.

Trunked Announcement

The announcement capability allows you to make announcements to the entire user group, as well as monitor talkgroup calls and other announcements.

Announcement calls are handled in two different ways, depending on the trunked central controller configuration. The two types are called ruthless and non-ruthless preemption.

Ruthless Preemption

When a ruthless preemption announcement call is initiated, the requesting radio begins transmitting immediately. All associated talkgroup calls taking place on other channels are immediately halted, and the radios are steered to the announcement call.

Transmitting radios continue to transmit until the **PTT** button is released, at which time they also unmute for the announcement call. Individual calls (Private Conversation and telephone interconnect) are not affected.

Non-Ruthless Preemption

When a non-ruthless preemption announcement is initiated, the initiating unit receives a telephone-type busy tone, followed by a call

back when all associated talkgroup conversations end.

Once an announcement call is pending, any attempts by other users to initiate a talkgroup call will result in a telephone-type busy tone. These users will not receive a call back until the announcement call is complete.

Initiating an Announcement

Ensure your radio has been programmed to allow announcement calls.

- 1 Turn the **Mode Knob** to locate the announcement-group mode.
- 2 Press the **PTT** button to initiate the announcement.

Ignition Switch Options

This feature allows the user to select the functionality of the radio based on the Ignition State of the radio user's vehicle. The following options are available.

Blank

This option allows the user to power on and power off the radio through the **Power** button regardless of the current state of the Ignition.

Tx Inhibit

This option allows the user to power on and power off the radio through the **Power** button regardless of the current state of the Ignition. In addition, if the Ignition is not present, then all transmissions are inhibited. This includes receiving any Trunking dispatch communications since the radio will not affiliate with the Trunking systems.

PTT Tx Inhibit

This option allows the user to power on and power off the radio through the **Power** button regardless of the current state of the Ignition. In addition, if the Ignition is not present, then all **PTT** button transmissions are inhibited. However, the radio is able to affiliate with the Trunking systems.

Required

This option allows the user to power on the radio only if the Ignition is present. The radio can be powered off either through **Power** button press or when Ignition is

lost. In addition, the radio automatically powers on when the Ignition is present only if the radio was turned off due to the ignition being removed.

This option allows the radio to power off when Inactivity Auto Power Off Timer expires, or, when Ignition Auto Power Off Timer expires.

Soft Power Off

This option allows the user to power on the radio either through **Power** button presses or when the Ignition is detected. Meanwhile, if the **Power** button was pressed or the Ignition was removed, the radio will be turned off.

This option allows the radio to power off when Inactivity Auto Power Off Timer expires, or, when Ignition Auto Power Off Timer expires.

Ignition Only Power Up

This option allows the user to power on the radio only when Ignition is detected and will power off when it is removed. The radio does not power on or off with the Power button press.

This option allows the radio to power off when Inactivity Auto Power Off Timer expires, or, when Ignition Auto Power Off Timer expires.



Note:

While **Ignition** is not present, the radio powers-off with a radio-user **Power Off** button / knob selection if the radio was powered-up with an Emergency Power Up footswitch-press or Ignition Auto Power Off timer is running.

While **Ignition** is present, the radio powers-on with a radio-user **Power On** button / knob selection only if the radio was powered-down with Inactivity Auto Power Off timer.

Using Emergency Power Up

This feature allows the user to power on the radio and automatically transmits an emergency mode transmission on personalities with emergency enabled, with the use of a footswitch. In addition, when the Ignition Switch option is set to either Tx Inhibit or PTT Tx Inhibit, this feature will not be available to the users.

Press the footswitch to turn on the radio and launch Emergency.

A tone sounds and the display shows Emergency.

Auto Power Off Timer

Auto Power Off feature powers off the radio when no user actions occur during a preprogrammed length of time. There are two different versions of Auto Power Off:

- | | |
|--|---|
| Inactivity Auto Power Off Timer | This timer begins once the radio is power-on. While the timer is active any user interaction with the radio resets the timer. |
| Ignition Auto Power Off Timer | This timer begins once the vehicle key is removed, when the voltage at the ignition sense is removed. While the timer is active any user interaction with the radio resets the timer. When the vehicle key is reapplied, the voltage at the ignition is reconnected, this timer is stopped. |

Although both Inactivity Auto Power Off and Ignition Auto Power Off can be enabled together, Ignition Auto Power Off timer is mutually exclusive with Inactivity Auto Power Off timer when both are enabled. During the last two minutes of the timer countdown, the radio generates continuous low tone and blinks Powering Off warning on the display until

the timer expires or the timer is reset. The radio automatically powers off after the timer expires. The duration of the timer is preprogrammed.

Voice Announcement

This feature enables the radio to audibly indicate the current feature mode, zone or channel the user has just assigned. This audio indicator can be customized per customer requirements. This is typically useful when the user is having difficulty reading the content shown on the display.

Each voice announcement is within a limit of three seconds maximum. The sum duration of all different voice announcements in a radio shall be no more than 1000 seconds.



Note:

This feature must be preprogrammed by a qualified radio technician.

Check with your agent if Voice Announcement is available for the feature you need.

The two options of priority for the Voice Announcement available are:

High Enables the voice of the feature to announce even when the radio is receiving calls.

Low Disables the voice of the feature from announcing when the radio is receiving calls.

You hear a voice announcement when the features below are preprogrammed in the radio.

- The radio powers up. The radio announces the current zone and channel it is transmitting.
- Press the preprogrammed voice announcement button (which specifically programmed to playback the current zone and channel). The radio announces the current zone and channel it is transmitting.



Note:

Pressing this preprogrammed playback button enables the voice feature to announce in High priority.

All the three programmable buttons at the side of the radio support this feature.

- Change to a new zone. The radio announces the current zone and channel it is transmitting.

- Change to a new channel remaining within the current zone. The radio announces the current channel.
- Press either the **Menu Select** button or preprogrammed button or switch of the radio to launch or terminate Scan, PL Disabled, Talkaround/Direct or Transmit Inhibit. The radio announces the corresponding feature activation or deactivation.

Site Selectable Alerts (ASTRO 25)

A Site Selectable Alert (SSA) is an Intelligent Lighting indicator together with audio alert sent to radios at a site or a few sites to notify the users when there is a special situation that they need to be aware of. Only authorized radios are enabled to send SSA.

Upon the activation of a SSA, the receiving radios display the alert alias and generate the periodic alert tone.



Note:

Alert alias, alert tone, and alert period can be preprogrammed. Alert period is the duration for the radio to repeat the alert tone. An interval of 5 seconds might impact the battery

life of the radio. Check with your dealer or system administrator for more details.

When mixing SSA with received voice audio, the SSA alert is reduced in volume to ensure that the voice message is still heard clearly. Therefore, it is important that the SSA audio files are created with clear loud audio to ensure they can still be heard clearly when played at reduced levels.

Sending SSA Notification to Single Site

- 1 ◀ or ▶ to SSA.

- 2 Press the **Menu Select** button directly below SSA. The display shows the **Site Alert** screen.

- 3 ◀ or ▶ to START ALERT and press the **Menu Select** button directly below SEL. The display shows the **Select Site** screen.

- 4 ◀ or ▶ to the desired Site Alias. Press the **Menu Select** button directly below SEL. The display shows the **Select Alert** screen.

- 5 ◀ or ▶ to select the desired Alert Alias and press the **Menu Select** button directly below SEND. The display shows SENDING REQ.

If radio is out of range, roaming to a foreign system or in a failsoft situation, the display shows REQ FAILED.

If the request is successful, the display shows REQ SUCCESSFUL.

If the site is not available, the display shows <SITE ALIAS> NOT AVAILABLE.

If the site does not exist, the display shows <SITE ALIAS> DOES NOT EXIST.

- 6 To return to the Home screen, press the **Menu Select** button directly below EXIT.
-

If you are at the site designated to receive this alert, you can hear an alert tone repeated periodically. The display shows the <ALERT ALIAS> with the intelligent lighting at Home screen.

Sending SSA Notification to Single Site Via Manual Entry

- 1 ◀ or ▶ to SSA.

- 2 Press the **Menu Select** button directly below SSA.
The display shows the **Site Alert** screen.

- 3 ◀ or ▶ to START ALERT and press the **Menu Select** button directly below SEL.
The display shows the **Select Site** screen.

- 4 ◀ or ▶ to [SITEID ENTRY] to send alert via manual entry. Press the **Menu Select** button directly below EDIT.
The display shows the **Enter SiteID** screen.

- 5 Key in the desired Site ID and press the **Menu Select** button directly below OK.
If a correct Site ID is entered, the display shows the **Select Alert** screen.

If a wrong Site ID is entered, the display shows INVALID ID and prompts to enter the Site ID again.

- 6 ◀ or ▶ to select the desired Alert Alias and press the **Menu Select** button directly below SEND.
The display shows SENDING REQ.

If radio is out of range, roaming to a foreign system or in a failsoft situation, the display shows REQ FAILED.

If the request is successful, the display shows REQ SUCCESSFUL.

If the site is not available, the display shows <SITE ID> NOT AVAILABLE.

If the site does not exist, the display shows <SITE ID> DOES NOT EXIST.

- 7 To return to the Home screen, press the **Menu Select** button directly below EXIT.

If you are at the site designated to receive this alert, you can hear an alert tone repeated periodically. The display shows the <ALERT ALIAS> with the intelligent lighting at Home screen.

Sending SSA Notification to All Sites

- 1 ◀ or ▶ to SSA.

- 2 Press the **Menu Select** button directly below SSA.
The display shows the **Site Alert** screen.

- 3 ◀ or ▶ to START ALERT and press the **Menu Select** button directly below SEL.
The display shows the **Select Site** screen.

- 4 ◀ or ▶ to [ALL SITES] and press the **Menu Select** button directly below SEL.
The display shows the **Select Alert** screen.

- 5 ◀ or ▶ to select the desired <Alert Alias> and press the **Menu Select** button directly below SEND.
The display shows SENDING REQ.

If radio is out of range, roaming to a foreign system or in a failsoft situation, the display shows REQ FAILED.

If the request is successful, the display shows REQ SUCCESSFUL.

If one or more sites are unavailable, the display shows NOT ALL SITES AVAILABLE. Repeat 3.

- 6 To return to the Home screen, press the **Menu Select** button directly below EXIT.

If you are at the site designated to receive this alert, you can hear an alert tone repeated periodically. The display shows the <ALERT ALIAS> with the intelligent lighting at Home screen.

Sending SSA Notification to All Available Sites

- 1 ◀ or ▶ to SSA.

- 2 Press the **Menu Select** button directly below SSA.
The display shows the **Site Alert** screen.

- 3 ◀ or ▶ to START ALERT and press the **Menu Select** button directly below SEL.
The display shows the **Select Site** screen.

- 4 ◀ or ▶ to [ALL AVAIL] and press the **Menu Select** button directly below SEL.
The display shows the **Select Alert** screen.

- 5 ◀ or ▶ to select the desired <Alert Alias> and press the **Menu Select** button directly below SEND.
The display shows SENDING REQ.

If radio is out of range, roaming to a foreign system or in a failsoft situation, the display shows REQ FAILED.

If the request is successful, the display shows REQ SUCCESSFUL.

- To return to the Home screen, press the **Menu Select** button directly below EXIT.

If you are at the site designated to receive this alert, you can hear an alert tone repeated periodically. The display shows the <ALERT ALIAS> with the intelligent lighting at Home screen.

Stopping SSA Notification of a Single Site

- ◀ or ▶ to SSA.
- Press the **Menu Select** button directly below SSA. The display shows the **Site Alert** screen.
- ◀ or ▶ to STOP ALERT and press the **Menu Select** button directly below Sel1. The display shows the **Select Site** screen.
- ◀ or ▶ to select the desired Site Alias and press the **Menu Select** button directly below SEND. The display shows SENDING REQ.

If radio is out of range, roaming to a foreign system or in a failsoft situation, the display shows REQ FAILED.

If the request is successful, the display shows REQ SUCCESSFUL.

If the site is not available, the display shows <SITE ALIAS> NOT AVAILABLE.

If the site does not exist, the display shows <SITE ALIAS> DOES NOT EXIST.

- To return to the Home screen, press the **Menu Select** button directly below EXIT.

The SSA Alert for the designated site stops.

Stopping SSA Notification of a Single Site Via Manual Entry

- ◀ or ▶ to SSA.
- Press the **Menu Select** button directly below SSA. The display shows the **Site Alert** screen.
- ◀ or ▶ to STOP ALERT and press the **Menu Select** button directly below SEL.

The display shows the **Select Site** screen.

- 4 **◀** or **▶** to [SITEID ENTRY] and press the **Menu Select** button directly below EDIT.
The display shows the **Enter SiteID** screen.
-

- 5 Key in the required Site ID and press the **Menu Select** button directly below SEND.

One of the following scenarios occur:

- If a wrong Site ID is entered, the display shows INVALID ID and prompts to enter the Site ID again.
 - If a correct Site ID is entered, the display shows SENDING REQ.
 - If the request is successful, the display shows REQ SUCCESSFUL.
 - If the single site is not available, the display shows <SITE ID> NOT AVAILABLE.
 - If the single site does not exist, the display shows <SITE ID> DOES NOT EXIST.
-

- 6 To return to the Home screen, press the **Menu Select** button directly below EXIT.
-

The SSA Alert for the designated site stops.

Stopping SSA Notification of All Sites

- 1 **◀** or **▶** to SSA.
-

- 2 Press the **Menu Select** button directly below SSA.
The display shows the **Site Alert** screen.
-

- 3 **◀** or **▶** to STOP ALERT and press the **Menu Select** button directly below SEL.
The display shows the **Select Site** screen.
-

- 4 **◀** or **▶** to [CALL SITES] and press the **Menu Select** button directly below SEND.
The display shows SENDING REQ.

If radio is out of range, roaming to a foreign system or in a failsoft situation, the display shows REQ FAILED.



If the request is successful, the display shows REQ SUCCESSFUL.

If one or more sites are not available, the display shows NOT ALL SITES AVAILABLE. Repeat step 3.



- 5 To return to the Home screen, press the **Menu Select** button directly below EXIT.
-



The SSA Alert for all sites stop.

Stopping SSA Notification of All Available Sites

- 1  or  to SSA.

- 2 Press the **Menu Select** button directly below SSA.
The display shows the **Site Alert** screen.

- 3  or  to STOP ALERT and press the **Menu Select** button directly below SEL.
The display shows the **Select Site** screen.

- 4  or  to [CALL AVAIL] and press the **Menu Select** button directly below SEND.
The display shows SENDING REQ.

If radio is out of range, roaming to a foreign system or in a failsoft situation, the display shows REQ FAILED.

If the request is successful, the display shows REQ SUCCESSFUL.

- 5 To return to the Home screen, press the **Menu Select** button directly below EXIT.

The SSA Alert for all available sites stop.

Channel Change on Off Hook on All Channels

This feature enables the mode of the radio to be changed based on the HUB on/off-hook state on all control heads.

Whenever the radio goes off-hook, the radio changes to a preprogrammed zone channel specifically for off-hook state. When the user returns the radio to on-hook state, it reverts to its previous channel zone before the radio goes off-hook.

When the radio is in off-hook state, manual mode change (including mode change triggered by third party devices) is allowed. Radio reverts back to the last mode before off-hook once the radio goes on-hook.



Note:

During PL Defeats and Suspend Scan during on-hook state, the radio is converted to work in new channel and Channel Change on Off Hook feature is suspended until these conditions end.

We do **not** recommend that "Hub Suspend Scan" and "Channel Change on Off Hook" to be enabled simultaneously.

During Dynamic Regroup channel selector lock state, Emergency, Transmit Inhibit, radio lock, or when external key loaded is attached to the radio, the Channel Change on Off Hook feature is suspended until these conditions end.

The Off Hook State for APX™ Dual Radio Setup For Dual Radio, the state of the HUB on the unselected radio is always considered as on-hook. The state of the HUB of the selected radio is always reflected as the actual states of the HUB. When the HUB is placed off-hook, the selected radio makes channel change per CPS configuration, and the unselected radio does not trigger channel change.

With Channel Change on Off Hook enabled, when the HUB is placed off-hook, and there is radio switch, the new selected radio moves to the target channel zone on off hook, and the new unselected radio reverts to the last user selected channel before off-hook.

The Off Hook State for Multiple Radios Setup

When there are multi-control heads connected, the states of these HUBs reflect the active control head(s) state. Any HUB placed off-hook by active control head(s) makes the radio goes off-hook state. Only when all HUBs are placed on-hook, the radio can be in on-hook state.



Note:

This feature needs to be carefully enabled.

Users must also be familiar with the functionality of this feature as they have to be aware that removing the microphone triggers mode change most of the time.

Low Voltage Threshold Warning

This feature is created for APX mobile radio to provide warning for low voltage threshold.

A specific external device is attached to the radio to monitor the automobile voltage. When the car battery went lower than a pre-defined threshold, the external device asserts the Vehicular Interface Port (VIP) input to the radio. When the voltage of the battery becomes

normal, the external device de-asserts the VIP input to the radio.

The voltage threshold is customized in the external device settings.

When the VIP switch turns on, the VIP asserts input to the radio. The radio immediately initiates a 15 seconds of low Voltage Pre-alert Timer. If the status of the VIP changed before this time-out timer ends, the radio returns to normal operation.

If the status from the VIP unchanged when the time-out timer ends, the radio shows `LOW BATTERY` on the display and also sounds low battery/voltage alert tone. The radio sounds a short, high-pitched tone immediately after the **PTT** button is released.



Note:

If the mobile radio does not have a control head connected, the bricks can only alert the user with battery alert tone and the transmit chirp.

Wi-Fi

This feature allows you to turn Wi-Fi® on or off. Wi-Fi can be used for wireless programming of the radio with the Radio Management tool. ^[3]



Note:

Wi-Fi Network Name (SSID) for the radio to connect to must be preprogrammed by a qualified radio technician. Check with your dealer or system administrator for more information

Turning Wi-Fi On or Off

The following methods are options on how to turn Wi-Fi® on or off. The result of all the methods is the same. You can use the options interchangeably depending on your preference and the programmed functions.

- Turning Wi-Fi on or off via the preprogrammed button:

³ This feature is available to capable and ordered option.

- a) To toggle the Wi-Fi on or off, press the preprogrammed **Wi-Fi** button.

This button must be preprogrammed by a qualified radio technician. Check with your dealer or system administrator for more information.

-
- Turning Wi-Fi on or off via the radio menu button:

- a) ◀ or ▶ to WiFi and press the **Menu Select** button directly below WiFi.
- If the display shows WiFi Status being Off, press the **Menu Select** button directly below On.
 - If the display shows WiFi Status as Searching, Connecting, Connected or No Service, press the **Menu Select** button directly below Off to turn Wi-Fi off.

Checking the Wi-Fi Configuration and Status of the Radio

- 1 Perform one of the following actions:
 - Long press the preprogrammed **Wi-Fi** button.
 - ◀ or ▶ to WiFi and press the **Menu Select** button directly below WiFi.

The display shows the current status of the Wi-Fi® as described next.

- Searching** Looking for available Wi-Fi networks that have been preprogrammed into the radio.
- Connecting** In the process of connecting to a found Wi-Fi network.
- Connected** Connected to one of the preprogrammed Wi-Fi networks.
- No Service** No available networks or connection with one of the networks failed.

If the radio is Wi-Fi connected, you see a Wi-Fi

signal strength indicator,  on the display. In addition, the WiFi menu shows Connected under the connection Status heading, what network you are connected to under the Network heading, and the signal strength to that network under the Sig Strength heading.

-
- 2 Press  to exit.
-

Utilities

Viewing Recent Calls

This feature allows you to view the recent incoming and outgoing call information of the following call types:

- Call Alert
- Selective Call
- Private Call
- Phone Call (Outgoing Only)



Note:

The radio can also be preprogrammed to log only the radio IDs associated with incoming Dispatch Calls. Check with your dealer or system administrator for more information.

Viewing recent calls via the radio menu:

- a) ◀ or ▶ to RCNT.
- b) Press the **Menu Select** button directly below RCNT to access the RECENT CALLS feature screen.
- c) ◀ or ▶ to scroll through the list.

- d) To return to the Home screen, press the **Menu Select** button directly below BACK,  or the PTT button.

The radio automatically exits the feature, if the feature inactivity timer is enabled, when the radio is left idle and the timer expires. You will hear the Menu Inactive Exit Tone upon feature exit.

Selecting the Power Level



Note:

This feature must be preprogrammed by a qualified radio technician.

This feature enables you to reduce the transmit power level for specific case that requires a lower power level. You can select the power level at which your radio transmits. The radio always turns on to the default setting.

Power level **LOW** enables a shorter transmitting distance and to conserve power. Power level **HIGH** enables a longer transmitting distance.

The following methods are options on how to select the power level. The result of all the methods is the same. You can use the options interchangeably

depending on your preference and the programmed functions.

- Selecting the Power Level via the **Transmit Power Level** switch:
 - a) Use the preprogrammed **Transmit Power Level** switch to toggle the power level between low and high power.

- Selecting the Power Level via the radio menu:
 - a) ◀ or ▶ to PWR.
 - b) Press the **Menu Select** button directly below PWR.

The display shows LOW POWER and the low power icon or the display shows HIGH POWER and the high power icon.

Selecting a Radio Profile

This feature allows you to manually switch the visual and audio settings of the radio. The display, backlight, alert tones, and audio settings are defined according to the preprogrammed radio settings of each radio profile.

Please refer to a qualified technician for more information.



Note:

The radio automatically exits the feature, if the feature inactivity timer is enabled, when the radio is left idle and the timer expires. You will hear the Menu Inactive Exit Tone upon feature exit.

The following methods are options on how to select a radio profile. The result of all the methods is the same. You can use the options interchangeably depending on your preference and the programmed functions.

- Selecting a radio profile via the preprogrammed **Profile** button:
 - a) Press the preprogrammed **Profile** button.
 - b) ◀ or ▶ to scroll through the menu selections.
 - c) Press the **Menu Select** button directly below SEL to select the required radio profile, or press the **Menu Select** button directly below EXIT to exit the screen without making any changes.

The radio returns to the Home screen. The profile name on the Home screen indicates the current selected radio profile.

- Selecting a radio profile via the radio menu:

- a) ◀ or ▶ to **PRFL** and press the **Menu Select** button directly below **PRFL** to access the **Profiles** feature screen.
- b) ◀ or ▶ to scroll through the menu selections.
- c) Press the **Menu Select** button directly below **SEL** to select the required radio profile, or press the **Menu Select** button directly below **EXIT** to exit the screen without making any changes.

The radio returns to the Home screen. The profile name on the Home screen indicates the current selected radio profile.

- To turn the backlight on, press any key of the keypad, the **Menu Select** or **Menu Navigation** buttons, or any programmable radio controls or buttons

Turning the Keypad Tones On or Off

You can enable and disable keypad tones as needed.

- Turning the tones on or off via the preprogrammed **Keypad Mute** button:
 - a) To turn the tones off or on, press the preprogrammed **Keypad Mute** button.
 - Turning the tones on or off via the radio menu:
 - a) ◀ or ▶ to **MUTE**.
 - b) Press the **Menu Select** button directly below **MUTE**.
The display shows momentary **TONES OFF**, indicating that the tones are disabled or the display shows momentary **TONES ON**, and you hear a short tone indicating that the tones are enabled.
-

Controlling the Display Backlight

You can enable or disable the radio's display backlight as needed, if poor light conditions make the display or keypad difficult to read.

Depending on how your radio is preprogrammed, you can also maintain a minimum backlight level on the radio's front display.



Perform one of the following actions:

- To toggle the backlight on or off, press the **DIM** button.

Turning Voice Mute On or Off

You can enable and disable voice transmission, if needed.

- Turning Voice Mute off or on via the preprogrammed **Voice Mute** button:
 - a) To turn the feature off or on, press the preprogrammed **Voice Mute** button.

- Turning Voice Mute on or off via the radio menu:
 - a)  or  to **VMUT** and press the **Menu Select** button directly below **VMUT**.

The display shows momentary **VOICE MUTE OFF**, and you hear a short tone, indicating that the feature is disabled or the display shows momentary **VOICE MUTE ON**, and you hear a short tone, indicating that the feature is enabled.

Using the Time-Out Timer

This feature turns off the transmitter of your radio. You cannot transmit longer than the preset timer setting.

If you attempt to do so, the radio automatically stops your transmission, and you hear a talk-prohibit tone.

The timer is defaulted at 60 seconds, but it can be preprogrammed from 3 to 120 seconds, in 15-second intervals, or it can be disabled entirely for each radio mode, by a qualified radio technician.



Note:

You hear a brief, low-pitched, warning tone four seconds before the transmission times out.

- 1 Hold down the **PTT** button longer than the preprogrammed time. You hear a short, low-pitched warning tone, the transmission is cut-off, and the LED goes out until you release the **PTT** button.

- 2 Release the **PTT** button. The timer resets.

- 3 To re-transmit, press the **PTT** button. The time-out timer restarts and the LED lights up solid red.

Using Conventional Squelch Operation Features

This feature filters out unwanted calls with low signal strength or channels that have a higher than normal background noise.

1 ◀ or ▶ to **SOL**.

2 Press the **Menu Select** button directly below **SOL**. The display shows **SQUELCH XX**, where **XX** is the value for the current squelch.

3 Perform one of the following actions:

- Press the **Menu Select** button directly below “+” to increase the squelch volume.
- Press the **Menu Select** button directly below “-” to decrease the squelch volume.

4 Press  to return to the selected channel.

Analog Options

Tone Private Line (PL), Digital Private-Line (DPL), and carrier squelch can be available (preprogrammed) per channel.

Mode	Result
Carrier squelch (C)	You hear all traffic on a channel.
PL or DPL	The radio responds only to your messages.

Digital Options

One or more of the following options may be preprogrammed in your radio. Check with your dealer or system administrator for more information.

Option	Result
Digital Carrier-Operated Squelch (COS)	You hear any digital traffic.
Normal Squelch	You hear any digital traffic having the correct network access code.
Selective Switch	You hear any digital traffic having the correct network access code and correct talkgroup.

Using the PL Defeat Feature

This feature allows you to override any coded squelch (DPL or PL) that might be preprogrammed to a channel. The radio also unmutes to any digital activity on a digital channel.

Place the preprogrammed **PL Defeat** switch in the PL Defeat position.

One of the following scenarios occurs:

- You hear any activity on the channel.
- The radio is muted if no activity is present.



Note:

When this feature is active, the Carrier Squelch status indicator is displayed.

When smart **PTT** is enabled in your radio, you cannot transmit on an active channel.

If you try to transmit on an active smart-**PTT** channel, you hear an alert tone, and the transmission is inhibited. The LED lights up solid yellow to indicate that the channel is busy.

The following table shows the variations of smart **PTT**:

Mode	Description
Transmit Inhibit on Busy Channel with Carrier	You cannot transmit if any traffic is detected on the channel.
Transmit Inhibit on Busy Channel with Wrong Squelch Code	You cannot transmit on an active channel with a squelch code or (if secure-equipped) encryption key other than your own. If the PL code is the same as yours, the transmission is not prevented.
Quick-Key Override	Your radio must be preprogrammed to allow you to use Quick-Key Override. This feature can work in conjunction with either of the two above variations. You

Digital PTT ID Support

This feature allows you to see the radio ID (number) of the radio from whom you are currently receiving a transmission. This ID, consisting up to a maximum of eight characters, can be viewed by both the receiving radio and the dispatcher.

The ID number of your radio is also automatically sent every time the **PTT** button is pressed. This is a per-channel feature. For digital voice transmissions, the ID of your radio is sent continuously during the voice message.

Smart PTT Feature (Conventional Only)

Smart **PTT** is a per-personality, programmable feature used in conventional radio systems to keep radio users from talking over other radio conversations.

Mode	Description
	can override the transmit-inhibit state by quick-keying the radio. In other words, two PTT button presses within the preprogrammed time limit.

Transmit Inhibit

This feature is available for APCO 25 trunking, Type II trunking and Conventional operations for all APX radios.

When Transmit Inhibit feature is enabled, the radio stops all transmission including voice and data. The radio can receive messages but is not able to reply the acknowledgment request of the received message.

User can physically control the transmission of the radio especially during operation in hazardous environments with this feature. An environment is considered hazardous when the power emitted by the radio power amplifier could initiate an explosion or other dangerous reactions.

When the Transmit Inhibit feature is disabled, the radio functions according to its normal operations.

The radio sounds alert tone when user enters or exits this feature and also when **PTT** is pressed.



Note:

Acknowledgement of any messages required from the radio is not transmitted if the Transmit Inhibition is enabled.

Enabling Transmit Inhibition

Perform one of the following actions:

- ◀ or ▶ to TXIN. Press the **Menu Select** button below TXIN.
- Turn off the ignition through Ignition Sense Line.



Note:

If the user has disabled TX Inhibit via the menu and then moves the switch to the position where TX Inhibit is enabled, the new value overwrites the menu value.

The display shows TX INHIBIT ON. You hear a sequence of short, low-high tones to indicate transmission is inhibited.

Pressing **PTT** triggers the radio sounds a constant short, low-pitched tone (reject tone).

**Note:**

The status of the Transmit Inhibit does not change after the radio powers up.

The softkey TXIN is created to ease the user of inhibition transmission besides relying solely on Ignition Sense Line. Only if the Ignition Sense Line is on, the softkey TXIN works. If the Ignition Sense Line is on, user can always turn on or off the Transmit Inhibition using the softkey TXIN; but when the Ignition Sense Line is off, function of softkey TXIN is suspended, and the Transmit Inhibition function is always off.

If PTT TX Inhibit is enabled, when using multi control head with one active configuration, with the **PTT** pressed on the active control head, any press on the programmable button of the other control head which meant for that control head to be active control head will cause an unstoppable long low-pitched tone (Talk Prohibit Tone). The display shows TX INHIBIT This behavior can be stopped by pressing **PTT** button again on the active control head

Disabling Transmit Inhibition

Perform one of the following actions:

- ◀ or ▶ to TXIN. Press the **Menu Select** button below TXIN.
- Turn on the ignition through Ignition Sense Line.

**Note:**

If the user has disabled TX Inhibit via the softkey and then moves the switch to the position where TX Inhibit is enabled, the new value overwrites the menu value.

The display shows TX INHIBIT OFF. You hear a sequence of short, high-low tone (Transmit Inhibit Off tone) to indicate transmission is back to normal operation.

General Radio Information

Your radio contains information on the following:

- Radio Information
- IP Display
- Control Assignments

**Note:**

The radio automatically exits the feature, if the feature inactivity timer is enabled, when the radio is left idle and the timer expires. You

hear the Menu Inactive Exit Tone upon feature exit.

Accessing the Radio Information

This feature displays the following radio information:

- Host Version
- Secure Version
- CH 1 – 4 Version (depending on the number of channels connected.)
- Siren Version
- Model Number
- ESN
- Flash Code
- Tuning Version
- DSP Version
- KG (Secure Algorithm)
- Serial Number
- Flash Size & Type
- RF Band(s)
- Processor Version
- MCHIB Version
- CHIB Version
- TIB Version
- TRC Version

- VRS Version
- URC Version
- DVRS App Version (only when DVRS is available)
- DVRS DSP Version (only when DVRS is available)
- DVRS CP Version (only when DVRS is available)
- AUX CH Version



Note:

To return to the Home screen, press at any time.

- 1 or to INFO and press the **Menu Select** button directly below INFO.

- 2 or to RADIO INFO and press the **Menu Select** button directly below SEL.
The display shows the Information screen.

- 3 Perform one of the following actions:
 - or to scroll through the various information.
 - Press the **Menu Select** button directly below BACK to return to the previous screen.
 - Press to return to the Home screen .

Viewing the IP Information

This feature displays the device name, IP address, and status of your radio.



Note:

The device name of your radio is preprogrammed. Check with your dealer or system administrator for more information.

- 1 Perform one of the following actions:
 - Press the preprogrammed **Info** button.
 - ◀ or ▶ to **INFO** and press the **Menu Select** button directly below **INFO**.

- 2 ◀ or ▶ to **IP INFO** and press the **Menu Select** button directly below **SEL**.

- 3 Perform one of the following actions:
 - ◀ or ▶ to scroll through the various information.
 - Press the **Menu Select** button directly below **BACK** to return to the previous screen.
 - Press  to return to the Home screen.

Viewing the Control Assignments

This feature displays the programmable radio functions assigned to the controls of your radio for the currently selected channel.

See [Programmable Features](#) on page 23 for more information on the various programmable features of your radio.

- 1 Perform one of the following actions:
 - Press the preprogrammed **Info** button.
 - ◀ or ▶ to **INFO** and press the **Menu Select** button directly below **INFO**.

- 2 ◀ or ▶ to **CONTROL MAP** and press the **Menu Select** button directly below **SEL**.
The display shows the Control Map screen.

- 3 Perform one of the following actions:
 - ◀ or ▶ to scroll through the various information.
 - Press the **Menu Select** button directly below **BACK** to return to the previous screen.
 - Press  to return to the Home screen.

External Alarms (Horn and Lights)

All control heads can be equipped for external alarms (horn and lights) that are activated when a Call Alert page, Private Conversation call, or phone call is received.

The radio always powers up with the horn and lights feature enabled.



Note:

The horn and lights feature must be enabled by a qualified radio technician.

Using Non-Permanent Horn and Lights

- 1 Press the **Menu Select** button directly below H/L momentarily.
The last selected alarm(s) are enabled, and the display shows the enabled alarm(s) alternating with the selected mode, until it is turned off.

- 2 Press the **Menu Select** button directly below H/L momentarily to turn off the alarm(s).
The display shows HORN/LITES OFF.

Using Permanent Horn and Lights

If Permanent Horn and Lights is enabled, horn and lights will automatically turn on when the radio powers up.

- 1 Press the **Menu Select** button directly below H/L once to turn off the alarm(s).

- 2 Press the **Menu Select** button directly below H/L momentarily to enable the last selected alarm(s).
The display briefly shows the enabled alarms, and then reverts back to the selected mode.

Changing the Selected Alarms

- 1 Press the **Menu Select** button directly below H/L until the display shows the required alarm.

- 2 Perform one of the following actions:
 - Press the **Menu Select** button directly below H +L to turn on both horn and lights.
 - Press the **Menu Select** button directly below Lgts to turn on the lights.
 - Press the **Menu Select** button directly below Horn to turn on the horn.

One of the following scenarios occurs:

- If you choose H+L, the display shows HORN/LITES ON.
- If you choose LGTS, the display shows LIGHTS ON.
- If you choose HORN, the display shows HORN ON.

An OFF entry is shown at the softkey when one of the alarms is active. Selecting OFF deactivates the current active alarm.

Receiving a Call While Alarms are Turned On

When you receive a call with the Alarms turned on, you hear the vehicle's horn sounds for four seconds, and/or the car lights turn on for 60 seconds.

The display shows the type of call received (CALL, PAGE, or PHONE) and the selected mode name.

The time interval can be modified by a qualified radio technician.

Turning Off Non-Rearmable External Alarms

- 1 Perform one of the following actions:

- Press the **Menu Select** button directly below CALL, PAGE or PHON to turn off the external alarm(s) and access that feature.
- Press the **PTT** button or any control-head button to turn off the external alarm(s).

The **Volume Knob** and the **DIM** button have no effect on the state of the external alarm(s).

-
- 2 Press the **Menu Select** button directly below H/L momentarily to rearm the horn and lights feature.

Turning Off Rearmable External Alarms

Perform one of the following actions:

- Press the **Menu Select** button directly below CALL, PAGE or PHON to turn off the external alarm(s) and access that feature. The external alarm(s) is turned off and automatically rearmed so that when you exit the entry, the external alarm(s) will automatically turn on.
- Press the **PTT** button or any control head button other than the **Menu Select** button directly below H/L to turn off the external alarm(s). The external alarm(s) is turned off and automatically rearmed so that when you

exit the entry, the external alarm(s) will automatically turn on.

- Press the **Menu Select** button directly below H/L to turn off the external alarm(s) and exit the Horn and Lights feature. Press the **Menu Select** button directly below H/L momentarily to rearm the horn and lights feature.

The **Volume Knob** and the **DIM** button have no effect on the state of the external alarm(s).

Helpful Tips

Radio Care

The following are suggestions to assist you in troubleshooting possible operating problems.



Caution:

The cables that connect to the rear of the radio could have live voltage on some of their pins. Do not remove or reconnect these cables. Only a qualified radio technician should perform this task. Service performed by unauthorized personnel may cause the radio to transmit an emergency alarm even if the unit is turned off.

If your radio is locked up or the display shows FAIL 01/09, turn the radio off and then back on. If this does not correct the condition, take the radio to a qualified radio technician for service.

If radio operation is intermittent, check with other persons using the system for similar problems before taking the radio in for service. Similar problems indicate a system malfunction rather than a radio failure.

If symptoms persist or, if your unit exhibits other problems, contact a qualified radio technician.

Cleaning the External Surface of the Radio



Caution:

Do **not** use solvents to clean your radio. Spirits may permanently damage the radio housing.

Do **not** submerge the radio in detergent solution.

- 1 Combine one teaspoon of mild dishwashing detergent to one gallon of water (0.5% solution).
- 2 Apply the solution sparingly with a stiff, non-metallic, short-bristled brush, making sure excess detergent does not get entrapped near the connectors, controls or crevices.
- 3 Dry the radio thoroughly with a soft, lint-free cloth.

Cleaning the External Plastic Surface

The detergent-water solution should be applied sparingly with a stiff, non-metallic, short-bristled brush to work all loose dirt away from the radio.

A soft, absorbent, lint-free cloth or tissue should be used to remove the solution and dry the radio.

Make sure that no water remains entrapped near the connectors, cracks, or crevices.

Accessories

The accessory link below is for APX radios. Not all accessories are FCC certified to operate with all APX models and/or bandsplits. Please refer to the specific APX radio price pages for a list of FCC certified accessories or contact your sales representative for accessory compatibility.

<http://www.motorolasolutions.com/APX>



Note:

GPS only antenna is only used in either a single band UHF or 700/800 application where the Public Safety Microphone (PSM) is used with the corresponding PSM antenna. This antenna is only for GPS reception and cannot be used for receive/transmit operation at UHF, VHF or 700/800. This antenna is never to be used on the PSM.

Maritime Radio Use in the VHF Frequency Range

Special Channel Assignments

Emergency Channel

If you are in imminent and grave danger at sea and require emergency assistance, use VHF Channel 16 to send a distress call to nearby vessels and the United States Coast Guard. Transmit the following information, in this order:

- 1 “MAYDAY, MAYDAY, MAYDAY.”
- 2 “THIS IS _____, CALL SIGN _____.” State the name of the vessel in distress 3 times, followed by the call sign or other identification of the vessel, stated 3 times.
- 3 Repeat “MAYDAY” and the name of the vessel.
- 4 “WE ARE LOCATED AT _____.” State the position of the vessel in distress, using any information that will help responders to locate you, e.g.:
 - latitude and longitude
 - bearing (state whether you are using true or magnetic north)

- distance to a well-known landmark
 - vessel course, speed or destination
- 5 State the nature of the distress.
 - 6 Specify what kind of assistance you need.
 - 7 State the number of persons on board and the number needing medical attention, if any.
 - 8 Mention any other information that would be helpful to responders, such as type of vessel, vessel length and/or tonnage, hull color, etc.
 - 9 “OVER.”
 - 10 Wait for a response.
 - 11 If you do not receive an immediate response, remain by the radio and repeat the transmission at intervals until you receive a response. Be prepared to follow any instructions given to you.

Non-Commercial Call Channel

For non-commercial transmissions, such as fishing reports, rendezvous arrangements, repair scheduling, or berthing information, use **VHF Channel 9**.

Operating Frequency Requirements

A radio designated for shipboard use must comply with Federal Communications Commission Rule Part 80 as follows:

- on ships subject to Part II of Title III of the Communications Act, the radio must be capable of operating on the 156.800 MHz frequency.
- on ships subject to the Safety Convention, the radio must be capable of operating:
 - in the simplex mode on the ship station transmitting frequencies specified in the 156.025 – 157.425 MHz frequency band, and
 - in the semiduplex mode on the two frequency channels specified in the table below.



Note:

Simplex channels 3, 21, 23, 61, 64, 81, 82, and 83 cannot be lawfully used by the general public in US waters.

Additional information about operating requirements in the Maritime Services can be obtained from the full text of FCC Rule Part 80 and from the US Coast Guard.

Table 1: VHF Marine Channel List

Channel Number	Frequency (MHz)	
	Transmit	Receive

1	156.050	160.650
2	156.100	160.700
*	156.150	160.750
4	156.200	160.800
5	156.250	160.850
6	156.300	–
7	156.350	160.950
8	156.400	–
9	156.450	156.450
10	156.500	156.500
11	156.550	156.550
12	156.600	156.600
13**	156.650	156.650
14	156.700	156.700
15**	156.750	156.750
16	156.800	156.800
17**	156.850	156.850

18	156.900	161.500
19	156.950	161.550
20	157.000	161.600
*	157.050	161.650
22	157.100	161.700
*	157.150	161.750
24	157.200	161.800
25	157.250	161.850
26	157.300	161.900
27	157.350	161.950
28	157.400	162.000
60	156.025	160.625
*	156.075	160.675
62	156.125	160.725
63	156.175	160.775
*	156.225	160.825
65	156.275	160.875

66	156.325	160.925
67**	156.375	156.375
68	156.425	156.425
69	156.475	156.475
71	156.575	156.575
72	156.625	–
73	156.675	156.675
74	156.725	156.725
75	***	***
76	***	***
77**	156.875	–
78	156.925	161.525
79	156.975	161.575
80	157.025	161.625
*	157.075	161.675
*	157.125	161.725
*	157.175	161.775

84	157.225	161.825
85	157.275	161.875
86	157.325	161.925
87	157.375	161.975
88	157.425	162.025

**Note:**

* Simplex channels 3, 21, 23, 61, 64, 81, 82, and 83 cannot be **lawfully used** by the general public in US waters.

** Low power (1 W) only.

*** Guard band.

**Note:**

A – in the Receive column indicates that the channel is transmit only.

maritime use when it operates on the distress and safety frequencies specified in RSS-182 Section 7.3.

Technical Parameters for Interfacing External Data Sources

	RS232	USB	SB9600
Input Voltage (Volts Peak-to-peak)	18V	3.6V	5V
Max Data Rate	115 Kbps	12 Mbps	9.6 Kbps
Impedance	5000 Ohm	90 Ohm	120 Ohm

Declaration of Compliance for the Use of Distress and Safety Frequencies

The radio equipment does not employ a modulation other than the internationally adopted modulation for

Glossary

This glossary is a list of specialized terms used in this manual.

ACK	Acknowledgment of communication.
Active Channel	A channel that has traffic on it.
Analog Signal	An RF signal that has a continuous nature rather than a pulsed or discrete nature.
ARS	Automatic Registration Service
ASTRO 25	Motorola standard for wireless digital trunked communications.
ASTRO Conventional	Motorola standard for wireless digital conventional communications.
Autoscan	A feature that allows the radio to automatically scan the members of a scan list.
AUX CH	Auxiliary Control Head

Call Alert	Privately page an individual by sending an audible tone.
Carrier Squelch	Feature that responds to the presence of an RF carrier by opening or unmuting (turning on) a receiver's audio circuit. A squelch circuit silences the radio when no signal is being received so that the user does not have to listen to "noise".
Central Controller	A software-controlled, computer-driven device that receives and generates data for the trunked radios assigned to it. It monitors and directs the operations of the trunked repeaters.
Channel	A group of characteristics such as transmit/ receive frequency pairs, radio parameters, and encryption encoding.
CHIB	Control Head Interface Board

Control Channel In a trunking system, one of the channels that is used to provide a continuous, two-way/ data communications path between the central controller and all radios on the system.

Conventional Typically refers to radio-to-radio communications, sometimes through a repeater (see Trunking).

Conventional Scan List A scan list that includes only conventional channels.

CP Codeplug

Cursor A visual tracking marker (a blinking line) that indicates a location on the display.

Deadlock Displayed by the radio after three failed attempts to unlock the radio. The radio must be powered off and on prior to another attempt.

Digital Private Line (DPL) A type of coded squelch using data bursts. Similar to PL

except a digital code is used instead of a tone.

Digital Signal An RF signal that has a pulsed, or discrete, nature, rather than a continuous nature.

Dispatcher An individual who has radio system management duties.

DSP Digital Signal Processing

Dynamic Regrouping A feature that allows the dispatcher to temporarily reassign selected radios to a single special channel so they can communicate with each other.

DVRS Digital Vehicular Repeater System

ESN Electrical Serial Number

Failsoft A feature that allows communications to take place even though the central controller has failed. Each trunked repeater in the system transmits a data word informing

	every radio that the system has gone into failsoft.		
FCC	Federal Communications Commission.	Monitor	Check channel activity by pressing the Monitor button. If the channel is clear, you hear static. If the channel is in use, you hear conversation. It also serves as a way to check the volume level of the radio, since the radio “opens the squelch” when the monitor button is pressed.
FM	Frequency Modulation		
Hang Up	Disconnect.		
Home screen	The first display information after the radio completes its self test.		
KVL	Key-variable loader: A device for loading encryption keys into the radio.	Multi-System Talkgroup Scan List	A scan list that can include both talkgroups (trunked) and channels (conventional).
LCD	Liquid crystal display.	Network Access Code	Network Access Code (NAC) operates on digital channels to reduce voice channel interference between adjacent systems and sites.
LED	Light-emitting diode.		
MCHB	Millennium Control Head Board	Non-Tactical/ Revert	The user talks on a preprogrammed emergency channel. The emergency alarm is sent out on this same channel.
Menu Entry	A software-activated feature shown at the bottom of the display – selection of these features is controlled by the  button.	OTAR	Over-the-air rekeying.

Page	A one-way alert, with audio and/or display messages.		(send) operation when pressed.
Personality	A set of unique features specific to a radio.	Radio Frequency (RF)	The part of the general frequency spectrum between the audio and infrared light regions (about 10 kHz to 10,000,000 MHz).
PIN	Personal Identification Number		
Preprogrammed	Refers to a software feature that has been activated by a qualified radio technician.	Repeater	A conventional radio feature, where you talk through a receive/transmit facility that re-transmits received signals, in order to improve communications range and coverage.
Private (Conversation) Call	A feature that lets you have a private conversation with another radio user in the talkgroup.		
Private Line (PL)	A sub-audible tone that is transmitted such that only receivers decoding the tone receives it.	Selective Call	A feature that allows you to call a selected individual, intended to provide privacy and to eliminate the annoyance of having to listen to conversations of no interest to you.
Programmable	Refers to a radio control that can have a radio feature assigned to it.		
PTT	Push-To-Talk. The PTT button engages the transmitter and puts the radio in transmit	Selective Switch	Any digital P25 traffic having the correct Network Access Code and the correct talkgroup.

Squelch	Special electronic circuitry, added to the receiver of a radio, that reduces, or cuts off, unwanted signals before they are heard in the speaker.		with each other using the same communication path.
Standby	An operating condition whereby the radio's speaker is muted but still continues to receive data.	TMS	Text Messaging Service
Status Calls	Pre-defined text messages that allow the user to send a conditional message without talking.	Trunking	The automatic sharing of communications paths between a large number of users (see Conventional).
Tactical/ Non-Revert	The user talks on the channel that was selected before the radio entered the emergency state.	Trunking Priority Monitor Scan List	A scan list that includes talkgroups that are all from the same trunking system.
Talkaround	Bypass a repeater and talk directly to another unit for easy local unit-to-unit communications.	USK	Unique Shadow Key.
Talkgroup	An organization or group of radio users who communicate	UTC	Coordinated Universal Time. The international time standard (formerly Greenwich Mean Time, or GMT). Zero hours UTC is midnight in Greenwich, England, which is located at 0 degrees longitude. Everything east of Greenwich (up to 180 degrees) is later in time; everything west is earlier. There are 42 time authorities around the world that are constantly synchronizing with

each other. Abbreviated as UTC (English backronym = Universal Time, Coordinated), it is also known as Zulu (Z) Time.

VRS

Vehicular Repeater System

Zone

A grouping of channels.

Crab

Limited Warranty

MOTOROLA COMMUNICATION PRODUCTS

I. WHAT THIS WARRANTY COVERS AND FOR HOW LONG:

MOTOROLA SOLUTIONS, INC. (“MOTOROLA”) warrants the MOTOROLA manufactured Communication Products listed below (“Product”) against defects in material and workmanship under normal use and service for a period of time from the date of purchase as scheduled below:

ASTRO APX Mobile Radios	One (1) Year
Product Accessories	One (1) Year

MOTOROLA, at its option, will at no charge either repair the Product (with new or reconditioned parts), replace it (with a new or reconditioned Product), or refund the purchase price of the Product during the warranty period provided it is returned in accordance with the terms of this warranty. Replaced parts or boards are warranted for the balance of the original

applicable warranty period. All replaced parts of Product shall become the property of MOTOROLA.

This express limited warranty is extended by MOTOROLA to the original end user purchaser only and is not assignable or transferable to any other party. This is the complete warranty for the Product manufactured by MOTOROLA. MOTOROLA assumes no obligations or liability for additions or modifications to this warranty unless made in writing and signed by an officer of MOTOROLA.

Unless made in a separate agreement between MOTOROLA and the original end user purchaser, MOTOROLA does not warrant the installation, maintenance or service of the Product.

MOTOROLA cannot be responsible in any way for any ancillary equipment not furnished by MOTOROLA which is attached to or used in connection with the Product, or for operation of the Product with any ancillary equipment, and all such equipment is expressly excluded from this warranty. Because each system which may use the Product is unique, MOTOROLA disclaims liability for range, coverage, or operation of the system as a whole under this warranty.

MOTOROLA offers the following optional extended service contracts.

SERVICE FROM THE START (SfS) COMPREHENSIVE

Provides for extended hardware repair coverage INCLUDING CHEMICAL, LIQUID, FIRE, AND OTHER PHYSICAL DAMAGE. Comprehensive coverage is available in conjunction with MOTOROLA'S standard Commercial Warranty and starts from the FIRST DAY the radio is put into use. Service performed under this plan consists of repair or replacement of the covered equipment as set forth in the terms and conditions. Repairs will be made only at the designated MOTOROLA repair depot. Local services are not included. MOTOROLA will pay the inbound shipping charges only with use of the MOTOROLA designated delivery service. MOTOROLA will pay for outbound shipping via MOTOROLA'S normal shipping methods.

SERVICE FROM THE START (SfS) LITE

Provides extended hardware normal wear and tear repair coverage beginning AFTER MOTOROLA'S standard Commercial Warranty period expires. Service performed under this plan consists of repair of the covered equipment as set forth in the terms

and conditions. Repairs will be made only at the designated MOTOROLA repair depot. Local services are not included. MOTOROLA will pay for outbound shipping via MOTOROLA'S normal shipping methods.

II. GENERAL PROVISIONS:

This warranty sets forth the full extent of MOTOROLA'S responsibilities regarding the Product. Repair, replacement or refund of the purchase price, at MOTOROLA's option, is the exclusive remedy. THIS WARRANTY IS GIVEN IN LIEU OF ALL OTHER EXPRESS WARRANTIES. IMPLIED WARRANTIES, INCLUDING WITHOUT LIMITATION, IMPLIED WARRANTIES OF MERCHANTABILITY AND FITNESS FOR A PARTICULAR PURPOSE, ARE LIMITED TO THE DURATION OF THIS LIMITED WARRANTY. IN NO EVENT SHALL MOTOROLA BE LIABLE FOR DAMAGES IN EXCESS OF THE PURCHASE PRICE OF THE PRODUCT, FOR ANY LOSS OF USE, LOSS OF TIME, INCONVENIENCE, COMMERCIAL LOSS, LOST PROFITS OR SAVINGS OR OTHER INCIDENTAL, SPECIAL OR CONSEQUENTIAL DAMAGES ARISING OUT OF THE USE OR INABILITY TO USE SUCH PRODUCT, TO THE

FULL EXTENT SUCH MAY BE DISCLAIMED BY LAW.

warranty service. You can also call MOTOROLA at 1-800-927-2744 US/Canada.

III. STATE LAW RIGHTS:

SOME STATES DO NOT ALLOW THE EXCLUSION OR LIMITATION OF INCIDENTAL OR CONSEQUENTIAL DAMAGES OR LIMITATION ON HOW LONG AN IMPLIED WARRANTY LASTS, SO THE ABOVE LIMITATION OR EXCLUSIONS MAY NOT APPLY.

This warranty gives specific legal rights, and there may be other rights which may vary from state to state.

IV. HOW TO GET WARRANTY SERVICE:

You must provide proof of purchase (bearing the date of purchase and Product item serial number) in order to receive warranty service and, also, deliver or send the Product item, transportation and insurance prepaid, to an authorized warranty service location. Warranty service will be provided by MOTOROLA through one of its authorized warranty service locations. If you first contact the company which sold you the Product (e.g., dealer or communication service provider), it can facilitate your obtaining

V. WHAT THIS WARRANTY DOES NOT COVER:

- 1 Defects or damage resulting from use of the Product in other than its normal and customary manner.
- 2 Defects or damage from misuse, accident, water, or neglect.
- 3 Defects or damage from improper testing, operation, maintenance, installation, alteration, modification, or adjustment.
- 4 Breakage or damage to antennas unless caused directly by defects in material workmanship.
- 5 A Product subjected to unauthorized Product modifications, disassembles or repairs (including, without limitation, the addition to the Product of non-MOTOROLA supplied equipment) which adversely affect performance of the Product or interfere with MOTOROLA's normal warranty inspection and testing of the Product to verify any warranty claim.
- 6 Product which has had the serial number removed or made illegible.

- 7 Rechargeable batteries if:
 - any of the seals on the battery enclosure of cells are broken or show evidence of tampering.
 - the damage or defect is caused by charging or using the battery in equipment or service other than the Product for which it is specified.
- 8 Freight costs to the repair depot.
- 9 A Product which, due to illegal or unauthorized alteration of the software/firmware in the Product, does not function in accordance with MOTOROLA's published specifications or the FCC certification labeling in effect for the Product at the time the Product was initially distributed from MOTOROLA.
- 10 Scratches or other cosmetic damage to Product surfaces that does not affect the operation of the Product.
- 11 Normal and customary wear and tear.

VI. PATENT AND SOFTWARE PROVISIONS:

MOTOROLA will defend, at its own expense, any suit brought against the end user purchaser to the extent that it is based on a claim that the Product or parts infringe a United States patent, and MOTOROLA will

pay those costs and damages finally awarded against the end user purchaser in any such suit which are attributable to any such claim, but such defense and payments are conditioned on the following:

- 1 that MOTOROLA will be notified promptly in writing by such purchaser of any notice of such claim,
- 2 that MOTOROLA will have sole control of the defense of such suit and all negotiations for its settlement or compromise, and
- 3 should the Product or parts become, or in MOTOROLA's opinion be likely to become, the subject of a claim of infringement of a United States patent, that such purchaser will permit MOTOROLA, at its option and expense, either to procure for such purchaser the right to continue using the Product or parts or to replace or modify the same so that it becomes non-infringing or to grant such purchaser a credit for the Product or parts as depreciated and accept its return. The depreciation will be an equal amount per year over the lifetime of the Product or parts as established by MOTOROLA.

MOTOROLA will have no liability with respect to any claim of patent infringement which is based upon the

combination of the Product or parts furnished hereunder with software, apparatus or devices not furnished by MOTOROLA, nor will MOTOROLA have any liability for the use of ancillary equipment or software not furnished by MOTOROLA which is attached to or used in connection with the Product. The foregoing states the entire liability of MOTOROLA with respect to infringement of patents by the Product or any parts thereof.

Laws in the United States and other countries preserve for MOTOROLA certain exclusive rights for copyrighted MOTOROLA software such as the exclusive rights to reproduce in copies and distribute copies of such MOTOROLA software. MOTOROLA software may be used in only the Product in which the software was originally embodied and such software in such Product may not be replaced, copied, distributed, modified in any way, or used to produce any derivative thereof. No other use including, without limitation, alteration, modification, reproduction, distribution, or reverse engineering of such MOTOROLA software or exercise of rights in such MOTOROLA software is permitted. No license is granted by implication, estoppel or otherwise under MOTOROLA patent rights or copyrights.

VII. GOVERNING LAW:

This Warranty is governed by the laws of the State of Illinois, U.S.A.

VIII. For Australia Only

This warranty is given by Motorola Solutions Australia Pty Limited (ABN 16 004 742 312) of Tally Ho Business Park, 10 Wesley Court. Burwood East, Victoria.

Our goods come with guarantees that cannot be excluded under the Australia Consumer Law. You are entitled to a replacement or refund for a major failure and compensation for any other reasonably foreseeable loss or damage. You are also entitled to have the goods repaired or replaced if the goods fail to be of acceptable quality and the failure does not amount to a major failure.

Motorola Solutions Australia's limited warranty above is in addition to any rights and remedies you may have under the Australian Consumer Law. If you have any queries, please call Motorola Solutions Australia at 1800 457 439. You may also visit our website: http://www.motorolasolutions.com/XA-EN/Pages/Contact_Us for the most updated warranty terms.

SERVICE

Proper repair and maintenance procedures will assure efficient operation and long life for this product. A Motorola maintenance agreement will provide expert service to keep this and all other communication equipment in perfect operating condition. A nationwide service organization is provided by Motorola to support maintenance services. Through its maintenance and installation program, Motorola makes available the finest service to those desiring reliable, continuous communications on a contract basis. For a contract service agreement, please contact your nearest Motorola service or sales representative, or an authorized Motorola dealer.

Express Service Plus (ESP) is an optional extended service coverage plan, which provides for the repair of this product for a period of three years from the date of shipment from the factory, or the date of delivery if purchased from an authorized Motorola two-way radio dealer. For more information about ESP, contact the Motorola Radio Support Center, 2204 Galvin Drive, Elgin, IL 60123, 1-800-227-6772.

Urdu



MOTOROLA SOLUTIONS

Motorola Solutions, Inc.
1303 East Algonquin Road
Schaumburg, Illinois 60196 U.S.A.

MOTOROLA, MOTO, MOTOROLA SOLUTIONS and the Stylized M logo are trademarks or registered trademarks of Motorola Trademark Holdings, LLC and are used under license. All other trademarks are the property of their respective owners.
© 2012–2016 Motorola Solutions, Inc. All rights reserved.



6875947M01-HC