



**CFR 47 FCC PART 15 SUBPART C
ISED RSS-247 ISSUE 2**

TEST REPORT

For

Two Way Portable Radio R7

MODEL NUMBER: AAH06UCN9RB1AN (IC Model: PMUF2000ABB)

REPORT NUMBER: 4790494290-1-RF-3

ISSUE DATE: August 24, 2022

FCC ID: AZ489FT7169

IC: 109U-89FT7169

Prepared for

Motorola Solutions, Inc.

8000, West Sunrise Blvd., Ft Lauderdale, Florida 33322, United States

Prepared by

UL Verification Services (Guangzhou) Co., Ltd, Song Shan Lake Branch

Building 10, Innovation Technology Park, No. 1, Li Bin Road, Song Shan Lake Hi-Tech Development Zone Dongguan, 523808, People's Republic of China

Tel: +86 769 22038881

Fax: +86 769 33244054

Website: www.ul.com

The results reported herein have been performed in accordance with the laboratory's terms of accreditation. This report shall not be reproduced except in full without the written approval of the Laboratory. The results in this report apply to the test sample(s) mentioned above at the time of the testing period only and are not to be used to indicate applicability to other similar products.



Revision History

<u>Rev.</u>	<u>Issue Date</u>	<u>Revisions</u>	<u>Revised By</u>
<u>V0</u>	<u>August 24, 2022</u>	<u>Initial Issue</u>	<u></u>



Summary of Test Results

Test Item	Clause	Limit/Requirement	Result
Antenna Requirement	N/A	FCC Part 15.203/15.247 (c) RSS-GEN Clause 6.8	Pass
AC Power Line Conducted Emission	ANSI C63.10-2013, Clause 6.2	FCC Part 15.207 RSS-GEN Clause 8.8	Pass
Conducted Output Power	ANSI C63.10-2013, Clause 11.9.1.3	FCC Part 15.247 (b)(3) RSS-247 Clause 5.4 (d)	Pass
6dB Bandwidth and 99% Occupied Bandwidth	ANSI C63.10-2013, Clause 11.8.1	FCC Part 15.247 (a)(2) RSS-247 Clause 5.2 (a) ISED RSS-Gen Clause 6.7	Pass
Power Spectral Density	ANSI C63.10-2013, Clause 11.10.2	FCC Part 15.247 (e) RSS-247 Clause 5.2 (b)	Pass
Conducted Band edge and spurious emission	ANSI C63.10-2013, Clause 11.11	FCC Part 15.247(d) RSS-247 Clause 5.5	Pass
Duty Cycle	ANSI C63.10-2013, Clause 11.6	None; for reporting purposes only.	Pass

*This test report is only published to and used by the applicant, and it is not for evidence purpose in China.

*The measurement result for the sample received is <Pass> according to <CFR 47 FCC PART 15 SUBPART C><ISED RSS-247 ISSUE 2> when <Accuracy Method> decision rule is applied.

CONTENTS

1. ATTESTATION OF TEST RESULTS	6
2. TEST METHODOLOGY	7
3. FACILITIES AND ACCREDITATION	7
4. CALIBRATION AND UNCERTAINTY	8
4.1. <i>MEASURING INSTRUMENT CALIBRATION</i>	8
4.2. <i>MEASUREMENT UNCERTAINTY</i>	8
5. EQUIPMENT UNDER TEST	9
5.1. <i>DESCRIPTION OF EUT</i>	9
5.2. <i>CHANNEL LIST</i>	9
5.3. <i>MAXIMUM EIRP</i>	9
5.4. <i>TEST CHANNEL CONFIGURATION</i>	9
5.5. <i>THE WORSE CASE POWER SETTING PARAMETER</i>	10
5.6. <i>DESCRIPTION OF AVAILABLE ANTENNAS</i>	11
5.7. <i>SUPPORT UNITS FOR SYSTEM TEST</i>	12
5.8. <i>SETUP DIAGRAM</i>	13
6. MEASURING EQUIPMENT AND SOFTWARE USED	14
7. ANTENNA PORT TEST RESULTS	17
7.1. <i>CONDUCTED OUTPUT POWER</i>	17
7.2. <i>6DB BANDWIDTH AND 99% OCCUPIED BANDWIDTH</i>	18
7.3. <i>POWER SPECTRAL DENSITY</i>	20
7.4. <i>CONDUCTED BAND EDGE AND SPURIOUS EMISSION</i>	21
7.5. <i>DUTY CYCLE</i>	23
8. RADIATED TEST RESULTS	24
8.1. <i>RESTRICTED BANDEDGE</i>	32
8.2. <i>RESTRICTED BANDEDGE WITH CHARGING WORST CASE</i>	44
8.3. <i>SPURIOUS EMISSIONS(1 GHZ~3 GHZ)</i>	46
8.4. <i>SPURIOUS EMISSIONS WITH CHARGING WORST CASE(1 GHZ~3 GHZ)</i>	52
8.5. <i>SPURIOUS EMISSIONS(3 GHZ~18 GHZ)</i>	54
8.6. <i>SPURIOUS EMISSIONS WITH CHARGING WORST CASE(3 GHZ~18 GHZ)</i>	72
8.7. <i>SPURIOUS EMISSIONS(9 KHZ~30 MHZ)</i>	74
8.8. <i>SPURIOUS EMISSIONS(18 GHZ~26 GHZ)</i>	77
8.9. <i>SPURIOUS EMISSIONS(30 MHZ~1 GHZ)</i>	79
8.10. <i>SPURIOUS EMISSIONS WITH CHARGING WORST CASE(30 MHZ~1 GHZ)</i>	81



9.	ANTENNA REQUIREMENT	83
10.	AC POWER LINE CONDUCTED EMISSION	84
11.	TEST DATA	87
11.1.	<i>APPENDIX A: DTS BANDWIDTH</i>	87
11.1.1.	Test Result	87
11.1.2.	Test Graphs	88
11.2.	<i>APPENDIX B: OCCUPIED CHANNEL BANDWIDTH</i>	91
11.2.1.	Test Result	91
11.2.2.	Test Graphs	92
11.3.	<i>APPENDIX C: MAXIMUM CONDUCTED OUTPUT POWER</i>	95
11.3.1.	Test Result	95
11.4.	<i>APPENDIX D: MAXIMUM POWER SPECTRAL DENSITY</i>	96
11.4.1.	Test Result	96
11.4.2.	Test Graphs	97
11.5.	<i>APPENDIX E: BAND EDGE MEASUREMENTS</i>	100
11.5.1.	Test Result	100
11.5.2.	Test Graphs	101
11.6.	<i>APPENDIX F: CONDUCTED SPURIOUS EMISSION</i>	103
11.6.1.	Test Result	103
11.6.2.	Test Graphs	104
11.7.	<i>APPENDIX G: DUTY CYCLE</i>	113
11.7.1.	Test Result	113
11.7.2.	Test Graphs	114



1. ATTESTATION OF TEST RESULTS

Applicant Information

Company Name: Motorola Solutions, Inc.
Address: 8000, West Sunrise Blvd., Ft Lauderdale, Florida 33322, United States

Manufacturer Information

Company Name: Motorola Solutions, Inc.
Address: 8000, West Sunrise Blvd., Ft Lauderdale, Florida 33322, United States

EUT Information

EUT Name: Two Way Portable Radio R7
Model: AAH06UCN9RB1AN (IC Model: PMUF2000ABB)
Brand: Motorola
Sample Received Date: August 10, 2022
Sample Status: Normal
Sample ID: 5225541
Date of Tested: August 10, 2022 to August 24, 2022

APPLICABLE STANDARDS	
STANDARD	TEST RESULTS
CFR 47 FCC PART 15 SUBPART C ISED RSS-247 ISSUE 2	Pass

Prepared By:

Kebo Zhang
Senior Project Engineer

Checked By:

Denny Huang
Senior Project Engineer

Approved By:

Stephen Guo
Operations Manager



2. TEST METHODOLOGY

All tests were performed in accordance with the standard CFR 47 FCC PART 15 SUBPART C ISED RSS-247 ISSUE 2, KDB 558074 D01 15.247 Meas Guidance v05r02, KDB 414788 D01 Radiated Test Site v01r01, CFR 47 FCC Part 2, CFR 47 FCC Part 15, ANSI C63.10-2013, ISED RSS-247 Issue 2 and ISED RSS-GEN Issue 5

3. FACILITIES AND ACCREDITATION

Accreditation Certificate	<p>A2LA (Certificate No.: 4102.01) UL Verification Services (Guangzhou) Co., Ltd. Song Shan Lake Branch. has been assessed and proved to be in compliance with A2LA.</p> <p>FCC (FCC Designation No.: CN1187) UL Verification Services (Guangzhou) Co., Ltd. Song Shan Lake Branch. Has been recognized to perform compliance testing on equipment subject to the Commission's Delcaration of Conformity (DoC) and Certification rules</p> <p>ISED (Company No.: 21320) UL Verification Services (Guangzhou) Co., Ltd. Song Shan Lake Branch. has been registered and fully described in a report filed with ISED. The Company Number is 21320 and the test lab Conformity Assessment Body Identifier (CABID) is CN0046.</p> <p>VCCI (Registration No.: G-20019, R-20004, C-20012 and T-20011) UL Verification Services (Guangzhou) Co., Ltd. Song Shan Lake Branch. has been assessed and proved to be in compliance with VCCI, the Membership No. is 3793. Facility Name: Chamber D, the VCCI registration No. is G-20019 and R-20004 Shielding Room B , the VCCI registration No. is C-20012 and T-20011</p>
---------------------------	--

Note1:

All tests measurement facilities use to collect the measurement data are located at Building 10, Innovation Technology Park, No. 1, Li Bin Road, Song Shan Lake Hi-Tech Development Zone Dongguan, 523808, People’s Republic of China.

Note2:

The test anechoic chamber in UL Verification Services (Guangzhou) Co., Ltd. Song Shan Lake Branch had been calibrated and compared to the open field sites and the test anechoic chamber is shown to be equivalent to or worst case from the open field site.

Note3:

For below 30 MHz, lab had performed measurements at test anechoic chamber and comparing to measurements obtained on an open field site. And these measurements below 30 MHz had been correlated to measurements performed on an OFS.



4. CALIBRATION AND UNCERTAINTY

4.1. MEASURING INSTRUMENT CALIBRATION

The measuring equipment utilized to perform the tests documented in this report has been calibrated in accordance with the manufacturer's recommendations and is traceable to recognized national standards.

4.2. MEASUREMENT UNCERTAINTY

Where relevant, the following measurement uncertainty levels have been estimated for tests performed on the apparatus:

Test Item	Uncertainty
Conduction emission	3.62 dB
Radiated Emission (Included Fundamental Emission) (9 kHz ~ 30 MHz)	2.2 dB
Radiated Emission (Included Fundamental Emission) (30 MHz ~ 1 GHz)	4.00 dB
Radiated Emission (Included Fundamental Emission) (1 GHz to 26 GHz)	5.78 dB (1 GHz ~ 18 GHz)
	5.23 dB (18 GHz ~ 26 GHz)
Note: This uncertainty represents an expanded uncertainty expressed at approximately the 95% confidence level using a coverage factor of k=2.	

5. EQUIPMENT UNDER TEST

5.1. DESCRIPTION OF EUT

EUT Name	Two Way Portable Radio R7
Model	AAH06UCN9RB1AN (IC Model: PMUF2000ABB)
Frequency Range:	2412 MHz to 2462 MHz
Radio Technology	IEEE802.11b/g/n HT20
Type of Modulation:	IEEE 802.11b: DSSS(CCK, DQPSK, DBPSK) IEEE 802.11g/n: OFDM(64-QAM, 16-QAM, QPSK, BPSK)
Firmware Version:	D02.22.02.1009
Test Voltage:	Normal Voltage: DC 7.5 V Battery: PMNN4809A DC 7.7 V, 21.9 Wh PMNN4810A DC 7.2 V, 23.0 Wh

Note: We have pre-test the two battery, only the worst data on PMNN4809A battery usage was recorded in the report.

5.2. CHANNEL LIST

Channel List for 802.11b/g/n (20 MHz)							
Channel	Frequency (MHz)	Channel	Frequency (MHz)	Channel	Frequency (MHz)	Channel	Frequency (MHz)
1	2412	4	2427	7	2442	10	2457
2	2417	5	2432	8	2447	11	2462
3	2422	6	2437	9	2452	/	/

5.3. MAXIMUM EIRP

IEEE Std. 802.11	Frequency (MHz)	Channel Number	Maximum Conducted AVG Output Power (dBm)	Maximum AVG EIRP (dBm)
b	2412 ~ 2462	1-11[11]	14.91	16.94
g	2412 ~ 2462	1-11[11]	12.82	14.85
n HT20	2412 ~ 2462	1-11[11]	12.93	14.96

5.4. TEST CHANNEL CONFIGURATION

IEEE Std. 802.11	Test Channel Number	Frequency
b	CH 1(Low Channel), CH 6(MID Channel), CH 11(High Channel)	2412 MHz, 2437 MHz, 2462 MHz
g	CH 1(Low Channel), CH 6(MID Channel), CH 11(High Channel)	2412 MHz, 2437 MHz, 2462 MHz
n HT20	CH 1(Low Channel), CH 6(MID Channel), CH 11(High Channel)	2412 MHz, 2437 MHz, 2462 MHz



5.5. THE WORSE CASE POWER SETTING PARAMETER

The Worse Case Power Setting Parameter under 2400 ~ 2483.5MHz Band				
Test Software		MP Tool		
Modulation Mode	Transmit Antenna Number	Test Channel		
		NCB: 20MHz		
		CH 1	CH 6	CH 11
802.11b	1	15	15	15
802.11g	1	13	13	13
802.11n HT20	1	13	13	13

WORST-CASE CONFIGURATIONS

The EUT was tested in the following configuration(s):

Controlled in test mode using a software application on the EUT supplied by customer. The application was used to enable a continuous transmission and to select the mode, test channels, bandwidth, data rates as required.

Test channels referring to section 5.4.

Maximum power setting referring to section 5.5.

Worst-case data rates as provided by the client were:

802.11b mode: 1 Mbps
802.11g mode: 6 Mbps
802.11n HT20 mode: MCS0

The measured additional path loss was included in any path loss calculations for all RF cable used during tested.



5.6. DESCRIPTION OF AVAILABLE ANTENNAS

Antenna	Frequency (MHz)	Antenna Type	MAX Antenna Gain (dBi)
1	2412-2462	PCB antenna	2.03

Test Mode	Transmit and Receive Mode	Description
IEEE 802.11b	<input checked="" type="checkbox"/> 1TX, 1RX	ANT 1 can be used as transmitting/receiving antenna.
IEEE 802.11g	<input checked="" type="checkbox"/> 1TX, 1RX	ANT 1 can be used as transmitting/receiving antenna.
IEEE 802.11n HT20	<input checked="" type="checkbox"/> 1TX, 1RX	ANT 1 can be used as transmitting/receiving antenna.

Note: The value of the antenna gain was declared by customer.



5.7. SUPPORT UNITS FOR SYSTEM TEST

SUPPORT EQUIPMENT

Item	Accessory	Brand Name	Model Name	Description
1	/	/	/	/

I/O CABLES

Item	Type of cable	Shielded Type	Ferrite Core	Length
1	/	/	/	/

ACCESSORY

Item	Accessory	Brand Name	Model Name	Description	Remark	Test Voltage
1	Lithium battery	Motorola	PMNN4809A	DC 7.7V / 21.9Wh	/	/
2	Lithium battery	Motorola	PMNN4810A	DC 7.2V / 23.0Wh	/	/
3	Charger	Motorola	PMPN4284A	MUC	PMPN4284A = BASE PMPN4283A + POWER SUPPLY PS000242A01 + LINE CORD	AC 120 V, 60 Hz
4	Two Way Portable Radio R7	Motorola	AAH06UCN9RB1AN (IC Model: PMUF2000ABB)	*2	/	/

5.8. SETUP DIAGRAM

Radio Alone

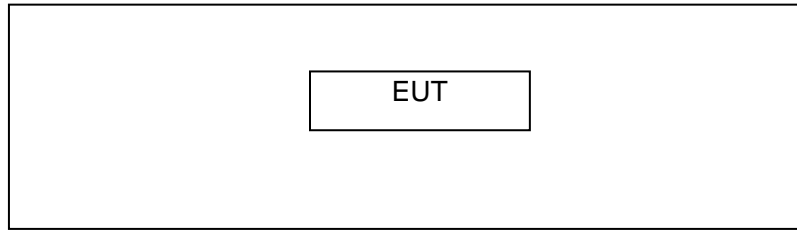

Radio with charger - AC input

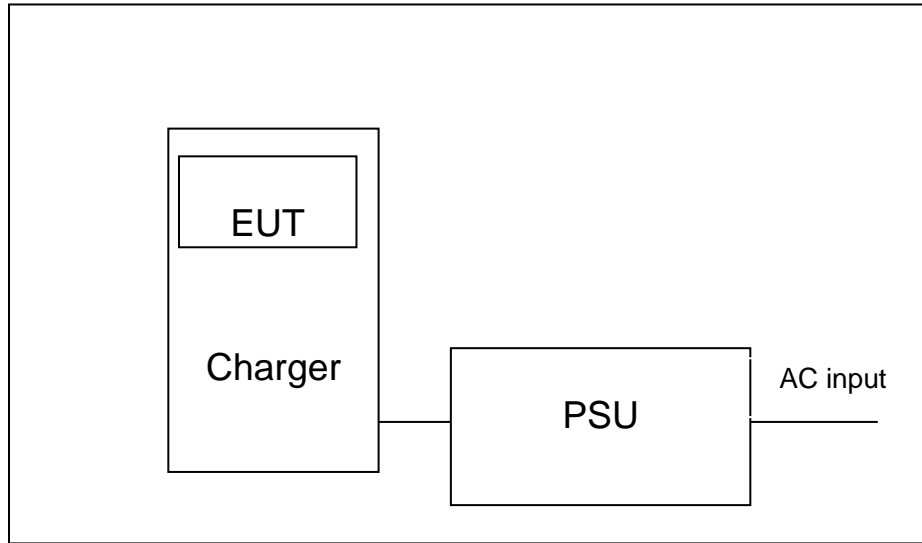

**6. MEASURING EQUIPMENT AND SOFTWARE USED**

R&S TS 8997 Test System					
Equipment	Manufacturer	Model No.	Serial No.	Last Cal.	Due. Date
Power sensor, Power Meter	R&S	OSP120	100921	Apr.02,2022	Apr.01,2023
Vector Signal Generator	R&S	SMBV100A	261637	Oct.30, 2021	Oct.29, 2022
Signal Generator	R&S	SMB100A	178553	Oct.30, 2021	Oct.29, 2022
Signal Analyzer	R&S	FSV40	101118	Oct.30, 2021	Oct.29, 2022
Software					
Description	Manufacturer	Name		Version	
For R&S TS 8997 Test System	Rohde & Schwarz	EMC 32		10.60.10	
Tonsend RF Test System					
Equipment	Manufacturer	Model No.	Serial No.	Last Cal.	Due. Date
Wideband Radio Communication Tester	R&S	CMW500	155523	Oct.30, 2021	Oct.29, 2022
Wireless Connectivity Tester	R&S	CMW270	1201.0002N75-102	Sep.29, 2021	Sep.28, 2022
PXA Signal Analyzer	Keysight	N9030A	MY55410512	Oct.30, 2021	Oct.29, 2022
MXG Vector Signal Generator	Keysight	N5182B	MY56200284	Oct.30, 2021	Oct.29, 2022
MXG Vector Signal Generator	Keysight	N5172B	MY56200301	Oct.30, 2021	Oct.29, 2022
DC power supply	Keysight	E3642A	MY55159130	Oct.30, 2021	Oct.29, 2022
Temperature & Humidity Chamber	SANMOOD	SG-80-CC-2	2088	Nov.20,2020	Nov.19,2022
Software					
Description	Manufacturer	Name		Version	
Tonsend SRD Test System	Tonsend	JS1120-3 RF Test System		2.6.77.0518	



Conducted Emissions					
Equipment	Manufacturer	Model No.	Serial No.	Last Cal.	Due Date
EMI Test Receiver	R&S	ESR3	101961	Oct.30, 2021	Oct.29, 2022
Two-Line V-Network	R&S	ENV216	101983	Oct.30, 2021	Oct.29, 2022
Artificial Mains Networks	Schwarzbeck	NSLK 8126	8126465	Oct.30, 2021	Oct.29, 2022
Software					
Description			Manufacturer	Name	Version
Test Software for Conducted Emissions			Farad	EZ-EMC	Ver. UL-3A1

Radiated Emissions					
Equipment	Manufacturer	Model No.	Serial No.	Last Cal.	Due Date
MXE EMI Receiver	KESIGHT	N9038A	MY56400036	Oct.30, 2021	Oct.29, 2022
Hybrid Log Periodic Antenna	TDK	HLP-3003C	130959	Aug.02, 2021	Aug.01, 2024
Preamplifier	HP	8447D	2944A09099	Oct.30, 2021	Oct.29, 2022
EMI Measurement Receiver	R&S	ESR26	101377	Oct.30, 2021	Oct.29, 2022
Horn Antenna	TDK	HRN-0118	130940	July 20, 2021	July 19, 2024
Preamplifier	TDK	PA-02-0118	TRS-305-00067	Oct.30, 2021	Oct.29, 2022
Horn Antenna	Schwarzbeck	BBHA9170	697	July 20, 2021	July 19, 2024
Preamplifier	TDK	PA-02-2	TRS-307-00003	Oct.31, 2021	Oct.30, 2022
Preamplifier	TDK	PA-02-3	TRS-308-00002	Oct.31, 2021	Oct.30, 2022
Loop antenna	Schwarzbeck	1519B	00008	Dec.14, 2021	Dec.13, 2024
Preamplifier	TDK	PA-02-001-3000	TRS-302-00050	Oct.31, 2021	Oct.30, 2022
Preamplifier	Mini-Circuits	ZX60-83LN-S+	SUP01201941	Oct.31, 2021	Oct.30, 2022
High Pass Filter	Wi	WHKX10-2700-3000-18000-40SS	23	Oct.31, 2021	Oct.30, 2022
Highpass Filter	Wainwright	WHKX10-5850-6500-1800-40SS	4	Oct.31, 2021	Oct.30, 2022
Band Reject Filter	Wainwright	WRCJV12-5695-5725-5850-5880-40SS	4	Oct.31, 2021	Oct.30, 2022
Band Reject Filter	Wainwright	WRCJV20-5120-5150-	2	Oct.31, 2021	Oct.30, 2022



		5350-5380-60SS			
Band Reject Filter	Wainwright	WRCJV20-5440-5470-5725-5755-60SS	1	Oct.31, 2021	Oct.30, 2022
Band Reject Filter	Wainwright	WRCJV8-2350-2400-2483.5-2533.5-40SS	4	Oct.31, 2021	Oct.30, 2022
Band Reject Filter	Wainwright	WRCD5-1879-1879.85-1880.15-1881-40SS	1	Oct.31, 2021	Oct.30, 2022
Notch Filter	Wainwright	WHJ10-882-980-7000-40SS	1	Oct.31, 2021	Oct.30, 2022
Software					
Description			Manufacturer	Name	Version
Test Software for Radiated Emissions			Farad	EZ-EMC	Ver. UL-3A1

Other Instrument					
Equipment	Manufacturer	Model No.	Serial No.	Last Cal.	Due Date
Temperature humidity probe	OMEGA	ITHX-SD-5	18470007	Nov. 4, 2021	Nov. 3, 2022
Barometer	Yiyi	Baro	N/A	Nov. 15, 2021	Nov. 14, 2022

7. ANTENNA PORT TEST RESULTS

7.1. CONDUCTED OUTPUT POWER

LIMITS

CFR 47 FCC Part15 (15.247) Subpart C ISED RSS-247 ISSUE 2			
Section	Test Item	Limit	Frequency Range (MHz)
CFR 47 FCC 15.247(b)(3) ISED RSS-247 5.4 (d)	AVG Output Power	1 watt or 30 dBm	2400-2483.5

TEST PROCEDURE

Refer to ANSI C63.10-2013 clause 11.9.2.3.1.

Connect the EUT to a low loss RF cable from the antenna port to the power sensor (video bandwidth is greater than the occupied bandwidth).

Measure peak emission level, the indicated level is the average output power, after any corrections for external attenuators and cables.

The test result in dBm by adding $[10 \log (1 / D)]$, where D is the duty cycle.

TEST SETUP

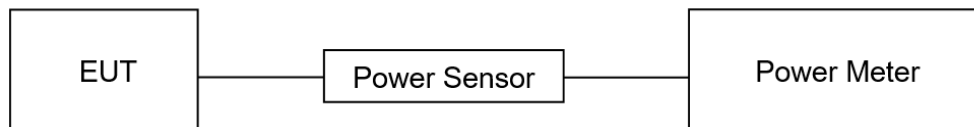

TEST ENVIRONMENT

Temperature	23.9°C	Relative Humidity	64%
Atmosphere Pressure	101kPa	Test Voltage	

TEST RESULTS

Please refer to section "Test Data" - Appendix C

7.2. 6DB BANDWIDTH AND 99% OCCUPIED BANDWIDTH

LIMITS

CFR 47 FCC Part15 (15.247) Subpart C ISED RSS-247 ISSUE 2			
Section	Test Item	Limit	Frequency Range (MHz)
CFR 47 FCC 15.247(a)(2) ISED RSS-247 5.2 (a)	6 dB Bandwidth	≥ 500 kHz	2400-2483.5
ISED RSS-Gen Clause 6.7	99 % Occupied Bandwidth	For reporting purposes only.	2400-2483.5

TEST PROCEDURE

Refer to ANSI C63.10-2013 clause 11.8 for DTS bandwidth and clause 6.9 for Occupied Bandwidth.

Connect the EUT to the spectrum analyser and use the following settings:

Center Frequency	The center frequency of the channel under test
Frequency Span	For 6 dB Bandwidth: Enough to capture all products of the modulation carrier emission For 99 % Occupied Bandwidth: Between 1.5 times and 5.0 times the OBW
Detector	Peak
RBW	For 6 dB Bandwidth: 100 kHz For 99 % Occupied Bandwidth: 1 % to 5 % of the occupied bandwidth
VBW	For 6 dB Bandwidth: ≥3 × RBW For 99 % Occupied Bandwidth: ≥3 × RBW
Trace	Max hold
Sweep	Auto couple

a) Use the 99 % power bandwidth function of the instrument, allow the trace to stabilize and report the measured bandwidth.

b) Allow the trace to stabilize and measure the maximum width of the emission that is constrained by the frequencies associated with the two outermost amplitude points (upper and lower frequencies) that are attenuated by 6 dB relative to the maximum level measured in the fundamental emission.



TEST SETUP

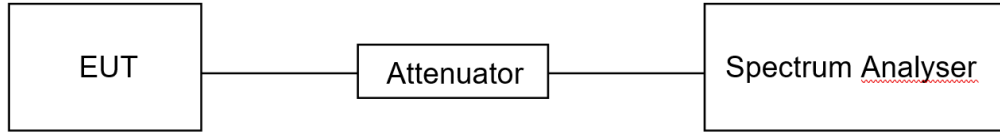

TEST ENVIRONMENT

Temperature	23.9°C	Relative Humidity	64%
Atmosphere Pressure	101kPa	Test Voltage	DC 7.5 V

TEST RESULTS

Please refer to section "Test Data" - Appendix A&B

7.3. POWER SPECTRAL DENSITY

LIMITS

CFR 47 FCC Part15 (15.247) Subpart C ISED RSS-247 ISSUE 2			
Section	Test Item	Limit	Frequency Range (MHz)
CFR 47 FCC §15.247 (e) ISED RSS-247 5.2 (b)	Power Spectral Density	8 dBm in any 3 kHz band	2400-2483.5

TEST PROCEDURE

Refer to ANSI C63.10-2013 clause 11.10.5.

Connect the EUT to the spectrum analyser and use the following settings:

Center Frequency	The center frequency of the channel under test
Detector	power averaging (rms) or sample detector
RBW	$3 \text{ kHz} \leq \text{RBW} \leq 100 \text{ kHz}$
VBW	$\geq 3 \times \text{RBW}$
Span	1.5 x OBW bandwidth
Trace	Average
Sweep time	Auto couple

Allow trace to fully stabilize and use the peak marker function to determine the maximum amplitude level within the RBW.

If measured value exceeds limit, reduce RBW (no less than 3 kHz) and repeat.

TEST SETUP

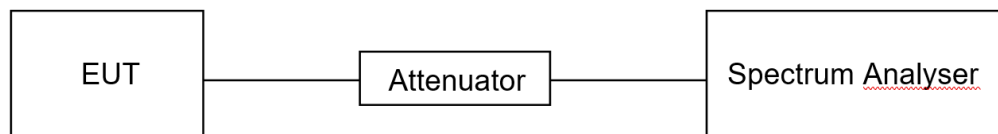

TEST ENVIRONMENT

Temperature	23.9°C	Relative Humidity	64%
Atmosphere Pressure	101kPa	Test Voltage	DC 7.5 V

TEST RESULTS

Please refer to section "Test Data" - Appendix D

7.4. CONDUCTED BAND EDGE AND SPURIOUS EMISSION

TEST PROCEDURE

Refer to ANSI C63.10-2013 clause 11.11 and 11.13.

Connect the EUT to the spectrum analyser and use the following settings for reference level measurement:

Center Frequency	The center frequency of the channel under test
Detector	Peak
RBW	100 kHz
VBW	$\geq 3 \times \text{RBW}$
Span	1.5 x DTS bandwidth
Trace	Max hold
Sweep time	Auto couple.

Allow trace to fully stabilize and use the peak marker function to determine the maximum PSD level.

Change the settings for emission level measurement:

Span	Set the center frequency and span to encompass frequency range to be measured
Detector	Peak
RBW	100 kHz
VBW	$\geq 3 \times \text{RBW}$
measurement points	$\geq \text{span}/\text{RBW}$
Trace	Max hold
Sweep time	Auto couple.

Allow trace to fully stabilize and use the peak marker function to determine the maximum PSD level. Ensure that the amplitude of all unwanted emissions outside of the authorized frequency band (excluding restricted frequency bands) is attenuated by at least the minimum requirements specified in 11.11.

TEST SETUP

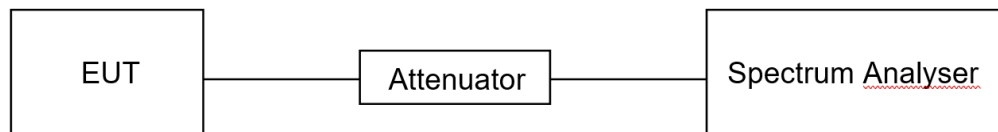

TEST ENVIRONMENT

Temperature	23.9°C	Relative Humidity	64%
Atmosphere Pressure	101kPa	Test Voltage	DC 7.5 V



TEST RESULTS

Please refer to section "Test Data" - Appendix E&F



7.5. DUTY CYCLE

LIMITS

None; for reporting purposes only.

TEST PROCEDURE

Refer to ANSI C63.10-2013 clause 11.6 Zero – Span Spectrum Analyzer method.

TEST SETUP

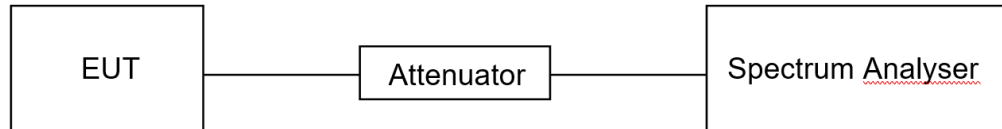

TEST ENVIRONMENT

Temperature	23.9°C	Relative Humidity	64%
Atmosphere Pressure	101kPa	Test Voltage	DC 7.5 V

TEST RESULTS

Please refer to section "Test Data" - Appendix G

8. RADIATED TEST RESULTS

LIMITS

Please refer to CFR 47 FCC §15.205 and §15.209.

Please refer to ISED RSS-GEN Clause 8.9 and Clause 8.10.

Radiation Disturbance Test Limit for FCC (Class B) (9 kHz ~ 1 GHz)

Emissions radiated outside of the specified frequency bands above 30 MHz			
Frequency Range (MHz)	Field Strength Limit (uV/m) at 3 m	Field Strength Limit (dBuV/m) at 3 m	
		Quasi-Peak	
30 - 88	100	40	
88 - 216	150	43.5	
216 - 960	200	46	
Above 960	500	54	
Above 1000	500	Peak	Average
		74	54

FCC Emissions radiated outside of the specified frequency bands below 30 MHz		
Frequency (MHz)	Field strength (microvolts/meter)	Measurement distance (meters)
0.009-0.490	2400/F(kHz)	300
0.490-1.705	24000/F(kHz)	30
1.705-30.0	30	30

ISED General field strength limits at frequencies below 30 MHz

Table 6 – General field strength limits at frequencies below 30 MHz		
Frequency	Magnetic field strength (H-Field) (uA/m)	Measurement distance (m)
9 - 490 kHz ^{Note 1}	6.37/F (F in kHz)	300
490 - 1705 kHz	63.7/F (F in kHz)	30
1.705 - 30 MHz	0.08	30

Note 1: The emission limits for the ranges 9-90 kHz and 110-490 kHz are based on measurements employing a linear average detector.



ISED Restricted bands please refer to ISED RSS-GEN Clause 8.10

Table 7 – Restricted frequency bands ^{Note 1}		
MHz	MHz	GHz
0.090 - 0.110	149.9 - 150.05	9.0 - 9.2
0.495 - 0.505	156.52475 - 156.52525	9.3 - 9.5
2.1735 - 2.1905	156.7 - 156.9	10.6 - 12.7
3.020 - 3.026	162.0125 - 167.17	13.25 - 13.4
4.125 - 4.128	167.72 - 173.2	14.47 - 14.5
4.17725 - 4.17775	240 - 285	15.35 - 16.2
4.20725 - 4.20775	322 - 335.4	17.7 - 21.4
5.677 - 5.683	399.9 - 410	22.01 - 23.12
6.215 - 6.218	608 - 614	23.6 - 24.0
6.26775 - 6.26825	960 - 1427	31.2 - 31.8
6.31175 - 6.31225	1435 - 1626.5	36.43 - 36.5
8.291 - 8.294	1645.5 - 1646.5	Above 38.6
8.362 - 8.366	1660 - 1710	
8.37625 - 8.38675	1718.8 - 1722.2	
8.41425 - 8.41475	2200 - 2300	
12.29 - 12.293	2310 - 2390	
12.51975 - 12.52025	2483.5 - 2500	
12.57675 - 12.57725	2655 - 2900	
13.36 - 13.41	3260 - 3267	
16.42 - 16.423	3332 - 3339	
16.60475 - 16.60525	3345.8 - 3358	
16.80425 - 16.80475	3500 - 4400	
25.5 - 25.67	4500 - 5150	
37.5 - 38.25	5350 - 5460	
73 - 74.6	7250 - 7750	
74.8 - 75.2	8025 - 8500	
108 - 138		

Note 1: Certain frequency bands listed in table 7 and in bands above 38.6 GHz are designated for licence-exempt applications. These frequency bands and the requirements that apply to related devices are set out in the 200 and 300 series of RSSs.

FCC Restricted bands of operation refer to FCC §15.205 (a):

MHz	MHz	MHz	GHz
0.090-0.110	16.42-16.423	399.9-410	4.5-5.15
¹ 0.495-0.505	16.69475-16.69525	608-614	5.35-5.46
2.1735-2.1905	16.80425-16.80475	960-1240	7.25-7.75
4.125-4.128	25.5-25.67	1300-1427	8.025-8.5
4.17725-4.17775	37.5-38.25	1435-1626.5	9.0-9.2
4.20725-4.20775	73-74.6	1645.5-1646.5	9.3-9.5
6.215-6.218	74.8-75.2	1660-1710	10.6-12.7
6.26775-6.26825	108-121.94	1718.8-1722.2	13.25-13.4
6.31175-6.31225	123-138	2200-2300	14.47-14.5
8.291-8.294	149.9-150.05	2310-2390	15.35-16.2
8.362-8.366	156.52475-156.52525	2483.5-2500	17.7-21.4
8.37625-8.38675	156.7-156.9	2690-2900	22.01-23.12
8.41425-8.41475	162.0125-167.17	3260-3267	23.6-24.0
12.29-12.293	167.72-173.2	3332-3339	31.2-31.8
12.51975-12.52025	240-285	3345.8-3358	36.43-36.5
12.57675-12.57725	322-335.4	3600-4400	(²)
13.36-13.41			

Note: ¹Until February 1, 1999, this restricted band shall be 0.490-0.510 MHz.

²Above 38.6c

TEST PROCEDURE

Below 30 MHz

The setting of the spectrum analyser

RBW	200 Hz (From 9 kHz to 0.15 MHz)/ 9 kHz (From 0.15 MHz to 30 MHz)
VBW	200 Hz (From 9 kHz to 0.15 MHz)/ 9 kHz (From 0.15 MHz to 30 MHz)
Sweep	Auto

1. The testing follows the guidelines in ANSI C63.10-2013 clause 6.4.
2. The EUT was arranged to its worst case and then turntable (from 0 degree to 360 degrees) to find the maximum reading. A pre-amp and a high pass filter are used for the test in order to get better signal level. Both Horizontal, Face-on and Face-off polarizations of the antenna are set to make the measurement.
3. The EUT was placed on a turntable with 80 cm above ground.
4. The EUT was set 3 meters from the interference receiving antenna, which was mounted on the top of a 1 m height antenna tower.
5. The radiated emission limits are based on measurements employing a CISPR quasi-peak detector except for the frequency bands 9-90 kHz, 110-490 kHz and above 1000 MHz Radiated emission limits in these three bands are based on measurements employing an average detector.
6. For measurement below 1 GHz, the initial step in collecting conducted emission data is a spectrum analyzer peak detector mode pre-scanning the measurement frequency range. Significant peaks are then marked and then Quasi Peak and average detector mode re-measured. If the emission level of the EUT measured by the peak detector is 3 dB lower than the applicable limit, the peak emission level will be reported. Otherwise, the emission measurement will be repeated using the quasi-peak and average detector and reported.
7. Although these tests were performed other than open field site, adequate comparison measurements were confirmed against 30m open field site. Therefore sufficient tests were made to demonstrate that the alternative site produces results that correlate with the ones of tests made in an open field site based on KDB 414788.
8. The limits in CFR 47, Part 15, Subpart C, paragraph 15.209 (a), are identical to those in RSS-GEN Section 8.9, Table 6, since the measurements are performed in terms of magnetic field strength and converted to electric field strength levels (as reported in the table) using the free space impedance of 377Ω. For example, the measurement frequency X KHz resulted in a level of Y dBuV/m, which is equivalent to $Y-51.5 = Z$ dBuA/m, which has the same margin, W dB, to the corresponding RSS-GEN Table 6 limit as it has to be 15.209(a) limit.

Below 1 GHz and above 30 MHz

The setting of the spectrum analyser

RBW	120 kHz
VBW	300 kHz
Sweep	Auto
Detector	Peak/QP
Trace	Max hold

1. The testing follows the guidelines in ANSI C63.10-2013 clause 6.5.
2. The EUT was arranged to its worst case and then tune the antenna tower (from 1 m to 4 m) and turntable (from 0 degree to 360 degrees) to find the maximum reading. A pre-amp and a high pass filter are used for the test in order to get better signal level. Both horizontal and vertical polarizations of the antenna are set to make the measurement.
3. The EUT was placed on a turntable with 80 cm above ground.
4. The EUT was set 3 meters from the interference receiving antenna, which was mounted on the top of a variable height antenna tower.
5. For measurement below 1 GHz, the initial step in collecting conducted emission data is a spectrum analyzer peak detector mode pre-scanning the measurement frequency range. Significant peaks are then marked and then Quasi Peak detector mode re-measured. If the emission level of the EUT measured by the peak detector is 3 dB lower than the applicable limit, the peak emission level will be reported. Otherwise, the emission measurement will be repeated using the quasi-peak detector and reported.

Above 1G

The setting of the spectrum analyser

RBW	1 MHz
VBW	PEAK: 3 MHz AVG: see note 6
Sweep	Auto
Detector	Peak
Trace	Max hold

1. The testing follows the guidelines in ANSI C63.10-2013 clause 6.6.
2. The EUT was arranged to its worst case and then tune the antenna tower (from 1 m to 4 m) and turntable (from 0 degree to 360 degrees) to find the maximum reading. A pre-amp and a high pass filter are used for the test in order to get better signal level. Both horizontal and vertical polarizations of the antenna are set to make the measurement.
3. The EUT was placed on a turntable with 1.5 m above ground.
4. The EUT was set 3 meters from the interference receiving antenna, which was mounted on the top of a variable height antenna tower.
5. For measurement above 1 GHz, the emission measurement will be measured by the peak detector. This peak level, once corrected, must comply with the limit specified in Section 15.209.
6. For measurements above 1 GHz the resolution bandwidth is set to 1 MHz, then the video bandwidth is set to 3 MHz for peak measurements and 1 MHz resolution bandwidth with 1/T video bandwidth with peak detector for average measurements. For the Duty Cycle please refer to clause 7.5.ON TIME AND DUTY CYCLE.

X axis, Y axis, Z axis positions:

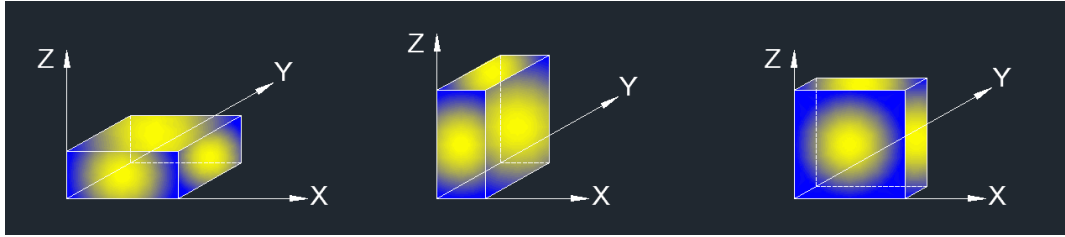

Note 1: For all radiated test, EUT in each of three orthogonal axis emissions had been tested, but only the worst case (X axis) data recorded in the report.

For Band edge note:

1. Measurement = Reading Level + Correct Factor.
2. If Peak Result complies with AV limit, AV Result is deemed to comply with AV limit.
3. Peak: Peak detector.
4. AVG: $VBW=1/Ton$, where: Ton is the transmitting duration.
5. For the transmitting duration, please refer to clause 7.5.
6. Only the worst data was recorded, if it complies with the limit, the other emissions deemed to comply with the limit.
7. Horizontal and Vertical have been tested, only the worst data was recorded in the report.
8. All modes and channels have been tested, only the worst data was recorded in the report.

For Radiate Spurious emission 1GHz-3GHz note:

- Note:
1. Measurement = Reading Level + Correct Factor.
 2. If Peak Result complies with AV limit, AV Result is deemed to comply with AV limit.
 3. Peak: Peak detector.
 4. AVG: $VBW=1/Ton$, where: Ton is the transmitting duration.
 5. For the transmitting duration, please refer to clause 7.5.
 6. Filter losses were only considered in the spurious frequency bands and the authorized band was not corrected for Band reject filter losses.
 7. Proper operation of the transmitter prior to adding the filter to the measurement chain.
 8. All modes and channels have been tested, only the worst data was recorded in the report.

For Radiate Spurious emission 3GHz-18GHz note:

- Note:
1. Peak Result = Reading Level + Correct Factor.
 2. If Peak Result complies with AV limit, AV Result is deemed to comply with AV limit.
 3. Peak: Peak detector.
 4. AVG: $VBW=1/Ton$, where: Ton is the transmitting duration.
 5. For the transmitting duration, please refer to clause 7.5.
 6. Filter losses were only considered in the spurious frequency bands and the authorized band was not corrected for High Pass Filter losses.
 7. Proper operation of the transmitter prior to adding the filter to the measurement chain.



For Radiate Spurious emission 9kHz-30MHz note:

1. Measurement = Reading Level + Correct Factor.
2. If Peak Result complies with AV and QP limit, AV and QP Result are deemed to comply with AV limit.
3. All 3 polarizations (Horizontal, Face-on and Face-off) of the loop antenna had been tested, but only the worst data recorded in the report.
4. All modes and channels have been tested, only the worst data was recorded in the report.

For Radiate Spurious emission 18GHz-26GHz note:

1. Measurement = Reading Level + Correct Factor.
2. If Peak Result complies with AV limit, AV Result is deemed to comply with AV limit.
3. Peak: Peak detector.
4. All modes and channels have been tested, only the worst data was recorded in the report.

For Radiate Spurious emission 30MHz-1GHz note:

1. Result Level = Read Level + Correct Factor.
2. If Peak Result complies with QP limit, QP Result is deemed to comply with QP limit.
3. Test setup: RBW: 120 kHz, VBW: 300 kHz, Sweep time: auto.
4. All modes and channels have been tested, only the worst data was recorded in the report.

TEST SETUP

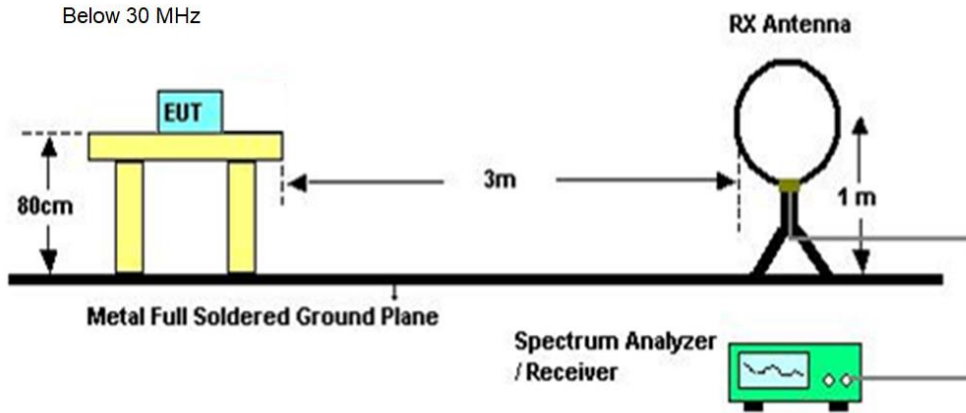

Below 1 GHz and above 30 MHz

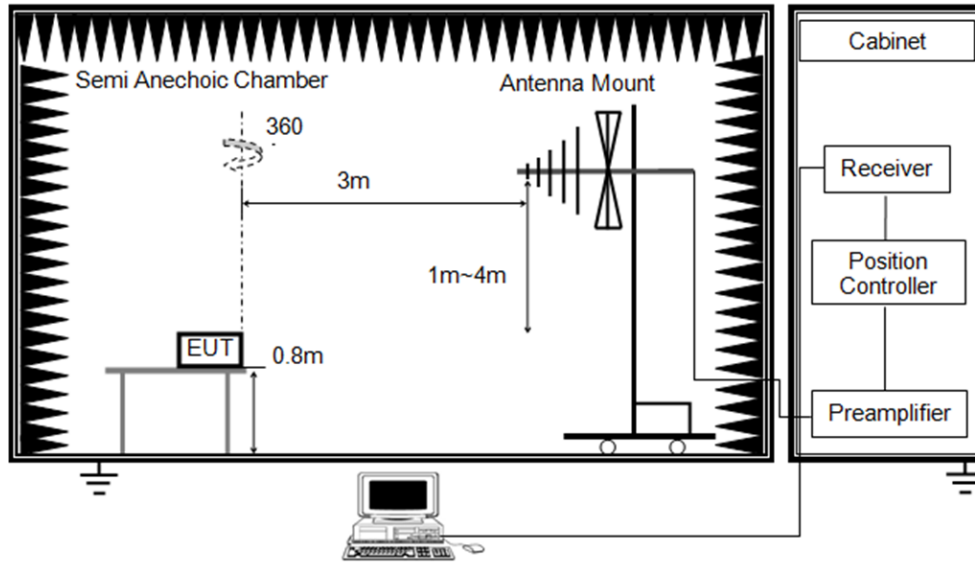

Above 1 GHz

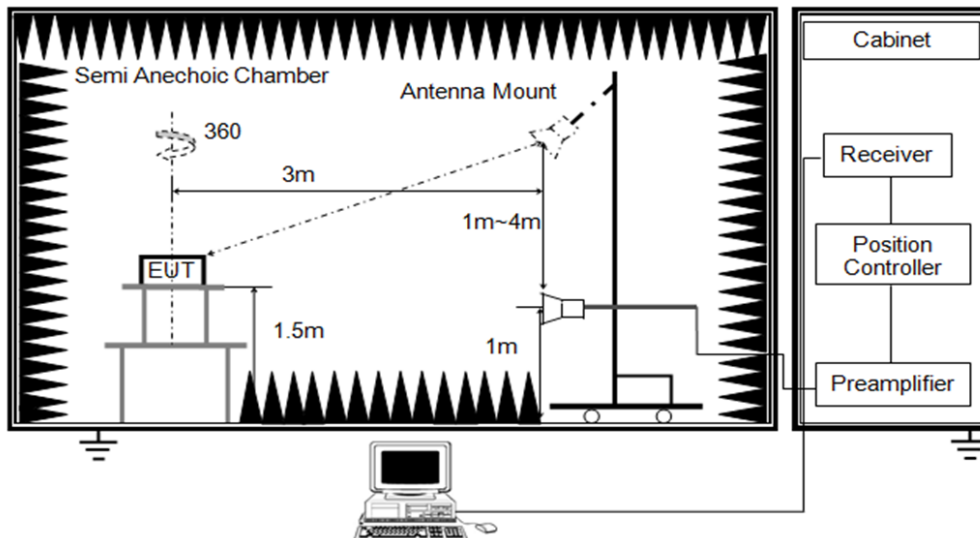



TEST ENVIRONMENT

Temperature	25.6°C	Relative Humidity	63%
Atmosphere Pressure	101kPa	Test Voltage	DC 7.5 V

TEST RESULTS



8.1. RESTRICTED BANDEDGE

Test Mode:	802.11b PK	Channel:	2412
Polarity:	Horizontal		

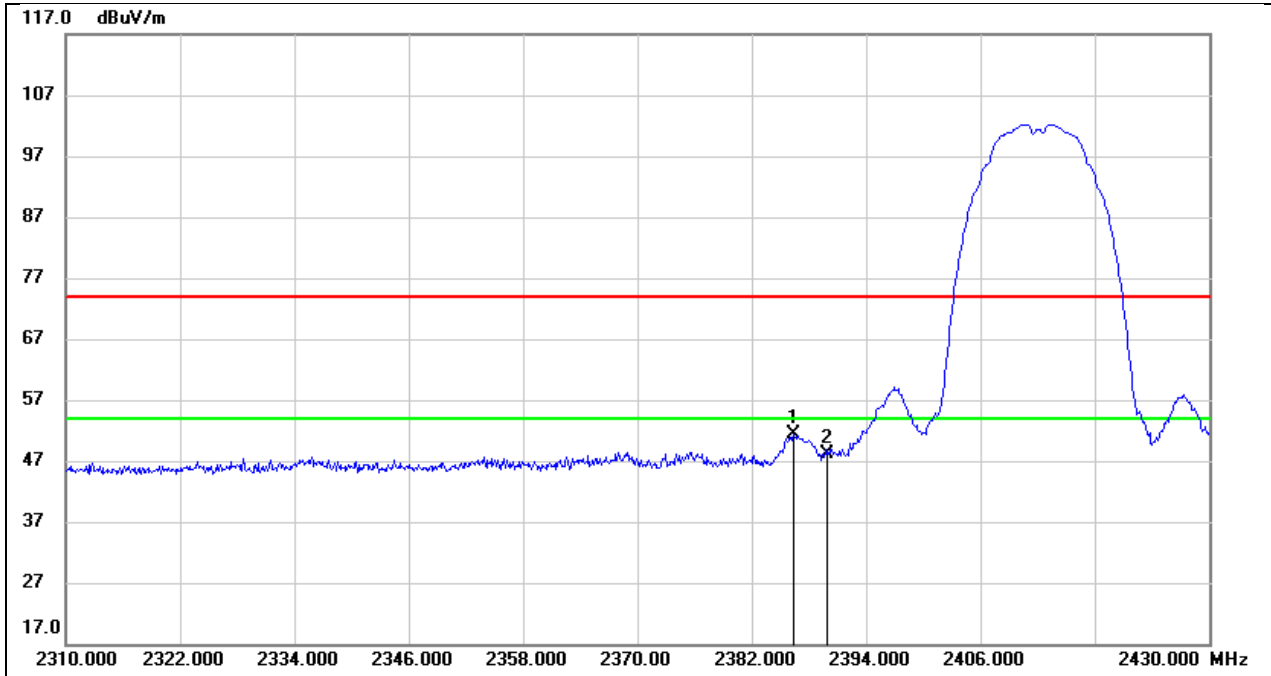

No.	Frequency (MHz)	Reading (dBuV)	Correct (dB/m)	Result (dBuV/m)	Limit (dBuV/m)	Margin (dB)	Remark
1	2386.320	19.22	32.14	51.36	74.00	-22.64	peak
2	2390.000	15.91	32.16	48.07	74.00	-25.93	peak



Test Mode:	802.11b AV	Channel:	2412
Polarity:	Horizontal		

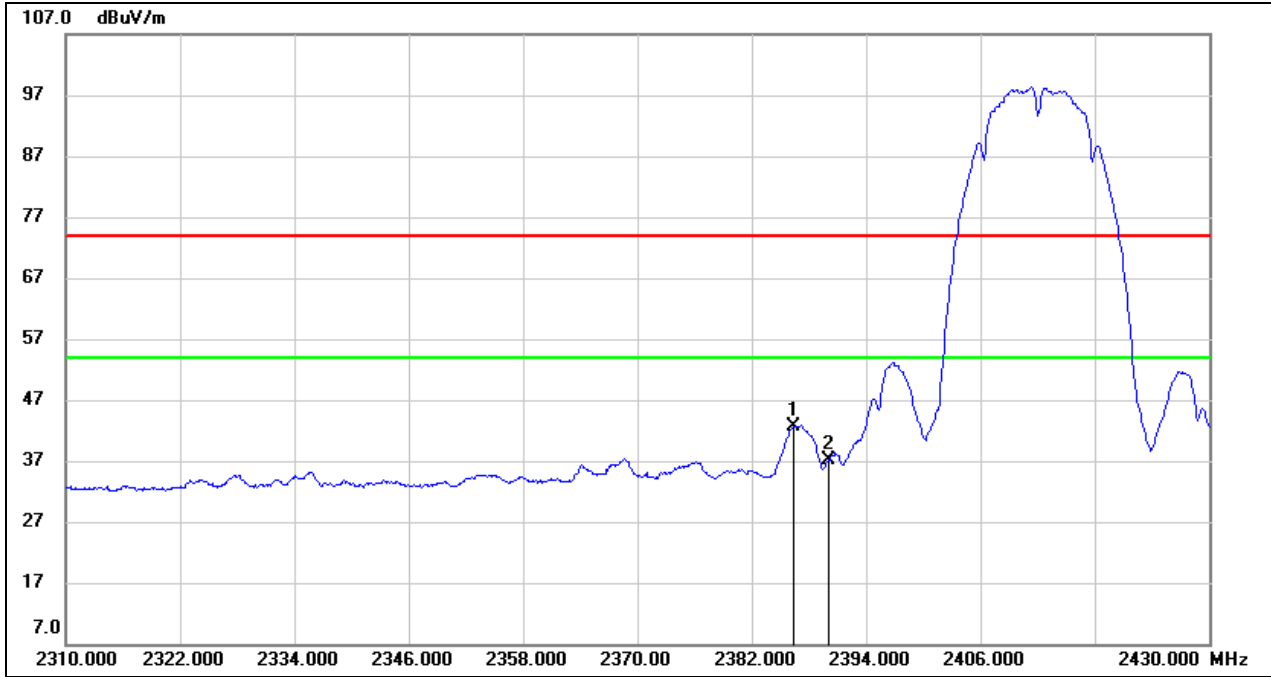

No.	Frequency (MHz)	Reading (dBuV)	Correct (dB/m)	Result (dBuV/m)	Limit (dBuV/m)	Margin (dB)	Remark
1	2386.320	10.38	32.14	42.52	54.00	-11.48	AVG
2	2390.000	5.00	32.16	37.16	54.00	-16.84	AVG



Test Mode:	802.11b PK	Channel:	2462
Polarity:	Horizontal		

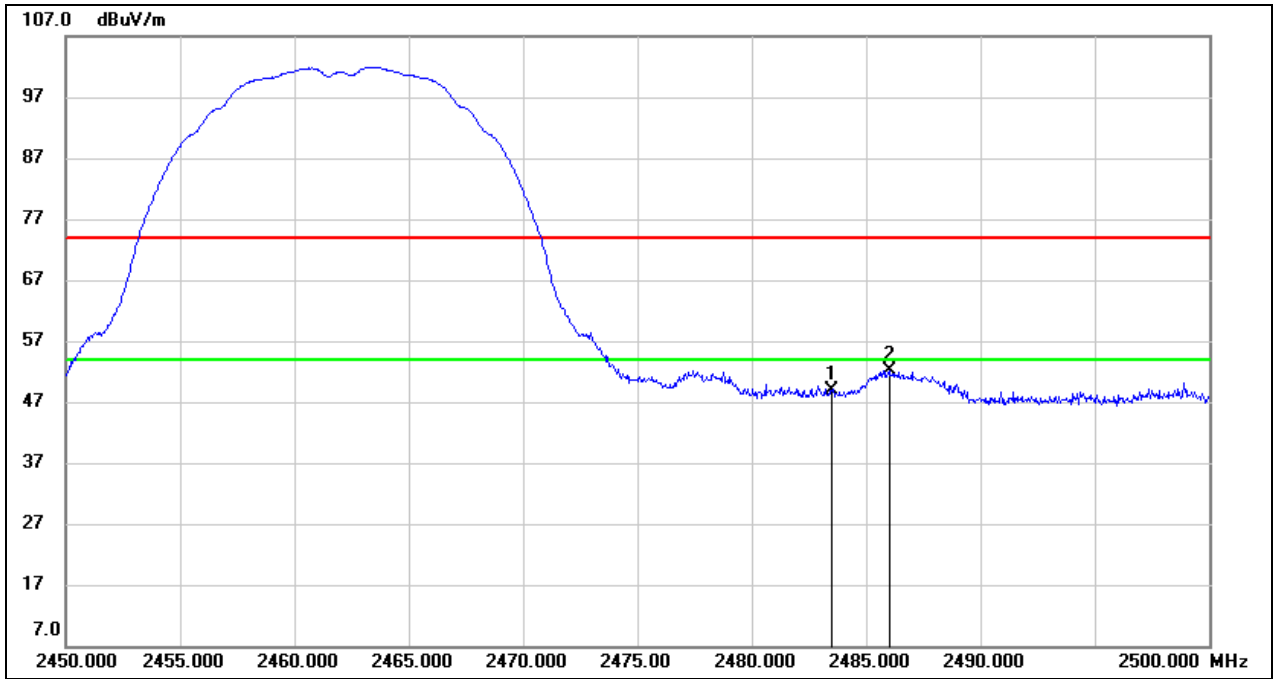

No.	Frequency (MHz)	Reading (dBuV)	Correct (dB/m)	Result (dBuV/m)	Limit (dBuV/m)	Margin (dB)	Remark
1	2483.500	16.33	32.44	48.77	74.00	-25.23	peak
2	2486.000	19.77	32.44	52.21	74.00	-21.79	peak



Test Mode:	802.11b AV	Channel:	2462
Polarity:	Horizontal		

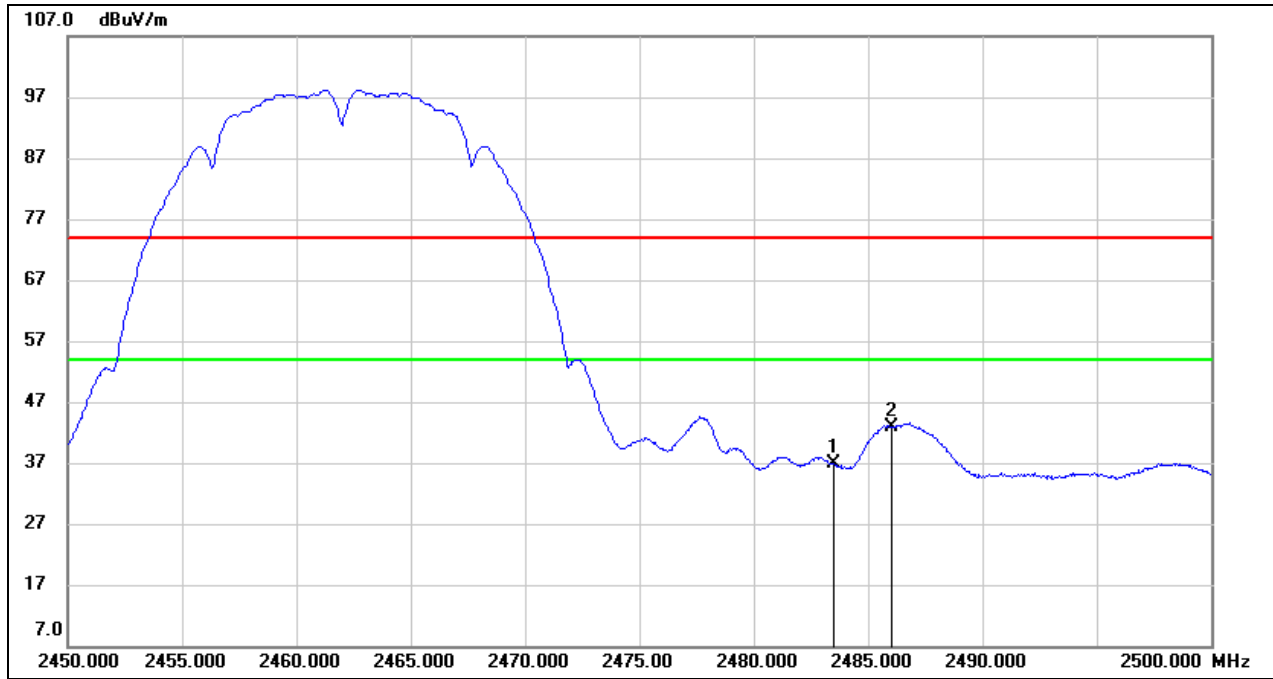

No.	Frequency (MHz)	Reading (dBuV)	Correct (dB/m)	Result (dBuV/m)	Limit (dBuV/m)	Margin (dB)	Remark
1	2483.500	4.38	32.44	36.82	54.00	-17.18	AVG
2	2486.000	10.40	32.44	42.84	54.00	-11.16	AVG



Test Mode:	802.11g PK	Channel:	2412
Polarity:	Horizontal		

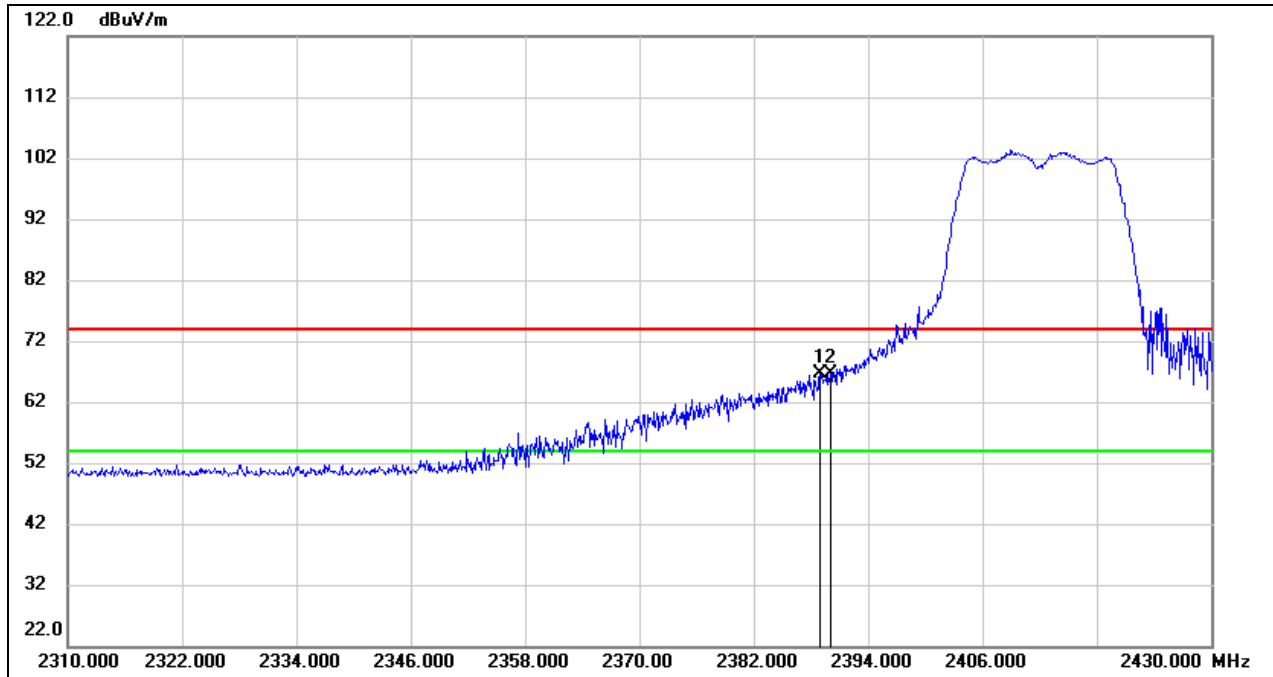

No.	Frequency (MHz)	Reading (dBuV)	Correct (dB/m)	Result (dBuV/m)	Limit (dBuV/m)	Margin (dB)	Remark
1	2388.960	34.57	32.16	66.73	74.00	-7.27	peak
2	2390.000	34.56	32.16	66.72	74.00	-7.28	peak



Test Mode:	802.11g AV	Channel:	2412
Polarity:	Horizontal		

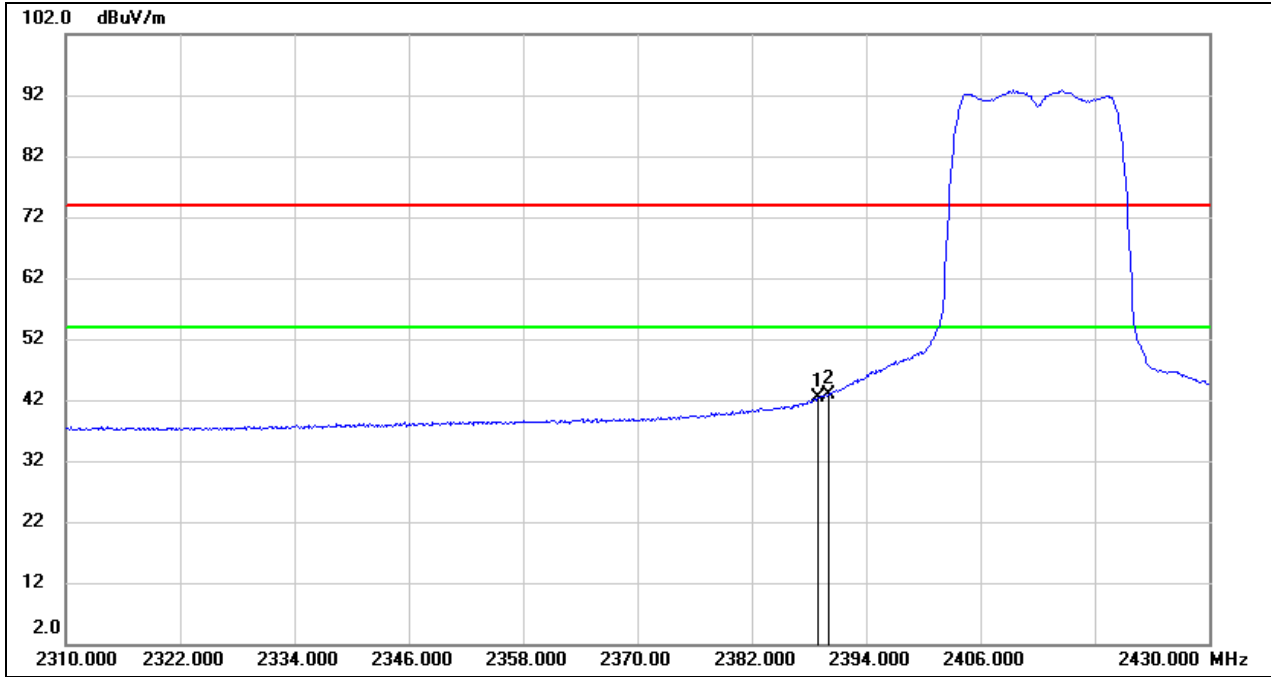

No.	Frequency (MHz)	Reading (dBuV)	Correct (dB/m)	Result (dBuV/m)	Limit (dBuV/m)	Margin (dB)	Remark
1	2388.960	10.10	32.16	42.26	54.00	-11.74	AVG
2	2390.000	10.72	32.16	42.88	54.00	-11.12	AVG



Test Mode:	802.11g PK	Channel:	2462
Polarity:	Horizontal		

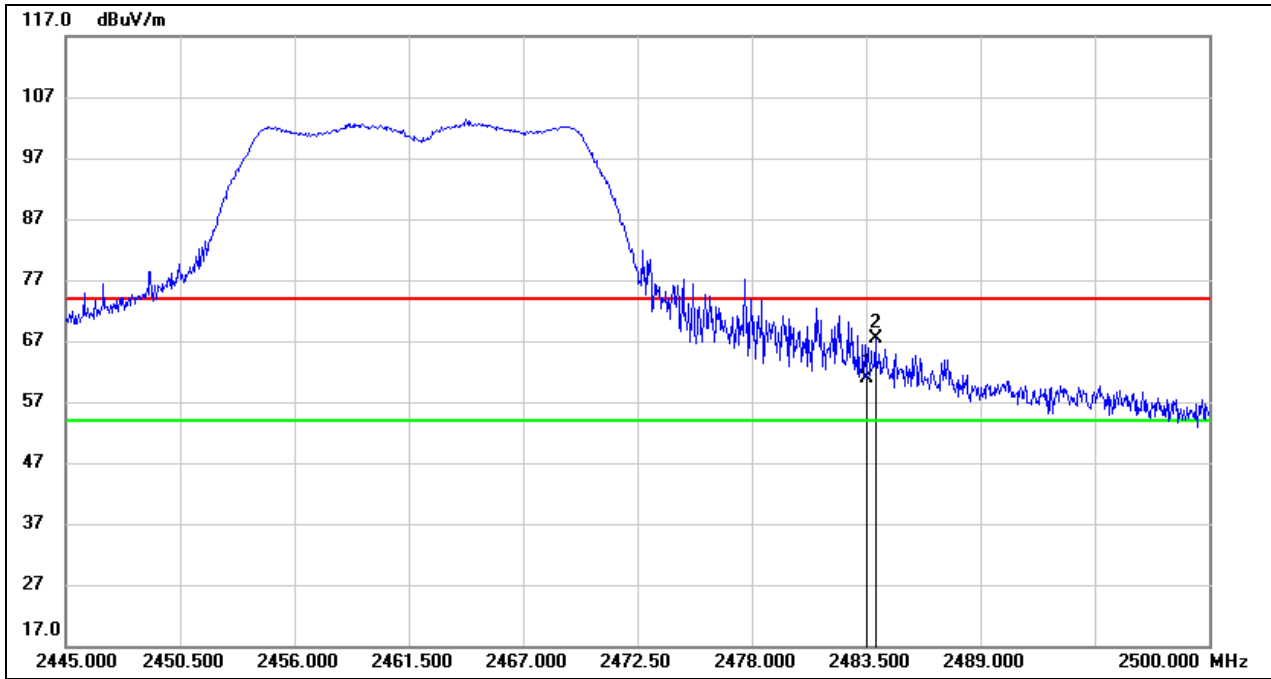

No.	Frequency (MHz)	Reading (dBuV)	Correct (dB/m)	Result (dBuV/m)	Limit (dBuV/m)	Margin (dB)	Remark
1	2483.500	28.48	32.44	60.92	74.00	-13.08	peak
2	2483.940	34.97	32.44	67.41	74.00	-6.59	peak



Test Mode:	802.11g AV	Channel:	2462
Polarity:	Horizontal		

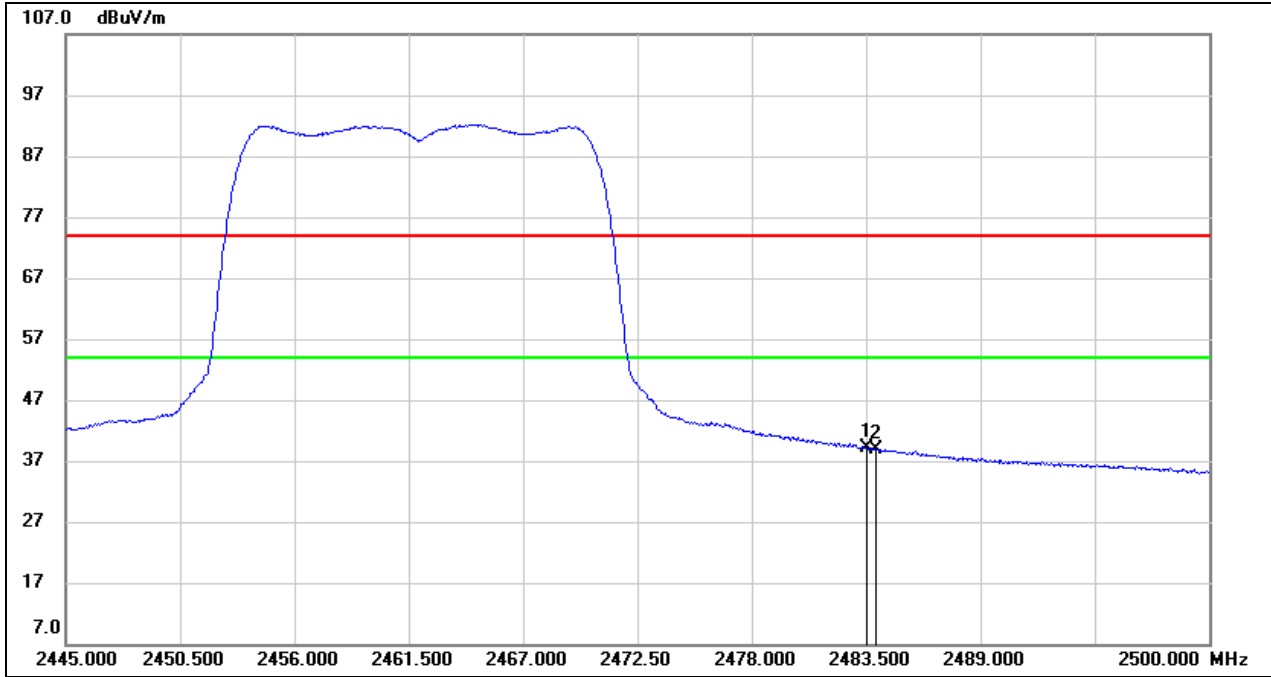

No.	Frequency (MHz)	Reading (dBuV)	Correct (dB/m)	Result (dBuV/m)	Limit (dBuV/m)	Margin (dB)	Remark
1	2483.500	6.69	32.44	39.13	54.00	-14.87	AVG
2	2483.940	6.34	32.44	38.78	54.00	-15.22	AVG



Test Mode:	802.11n HT20 PK	Channel:	2412
Polarity:	Horizontal		

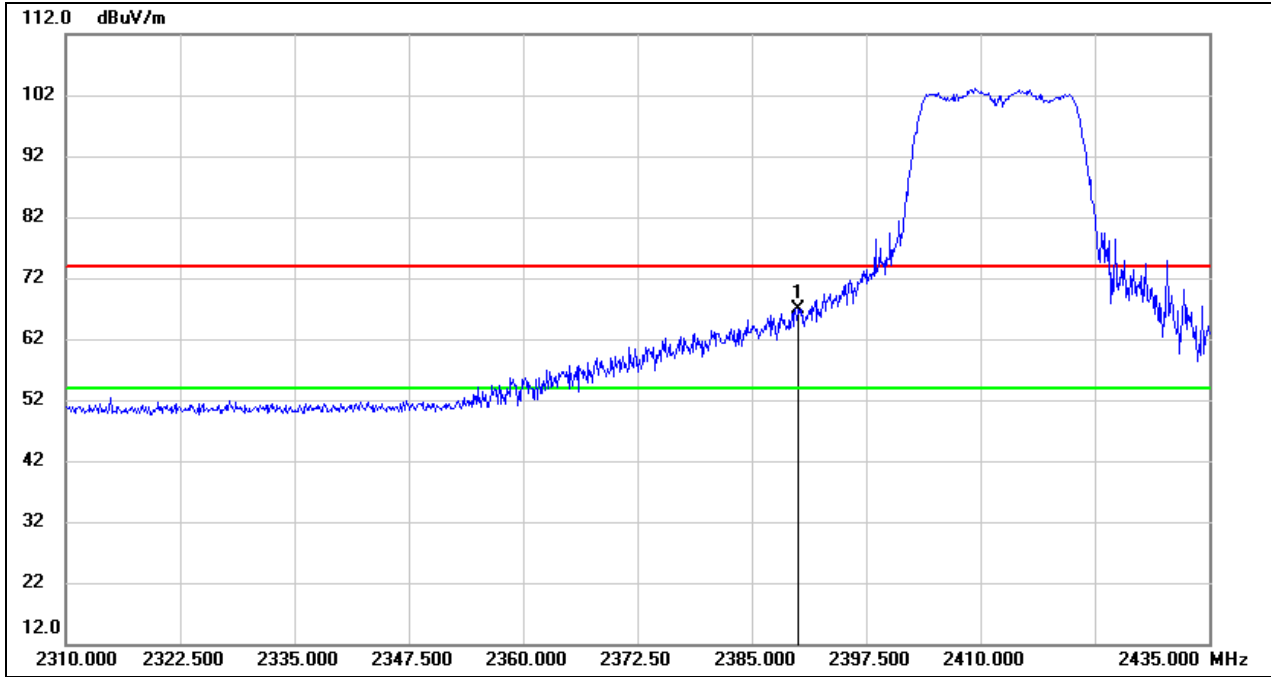

No.	Frequency (MHz)	Reading (dBuV)	Correct (dB/m)	Result (dBuV/m)	Limit (dBuV/m)	Margin (dB)	Remark
1	2390.000	34.72	32.16	66.88	74.00	-7.12	peak



Test Mode:	802.11n HT20 AV	Channel:	2412
Polarity:	Horizontal		

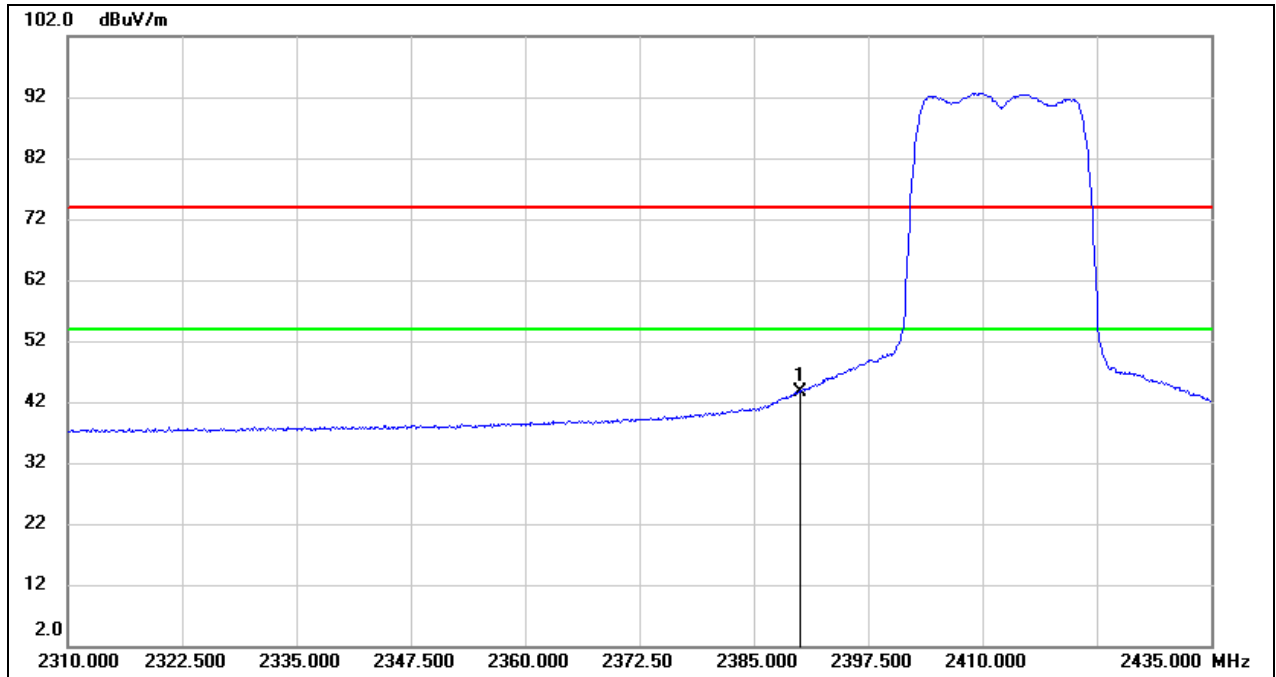

No.	Frequency (MHz)	Reading (dBuV)	Correct (dB/m)	Result (dBuV/m)	Limit (dBuV/m)	Margin (dB)	Remark
1	2390.000	11.47	32.16	43.63	54.00	-10.37	AVG



Test Mode:	802.11n HT20 PK	Channel:	2462
Polarity:	Horizontal		

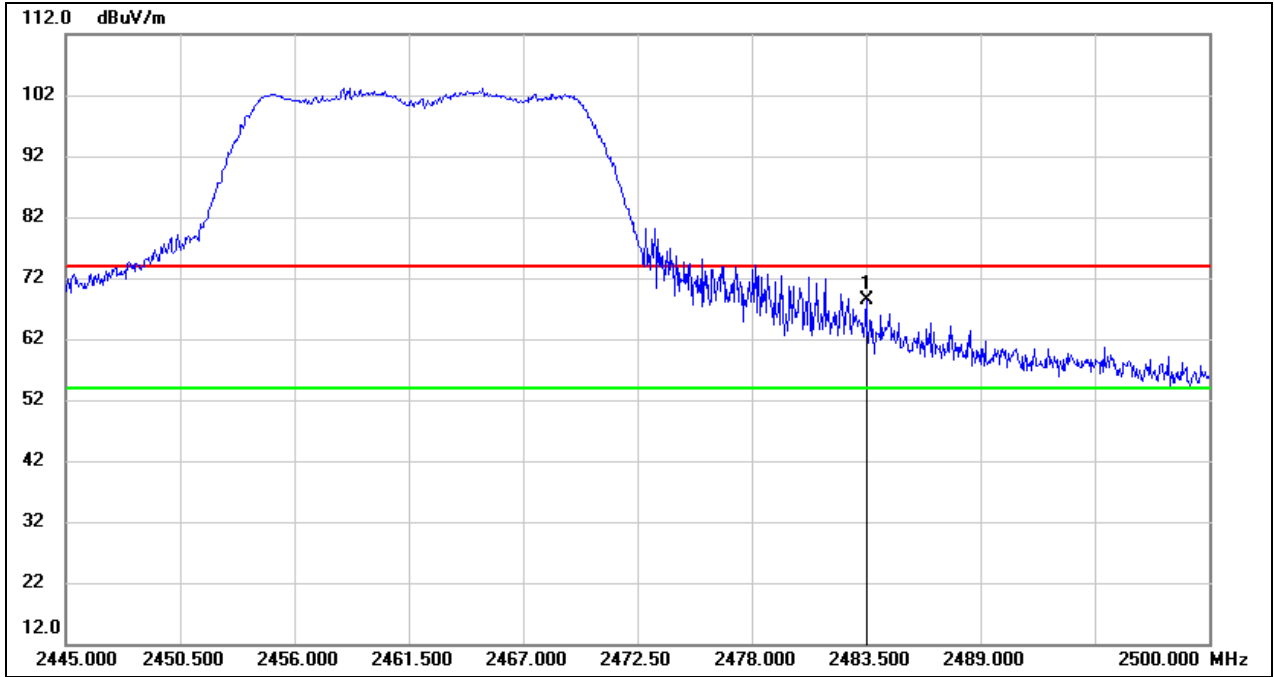

No.	Frequency (MHz)	Reading (dBuV)	Correct (dB/m)	Result (dBuV/m)	Limit (dBuV/m)	Margin (dB)	Remark
1	2483.500	35.95	32.44	68.39	74.00	-5.61	peak



Test Mode:	802.11n HT20 PK	Channel:	2462
Polarity:	Horizontal		

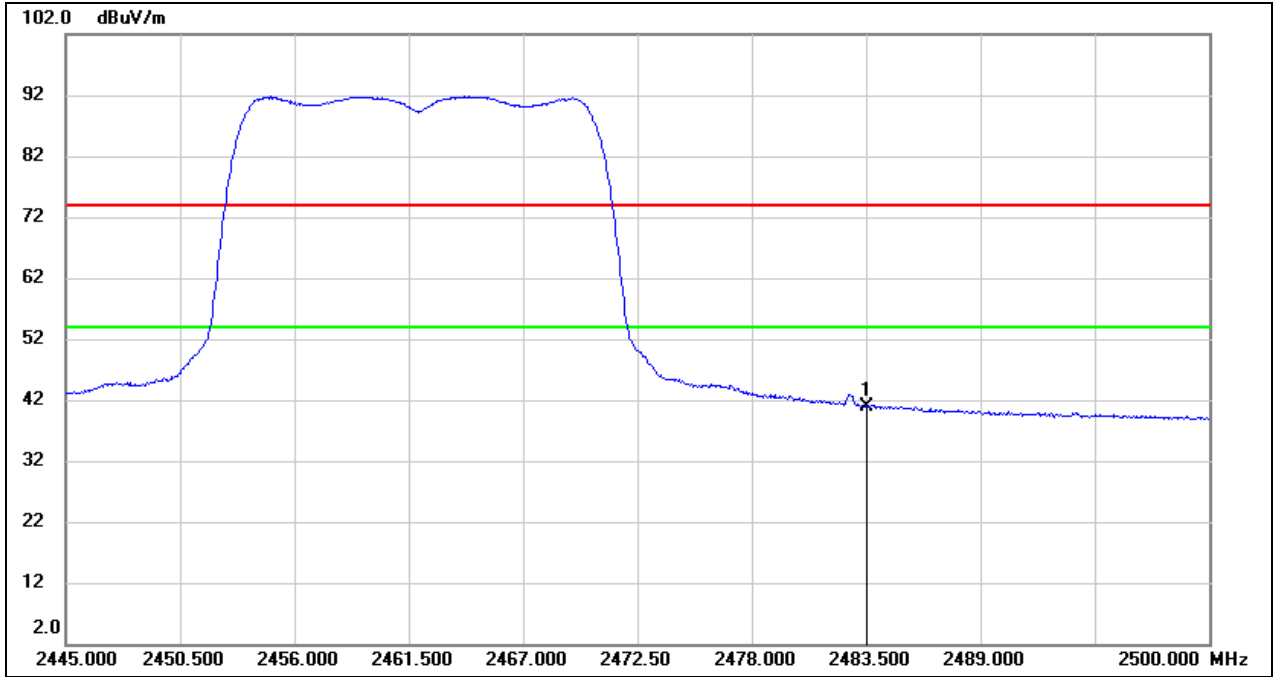

No.	Frequency (MHz)	Reading (dBuV)	Correct (dB/m)	Result (dBuV/m)	Limit (dBuV/m)	Margin (dB)	Remark
1	2483.500	8.52	32.44	40.96	54.00	-13.04	AVG



8.2. RESTRICTED BANDEDGE WITH CHARGING WORST CASE

Test Mode:	802.11n HT20 PK	Channel:	2412
Polarity:	Horizontal	Charger:	PMPN4284A

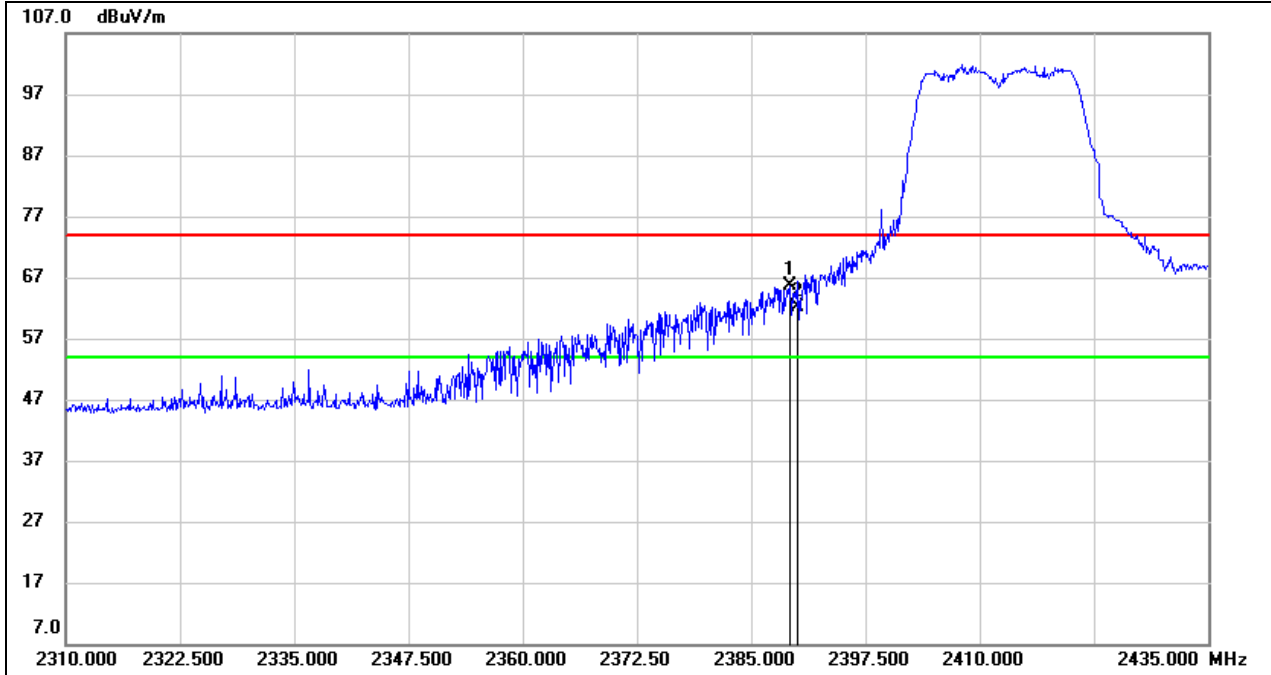

No.	Frequency (MHz)	Reading (dBuV)	Correct (dB/m)	Result (dBuV/m)	Limit (dBuV/m)	Margin (dB)	Remark
1	2389.250	33.53	32.16	65.69	74.00	-8.31	peak
2	2390.000	29.87	32.16	62.03	74.00	-11.97	peak



Test Mode:	802.11n HT20 AV	Channel:	2412
Polarity:	Horizontal	Charger:	PMPN4284A

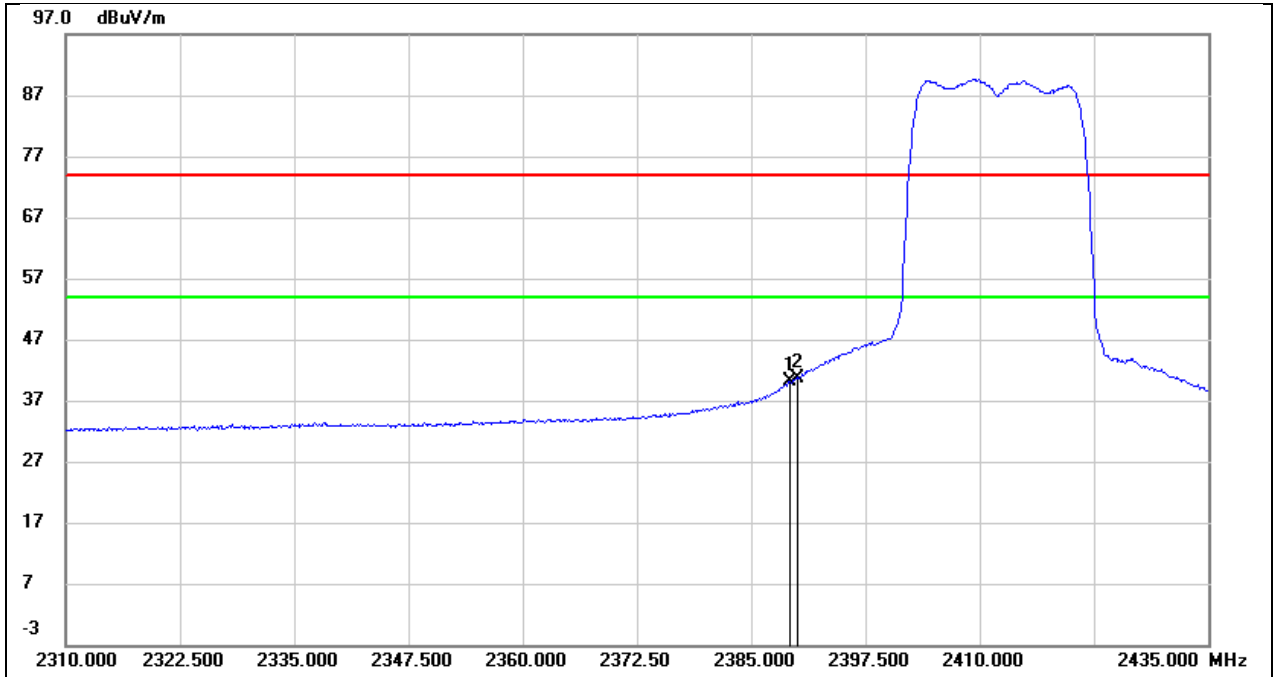

No.	Frequency (MHz)	Reading (dBuV)	Correct (dB/m)	Result (dBuV/m)	Limit (dBuV/m)	Margin (dB)	Remark
1	2389.250	7.98	32.16	40.14	54.00	-13.86	AVG
2	2390.000	8.41	32.16	40.57	54.00	-13.43	AVG



8.3. SPURIOUS EMISSIONS(1 GHZ~3 GHZ)

Test Mode:	802.11b	Channel:	2412
Polarity:	Horizontal		

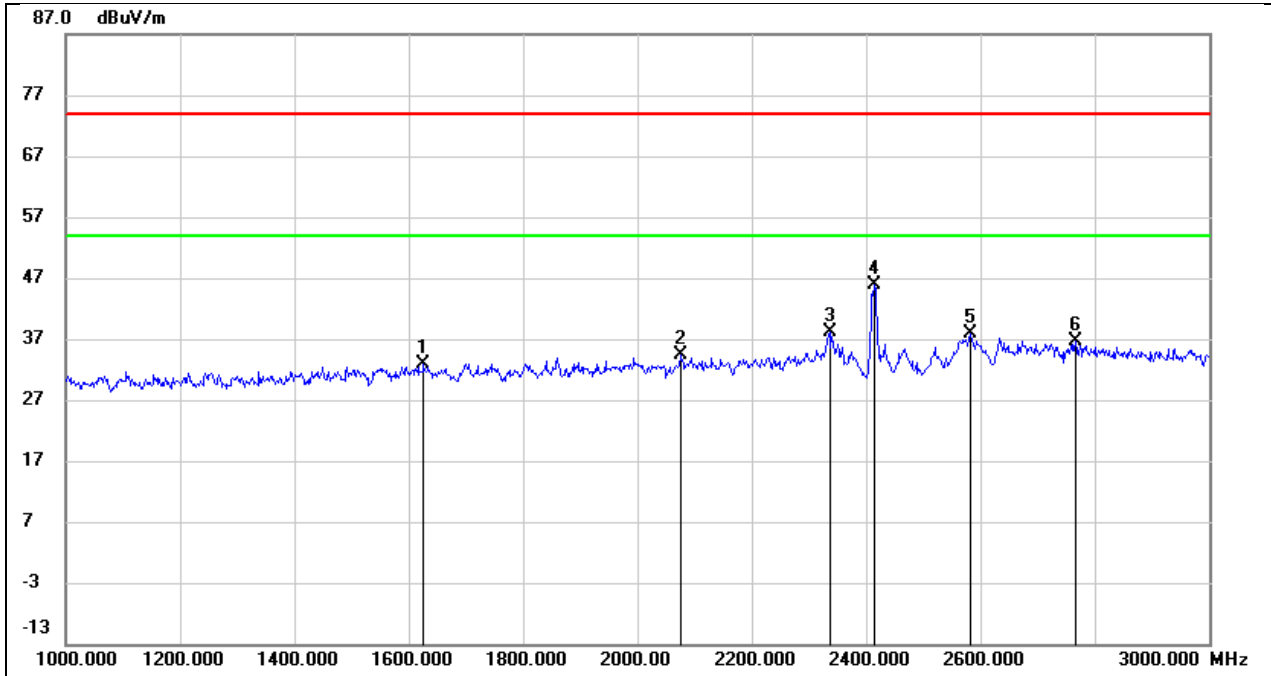

No.	Frequency (MHz)	Reading (dBuV)	Correct (dB/m)	Result (dBuV/m)	Limit (dBuV/m)	Margin (dB)	Remark
1	1626.000	45.17	-12.30	32.87	74.00	-41.13	peak
2	2076.000	45.00	-10.67	34.33	74.00	-39.67	peak
3	2336.000	47.56	-9.33	38.23	74.00	-35.77	peak
4	2414.000	54.71	-8.93	45.78	74.00	-28.22	peak
5	2582.000	46.15	-8.24	37.91	74.00	-36.09	peak
6	2766.000	44.32	-7.68	36.64	74.00	-37.36	peak



Test Mode:	802.11b	Channel:	2412
Polarity:	Vertical		

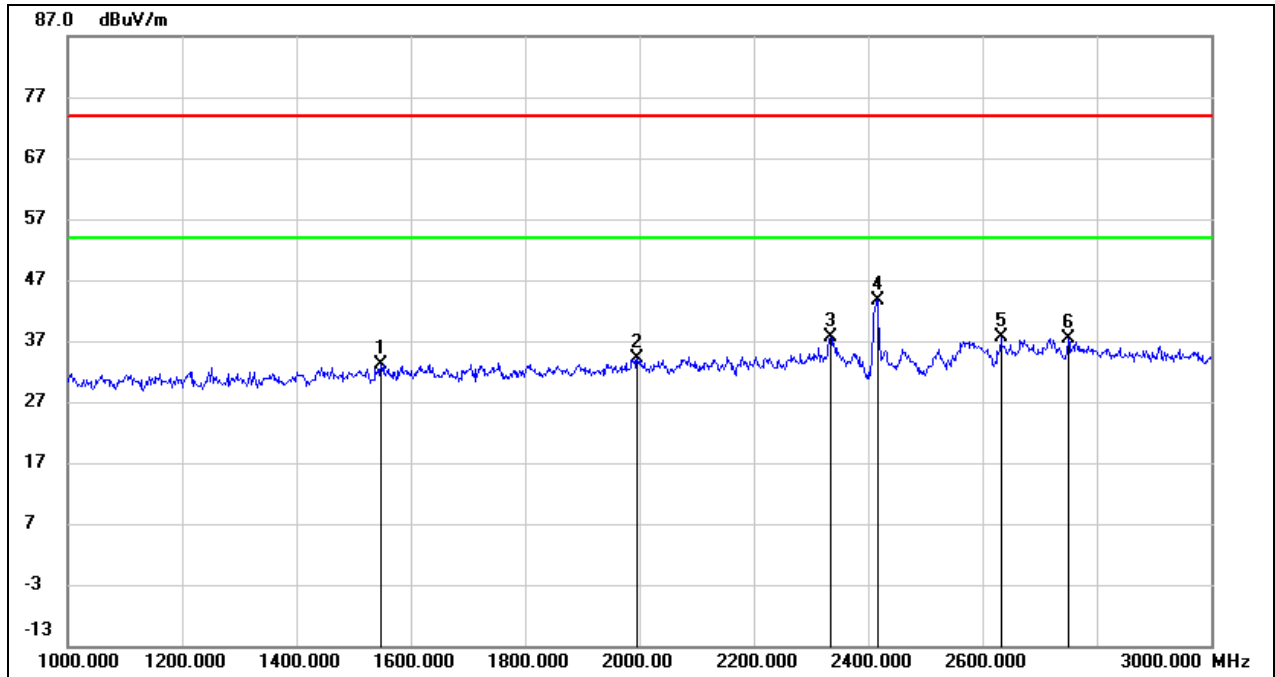

No.	Frequency (MHz)	Reading (dBuV)	Correct (dB/m)	Result (dBuV/m)	Limit (dBuV/m)	Margin (dB)	Remark
1	1548.000	45.75	-12.55	33.20	74.00	-40.80	peak
2	1996.000	45.16	-11.07	34.09	74.00	-39.91	peak
3	2334.000	47.03	-9.35	37.68	74.00	-36.32	peak
4	2416.000	52.65	-8.92	43.73	74.00	-30.27	peak
5	2632.000	45.79	-8.09	37.70	74.00	-36.30	peak
6	2750.000	45.22	-7.73	37.49	74.00	-36.51	peak



Test Mode:	802.11b	Channel:	2437
Polarity:	Horizontal		

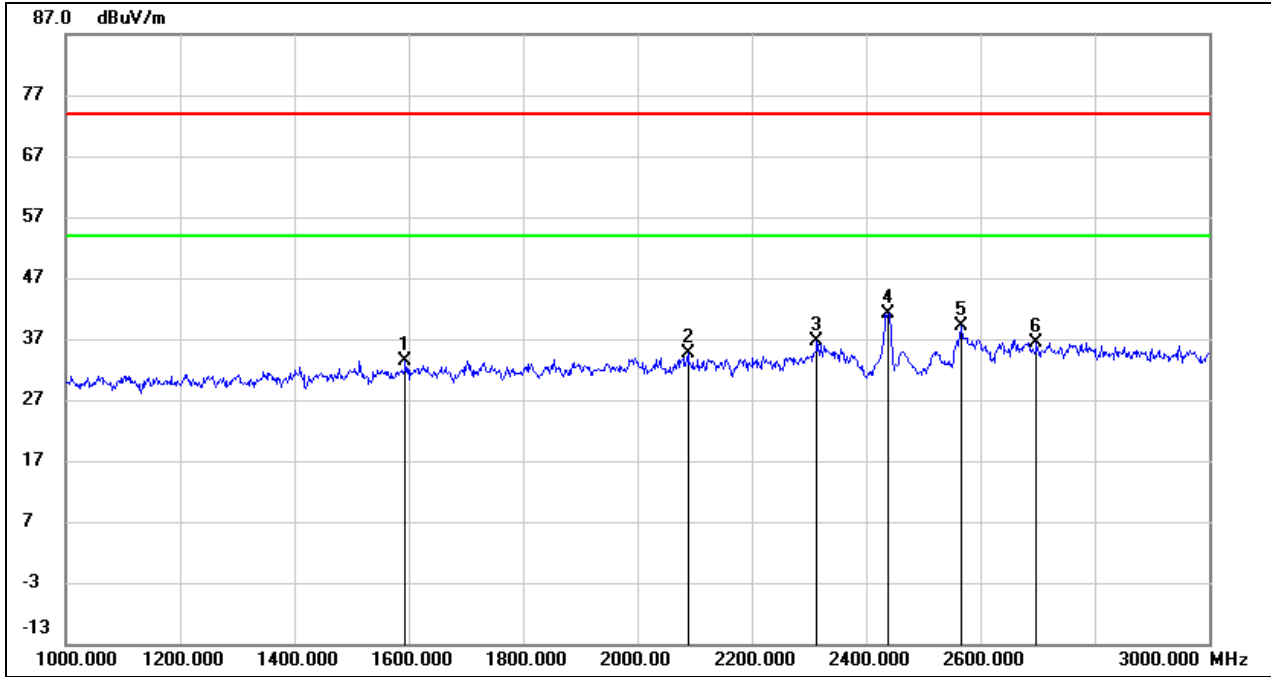

No.	Frequency (MHz)	Reading (dBuV)	Correct (dB/m)	Result (dBuV/m)	Limit (dBuV/m)	Margin (dB)	Remark
1	1594.000	45.76	-12.40	33.36	74.00	-40.64	peak
2	2088.000	45.16	-10.61	34.55	74.00	-39.45	peak
3	2314.000	45.99	-9.44	36.55	74.00	-37.45	peak
4	2438.000	50.00	-8.80	41.20	74.00	-32.80	peak
5	2566.000	47.43	-8.29	39.14	74.00	-34.86	peak
6	2698.000	44.32	-7.89	36.43	74.00	-37.57	peak



Test Mode:	802.11b	Channel:	2437
Polarity:	Vertical		

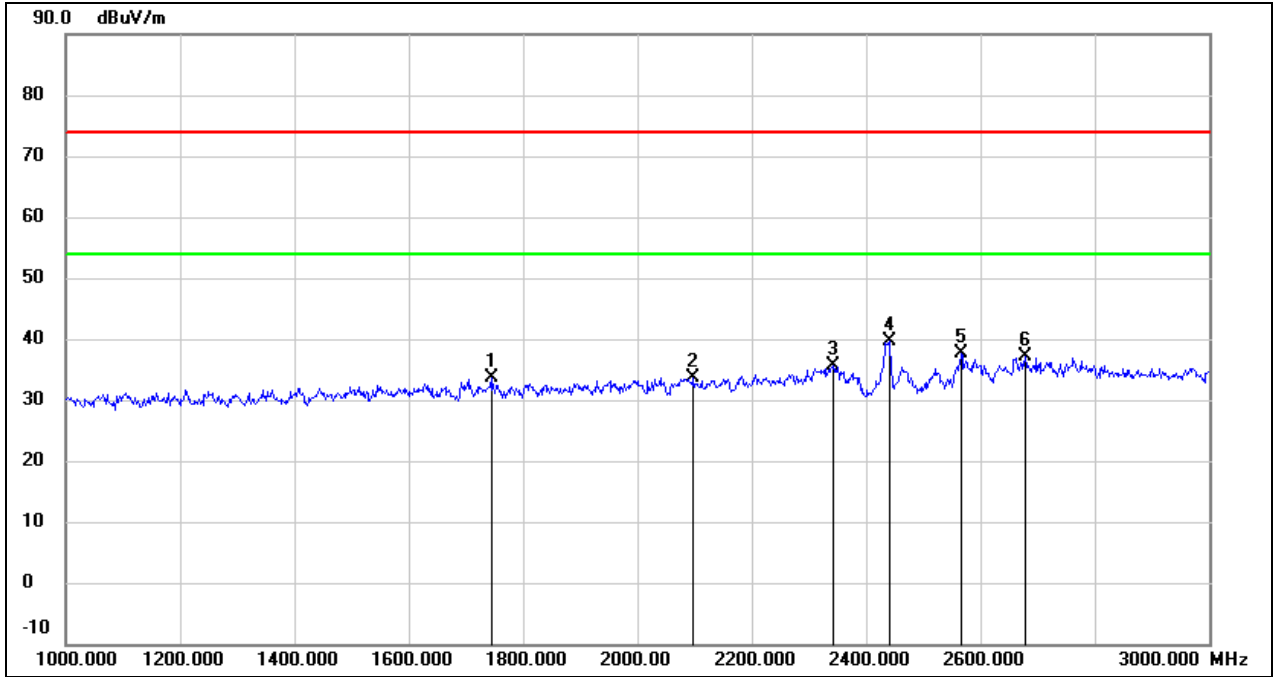

No.	Frequency (MHz)	Reading (dBuV)	Correct (dB/m)	Result (dBuV/m)	Limit (dBuV/m)	Margin (dB)	Remark
1	1744.000	45.62	-11.90	33.72	74.00	-40.28	peak
2	2098.000	44.14	-10.56	33.58	74.00	-40.42	peak
3	2342.000	44.85	-9.30	35.55	74.00	-38.45	peak
4	2440.000	48.53	-8.80	39.73	74.00	-34.27	peak
5	2566.000	45.97	-8.29	37.68	74.00	-36.32	peak
6	2678.000	45.11	-7.96	37.15	74.00	-36.85	peak



Test Mode:	802.11b	Channel:	2462
Polarity:	Horizontal		

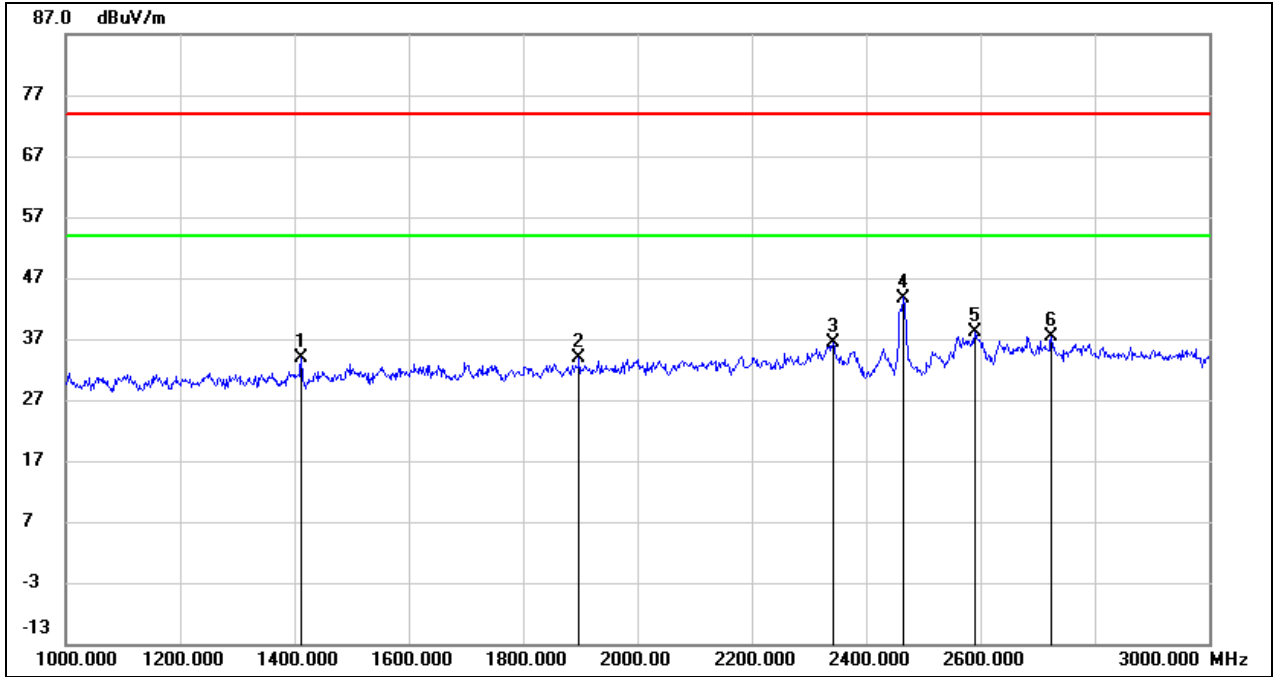

No.	Frequency (MHz)	Reading (dBuV)	Correct (dB/m)	Result (dBuV/m)	Limit (dBuV/m)	Margin (dB)	Remark
1	1412.000	46.91	-13.12	33.79	74.00	-40.21	peak
2	1898.000	45.25	-11.39	33.86	74.00	-40.14	peak
3	2342.000	45.64	-9.30	36.34	74.00	-37.66	peak
4	2464.000	52.43	-8.68	43.75	74.00	-30.25	peak
5	2590.000	46.28	-8.22	38.06	74.00	-35.94	peak
6	2724.000	45.18	-7.81	37.37	74.00	-36.63	peak



Test Mode:	802.11b	Channel:	2462
Polarity:	Vertical		

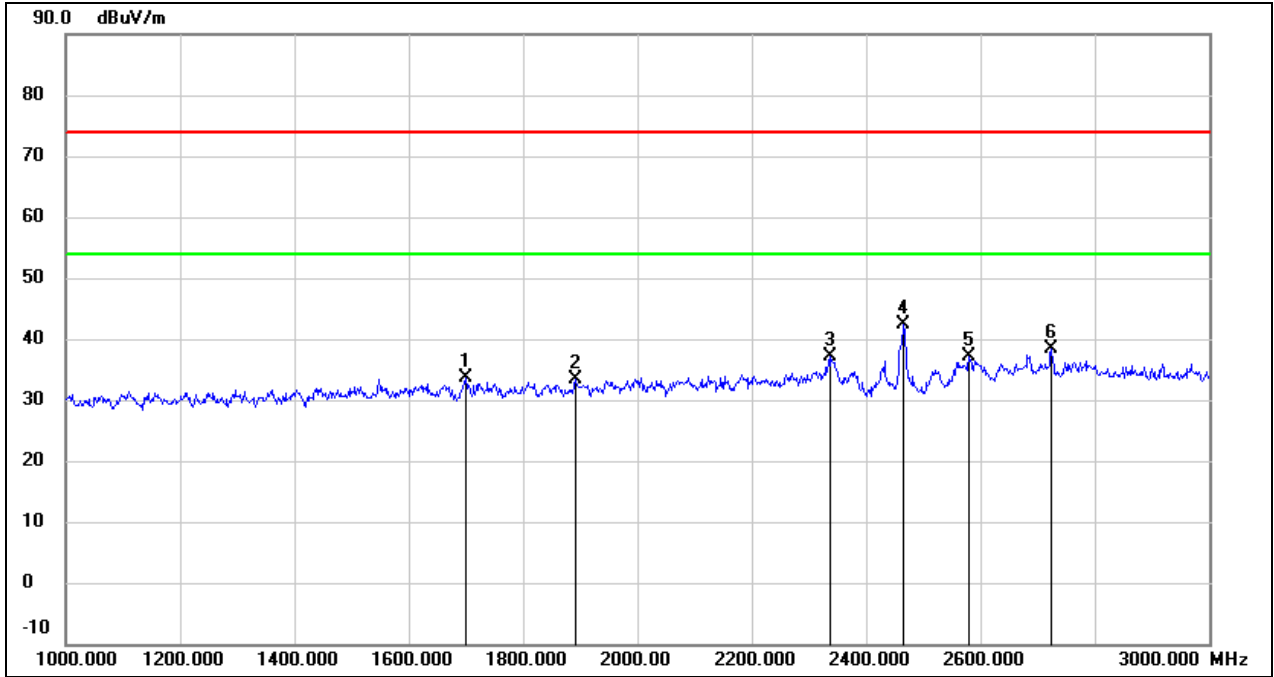

No.	Frequency (MHz)	Reading (dBuV)	Correct (dB/m)	Result (dBuV/m)	Limit (dBuV/m)	Margin (dB)	Remark
1	1700.000	45.74	-12.05	33.69	74.00	-40.31	peak
2	1892.000	44.92	-11.42	33.50	74.00	-40.50	peak
3	2336.000	46.51	-9.33	37.18	74.00	-36.82	peak
4	2466.000	51.00	-8.66	42.34	74.00	-31.66	peak
5	2580.000	45.36	-8.25	37.11	74.00	-36.89	peak
6	2724.000	46.09	-7.81	38.28	74.00	-35.72	peak



8.4. SPURIOUS EMISSIONS WITH CHARGING WORST CASE(1 GHZ~3 GHZ)

Test Mode:	802.11n HT20	Channel:	2412
Polarity:	Horizontal	Charger:	PMPN4284A

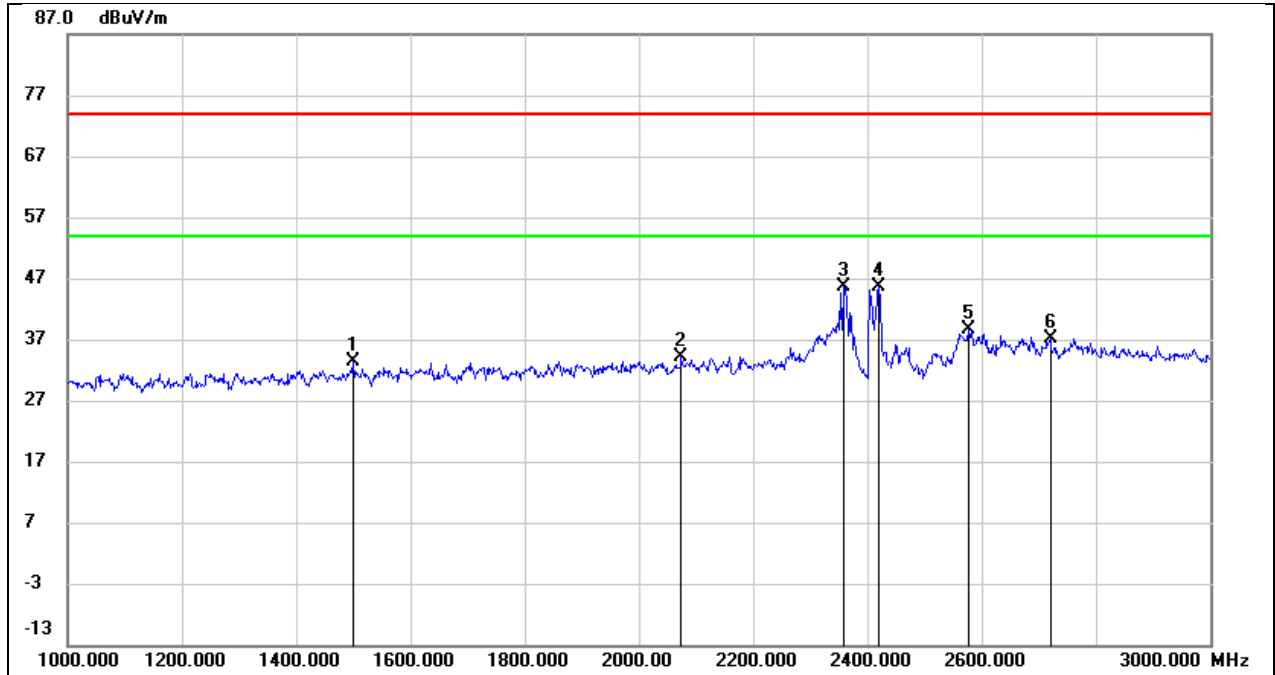

No.	Frequency (MHz)	Reading (dBuV)	Correct (dB/m)	Result (dBuV/m)	Limit (dBuV/m)	Margin (dB)	Remark
1	1500.000	46.20	-12.71	33.49	74.00	-40.51	peak
2	2074.000	44.73	-10.68	34.05	74.00	-39.95	peak
3	2358.000	54.74	-9.22	45.52	74.00	-28.48	peak
4	2420.000	54.51	-8.91	45.60	74.00	-28.40	peak
5	2578.000	46.88	-8.26	38.62	74.00	-35.38	peak
6	2720.000	44.92	-7.83	37.09	74.00	-36.91	peak



Test Mode:	802.11n HT20	Channel:	2412
Polarity:	Vertical	Charger:	PMPN4284A

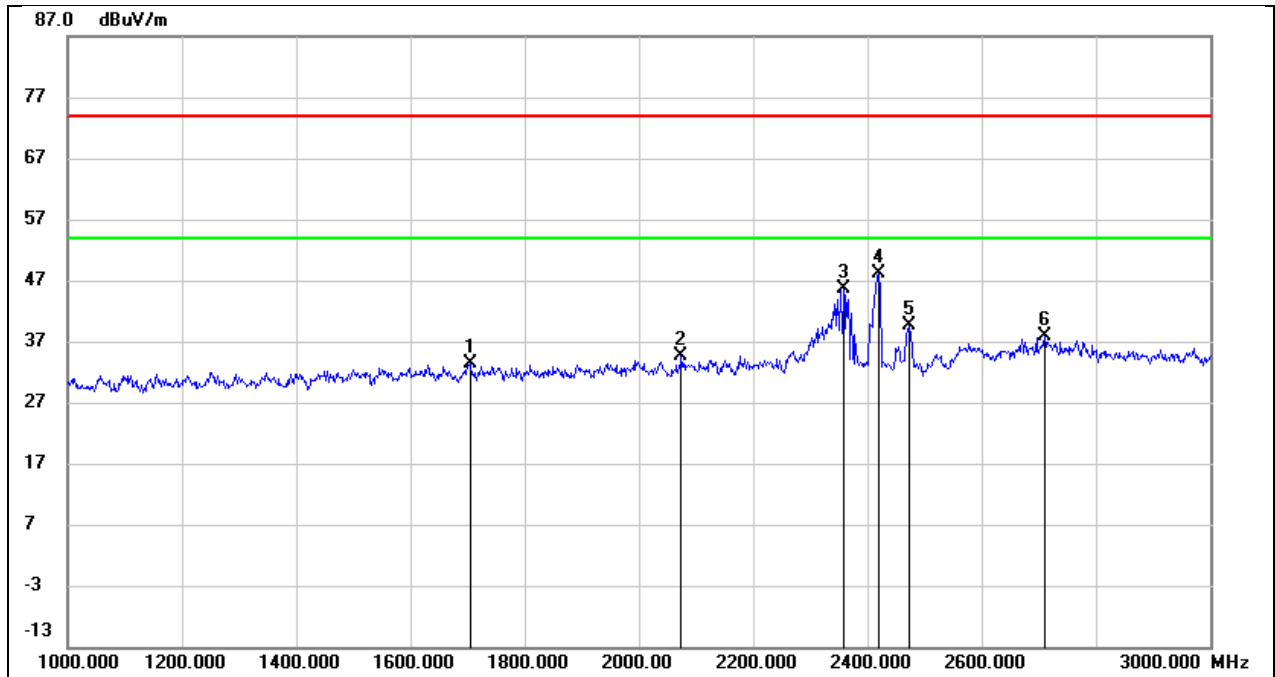

No.	Frequency (MHz)	Reading (dBuV)	Correct (dB/m)	Result (dBuV/m)	Limit (dBuV/m)	Margin (dB)	Remark
1	1704.000	45.38	-12.04	33.34	74.00	-40.66	peak
2	2074.000	45.19	-10.68	34.51	74.00	-39.49	peak
3	2358.000	54.83	-9.22	45.61	74.00	-28.39	peak
4	2420.000	57.07	-8.91	48.16	74.00	-25.84	peak
5	2472.000	48.32	-8.63	39.69	74.00	-34.31	peak
6	2710.000	45.78	-7.85	37.93	74.00	-36.07	peak



8.5. SPURIOUS EMISSIONS(3 GHZ~18 GHZ)

Test Mode:	802.11b	Channel:	2412
Polarity:	Horizontal		

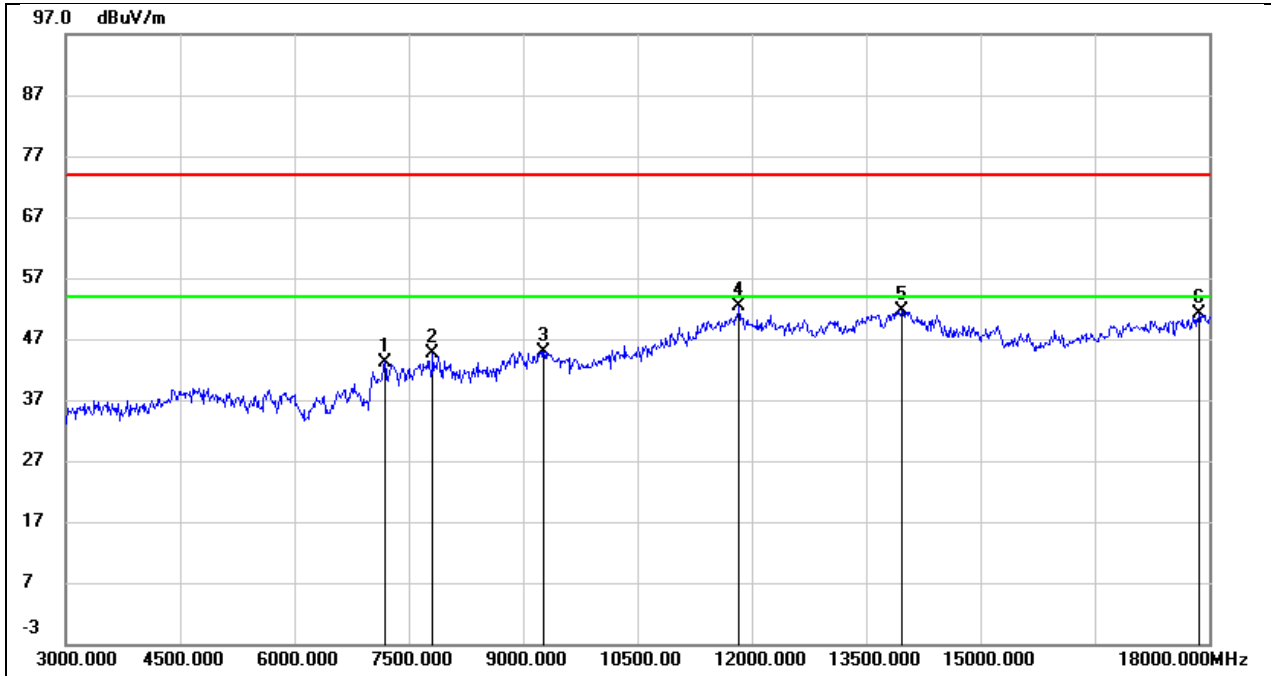

No.	Frequency (MHz)	Reading (dBuV)	Correct (dB/m)	Result (dBuV/m)	Limit (dBuV/m)	Margin (dB)	Remark
1	7185.000	36.70	6.55	43.25	74.00	-30.75	peak
2	7815.000	38.25	6.32	44.57	74.00	-29.43	peak
3	9270.000	34.28	10.59	44.87	74.00	-29.13	peak
4	11835.000	34.87	17.51	52.38	74.00	-21.62	peak
5	13965.000	29.67	21.89	51.56	74.00	-22.44	peak
6	17865.000	26.26	24.89	51.15	74.00	-22.85	peak



Test Mode:	802.11b	Channel:	2412
Polarity:	Vertical		

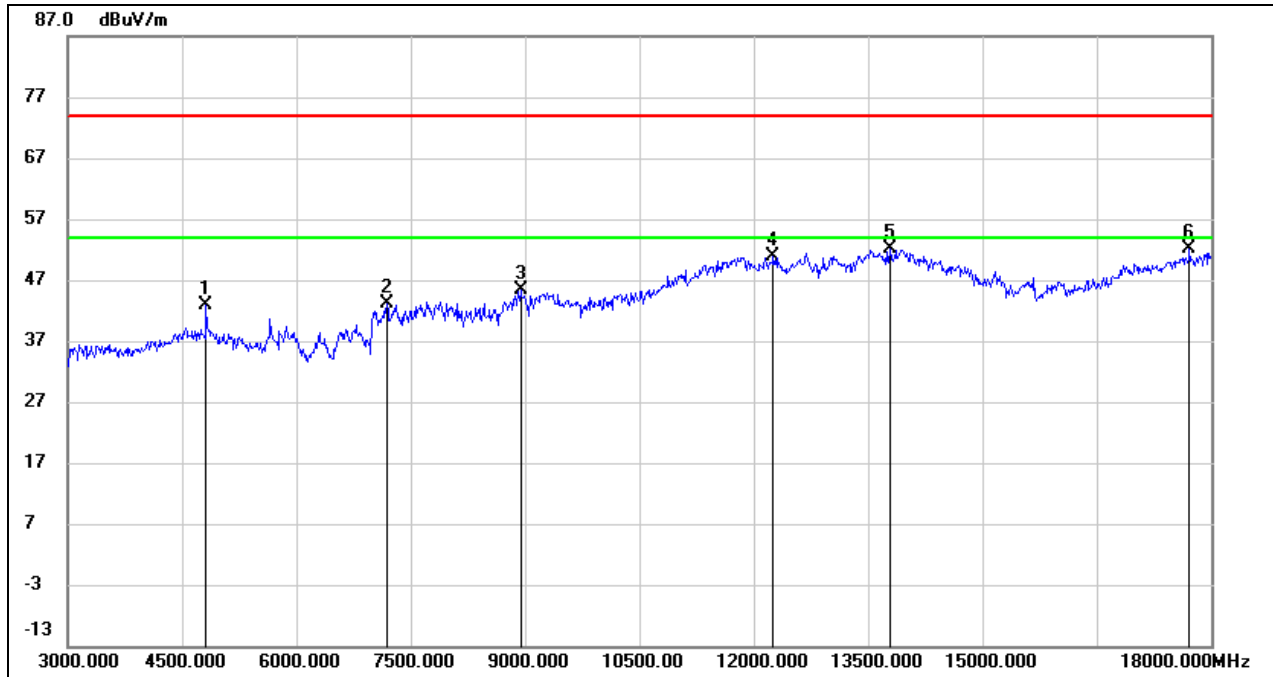

No.	Frequency (MHz)	Reading (dBuV)	Correct (dB/m)	Result (dBuV/m)	Limit (dBuV/m)	Margin (dB)	Remark
1	4815.000	43.12	-0.26	42.86	74.00	-31.14	peak
2	7185.000	36.53	6.55	43.08	74.00	-30.92	peak
3	8940.000	35.31	10.04	45.35	74.00	-28.65	peak
4	12255.000	32.99	17.78	50.77	74.00	-23.23	peak
5	13785.000	30.57	21.51	52.08	74.00	-21.92	peak
6	17715.000	28.08	24.00	52.08	74.00	-21.92	peak



Test Mode:	802.11b	Channel:	2437
Polarity:	Horizontal		

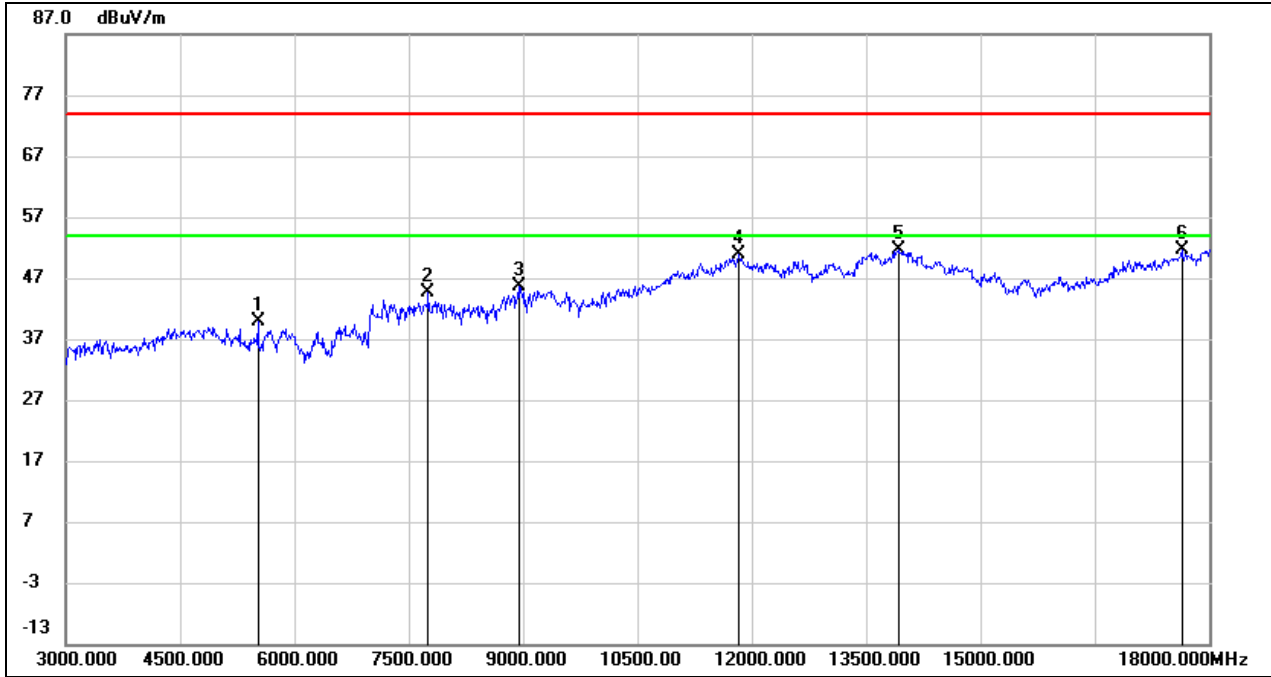

No.	Frequency (MHz)	Reading (dBuV)	Correct (dB/m)	Result (dBuV/m)	Limit (dBuV/m)	Margin (dB)	Remark
1	5520.000	38.99	0.90	39.89	74.00	-34.11	peak
2	7755.000	38.26	6.31	44.57	74.00	-29.43	peak
3	8940.000	35.57	10.04	45.61	74.00	-28.39	peak
4	11835.000	33.35	17.51	50.86	74.00	-23.14	peak
5	13920.000	29.87	21.79	51.66	74.00	-22.34	peak
6	17640.000	28.10	23.56	51.66	74.00	-22.34	peak



Test Mode:	802.11b	Channel:	2437
Polarity:	Vertical		

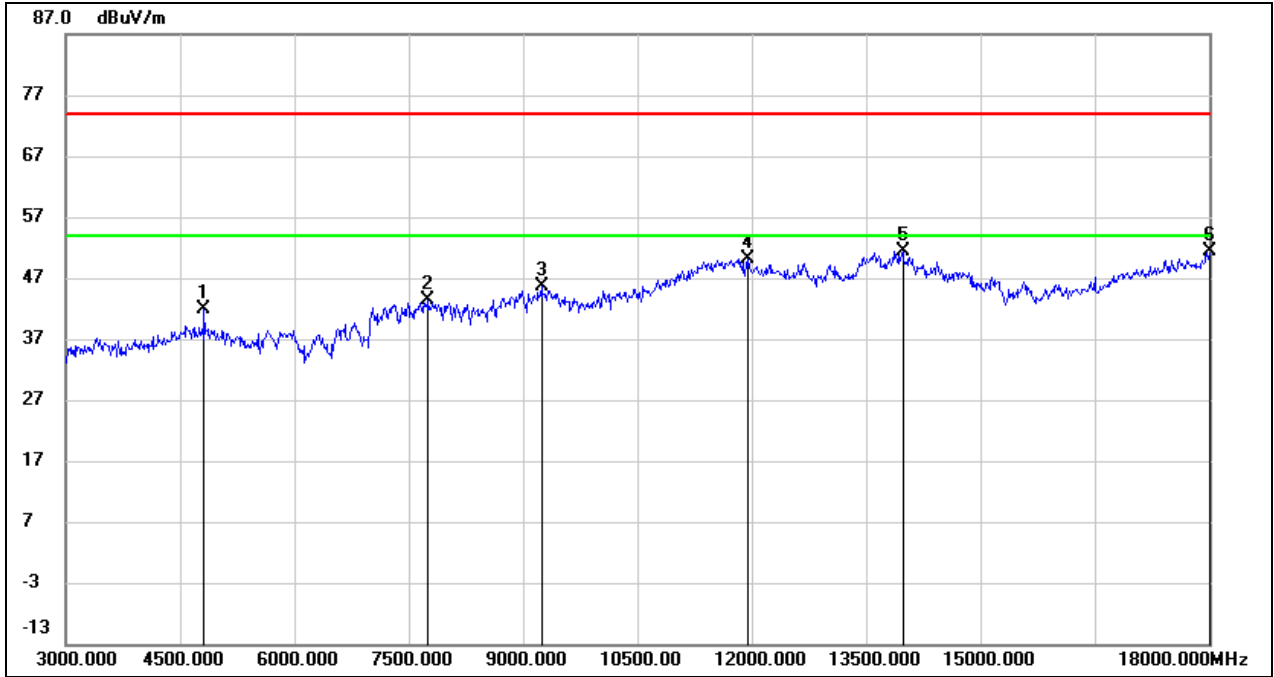

No.	Frequency (MHz)	Reading (dBuV)	Correct (dB/m)	Result (dBuV/m)	Limit (dBuV/m)	Margin (dB)	Remark
1	4815.000	42.21	-0.26	41.95	74.00	-32.05	peak
2	7755.000	36.96	6.31	43.27	74.00	-30.73	peak
3	9240.000	34.99	10.58	45.57	74.00	-28.43	peak
4	11955.000	32.37	17.83	50.20	74.00	-23.80	peak
5	13980.000	29.37	21.92	51.29	74.00	-22.71	peak
6	18000.000	25.61	25.69	51.30	74.00	-22.70	peak



Test Mode:	802.11b	Channel:	2462
Polarity:	Horizontal		

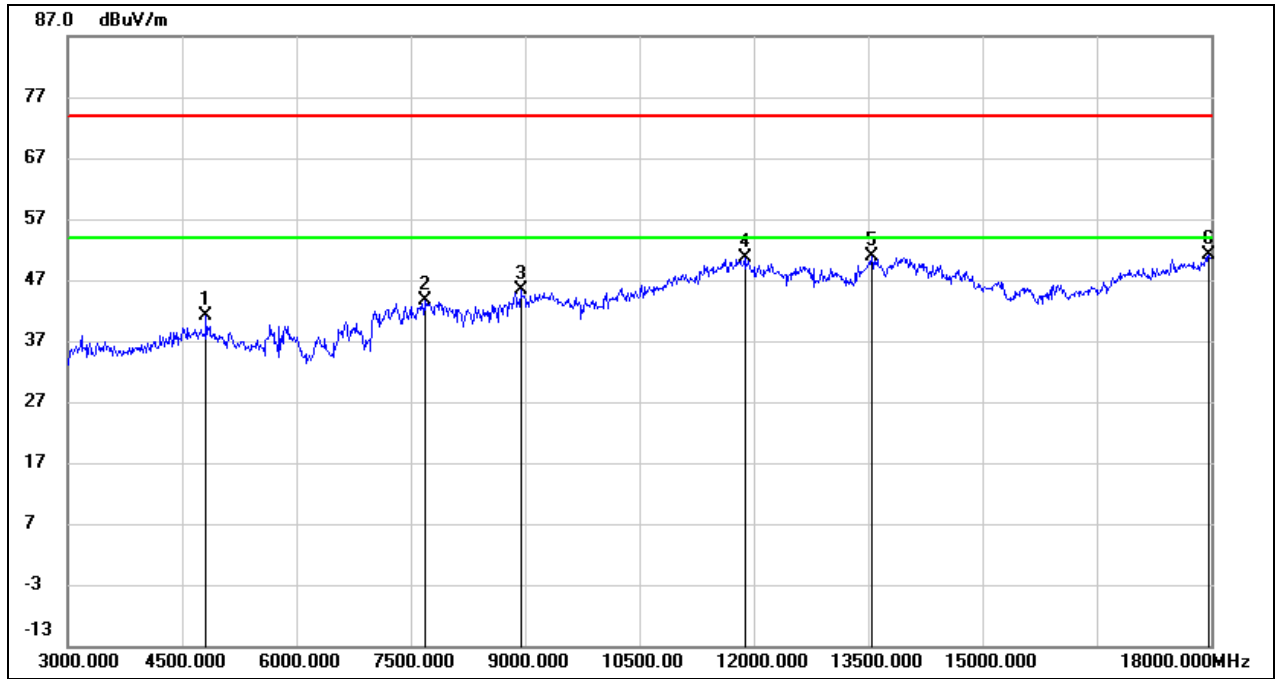

No.	Frequency (MHz)	Reading (dBuV)	Correct (dB/m)	Result (dBuV/m)	Limit (dBuV/m)	Margin (dB)	Remark
1	4815.000	41.45	-0.26	41.19	74.00	-32.81	peak
2	7680.000	37.42	6.32	43.74	74.00	-30.26	peak
3	8940.000	35.24	10.04	45.28	74.00	-28.72	peak
4	11880.000	33.03	17.63	50.66	74.00	-23.34	peak
5	13545.000	29.77	20.99	50.76	74.00	-23.24	peak
6	17970.000	25.51	25.51	51.02	74.00	-22.98	peak



Test Mode:	802.11b	Channel:	2462
Polarity:	Vertical		

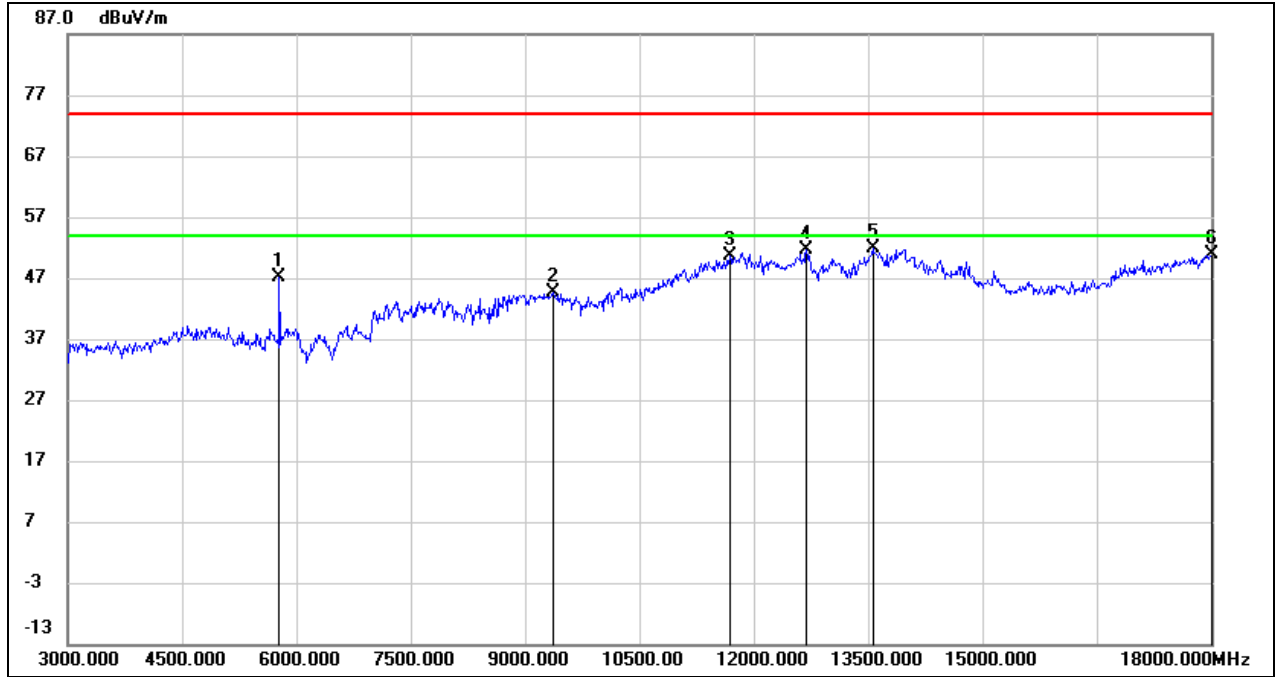

No.	Frequency (MHz)	Reading (dBuV)	Correct (dB/m)	Result (dBuV/m)	Limit (dBuV/m)	Margin (dB)	Remark
1	5775.000	45.62	1.63	47.25	74.00	-26.75	peak
2	9360.000	34.00	10.64	44.64	74.00	-29.36	peak
3	11685.000	33.45	17.10	50.55	74.00	-23.45	peak
4	12690.000	33.73	18.02	51.75	74.00	-22.25	peak
5	13560.000	30.82	21.04	51.86	74.00	-22.14	peak
6	18000.000	25.19	25.69	50.88	74.00	-23.12	peak



Test Mode:	802.11g	Channel:	2412
Polarity:	Horizontal		

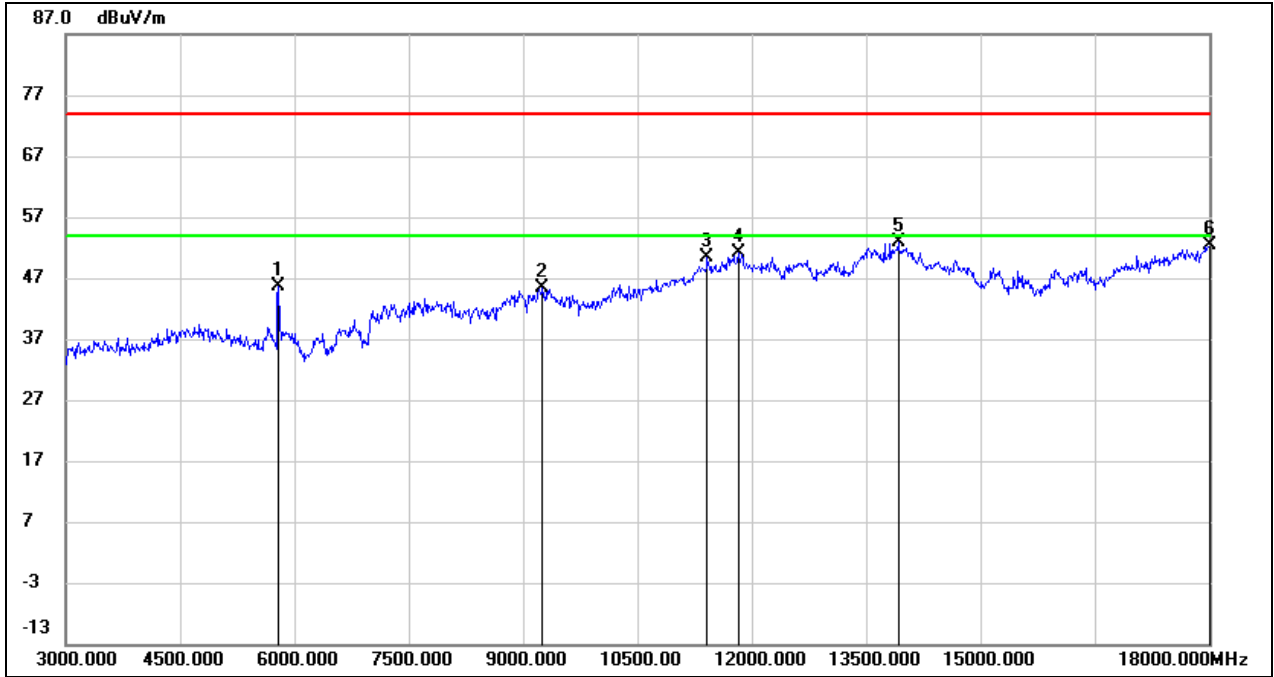

No.	Frequency (MHz)	Reading (dBuV)	Correct (dB/m)	Result (dBuV/m)	Limit (dBuV/m)	Margin (dB)	Remark
1	5790.000	44.09	1.66	45.75	74.00	-28.25	peak
2	9255.000	34.73	10.59	45.32	74.00	-28.68	peak
3	11415.000	33.98	16.29	50.27	74.00	-23.73	peak
4	11820.000	33.66	17.47	51.13	74.00	-22.87	peak
5	13920.000	31.19	21.79	52.98	74.00	-21.02	peak
6	18000.000	26.78	25.69	52.47	74.00	-21.53	peak



Test Mode:	802.11g	Channel:	2412
Polarity:	Vertical		

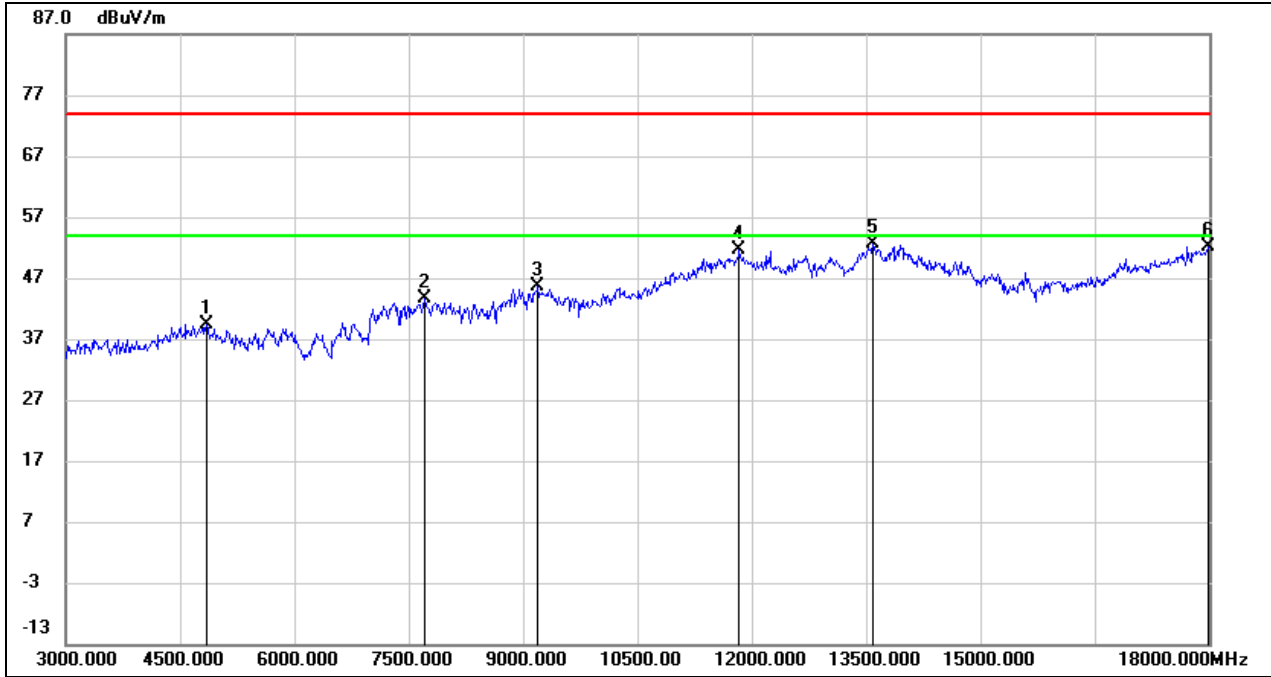

No.	Frequency (MHz)	Reading (dBuV)	Correct (dB/m)	Result (dBuV/m)	Limit (dBuV/m)	Margin (dB)	Remark
1	4845.000	39.41	-0.15	39.26	74.00	-34.74	peak
2	7710.000	37.34	6.33	43.67	74.00	-30.33	peak
3	9195.000	35.01	10.56	45.57	74.00	-28.43	peak
4	11835.000	34.12	17.51	51.63	74.00	-22.37	peak
5	13590.000	31.48	21.09	52.57	74.00	-21.43	peak
6	17985.000	26.53	25.60	52.13	74.00	-21.87	peak



Test Mode:	802.11g	Channel:	2437
Polarity:	Horizontal		

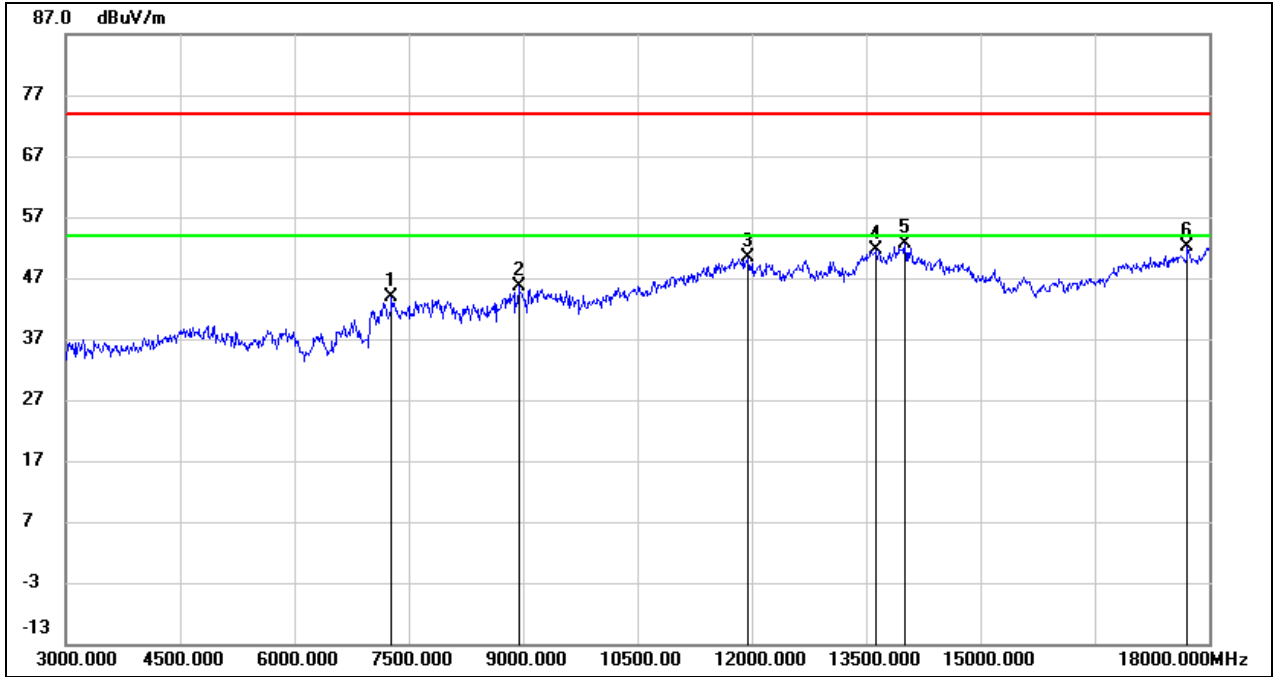

No.	Frequency (MHz)	Reading (dBuV)	Correct (dB/m)	Result (dBuV/m)	Limit (dBuV/m)	Margin (dB)	Remark
1	7275.000	37.34	6.49	43.83	74.00	-30.17	peak
2	8940.000	35.61	10.04	45.65	74.00	-28.35	peak
3	11955.000	32.55	17.83	50.38	74.00	-23.62	peak
4	13635.000	30.32	21.19	51.51	74.00	-22.49	peak
5	14010.000	30.59	21.93	52.52	74.00	-21.48	peak
6	17715.000	28.19	24.00	52.19	74.00	-21.81	peak



Test Mode:	802.11g	Channel:	2437
Polarity:	Vertical		

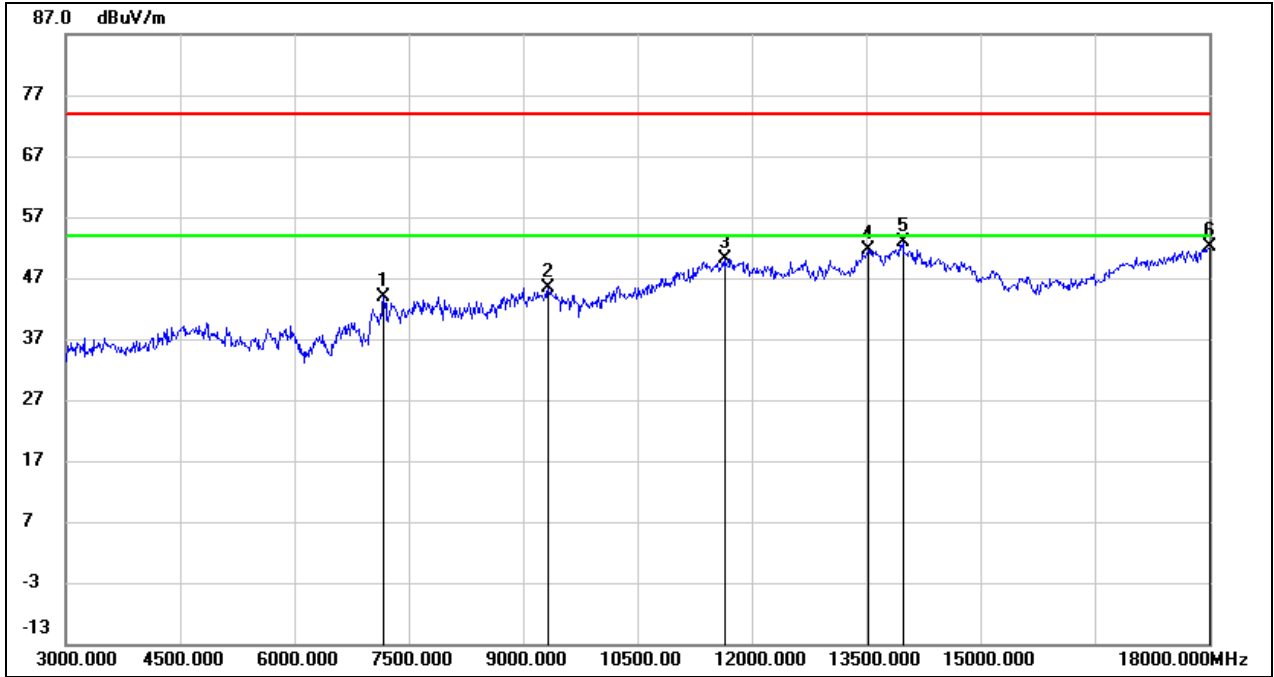

No.	Frequency (MHz)	Reading (dBuV)	Correct (dB/m)	Result (dBuV/m)	Limit (dBuV/m)	Margin (dB)	Remark
1	7170.000	37.36	6.56	43.92	74.00	-30.08	peak
2	9330.000	34.74	10.62	45.36	74.00	-28.64	peak
3	11655.000	33.23	17.01	50.24	74.00	-23.76	peak
4	13530.000	30.70	20.96	51.66	74.00	-22.34	peak
5	13980.000	30.88	21.92	52.80	74.00	-21.20	peak
6	18000.000	26.47	25.69	52.16	74.00	-21.84	peak



Test Mode:	802.11g	Channel:	2462
Polarity:	Horizontal		

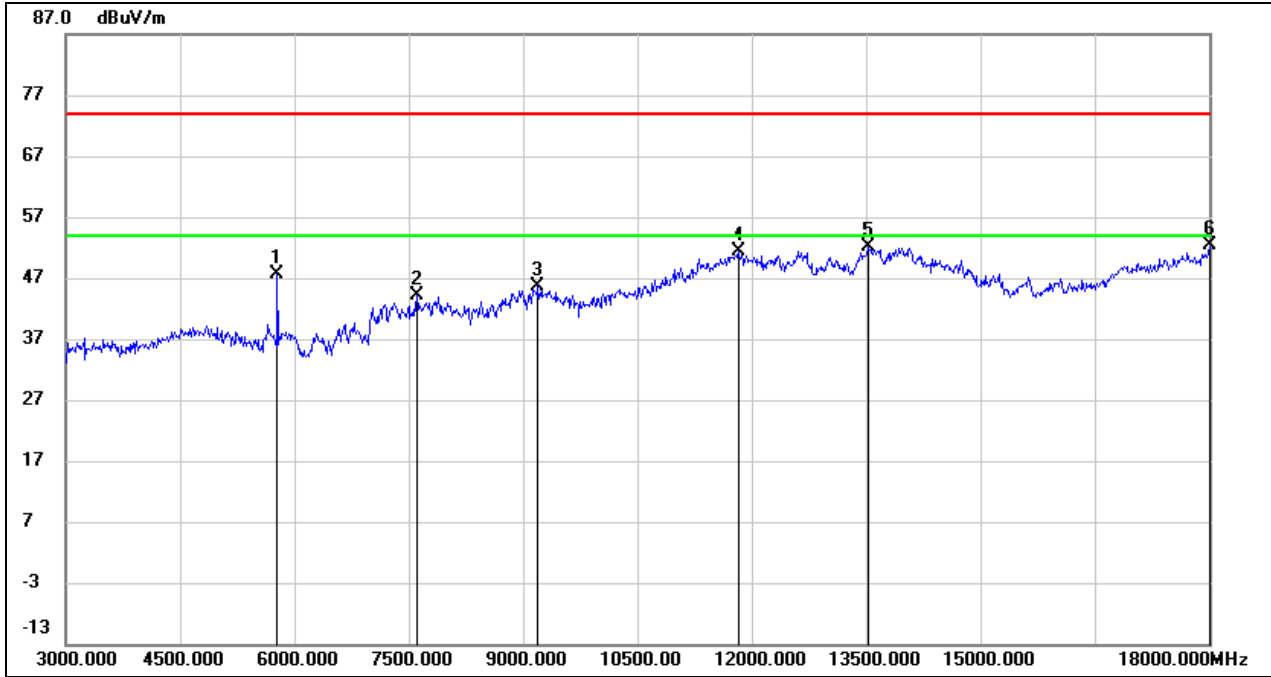

No.	Frequency (MHz)	Reading (dBuV)	Correct (dB/m)	Result (dBuV/m)	Limit (dBuV/m)	Margin (dB)	Remark
1	5775.000	46.11	1.63	47.74	74.00	-26.26	peak
2	7605.000	37.92	6.32	44.24	74.00	-29.76	peak
3	9195.000	35.17	10.56	45.73	74.00	-28.27	peak
4	11820.000	33.94	17.47	51.41	74.00	-22.59	peak
5	13530.000	31.20	20.96	52.16	74.00	-21.84	peak
6	18000.000	26.79	25.69	52.48	74.00	-21.52	peak



Test Mode:	802.11g	Channel:	2462
Polarity:	Vertical		

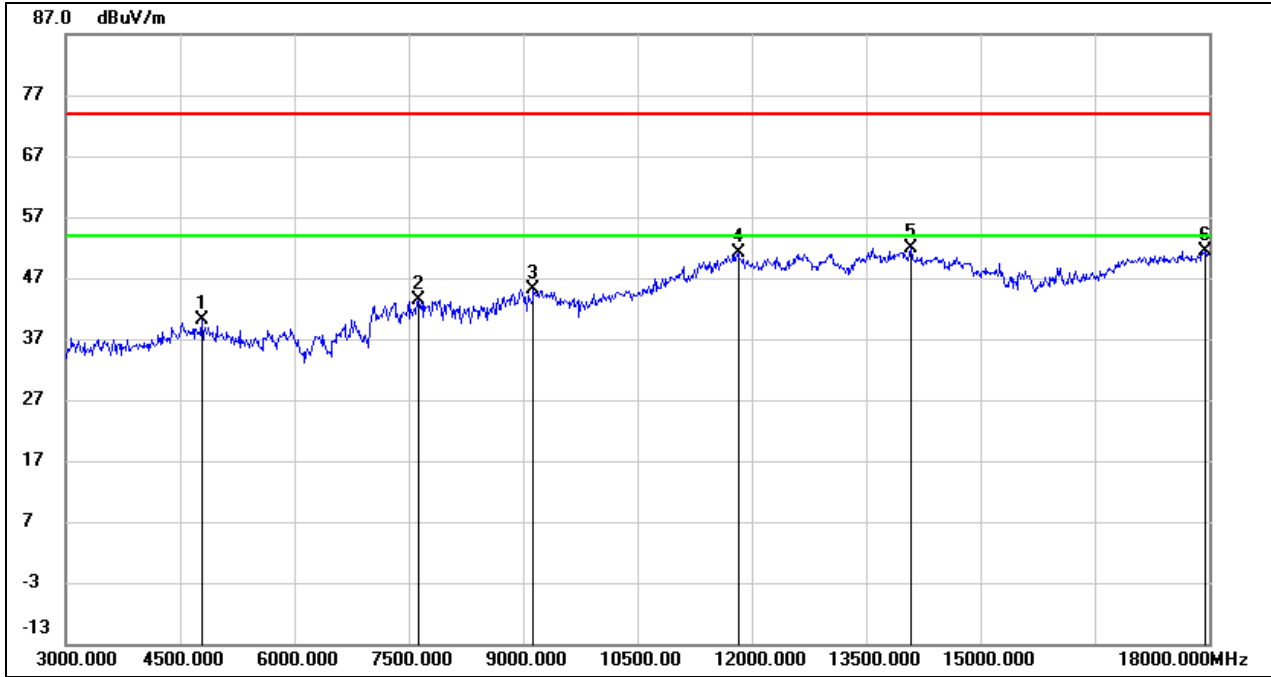

No.	Frequency (MHz)	Reading (dBuV)	Correct (dB/m)	Result (dBuV/m)	Limit (dBuV/m)	Margin (dB)	Remark
1	4785.000	40.52	-0.37	40.15	74.00	-33.85	peak
2	7635.000	36.98	6.33	43.31	74.00	-30.69	peak
3	9135.000	34.50	10.55	45.05	74.00	-28.95	peak
4	11820.000	33.54	17.47	51.01	74.00	-22.99	peak
5	14085.000	30.22	21.61	51.83	74.00	-22.17	peak
6	17955.000	25.92	25.42	51.34	74.00	-22.66	peak



Test Mode:	802.11n HT20	Channel:	2412
Polarity:	Horizontal		

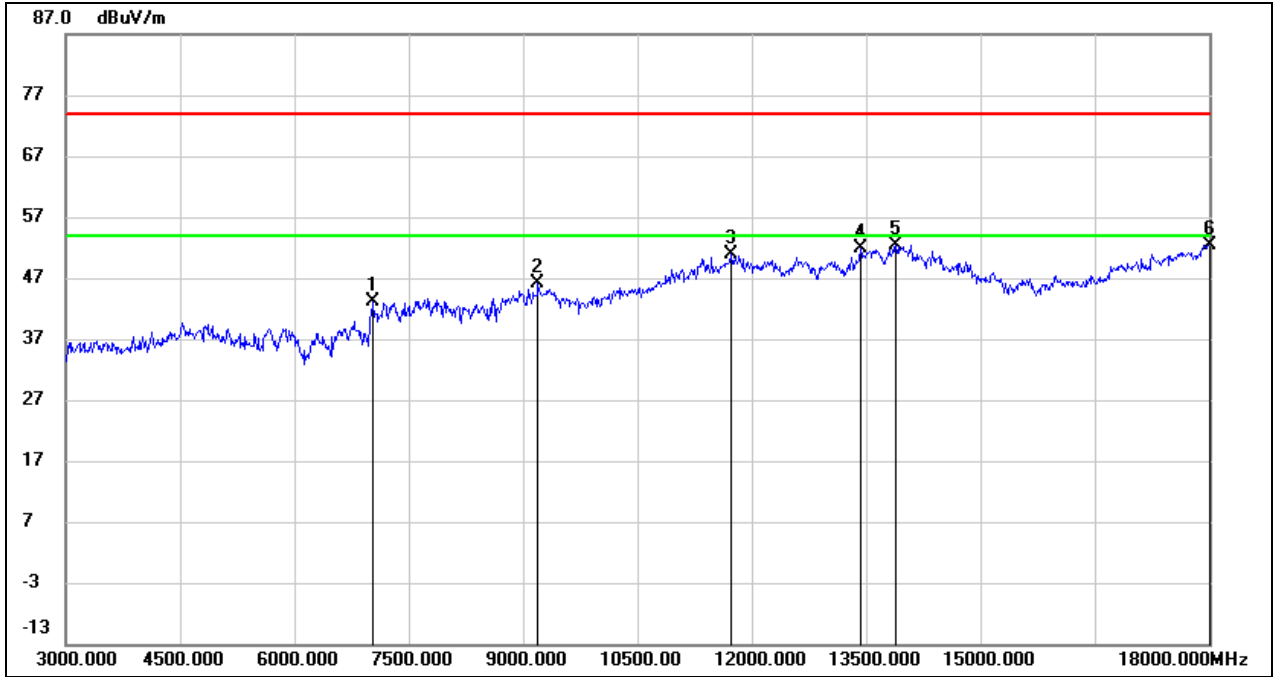

No.	Frequency (MHz)	Reading (dBuV)	Correct (dB/m)	Result (dBuV/m)	Limit (dBuV/m)	Margin (dB)	Remark
1	7035.000	36.58	6.67	43.25	74.00	-30.75	peak
2	9195.000	35.50	10.56	46.06	74.00	-27.94	peak
3	11730.000	33.55	17.22	50.77	74.00	-23.23	peak
4	13425.000	31.27	20.58	51.85	74.00	-22.15	peak
5	13890.000	30.70	21.72	52.42	74.00	-21.58	peak
6	18000.000	26.64	25.69	52.33	74.00	-21.67	peak



Test Mode:	802.11n HT20	Channel:	2412
Polarity:	Vertical		

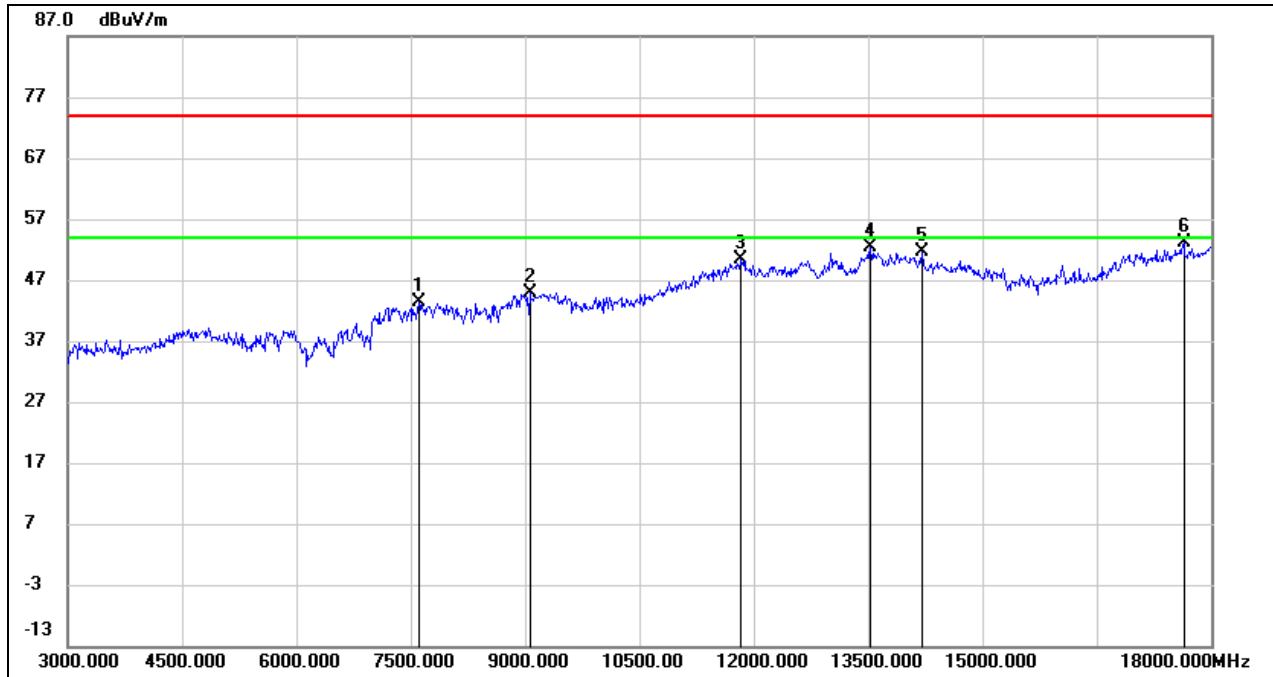

No.	Frequency (MHz)	Reading (dBuV)	Correct (dB/m)	Result (dBuV/m)	Limit (dBuV/m)	Margin (dB)	Remark
1	7605.000	37.01	6.32	43.33	74.00	-30.67	peak
2	9060.000	34.47	10.51	44.98	74.00	-29.02	peak
3	11835.000	32.88	17.51	50.39	74.00	-23.61	peak
4	13530.000	31.35	20.96	52.31	74.00	-21.69	peak
5	14205.000	30.42	21.11	51.53	74.00	-22.47	peak
6	17640.000	29.68	23.56	53.24	74.00	-20.76	peak



Test Mode:	802.11n HT20	Channel:	2437
Polarity:	Horizontal		

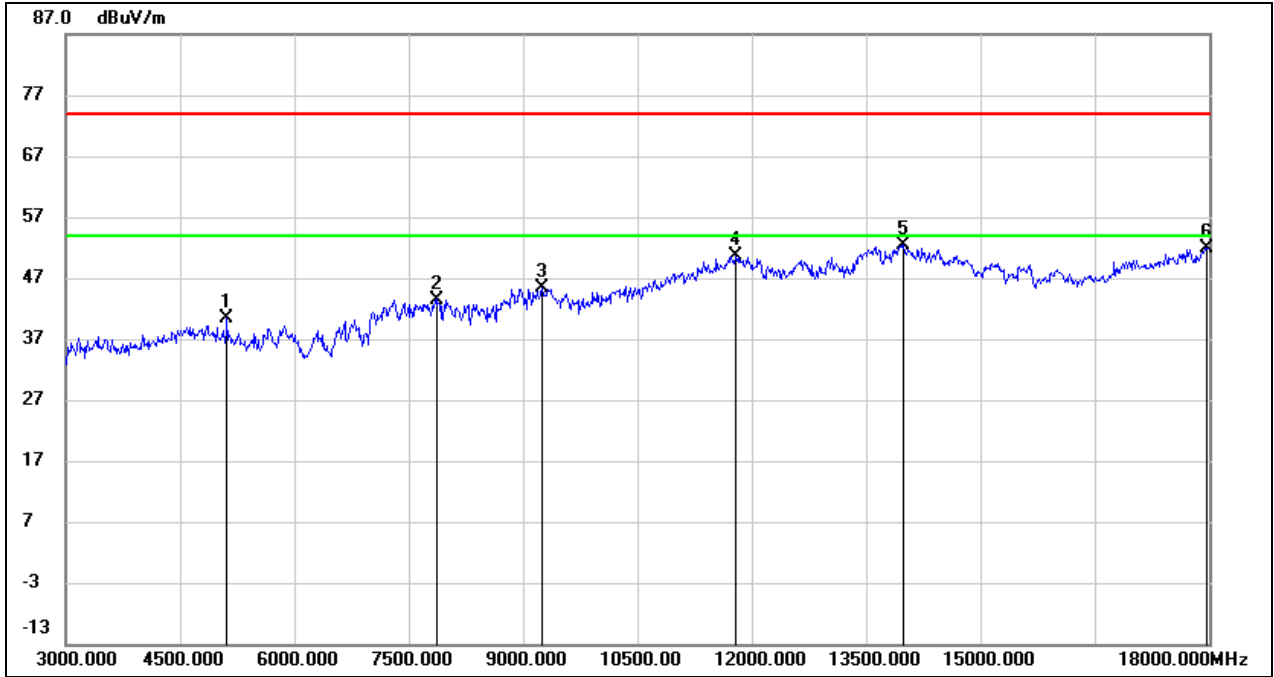

No.	Frequency (MHz)	Reading (dBuV)	Correct (dB/m)	Result (dBuV/m)	Limit (dBuV/m)	Margin (dB)	Remark
1	5115.000	39.88	0.54	40.42	74.00	-33.58	peak
2	7860.000	37.18	6.32	43.50	74.00	-30.50	peak
3	9255.000	34.90	10.59	45.49	74.00	-28.51	peak
4	11790.000	33.29	17.38	50.67	74.00	-23.33	peak
5	13995.000	30.52	21.95	52.47	74.00	-21.53	peak
6	17970.000	26.35	25.51	51.86	74.00	-22.14	peak



Test Mode:	802.11n HT20	Channel:	2437
Polarity:	Vertical		

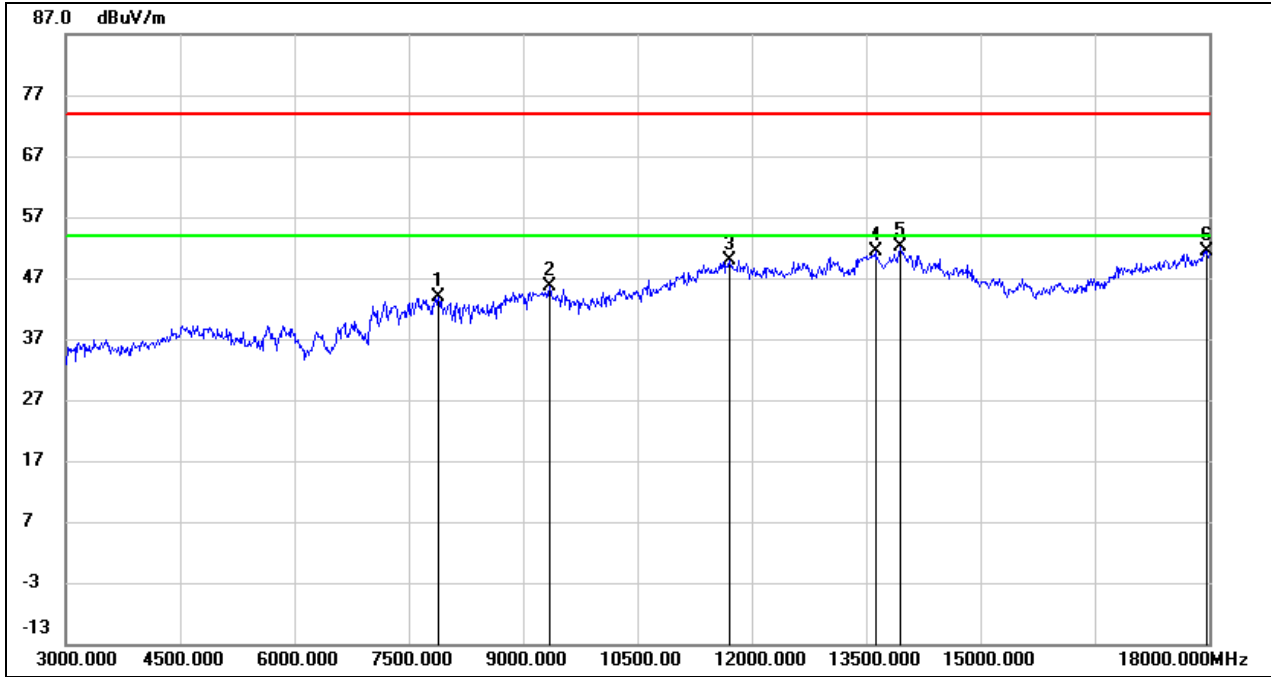

No.	Frequency (MHz)	Reading (dBuV)	Correct (dB/m)	Result (dBuV/m)	Limit (dBuV/m)	Margin (dB)	Remark
1	7890.000	37.64	6.31	43.95	74.00	-30.05	peak
2	9345.000	35.10	10.63	45.73	74.00	-28.27	peak
3	11700.000	32.80	17.14	49.94	74.00	-24.06	peak
4	13620.000	30.13	21.15	51.28	74.00	-22.72	peak
5	13950.000	30.15	21.86	52.01	74.00	-21.99	peak
6	17970.000	25.78	25.51	51.29	74.00	-22.71	peak



Test Mode:	802.11n HT20	Channel:	2462
Polarity:	Horizontal		

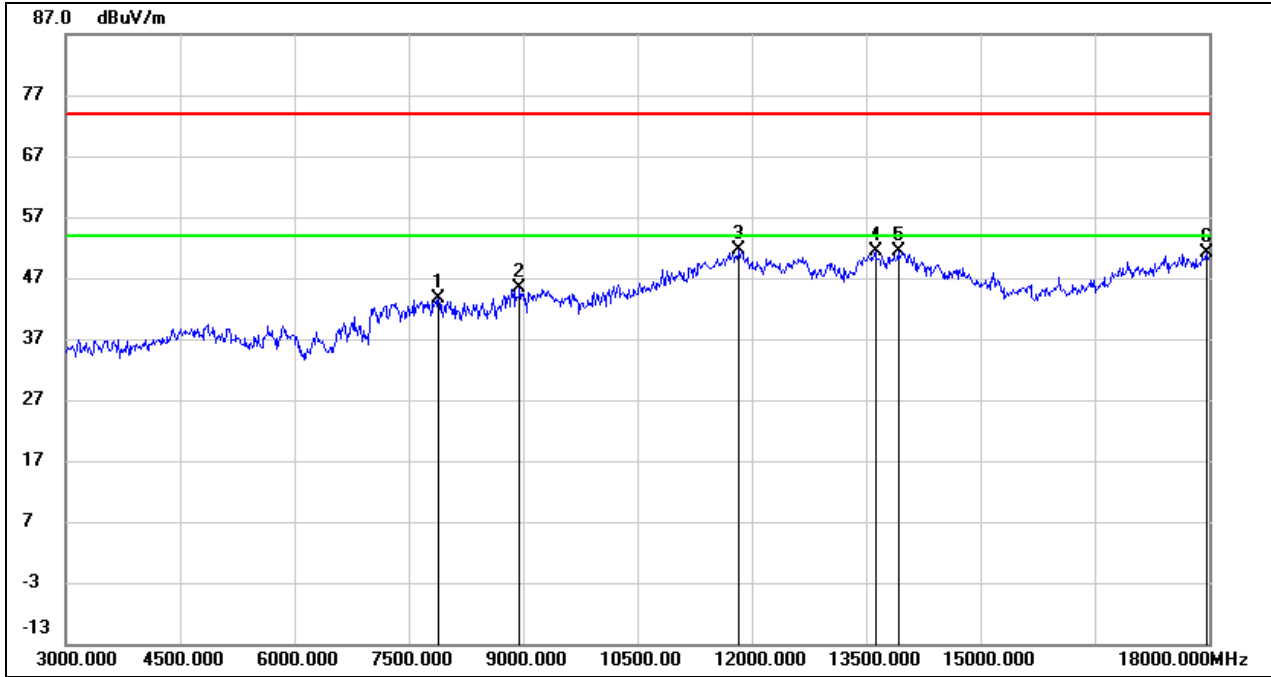

No.	Frequency (MHz)	Reading (dBuV)	Correct (dB/m)	Result (dBuV/m)	Limit (dBuV/m)	Margin (dB)	Remark
1	7890.000	37.38	6.31	43.69	74.00	-30.31	peak
2	8955.000	35.22	10.16	45.38	74.00	-28.62	peak
3	11835.000	34.12	17.51	51.63	74.00	-22.37	peak
4	13620.000	30.31	21.15	51.46	74.00	-22.54	peak
5	13920.000	29.47	21.79	51.26	74.00	-22.74	peak
6	17970.000	25.74	25.51	51.25	74.00	-22.75	peak



Test Mode:	802.11n HT20	Channel:	2462
Polarity:	Vertical		

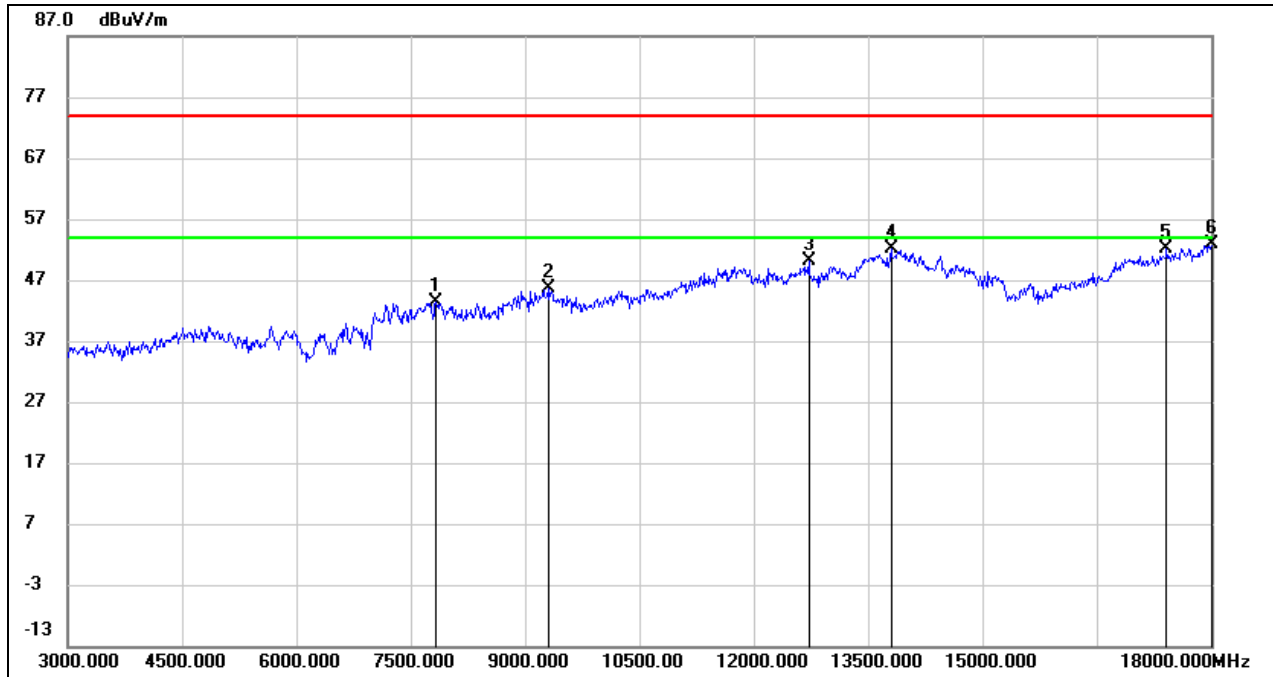

No.	Frequency (MHz)	Reading (dBuV)	Correct (dB/m)	Result (dBuV/m)	Limit (dBuV/m)	Margin (dB)	Remark
1	7830.000	36.97	6.32	43.29	74.00	-30.71	peak
2	9300.000	34.94	10.61	45.55	74.00	-28.45	peak
3	12720.000	32.01	18.08	50.09	74.00	-23.91	peak
4	13800.000	30.61	21.54	52.15	74.00	-21.85	peak
5	17415.000	29.70	22.42	52.12	74.00	-21.88	peak
6	18000.000	27.07	25.69	52.76	74.00	-21.24	peak



8.6. SPURIOUS EMISSIONS WITH CHARGING WORST CASE(3 GHZ~18 GHZ)

Test Mode:	802.11n HT20	Channel:	2412
Polarity:	Horizontal	Charger:	PMPN4284A

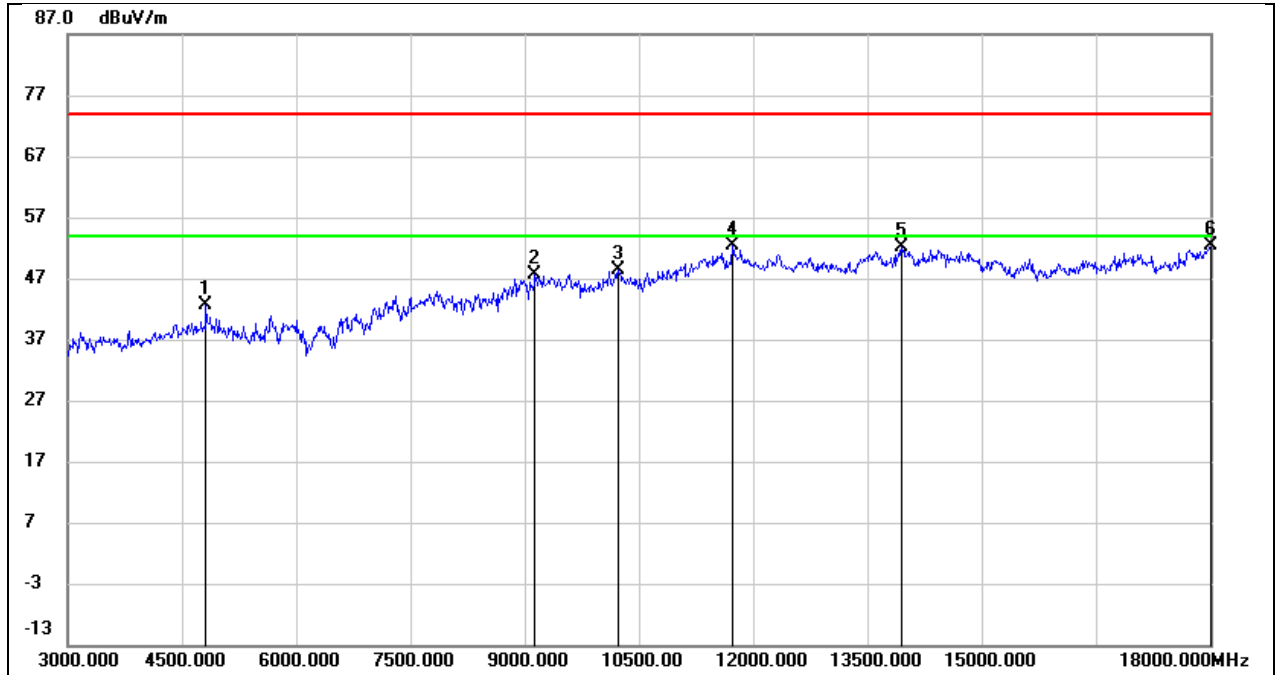

No.	Frequency (MHz)	Reading (dBuV)	Correct (dB/m)	Result (dBuV/m)	Limit (dBuV/m)	Margin (dB)	Remark
1	4815.000	42.80	-0.26	42.54	74.00	-31.46	peak
2	9135.000	37.18	10.55	47.73	74.00	-26.27	peak
3	10230.000	35.80	12.46	48.26	74.00	-25.74	peak
4	11730.000	35.12	17.22	52.34	74.00	-21.66	peak
5	13950.000	30.15	21.86	52.01	74.00	-21.99	peak
6	18000.000	26.75	25.69	52.44	74.00	-21.56	peak



Test Mode:	802.11n HT20	Channel:	2412
Polarity:	Vertical	Charger:	PMPN4284A

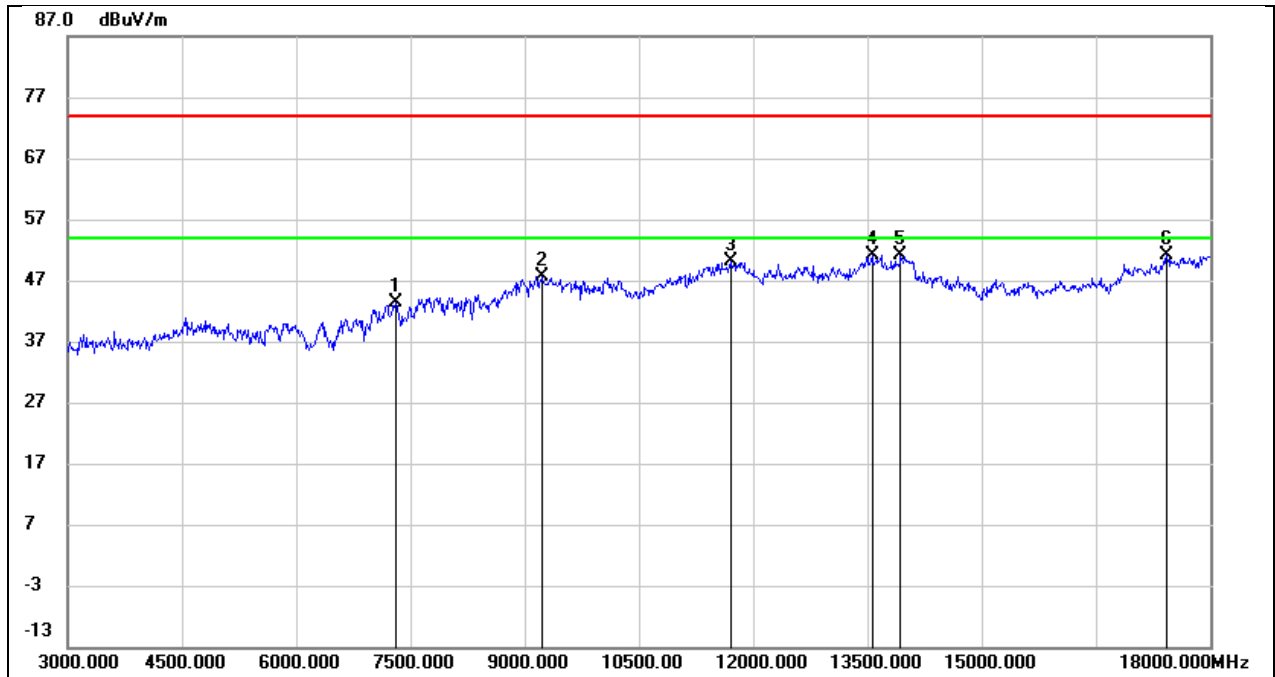

No.	Frequency (MHz)	Reading (dBuV)	Correct (dB/m)	Result (dBuV/m)	Limit (dBuV/m)	Margin (dB)	Remark
1	7305.000	36.83	6.47	43.30	74.00	-30.70	peak
2	9225.000	37.05	10.58	47.63	74.00	-26.37	peak
3	11715.000	33.04	17.19	50.23	74.00	-23.77	peak
4	13560.000	30.12	21.04	51.16	74.00	-22.84	peak
5	13935.000	29.19	21.82	51.01	74.00	-22.99	peak
6	17430.000	28.58	22.47	51.05	74.00	-22.95	peak



8.7. SPURIOUS EMISSIONS(9 KHZ~30 MHZ)

Test Mode:	802.11n HT20	Channel:	2412
Polarity:	Horizontal		

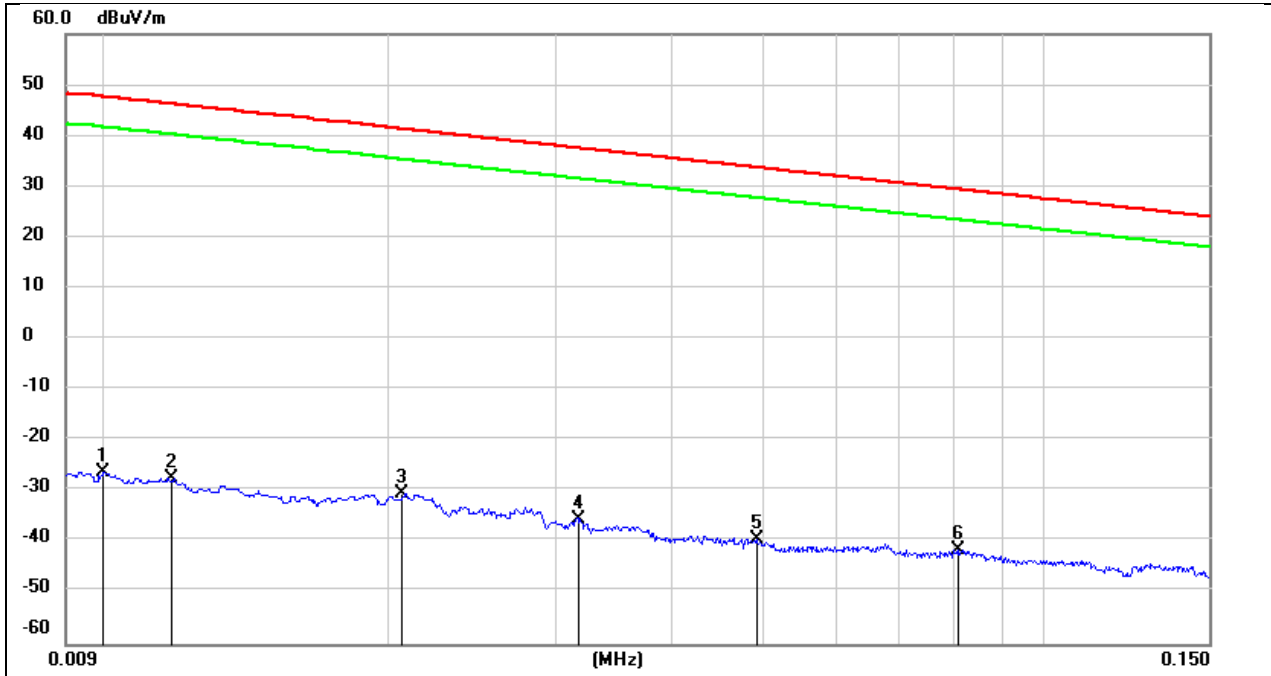

No.	Frequency (MHz)	Reading (dBuV)	Correct (dB/m)	FCC Result (dBuV/m)	FCC Limit (dBuV/m)	ISED Result (dBuA/m)	ISED Limit (dBuA/m)	Margin (dB)	Remark
1	0.0100	75.22	-101.40	-26.18	47.60	-77.68	-3.90	-73.78	peak
2	0.0117	73.98	-101.39	-27.41	46.24	-78.91	-5.26	-73.65	peak
3	0.0206	70.92	-101.35	-30.43	41.32	-81.93	-10.18	-71.75	peak
4	0.0318	65.84	-101.40	-35.56	37.55	-87.06	-13.95	-73.11	peak
5	0.0492	62.05	-101.47	-39.42	33.76	-90.92	-17.74	-73.18	peak
6	0.0810	60.02	-101.64	-41.62	29.43	-93.12	-22.07	-71.05	peak



Test Mode:	802.11n HT20	Channel:	2412
Polarity:	Horizontal		

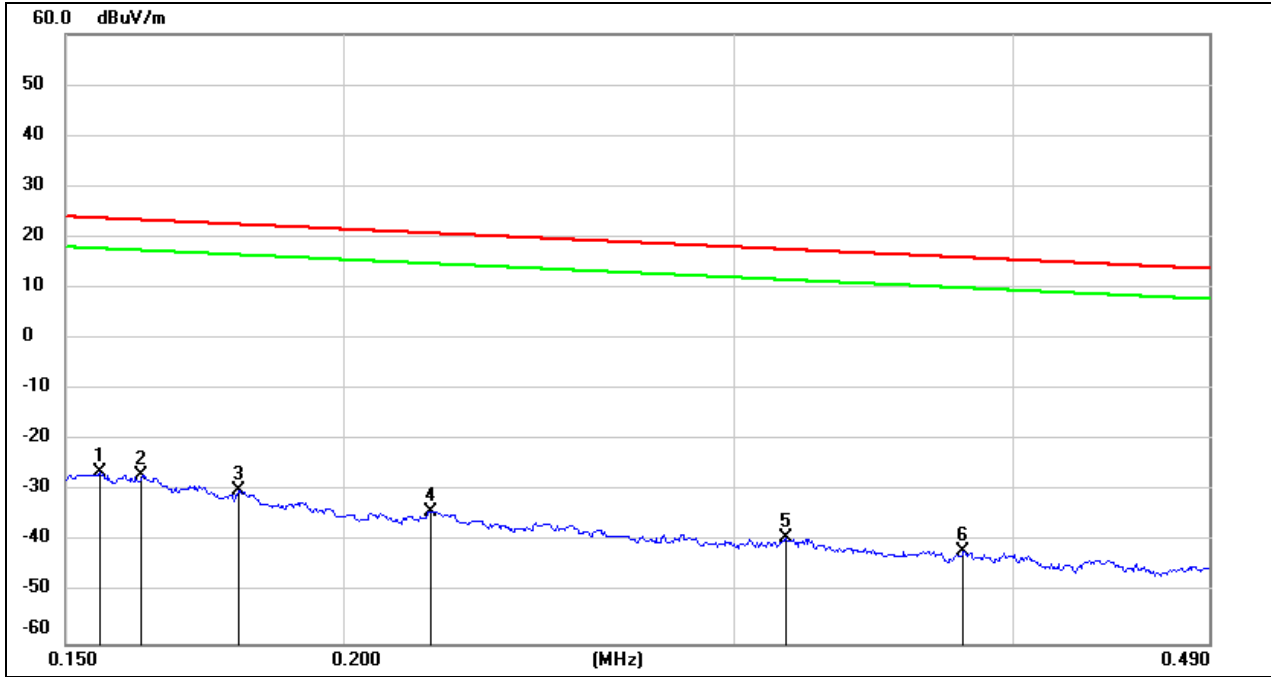

No.	Frequency (MHz)	Reading (dBuV)	Correct (dB/m)	FCC Result (dBuV/m)	FCC Limit (dBuV/m)	ISED Result (dBuA/m)	ISED Limit (dBuA/m)	Margin (dB)	Remark
1	0.1554	75.27	-101.65	-26.38	23.77	-77.88	-27.73	-50.15	peak
2	0.1621	74.92	-101.65	-26.73	23.41	-78.23	-28.09	-50.14	peak
3	0.1794	71.77	-101.68	-29.91	22.53	-81.41	-28.97	-52.44	peak
4	0.2190	67.77	-101.75	-33.98	20.79	-85.48	-30.71	-54.77	peak
5	0.3163	62.70	-101.87	-39.17	17.60	-90.67	-33.90	-56.77	peak
6	0.3800	60.02	-101.94	-41.92	16.01	-93.42	-35.49	-57.93	peak



Test Mode:	802.11n HT20	Channel:	2412
Polarity:	Horizontal		

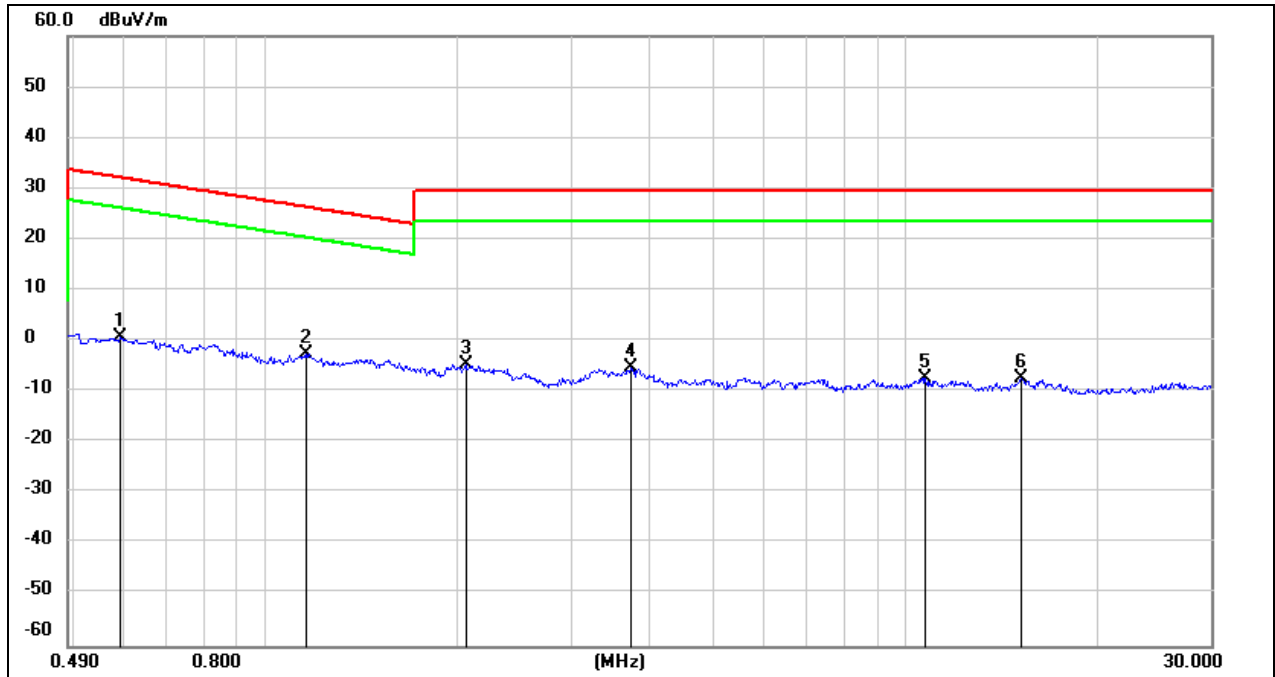

No.	Frequency (MHz)	Reading (dBuV)	Correct (dB/m)	FCC Result (dBuV/m)	FCC Limit (dBuV/m)	ISED Result (dBuA/m)	ISED Limit (dBuA/m)	Margin (dB)	Remark
1	0.5917	62.74	-62.08	0.66	32.16	-50.84	-19.34	-31.50	peak
2	1.1531	59.75	-62.20	-2.45	26.37	-53.95	-25.13	-28.82	peak
3	2.0539	57.20	-61.81	-4.61	29.54	-56.11	-21.96	-34.15	peak
4	3.7100	56.20	-61.41	-5.21	29.54	-56.71	-21.96	-34.75	peak
5	10.7299	53.48	-60.83	-7.35	29.54	-58.85	-21.96	-36.89	peak
6	15.1859	53.55	-61.01	-7.46	29.54	-58.96	-21.96	-37.00	peak

**8.8. SPURIOUS EMISSIONS(18 GHZ~26 GHZ)**

Test Mode:	802.11n HT20	Channel:	2412
Polarity:	Horizontal		

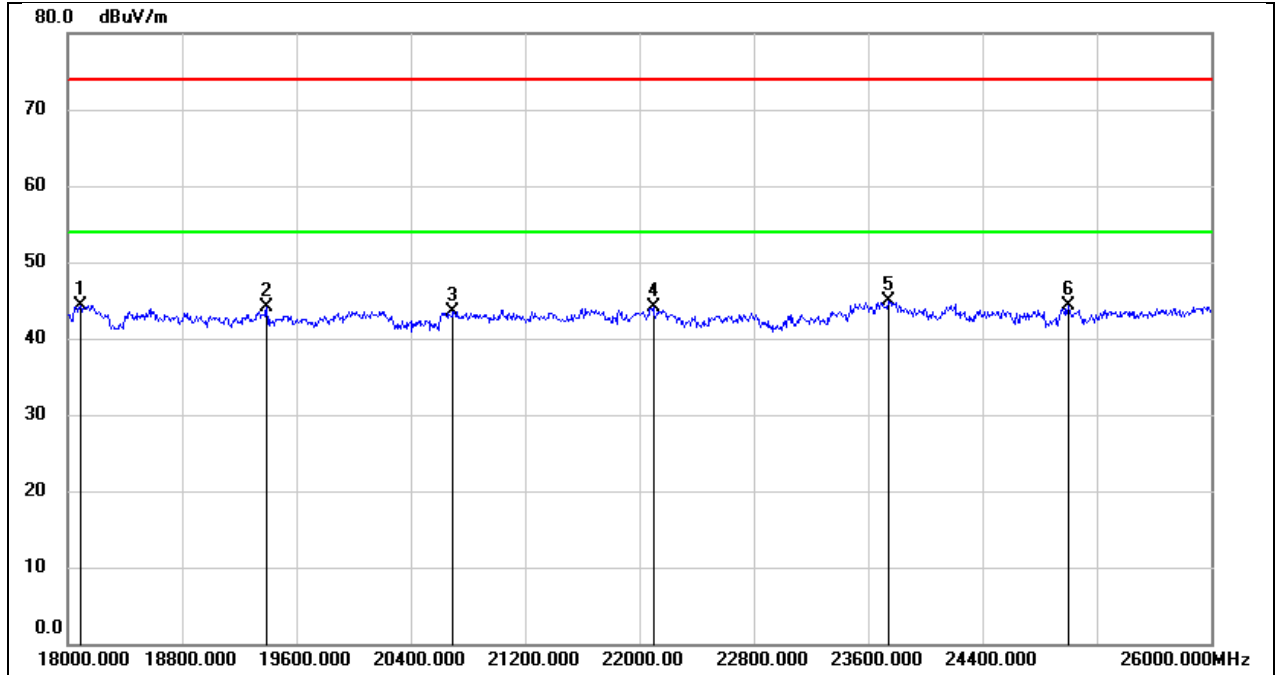

No.	Frequency (MHz)	Reading (dBuV)	Correct (dB/m)	Result (dBuV/m)	Limit (dBuV/m)	Margin (dB)	Remark
1	18088.000	49.75	-5.43	44.32	74.00	-29.68	peak
2	19392.000	49.62	-5.57	44.05	74.00	-29.95	peak
3	20696.000	48.71	-5.16	43.55	74.00	-30.45	peak
4	22096.000	48.54	-4.38	44.16	74.00	-29.84	peak
5	23744.000	48.15	-3.20	44.95	74.00	-29.05	peak
6	25000.000	46.36	-2.10	44.26	74.00	-29.74	peak



Test Mode:	802.11n HT20	Channel:	2412
Polarity:	Vertical		

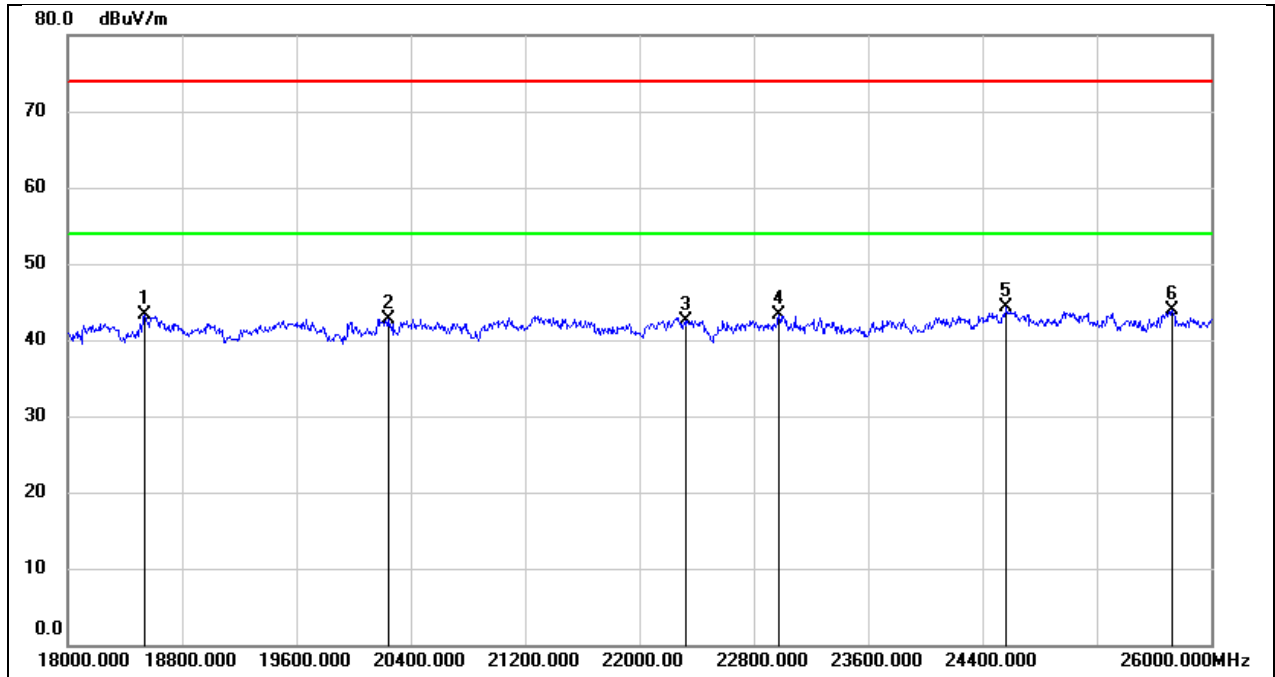

No.	Frequency (MHz)	Reading (dBuV)	Correct (dB/m)	Result (dBuV/m)	Limit (dBuV/m)	Margin (dB)	Remark
1	18536.000	48.60	-5.27	43.33	74.00	-30.67	peak
2	20240.000	48.32	-5.61	42.71	74.00	-31.29	peak
3	22328.000	46.70	-4.11	42.59	74.00	-31.41	peak
4	22976.000	46.76	-3.46	43.30	74.00	-30.70	peak
5	24568.000	46.60	-2.33	44.27	74.00	-29.73	peak
6	25728.000	44.61	-0.72	43.89	74.00	-30.11	peak



8.9. SPURIOUS EMISSIONS(30 MHZ~1 GHZ)

Test Mode:	802.11n HT20	Channel:	2412
Polarity:	Horizontal		

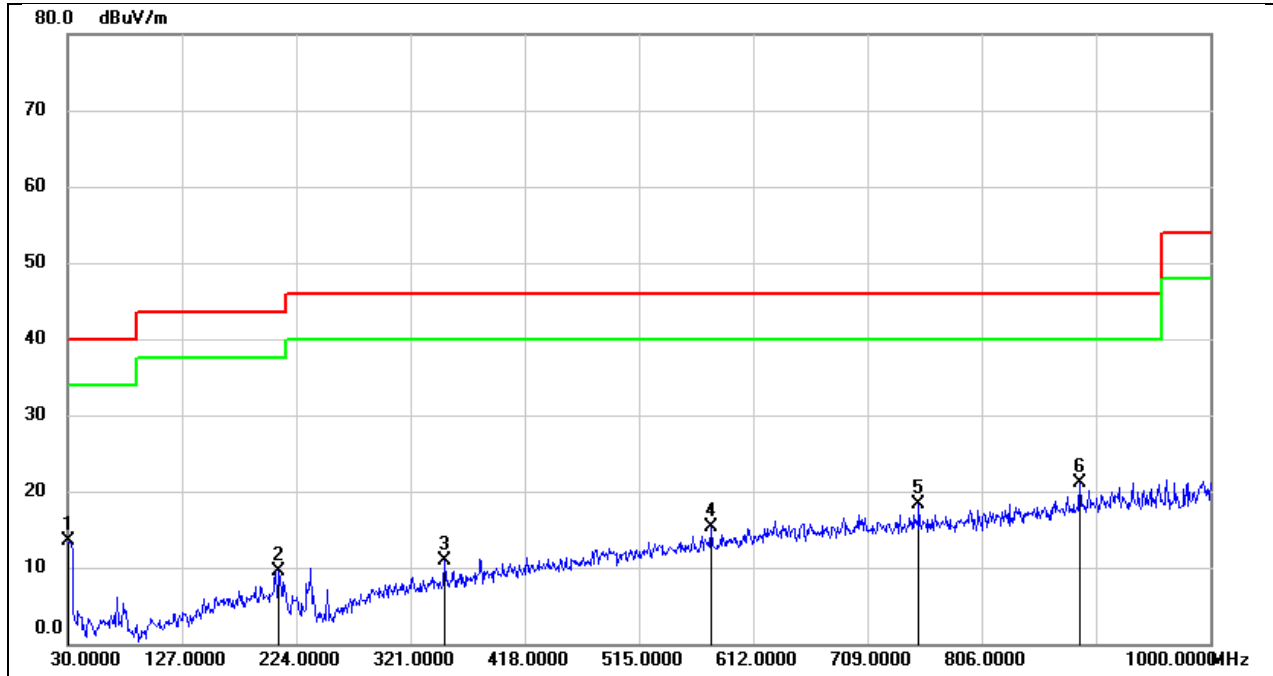

No.	Frequency (MHz)	Reading (dBuV)	Correct (dB/m)	Result (dBuV/m)	Limit (dBuV/m)	Margin (dB)	Remark
1	30.0000	32.48	-18.94	13.54	40.00	-26.46	QP
2	208.4800	26.69	-17.14	9.55	43.50	-33.95	QP
3	350.1000	25.17	-14.32	10.85	46.00	-35.15	QP
4	576.1100	25.41	-10.02	15.39	46.00	-30.61	QP
5	752.6500	26.19	-7.87	18.32	46.00	-27.68	QP
6	889.4200	26.30	-5.25	21.05	46.00	-24.95	QP



Test Mode:	802.11n HT20	Channel:	2412
Polarity:	Vertical		

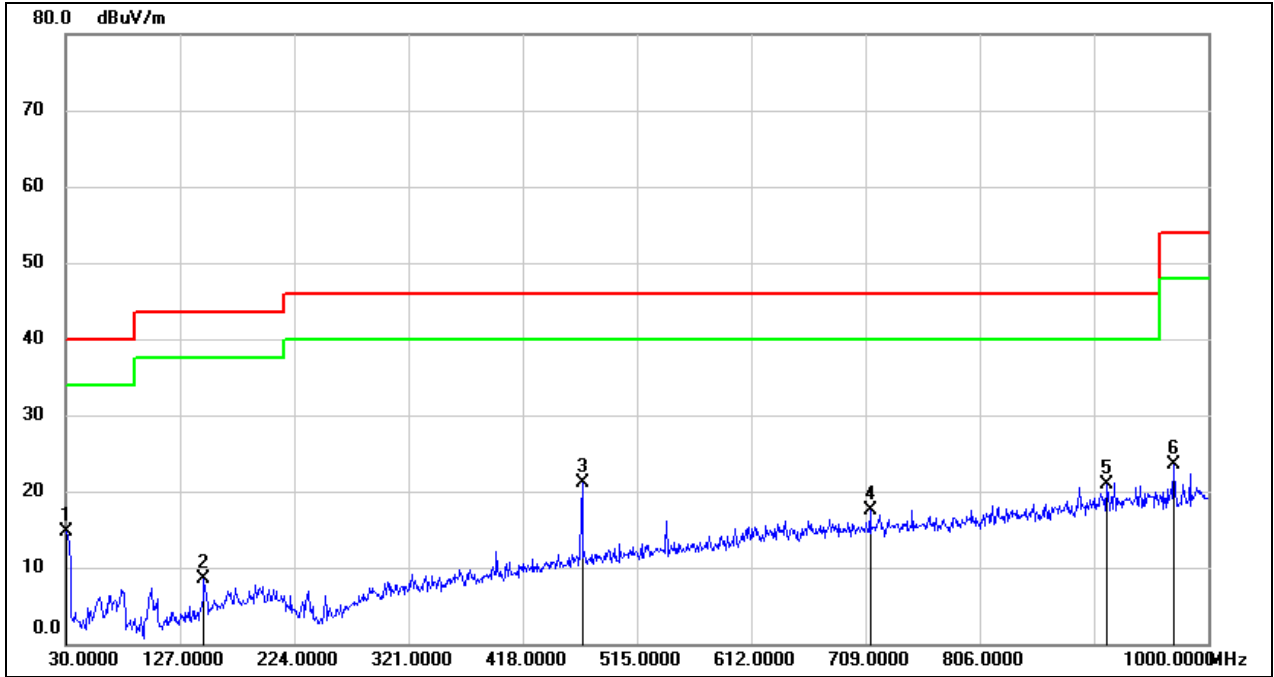

No.	Frequency (MHz)	Reading (dBuV)	Correct (dB/m)	Result (dBuV/m)	Limit (dBuV/m)	Margin (dB)	Remark
1	30.9700	33.70	-19.04	14.66	40.00	-25.34	QP
2	147.3700	26.90	-18.43	8.47	43.50	-35.03	QP
3	468.4400	33.06	-12.04	21.02	46.00	-24.98	QP
4	712.8800	25.71	-8.20	17.51	46.00	-28.49	QP
5	913.6700	25.81	-4.89	20.92	46.00	-25.08	QP
6	970.9000	27.87	-4.40	23.47	54.00	-30.53	QP



8.10. SPURIOUS EMISSIONS WITH CHARGING WORST CASE(30 MHZ~1 GHZ)

Test Mode:	802.11n HT20	Channel:	2412
Polarity:	Horizontal	Charger:	PMPN4284A

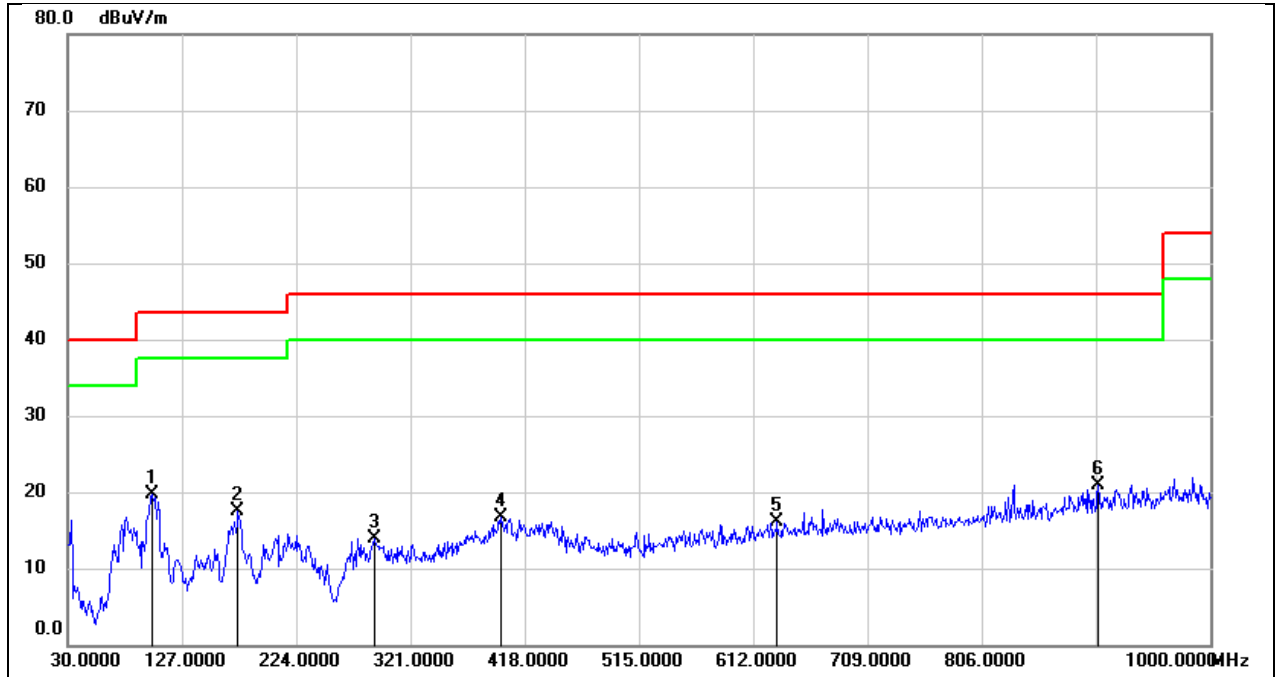

No.	Frequency (MHz)	Reading (dBuV)	Correct (dB/m)	Result (dBuV/m)	Limit (dBuV/m)	Margin (dB)	Remark
1	101.7800	40.80	-21.00	19.80	43.50	-23.70	QP
2	174.5300	34.59	-17.12	17.47	43.50	-26.03	QP
3	290.9300	29.78	-15.84	13.94	46.00	-32.06	QP
4	397.6300	30.05	-13.39	16.66	46.00	-29.34	QP
5	632.3700	25.15	-9.13	16.02	46.00	-29.98	QP
6	904.9400	26.08	-5.11	20.97	46.00	-25.03	QP



Test Mode:	802.11n HT20	Channel:	2412
Polarity:	Vertical	Charger:	PMPN4284A

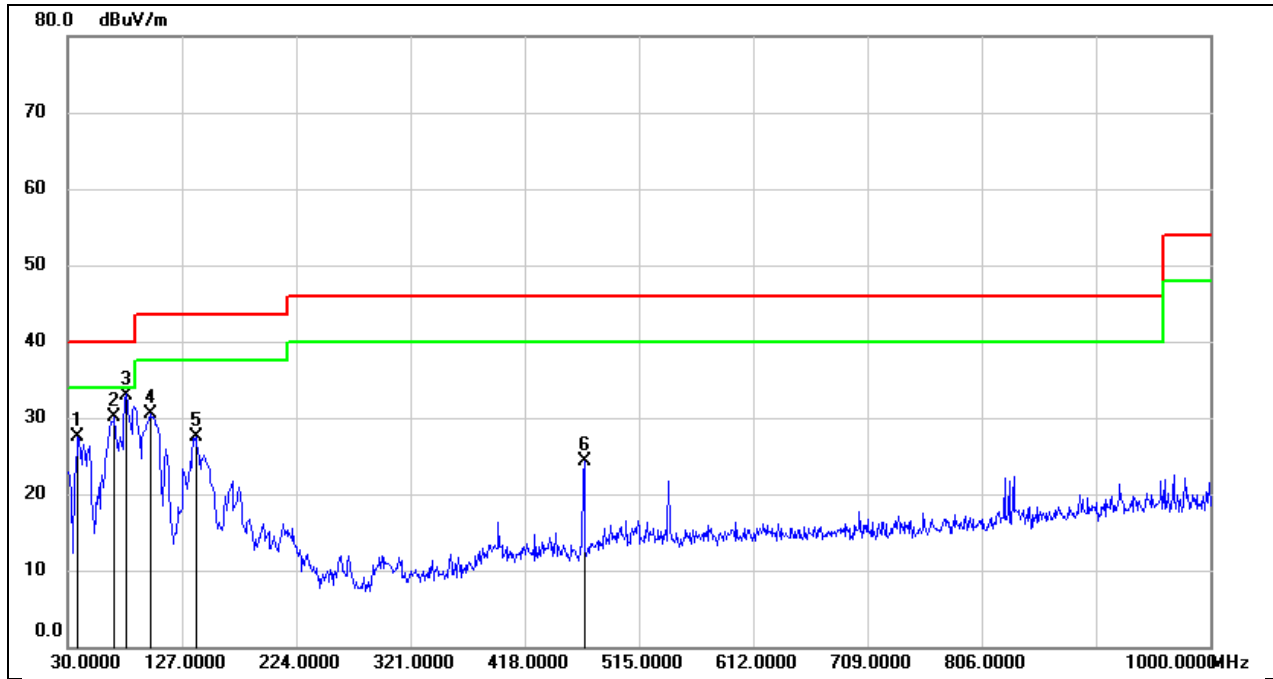

No.	Frequency (MHz)	Reading (dBuV)	Correct (dB/m)	Result (dBuV/m)	Limit (dBuV/m)	Margin (dB)	Remark
1	38.7300	47.40	-19.81	27.59	40.00	-12.41	QP
2	69.7699	50.64	-20.57	30.07	40.00	-9.93	QP
3	79.4700	54.30	-21.30	33.00	40.00	-7.00	QP
4	99.8399	51.56	-21.15	30.41	43.50	-13.09	QP
5	138.6400	46.46	-18.91	27.55	43.50	-15.95	QP
6	468.4400	36.28	-12.04	24.24	46.00	-21.76	QP



9. ANTENNA REQUIREMENT

REQUIREMENT

Please refer to FCC §15.203

An intentional radiator shall be designed to ensure that no antenna other than that furnished by the responsible party shall be used with the device. The use of a permanently attached antenna or of an antenna that uses a unique coupling to the intentional radiator shall be considered sufficient to comply with the provisions of this section. The manufacturer may design the unit so that a broken antenna can be replaced by the user, but the use of a standard antenna jack or electrical connector is prohibited.

Please refer to FCC §15.247(b)(4)

The conducted output power limit specified in paragraph (b) of this section is based on the use of antennas with directional gains that do not exceed 6 dBi. Except as shown in paragraph (c) of this section, if transmitting antennas of directional gain greater than 6 dBi are used, the conducted output power from the intentional radiator shall be reduced below the stated values in paragraphs (b)(1), (b)(2), and (b)(3) of this section, as appropriate, by the amount in dB that the directional gain of the antenna exceeds 6 dBi.

DESCRIPTION

Complies

10. AC POWER LINE CONDUCTED EMISSION

LIMITS

Please refer to CFR 47 FCC §15.207 (a) and ISED RSS-Gen Clause 8.8

FREQUENCY (MHz)	Quasi-peak	Average
0.15 -0.5	66 - 56 *	56 - 46 *
0.50 -5.0	56.00	46.00
5.0 -30.0	60.00	50.00

TEST PROCEDURE

The EUT is put on a table of non-conducting material that is 80 cm high. The vertical conducting wall of shielding is located 40 cm to the rear of the EUT. The power line of the EUT is connected to the AC mains through a Artificial Mains Network (A.M.N.). A EMI Measurement Receiver (R&S Test Receiver ESR3) is used to test the emissions from both sides of AC line. According to the requirements in Section 6.2 of ANSI C63.10-2013. Conducted emissions from the EUT measured in the frequency range between 0.15 MHz and 30 MHz using CISPR Quasi-Peak and average detector mode. The bandwidth of EMI test receiver is set at 9 kHz.

The arrangement of the equipment is installed to meet the standards and operating in a manner, which tends to maximize its emission characteristics in a normal application.

TEST SETUP

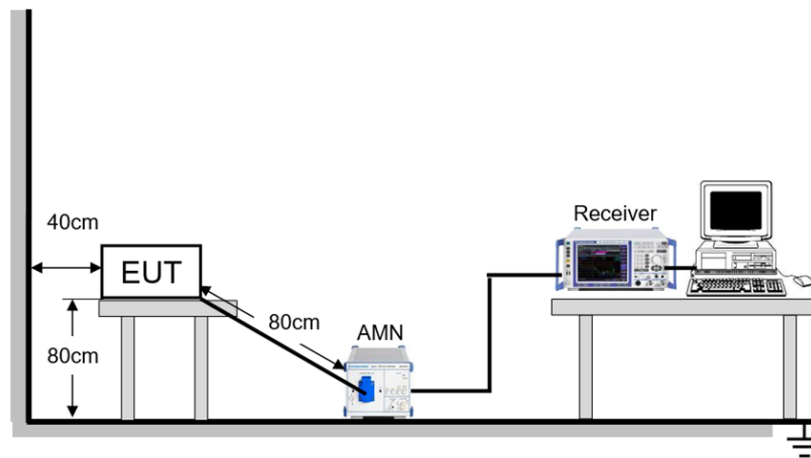

TEST ENVIRONMENT

Temperature	23.8°C	Relative Humidity	56%
Atmosphere Pressure	101kPa	Test Voltage	AC 120 V, 60 Hz



TEST RESULTS

Test Mode:	802.11n HT20	Channel:	2412
Line:	Line		

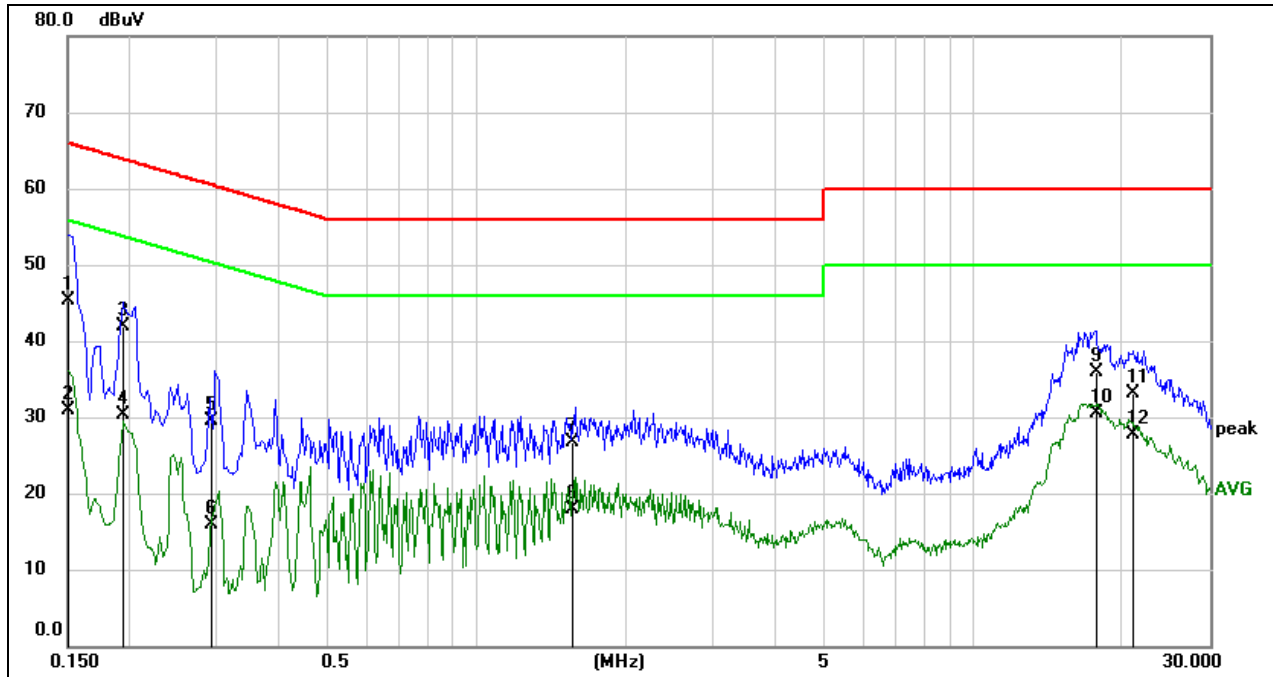

No.	Frequency (MHz)	Reading (dBuV)	Correct (dB)	Result (dBuV)	Limit (dBuV)	Margin (dB)	Remark
1	0.1500	35.91	9.49	45.40	66.00	-20.60	QP
2	0.1500	21.47	9.49	30.96	56.00	-25.04	AVG
3	0.1937	32.35	9.58	41.93	63.88	-21.95	QP
4	0.1937	20.77	9.58	30.35	53.88	-23.53	AVG
5	0.2935	19.91	9.56	29.47	60.42	-30.95	QP
6	0.2935	6.33	9.56	15.89	50.42	-34.53	AVG
7	1.5601	17.11	9.58	26.69	56.00	-29.31	QP
8	1.5601	8.39	9.58	17.97	46.00	-28.03	AVG
9	17.6887	26.13	9.70	35.83	60.00	-24.17	QP
10	17.6887	20.79	9.70	30.49	50.00	-19.51	AVG
11	21.1435	23.40	9.75	33.15	60.00	-26.85	QP
12	21.1435	17.91	9.75	27.66	50.00	-22.34	AVG

Note:

1. Result = Reading + Correct Factor.
2. If QP Result complies with AV limit, AV Result is deemed to comply with AV limit.
3. Test setup: RBW: 200 Hz (9 kHz ~ 150 kHz), 9 kHz (150 kHz ~ 30 MHz).
4. Step size: 80 Hz (0.009 MHz ~ 0.15 MHz), 4 kHz (0.15 MHz ~ 30 MHz), Scan time: auto.

Note: All the modes have been tested, only the worst data was recorded in the report.



Test Mode:	802.11n HT20	Channel:	2412
Line:	Neutral		

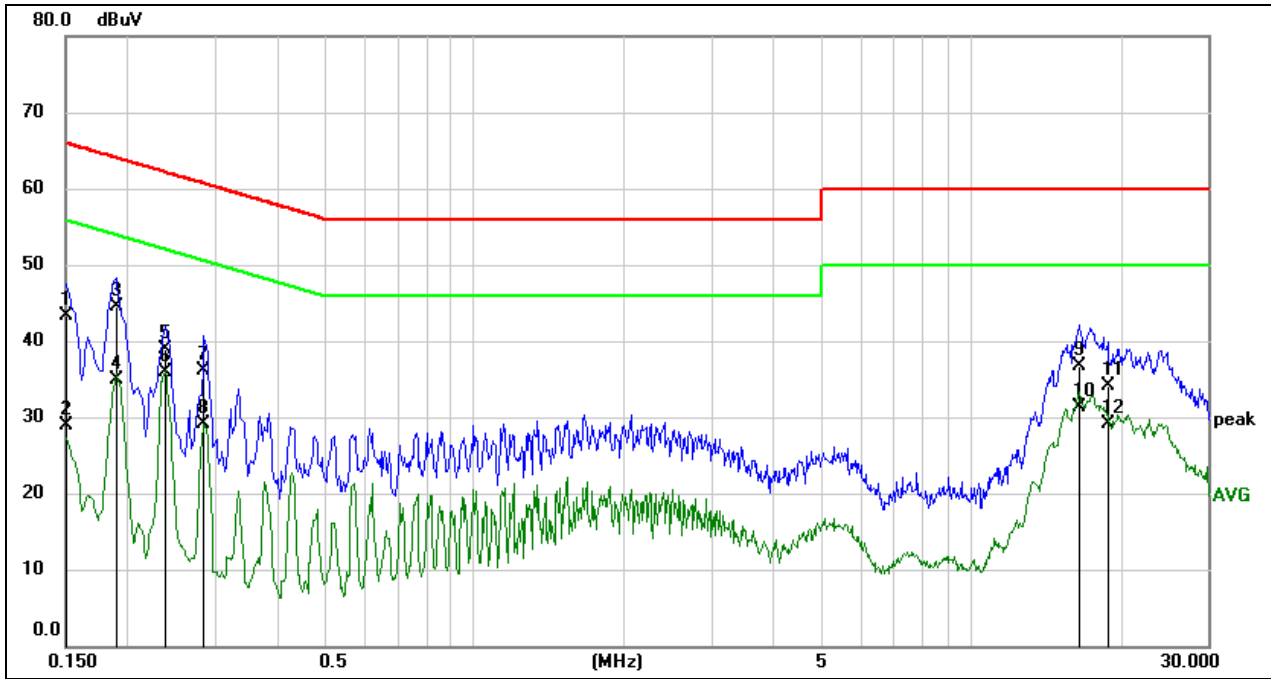

No.	Frequency (MHz)	Reading (dBuV)	Correct (dB)	Result (dBuV)	Limit (dBuV)	Margin (dB)	Remark
1	0.1500	33.81	9.49	43.30	66.00	-22.70	QP
2	0.1500	19.48	9.49	28.97	56.00	-27.03	AVG
3	0.1903	34.89	9.57	44.46	64.02	-19.56	QP
4	0.1903	25.37	9.57	34.94	54.02	-19.08	AVG
5	0.2377	29.42	9.58	39.00	62.18	-23.18	QP
6	0.2377	26.23	9.58	35.81	52.18	-16.37	AVG
7	0.2853	26.49	9.56	36.05	60.66	-24.61	QP
8	0.2853	19.45	9.56	29.01	50.66	-21.65	AVG
9	16.5144	27.10	9.66	36.76	60.00	-23.24	QP
10	16.5144	21.71	9.66	31.37	50.00	-18.63	AVG
11	18.8303	24.41	9.72	34.13	60.00	-25.87	QP
12	18.8303	19.29	9.72	29.01	50.00	-20.99	AVG

Note:

1. Result = Reading + Correct Factor.
2. If QP Result complies with AV limit, AV Result is deemed to comply with AV limit.
3. Test setup: RBW: 200 Hz (9 kHz ~ 150 kHz), 9 kHz (150 kHz ~ 30 MHz).
4. Step size: 80 Hz (0.009 MHz ~ 0.15 MHz), 4 kHz (0.15 MHz ~ 30 MHz), Scan time: auto.

Note: All the modes have been tested, only the worst data was recorded in the report.



11. TEST DATA

11.1. APPENDIX A: DTS BANDWIDTH

11.1.1. Test Result

Test Mode	Antenna	Channel	DTS BW [MHz]	FL[MHz]	FH[MHz]	Limit[MHz]	Verdict
11B	Ant1	2412	10.08	2406.96	2417.04	0.5	PASS
		2437	10.08	2431.96	2442.04	0.5	PASS
		2462	10.08	2456.96	2467.04	0.5	PASS
11G	Ant1	2412	16.40	2403.80	2420.20	0.5	PASS
		2437	16.32	2428.84	2445.16	0.5	PASS
		2462	16.32	2453.84	2470.16	0.5	PASS
11N20SISO	Ant1	2412	17.60	2403.20	2420.80	0.5	PASS
		2437	16.32	2428.84	2445.16	0.5	PASS
		2462	16.36	2453.80	2470.16	0.5	PASS

11.1.2. Test Graphs

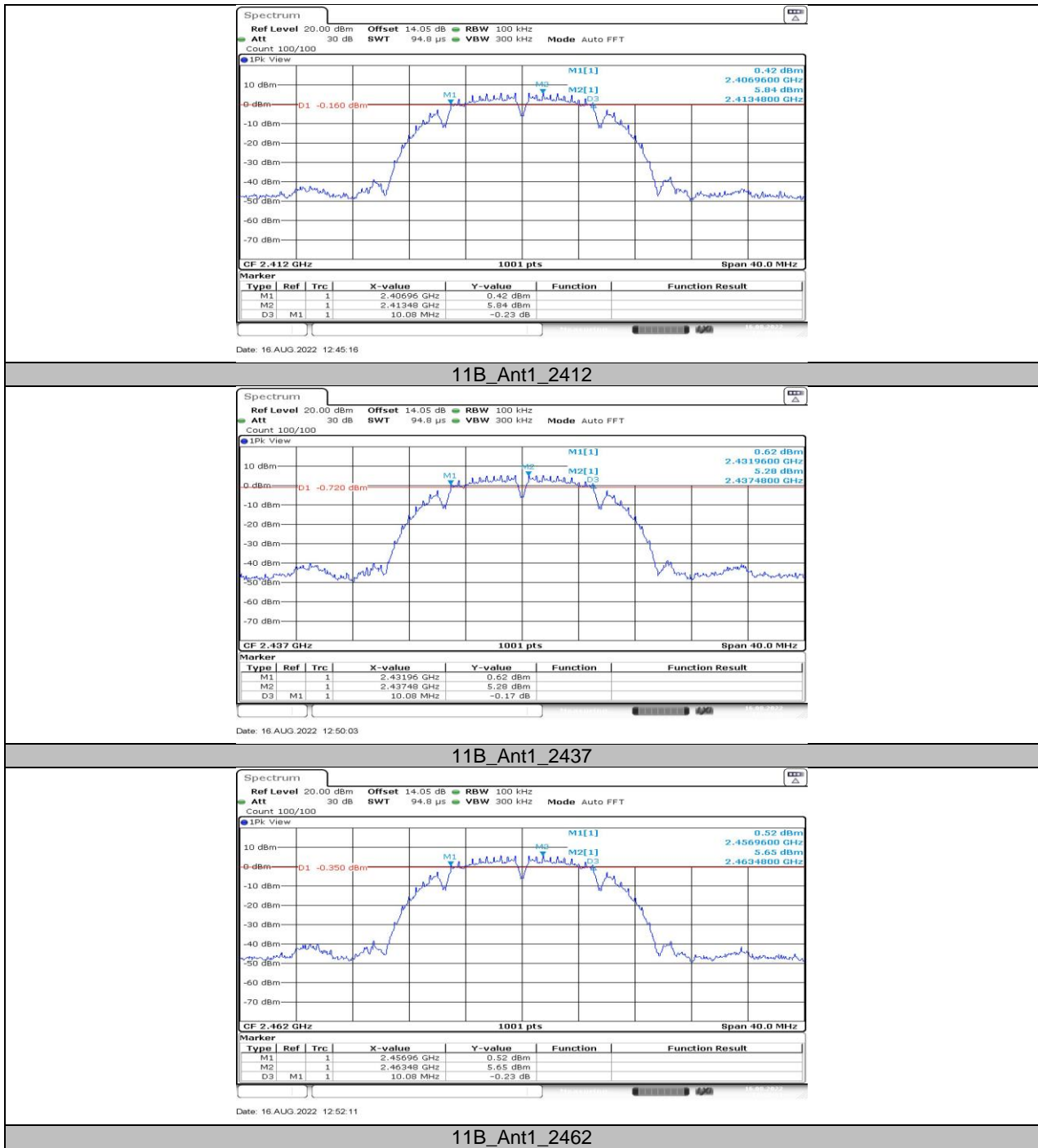

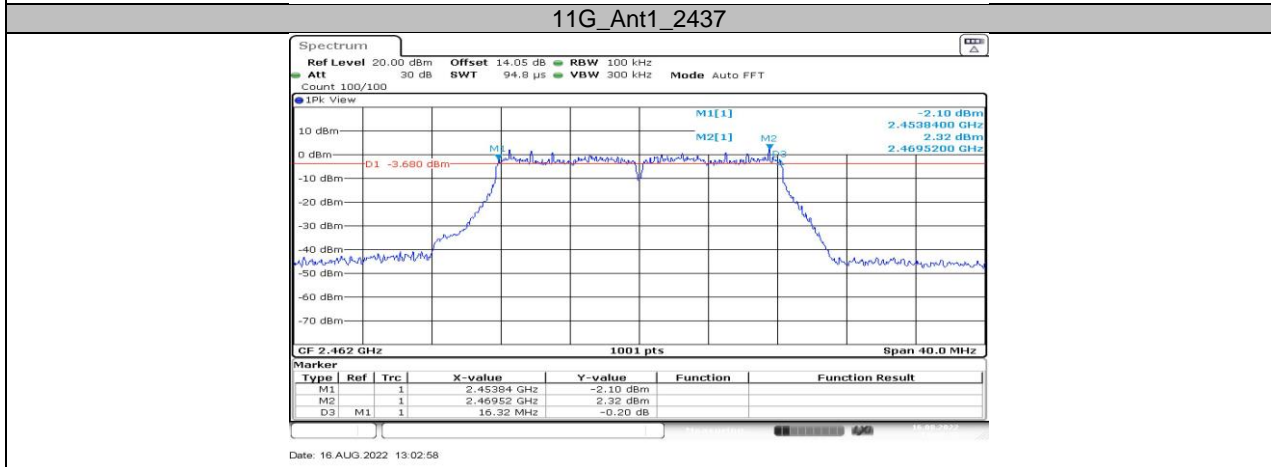
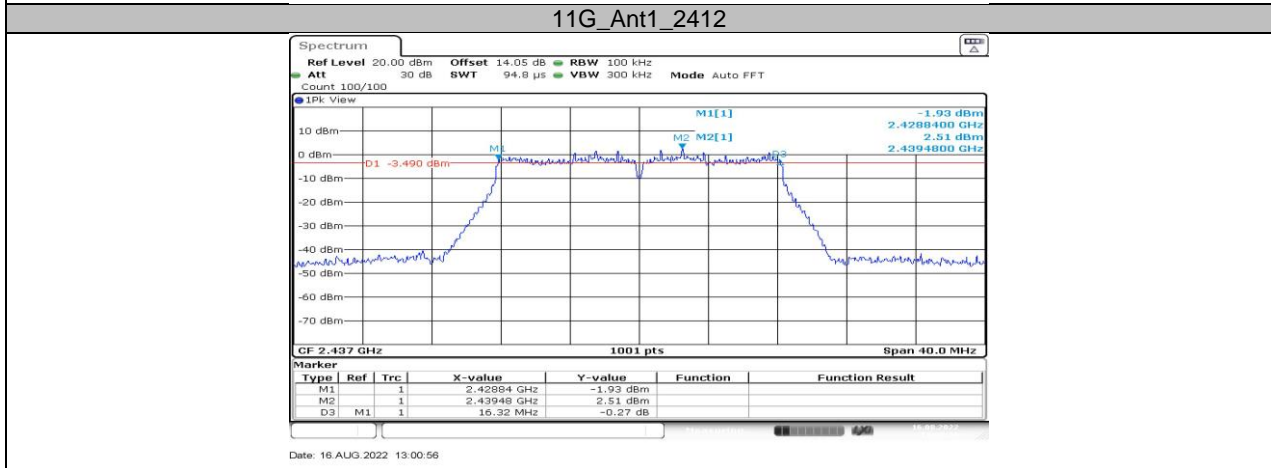
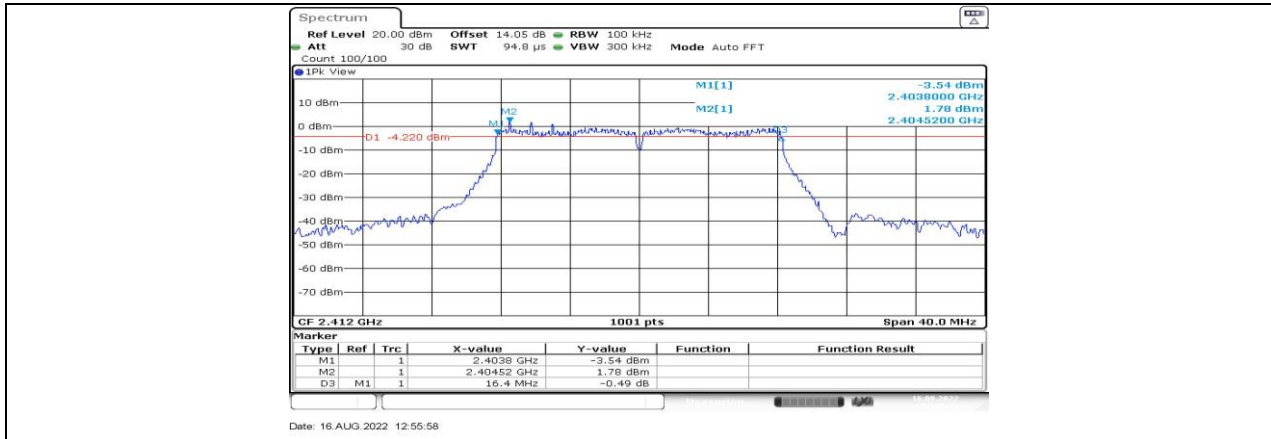

11G_Ant1_2462

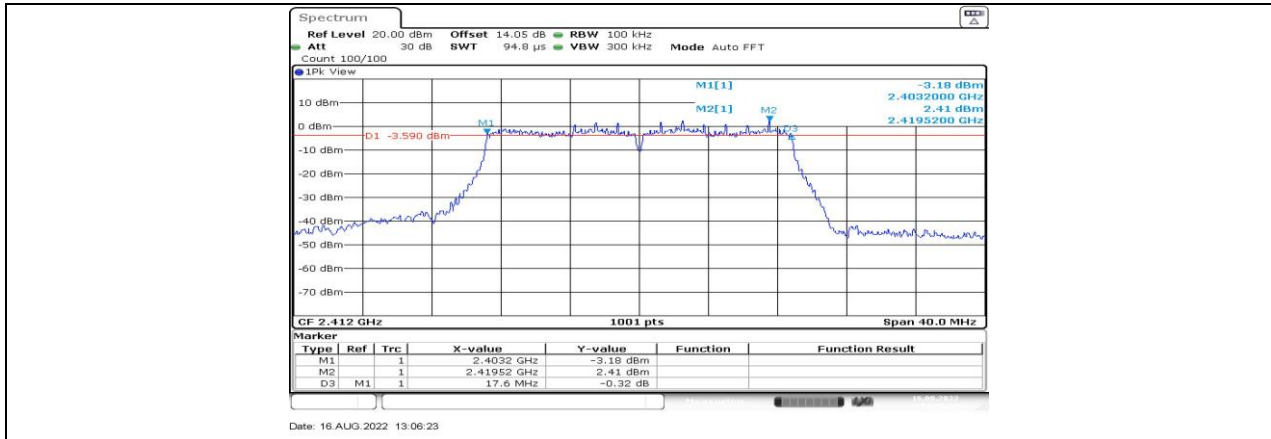

11N20SISO_Ant1_2412

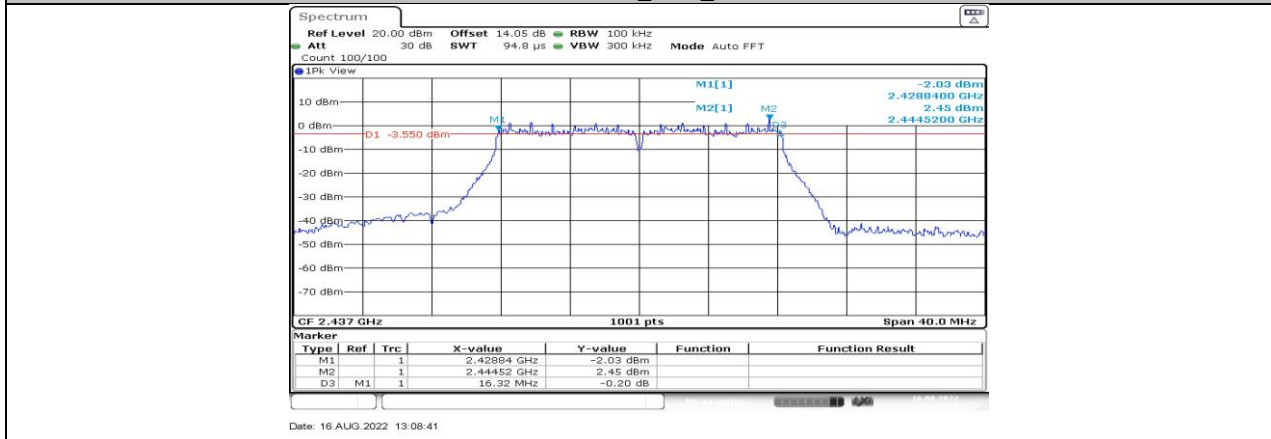

11N20SISO_Ant1_2437

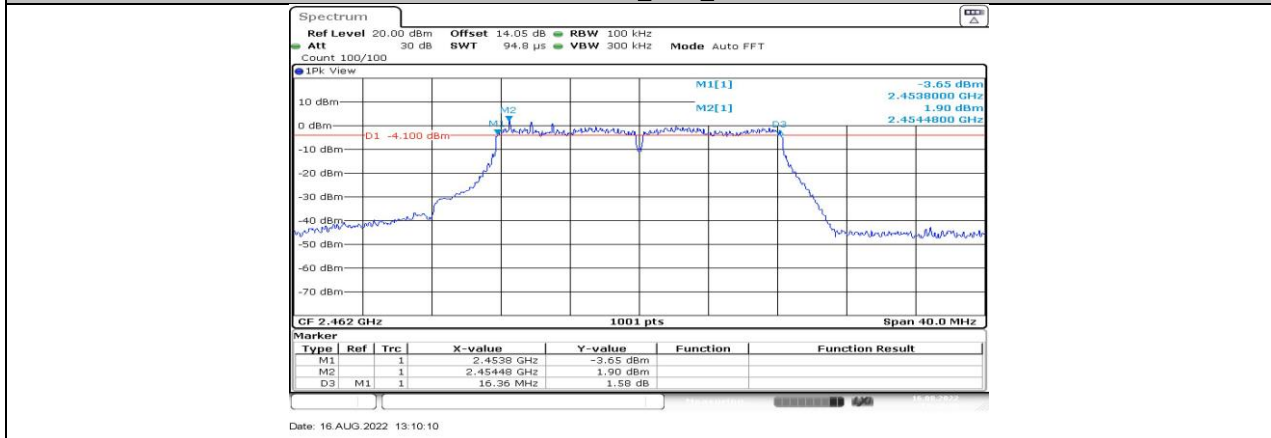

11N20SISO_Ant1_2462



11.2. APPENDIX B: OCCUPIED CHANNEL BANDWIDTH

11.2.1. Test Result

Test Mode	Antenna	Channel	OCB [MHz]	FL[MHz]	FH[MHz]	Verdict
11B	Ant1	2412	13.546	2405.247	2418.793	PASS
		2437	13.546	2430.247	2443.793	PASS
		2462	13.506	2455.247	2468.753	PASS
11G	Ant1	2412	17.303	2403.369	2420.671	PASS
		2437	17.303	2428.369	2445.671	PASS
		2462	17.303	2453.369	2470.671	PASS
11N20SISO	Ant1	2412	18.062	2403.009	2421.071	PASS
		2437	17.303	2428.329	2445.631	PASS
		2462	17.303	2453.329	2470.631	PASS

11.2.2. Test Graphs

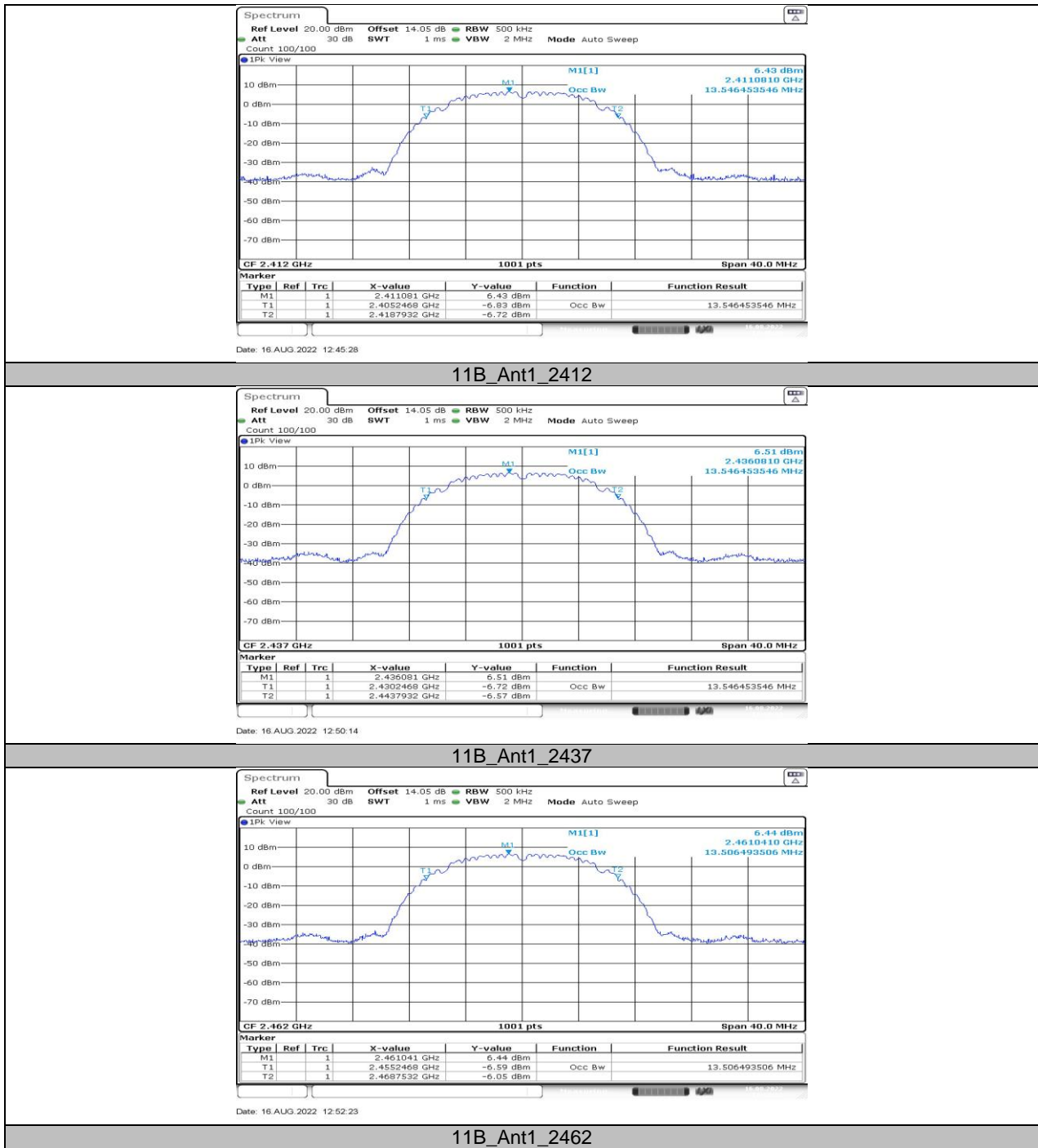

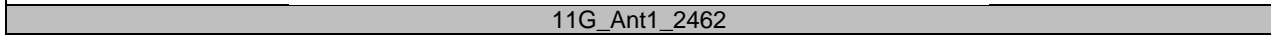
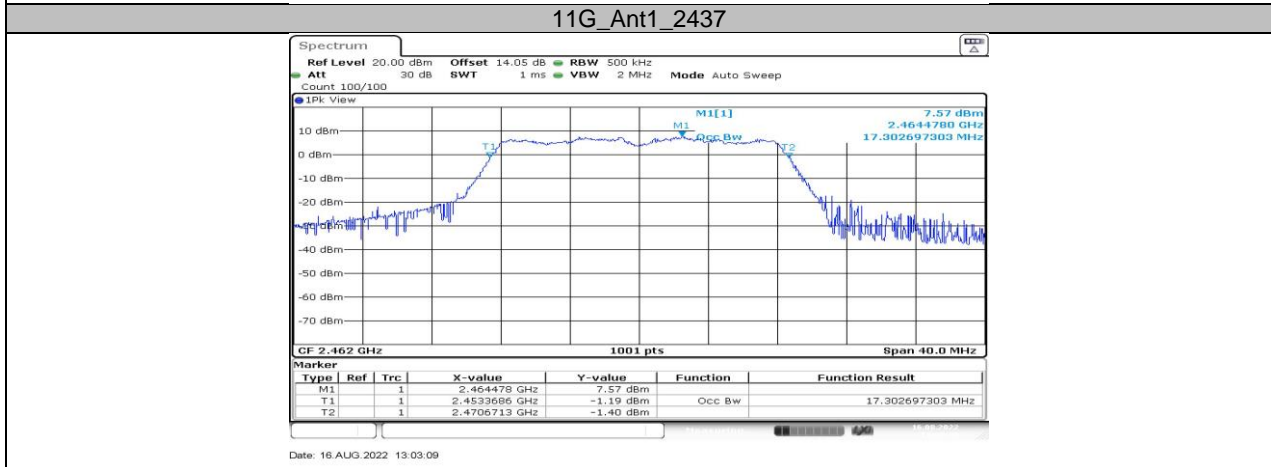
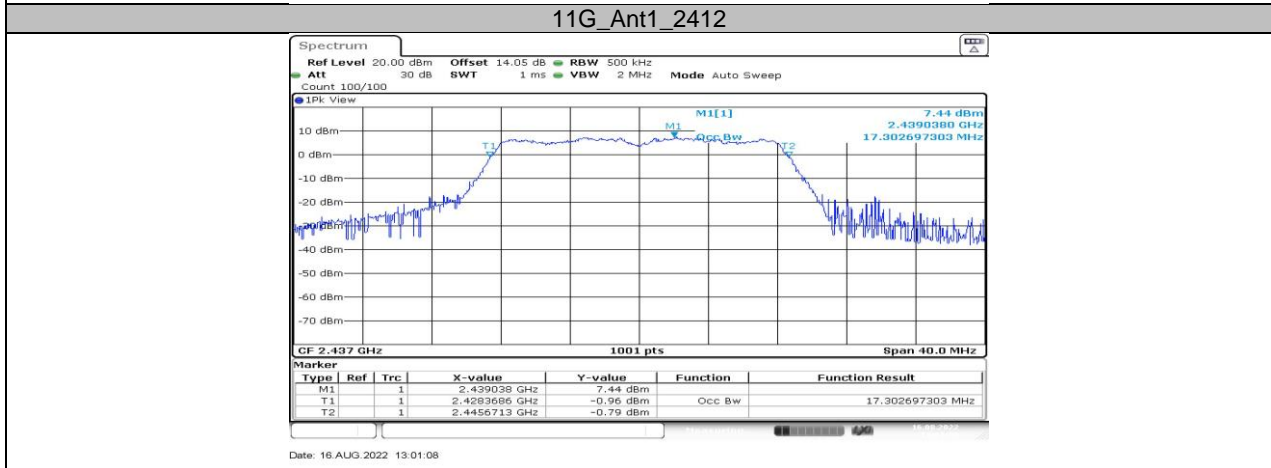
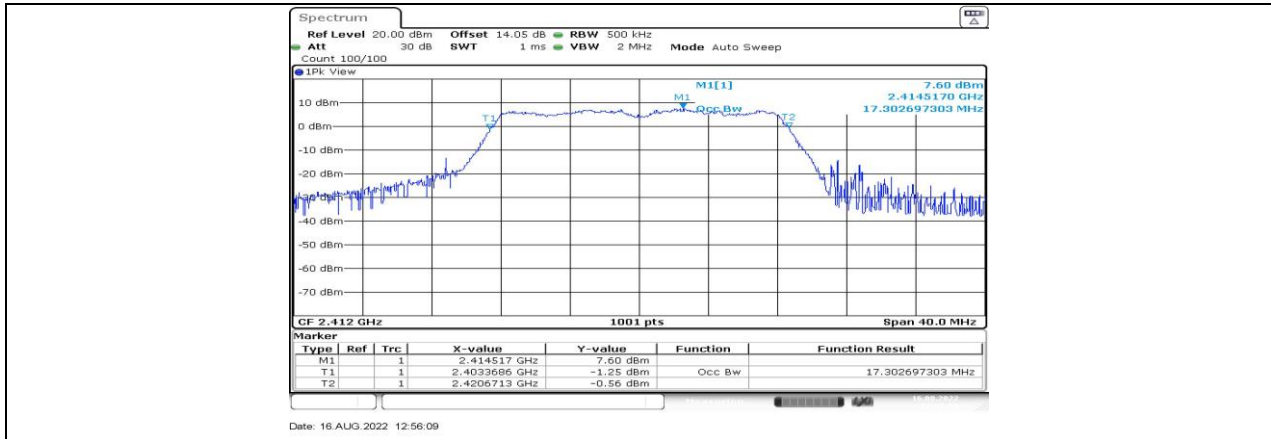

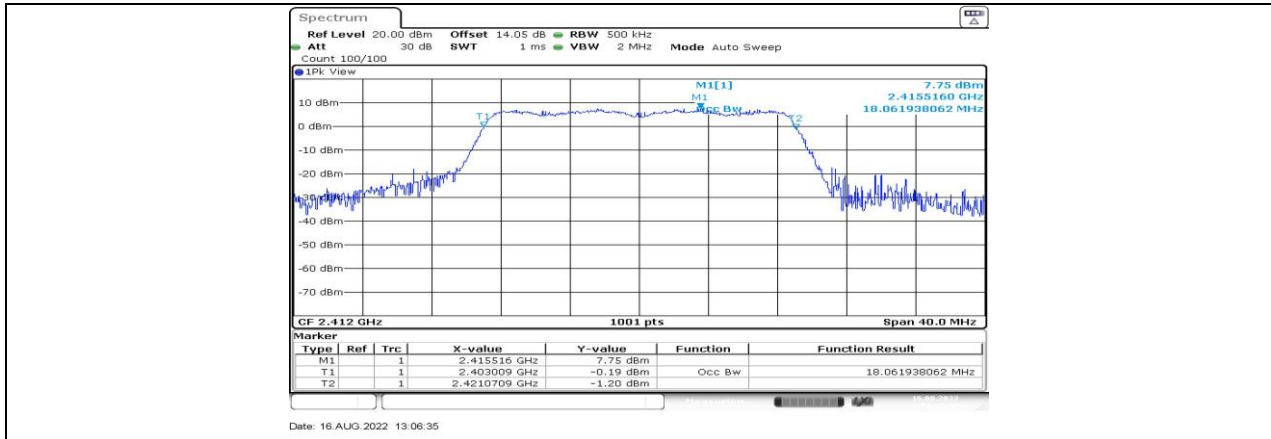

11N20SISO_Ant1_2412

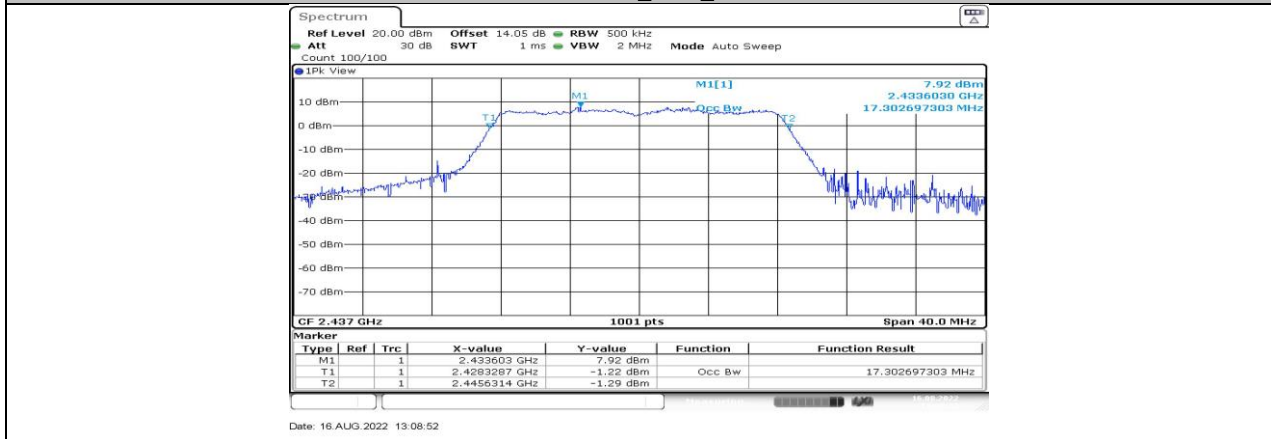

11N20SISO_Ant1_2437

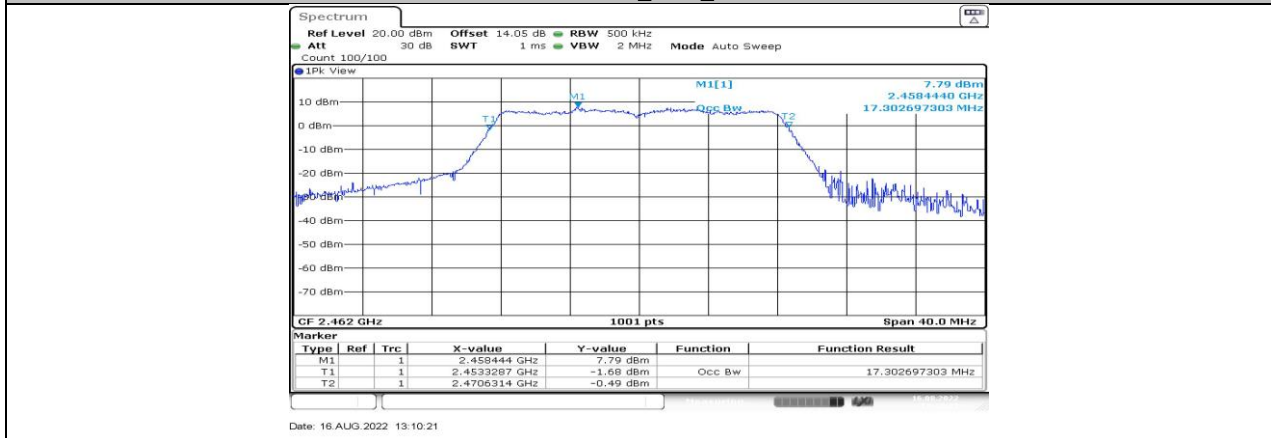

11N20SISO_Ant1_2462



11.3. APPENDIX C: MAXIMUM CONDUCTED OUTPUT POWER

11.3.1. Test Result

Test Mode	Antenna	Channel	Result[dBm]	Limit[dBm]	Verdict
11B	Ant1	2412	14.87	≤30.00	PASS
		2437	14.91	≤30.00	PASS
		2462	14.84	≤30.00	PASS
11G	Ant1	2412	12.77	≤30.00	PASS
		2437	12.82	≤30.00	PASS
		2462	12.75	≤30.00	PASS
11N20SISO	Ant1	2412	12.93	≤30.00	PASS
		2437	12.72	≤30.00	PASS
		2462	12.75	≤30.00	PASS

Note: 1. Conducted Power=Meas. Level+ Correction Factor

2. The Duty Cycle Factor (refer to section 7.5) had already compensated to the test data.



11.4. APPENDIX D: MAXIMUM POWER SPECTRAL DENSITY

11.4.1. Test Result

Test Mode	Antenna	Channel	Result[dBm/3kHz]	Limit[dBm/3kHz]	Verdict
11B	Ant1	2412	-17.02	≤8.00	PASS
		2437	-16.97	≤8.00	PASS
		2462	-17.25	≤8.00	PASS
11G	Ant1	2412	-20.2	≤8.00	PASS
		2437	-19.94	≤8.00	PASS
		2462	-20.15	≤8.00	PASS
11N20SISO	Ant1	2412	-20.38	≤8.00	PASS
		2437	-20.43	≤8.00	PASS
		2462	-20.25	≤8.00	PASS

Note: 1. The Duty Cycle Factor (refer to section 7.5) had already compensated in the test graph.

11.4.2. Test Graphs

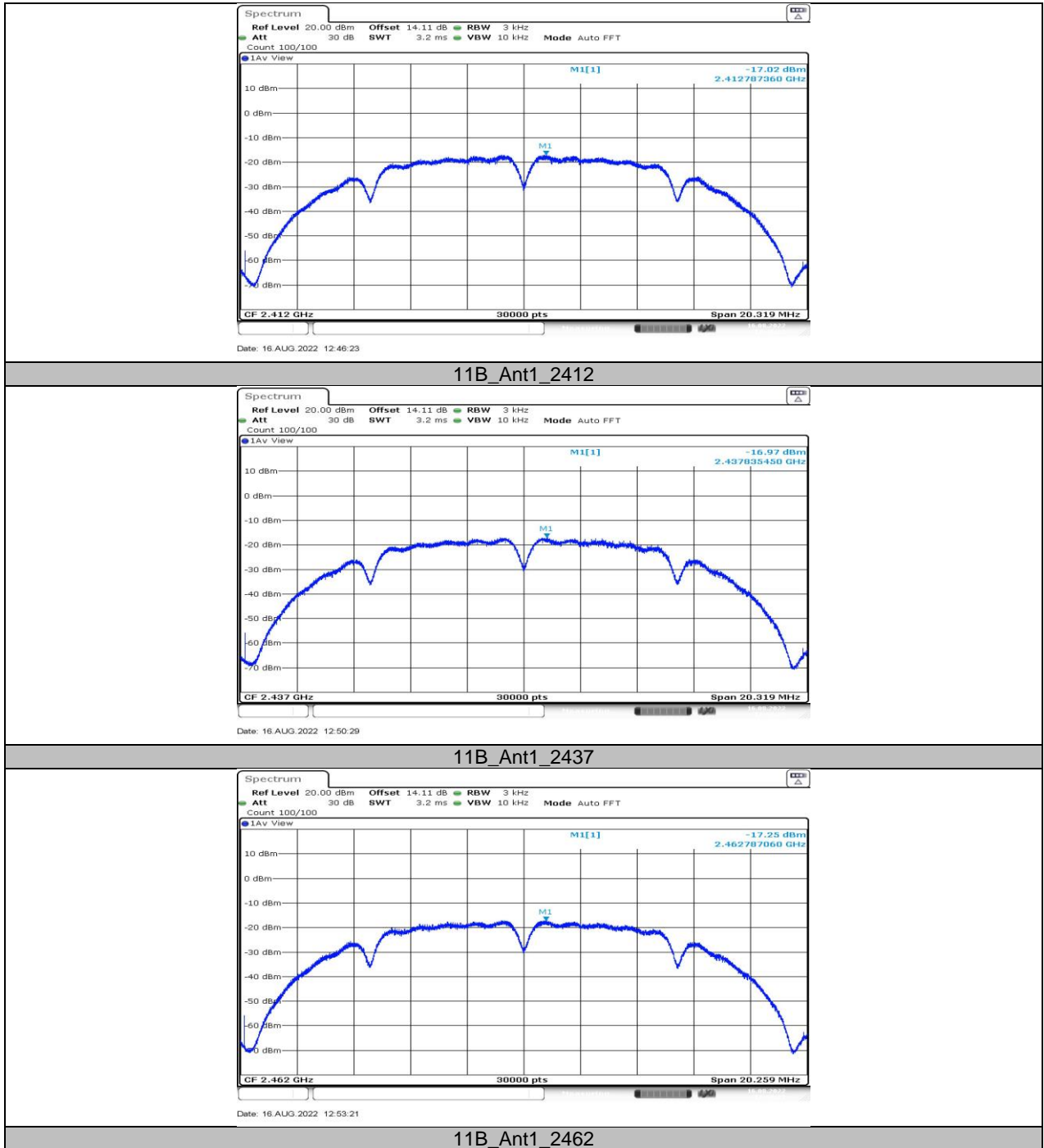

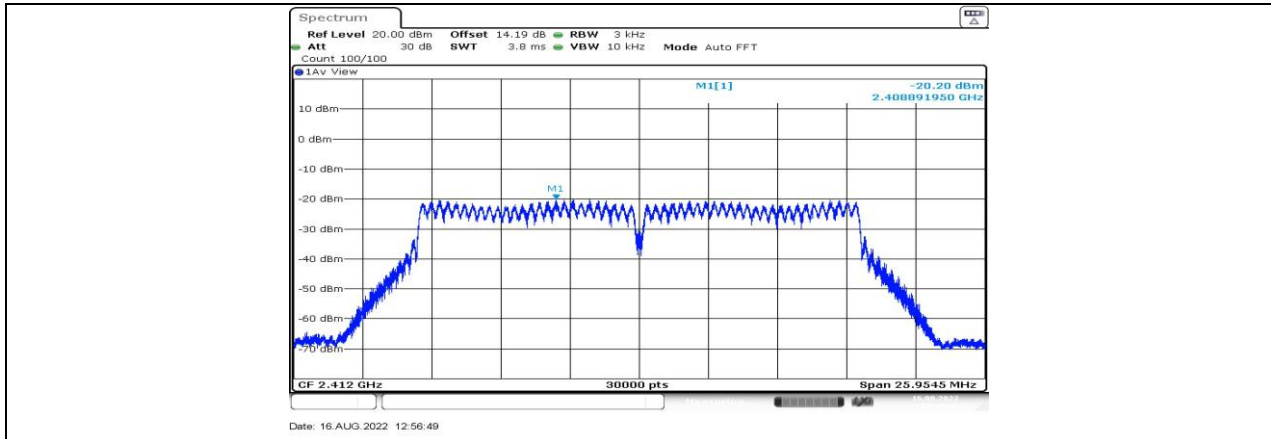

11G_Ant1_2412

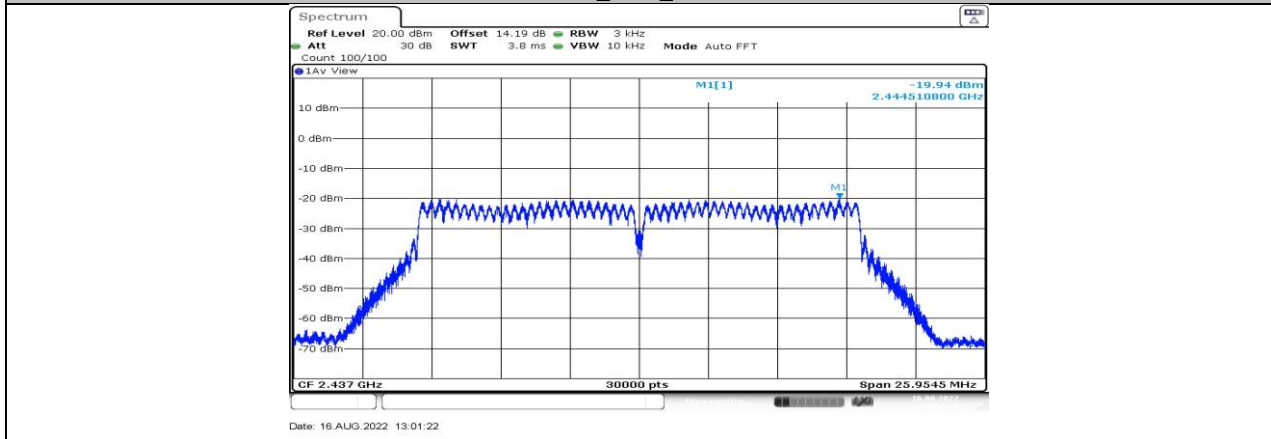

11G_Ant1_2437

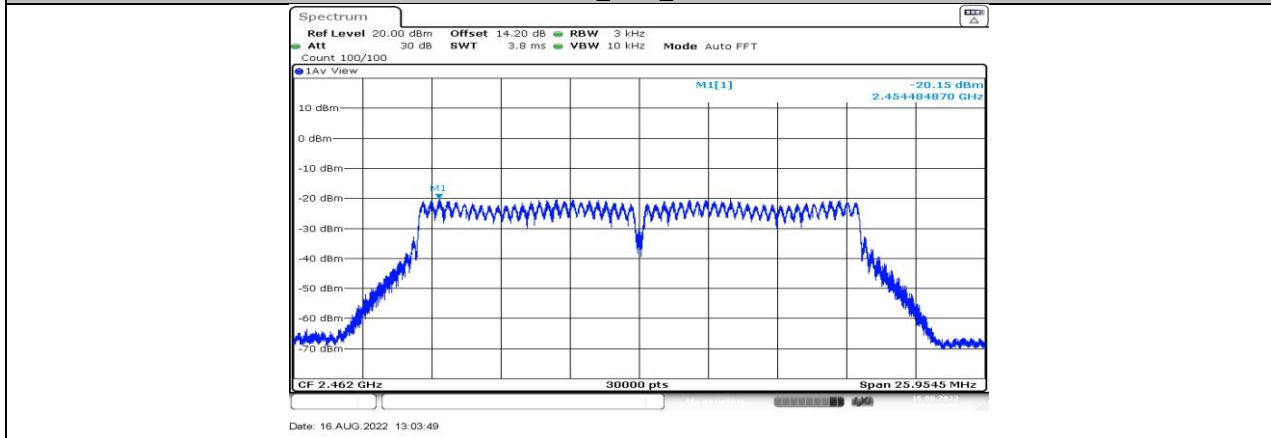

11G_Ant1_2462

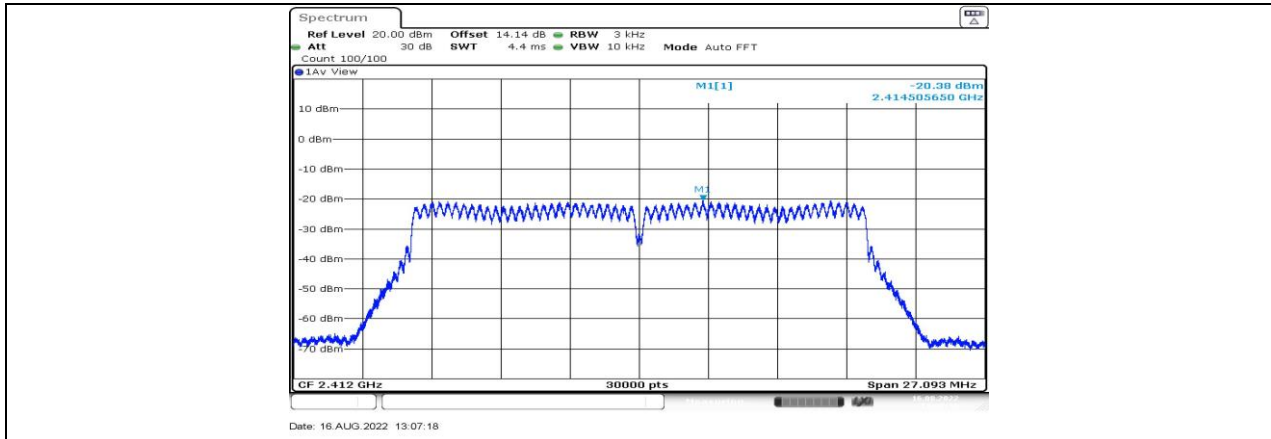

11N20SISO_Ant1_2412

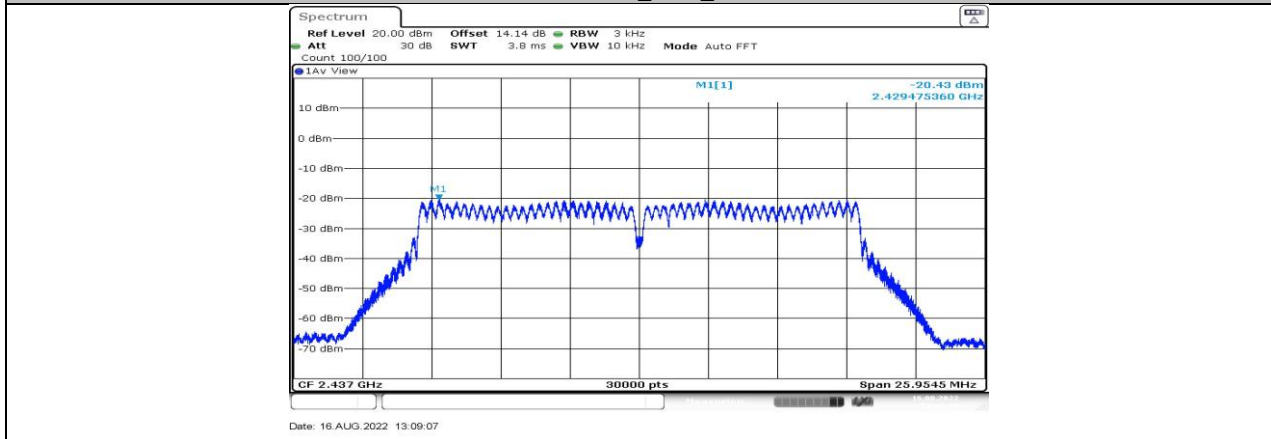

11N20SISO_Ant1_2437

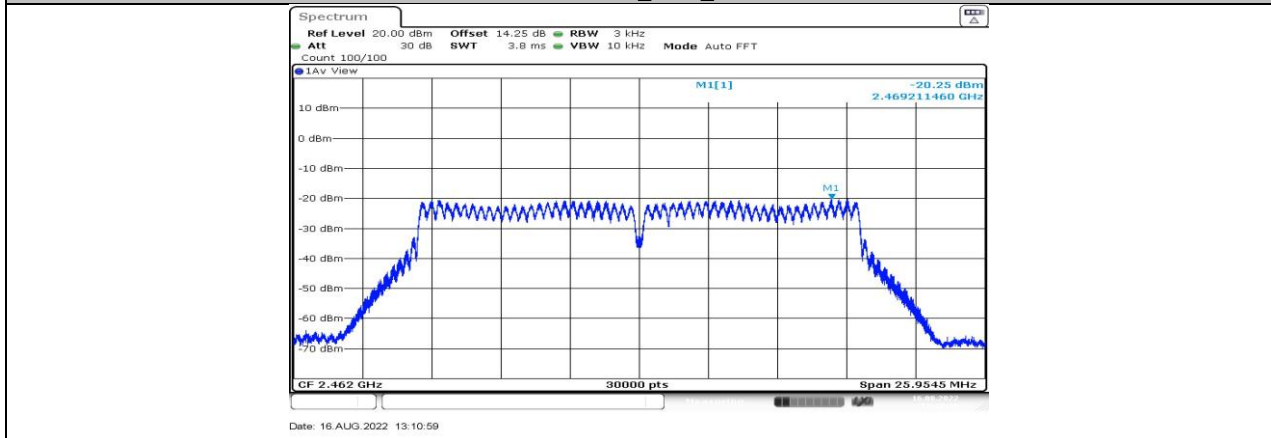

11N20SISO_Ant1_2462



11.5. APPENDIX E: BAND EDGE MEASUREMENTS

11.5.1. Test Result

Test Mode	Antenna	ChName	Channel	RefLevel[dBm]	Result[dBm]	Limit[dBm]	Verdict
11B	Ant1	Low	2412	5.09	-42.97	≤-24.91	PASS
		High	2462	5.28	-44.09	≤-24.72	PASS
11G	Ant1	Low	2412	-0.54	-37.38	≤-30.54	PASS
		High	2462	-0.60	-44.1	≤-30.6	PASS
11N20SISO	Ant1	Low	2412	0.09	-37.16	≤-29.91	PASS
		High	2462	1.88	-44.2	≤-28.12	PASS

11.5.2. Test Graphs

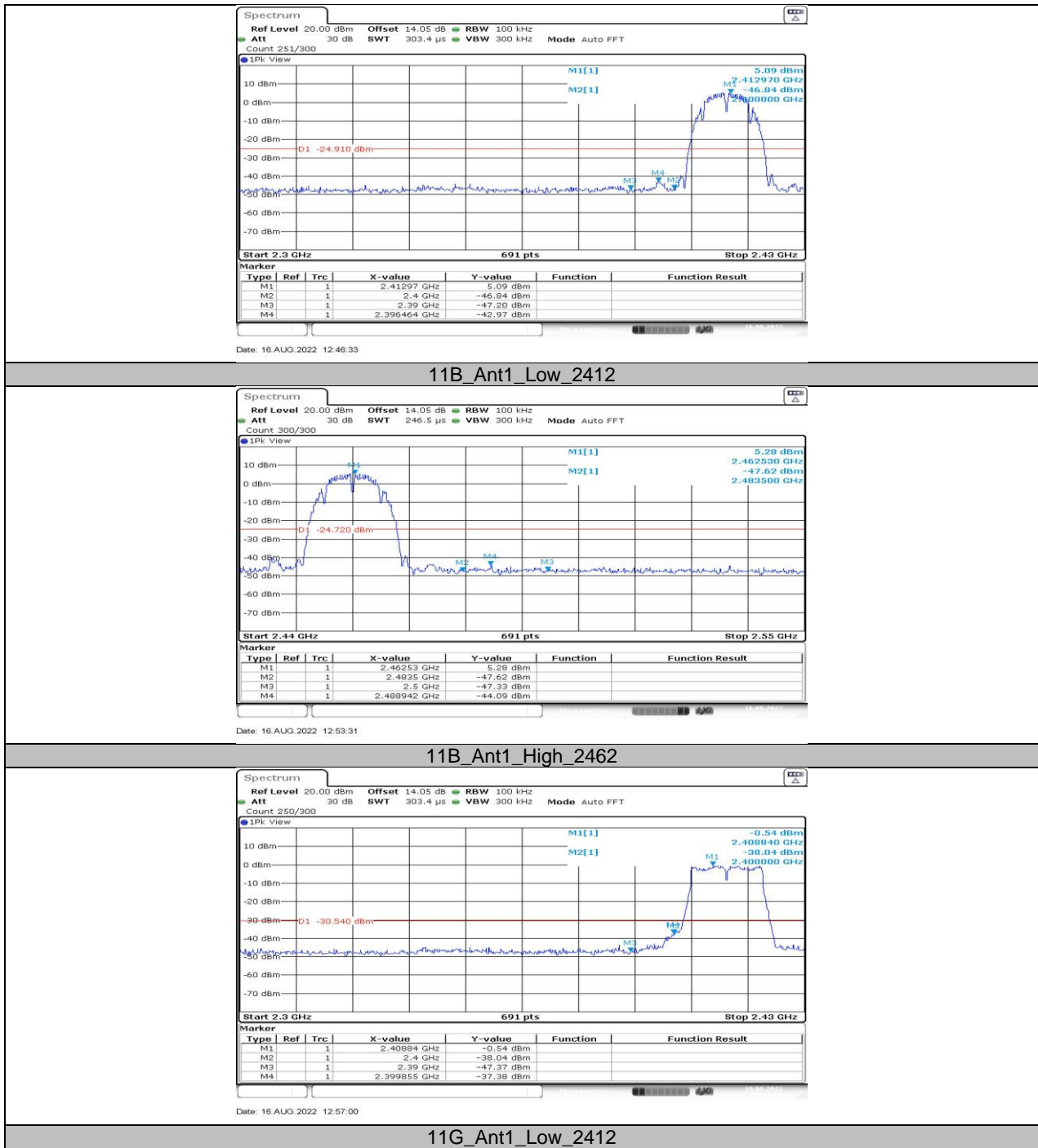

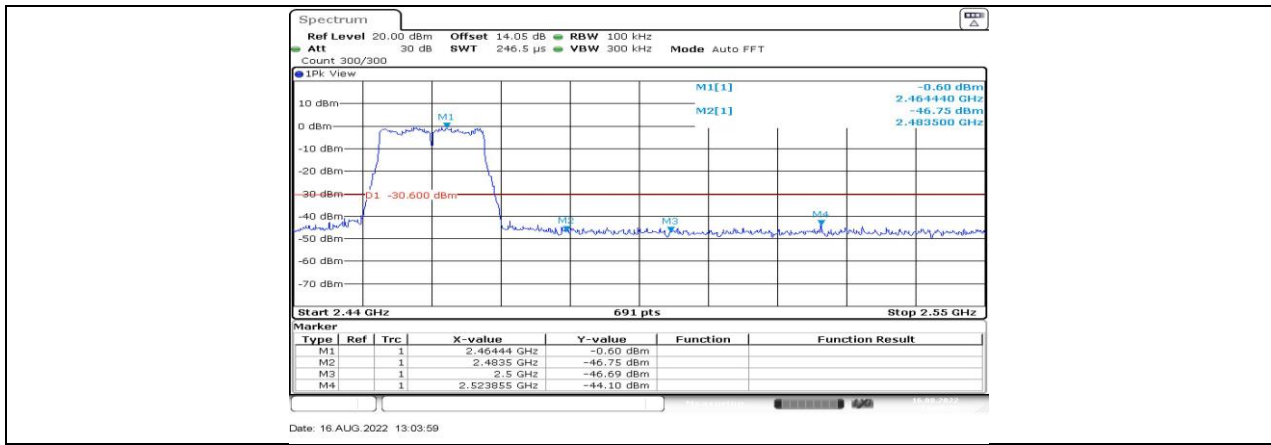

11G_Ant1_High_2462

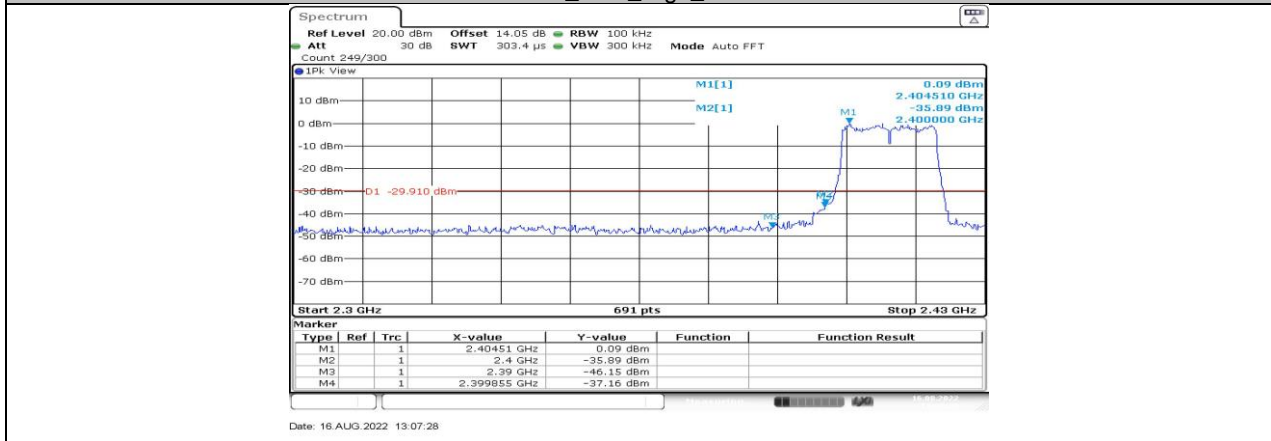

11N20SISO_Ant1_Low_2412

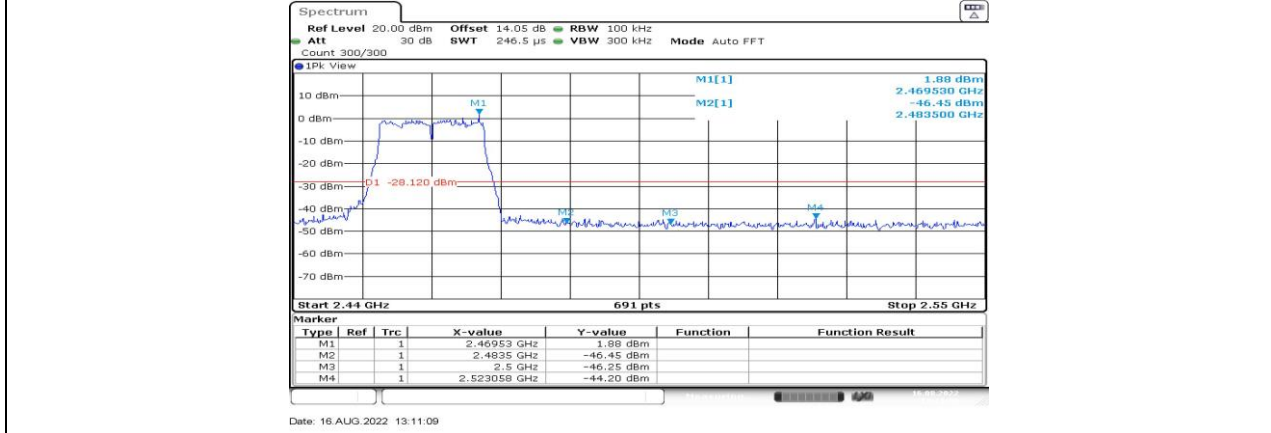

11N20SISO_Ant1_High_2462

**11.6. APPENDIX F: CONDUCTED SPURIOUS EMISSION****11.6.1. Test Result**

Test Mode	Antenna	Channel	FreqRange [Mhz]	Result [dBm]	Limit [dBm]	Verdict
11B	Ant1	2412	Reference	5.59	---	PASS
			30~1000	-53.05	≤-24.41	PASS
			1000~26500	-48.13	≤-24.41	PASS
		2437	Reference	5.96	---	PASS
			30~1000	-53.89	≤-24.04	PASS
			1000~26500	-48.01	≤-24.04	PASS
		2462	Reference	5.36	---	PASS
			30~1000	-53.33	≤-24.64	PASS
			1000~26500	-48.85	≤-24.64	PASS
11G	Ant1	2412	Reference	2.35	---	PASS
			30~1000	-53.92	≤-27.65	PASS
			1000~26500	-49.2	≤-27.65	PASS
		2437	Reference	2.42	---	PASS
			30~1000	-53.63	≤-27.58	PASS
			1000~26500	-48.22	≤-27.58	PASS
		2462	Reference	1.48	---	PASS
			30~1000	-53.74	≤-28.52	PASS
			1000~26500	-48.55	≤-28.52	PASS
11N20SISO	Ant1	2412	Reference	1.77	---	PASS
			30~1000	-52.99	≤-28.23	PASS
			1000~26500	-48.84	≤-28.23	PASS
		2437	Reference	1.95	---	PASS
			30~1000	-53.82	≤-28.05	PASS
			1000~26500	-48.79	≤-28.05	PASS
		2462	Reference	2.36	---	PASS
			30~1000	-53.47	≤-27.64	PASS
			1000~26500	-48.82	≤-27.64	PASS

11.6.2. Test Graphs

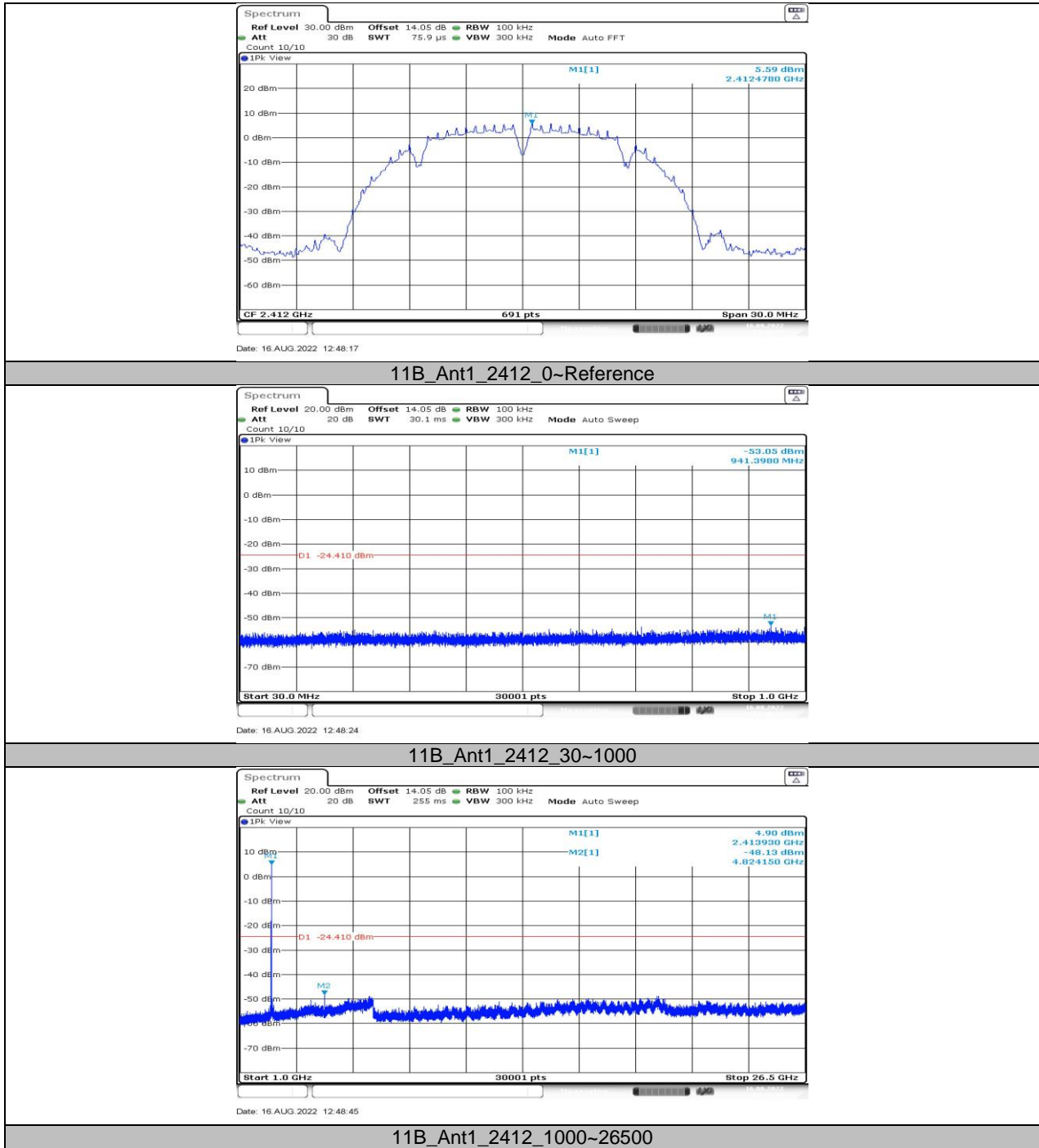

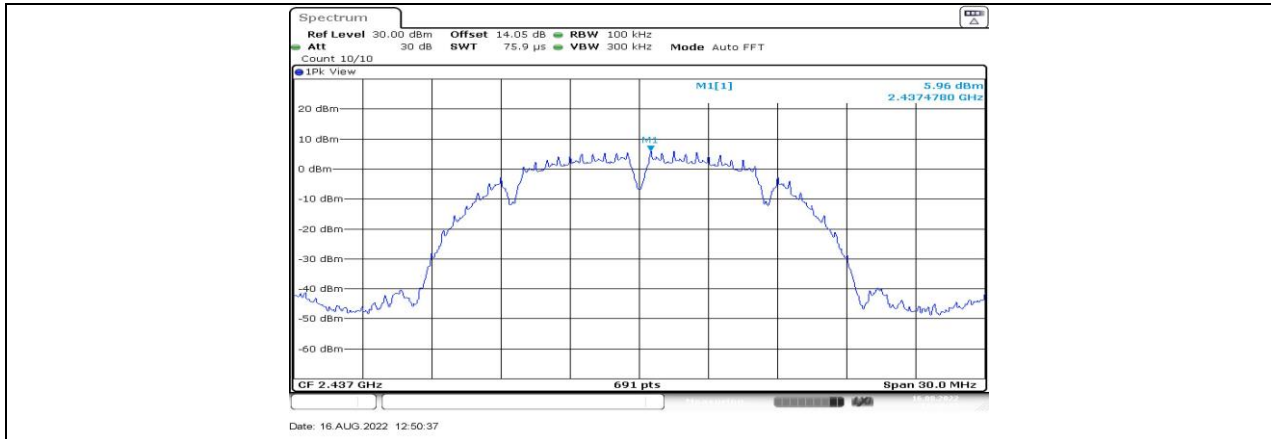

11B_Ant1_2437_0~Reference

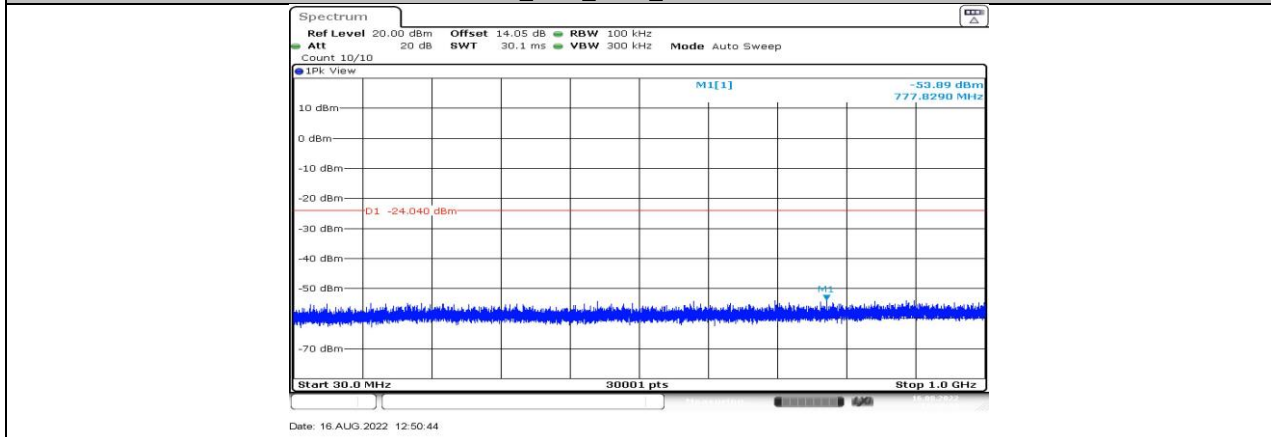

11B_Ant1_2437_30~1000

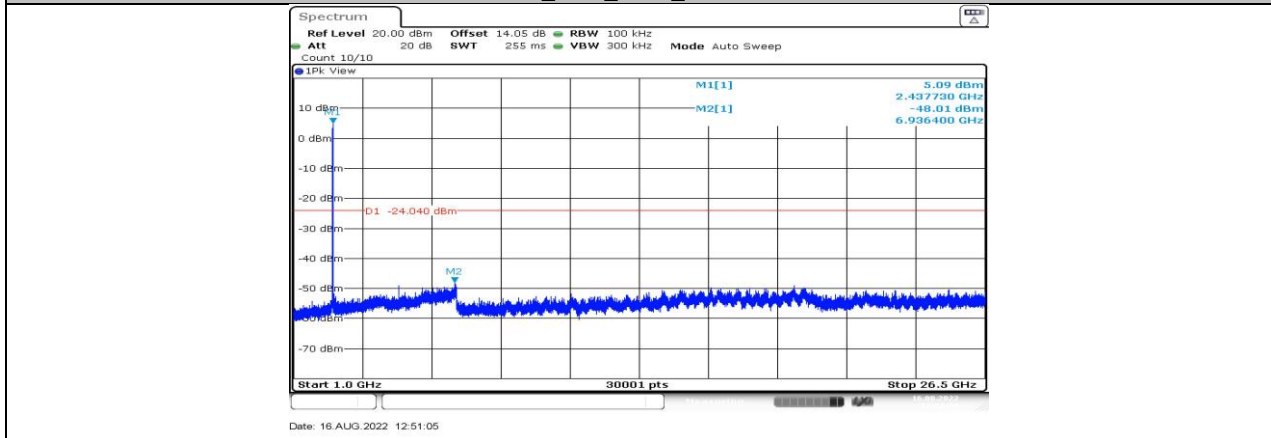

11B_Ant1_2437_1000~26500

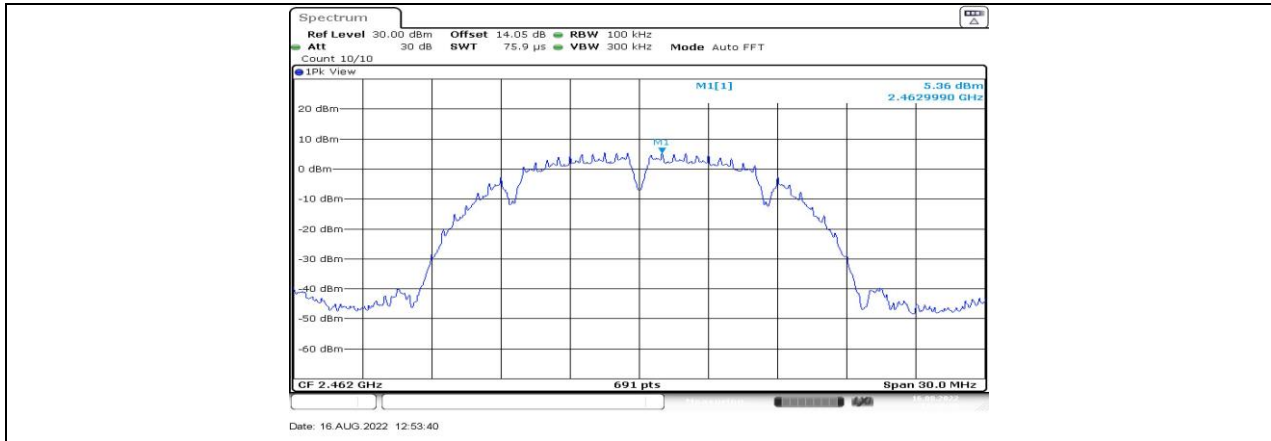

11B_Ant1_2462_0~Reference

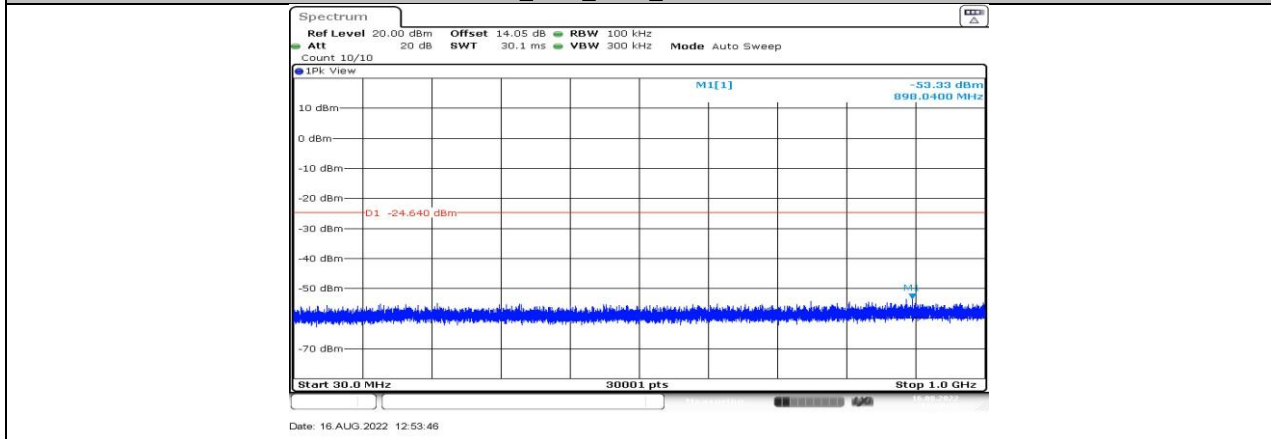

11B_Ant1_2462_30~1000

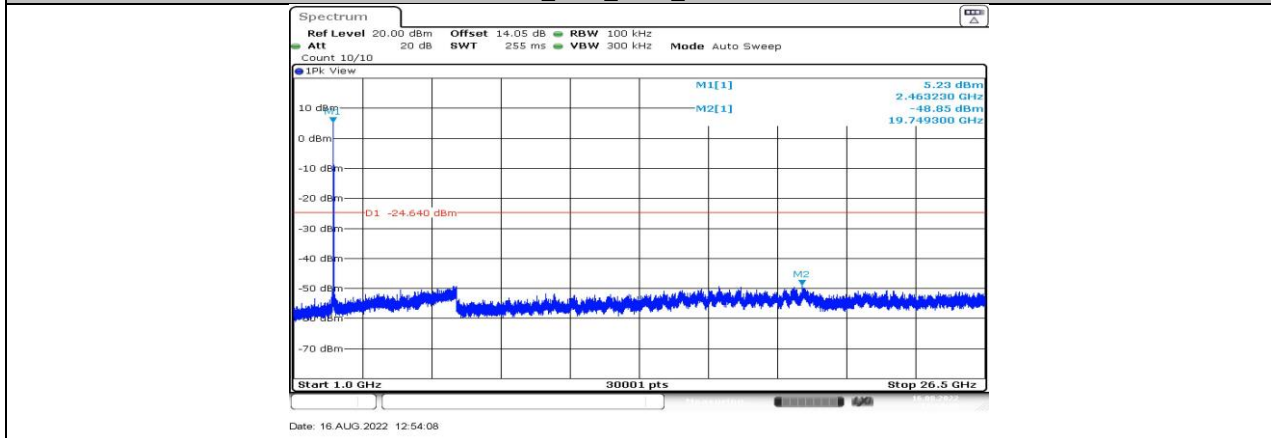

11B_Ant1_2462_1000~26500

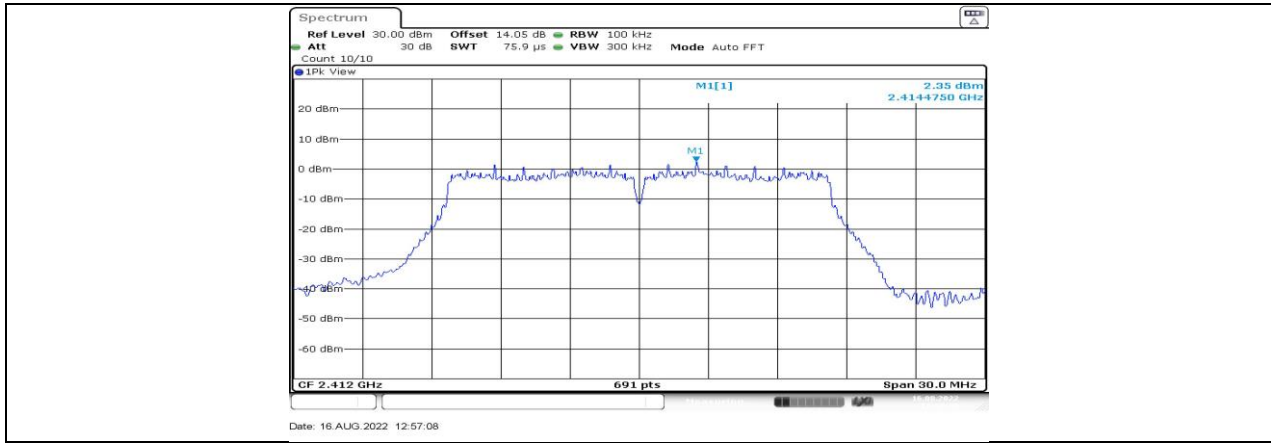

11G_Ant1_2412_0~Reference

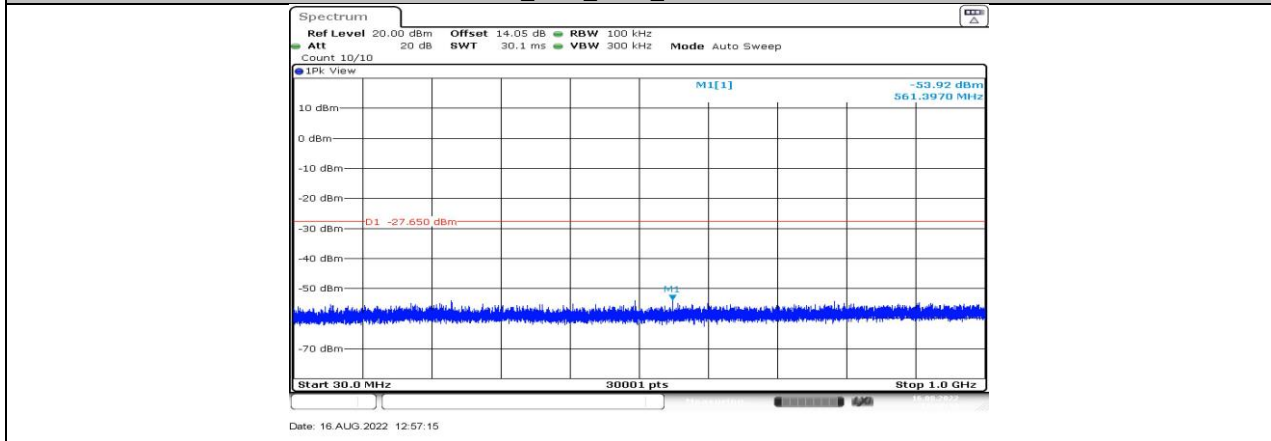

11G_Ant1_2412_30~1000

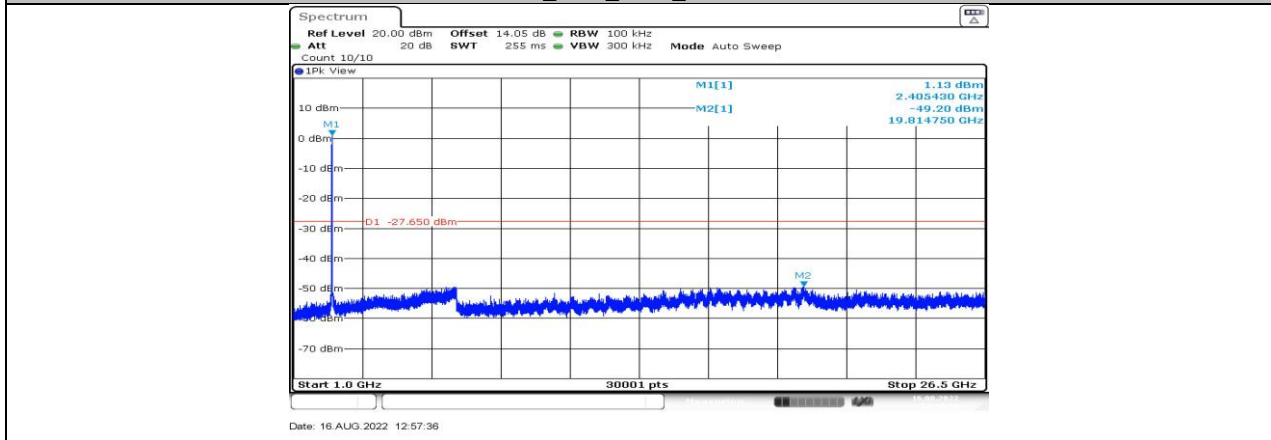

11G_Ant1_2412_1000~26500

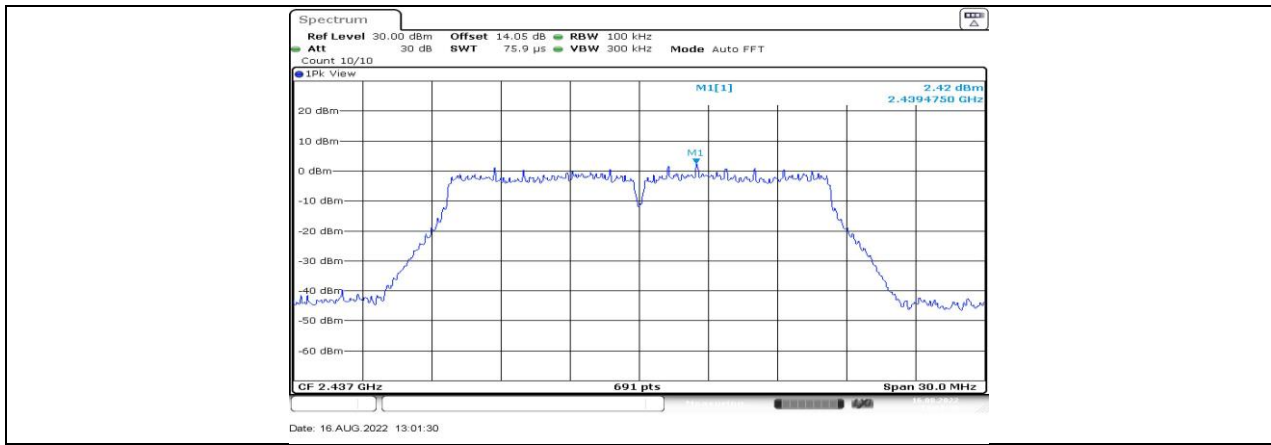

11G_Ant1_2437_0~Reference

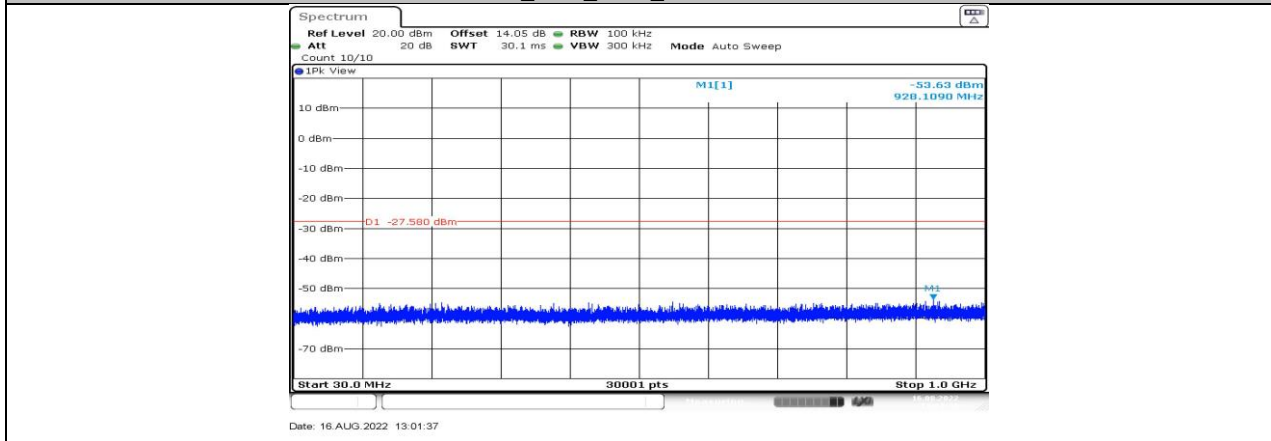

11G_Ant1_2437_30~1000

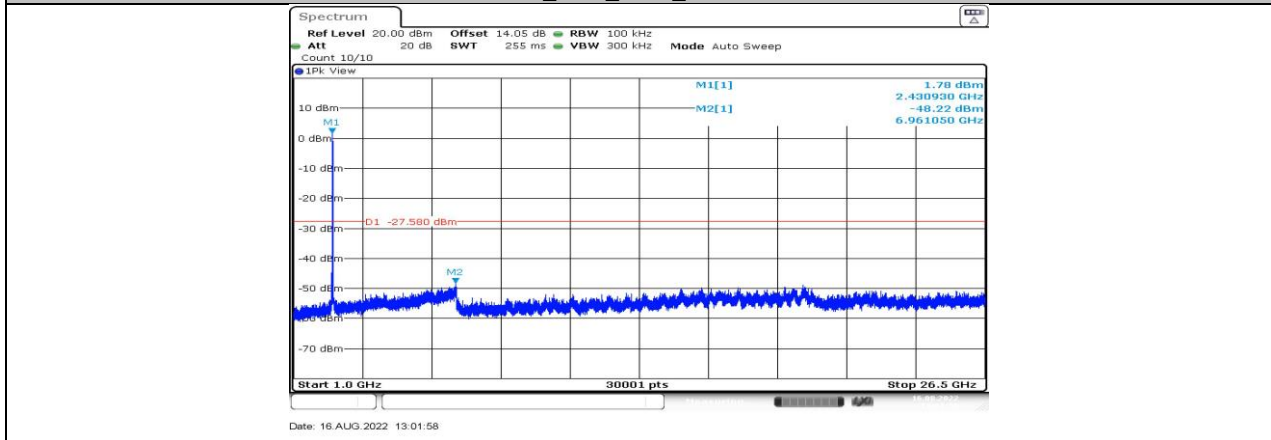

11G_Ant1_2437_1000~26500

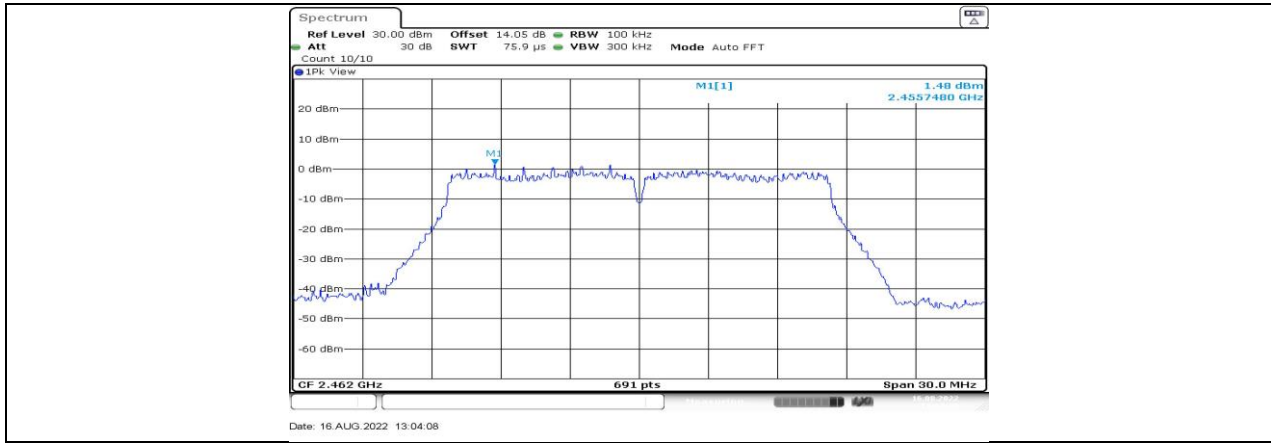

11G_Ant1_2462_0~Reference

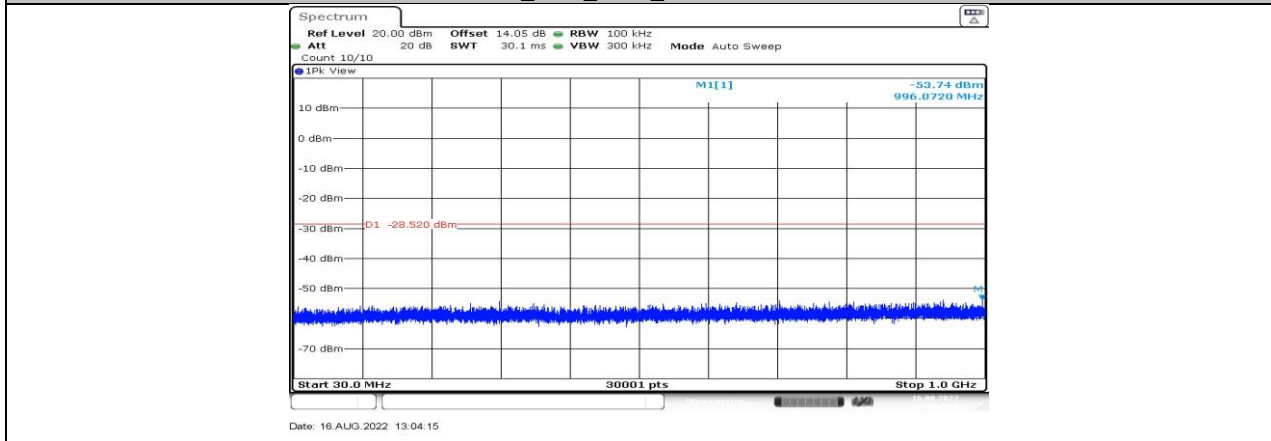

11G_Ant1_2462_30~1000

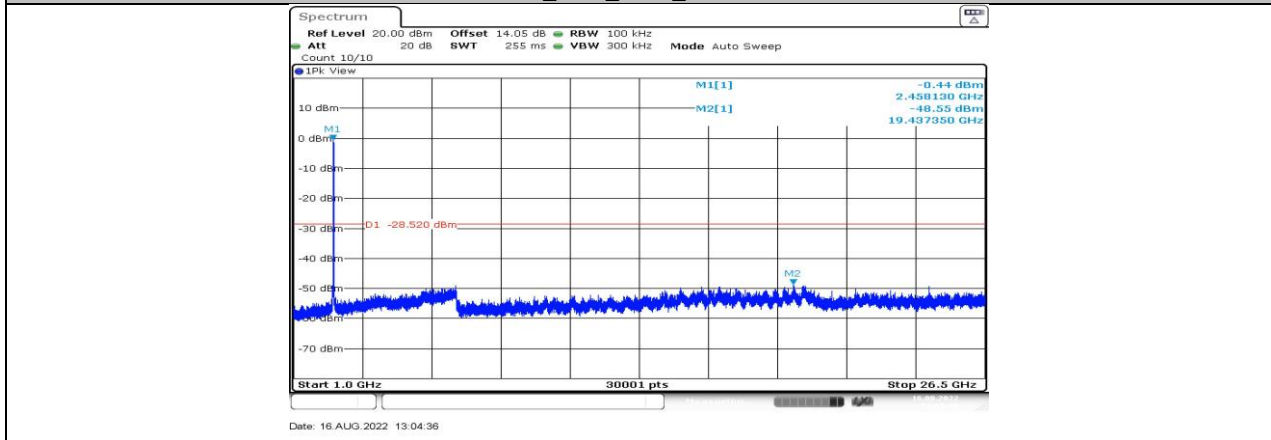

11G_Ant1_2462_1000~26500

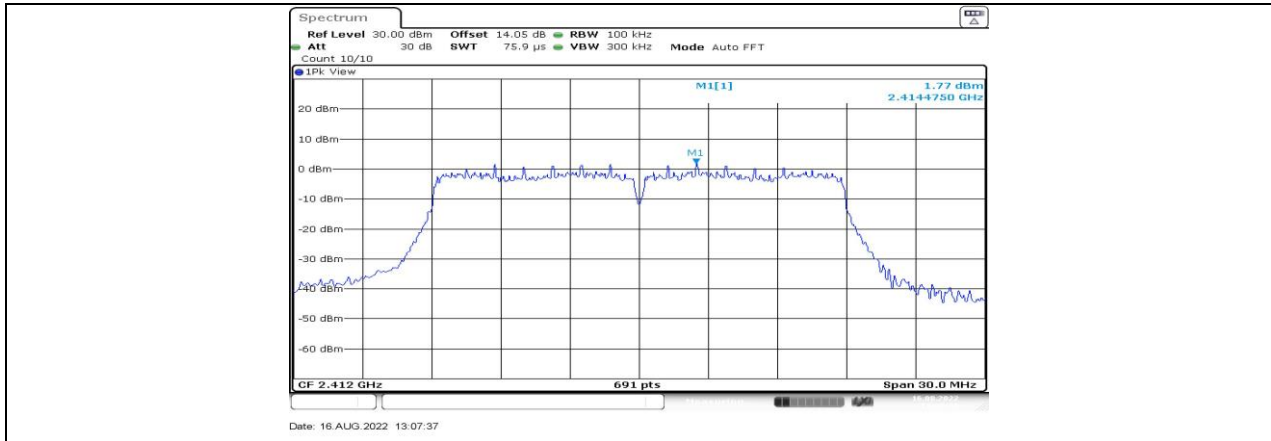

11N20SISO_Ant1_2412_0~Reference

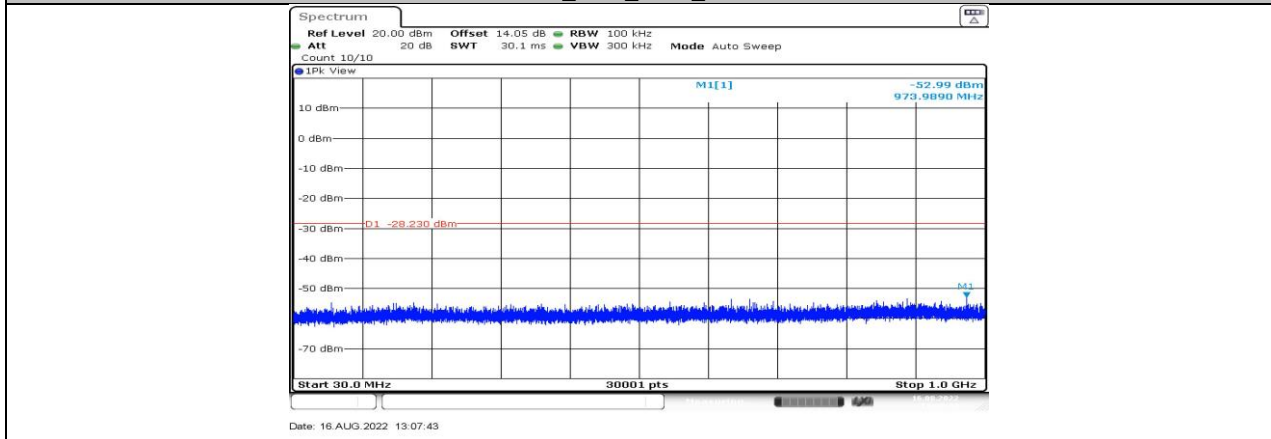

11N20SISO_Ant1_2412_30~100

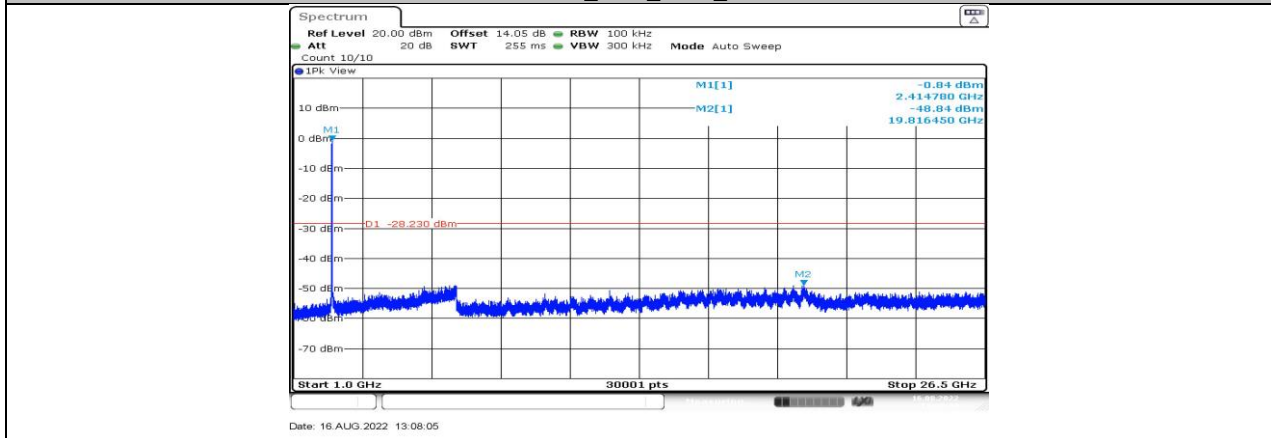

11N20SISO_Ant1_2412_1000~26500

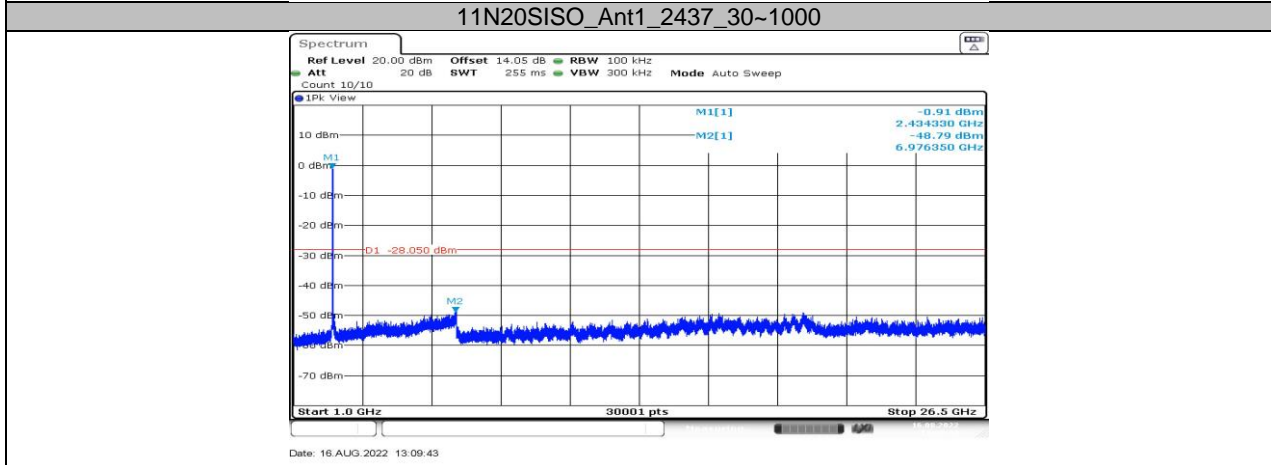
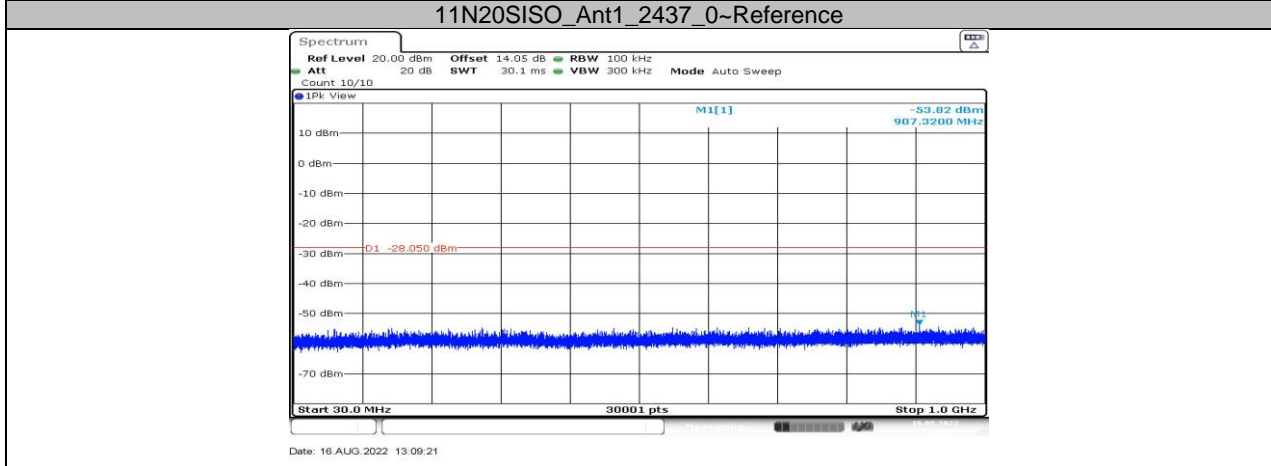
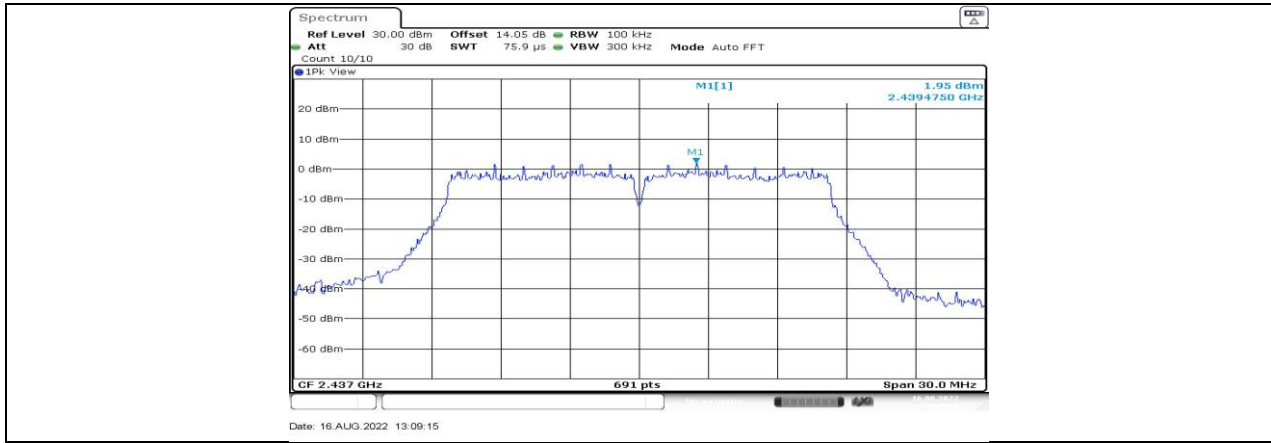

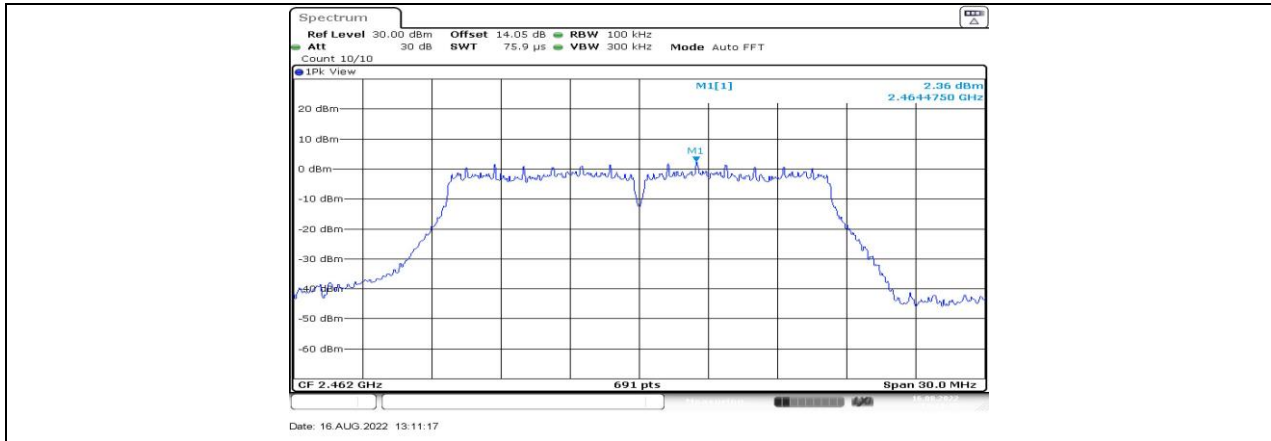

11N20SISO_Ant1_2462_0~Reference

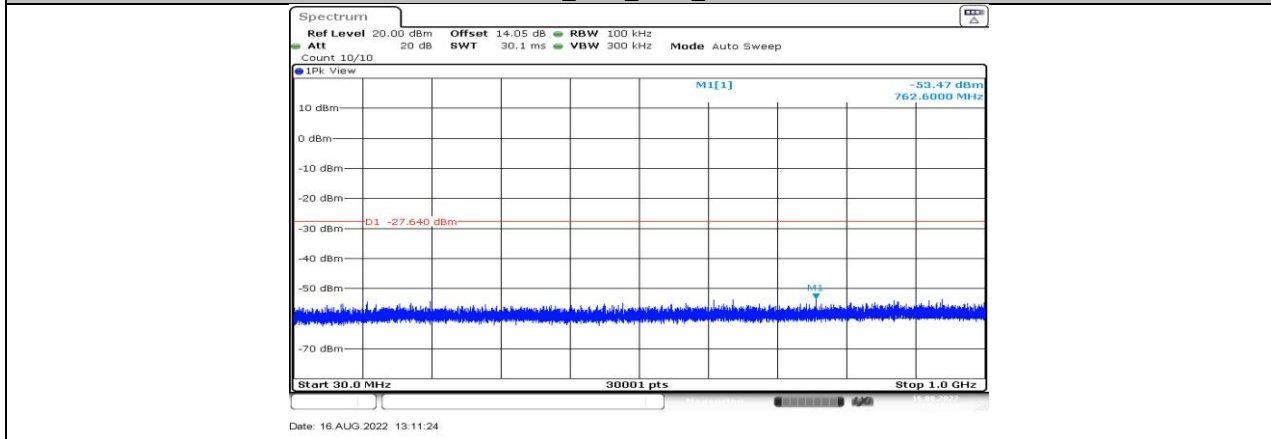

11N20SISO_Ant1_2462_30~1000

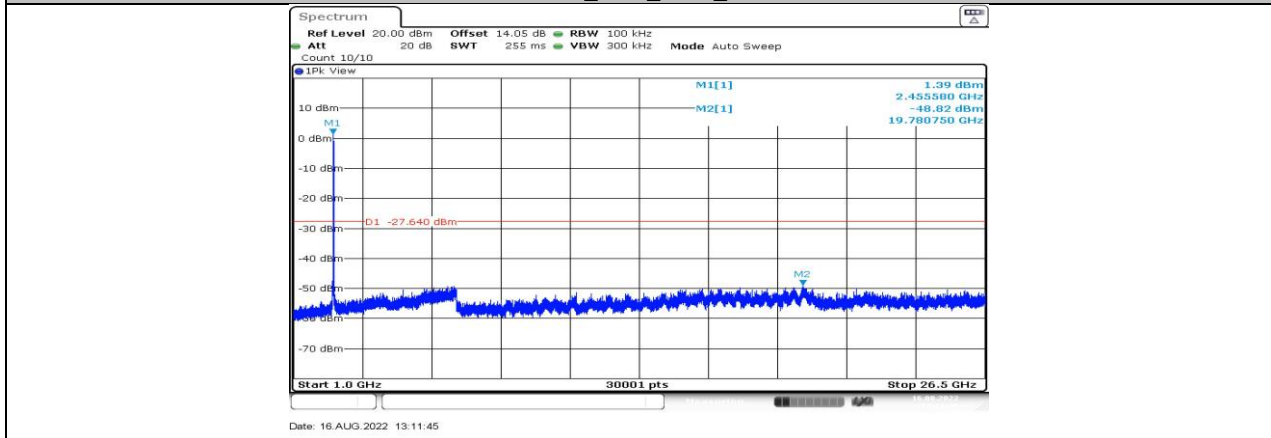

11N20SISO_Ant1_2462_1000~26500



11.7. APPENDIX G: DUTY CYCLE

11.7.1. Test Result

Test Mode	On Time (msec)	Period (msec)	Duty Cycle ^x (Linear)	Duty Cycle (%)	Duty Cycle Correction Factor (dB)	1/T Minimum VBW (kHz)	Final setting For VBW (kHz)
11B	8.36	8.47	0.9870	98.70	0.06	NA	0.01
11G	3.08	3.18	0.9686	96.86	0.14	0.32	0.5
11N20SISO	4.74	4.84	0.9793	97.93	0.09	0.21	0.5

Note:

Duty Cycle Correction Factor=10log (1/x).

Where: x is Duty Cycle (Linear)

Where: T is On Time

If that calculated VBW is not available on the analyzer then the next higher value should be used.

If the EUT is configured to transmit with duty cycle $\geq 98\%$, set VBW \leq RBW/100 (i.e., 10 kHz) but not less than 10 Hz.



11.7.2. Test Graphs

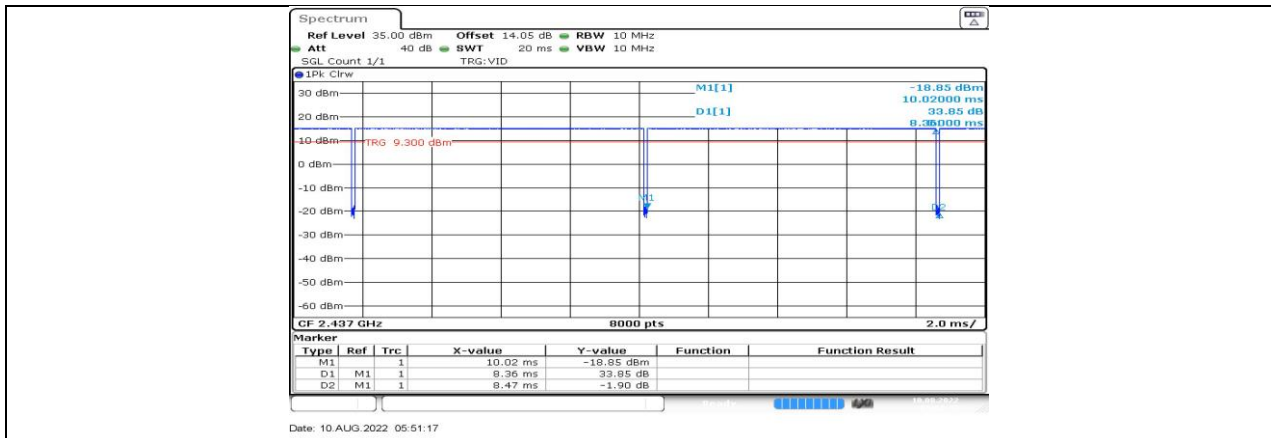

11B_Ant1_2437

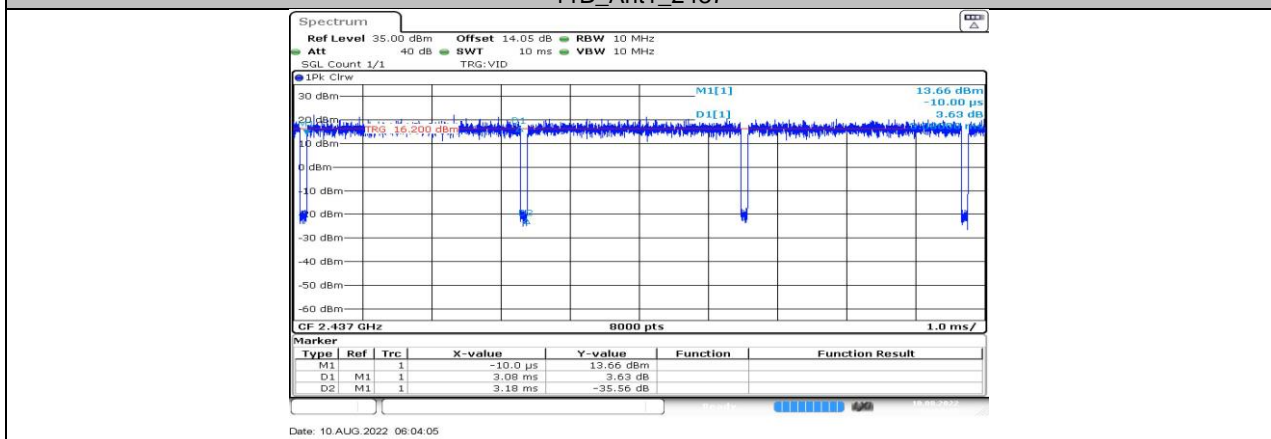

11G_Ant1_2437

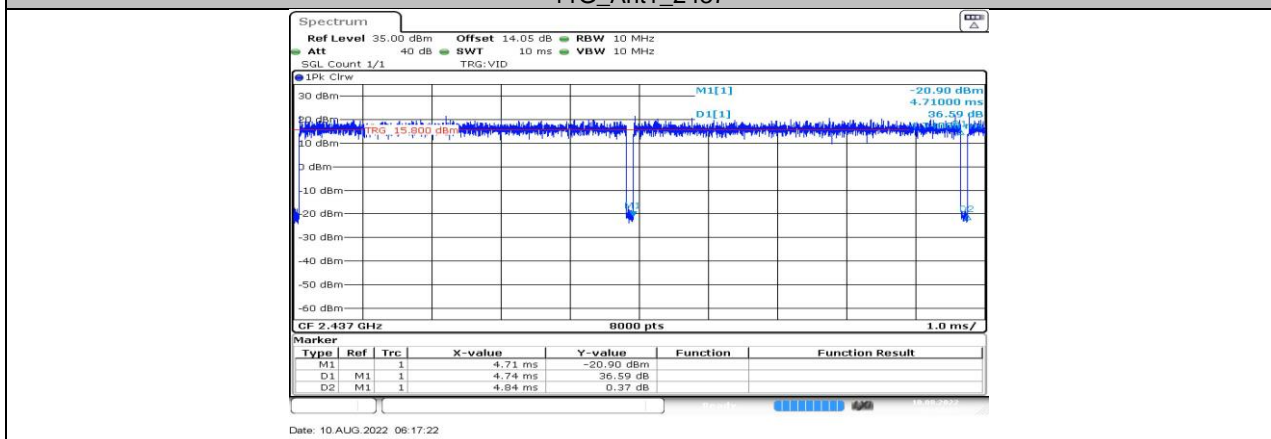

11N20SISO_Ant1_2437

END OF REPORT