



**CFR 47 FCC PART 15 SUBPART C  
ISED RSS-247 ISSUE 2**

**TEST REPORT**

*For*

**Two Way Portable Radio R7**

**MODEL NUMBER: AAH06UCN9RB1AN (IC Model: PMUF2000ABB)**

**REPORT NUMBER: 4790494290-1-RF-1**

**ISSUE DATE: August 24, 2022**

**FCC ID: AZ489FT7169**

**IC: 109U-89FT7169**

*Prepared for*

**Motorola Solutions, Inc.**

**8000, West Sunrise Blvd., Ft Lauderdale, Florida 33322, United States**

*Prepared by*

**UL Verification Services (Guangzhou) Co., Ltd, Song Shan Lake Branch**

**Building 10, Innovation Technology Park, No. 1, Li Bin Road, Song Shan Lake Hi-Tech Development Zone Dongguan, 523808, People's Republic of China**

**Tel: +86 769 22038881**

**Fax: +86 769 33244054**

**Website: [www.ul.com](http://www.ul.com)**

The results reported herein have been performed in accordance with the laboratory's terms of accreditation. This report shall not be reproduced except in full without the written approval of the Laboratory. The results in this report apply to the test sample(s) mentioned above at the time of the testing period only and are not to be used to indicate applicability to other similar products.



Revision History

<u>Rev.</u>	<u>Issue Date</u>	<u>Revisions</u>	<u>Revised By</u>
<u>V0</u>	<u>August 24, 2022</u>	<u>Initial Issue</u>	<u></u>



### Summary of Test Results

Test Item	Clause	Limit/Requirement	Result
Antenna Requirement	N/A	FCC Part 15.203/15.247 (c) RSS-GEN Clause 6.8	Pass
AC Power Line Conducted Emission	ANSI C63.10-2013, Clause 6.2	FCC Part 15.207 RSS-GEN Clause 8.8	Pass
Conducted Output Power	ANSI C63.10-2013, Clause 11.9.1.3	FCC Part 15.247 (b)(3) RSS-247 Clause 5.4 (d)	Pass
6dB Bandwidth and 99% Occupied Bandwidth	ANSI C63.10-2013, Clause 11.8.1	FCC Part 15.247 (a)(2) RSS-247 Clause 5.2 (a) ISED RSS-Gen Clause 6.7	Pass
Power Spectral Density	ANSI C63.10-2013, Clause 11.10.2	FCC Part 15.247 (e) RSS-247 Clause 5.2 (b)	Pass
Conducted Band edge and spurious emission	ANSI C63.10-2013, Clause 11.11	FCC Part 15.247(d) RSS-247 Clause 5.5	Pass
Duty Cycle	ANSI C63.10-2013, Clause 11.6	None; for reporting purposes only.	Pass

\*This test report is only published to and used by the applicant, and it is not for evidence purpose in China.

\*The measurement result for the sample received is <Pass> according to <CFR 47 FCC PART 15 SUBPART C><ISED RSS-247 ISSUE 2> when <Accuracy Method> decision rule is applied.

## CONTENTS

<b>1. ATTESTATION OF TEST RESULTS</b> .....	<b>6</b>
<b>2. TEST METHODOLOGY</b> .....	<b>7</b>
<b>3. FACILITIES AND ACCREDITATION</b> .....	<b>7</b>
<b>4. CALIBRATION AND UNCERTAINTY</b> .....	<b>8</b>
4.1. <i>MEASURING INSTRUMENT CALIBRATION</i> .....	8
4.2. <i>MEASUREMENT UNCERTAINTY</i> .....	8
<b>5. EQUIPMENT UNDER TEST</b> .....	<b>9</b>
5.1. <i>DESCRIPTION OF EUT</i> .....	9
5.2. <i>CHANNEL LIST</i> .....	9
5.3. <i>MAXIMUM EIRP</i> .....	9
5.4. <i>TEST CHANNEL CONFIGURATION</i> .....	10
5.5. <i>THE WORSE CASE POWER SETTING PARAMETER</i> .....	10
5.6. <i>DESCRIPTION OF AVAILABLE ANTENNAS</i> .....	10
5.7. <i>SUPPORT UNITS FOR SYSTEM TEST</i> .....	11
5.8. <i>SETUP DIAGRAM</i> .....	12
<b>6. MEASURING EQUIPMENT AND SOFTWARE USED</b> .....	<b>13</b>
<b>7. ANTENNA PORT TEST RESULTS</b> .....	<b>16</b>
7.1. <i>CONDUCTED OUTPUT POWER</i> .....	16
7.2. <i>6DB BANDWIDTH AND 99% OCCUPIED BANDWIDTH</i> .....	17
7.3. <i>POWER SPECTRAL DENSITY</i> .....	19
7.4. <i>CONDUCTED BAND EDGE AND SPURIOUS EMISSION</i> .....	20
7.5. <i>DUTY CYCLE</i> .....	22
<b>8. RADIATED TEST RESULTS</b> .....	<b>23</b>
8.1. <i>RESTRICTED BANDEDGE</i> .....	31
8.2. <i>RESTRICTED BANDEDGE WITH CHARGING WORST CASE</i> .....	38
8.3. <i>SPURIOUS EMISSIONS(1 GHZ~3 GHZ)</i> .....	40
8.4. <i>SPURIOUS EMISSIONS WITH CHARGING WORST CASE(1 GHZ~3 GHZ)</i> .....	46
8.5. <i>SPURIOUS EMISSIONS(3 GHZ~18 GHZ)</i> .....	48
8.6. <i>SPURIOUS EMISSIONS WITH CHARGING WORST CASE(3 GHZ~18 GHZ)</i> .....	60
8.7. <i>SPURIOUS EMISSIONS(9 KHZ~30 MHZ)</i> .....	62
8.8. <i>SPURIOUS EMISSIONS(18 GHZ~26 GHZ)</i> .....	65
8.9. <i>SPURIOUS EMISSIONS(30 MHZ~1 GHZ)</i> .....	67
8.10. <i>SPURIOUS EMISSIONS WITH CHARGING WORST CASE(30 MHZ~1 GHZ)</i> .....	69



**9. ANTENNA REQUIREMENT ..... 71**

**10. AC POWER LINE CONDUCTED EMISSION ..... 72**

**11. TEST DATA ..... 75**

    11.1. *APPENDIX A: DTS BANDWIDTH* ..... 75

        11.1.1. Test Result ..... 75

        11.1.2. Test Graphs ..... 76

    11.2. *APPENDIX B: OCCUPIED CHANNEL BANDWIDTH* ..... 78

        11.2.1. Test Result ..... 78

        11.2.2. Test Graphs ..... 79

    11.3. *APPENDIX C: MAXIMUM CONDUCTED OUTPUT POWER* ..... 81

        11.3.1. Test Result ..... 81

    11.4. *APPENDIX D: MAXIMUM POWER SPECTRAL DENSITY* ..... 82

        11.4.1. Test Result ..... 82

        11.4.2. Test Graphs ..... 83

    11.5. *APPENDIX E: BAND EDGE MEASUREMENTS* ..... 85

        11.5.1. Test Result ..... 85

        11.5.2. Test Graphs ..... 86

    11.6. *APPENDIX F: CONDUCTED SPURIOUS EMISSION* ..... 88

        11.6.1. Test Result ..... 88

        11.6.2. Test Graphs ..... 89

    11.7. *APPENDIX G: DUTY CYCLE* ..... 95

        11.7.1. Test Result ..... 95

        11.7.2. Test Graphs ..... 96



# 1. ATTESTATION OF TEST RESULTS

## Applicant Information

Company Name: Motorola Solutions, Inc.  
Address: 8000, West Sunrise Blvd., Ft Lauderdale, Florida 33322, United States

## Manufacturer Information

Company Name: Motorola Solutions, Inc.  
Address: 8000, West Sunrise Blvd., Ft Lauderdale, Florida 33322, United States

## EUT Information

EUT Name: Two Way Portable Radio R7  
Model: AAH06UCN9RB1AN (IC Model: PMUF2000ABB)  
Brand: Motorola  
Sample Received Date: August 10, 2022  
Sample Status: Normal  
Sample ID: 5225541  
Date of Tested: August 10, 2022 to August 24, 2022

APPLICABLE STANDARDS	
STANDARD	TEST RESULTS
CFR 47 FCC PART 15 SUBPART C ISED RSS-247 ISSUE 2	Pass

Prepared By:

Kebo Zhang  
Senior Project Engineer

Checked By:

Denny Huang  
Senior Project Engineer

Approved By:

Stephen Guo  
Operations Manager



## 2. TEST METHODOLOGY

All tests were performed in accordance with the standard CFR 47 FCC PART 15 SUBPART C ISED RSS-247 ISSUE 2, KDB 558074 D01 15.247 Meas Guidance v05r02, 414788 D01 Radiated Test Site v01r01, CFR 47 FCC Part 2, CFR 47 FCC Part 15, ANSI C63.10-2013, ISED RSS-247 Issue 2 and ISED RSS-GEN Issue 5.

## 3. FACILITIES AND ACCREDITATION

Accreditation Certificate	<p><b>A2LA (Certificate No.: 4102.01)</b> UL Verification Services (Guangzhou) Co., Ltd. Song Shan Lake Branch. has been assessed and proved to be in compliance with A2LA.</p> <p><b>FCC (FCC Designation No.: CN1187)</b> UL Verification Services (Guangzhou) Co., Ltd. Song Shan Lake Branch. Has been recognized to perform compliance testing on equipment subject to the Commission's Delcaration of Conformity (DoC) and Certification rules</p> <p><b>ISED (Company No.: 21320)</b> UL Verification Services (Guangzhou) Co., Ltd. Song Shan Lake Branch. has been registered and fully described in a report filed with ISED. The Company Number is 21320 and the test lab Conformity Assessment Body Identifier (CABID) is CN0046.</p> <p><b>VCCI (Registration No.: G-20019, R-20004, C-20012 and T-20011)</b> UL Verification Services (Guangzhou) Co., Ltd. Song Shan Lake Branch. has been assessed and proved to be in compliance with VCCI, the Membership No. is 3793. Facility Name: Chamber D, the VCCI registration No. is G-20019 and R-20004 Shielding Room B , the VCCI registration No. is C-20012 and T-20011</p>
---------------------------	---

Note1:

All tests measurement facilities use to collect the measurement data are located at Building 10, Innovation Technology Park, No. 1, Li Bin Road, Song Shan Lake Hi-Tech Development Zone Dongguan, 523808, People’s Republic of China.

Note2:

The test anechoic chamber in UL Verification Services (Guangzhou) Co., Ltd. Song Shan Lake Branch had been calibrated and compared to the open field sites and the test anechoic chamber is shown to be equivalent to or worst case from the open field site.

Note3:

For below 30 MHz, lab had performed measurements at test anechoic chamber and comparing to measurements obtained on an open field site. And these measurements below 30 MHz had been correlated to measurements performed on an OFS.



## 4. CALIBRATION AND UNCERTAINTY

### 4.1. MEASURING INSTRUMENT CALIBRATION

The measuring equipment utilized to perform the tests documented in this report has been calibrated in accordance with the manufacturer's recommendations and is traceable to recognized national standards.

### 4.2. MEASUREMENT UNCERTAINTY

Where relevant, the following measurement uncertainty levels have been estimated for tests performed on the apparatus:

Test Item	Uncertainty
Conduction emission	3.62 dB
Radiated Emission (Included Fundamental Emission) (9 kHz ~ 30 MHz)	2.2 dB
Radiated Emission (Included Fundamental Emission) (30 MHz ~ 1 GHz)	4.00 dB
Radiated Emission (Included Fundamental Emission) (1 GHz to 26 GHz)	5.78 dB (1 GHz ~ 18 GHz)
	5.23 dB (18 GHz ~ 26 GHz)

Note: This uncertainty represents an expanded uncertainty expressed at approximately the 95 % confidence level using a coverage factor of k=2.



## 5. EQUIPMENT UNDER TEST

### 5.1. DESCRIPTION OF EUT

EUT Name	Two Way Portable Radio R7
Model	AAH06UCN9RB1AN (IC Model: PMUF2000ABB)
Frequency Range:	2402 MHz to 2480 MHz
Technology	Bluetooth - Low Energy
Type of Modulation:	GFSK (LE 1M, LE 2M)
Firmware Version:	D02.22.02.1009
Test Voltage:	Normal Voltage: DC 7.5 V Battery: PMNN4809A DC 7.7 V, 21.9 Wh PMNN4810A DC 7.2 V, 23.0 Wh

Note: We have pre-test the two battery, only the worst data on PMNN4809A battery usage was recorded in the report.

### 5.2. CHANNEL LIST

Channel	Frequency (MHz)	Channel	Frequency (MHz)	Channel	Frequency (MHz)	Channel	Frequency (MHz)
0	2402	11	2424	22	2446	33	2468
1	2404	12	2426	23	2448	34	2470
2	2406	13	2428	24	2450	35	2472
3	2408	14	2430	25	2452	36	2474
4	2410	15	2432	26	2454	37	2476
5	2412	16	2434	27	2456	38	2478
6	2414	17	2436	28	2458	39	2480
7	2416	18	2438	29	2460	/	/
8	2418	19	2440	30	2462	/	/
9	2420	20	2442	31	2464	/	/
10	2422	21	2444	32	2468	/	/

### 5.3. MAXIMUM EIRP

Test Mode	Frequency (MHz)	Channel Number	Maximum Peak Output Power (dBm)	Maximum EIRP (dBm)
LE 1M	2402 ~ 2480	0-39[40]	8.97	11.00
LE 2M	2402 ~ 2480	0-39[40]	9.00	11.03

#### 5.4. TEST CHANNEL CONFIGURATION

Test Mode	Test Channel	Frequency
LE 1M	CH 0(Low Channel), CH 19(MID Channel), CH 39(High Channel)	2402 MHz, 2440 MHz, 2480 MHz
LE 2M	CH 0(Low Channel), CH 19(MID Channel), CH 39(High Channel)	2402 MHz, 2440 MHz, 2480 MHz

#### 5.5. THE WORSE CASE POWER SETTING PARAMETER

The Worse Case Power Setting Parameter under 2400 ~ 2483.5MHz Band				
Test Software Version		DutApiSisoACDuaIf		
Modulation Type	Transmit Antenna Number	Test Software setting value		
		CH 0	CH 19	CH 39
GFSK(1Mbps)	1	9	9	9
GFSK(2Mbps)	1	9	9	9

#### 5.6. DESCRIPTION OF AVAILABLE ANTENNAS

Antenna	Frequency (MHz)	Antenna Type	MAX Antenna Gain (dBi)
1	2402-2480	PCB Antenna	2.03

Test Mode	Transmit and Receive Mode	Description
LE 1M	<input checked="" type="checkbox"/> 1TX, 1RX	Antenna 1 can be used as transmitting/receiving antenna.
LE 2M	<input checked="" type="checkbox"/> 1TX, 1RX	Antenna 1 can be used as transmitting/receiving antenna.

Note: The value of the antenna gain was declared by customer.



### 5.7. SUPPORT UNITS FOR SYSTEM TEST

#### SUPPORT EQUIPMENT

Item	Accessory	Brand Name	Model Name	Description
1	/	/	/	/

#### I/O CABLES

Item	Type of cable	Shielded Type	Ferrite Core	Length
1	/	/	/	/

#### ACCESSORY

Item	Accessory	Brand Name	Model Name	Description	Remark	Test Voltage
1	Lithium battery	Motorola	PMNN4809A	DC 7.7V / 21.9Wh	/	/
2	Lithium battery	Motorola	PMNN4810A	DC 7.2V / 23.0Wh	/	/
3	Charger	Motorola	PMPN4284A	MUC	PMPN4284A = BASE PMPN4283A + POWER SUPPLY PS000242A01 + LINE CORD	AC 120 V, 60 Hz
4	Two Way Portable Radio R7	Motorola	AAH06UCN9RB1AN (IC Model: PMUF2000ABB)	*2	/	/

### 5.8. SETUP DIAGRAM

Radio Alone

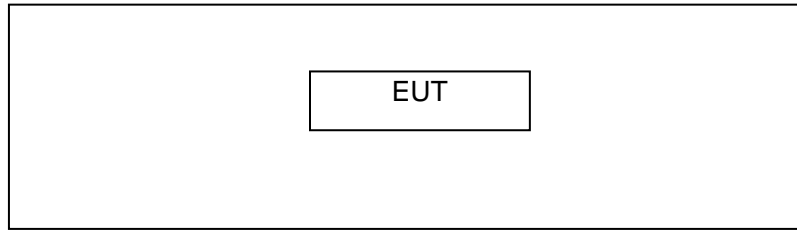

Radio with charger - AC input

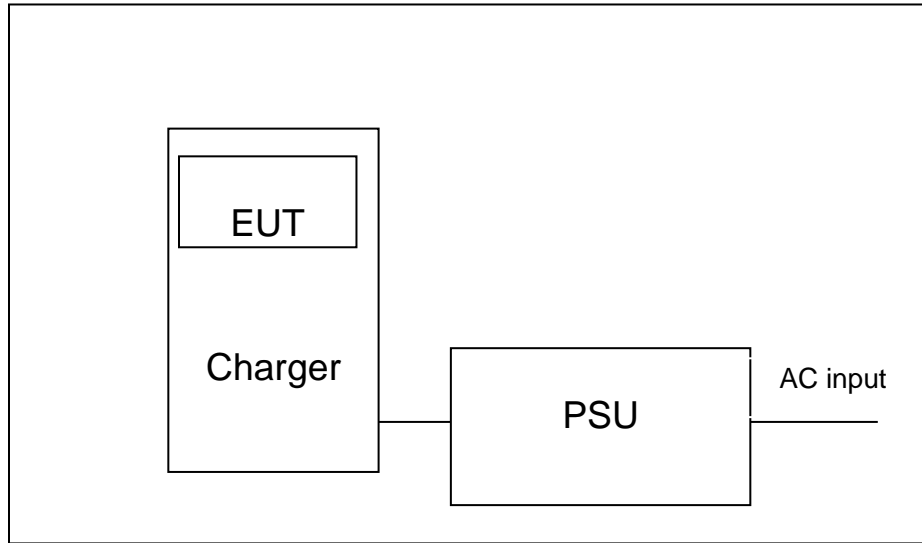

**6. MEASURING EQUIPMENT AND SOFTWARE USED**

<b>R&amp;S TS 8997 Test System</b>					
Equipment	Manufacturer	Model No.	Serial No.	Last Cal.	Due. Date
Power sensor, Power Meter	R&S	OSP120	100921	Apr.02,2022	Apr.01,2023
Vector Signal Generator	R&S	SMBV100A	261637	Oct.30, 2021	Oct.29, 2022
Signal Generator	R&S	SMB100A	178553	Oct.30, 2021	Oct.29, 2022
Signal Analyzer	R&S	FSV40	101118	Oct.30, 2021	Oct.29, 2022
<b>Software</b>					
Description	Manufacturer	Name		Version	
For R&S TS 8997 Test System	Rohde & Schwarz	EMC 32		10.60.10	
<b>Tonsend RF Test System</b>					
Equipment	Manufacturer	Model No.	Serial No.	Last Cal.	Due. Date
Wideband Radio Communication Tester	R&S	CMW500	155523	Oct.30, 2021	Oct.29, 2022
Wireless Connectivity Tester	R&S	CMW270	1201.0002N75-102	Sep.29, 2021	Sep.28, 2022
PXA Signal Analyzer	Keysight	N9030A	MY55410512	Oct.30, 2021	Oct.29, 2022
MXG Vector Signal Generator	Keysight	N5182B	MY56200284	Oct.30, 2021	Oct.29, 2022
MXG Vector Signal Generator	Keysight	N5172B	MY56200301	Oct.30, 2021	Oct.29, 2022
DC power supply	Keysight	E3642A	MY55159130	Oct.30, 2021	Oct.29, 2022
Temperature & Humidity Chamber	SANMOOD	SG-80-CC-2	2088	Nov.20,2020	Nov.19,2022
<b>Software</b>					
Description	Manufacturer	Name		Version	
Tonsend SRD Test System	Tonsend	JS1120-3 RF Test System		2.6.77.0518	



Conducted Emissions					
Equipment	Manufacturer	Model No.	Serial No.	Last Cal.	Due Date
EMI Test Receiver	R&S	ESR3	101961	Oct.30, 2021	Oct.29, 2022
Two-Line V-Network	R&S	ENV216	101983	Oct.30, 2021	Oct.29, 2022
Artificial Mains Networks	Schwarzbeck	NSLK 8126	8126465	Oct.30, 2021	Oct.29, 2022
Software					
Description			Manufacturer	Name	Version
Test Software for Conducted Emissions			Farad	EZ-EMC	Ver. UL-3A1

Radiated Emissions					
Equipment	Manufacturer	Model No.	Serial No.	Last Cal.	Due Date
MXE EMI Receiver	KESIGHT	N9038A	MY56400036	Oct.30, 2021	Oct.29, 2022
Hybrid Log Periodic Antenna	TDK	HLP-3003C	130959	Aug.02, 2021	Aug.01, 2024
Preamplifier	HP	8447D	2944A09099	Oct.30, 2021	Oct.29, 2022
EMI Measurement Receiver	R&S	ESR26	101377	Oct.30, 2021	Oct.29, 2022
Horn Antenna	TDK	HRN-0118	130940	July 20, 2021	July 19, 2024
Preamplifier	TDK	PA-02-0118	TRS-305-00067	Oct.30, 2021	Oct.29, 2022
Horn Antenna	Schwarzbeck	BBHA9170	697	July 20, 2021	July 19, 2024
Preamplifier	TDK	PA-02-2	TRS-307-00003	Oct.31, 2021	Oct.30, 2022
Preamplifier	TDK	PA-02-3	TRS-308-00002	Oct.31, 2021	Oct.30, 2022
Loop antenna	Schwarzbeck	1519B	00008	Dec.14, 2021	Dec.13, 2024
Preamplifier	TDK	PA-02-001-3000	TRS-302-00050	Oct.31, 2021	Oct.30, 2022
Preamplifier	Mini-Circuits	ZX60-83LN-S+	SUP01201941	Oct.31, 2021	Oct.30, 2022
High Pass Filter	Wi	WHKX10-2700-3000-18000-40SS	23	Oct.31, 2021	Oct.30, 2022
Highpass Filter	Wainwright	WHKX10-5850-6500-1800-40SS	4	Oct.31, 2021	Oct.30, 2022
Band Reject Filter	Wainwright	WRCJV12-5695-5725-5850-5880-40SS	4	Oct.31, 2021	Oct.30, 2022
Band Reject Filter	Wainwright	WRCJV20-5120-5150-	2	Oct.31, 2021	Oct.30, 2022



		5350-5380-60SS			
Band Reject Filter	Wainwright	WRCJV20-5440-5470-5725-5755-60SS	1	Oct.31, 2021	Oct.30, 2022
Band Reject Filter	Wainwright	WRCJV8-2350-2400-2483.5-2533.5-40SS	4	Oct.31, 2021	Oct.30, 2022
Band Reject Filter	Wainwright	WRCD5-1879-1879.85-1880.15-1881-40SS	1	Oct.31, 2021	Oct.30, 2022
Notch Filter	Wainwright	WHJ10-882-980-7000-40SS	1	Oct.31, 2021	Oct.30, 2022
<b>Software</b>					
Description			Manufacturer	Name	Version
Test Software for Radiated Emissions			Farad	EZ-EMC	Ver. UL-3A1

<b>Other Instrument</b>					
Equipment	Manufacturer	Model No.	Serial No.	Last Cal.	Due Date
Temperature humidity probe	OMEGA	ITHX-SD-5	18470007	Nov. 4, 2021	Nov. 3, 2022
Barometer	Yiyi	Baro	N/A	Nov. 15, 2021	Nov. 14, 2022

## 7. ANTENNA PORT TEST RESULTS

### 7.1. CONDUCTED OUTPUT POWER

#### LIMITS

CFR 47 FCC Part15 (15.247) Subpart C ISED RSS-247 ISSUE 2			
Section	Test Item	Limit	Frequency Range (MHz)
CFR 47 FCC 15.247(b)(3) ISED RSS-247 5.4 (d)	Peak Conduct Output Power	1 watt or 30 dBm	2400-2483.5

#### TEST PROCEDURE

Connect the EUT to a low loss RF cable from the antenna port to the power sensor (video bandwidth is greater than the occupied bandwidth).

Measure peak emission level, the indicated level is the peak output power, after any corrections for external attenuators and cables.

#### TEST SETUP

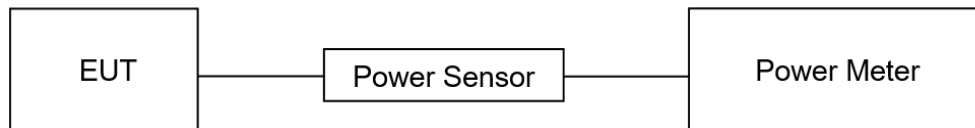

#### TEST ENVIRONMENT

Temperature	23.9°C	Relative Humidity	64%
Atmosphere Pressure	101kPa	Test Voltage	DC 7.5 V

#### TEST RESULTS

Please refer to section "Test Data" - Appendix C



## 7.2. 6DB BANDWIDTH AND 99% OCCUPIED BANDWIDTH

### LIMITS

CFR 47 FCC Part15 (15.247) Subpart C ISED RSS-247 ISSUE 2			
Section	Test Item	Limit	Frequency Range (MHz)
CFR 47 FCC 15.247(a)(2) ISED RSS-247 5.2 (a)	6 dB Bandwidth	≥ 500 kHz	2400-2483.5
ISED RSS-Gen Clause 6.7	99 % Occupied Bandwidth	For reporting purposes only.	2400-2483.5

### TEST PROCEDURE

Refer to ANSI C63.10-2013 clause 11.8 for DTS bandwidth and clause 6.9 for Occupied Bandwidth.

Connect the EUT to the spectrum analyser and use the following settings:

Center Frequency	The center frequency of the channel under test
Frequency Span	For 6 dB Bandwidth: Enough to capture all products of the modulation carrier emission For 99 % Occupied Bandwidth: Between 1.5 times and 5.0 times the OBW
Detector	Peak
RBW	For 6 dB Bandwidth: 100 kHz For 99 % Occupied Bandwidth: 1 % to 5 % of the occupied bandwidth
VBW	For 6 dB Bandwidth: ≥3 × RBW For 99 % Occupied Bandwidth: ≥3 × RBW
Trace	Max hold
Sweep	Auto couple

a) Use the 99 % power bandwidth function of the instrument, allow the trace to stabilize and report the measured bandwidth.

b) Allow the trace to stabilize and measure the maximum width of the emission that is constrained by the frequencies associated with the two outermost amplitude points (upper and lower frequencies) that are attenuated by 6 dB relative to the maximum level measured in the fundamental emission.



**TEST SETUP**

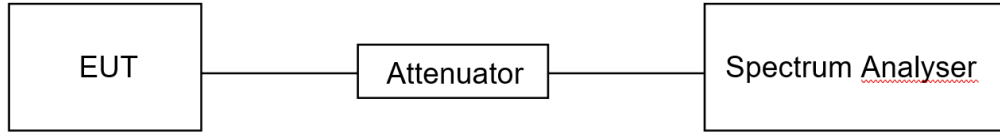

**TEST ENVIRONMENT**

Temperature	23.9°C	Relative Humidity	64%
Atmosphere Pressure	101kPa	Test Voltage	DC 7.5 V

**TEST RESULTS**

Please refer to section "Test Data" - Appendix A&B

### 7.3. POWER SPECTRAL DENSITY

#### LIMITS

CFR 47 FCC Part15 (15.247) Subpart C ISED RSS-247 ISSUE 2			
Section	Test Item	Limit	Frequency Range (MHz)
CFR 47 FCC §15.247 (e) ISED RSS-247 5.2 (b)	Power Spectral Density	8 dBm in any 3 kHz band	2400-2483.5

#### TEST PROCEDURE

Refer to ANSI C63.10-2013 clause 11.10.

Connect the EUT to the spectrum analyser and use the following settings:

Center Frequency	The center frequency of the channel under test
Detector	PEAK
RBW	$3 \text{ kHz} \leq \text{RBW} \leq 100 \text{ kHz}$
VBW	$\geq 3 \times \text{RBW}$
Span	1.5 x DTS bandwidth
Trace	Max hold
Sweep time	Auto couple

Allow trace to fully stabilize and use the peak marker function to determine the maximum amplitude level within the RBW.

If measured value exceeds limit, reduce RBW (no less than 3 kHz) and repeat.

#### TEST SETUP

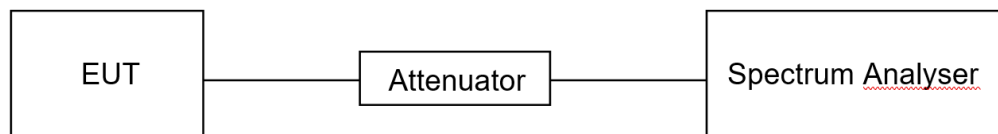

#### TEST ENVIRONMENT

Temperature	23.9°C	Relative Humidity	64%
Atmosphere Pressure	101kPa	Test Voltage	DC 7.5 V

#### TEST RESULTS

Please refer to section "Test Data" - Appendix D

## 7.4. CONDUCTED BAND EDGE AND SPURIOUS EMISSION

### LIMITS

CFR 47 FCC Part15 (15.247) Subpart C ISED RSS-247 ISSUE 2		
Section	Test Item	Limit
CFR 47 FCC §15.247 (d) ISED RSS-247 5.5	Conducted Bandedge and Spurious Emissions	at least 20 dB below that in the 100 kHz bandwidth within the band that contains the highest level of the desired power

### TEST PROCEDURE

Refer to ANSI C63.10-2013 clause 11.11 and 11.13.

Connect the EUT to the spectrum analyser and use the following settings for reference level measurement:

Center Frequency	The center frequency of the channel under test
Detector	Peak
RBW	100 kHz
VBW	$\geq 3 \times \text{RBW}$
Span	1.5 x DTS bandwidth
Trace	Max hold
Sweep time	Auto couple.

Allow trace to fully stabilize and use the peak marker function to determine the maximum PSD level.

Change the settings for emission level measurement:

Span	Set the center frequency and span to encompass frequency range to be measured
Detector	Peak
RBW	100 kHz
VBW	$\geq 3 \times \text{RBW}$
measurement points	$\geq \text{span}/\text{RBW}$
Trace	Max hold
Sweep time	Auto couple.

Allow trace to fully stabilize and use the peak marker function to determine the maximum PSD level. Ensure that the amplitude of all unwanted emissions outside of the authorized frequency band (excluding restricted frequency bands) is attenuated by at least the minimum requirements specified in 11.11.



**TEST SETUP**

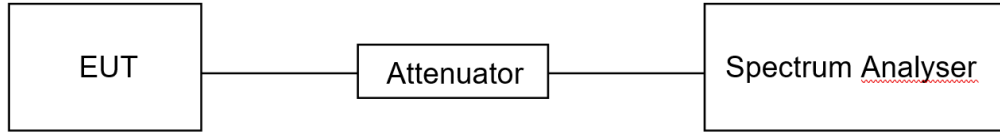

**TEST ENVIRONMENT**

Temperature	23.9°C	Relative Humidity	64%
Atmosphere Pressure	101kPa	Test Voltage	DC 7.5 V

**TEST RESULTS**

Please refer to section "Test Data" - Appendix E&F



## 7.5. DUTY CYCLE

### LIMITS

None; for reporting purposes only.

### TEST PROCEDURE

Refer to ANSI C63.10-2013 clause 11.6 Zero – Span Spectrum Analyzer method.

### TEST SETUP

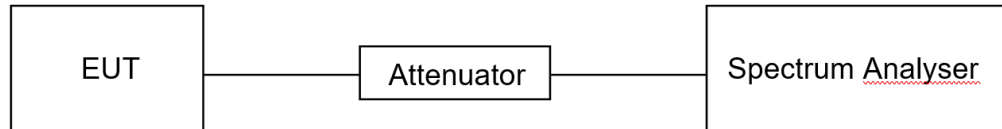

### TEST ENVIRONMENT

Temperature	23.9°C	Relative Humidity	64%
Atmosphere Pressure	101kPa	Test Voltage	DC 7.5 V

### TEST RESULTS

Please refer to section "Test Data" - Appendix G

## 8. RADIATED TEST RESULTS

### LIMITS

Please refer to CFR 47 FCC §15.205 and §15.209.

Please refer to ISED RSS-GEN Clause 8.9 and Clause 8.10.

Radiation Disturbance Test Limit for FCC (Class B) (9 kHz ~ 1 GHz)

Emissions radiated outside of the specified frequency bands above 30 MHz			
Frequency Range (MHz)	Field Strength Limit (uV/m) at 3 m	Field Strength Limit (dBuV/m) at 3 m	
		Quasi-Peak	
30 - 88	100	40	
88 - 216	150	43.5	
216 - 960	200	46	
Above 960	500	54	
Above 1000	500	Peak	Average
		74	54

FCC Emissions radiated outside of the specified frequency bands below 30 MHz		
Frequency (MHz)	Field strength (microvolts/meter)	Measurement distance (meters)
0.009-0.490	2400/F(kHz)	300
0.490-1.705	24000/F(kHz)	30
1.705-30.0	30	30

ISED General field strength limits at frequencies below 30 MHz

Table 6 – General field strength limits at frequencies below 30 MHz		
Frequency	Magnetic field strength (H-Field) (uA/m)	Measurement distance (m)
9 - 490 kHz <sup>Note 1</sup>	6.37/F (F in kHz)	300
490 - 1705 kHz	63.7/F (F in kHz)	30
1.705 - 30 MHz	0.08	30

**Note 1:** The emission limits for the ranges 9-90 kHz and 110-490 kHz are based on measurements employing a linear average detector.



ISED Restricted bands please refer to ISED RSS-GEN Clause 8.10

Table 7 – Restricted frequency bands <sup>Note 1</sup>		
MHz	MHz	GHz
0.090 - 0.110	149.9 - 150.05	9.0 - 9.2
0.495 - 0.505	156.52475 - 156.52525	9.3 - 9.5
2.1735 - 2.1905	156.7 - 156.9	10.6 - 12.7
3.020 - 3.026	162.0125 - 167.17	13.25 - 13.4
4.125 - 4.128	167.72 - 173.2	14.47 - 14.5
4.17725 - 4.17775	240 - 285	15.35 - 16.2
4.20725 - 4.20775	322 - 335.4	17.7 - 21.4
5.677 - 5.683	399.9 - 410	22.01 - 23.12
6.215 - 6.218	608 - 614	23.6 - 24.0
6.26775 - 6.26825	960 - 1427	31.2 - 31.8
6.31175 - 6.31225	1435 - 1626.5	36.43 - 36.5
8.291 - 8.294	1645.5 - 1646.5	Above 38.6
8.362 - 8.366	1660 - 1710	
8.37625 - 8.38675	1718.8 - 1722.2	
8.41425 - 8.41475	2200 - 2300	
12.29 - 12.293	2310 - 2390	
12.51975 - 12.52025	2483.5 - 2500	
12.57675 - 12.57725	2655 - 2900	
13.36 - 13.41	3260 - 3267	
16.42 - 16.423	3332 - 3339	
16.69475 - 16.69525	3345.8 - 3358	
16.80425 - 16.80475	3500 - 4400	
25.5 - 25.67	4500 - 5150	
37.5 - 38.25	5350 - 5460	
73 - 74.6	7250 - 7750	
74.8 - 75.2	8025 - 8500	
108 - 138		

**Note 1:** Certain frequency bands listed in table 7 and in bands above 38.6 GHz are designated for licence-exempt applications. These frequency bands and the requirements that apply to related devices are set out in the 200 and 300 series of RSSs.

FCC Restricted bands of operation refer to FCC §15.205 (a):

MHz	MHz	MHz	GHz
0.090-0.110	16.42-16.423	399.9-410	4.5-5.15
<sup>1</sup> 0.495-0.505	16.69475-16.69525	608-614	5.35-5.46
2.1735-2.1905	16.80425-16.80475	960-1240	7.25-7.75
4.125-4.128	25.5-25.67	1300-1427	8.025-8.5
4.17725-4.17775	37.5-38.25	1435-1626.5	9.0-9.2
4.20725-4.20775	73-74.6	1645.5-1646.5	9.3-9.5
6.215-6.218	74.8-75.2	1660-1710	10.6-12.7
6.26775-6.26825	108-121.94	1718.8-1722.2	13.25-13.4
6.31175-6.31225	123-138	2200-2300	14.47-14.5
8.291-8.294	149.9-150.05	2310-2390	15.35-16.2
8.362-8.366	156.52475-156.52525	2483.5-2500	17.7-21.4
8.37625-8.38675	156.7-156.9	2690-2900	22.01-23.12
8.41425-8.41475	162.0125-167.17	3260-3267	23.6-24.0
12.29-12.293	167.72-173.2	3332-3339	31.2-31.8
12.51975-12.52025	240-285	3345.8-3358	36.43-36.5
12.57675-12.57725	322-335.4	3600-4400	( <sup>2</sup> )
13.36-13.41			

Note: <sup>1</sup>Until February 1, 1999, this restricted band shall be 0.490-0.510 MHz.

<sup>2</sup>Above 38.6c



**TEST PROCEDURE**

Below 30 MHz

The setting of the spectrum analyser

RBW	200 Hz (From 9 kHz to 0.15 MHz)/ 9 kHz (From 0.15 MHz to 30 MHz)
VBW	200 Hz (From 9 kHz to 0.15 MHz)/ 9 kHz (From 0.15 MHz to 30 MHz)
Sweep	Auto

1. The testing follows the guidelines in ANSI C63.10-2013 clause 6.4.
2. The EUT was arranged to its worst case and then turntable (from 0 degree to 360 degrees) to find the maximum reading. A pre-amp and a high pass filter are used for the test in order to get better signal level. Both Horizontal, Face-on and Face-off polarizations of the antenna are set to make the measurement.
3. The EUT was placed on a turntable with 80 cm above ground.
4. The EUT was set 3 meters from the interference receiving antenna, which was mounted on the top of a 1 m height antenna tower.
5. The radiated emission limits are based on measurements employing a CISPR quasi-peak detector except for the frequency bands 9-90 kHz, 110-490 kHz and above 1000 MHz Radiated emission limits in these three bands are based on measurements employing an average detector.
6. For measurement below 1 GHz, the initial step in collecting conducted emission data is a spectrum analyzer peak detector mode pre-scanning the measurement frequency range. Significant peaks are then marked and then Quasi Peak and average detector mode re-measured. If the emission level of the EUT measured by the peak detector is 3 dB lower than the applicable limit, the peak emission level will be reported. Otherwise, the emission measurement will be repeated using the quasi-peak and average detector and reported.
7. Although these tests were performed other than open field site, adequate comparison measurements were confirmed against 30m open field site. Therefore sufficient tests were made to demonstrate that the alternative site produces results that correlate with the ones of tests made in an open field site based on KDB 414788.
8. The limits in CFR 47, Part 15, Subpart C, paragraph 15.209 (a), are identical to those in RSS-GEN Section 8.9, Table 6, since the measurements are performed in terms of magnetic field strength and converted to electric field strength levels (as reported in the table) using the free space impedance of 377Ω. For example, the measurement frequency X KHz resulted in a level of Y dBuV/m, which is equivalent to  $Y-51.5 = Z$  dBuA/m, which has the same margin, W dB, to the corresponding RSS-GEN Table 6 limit as it has to be 15.209(a) limit.

Below 1 GHz and above 30 MHz

The setting of the spectrum analyser

RBW	120 kHz
VBW	300 kHz
Sweep	Auto
Detector	Peak/QP
Trace	Max hold



1. The testing follows the guidelines in ANSI C63.10-2013 clause 6.5.
2. The EUT was arranged to its worst case and then tune the antenna tower (from 1 m to 4 m) and turntable (from 0 degree to 360 degrees) to find the maximum reading. A pre-amp and a high pass filter are used for the test in order to get better signal level. Both horizontal and vertical polarizations of the antenna are set to make the measurement.
3. The EUT was placed on a turntable with 80 cm above ground.
4. The EUT was set 3 meters from the interference receiving antenna, which was mounted on the top of a variable height antenna tower.
5. For measurement below 1 GHz, the initial step in collecting conducted emission data is a spectrum analyzer peak detector mode pre-scanning the measurement frequency range. Significant peaks are then marked and then Quasi Peak detector mode re-measured. If the emission level of the EUT measured by the peak detector is 3 dB lower than the applicable limit, the peak emission level will be reported. Otherwise, the emission measurement will be repeated using the quasi-peak detector and reported.

Above 1G

The setting of the spectrum analyser

RBW	1 MHz
VBW	PEAK: 3 MHz AVG: see note 6
Sweep	Auto
Detector	Peak
Trace	Max hold

1. The testing follows the guidelines in ANSI C63.10-2013 clause 6.6.
2. The EUT was arranged to its worst case and then tune the antenna tower (from 1 m to 4 m) and turntable (from 0 degree to 360 degrees) to find the maximum reading. A pre-amp and a high pass filter are used for the test in order to get better signal level. Both horizontal and vertical polarizations of the antenna are set to make the measurement.
3. The EUT was placed on a turntable with 1.5 m above ground.
4. The EUT was set 3 meters from the interference receiving antenna, which was mounted on the top of a variable height antenna tower.
5. For measurement above 1 GHz, the emission measurement will be measured by the peak detector. This peak level, once corrected, must comply with the limit specified in Section 15.209.
6. For measurements above 1 GHz the resolution bandwidth is set to 1 MHz, then the video bandwidth is set to 3 MHz for peak measurements and 1 MHz resolution bandwidth with 1/T video bandwidth with peak detector for average measurements. For the Duty Cycle please refer to clause 7.5.ON TIME AND DUTY CYCLE.

X axis, Y axis, Z axis positions:

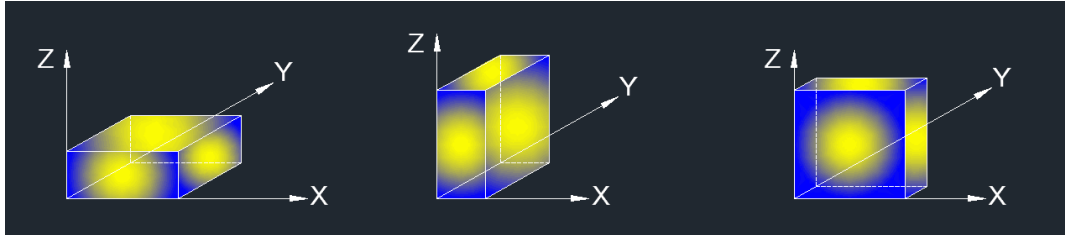

Note 1: For all radiated test, EUT in each of three orthogonal axis emissions had been tested, but only the worst case (X axis) data recorded in the report.

For Band edge note:

1. Measurement = Reading Level + Correct Factor.
2. If Peak Result complies with AV limit, AV Result is deemed to comply with AV limit.
3. Peak: Peak detector.
4. AVG:  $VBW=1/Ton$ , where: Ton is the transmitting duration.
5. For the transmitting duration, please refer to clause 7.5.
6. Only the worst data was recorded, if it complies with the limit, the other emissions deemed to comply with the limit.
7. Horizontal and Vertical have been tested, only the worst data was recorded in the report.

For Radiate Spurious emission 1GHz-3GHz note:

- Note: 1. Measurement = Reading Level + Correct Factor.
2. If Peak Result complies with AV limit, AV Result is deemed to comply with AV limit.
  3. Peak: Peak detector.
  4. AVG:  $VBW=1/Ton$ , where: Ton is the transmitting duration.
  5. For the transmitting duration, please refer to clause 7.5.
  6. Filter losses were only considered in the spurious frequency bands and the authorized band was not corrected for Band reject filter losses.
  7. Proper operation of the transmitter prior to adding the filter to the measurement chain.
  8. All modes and channels have been tested, only the worst data was recorded in the report.

For Radiate Spurious emission 3GHz-18GHz note:

- Note: 1. Peak Result = Reading Level + Correct Factor.
2. If Peak Result complies with AV limit, AV Result is deemed to comply with AV limit.
  3. Peak: Peak detector.
  4. AVG:  $VBW=1/Ton$ , where: Ton is the transmitting duration.
  5. For the transmitting duration, please refer to clause 7.5.
  6. Filter losses were only considered in the spurious frequency bands and the authorized band was not corrected for High Pass Filter losses.
  7. Proper operation of the transmitter prior to adding the filter to the measurement chain.
  8. All modes and channels have been tested, only the worst data was recorded in the report.



For Radiate Spurious emission 9kHz-30MHz note:

1. Measurement = Reading Level + Correct Factor.
2. If Peak Result complies with AV and QP limit, AV and QP Result are deemed to comply with AV limit.
3. All 3 polarizations (Horizontal, Face-on and Face-off) of the loop antenna had been tested, but only the worst data recorded in the report.
4. All modes and channels have been tested, only the worst data was recorded in the report.

For Radiate Spurious emission 18GHz-26GHz note:

1. Measurement = Reading Level + Correct Factor.
2. If Peak Result complies with AV limit, AV Result is deemed to comply with AV limit.
3. Peak: Peak detector.
4. All modes and channels have been tested, only the worst data was recorded in the report.

For Radiate Spurious emission 30MHz-1GHz note:

1. Result Level = Read Level + Correct Factor.
2. If Peak Result complies with QP limit, QP Result is deemed to comply with QP limit.
3. Test setup: RBW: 120 kHz, VBW: 300 kHz, Sweep time: auto.
4. All modes and channels have been tested, only the worst data was recorded in the report.

**TEST SETUP**

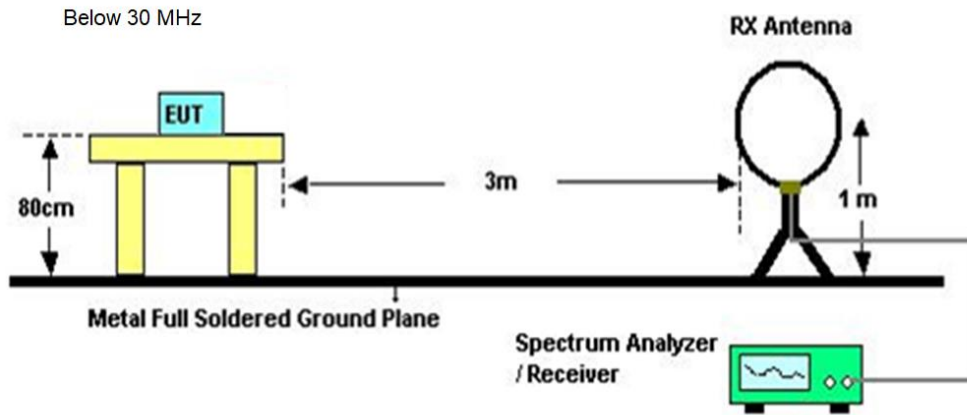

Below 1 GHz and above 30 MHz

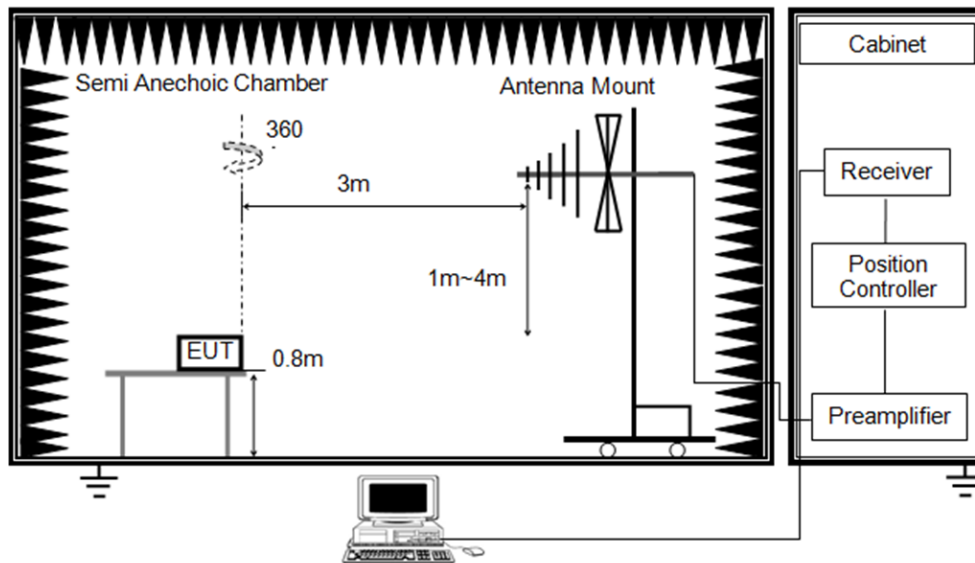

Above 1 GHz

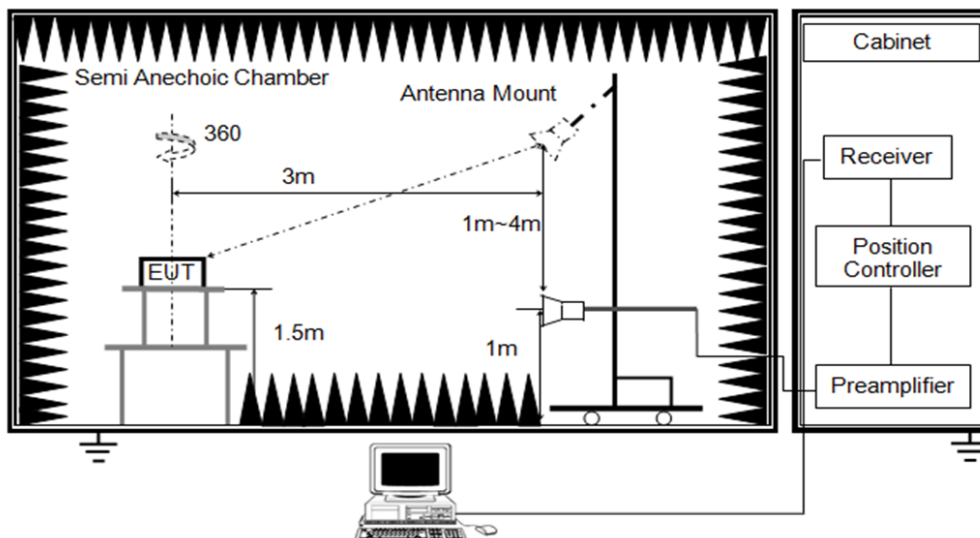



**TEST ENVIRONMENT**

Temperature	25.6°C	Relative Humidity	63%
Atmosphere Pressure	101kPa	Test Voltage	DC 7.5 V

**TEST RESULTS**



### 8.1. RESTRICTED BANDEDGE

Test Mode:	BLE 1M PK	Channel:	2402
Polarity:	Horizontal		

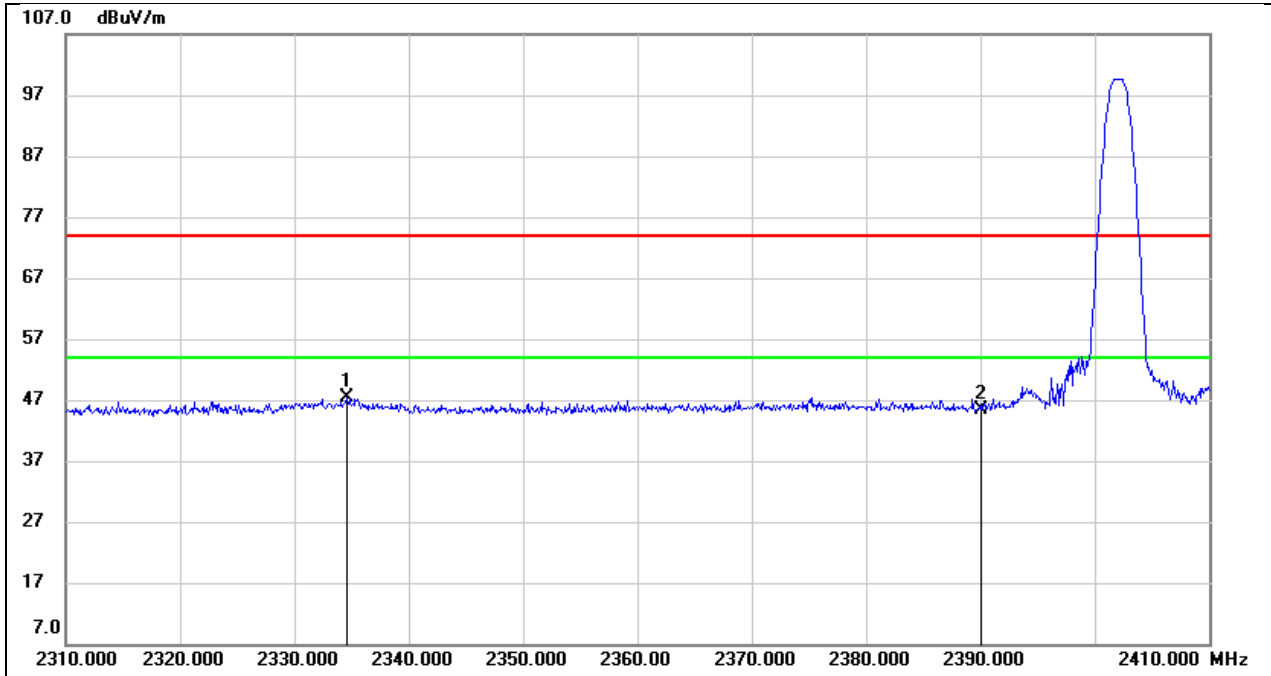

No.	Frequency (MHz)	Reading (dBuV)	Correct (dB/m)	Result (dBuV/m)	Limit (dBuV/m)	Margin (dB)	Remark
1	2334.600	15.35	31.99	47.34	74.00	-26.66	peak
2	2390.000	13.27	32.16	45.43	74.00	-28.57	peak



Test Mode:	BLE 1M PK	Channel:	2402
Polarity:	Vertical		

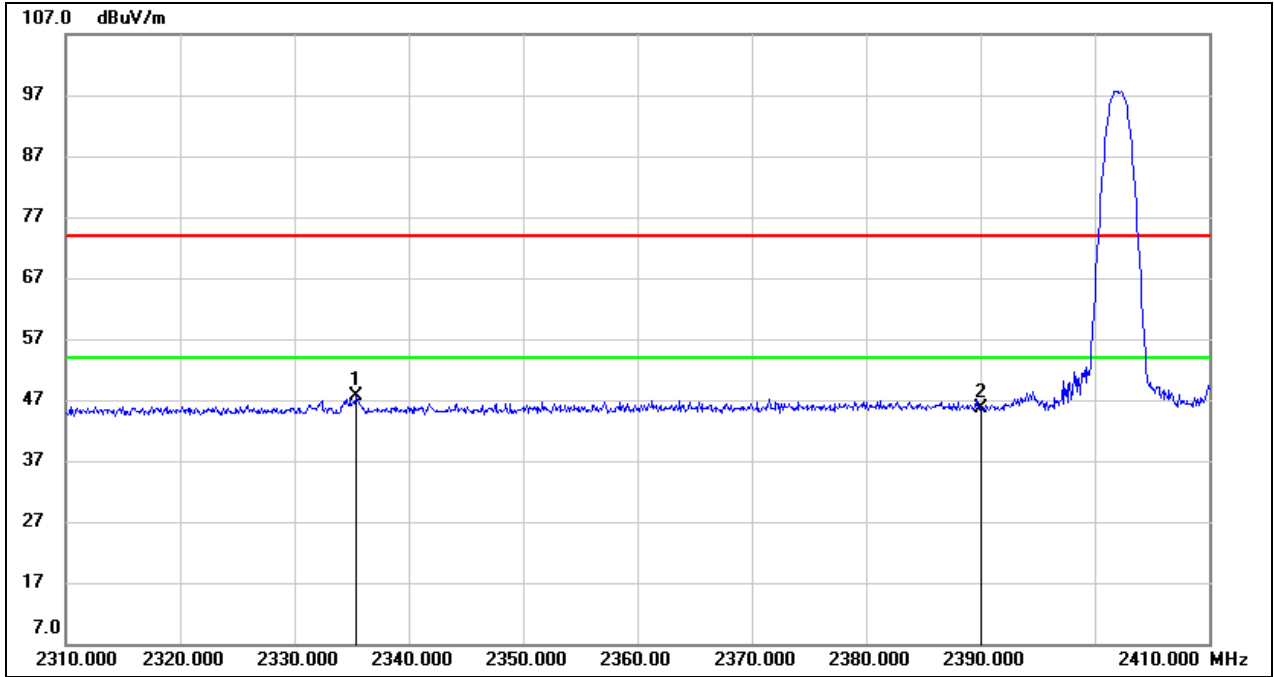

No.	Frequency (MHz)	Reading (dBuV)	Correct (dB/m)	Result (dBuV/m)	Limit (dBuV/m)	Margin (dB)	Remark
1	2335.400	15.53	31.99	47.52	74.00	-26.48	peak
2	2390.000	13.42	32.16	45.58	74.00	-28.42	peak





Test Mode:	BLE 1M PK	Channel:	2480
Polarity:	Horizontal		

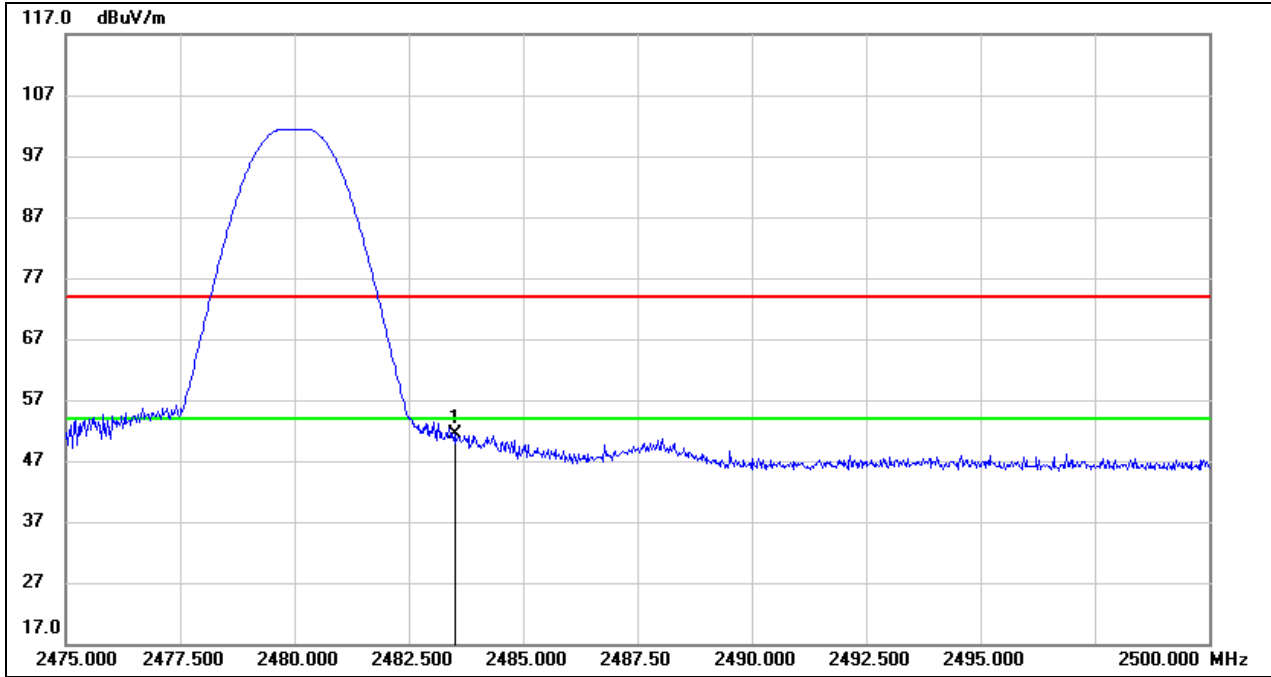

No.	Frequency (MHz)	Reading (dBuV)	Correct (dB/m)	Result (dBuV/m)	Limit (dBuV/m)	Margin (dB)	Remark
1	2483.500	19.03	32.44	51.47	74.00	-22.53	peak



Test Mode:	BLE 1M AV	Channel:	2480
Polarity:	Horizontal		

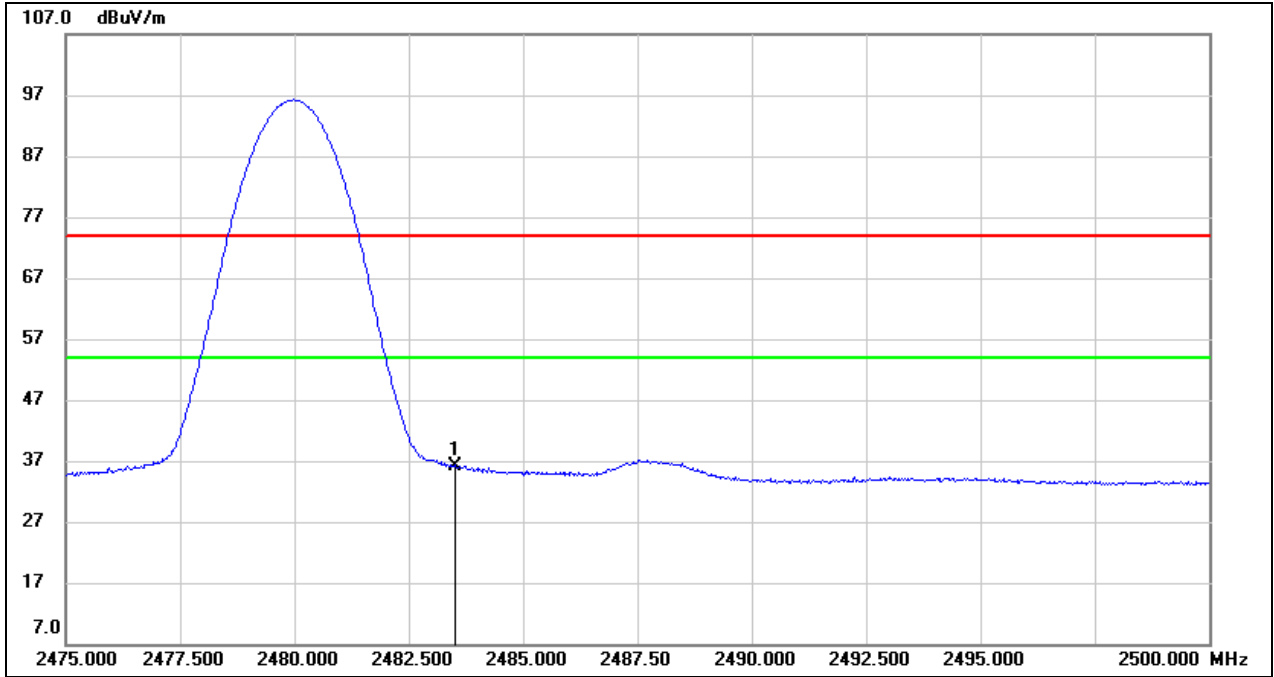

No.	Frequency (MHz)	Reading (dBuV)	Correct (dB/m)	Result (dBuV/m)	Limit (dBuV/m)	Margin (dB)	Remark
1	2483.500	3.76	32.44	36.20	54.00	-17.80	AVG



Test Mode:	BLE 2M PK	Channel:	2402
Polarity:	Horizontal		

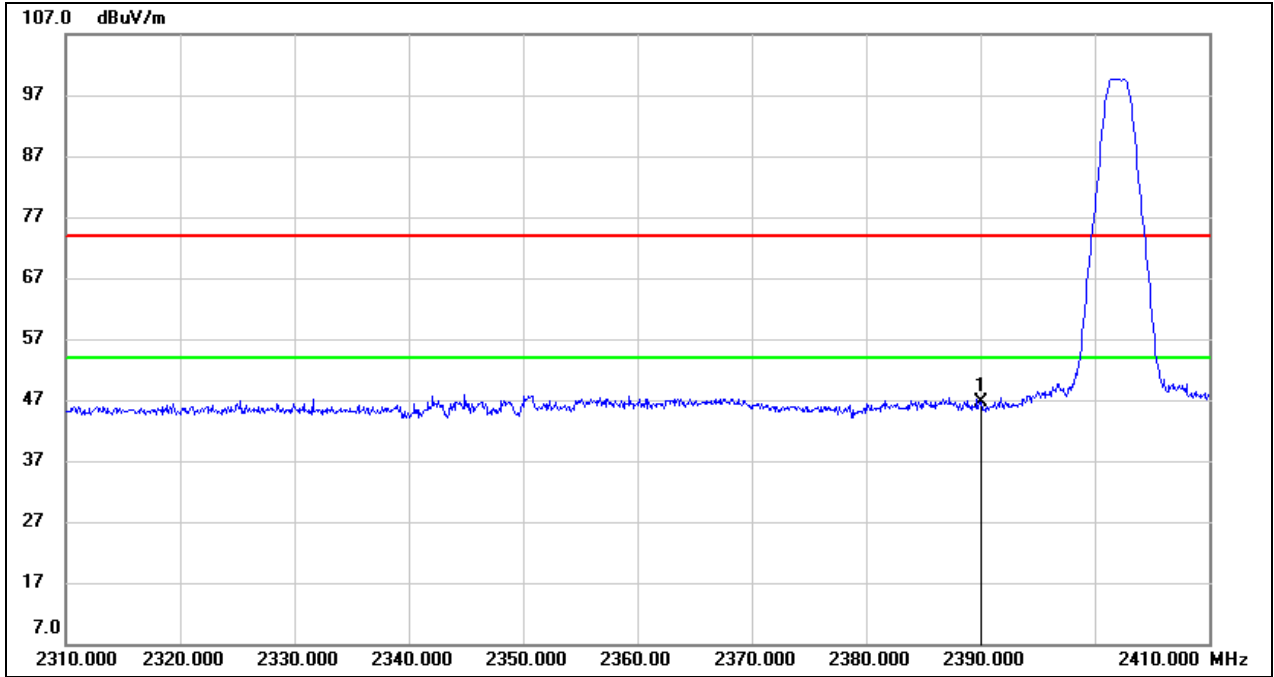

No.	Frequency (MHz)	Reading (dBuV)	Correct (dB/m)	Result (dBuV/m)	Limit (dBuV/m)	Margin (dB)	Remark
1	2390.000	14.47	32.16	46.63	74.00	-27.37	peak



Test Mode:	BLE 2M PK	Channel:	2480
Polarity:	Horizontal		

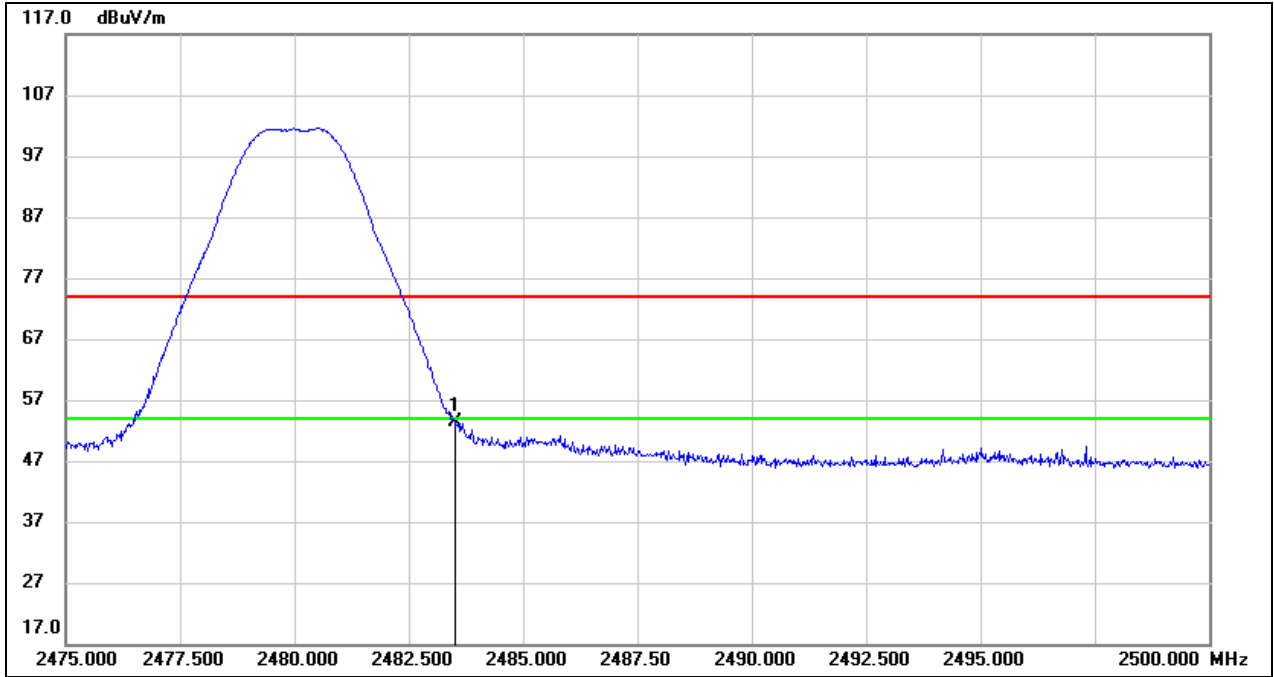

No.	Frequency (MHz)	Reading (dBuV)	Correct (dB/m)	Result (dBuV/m)	Limit (dBuV/m)	Margin (dB)	Remark
1	2483.500	20.94	32.44	53.38	74.00	-20.62	peak



Test Mode:	BLE 2M AV	Channel:	2480
Polarity:	Horizontal		

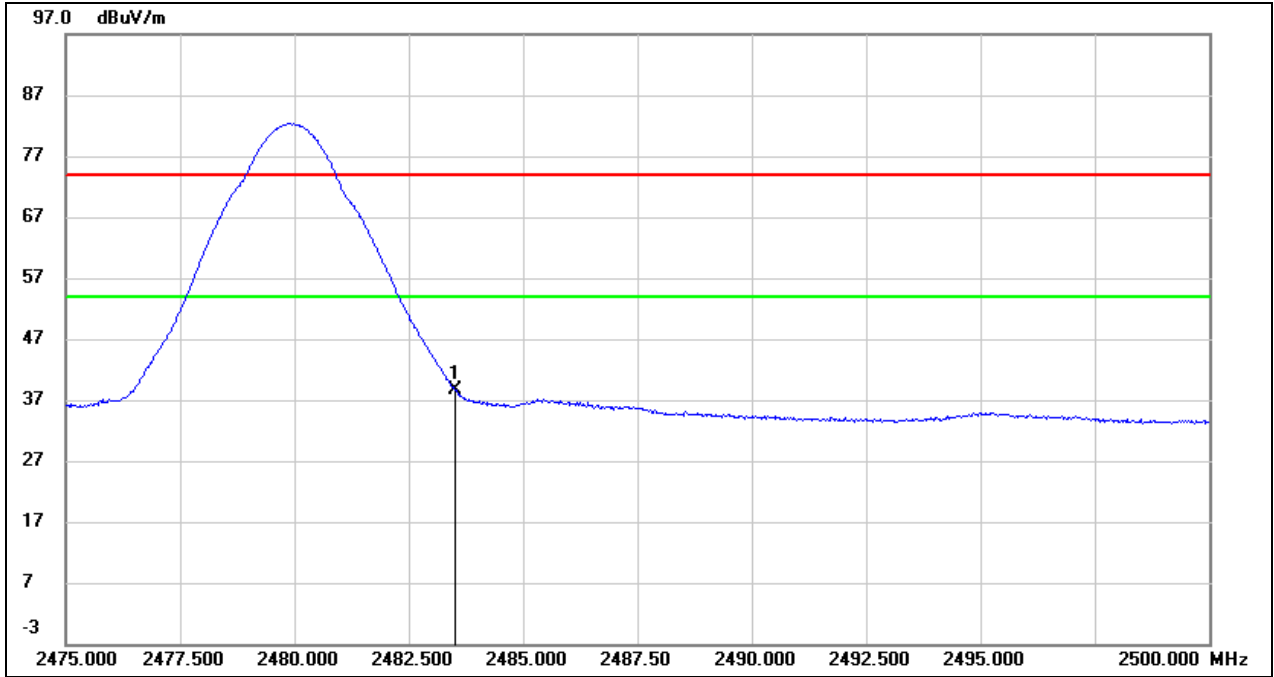

No.	Frequency (MHz)	Reading (dBuV)	Correct (dB/m)	Result (dBuV/m)	Limit (dBuV/m)	Margin (dB)	Remark
1	2483.500	6.25	32.44	38.69	54.00	-15.31	AVG



### 8.2. RESTRICTED BANDEDGE WITH CHARGING WORST CASE

Test Mode:	BLE 2M PK	Channel:	2480
Polarity:	Horizontal	Charger:	PMPN4284A

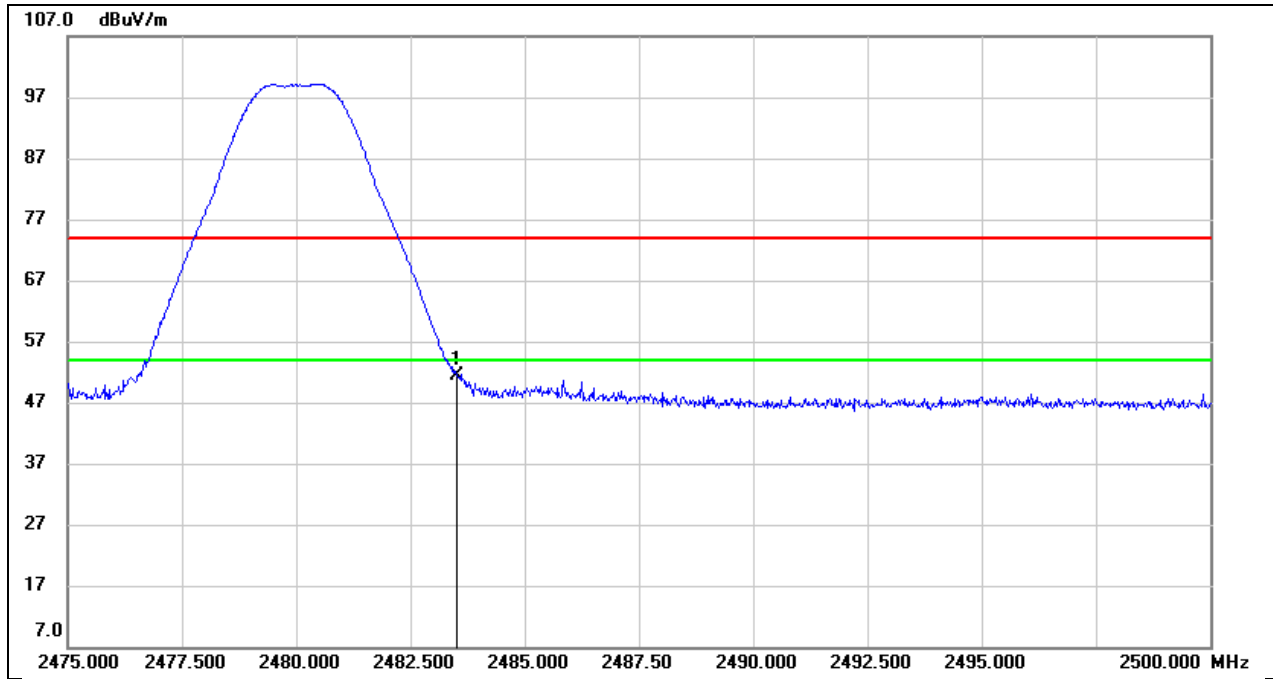

No.	Frequency (MHz)	Reading (dBuV)	Correct (dB/m)	Result (dBuV/m)	Limit (dBuV/m)	Margin (dB)	Remark
1	2483.500	19.02	32.44	51.46	74.00	-22.54	peak



Test Mode:	BLE 2M AV	Channel:	2480
Polarity:	Horizontal	Charger:	PMPN4284A

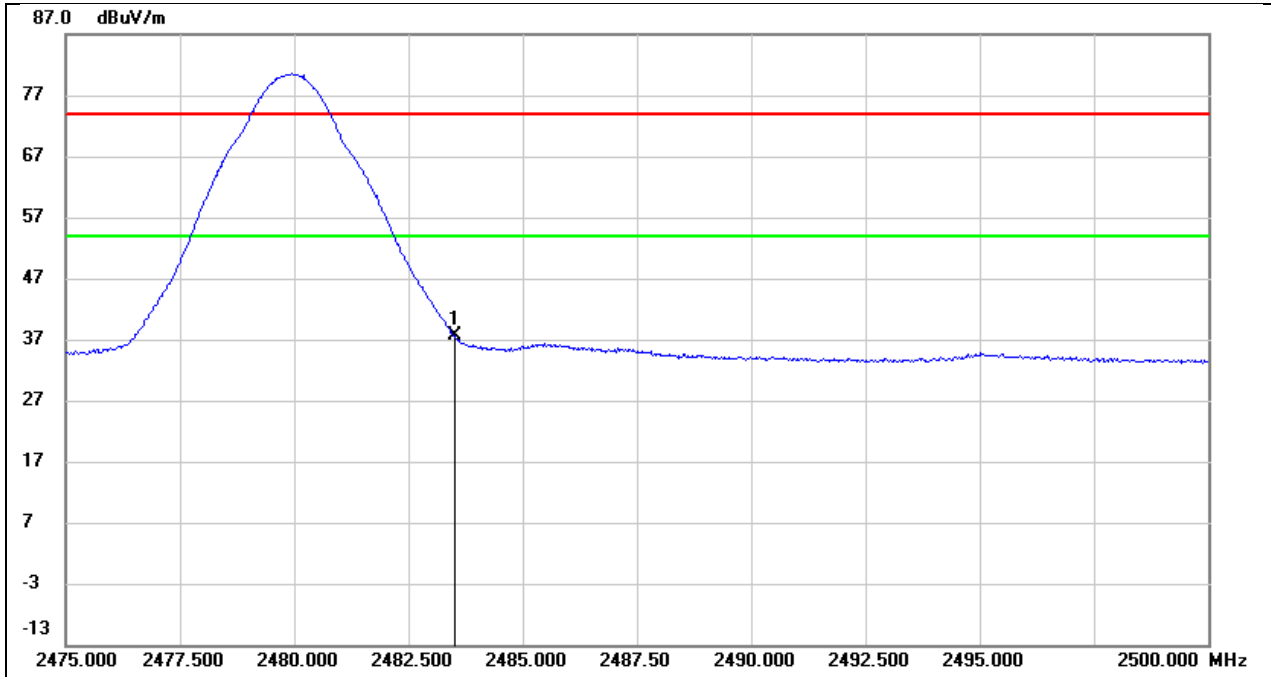

No.	Frequency (MHz)	Reading (dBuV)	Correct (dB/m)	Result (dBuV/m)	Limit (dBuV/m)	Margin (dB)	Remark
1	2483.500	5.12	32.44	37.56	54.00	-16.44	AVG



### 8.3. SPURIOUS EMISSIONS(1 GHz~3 GHz)

Test Mode:	BLE 1M	Channel:	2402
Polarity:	Horizontal		

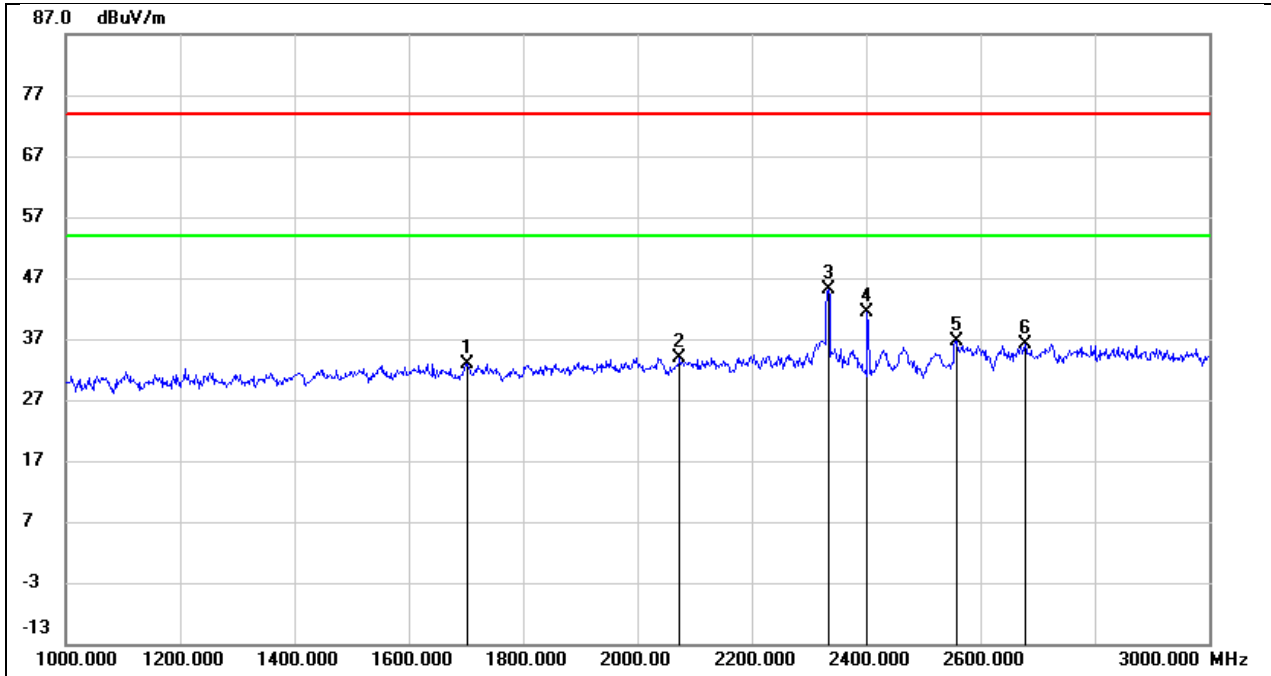

No.	Frequency (MHz)	Reading (dBuV)	Correct (dB/m)	Result (dBuV/m)	Limit (dBuV/m)	Margin (dB)	Remark
1	1702.000	44.96	-12.05	32.91	74.00	-41.09	peak
2	2074.000	44.59	-10.68	33.91	74.00	-40.09	peak
3	2334.000	54.47	-9.35	45.12	74.00	-28.88	peak
4	2402.000	50.35	-8.99	41.36	74.00	-32.64	peak
5	2558.000	45.02	-8.32	36.70	74.00	-37.30	peak
6	2678.000	44.05	-7.96	36.09	74.00	-37.91	peak





Test Mode:	BLE 1M	Channel:	2402
Polarity:	Vertical		

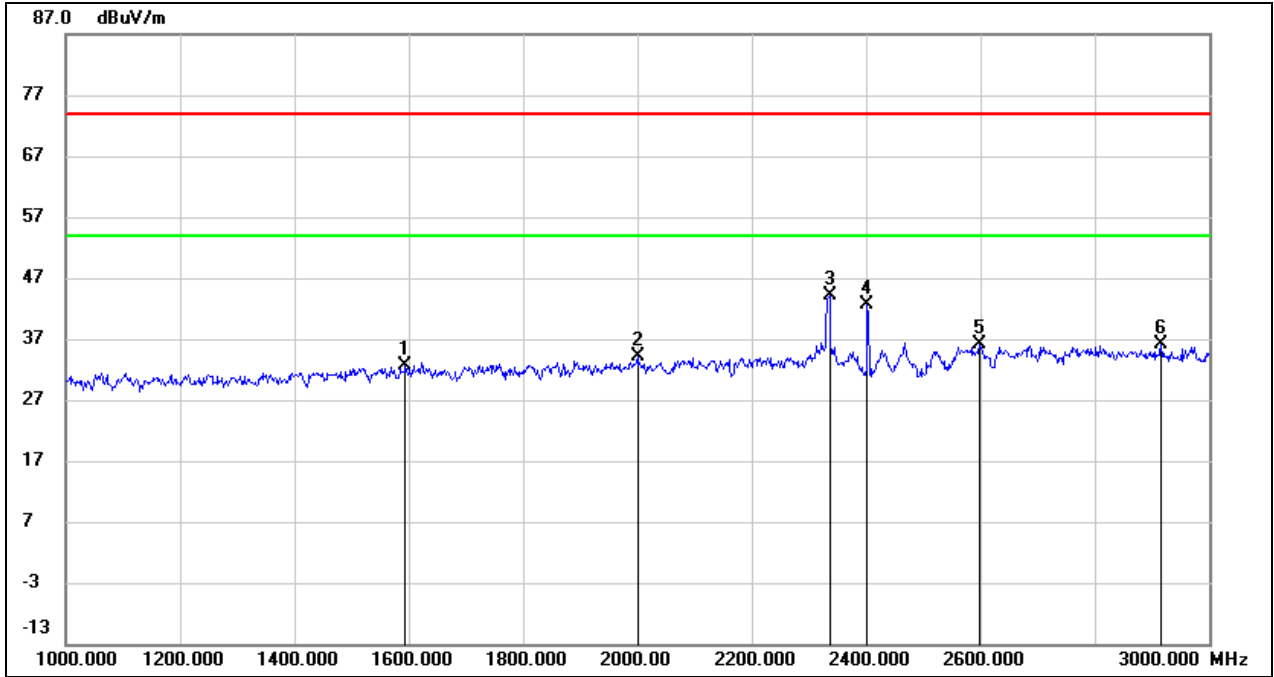

No.	Frequency (MHz)	Reading (dBuV)	Correct (dB/m)	Result (dBuV/m)	Limit (dBuV/m)	Margin (dB)	Remark
1	1594.000	44.96	-12.40	32.56	74.00	-41.44	peak
2	2000.000	45.31	-11.06	34.25	74.00	-39.75	peak
3	2336.000	53.52	-9.33	44.19	74.00	-29.81	peak
4	2402.000	51.70	-8.99	42.71	74.00	-31.29	peak
5	2598.000	44.36	-8.19	36.17	74.00	-37.83	peak
6	2916.000	43.29	-7.23	36.06	74.00	-37.94	peak



Test Mode:	BLE 1M	Channel:	2440
Polarity:	Horizontal		

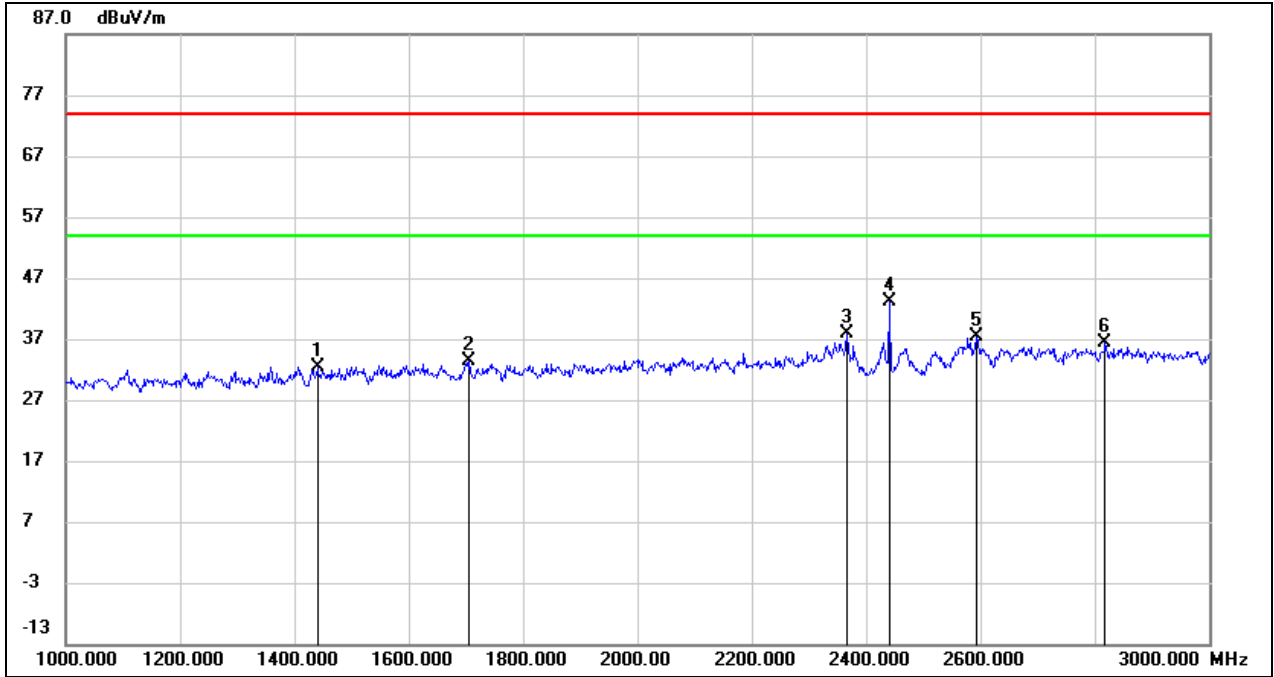

No.	Frequency (MHz)	Reading (dBuV)	Correct (dB/m)	Result (dBuV/m)	Limit (dBuV/m)	Margin (dB)	Remark
1	1440.000	45.41	-12.98	32.43	74.00	-41.57	peak
2	1706.000	45.52	-12.03	33.49	74.00	-40.51	peak
3	2366.000	47.12	-9.18	37.94	74.00	-36.06	peak
4	2440.000	52.02	-8.80	43.22	74.00	-30.78	peak
5	2594.000	45.66	-8.20	37.46	74.00	-36.54	peak
6	2818.000	43.98	-7.53	36.45	74.00	-37.55	peak



Test Mode:	BLE 1M	Channel:	2440
Polarity:	Vertical		

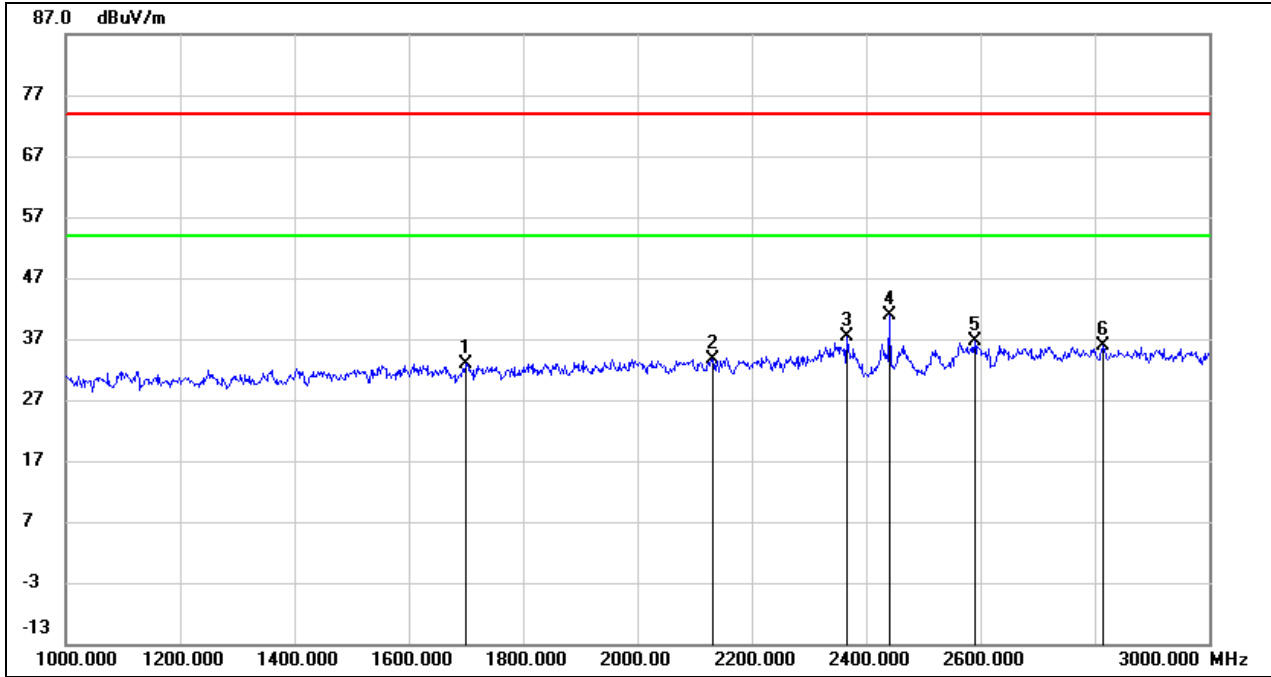

No.	Frequency (MHz)	Reading (dBuV)	Correct (dB/m)	Result (dBuV/m)	Limit (dBuV/m)	Margin (dB)	Remark
1	1700.000	45.01	-12.05	32.96	74.00	-41.04	peak
2	2132.000	44.10	-10.39	33.71	74.00	-40.29	peak
3	2366.000	46.58	-9.18	37.40	74.00	-36.60	peak
4	2440.000	49.74	-8.80	40.94	74.00	-33.06	peak
5	2590.000	44.80	-8.22	36.58	74.00	-37.42	peak
6	2814.000	43.45	-7.54	35.91	74.00	-38.09	peak



Test Mode:	BLE 1M	Channel:	2480
Polarity:	Horizontal		

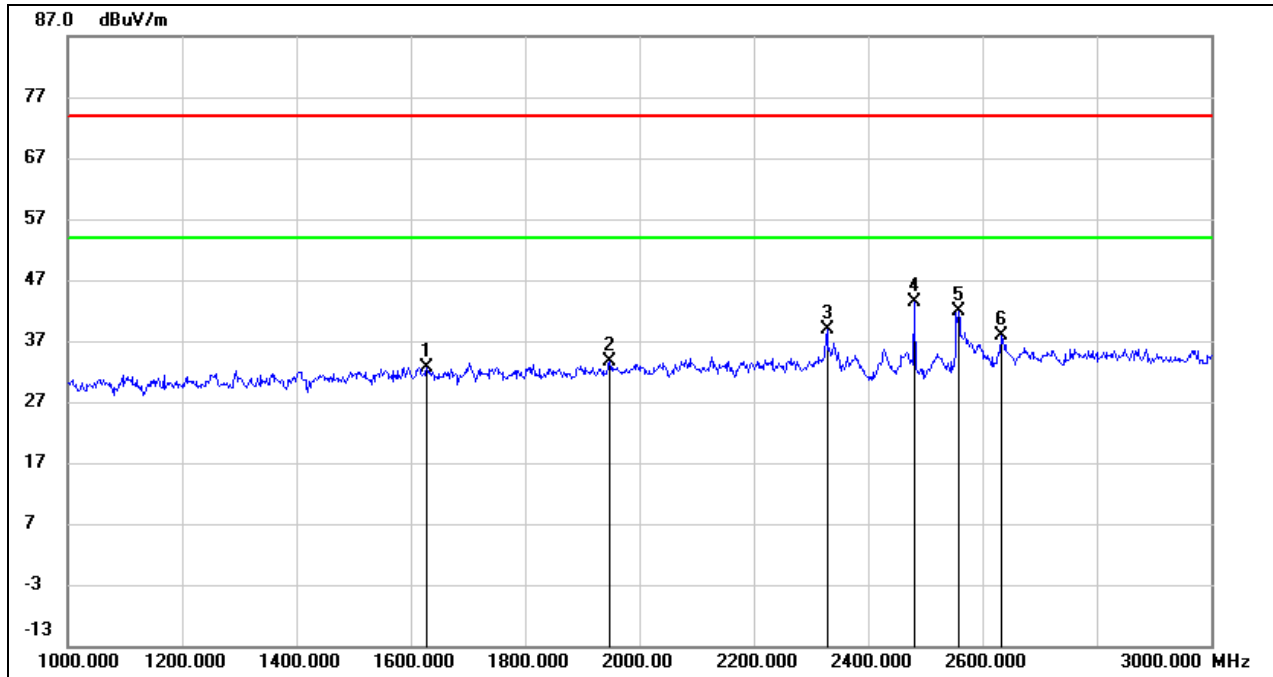

No.	Frequency (MHz)	Reading (dBuV)	Correct (dB/m)	Result (dBuV/m)	Limit (dBuV/m)	Margin (dB)	Remark
1	1628.000	44.98	-12.28	32.70	74.00	-41.30	peak
2	1948.000	44.92	-11.23	33.69	74.00	-40.31	peak
3	2328.000	48.24	-9.38	38.86	74.00	-35.14	peak
4	2480.000	51.93	-8.59	43.34	74.00	-30.66	peak
5	2558.000	50.09	-8.32	41.77	74.00	-32.23	peak
6	2632.000	45.87	-8.09	37.78	74.00	-36.22	peak



Test Mode:	BLE 1M	Channel:	2480
Polarity:	Vertical		

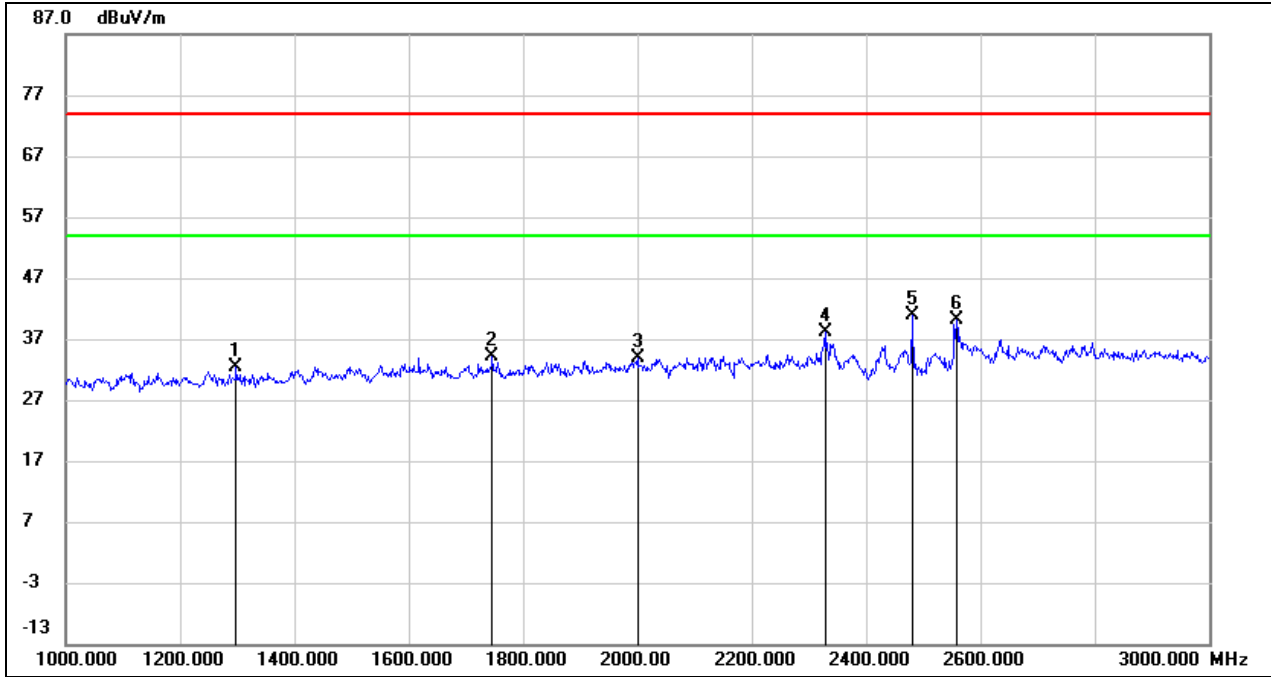

No.	Frequency (MHz)	Reading (dBuV)	Correct (dB/m)	Result (dBuV/m)	Limit (dBuV/m)	Margin (dB)	Remark
1	1298.000	46.00	-13.65	32.35	74.00	-41.65	peak
2	1746.000	45.96	-11.90	34.06	74.00	-39.94	peak
3	2000.000	44.82	-11.06	33.76	74.00	-40.24	peak
4	2328.000	47.62	-9.38	38.24	74.00	-35.76	peak
5	2480.000	49.43	-8.59	40.84	74.00	-33.16	peak
6	2558.000	48.38	-8.32	40.06	74.00	-33.94	peak



### 8.4. SPURIOUS EMISSIONS WITH CHARGING WORST CASE(1 GHZ~3 GHZ)

Test Mode:	BLE 2M	Channel:	2480
Polarity:	Horizontal	Charger:	PMPN4284A

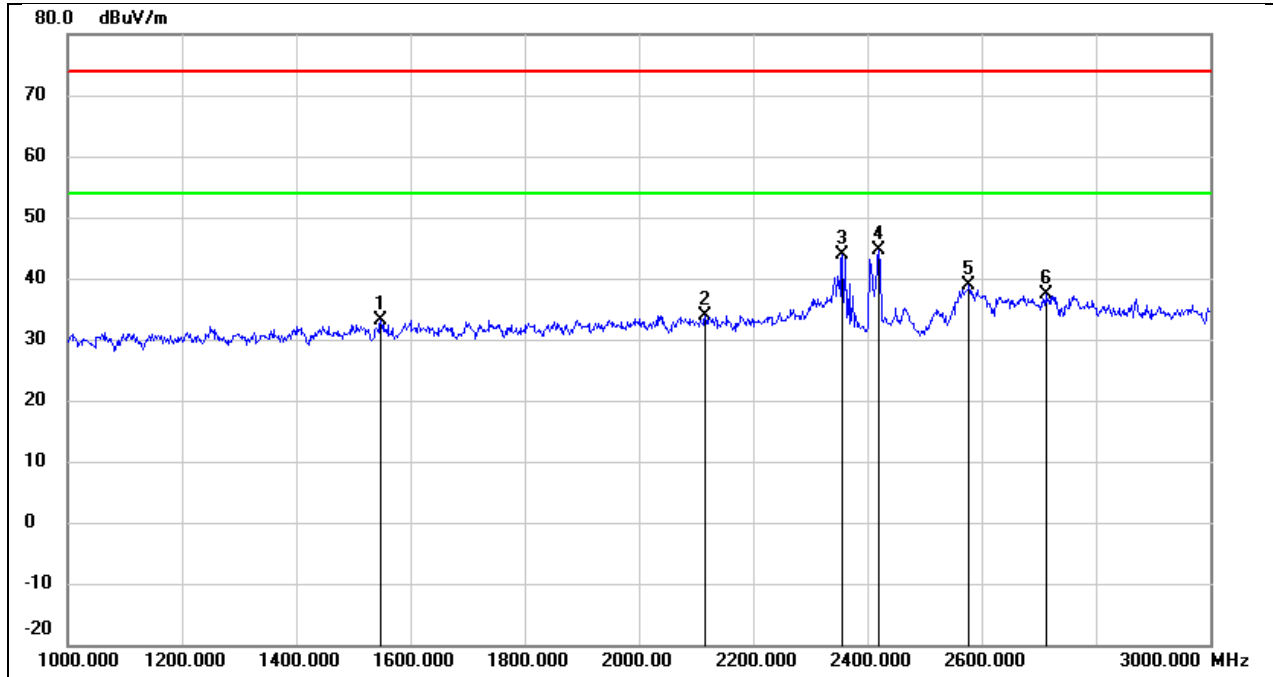

No.	Frequency (MHz)	Reading (dBuV)	Correct (dB/m)	Result (dBuV/m)	Limit (dBuV/m)	Margin (dB)	Remark
1	1548.000	45.61	-12.55	33.06	74.00	-40.94	peak
2	2116.000	44.45	-10.47	33.98	74.00	-40.02	peak
3	2356.000	53.16	-9.22	43.94	74.00	-30.06	peak
4	2420.000	53.62	-8.91	44.71	74.00	-29.29	peak
5	2578.000	47.18	-8.26	38.92	74.00	-35.08	peak
6	2712.000	45.25	-7.85	37.40	74.00	-36.60	peak



Test Mode:	BLE 2M	Channel:	2480
Polarity:	Vertical	Charger:	PMPN4284A

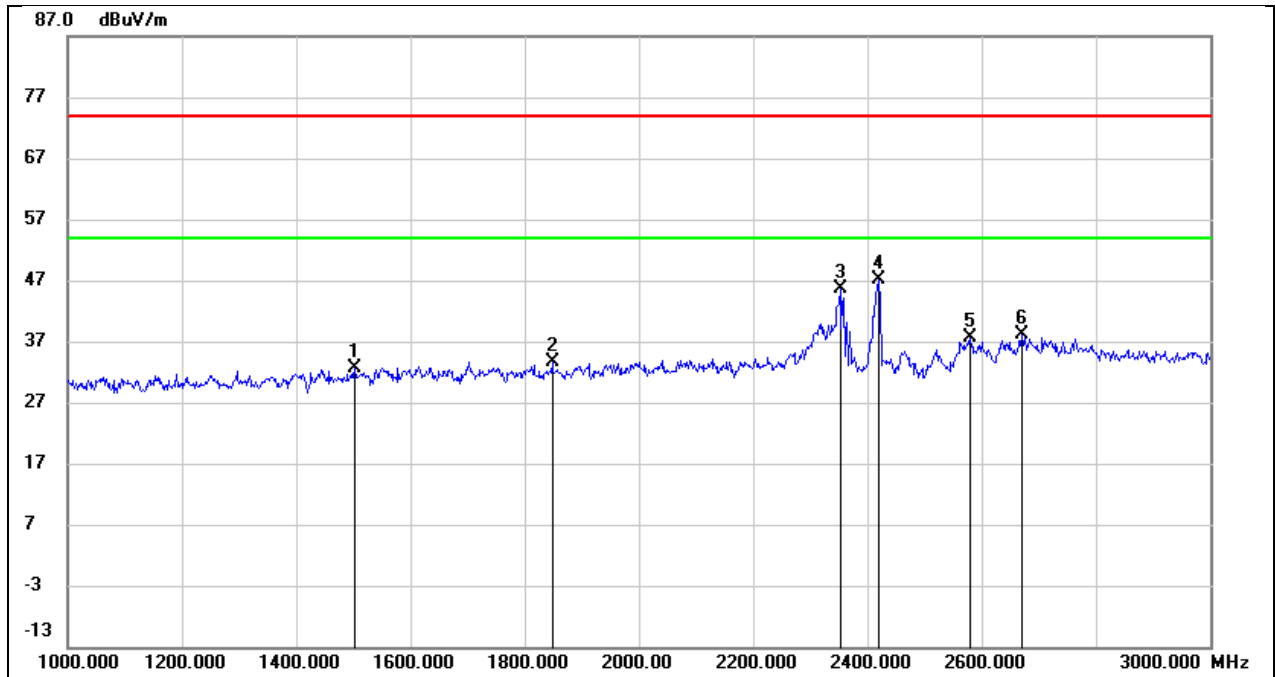

No.	Frequency (MHz)	Reading (dBuV)	Correct (dB/m)	Result (dBuV/m)	Limit (dBuV/m)	Margin (dB)	Remark
1	1502.000	45.30	-12.71	32.59	74.00	-41.41	peak
2	1848.000	45.17	-11.56	33.61	74.00	-40.39	peak
3	2352.000	54.84	-9.24	45.60	74.00	-28.40	peak
4	2420.000	56.07	-8.91	47.16	74.00	-26.84	peak
5	2580.000	45.86	-8.25	37.61	74.00	-36.39	peak
6	2670.000	46.19	-7.97	38.22	74.00	-35.78	peak



### 8.5. SPURIOUS EMISSIONS(3 GHz~18 GHz)

Test Mode:	BLE 1M	Channel:	2402
Polarity:	Horizontal		

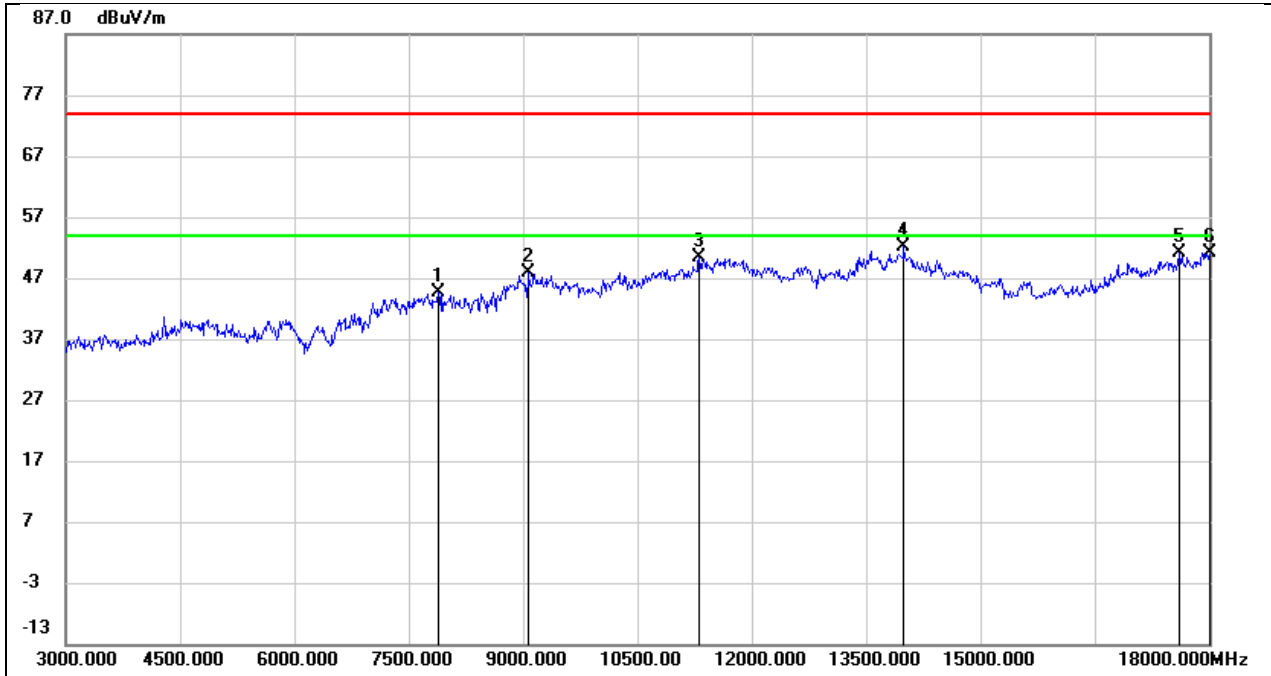

No.	Frequency (MHz)	Reading (dBuV)	Correct (dB/m)	Result (dBuV/m)	Limit (dBuV/m)	Margin (dB)	Remark
1	7890.000	38.26	6.31	44.57	74.00	-29.43	peak
2	9075.000	37.29	10.52	47.81	74.00	-26.19	peak
3	11310.000	34.36	15.91	50.27	74.00	-23.73	peak
4	13995.000	30.10	21.95	52.05	74.00	-21.95	peak
5	17610.000	27.66	23.38	51.04	74.00	-22.96	peak
6	18000.000	25.35	25.69	51.04	74.00	-22.96	peak





Test Mode:	BLE 1M	Channel:	2402
Polarity:	Vertical		

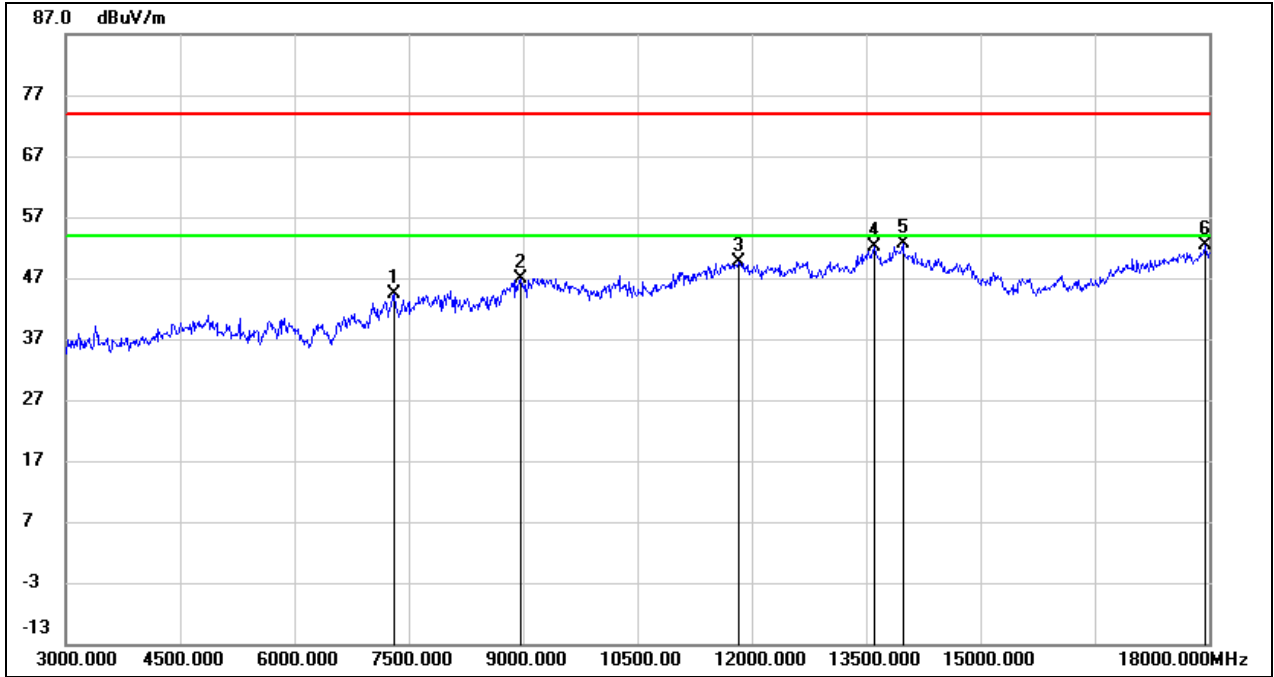

No.	Frequency (MHz)	Reading (dBuV)	Correct (dB/m)	Result (dBuV/m)	Limit (dBuV/m)	Margin (dB)	Remark
1	7305.000	37.98	6.47	44.45	74.00	-29.55	peak
2	8970.000	36.73	10.26	46.99	74.00	-27.01	peak
3	11820.000	32.04	17.47	49.51	74.00	-24.49	peak
4	13605.000	31.05	21.12	52.17	74.00	-21.83	peak
5	13980.000	30.67	21.92	52.59	74.00	-21.41	peak
6	17940.000	27.12	25.34	52.46	74.00	-21.54	peak



Test Mode:	BLE 1M	Channel:	2440
Polarity:	Horizontal		

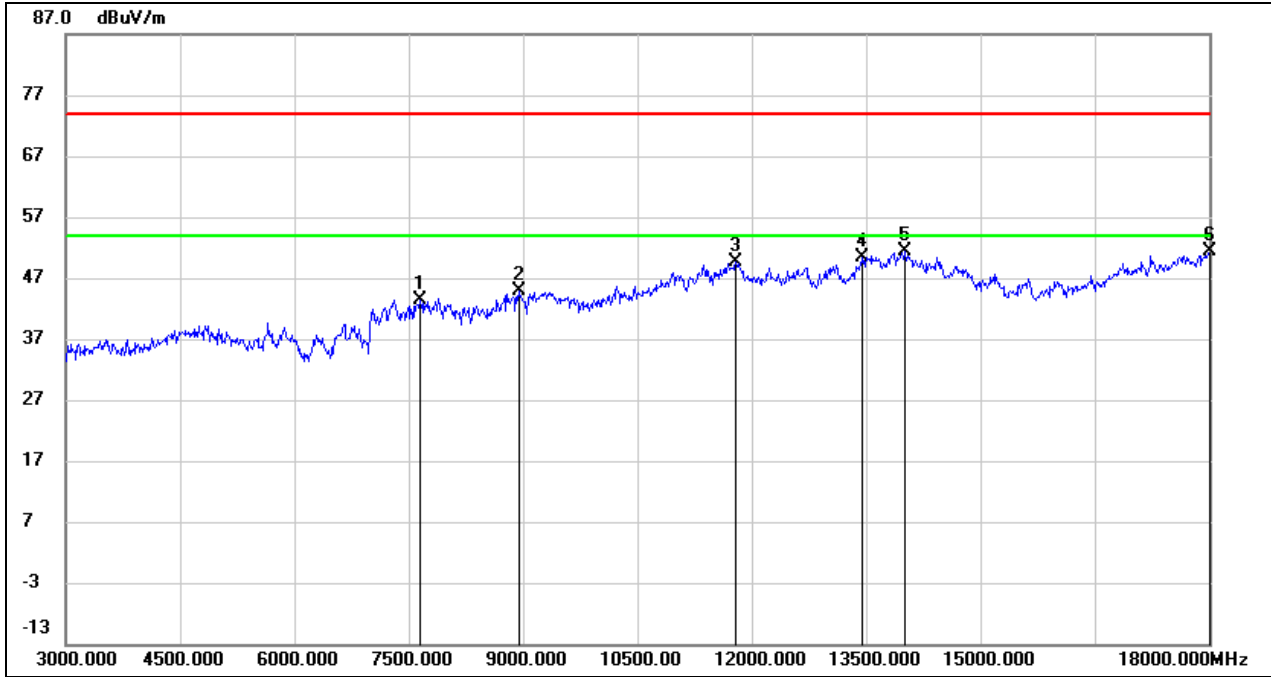

No.	Frequency (MHz)	Reading (dBuV)	Correct (dB/m)	Result (dBuV/m)	Limit (dBuV/m)	Margin (dB)	Remark
1	7650.000	37.14	6.33	43.47	74.00	-30.53	peak
2	8940.000	34.93	10.04	44.97	74.00	-29.03	peak
3	11790.000	32.15	17.38	49.53	74.00	-24.47	peak
4	13455.000	29.74	20.71	50.45	74.00	-23.55	peak
5	14010.000	29.33	21.93	51.26	74.00	-22.74	peak
6	18000.000	25.69	25.69	51.38	74.00	-22.62	peak



Test Mode:	BLE 1M	Channel:	2440
Polarity:	Vertical		

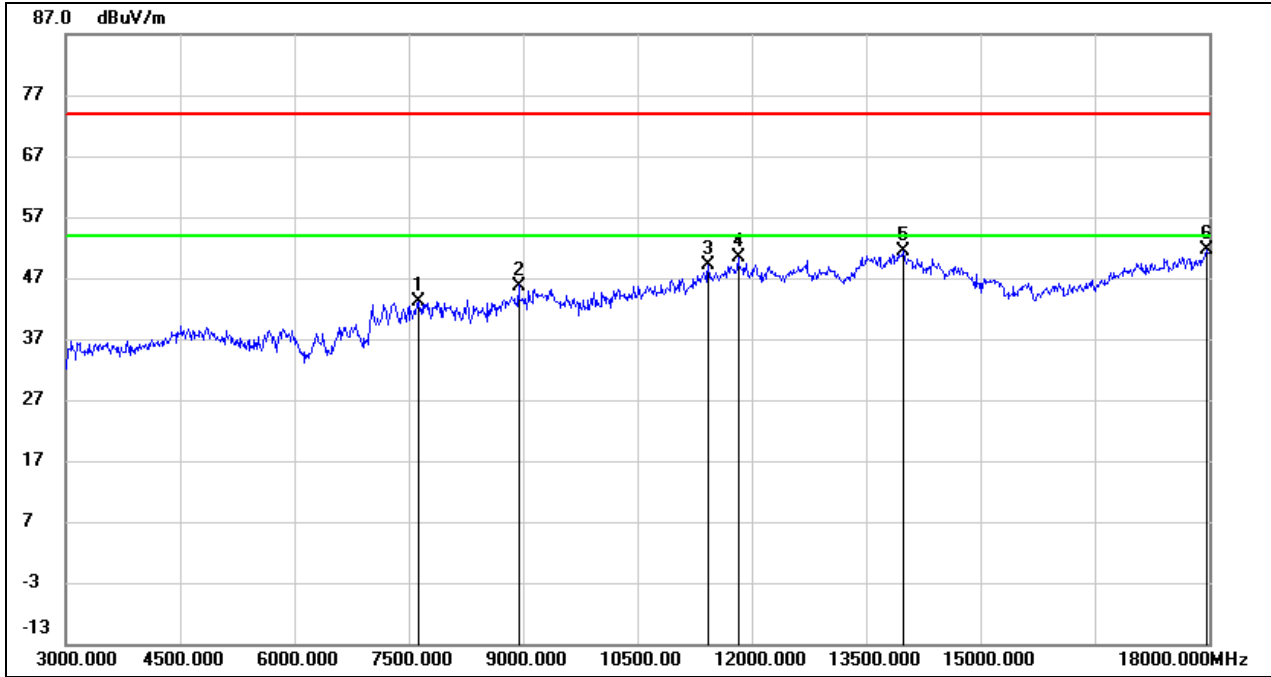

No.	Frequency (MHz)	Reading (dBuV)	Correct (dB/m)	Result (dBuV/m)	Limit (dBuV/m)	Margin (dB)	Remark
1	7620.000	36.74	6.33	43.07	74.00	-30.93	peak
2	8940.000	35.71	10.04	45.75	74.00	-28.25	peak
3	11430.000	32.84	16.34	49.18	74.00	-24.82	peak
4	11820.000	32.83	17.47	50.30	74.00	-23.70	peak
5	13995.000	29.38	21.95	51.33	74.00	-22.67	peak
6	17970.000	26.08	25.51	51.59	74.00	-22.41	peak



Test Mode:	BLE 1M	Channel:	2480
Polarity:	Horizontal		

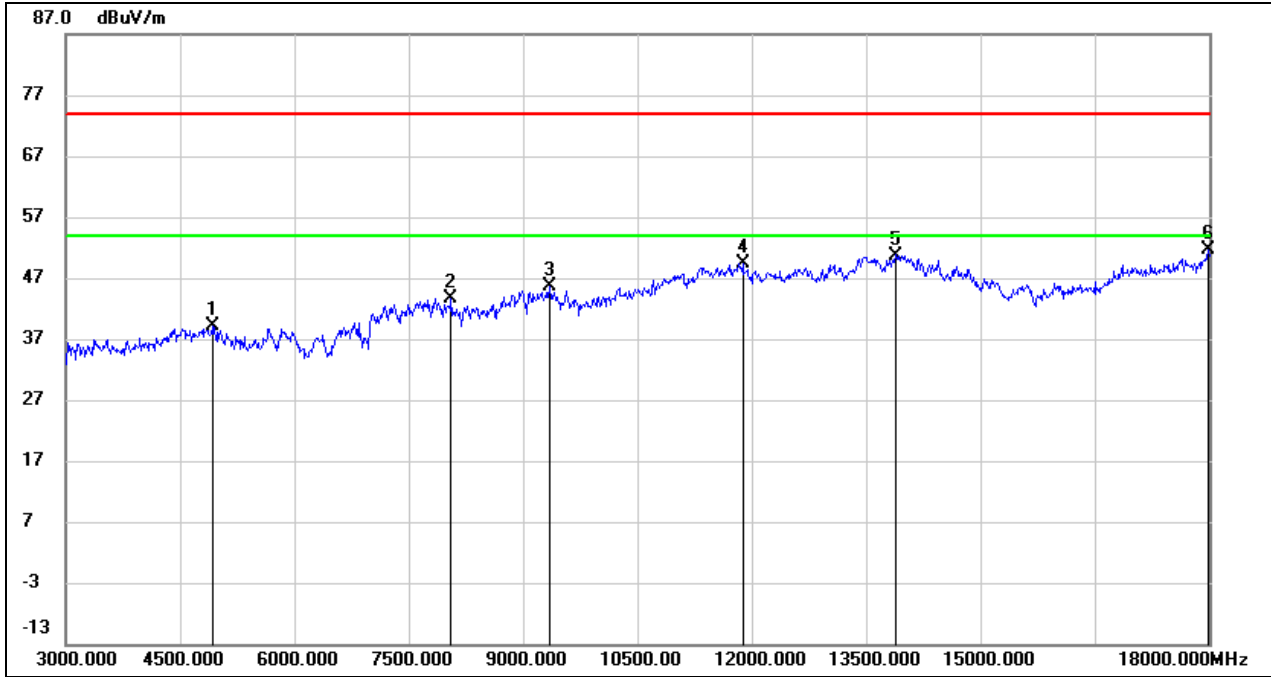

No.	Frequency (MHz)	Reading (dBuV)	Correct (dB/m)	Result (dBuV/m)	Limit (dBuV/m)	Margin (dB)	Remark
1	4920.000	39.07	0.14	39.21	74.00	-34.79	peak
2	8055.000	37.30	6.37	43.67	74.00	-30.33	peak
3	9345.000	34.92	10.63	45.55	74.00	-28.45	peak
4	11880.000	31.84	17.63	49.47	74.00	-24.53	peak
5	13890.000	29.03	21.72	50.75	74.00	-23.25	peak
6	17985.000	25.92	25.60	51.52	74.00	-22.48	peak



Test Mode:	BLE 1M	Channel:	2480
Polarity:	Vertical		

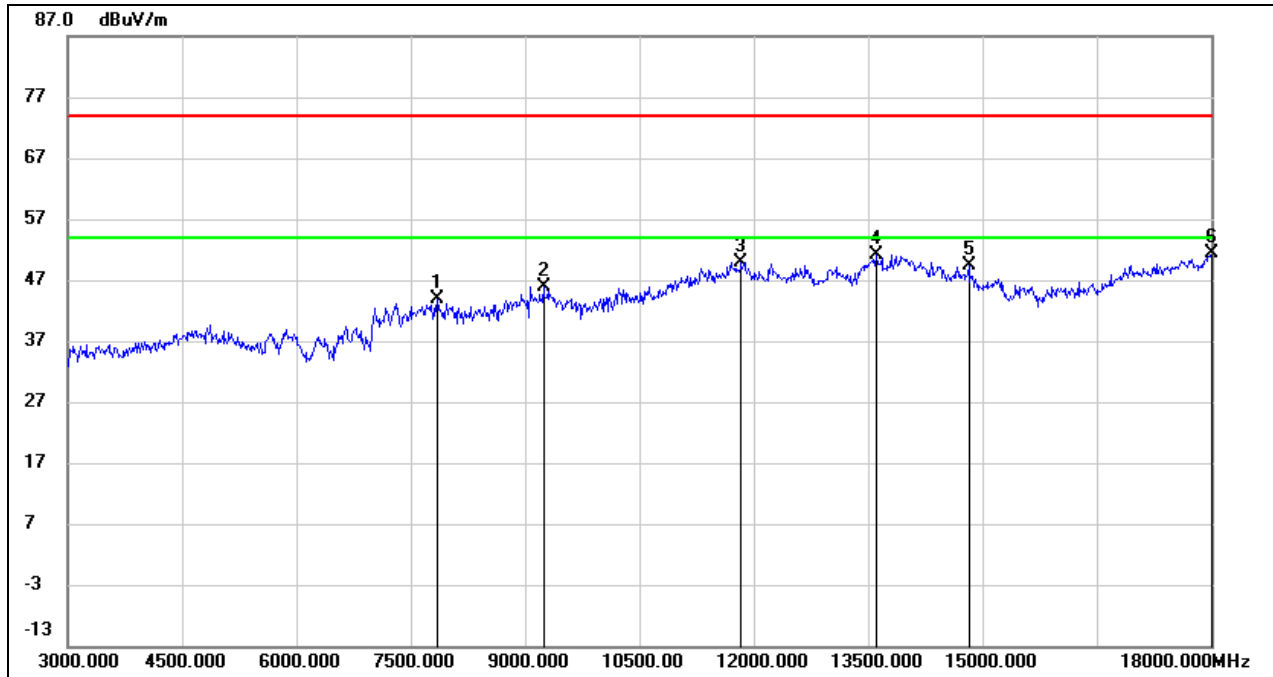

No.	Frequency (MHz)	Reading (dBuV)	Correct (dB/m)	Result (dBuV/m)	Limit (dBuV/m)	Margin (dB)	Remark
1	7845.000	37.60	6.32	43.92	74.00	-30.08	peak
2	9240.000	35.37	10.58	45.95	74.00	-28.05	peak
3	11835.000	32.40	17.51	49.91	74.00	-24.09	peak
4	13605.000	30.11	21.12	51.23	74.00	-22.77	peak
5	14820.000	30.64	18.62	49.26	74.00	-24.74	peak
6	18000.000	25.57	25.69	51.26	74.00	-22.74	peak



Test Mode:	BLE 2M	Channel:	2402
Polarity:	Horizontal		

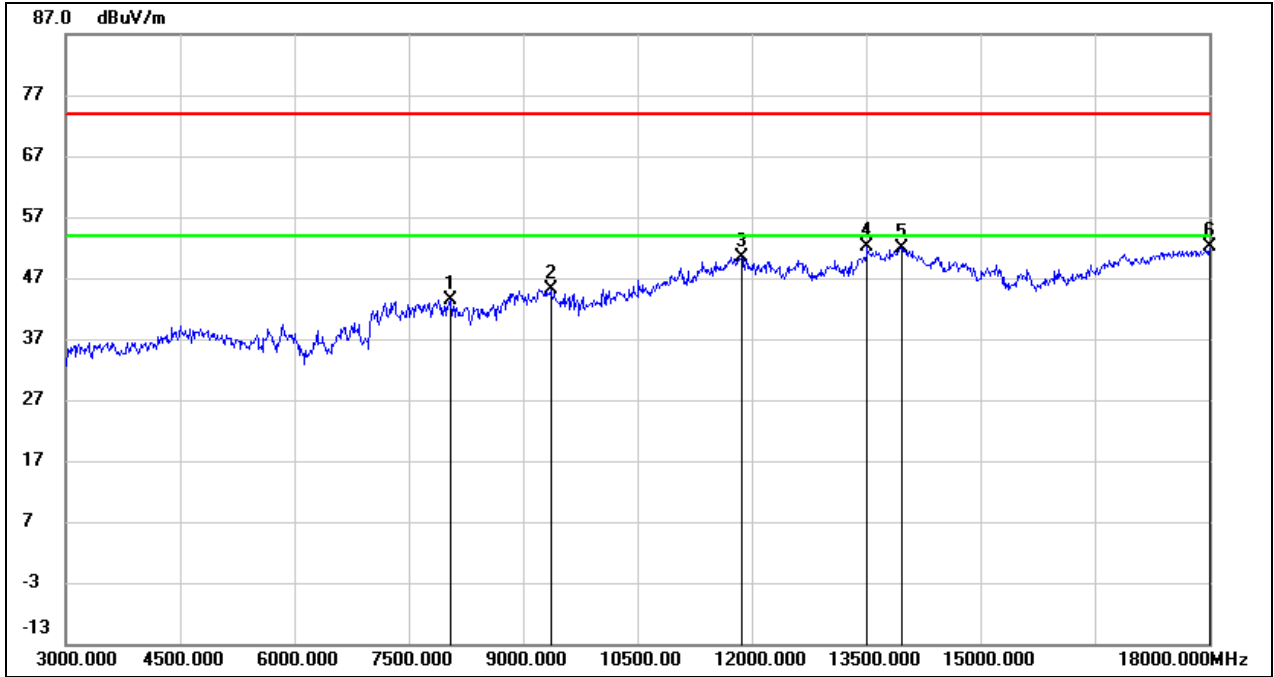

No.	Frequency (MHz)	Reading (dBuV)	Correct (dB/m)	Result (dBuV/m)	Limit (dBuV/m)	Margin (dB)	Remark
1	8055.000	36.98	6.37	43.35	74.00	-30.65	peak
2	9360.000	34.58	10.64	45.22	74.00	-28.78	peak
3	11865.000	32.90	17.59	50.49	74.00	-23.51	peak
4	13515.000	31.23	20.93	52.16	74.00	-21.84	peak
5	13965.000	29.96	21.89	51.85	74.00	-22.15	peak
6	18000.000	26.32	25.69	52.01	74.00	-21.99	peak



Test Mode:	BLE 2M	Channel:	2402
Polarity:	Vertical		

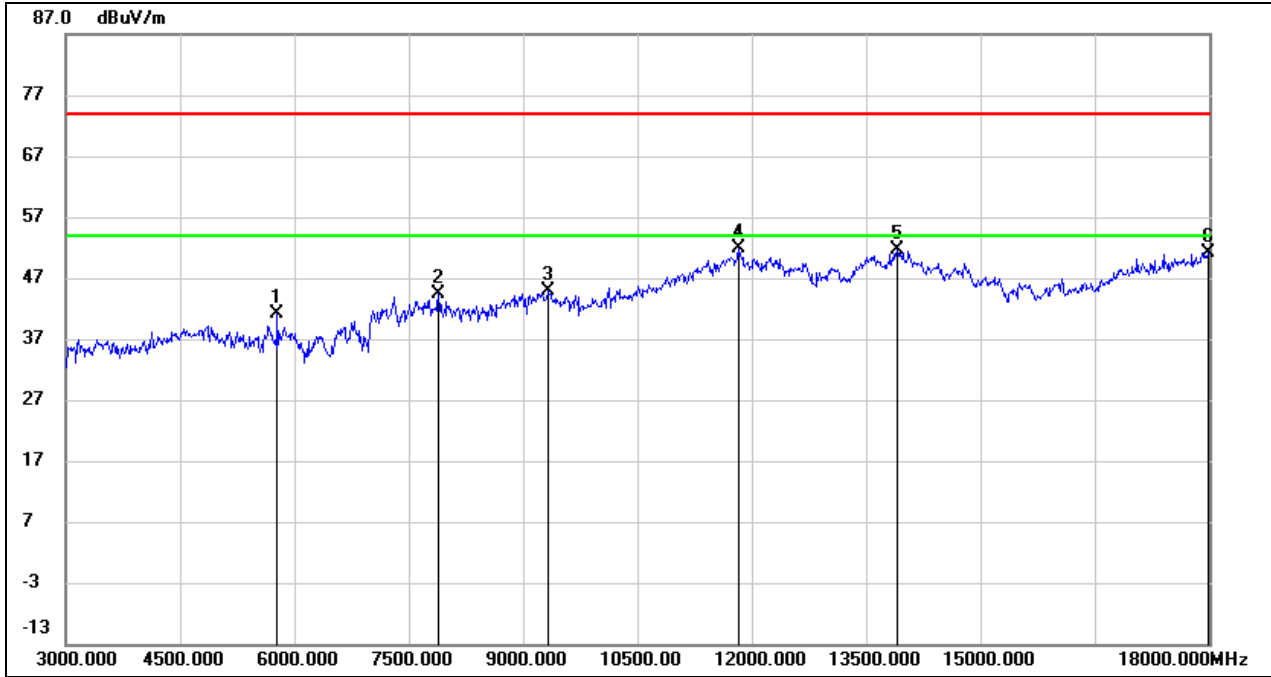

No.	Frequency (MHz)	Reading (dBuV)	Correct (dB/m)	Result (dBuV/m)	Limit (dBuV/m)	Margin (dB)	Remark
1	5775.000	39.58	1.63	41.21	74.00	-32.79	peak
2	7890.000	38.06	6.31	44.37	74.00	-29.63	peak
3	9330.000	34.29	10.62	44.91	74.00	-29.09	peak
4	11820.000	34.49	17.47	51.96	74.00	-22.04	peak
5	13905.000	29.86	21.76	51.62	74.00	-22.38	peak
6	17985.000	25.57	25.60	51.17	74.00	-22.83	peak



Test Mode:	BLE 2M	Channel:	2440
Polarity:	Horizontal		

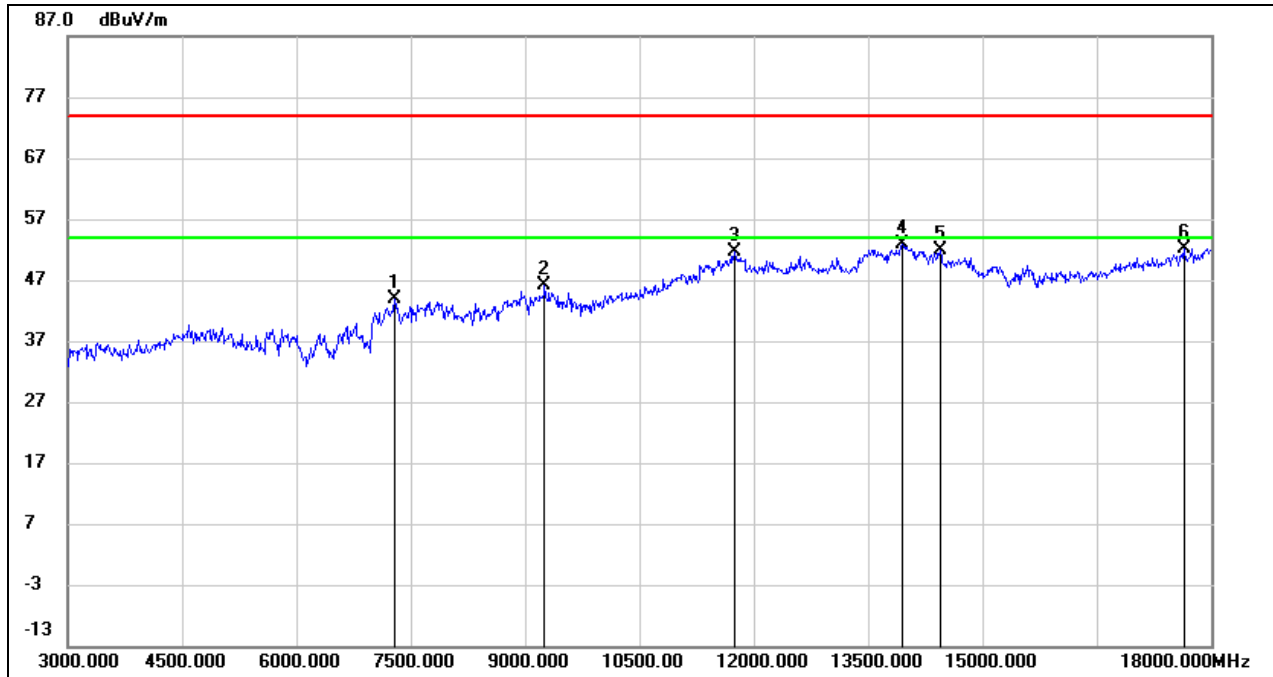

No.	Frequency (MHz)	Reading (dBuV)	Correct (dB/m)	Result (dBuV/m)	Limit (dBuV/m)	Margin (dB)	Remark
1	7290.000	37.30	6.48	43.78	74.00	-30.22	peak
2	9255.000	35.44	10.59	46.03	74.00	-27.97	peak
3	11745.000	34.35	17.27	51.62	74.00	-22.38	peak
4	13950.000	31.07	21.86	52.93	74.00	-21.07	peak
5	14445.000	31.67	20.14	51.81	74.00	-22.19	peak
6	17640.000	28.50	23.56	52.06	74.00	-21.94	peak





Test Mode:	BLE 2M	Channel:	2440
Polarity:	Vertical		

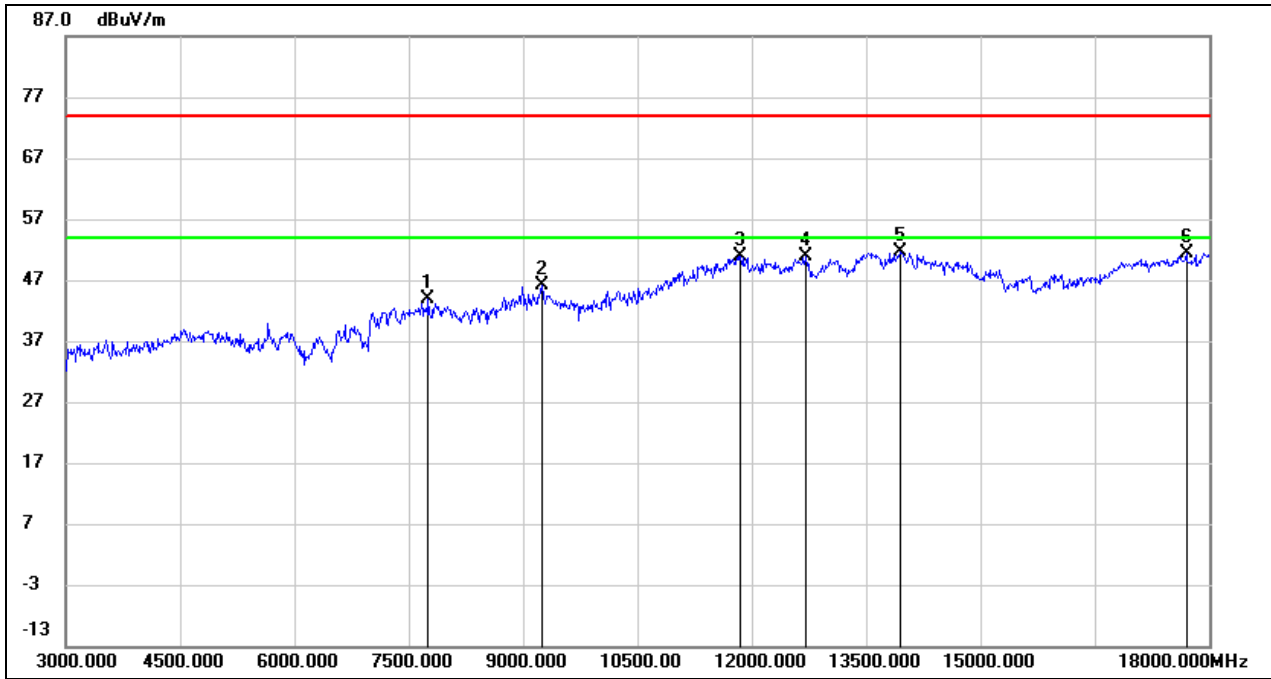

No.	Frequency (MHz)	Reading (dBuV)	Correct (dB/m)	Result (dBuV/m)	Limit (dBuV/m)	Margin (dB)	Remark
1	7755.000	37.58	6.31	43.89	74.00	-30.11	peak
2	9255.000	35.64	10.59	46.23	74.00	-27.77	peak
3	11850.000	33.37	17.56	50.93	74.00	-23.07	peak
4	12705.000	32.70	18.06	50.76	74.00	-23.24	peak
5	13950.000	29.87	21.86	51.73	74.00	-22.27	peak
6	17700.000	27.57	23.91	51.48	74.00	-22.52	peak



Test Mode:	BLE 2M	Channel:	2480
Polarity:	Horizontal		

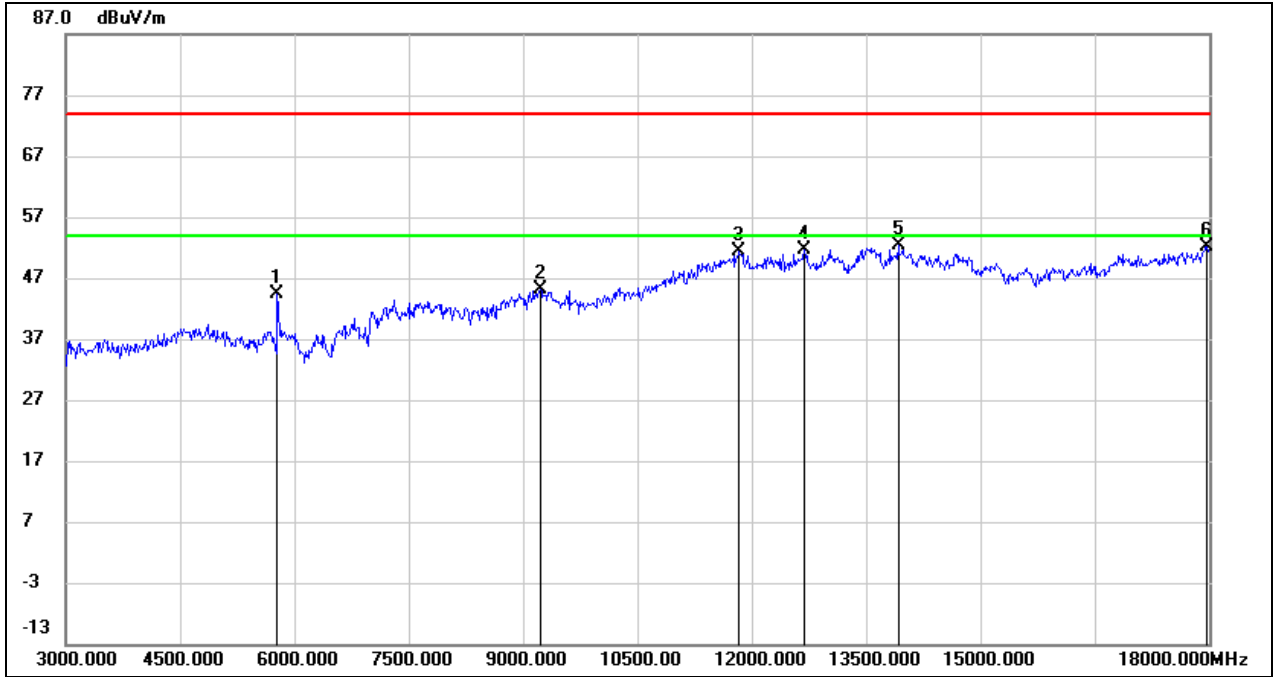

No.	Frequency (MHz)	Reading (dBuV)	Correct (dB/m)	Result (dBuV/m)	Limit (dBuV/m)	Margin (dB)	Remark
1	5775.000	42.79	1.63	44.42	74.00	-29.58	peak
2	9225.000	34.61	10.58	45.19	74.00	-28.81	peak
3	11835.000	33.89	17.51	51.40	74.00	-22.60	peak
4	12690.000	33.70	18.02	51.72	74.00	-22.28	peak
5	13920.000	30.61	21.79	52.40	74.00	-21.60	peak
6	17970.000	26.70	25.51	52.21	74.00	-21.79	peak



Test Mode:	BLE 2M	Channel:	2480
Polarity:	Vertical		

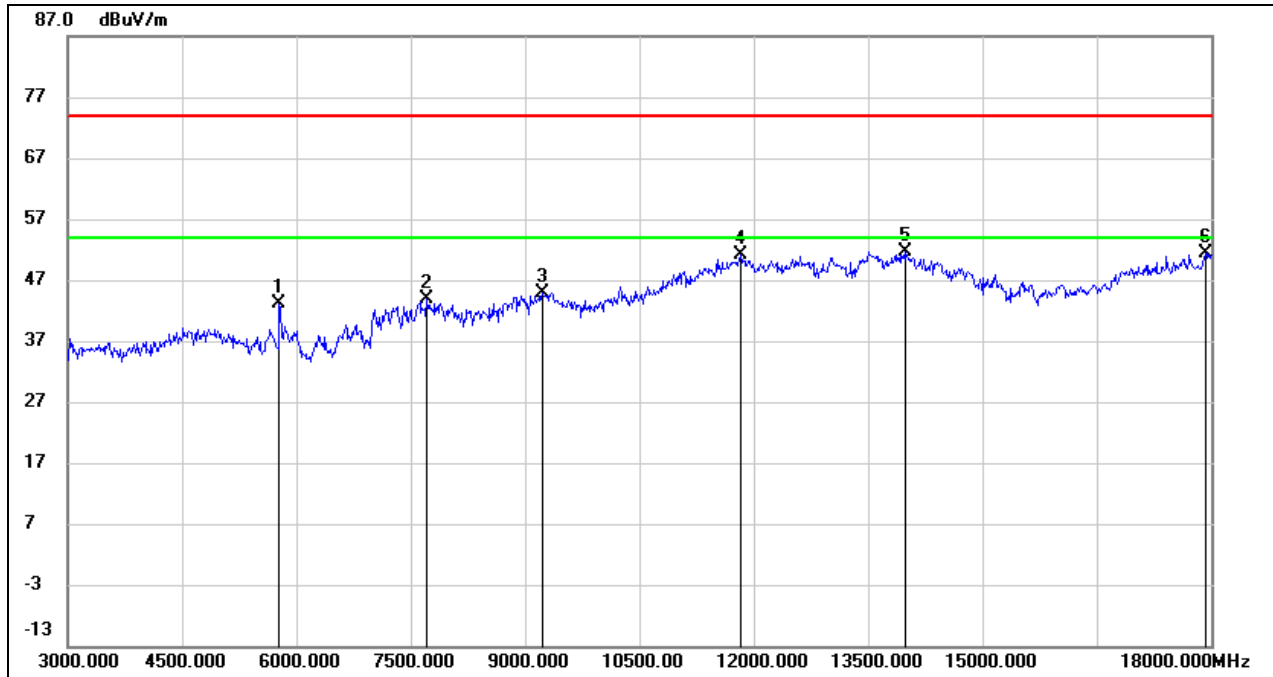

No.	Frequency (MHz)	Reading (dBuV)	Correct (dB/m)	Result (dBuV/m)	Limit (dBuV/m)	Margin (dB)	Remark
1	5775.000	41.60	1.63	43.23	74.00	-30.77	peak
2	7710.000	37.51	6.33	43.84	74.00	-30.16	peak
3	9225.000	34.28	10.58	44.86	74.00	-29.14	peak
4	11835.000	33.54	17.51	51.05	74.00	-22.95	peak
5	13980.000	29.77	21.92	51.69	74.00	-22.31	peak
6	17925.000	26.17	25.25	51.42	74.00	-22.58	peak



### 8.6. SPURIOUS EMISSIONS WITH CHARGING WORST CASE(3 GHZ~18 GHZ)

Test Mode:	BLE 2M	Channel:	2480
Polarity:	Horizontal	Charger:	PMPN4284A

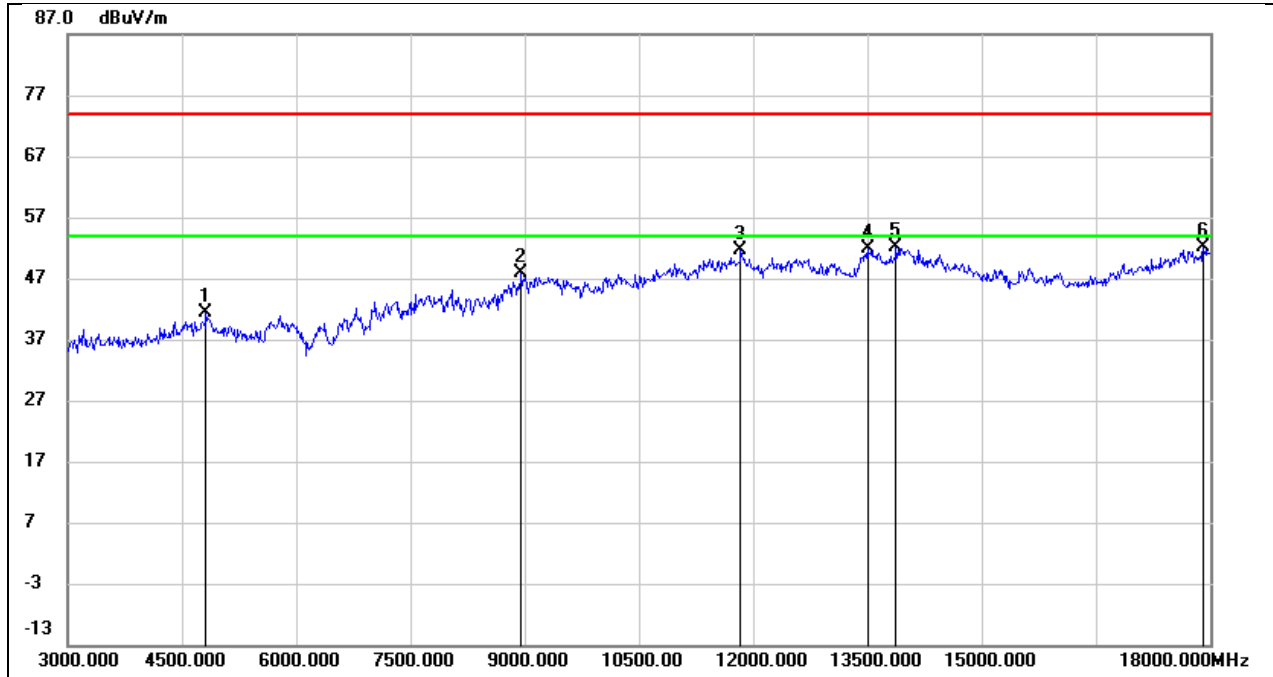

No.	Frequency (MHz)	Reading (dBuV)	Correct (dB/m)	Result (dBuV/m)	Limit (dBuV/m)	Margin (dB)	Remark
1	4815.000	41.53	-0.26	41.27	74.00	-32.73	peak
2	8955.000	37.73	10.16	47.89	74.00	-26.11	peak
3	11835.000	34.01	17.51	51.52	74.00	-22.48	peak
4	13500.000	30.86	20.90	51.76	74.00	-22.24	peak
5	13875.000	30.35	21.70	52.05	74.00	-21.95	peak
6	17910.000	26.95	25.16	52.11	74.00	-21.89	peak



Test Mode:	BLE 2M	Channel:	2480
Polarity:	Vertical	Charger:	PMPN4284A

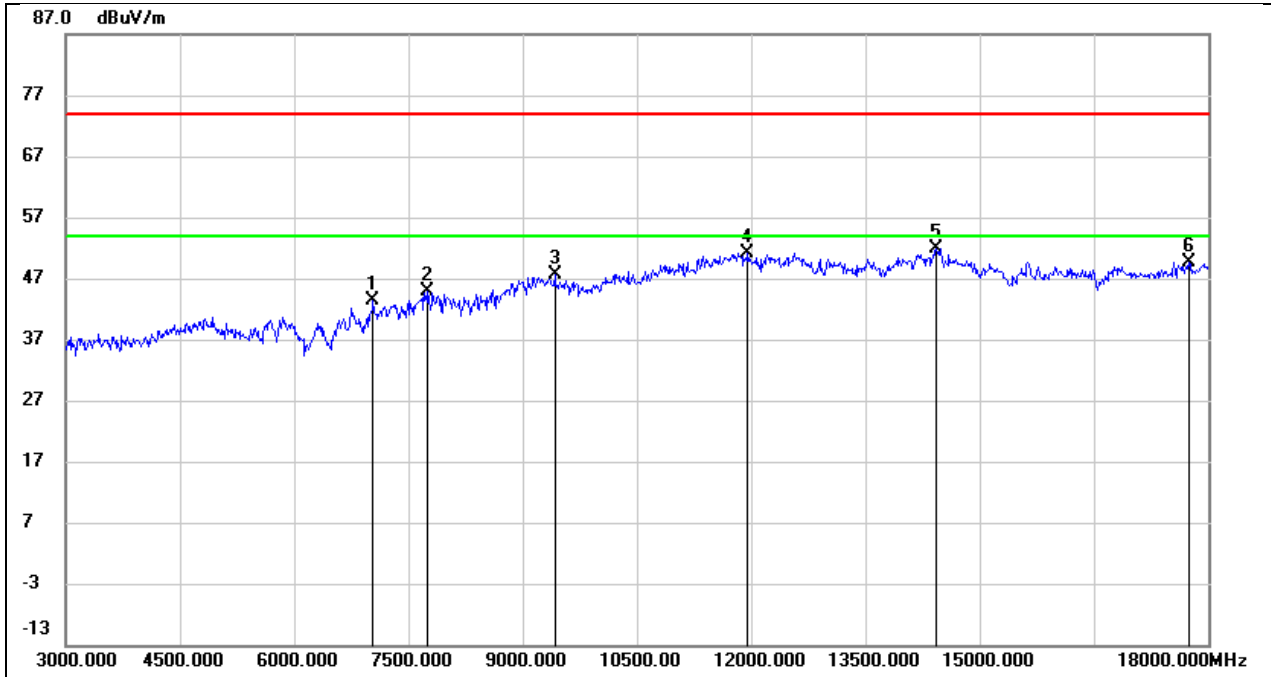

No.	Frequency (MHz)	Reading (dBuV)	Correct (dB/m)	Result (dBuV/m)	Limit (dBuV/m)	Margin (dB)	Remark
1	7035.000	36.73	6.67	43.40	74.00	-30.60	peak
2	7755.000	38.51	6.31	44.82	74.00	-29.18	peak
3	9420.000	37.05	10.65	47.70	74.00	-26.30	peak
4	11955.000	33.26	17.83	51.09	74.00	-22.91	peak
5	14430.000	31.74	20.20	51.94	74.00	-22.06	peak
6	17745.000	25.48	24.18	49.66	74.00	-24.34	peak



### 8.7. SPURIOUS EMISSIONS(9 kHz~30 MHz)

Test Mode:	BLE 2M	Channel:	2480
Polarity:	FACE ON TO THE EUT		

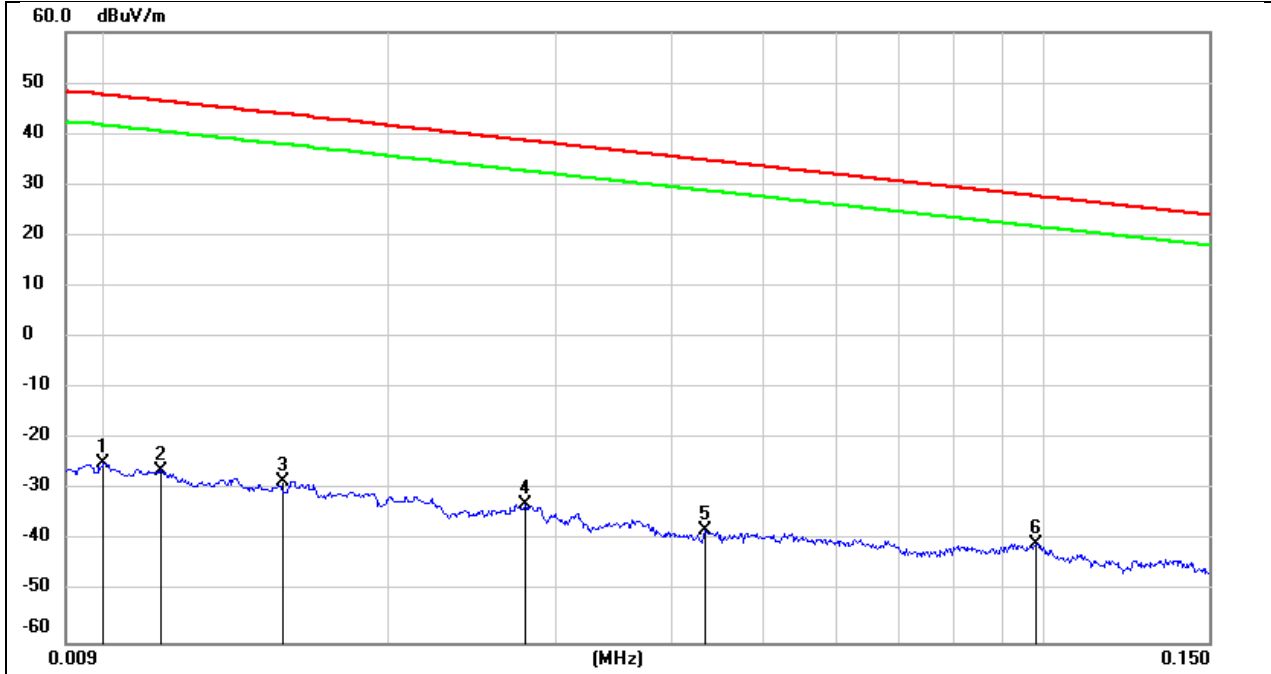

No.	Frequency (MHz)	Reading (dBuV)	Correct (dB/m)	FCC Result (dBuV/m)	FCC Limit (dBuV/m)	ISED Result (dBuA/m)	ISED Limit (dBuA/m)	Margin (dB)	Remark
1	0.0100	76.72	-101.40	-24.68	47.60	-76.18	-3.90	-72.28	peak
2	0.0114	75.00	-101.40	-26.40	46.46	-77.90	-5.04	-72.86	peak
3	0.0154	72.94	-101.37	-28.43	43.85	-79.93	-7.65	-72.28	peak
4	0.0279	68.67	-101.38	-32.71	38.69	-84.21	-12.81	-71.40	peak
5	0.0434	63.54	-101.45	-37.91	34.85	-89.41	-16.65	-72.76	peak
6	0.0981	61.27	-101.78	-40.51	27.77	-92.01	-23.73	-68.28	peak



Test Mode:	BLE 2M	Channel:	2480
Polarity:	FACE ON TO THE EUT		

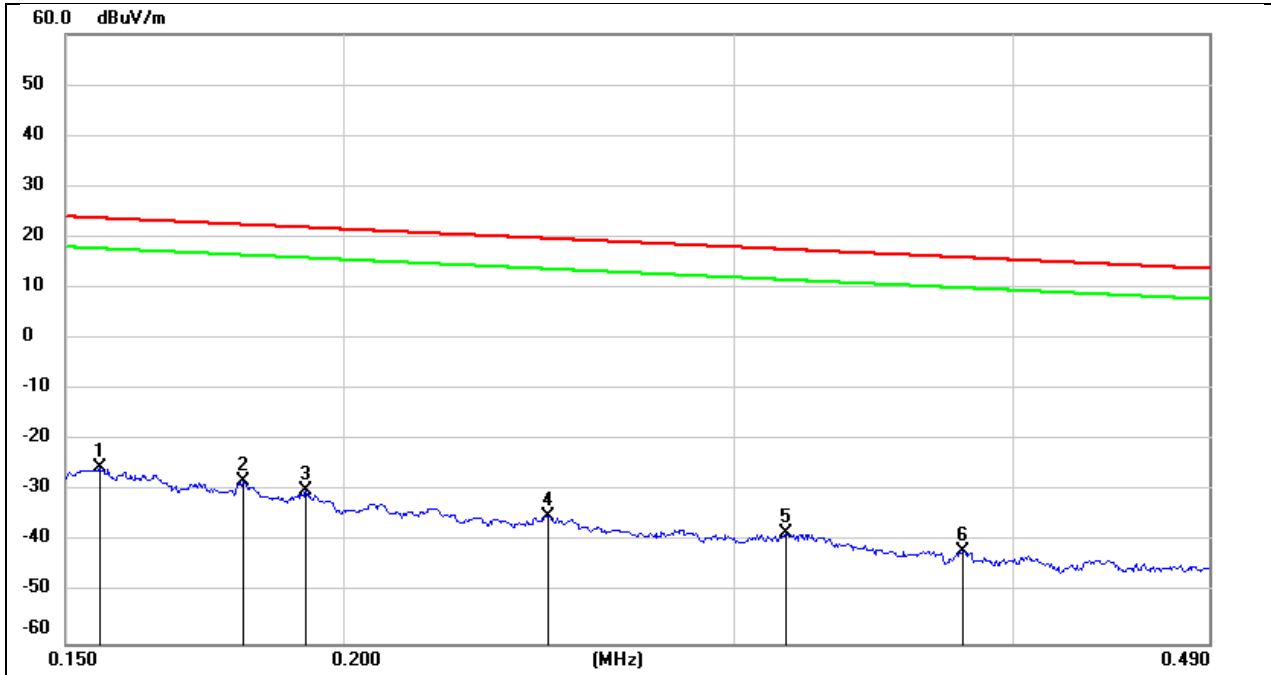

No.	Frequency (MHz)	Reading (dBuV)	Correct (dB/m)	FCC Result (dBuV/m)	FCC Limit (dBuV/m)	ISED Result (dBuA/m)	ISED Limit (dBuA/m)	Margin (dB)	Remark
1	0.1554	76.27	-101.65	-25.38	23.77	-76.88	-27.73	-49.15	peak
2	0.1801	73.53	-101.68	-28.15	22.50	-79.65	-29.00	-50.65	peak
3	0.1925	71.96	-101.70	-29.74	21.92	-81.24	-29.58	-51.66	peak
4	0.2472	66.95	-101.80	-34.85	19.74	-86.35	-31.76	-54.59	peak
5	0.3163	63.70	-101.87	-38.17	17.60	-89.67	-33.90	-55.77	peak
6	0.3800	60.02	-101.94	-41.92	16.01	-93.42	-35.49	-57.93	peak



Test Mode:	BLE 2M	Channel:	2480
Polarity:	FACE ON TO THE EUT		

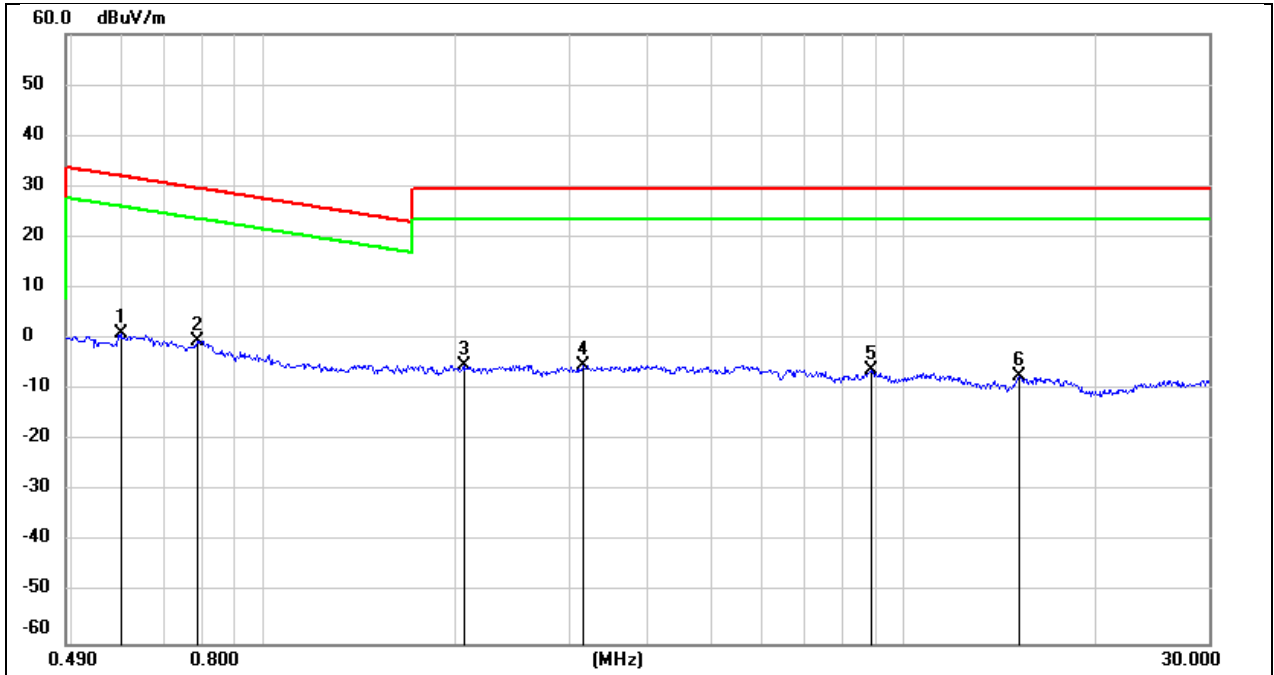

No.	Frequency (MHz)	Reading (dBuV)	Correct (dB/m)	FCC Result (dBuV/m)	FCC Limit (dBuV/m)	ISED Result (dBuA/m)	ISED Limit (dBuA/m)	Margin (dB)	Remark
1	0.5967	63.00	-62.08	0.92	32.09	-50.58	-19.41	-31.17	peak
2	0.7861	61.83	-62.14	-0.31	29.69	-51.81	-21.81	-30.00	peak
3	2.0539	56.70	-61.81	-5.11	29.54	-56.61	-21.96	-34.65	peak
4	3.1598	56.23	-61.53	-5.30	29.54	-56.80	-21.96	-34.84	peak
5	8.9001	54.91	-60.95	-6.04	29.54	-57.54	-21.96	-35.58	peak
6	15.1859	53.55	-61.01	-7.46	29.54	-58.96	-21.96	-37.00	peak





### 8.8. SPURIOUS EMISSIONS(18 GHz~26 GHz)

Test Mode:	BLE 2M	Channel:	2480
Polarity:	Horizontal		

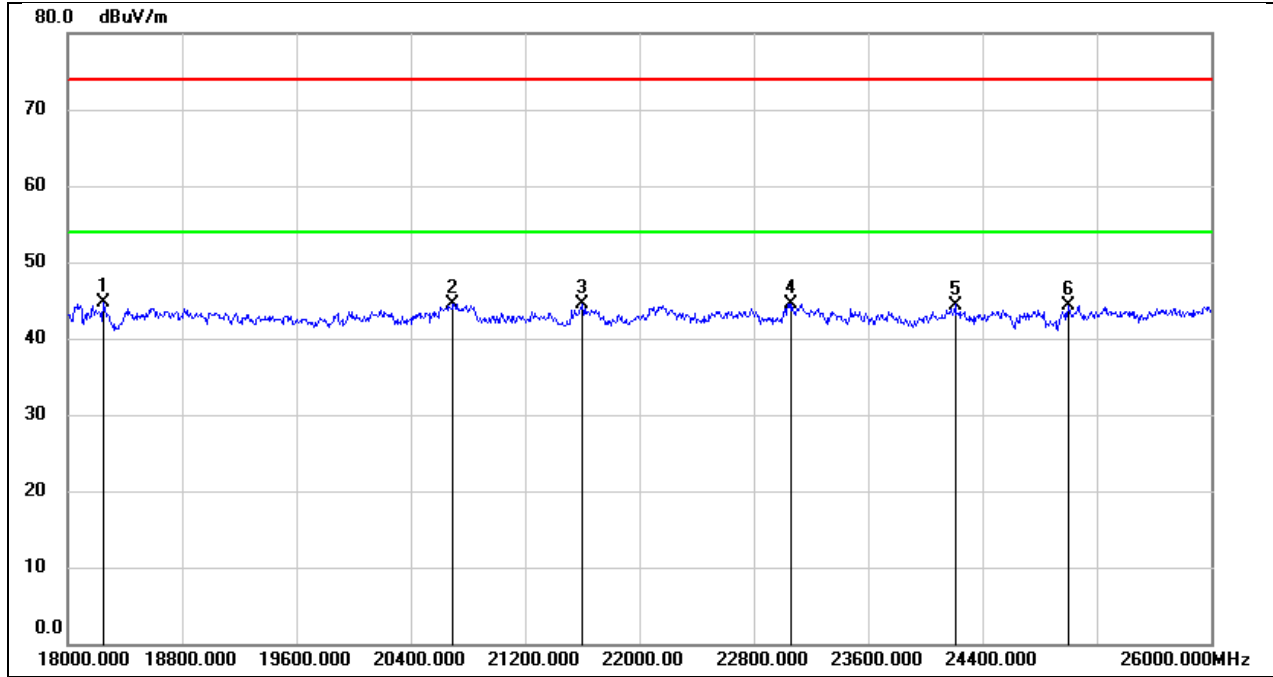

No.	Frequency (MHz)	Reading (dBuV)	Correct (dB/m)	Result (dBuV/m)	Limit (dBuV/m)	Margin (dB)	Remark
1	18248.000	50.18	-5.56	44.62	74.00	-29.38	peak
2	20696.000	49.71	-5.16	44.55	74.00	-29.45	peak
3	21600.000	49.02	-4.54	44.48	74.00	-29.52	peak
4	23064.000	47.99	-3.42	44.57	74.00	-29.43	peak
5	24208.000	47.21	-2.81	44.40	74.00	-29.60	peak
6	25000.000	46.36	-2.10	44.26	74.00	-29.74	peak



Test Mode:	BLE 2M	Channel:	2480
Polarity:	Vertical		

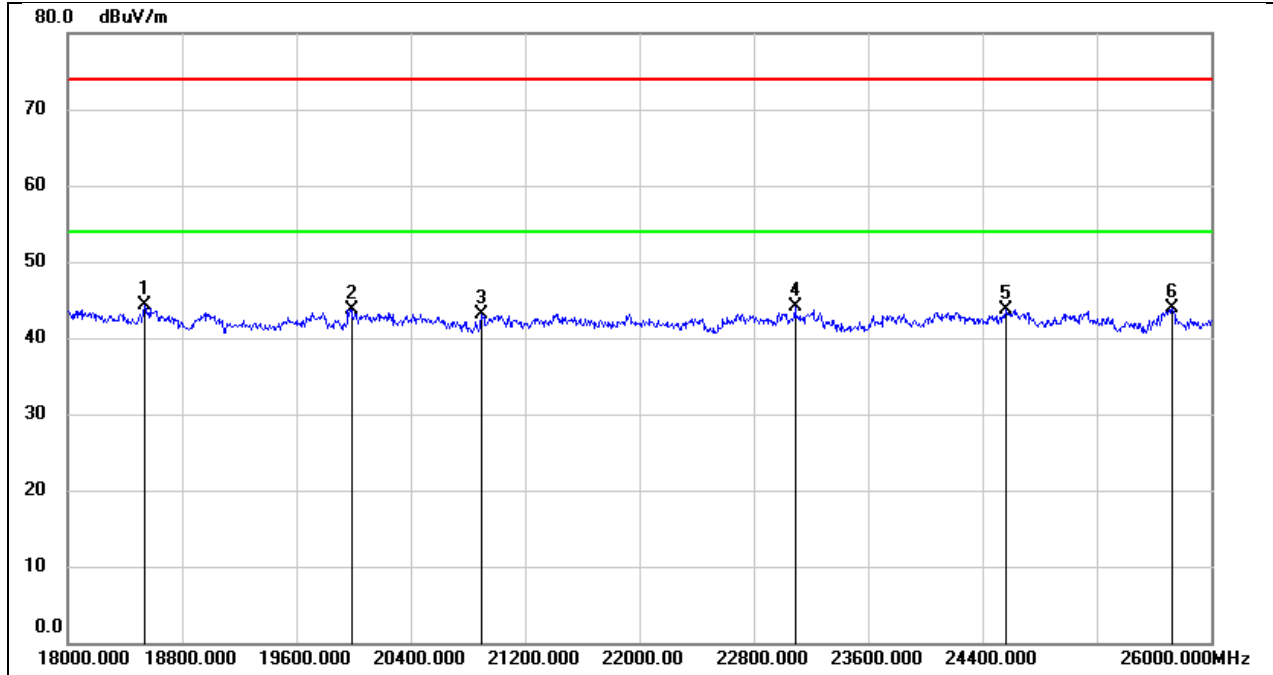

No.	Frequency (MHz)	Reading (dBuV)	Correct (dB/m)	Result (dBuV/m)	Limit (dBuV/m)	Margin (dB)	Remark
1	18536.000	49.60	-5.27	44.33	74.00	-29.67	peak
2	19984.000	49.21	-5.44	43.77	74.00	-30.23	peak
3	20896.000	48.02	-4.98	43.04	74.00	-30.96	peak
4	23088.000	47.52	-3.41	44.11	74.00	-29.89	peak
5	24568.000	46.10	-2.33	43.77	74.00	-30.23	peak
6	25728.000	44.61	-0.72	43.89	74.00	-30.11	peak



### 8.9. SPURIOUS EMISSIONS(30 MHz~1 GHz)

Test Mode:	BLE 2M	Channel:	2480
Polarity:	Horizontal		

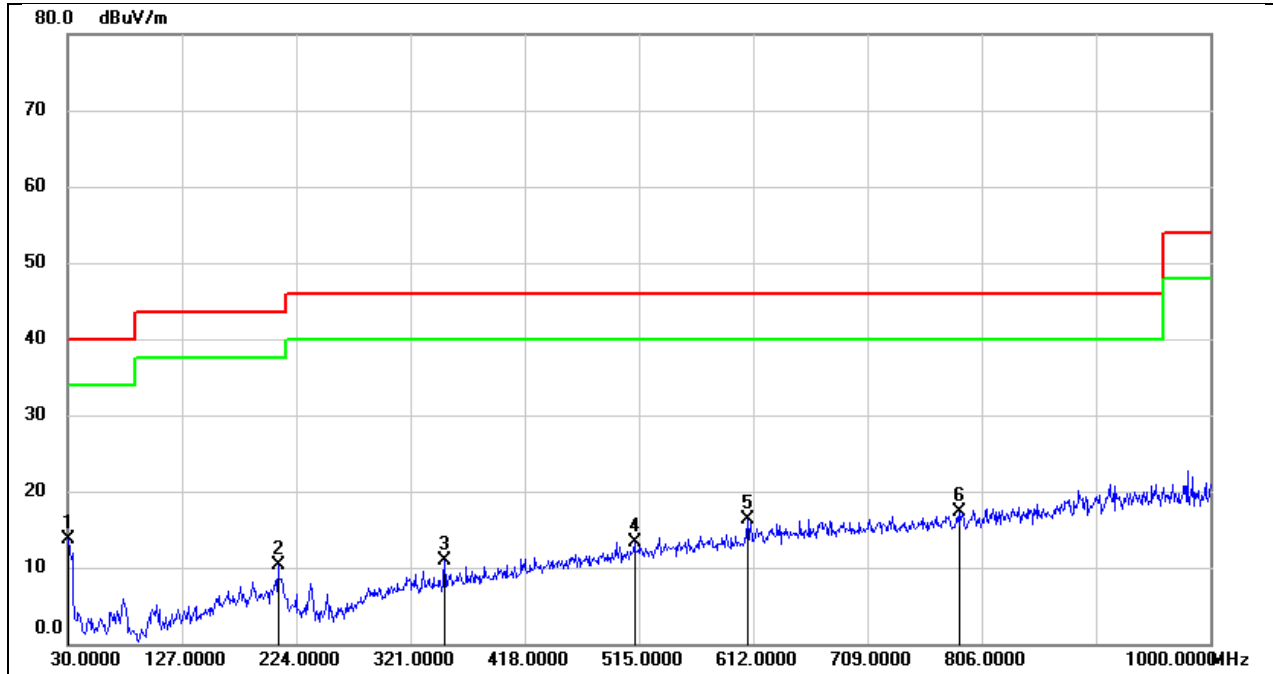

No.	Frequency (MHz)	Reading (dBuV)	Correct (dB/m)	Result (dBuV/m)	Limit (dBuV/m)	Margin (dB)	Remark
1	30.9700	32.71	-19.04	13.67	40.00	-26.33	QP
2	208.4800	27.46	-17.14	10.32	43.50	-33.18	QP
3	350.1000	25.27	-14.32	10.95	46.00	-35.05	QP
4	511.1200	24.56	-11.22	13.34	46.00	-32.66	QP
5	607.1500	25.77	-9.45	16.32	46.00	-29.68	QP
6	787.5700	24.66	-7.44	17.22	46.00	-28.78	QP



Test Mode:	BLE 2M	Channel:	2480
Polarity:	Vertical		

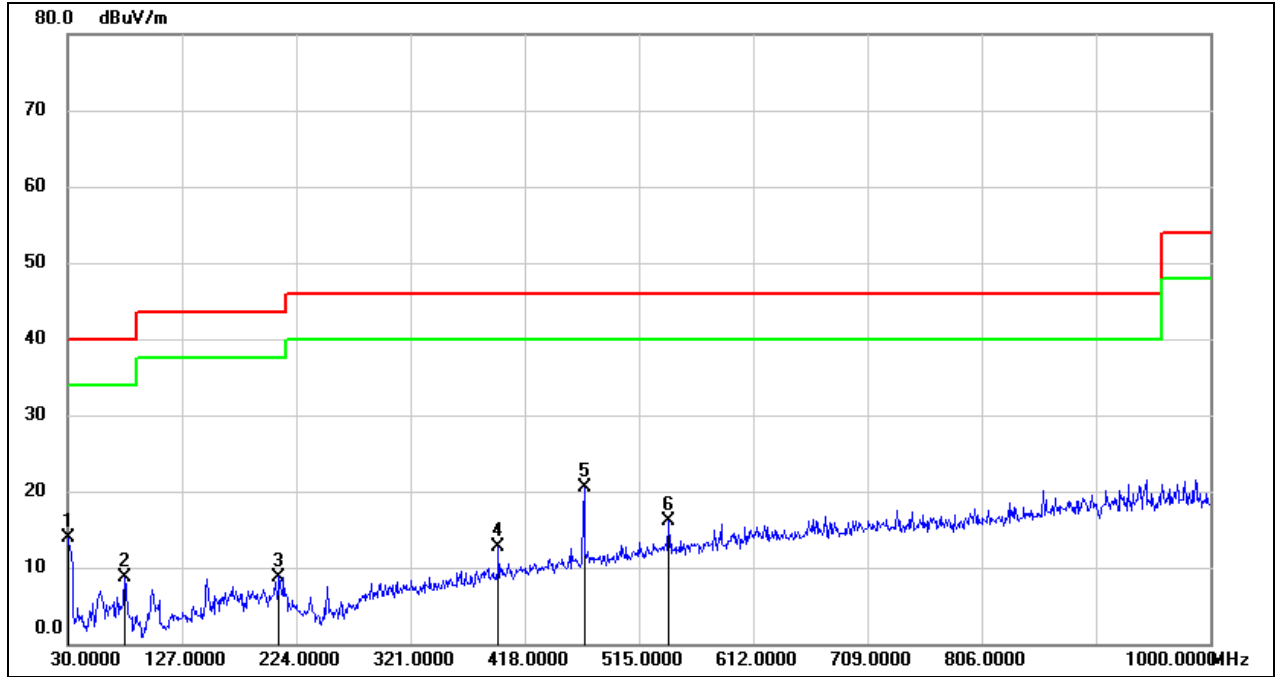

No.	Frequency (MHz)	Reading (dBuV)	Correct (dB/m)	Result (dBuV/m)	Limit (dBuV/m)	Margin (dB)	Remark
1	30.9700	32.96	-19.04	13.92	40.00	-26.08	QP
2	78.5000	30.02	-21.23	8.79	40.00	-31.21	QP
3	209.4500	26.03	-17.23	8.80	43.50	-34.70	QP
4	395.6900	26.14	-13.41	12.73	46.00	-33.27	QP
5	468.4400	32.46	-12.04	20.42	46.00	-25.58	QP
6	540.2199	26.65	-10.49	16.16	46.00	-29.84	QP



### 8.10. SPURIOUS EMISSIONS WITH CHARGING WORST CASE(30 MHZ~1 GHZ)

Test Mode:	BLE 2M	Channel:	2480
Polarity:	Horizontal	Charger:	PMPN4284A

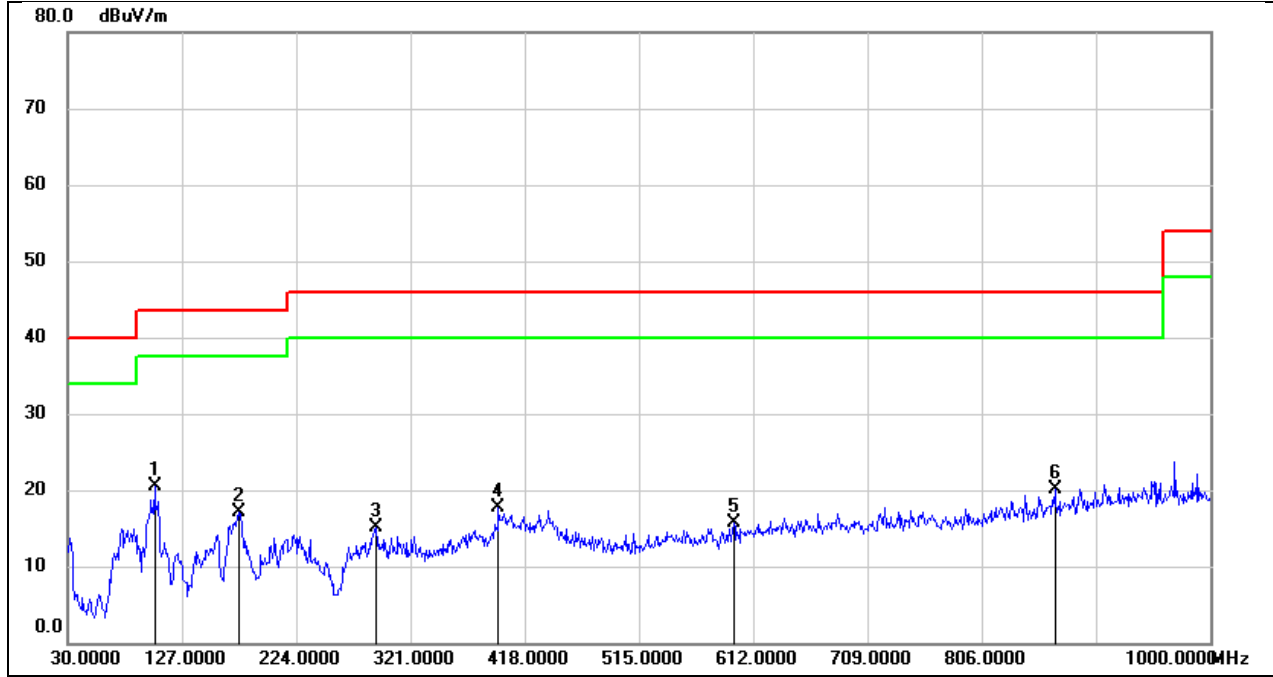

No.	Frequency (MHz)	Reading (dBuV)	Correct (dB/m)	Result (dBuV/m)	Limit (dBuV/m)	Margin (dB)	Remark
1	103.7200	41.38	-20.84	20.54	43.50	-22.96	QP
2	175.5000	34.08	-17.07	17.01	43.50	-26.49	QP
3	291.9000	30.84	-15.80	15.04	46.00	-30.96	QP
4	395.6900	31.15	-13.41	17.74	46.00	-28.26	QP
5	595.5100	25.35	-9.67	15.68	46.00	-30.32	QP
6	868.0800	25.88	-5.80	20.08	46.00	-25.92	QP



Test Mode:	BLE 2M	Channel:	2480
Polarity:	Vertical	Charger:	PMPN4284A

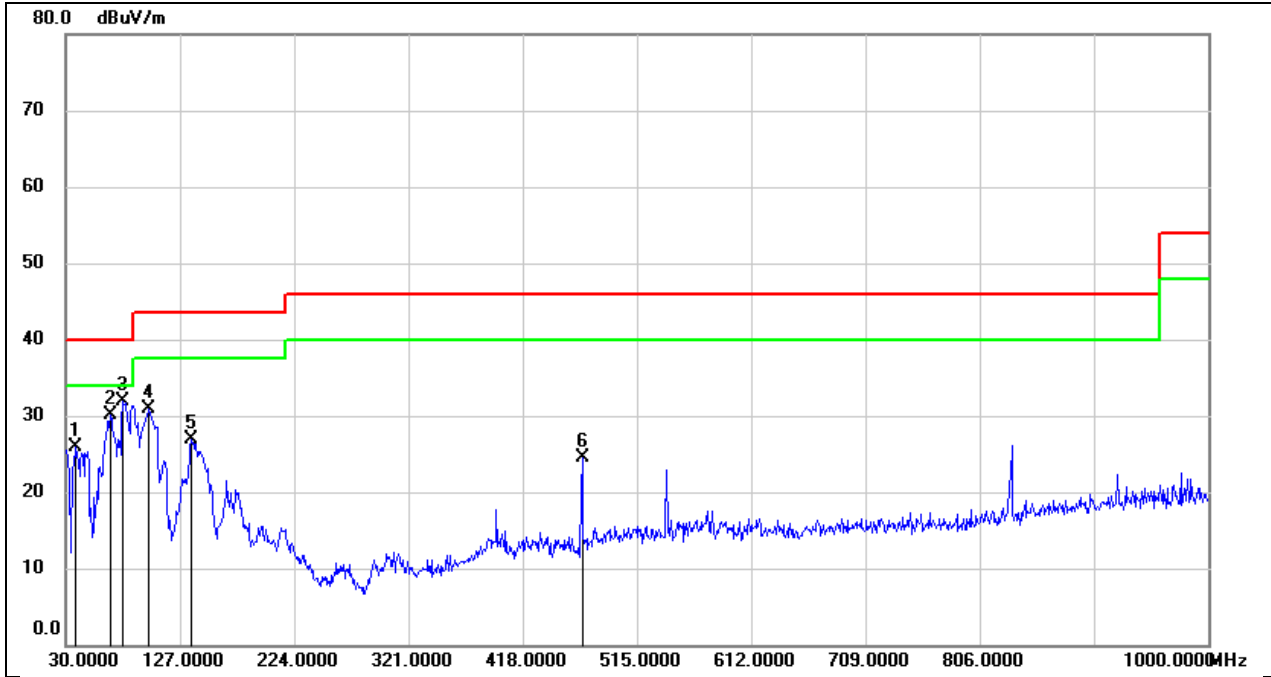

No.	Frequency (MHz)	Reading (dBuV)	Correct (dB/m)	Result (dBuV/m)	Limit (dBuV/m)	Margin (dB)	Remark
1	38.7300	45.67	-19.81	25.86	40.00	-14.14	QP
2	67.8300	50.68	-20.55	30.13	40.00	-9.87	QP
3	78.5000	53.23	-21.23	32.00	40.00	-8.00	QP
4	100.8100	52.02	-21.08	30.94	43.50	-12.56	QP
5	136.7000	45.83	-19.02	26.81	43.50	-16.69	QP
6	468.4400	36.58	-12.04	24.54	46.00	-21.46	QP



## 9. ANTENNA REQUIREMENT

### REQUIREMENT

Please refer to FCC §15.203

An intentional radiator shall be designed to ensure that no antenna other than that furnished by the responsible party shall be used with the device. The use of a permanently attached antenna or of an antenna that uses a unique coupling to the intentional radiator shall be considered sufficient to comply with the provisions of this section. The manufacturer may design the unit so that a broken antenna can be replaced by the user, but the use of a standard antenna jack or electrical connector is prohibited.

Please refer to FCC §15.247(b)(4)

The conducted output power limit specified in paragraph (b) of this section is based on the use of antennas with directional gains that do not exceed 6 dBi. Except as shown in paragraph (c) of this section, if transmitting antennas of directional gain greater than 6 dBi are used, the conducted output power from the intentional radiator shall be reduced below the stated values in paragraphs (b)(1), (b)(2), and (b)(3) of this section, as appropriate, by the amount in dB that the directional gain of the antenna exceeds 6 dBi.

### DESCRIPTION

Complies

## 10. AC POWER LINE CONDUCTED EMISSION

### LIMITS

Please refer to CFR 47 FCC §15.207 (a) and ISED RSS-Gen Clause 8.8

FREQUENCY (MHz)	Quasi-peak	Average
0.15 -0.5	66 - 56 *	56 - 46 *
0.50 -5.0	56.00	46.00
5.0 -30.0	60.00	50.00

### TEST PROCEDURE

The EUT is put on a table of non-conducting material that is 80 cm high. The vertical conducting wall of shielding is located 40 cm to the rear of the EUT. The power line of the EUT is connected to the AC mains through a Artificial Mains Network (A.M.N.). A EMI Measurement Receiver (R&S Test Receiver ESR3) is used to test the emissions from both sides of AC line. According to the requirements in Section 6.2 of ANSI C63.10-2013. Conducted emissions from the EUT measured in the frequency range between 0.15 MHz and 30 MHz using CISPR Quasi-Peak and average detector mode. The bandwidth of EMI test receiver is set at 9 kHz.

The arrangement of the equipment is installed to meet the standards and operating in a manner, which tends to maximize its emission characteristics in a normal application.

### TEST SETUP

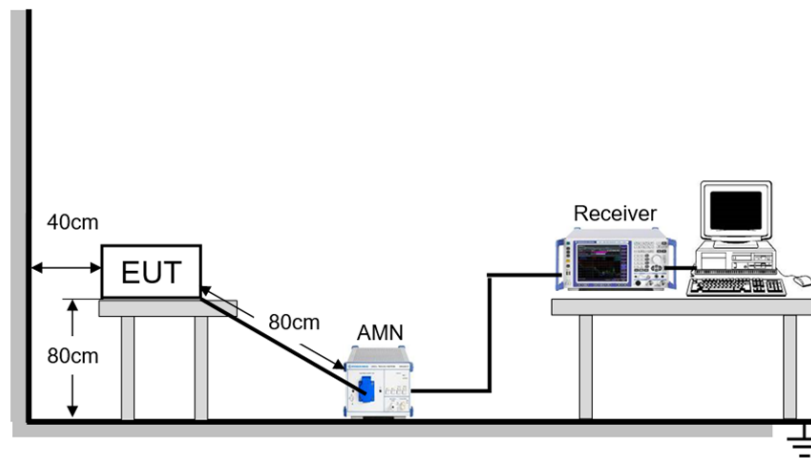

### TEST ENVIRONMENT

Temperature	23.8°C	Relative Humidity	56%
Atmosphere Pressure	101kPa	Test Voltage	AC 120 V, 60 Hz





**TEST RESULTS**

Test Mode:	BLE 2M	Channel:	2480
Line:	Line		

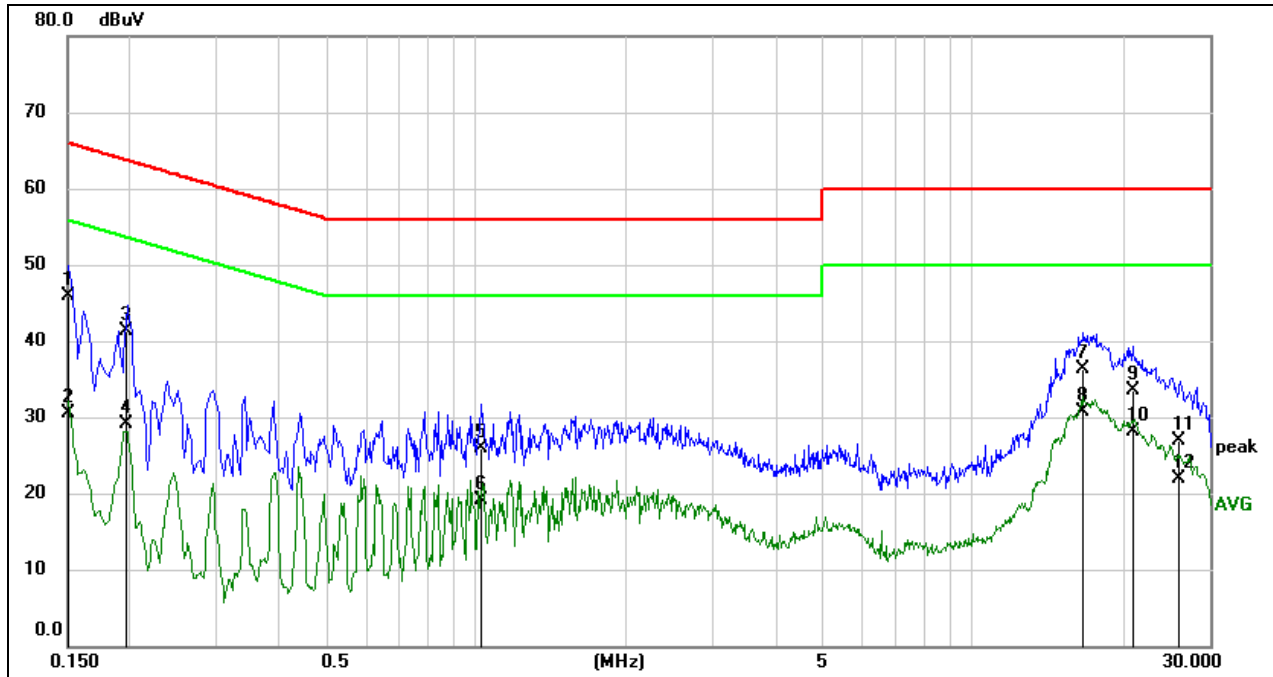

No.	Frequency (MHz)	Reading (dBuV)	Correct (dB)	Result (dBuV)	Limit (dBuV)	Margin (dB)	Remark
1	0.1500	36.51	9.49	46.00	66.00	-20.00	QP
2	0.1500	21.03	9.49	30.52	56.00	-25.48	AVG
3	0.1961	31.72	9.58	41.30	63.77	-22.47	QP
4	0.1961	19.58	9.58	29.16	53.77	-24.61	AVG
5	1.0298	16.45	9.51	25.96	56.00	-30.04	QP
6	1.0298	9.60	9.51	19.11	46.00	-26.89	AVG
7	16.6602	26.67	9.67	36.34	60.00	-23.66	QP
8	16.6602	21.07	9.67	30.74	50.00	-19.26	AVG
9	20.9900	23.76	9.75	33.51	60.00	-26.49	QP
10	20.9900	18.33	9.75	28.08	50.00	-21.92	AVG
11	26.1253	17.22	9.75	26.97	60.00	-33.03	QP
12	26.1253	12.25	9.75	22.00	50.00	-28.00	AVG

Note:

1. Result = Reading + Correct Factor.
2. If QP Result complies with AV limit, AV Result is deemed to comply with AV limit.
3. Test setup: RBW: 200 Hz (9 kHz ~ 150 kHz), 9 kHz (150 kHz ~ 30 MHz).
4. Step size: 80 Hz (0.009 MHz ~ 0.15 MHz), 4 kHz (0.15 MHz ~ 30 MHz), Scan time: auto.

Note: All the modes have been tested, only the worst data was recorded in the report.



Test Mode:	BLE 2M	Channel:	2480
Line:	Neutral		

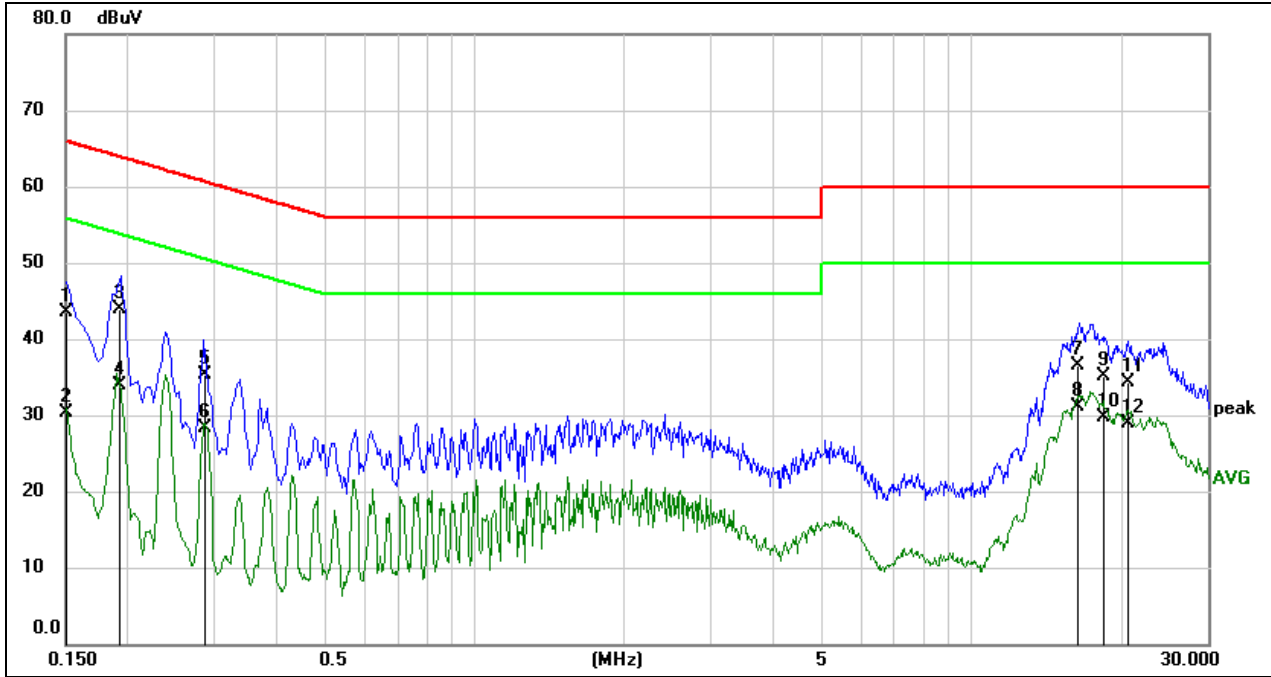

No.	Frequency (MHz)	Reading (dBuV)	Correct (dB)	Result (dBuV)	Limit (dBuV)	Margin (dB)	Remark
1	0.1500	34.11	9.49	43.60	66.00	-22.40	QP
2	0.1500	20.75	9.49	30.24	56.00	-25.76	AVG
3	0.1917	34.32	9.57	43.89	63.96	-20.07	QP
4	0.1917	24.36	9.57	33.93	53.96	-20.03	AVG
5	0.2862	25.79	9.56	35.35	60.63	-25.28	QP
6	0.2862	18.72	9.56	28.28	50.63	-22.35	AVG
7	16.4572	26.86	9.66	36.52	60.00	-23.48	QP
8	16.4572	21.45	9.66	31.11	50.00	-18.89	AVG
9	18.5542	25.31	9.72	35.03	60.00	-24.97	QP
10	18.5542	20.01	9.72	29.73	50.00	-20.27	AVG
11	20.7314	24.53	9.75	34.28	60.00	-25.72	QP
12	20.7314	19.17	9.75	28.92	50.00	-21.08	AVG

Note:

1. Result = Reading + Correct Factor.
2. If QP Result complies with AV limit, AV Result is deemed to comply with AV limit.
3. Test setup: RBW: 200 Hz (9 kHz ~ 150 kHz), 9 kHz (150 kHz ~ 30 MHz).
4. Step size: 80 Hz (0.009 MHz ~ 0.15 MHz), 4 kHz (0.15 MHz ~ 30 MHz), Scan time: auto.

Note: All the modes have been tested, only the worst data was recorded in the report.



## 11. TEST DATA

### 11.1. APPENDIX A: DTS BANDWIDTH

#### 11.1.1. Test Result

Test Mode	Antenna	Channel	DTS BW [MHz]	FL[MHz]	FH[MHz]	Limit[MHz]	Verdict
BLE_1M	Ant1	2402	0.71	2401.63	2402.35	0.5	PASS
		2440	0.71	2439.63	2440.35	0.5	PASS
		2480	0.71	2479.63	2480.35	0.5	PASS
BLE_2M	Ant1	2402	1.16	2401.41	2402.57	0.5	PASS
		2440	1.16	2439.41	2440.57	0.5	PASS
		2480	1.16	2479.41	2480.57	0.5	PASS

### 11.1.2. Test Graphs

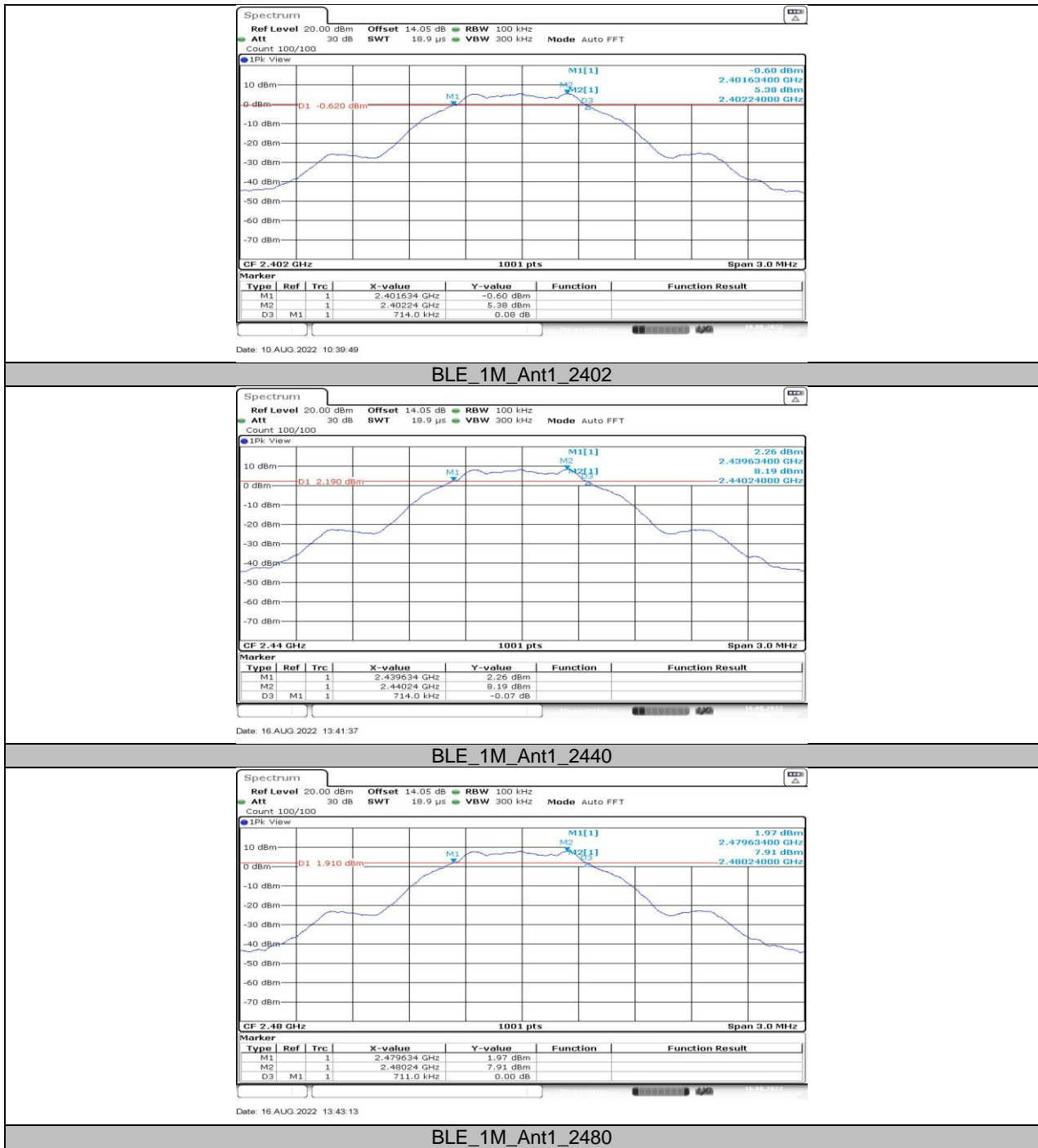

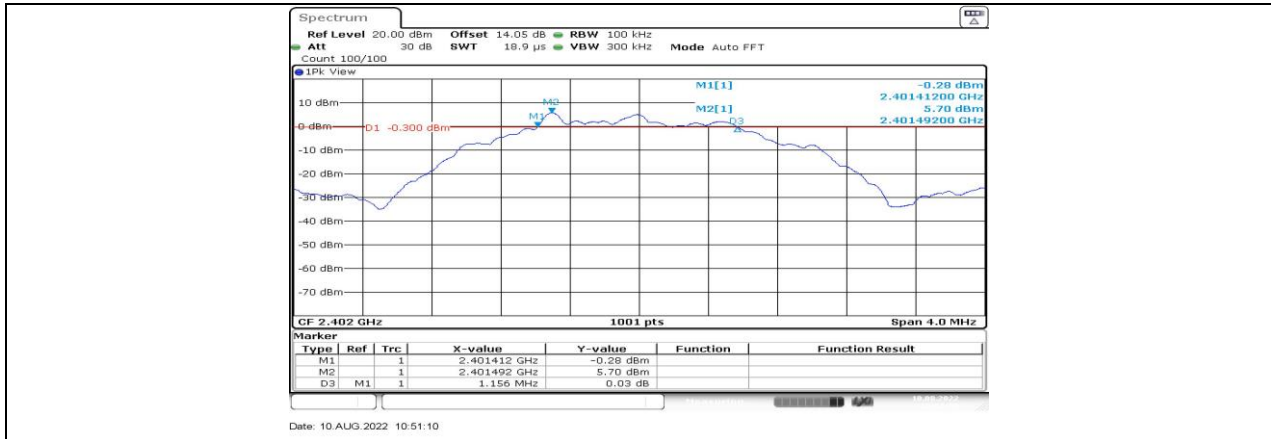

BLE\_2M\_Ant1\_2402

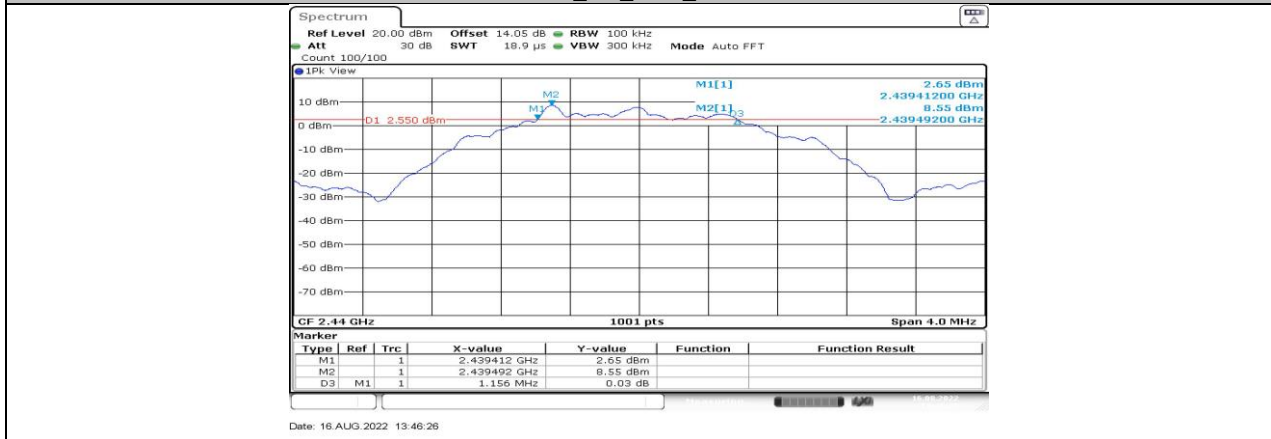

BLE\_2M\_Ant1\_2440

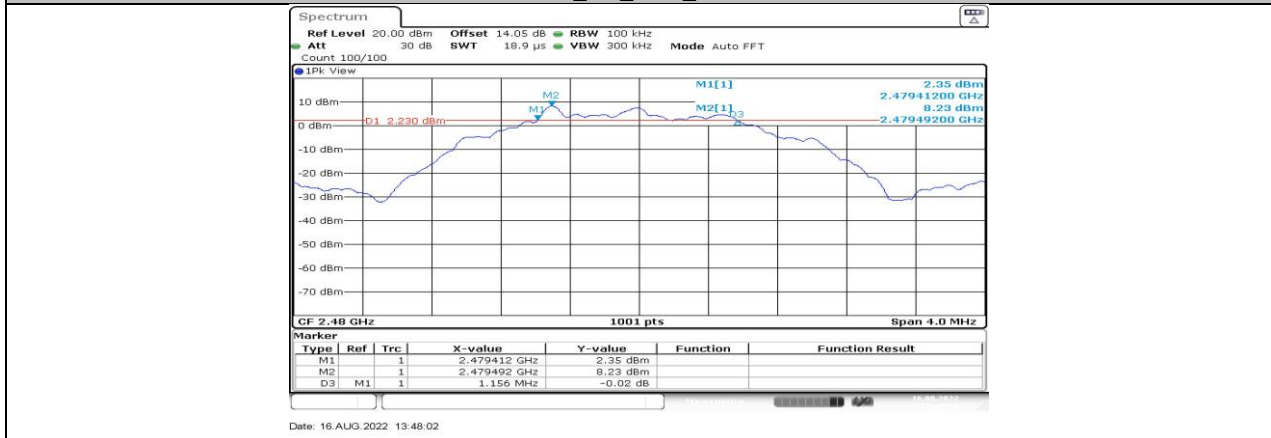

BLE\_2M\_Ant1\_2480



## 11.2. APPENDIX B: OCCUPIED CHANNEL BANDWIDTH

### 11.2.1. Test Result

Test Mode	Antenna	Channel	OCB [MHz]	FL[MHz]	FH[MHz]	Verdict
BLE_1M	Ant1	2402	1.027	2401.489	2402.515	PASS
		2440	1.027	2439.489	2440.515	PASS
		2480	1.027	2479.489	2480.515	PASS
BLE_2M	Ant1	2402	2.042	2400.993	2403.035	PASS
		2440	2.042	2438.993	2441.035	PASS
		2480	2.042	2478.993	2481.035	PASS

### 11.2.2. Test Graphs



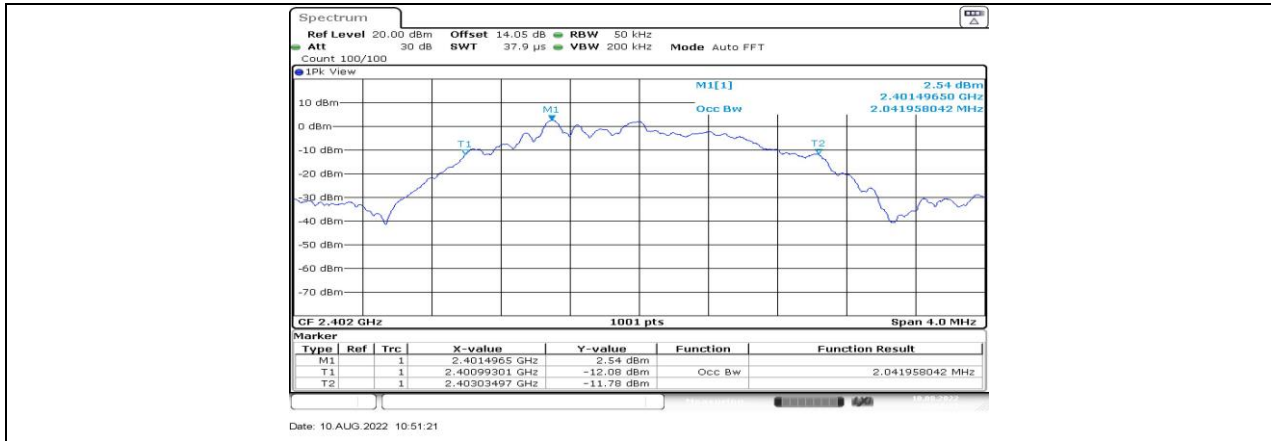

BLE\_2M\_Ant1\_2402

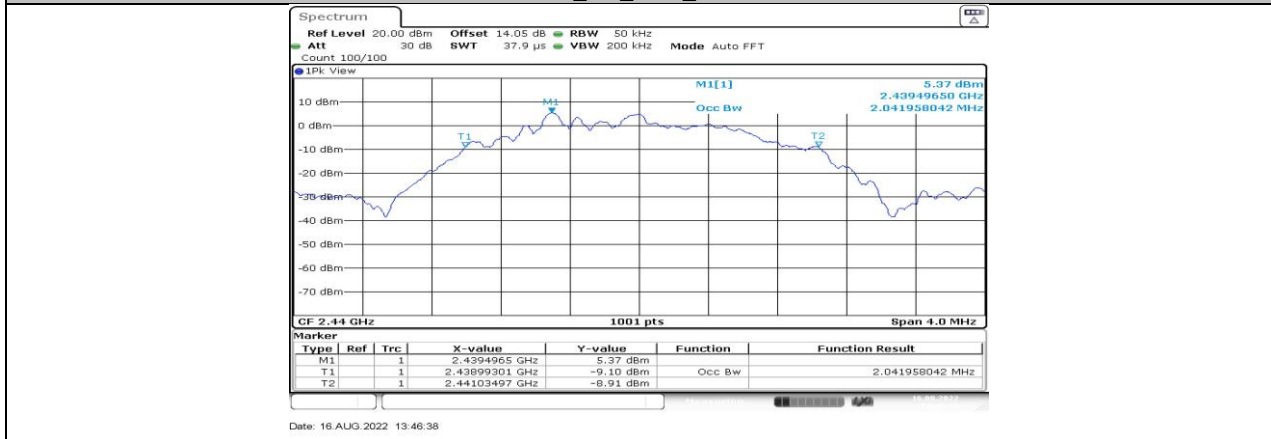

BLE\_2M\_Ant1\_2440

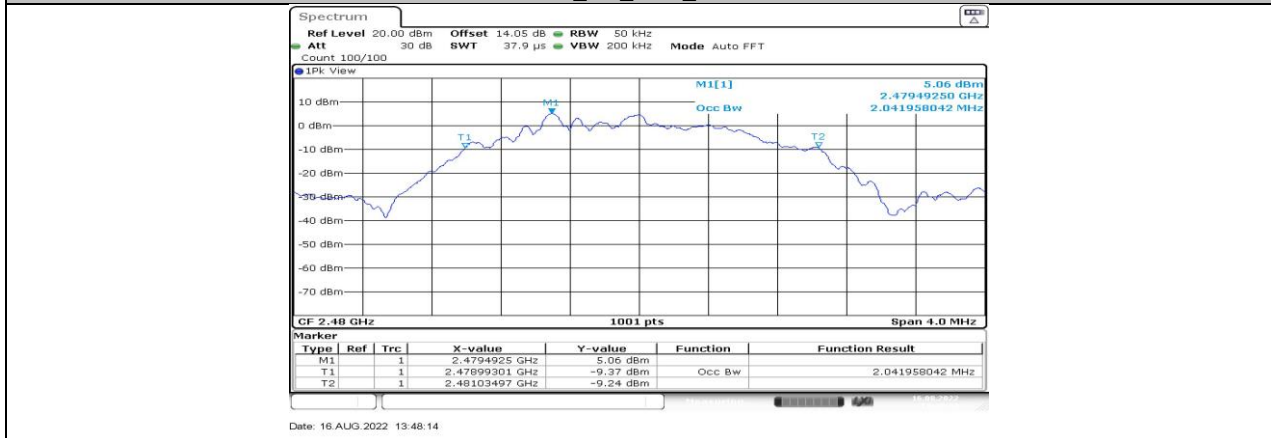

BLE\_2M\_Ant1\_2480





### 11.3. APPENDIX C: MAXIMUM CONDUCTED OUTPUT POWER

#### 11.3.1. Test Result

Test Mode	Antenna	Channel	Result[dBm]	Limit[dBm]	Verdict
BLE_1M	Ant1	2402	8.96	≤30	PASS
		2440	8.97	≤30	PASS
		2480	8.68	≤30	PASS
BLE_2M	Ant1	2402	8.99	≤30	PASS
		2440	9.00	≤30	PASS
		2480	8.69	≤30	PASS



## 11.4. APPENDIX D: MAXIMUM POWER SPECTRAL DENSITY

### 11.4.1. Test Result

Test Mode	Antenna	Channel	Result[dBm/3kHz]	Limit[dBm/3kHz]	Verdict
BLE_1M	Ant1	2402	-6.58	≤8.00	PASS
		2440	-6.43	≤8.00	PASS
		2480	-6.67	≤8.00	PASS
BLE_2M	Ant1	2402	-9.94	≤8.00	PASS
		2440	-9.82	≤8.00	PASS
		2480	-10.17	≤8.00	PASS

### 11.4.2. Test Graphs

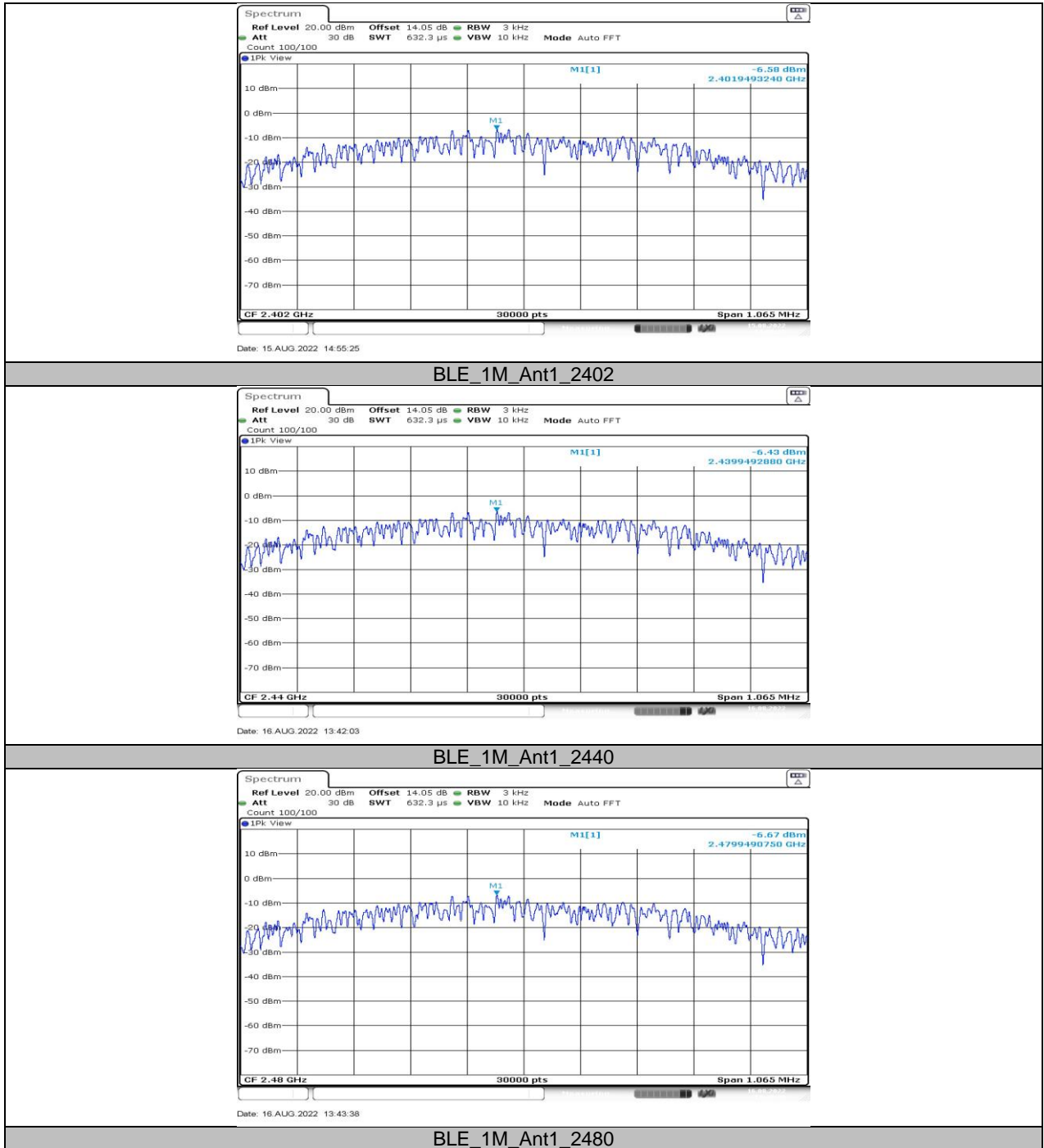

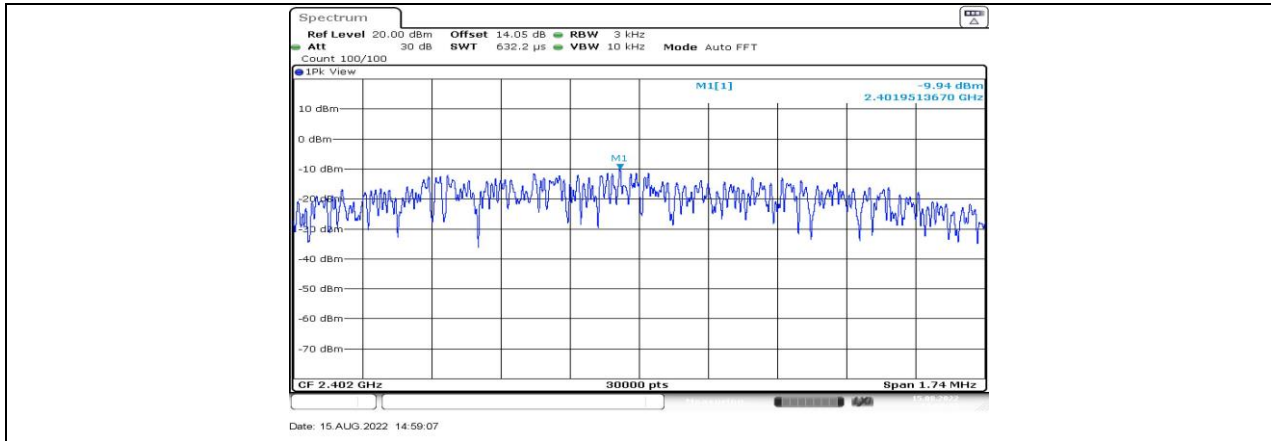

BLE\_2M\_Ant1\_2402

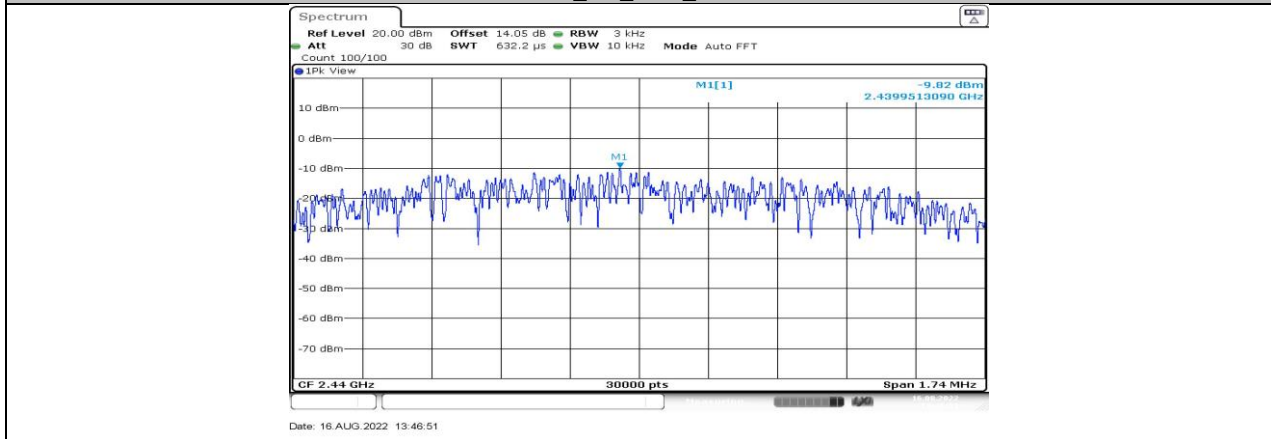

BLE\_2M\_Ant1\_2440

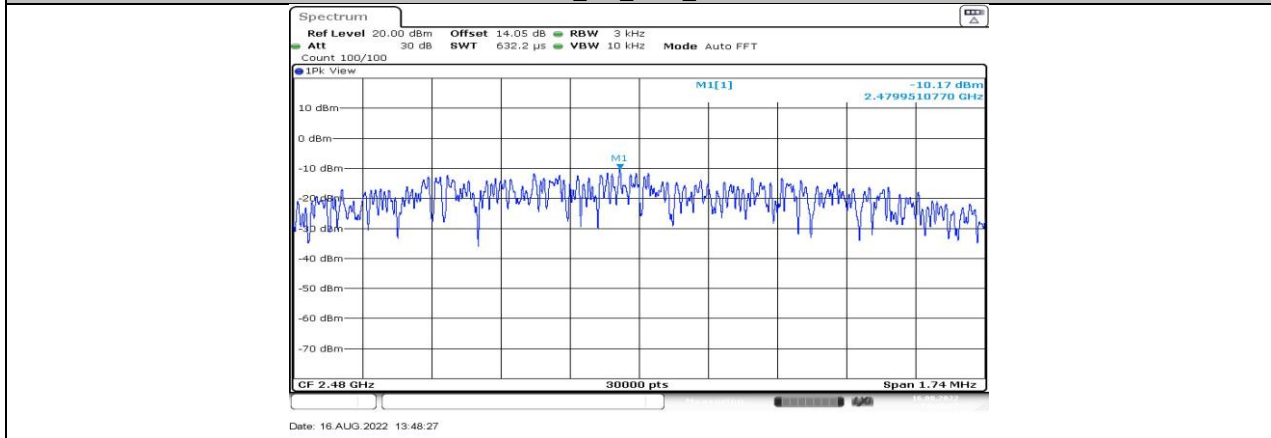

BLE\_2M\_Ant1\_2480



## 11.5. APPENDIX E: BAND EDGE MEASUREMENTS

### 11.5.1. Test Result

Test Mode	Antenna	ChName	Channel	RefLevel[dBm]	Result[dBm]	Limit[dBm]	Verdict
BLE_1M	Ant1	Low	2402	5.38	-45.33	≤-14.62	PASS
		High	2480	7.96	-43.97	≤-12.04	PASS
BLE_2M	Ant1	Low	2402	5.61	-26.82	≤-14.39	PASS
		High	2480	8.27	-38.07	≤-11.73	PASS

### 11.5.2. Test Graphs

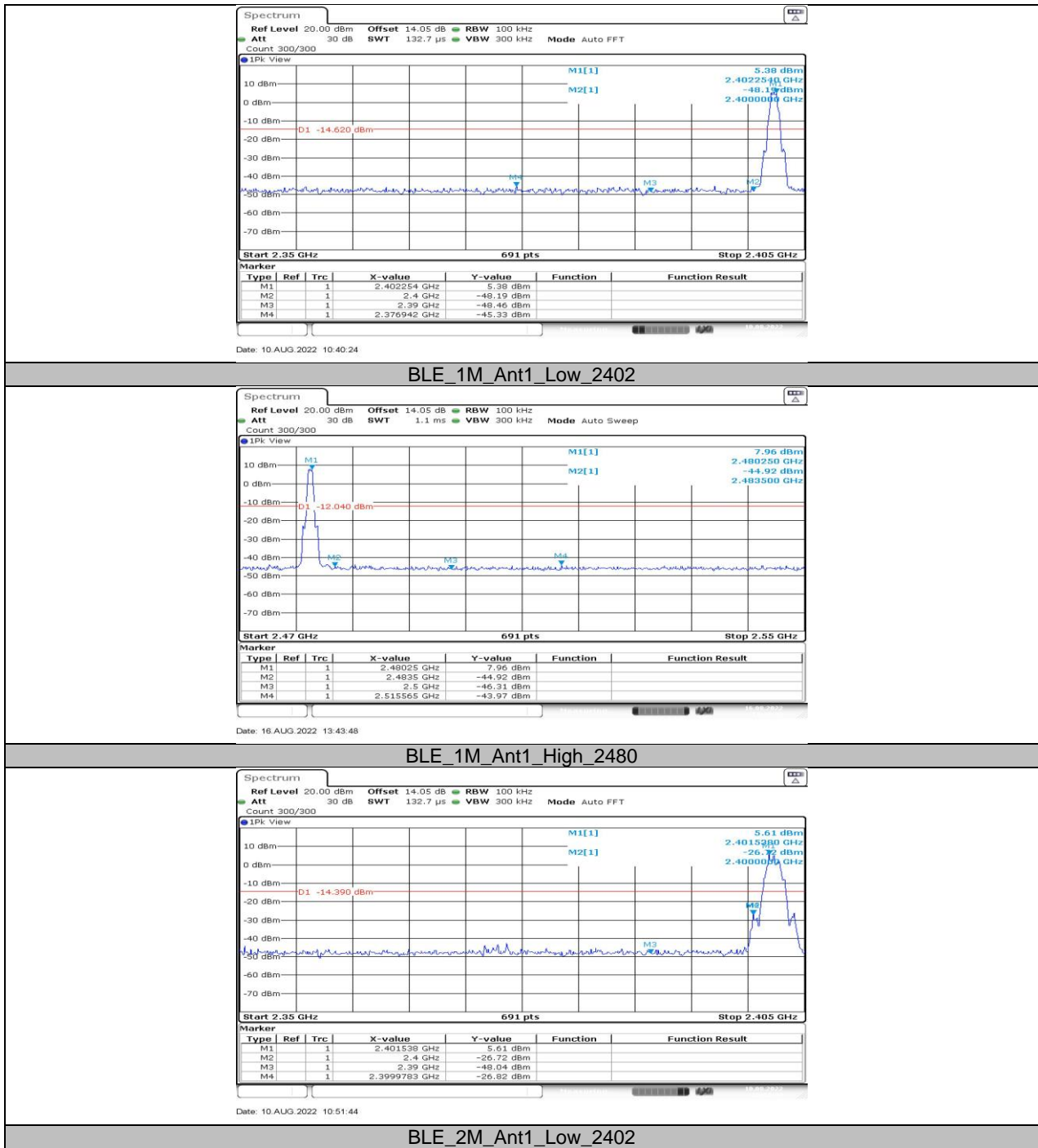

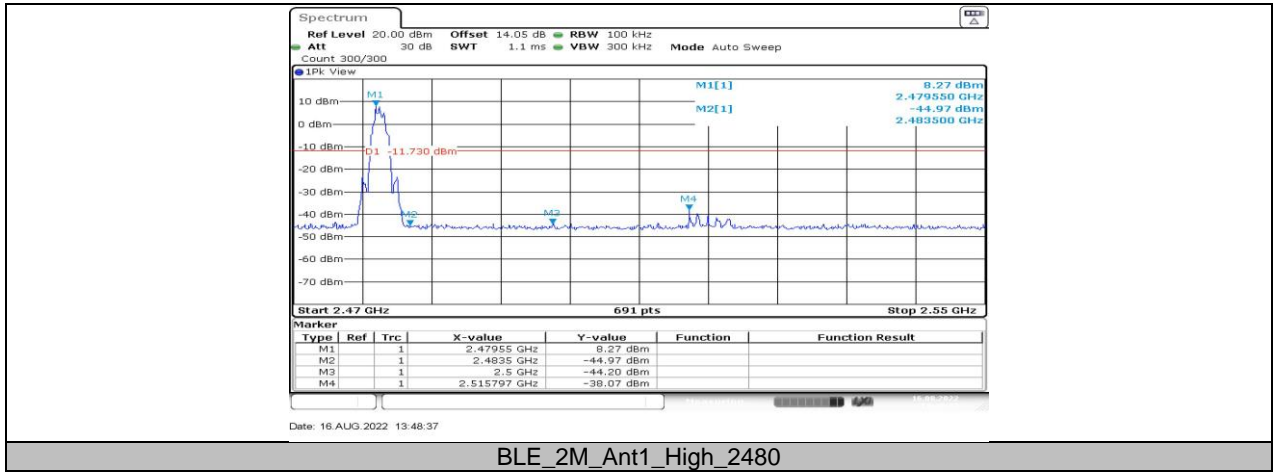



## 11.6. APPENDIX F: CONDUCTED SPURIOUS EMISSION

### 11.6.1. Test Result

Test Mode	Antenna	Channel	FreqRange [MHz]	Result[dBm]	Limit[dBm]	Verdict
BLE_1M	Ant1	2402	Reference	5.37	---	PASS
			30~1000	-53.96	≤-14.63	PASS
			1000~26500	-48.94	≤-14.63	PASS
		2440	Reference	8.17	---	PASS
			30~1000	-54.34	≤-11.83	PASS
			1000~26500	-48.78	≤-11.83	PASS
		2480	Reference	7.89	---	PASS
			30~1000	-53.4	≤-12.11	PASS
			1000~26500	-48.82	≤-12.11	PASS
BLE_2M	Ant1	2402	Reference	5.68	---	PASS
			30~1000	-54.32	≤-14.32	PASS
			1000~26500	-48.6	≤-14.32	PASS
		2440	Reference	8.53	---	PASS
			30~1000	-54.33	≤-11.47	PASS
			1000~26500	-48.65	≤-11.47	PASS
		2480	Reference	8.22	---	PASS
			30~1000	-53.47	≤-11.78	PASS
			1000~26500	-48.8	≤-11.78	PASS



### 11.6.2. Test Graphs

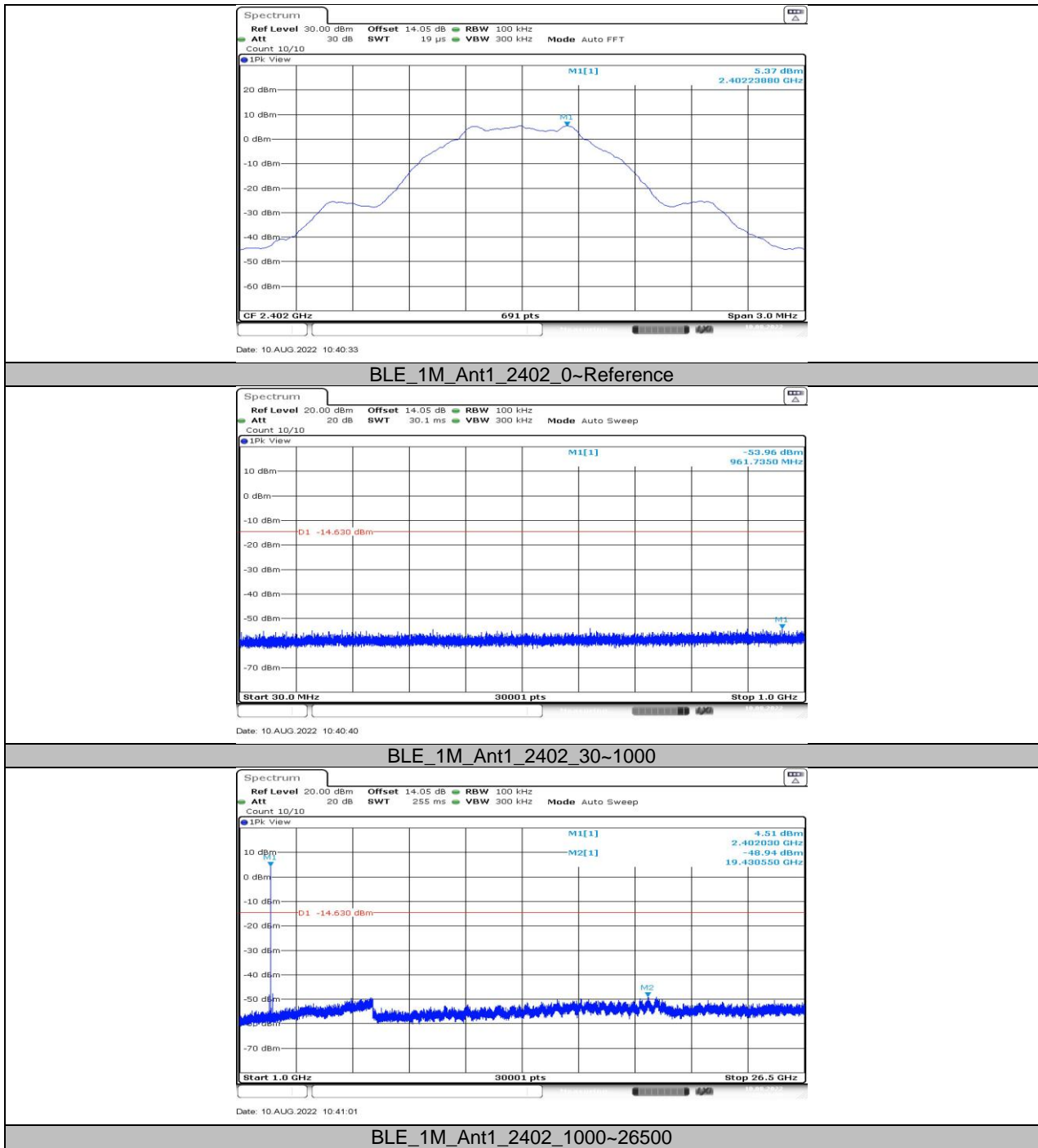



BLE\_1M\_Ant1\_2440\_0~Reference

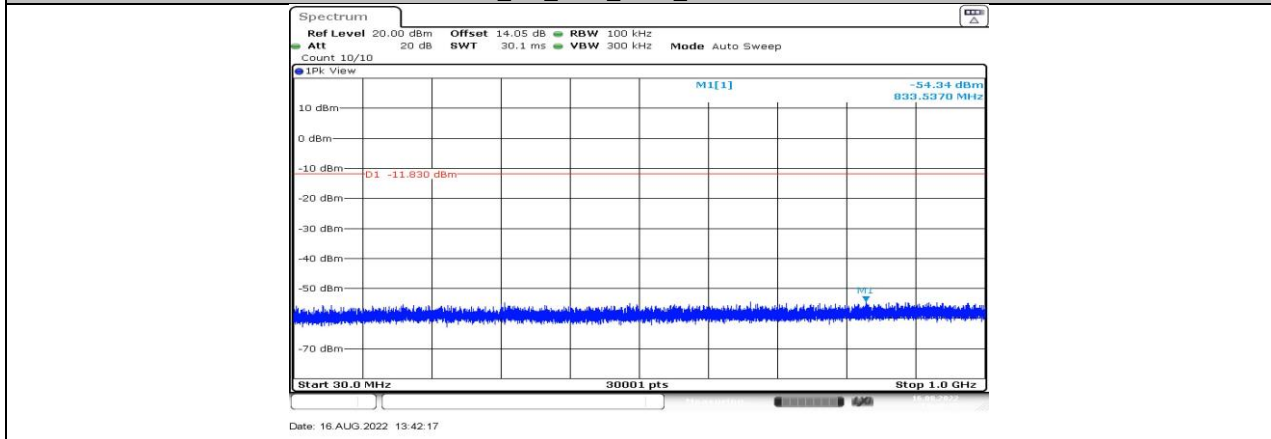

BLE\_1M\_Ant1\_2440\_30~1000

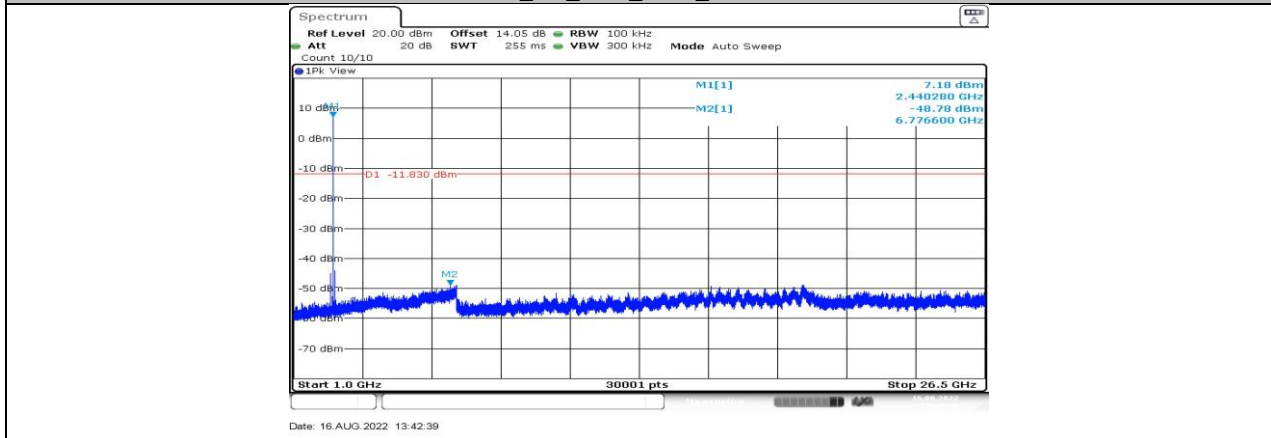

BLE\_1M\_Ant1\_2440\_1000~26500



BLE\_1M\_Ant1\_2480\_0~Reference

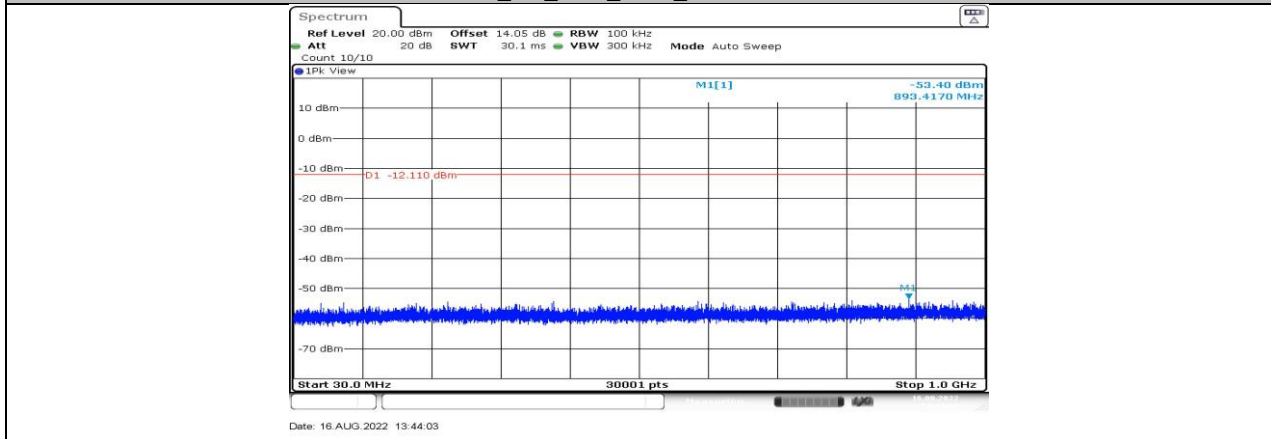

BLE\_1M\_Ant1\_2480\_30~1000

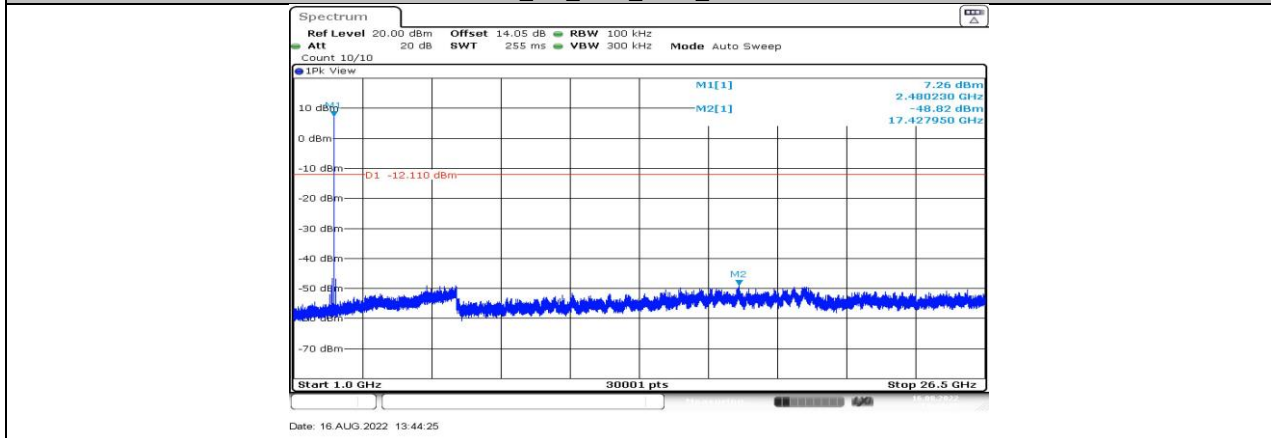

BLE\_1M\_Ant1\_2480\_1000~26500



BLE\_2M\_Ant1\_2402\_0~Reference

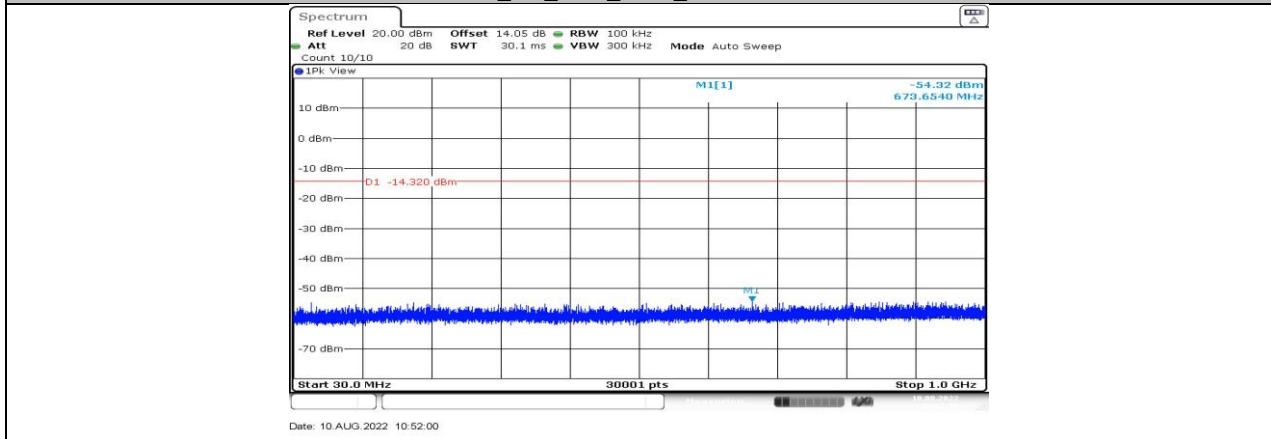

BLE\_2M\_Ant1\_2402\_30~1000

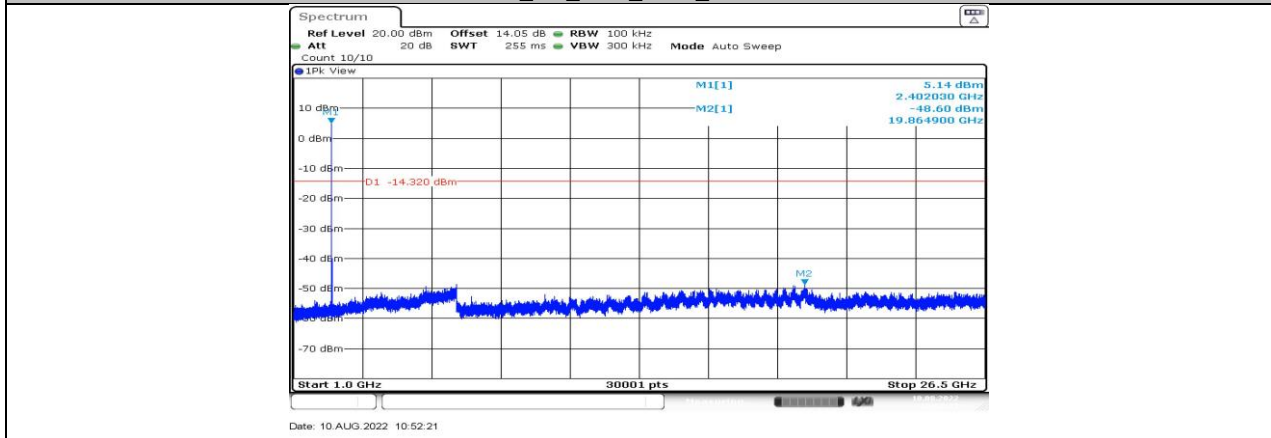

BLE\_2M\_Ant1\_2402\_1000~26500

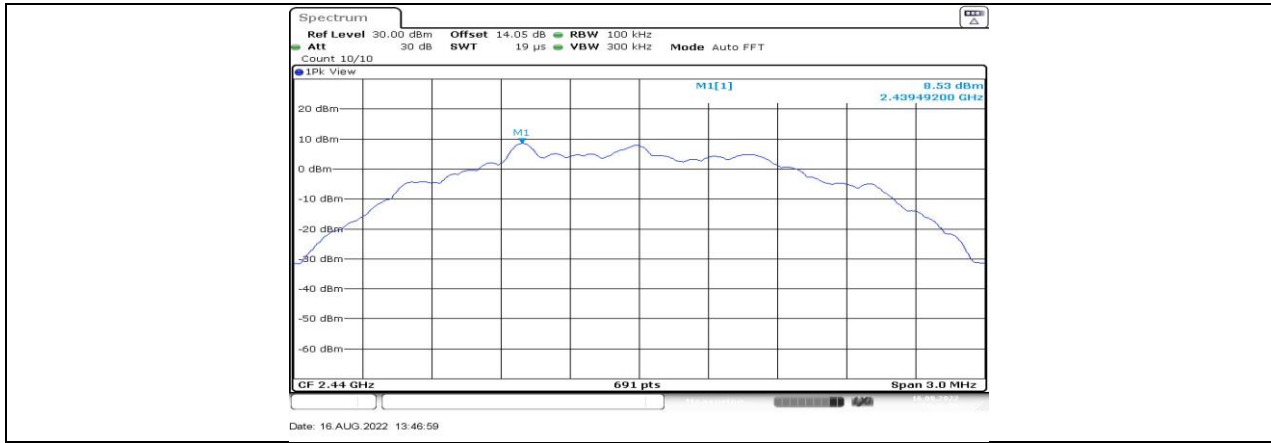

BLE\_2M\_Ant1\_2440\_0~Reference

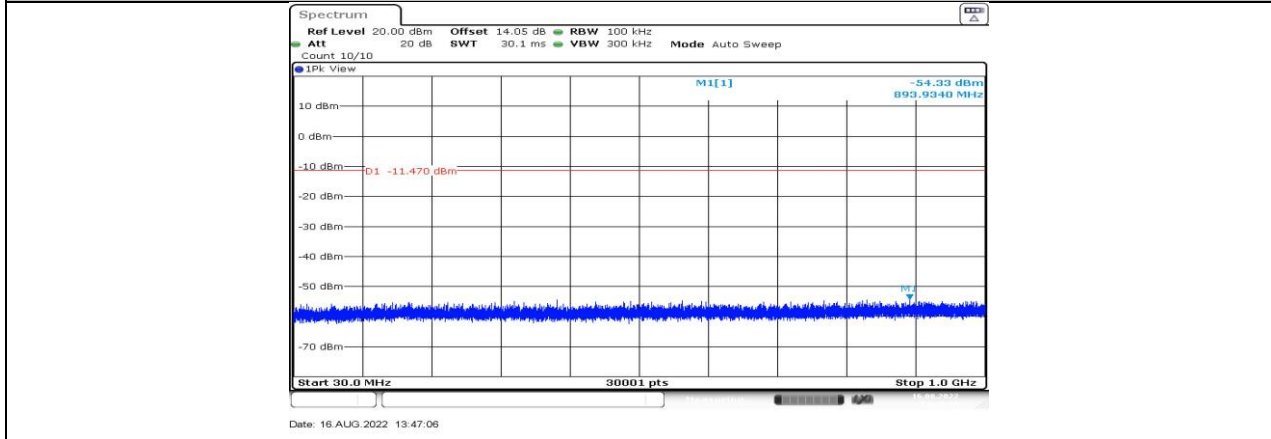

BLE\_2M\_Ant1\_2440\_30~1000

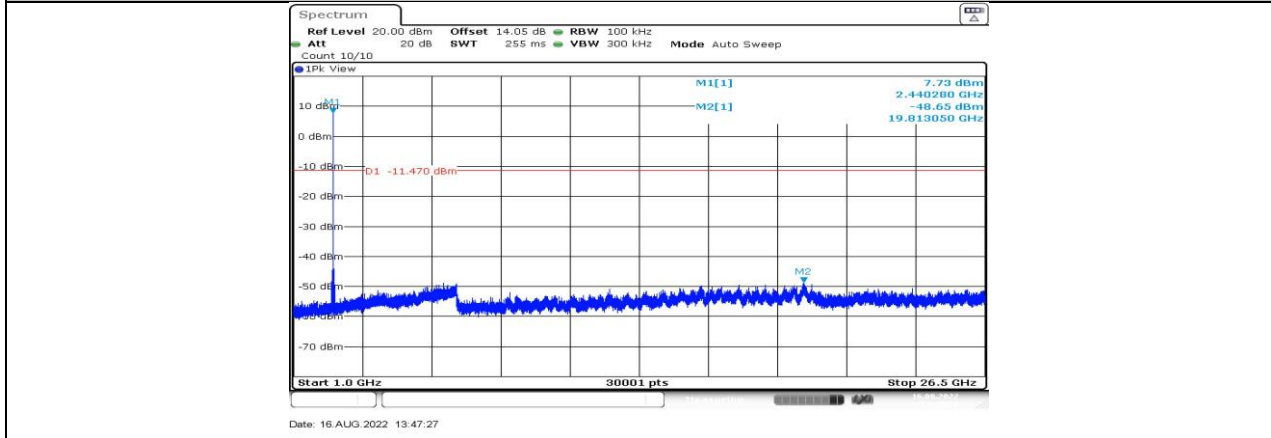

BLE\_2M\_Ant1\_2440\_1000~26500

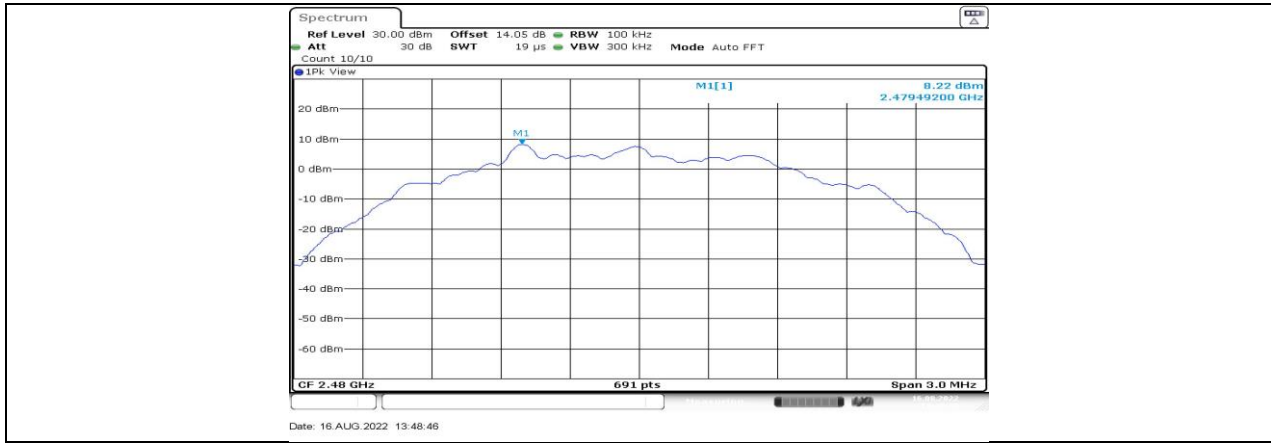

BLE\_2M\_Ant1\_2480\_0~Reference

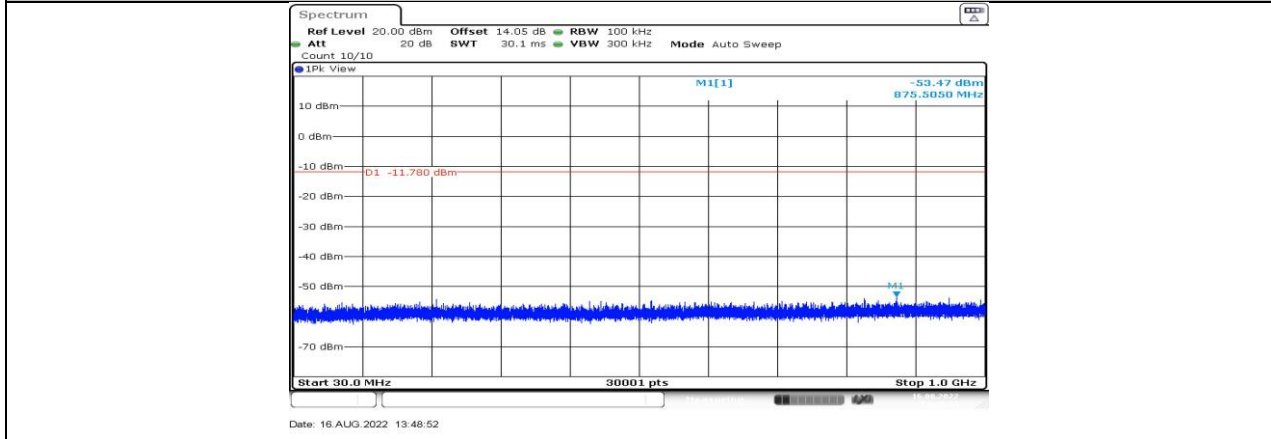

BLE\_2M\_Ant1\_2480\_30~1000

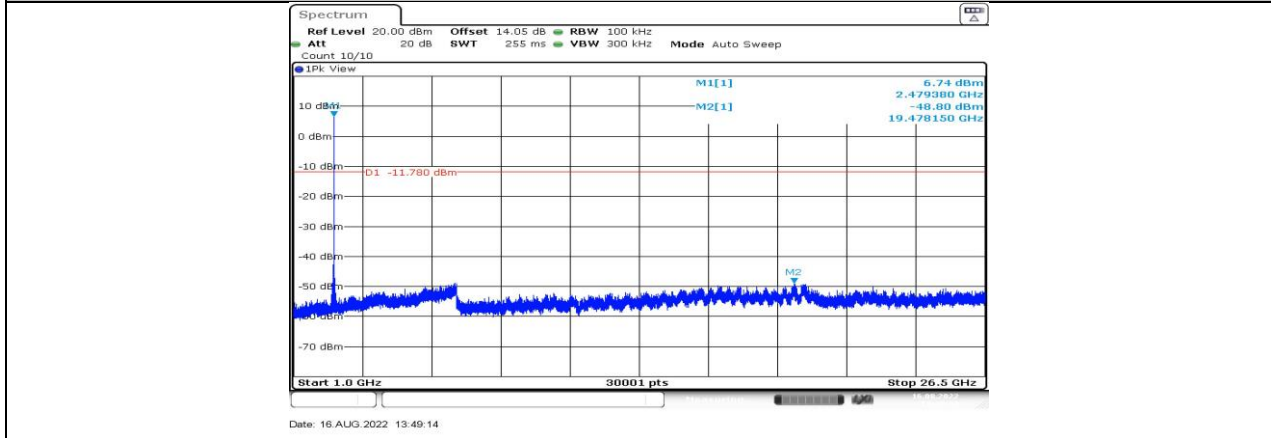

BLE\_2M\_Ant1\_2480\_1000~26500



## 11.7. APPENDIX G: DUTY CYCLE

### 11.7.1. Test Result

Test Mode	On Time (msec)	Period (msec)	Duty Cycle x (Linear)	Duty Cycle (%)	Duty Cycle Correction Factor (dB)	1/T Minimum VBW (kHz)	Final setting For VBW (kHz)
BLE_1M	0.39	0.62	0.6290	62.90	2.01	2.56	3
BLE_2M	0.21	0.62	0.3387	33.87	4.70	4.76	5

Note:

Duty Cycle Correction Factor= $10\log(1/x)$ .

Where: x is Duty Cycle (Linear)

Where: T is On Time

If that calculated VBW is not available on the analyzer then the next higher value should be used.

### 11.7.2. Test Graphs

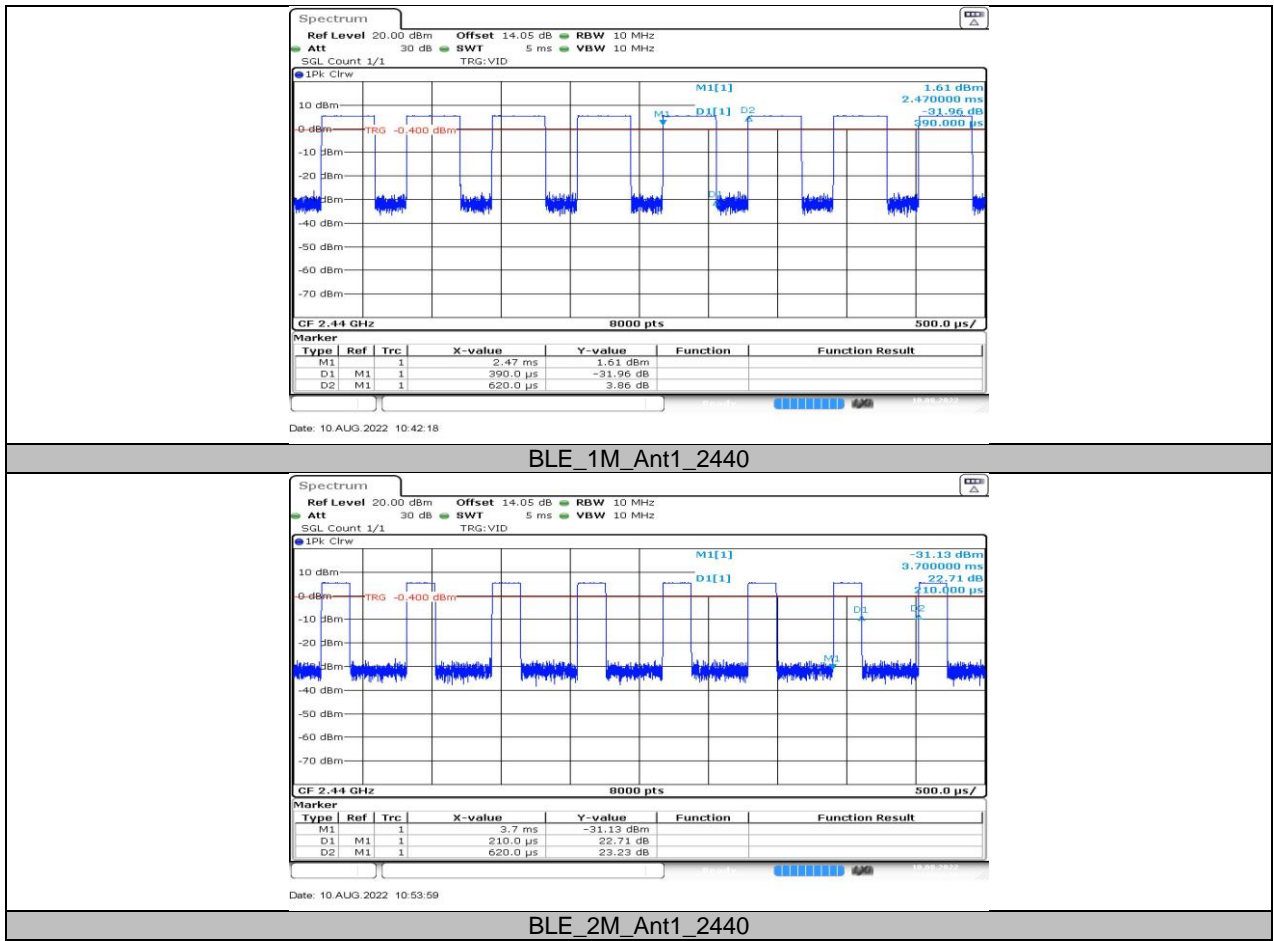

**END OF REPORT**