

EXHIBIT 9**Internal Photographs**

(Pursuant to FCC Part 2.1033(b)(7), 2.1033(c)(12) and RSP 100 Annex C)

The following photographs are attached.	<u>Exhibit</u>
1. RF board <u>with</u> Shields (Top)	9A
2. RF board <u>without</u> Shields (Top)	9B
3. RF board <u>with</u> Shields (Bottom)	9C
4. RF board <u>without</u> Shields (Bottom)	9D
5. Chassis and control heads (Top)	9E
6. Chassis and control heads (Bottom)	9F
7. GOB Rev A board (Top)	9G
8. GOB Rev A board with Shields (Bottom)	
9. GOB Rev A board without Shields (Bottom)	
10. GOB Rev B board (Top)	9H
11. GOB Rev B board with Shields (Bottom)	
12. GOB Rev B board without Shields (Bottom)	
13. GOB Rev C board (Top)	9I
14. GOB Rev C board with Shields (Bottom)	
15. GOB Rev C board without Shields (Bottom)	
16. WiFi/GPS/BT board (Top)	9J
17. WiFi/GPS/BT board with Shields (Bottom)	9K
18. WiFi/GPS/BT board without Shields (Bottom)	9L
19. Exploded view of radio	9M
20. Exploded view of colour display control head	9N
21. Exploded view of numeric display control head	9O

Exhibit 9A - RF board with Shields (Top)

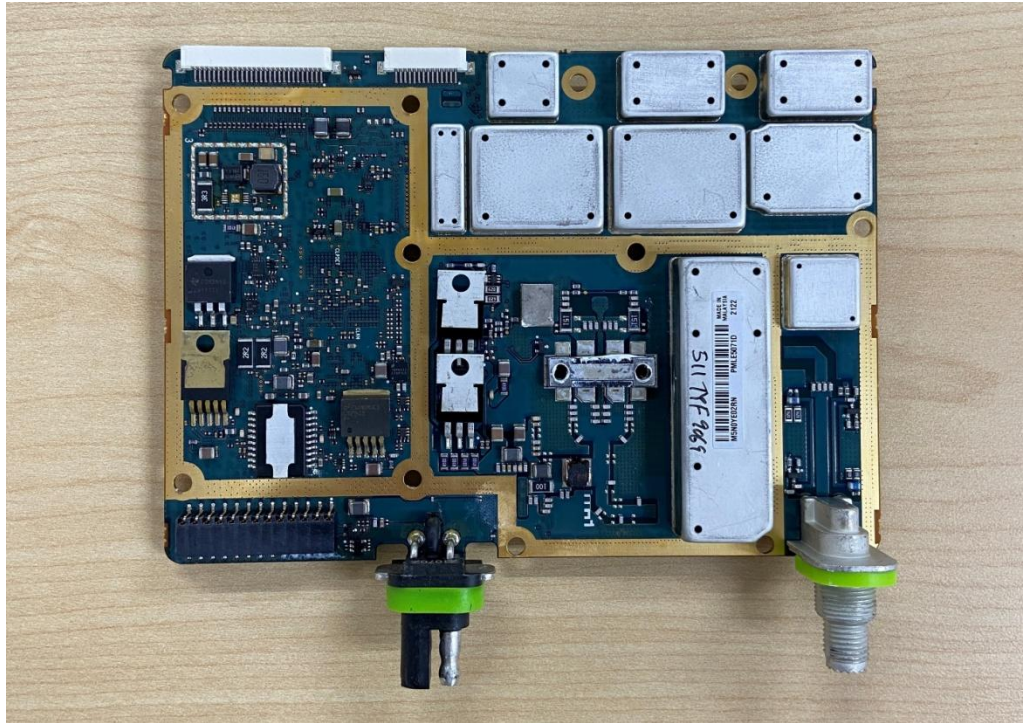

Exhibit 9B - RF board without Shields (Top)

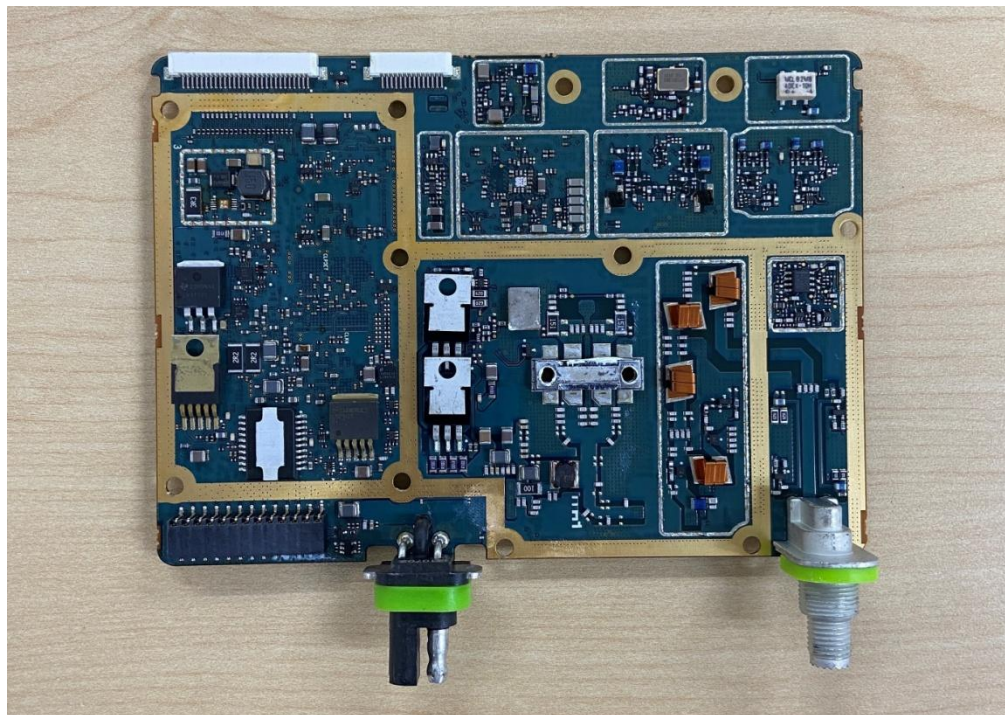

Exhibit 9C - RF board with Shields (Bottom)

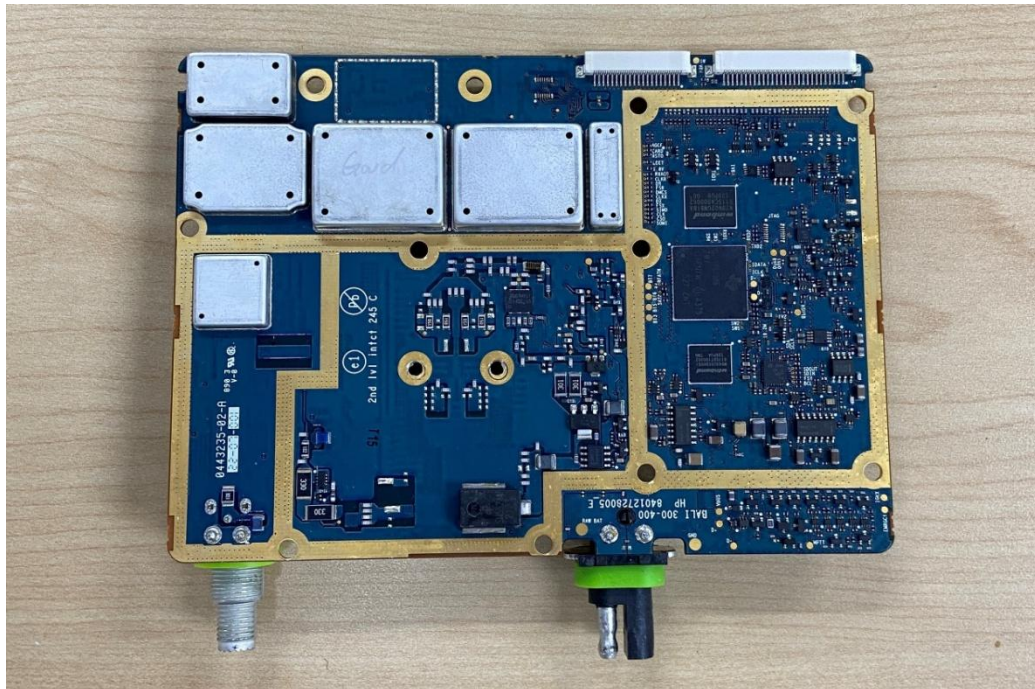

Exhibit 9D - RF board without Shields (Bottom)

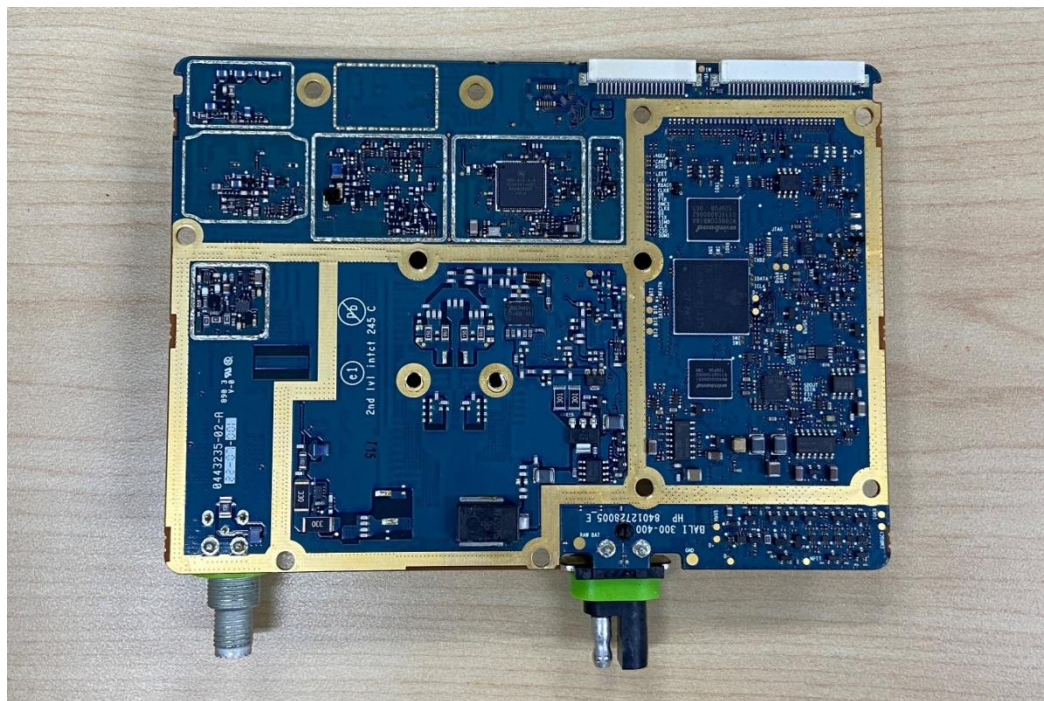
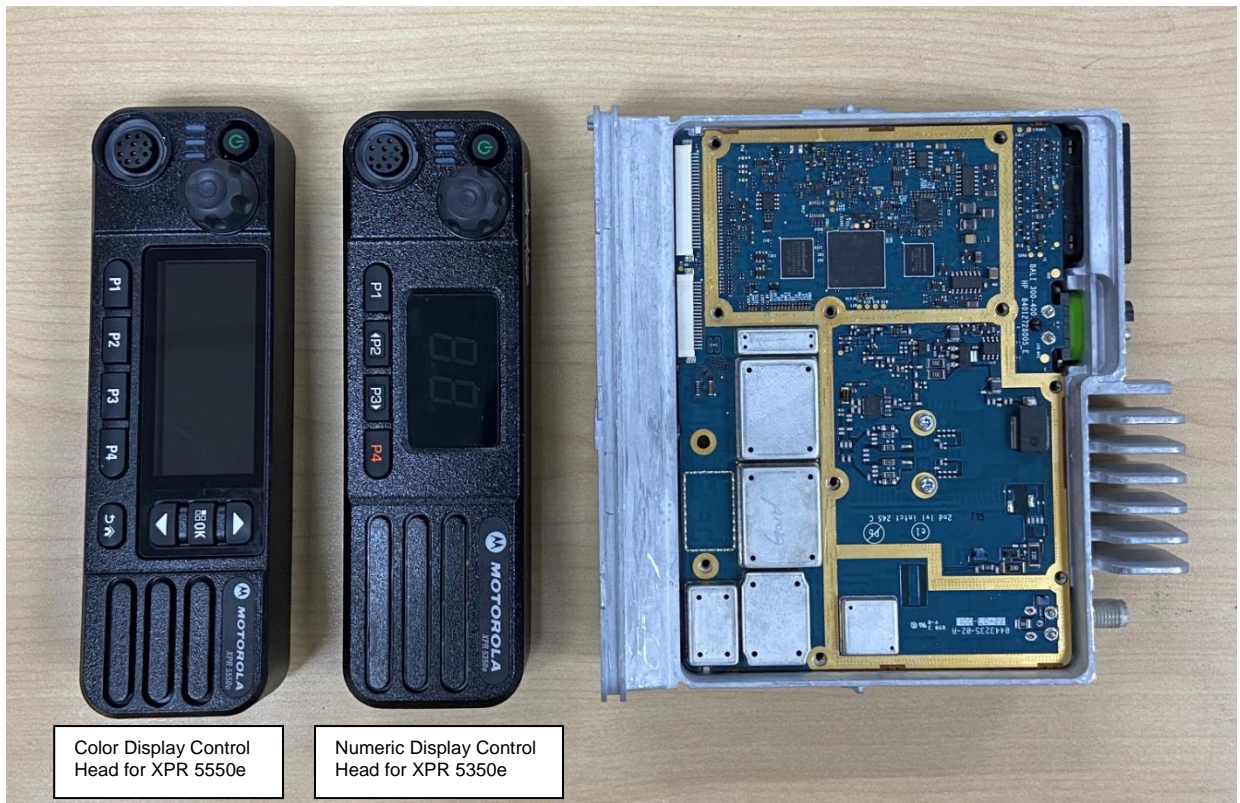

Exhibit 9E - Chassis and control heads (Top)



Color Display Control Head for XPR 5550e

Numeric Display Control Head for XPR 5350e

Exhibit 9F - Chassis and control heads (Bottom)

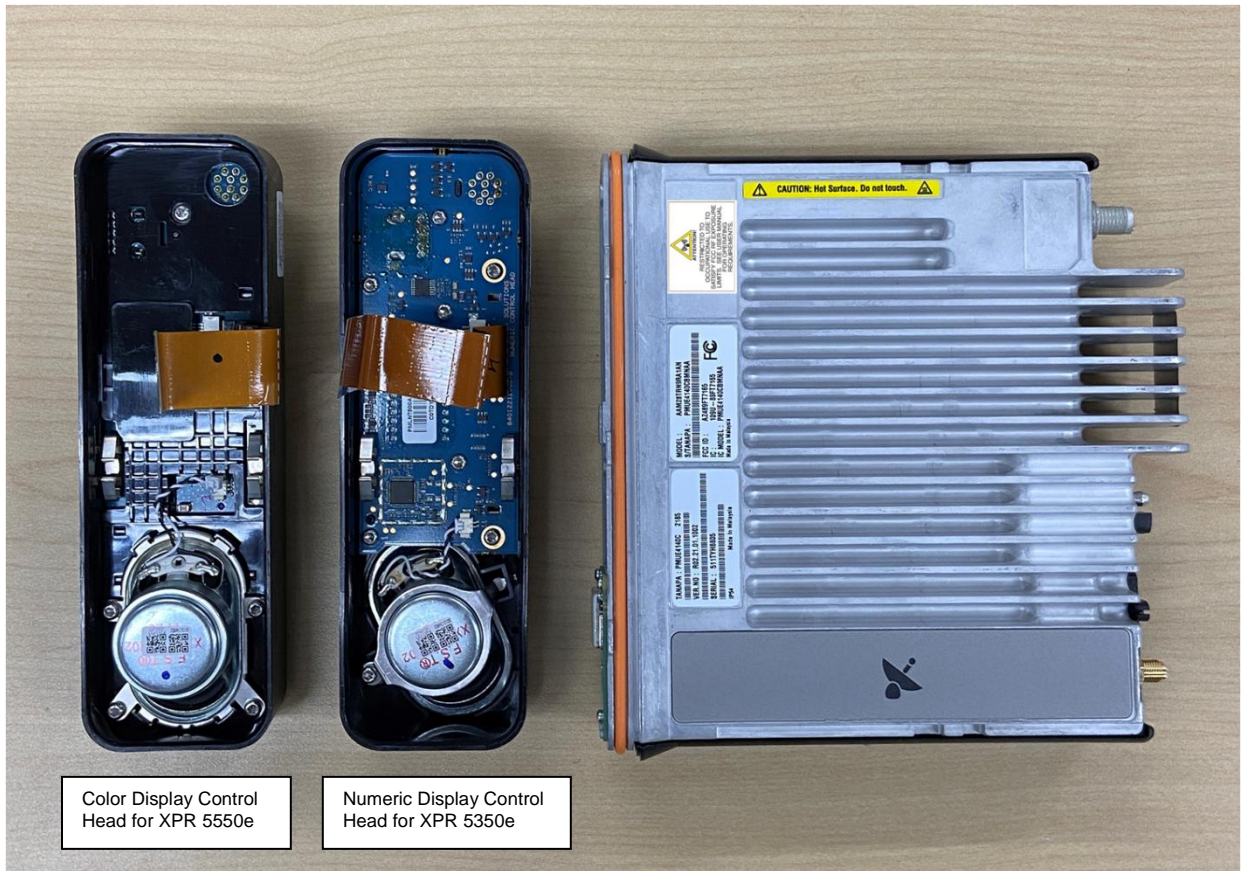

Color Display Control Head for XPR 5550e

Numeric Display Control Head for XPR 5350e

Exhibit 9G

GOB Rev A board with Shield (Top)



GOB Rev A board without Shield (Top)

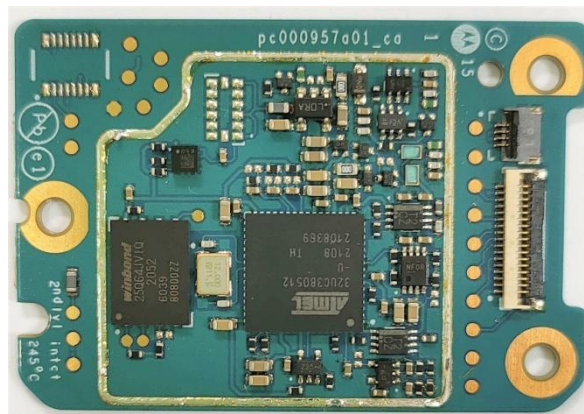

GOB Rev A board (Bottom)

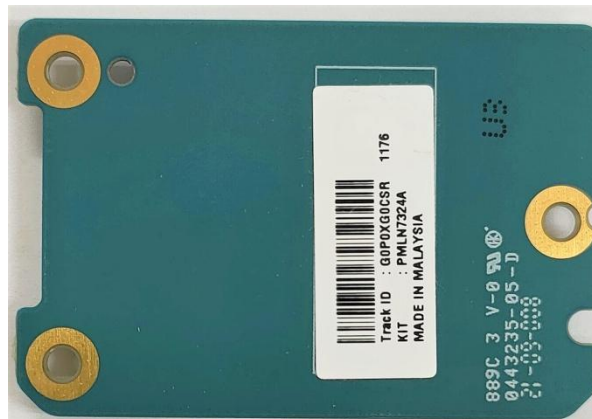
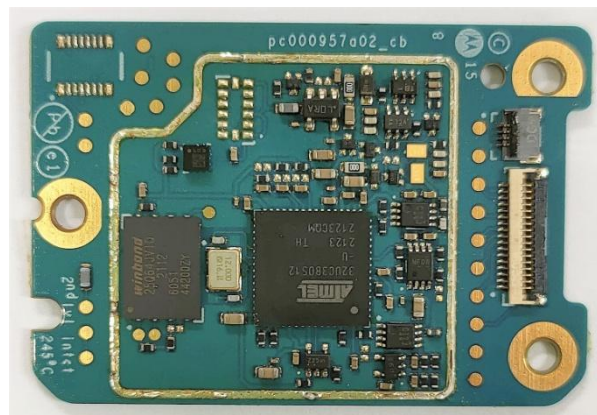

Exhibit 9H

GOB Rev B board with Shield (Top)



GOB Rev B board without Shield (Top)



GOB Rev B board (Bottom)

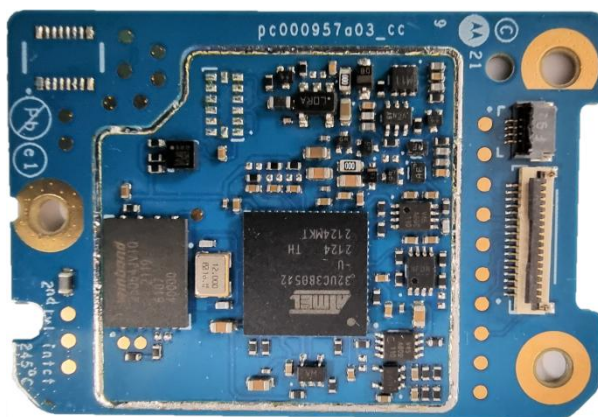

Exhibit 9

GOB Rev C board with Shield (Top)



GOB Rev C board without Shield (Top)



GOB Rev C board (Bottom)



Exhibit 9J - WiFi/GPS/BT board with Shields (Top)



Exhibit 9K - WiFi/GPS/BT board with Shields (Bottom)



Exhibit 9L - WiFi/GPS/BT board without Shields (Bottom)

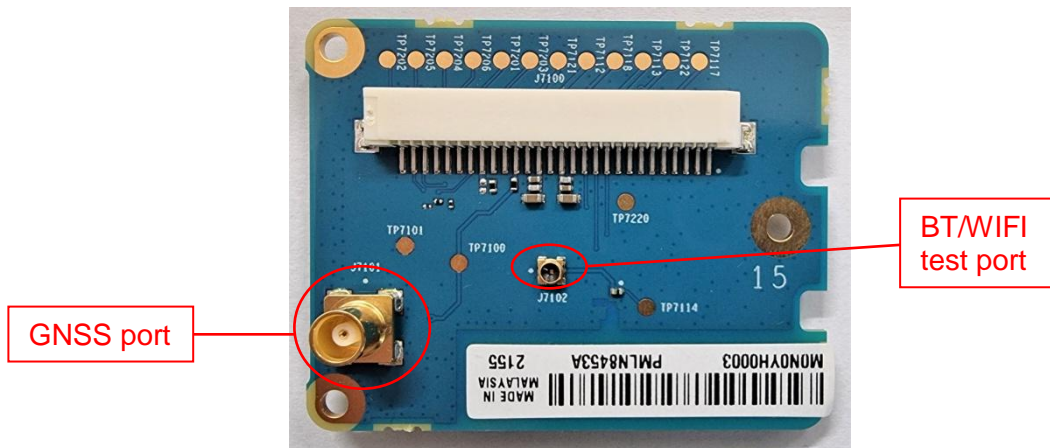

Exhibit 9M - Exploded view of radio

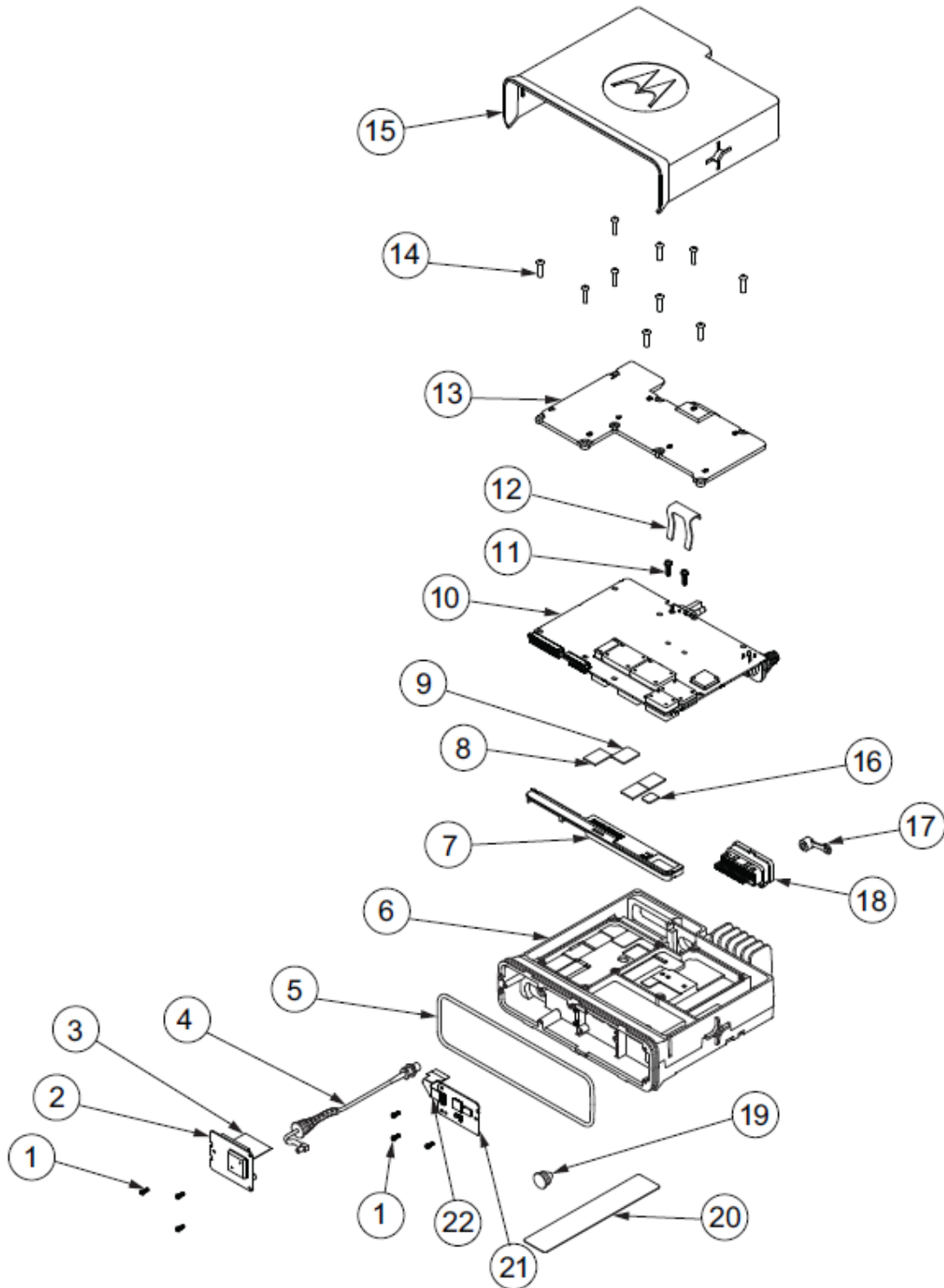

Exhibit 9N - Exploded view of colour display control head

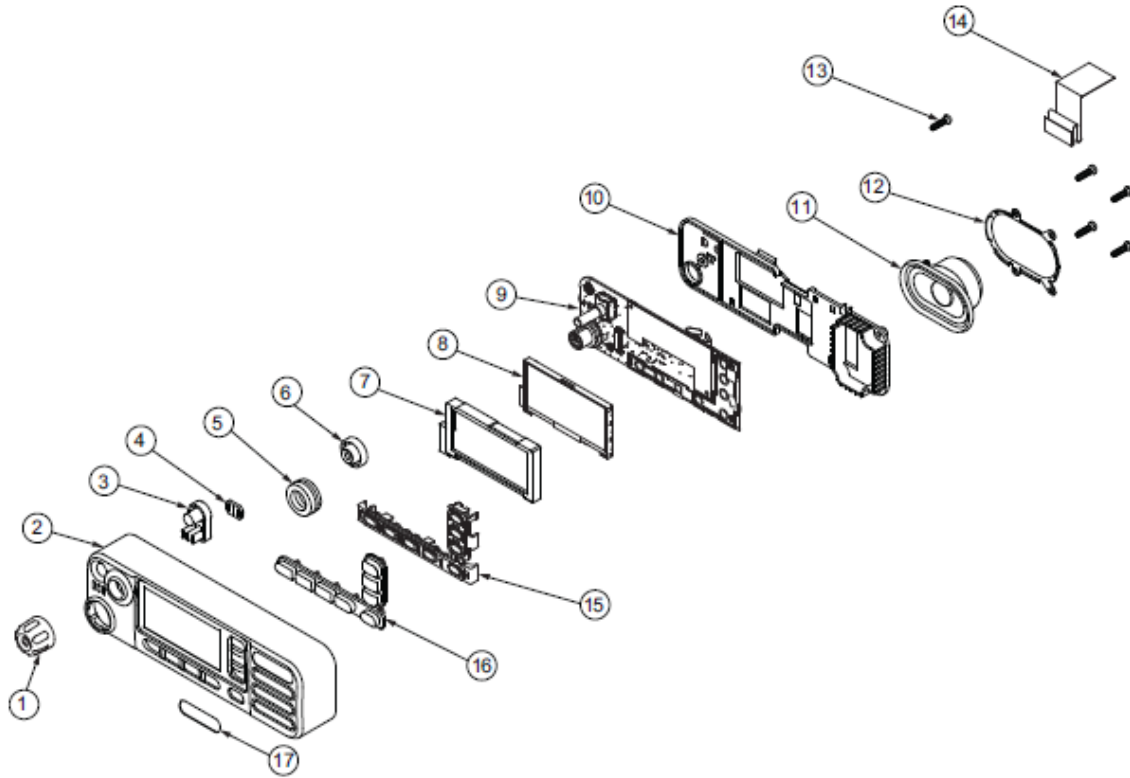
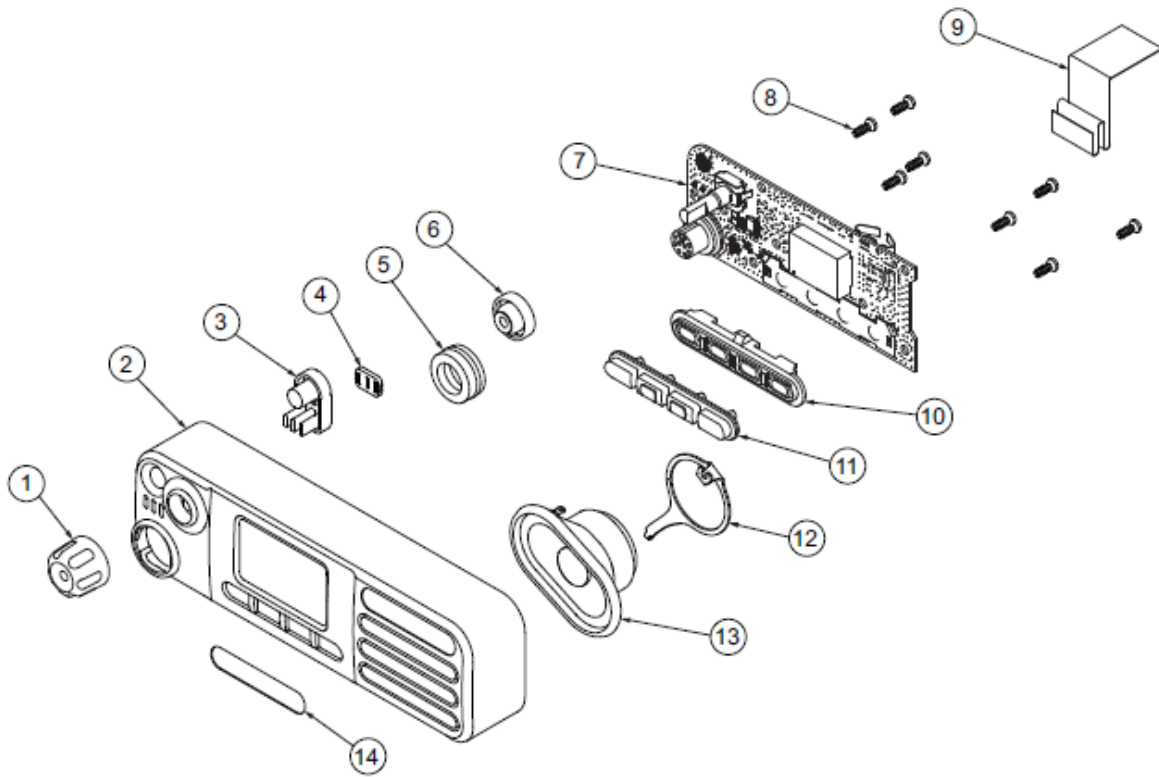

Exhibit 90 - Exploded view of numeric display control head



*** END ***