

**EXHIBIT 9****Internal Photographs**

(Pursuant to FCC Part 2.1033(b)(7), 2.1033(c)(12) and RSP 100 Annex C)

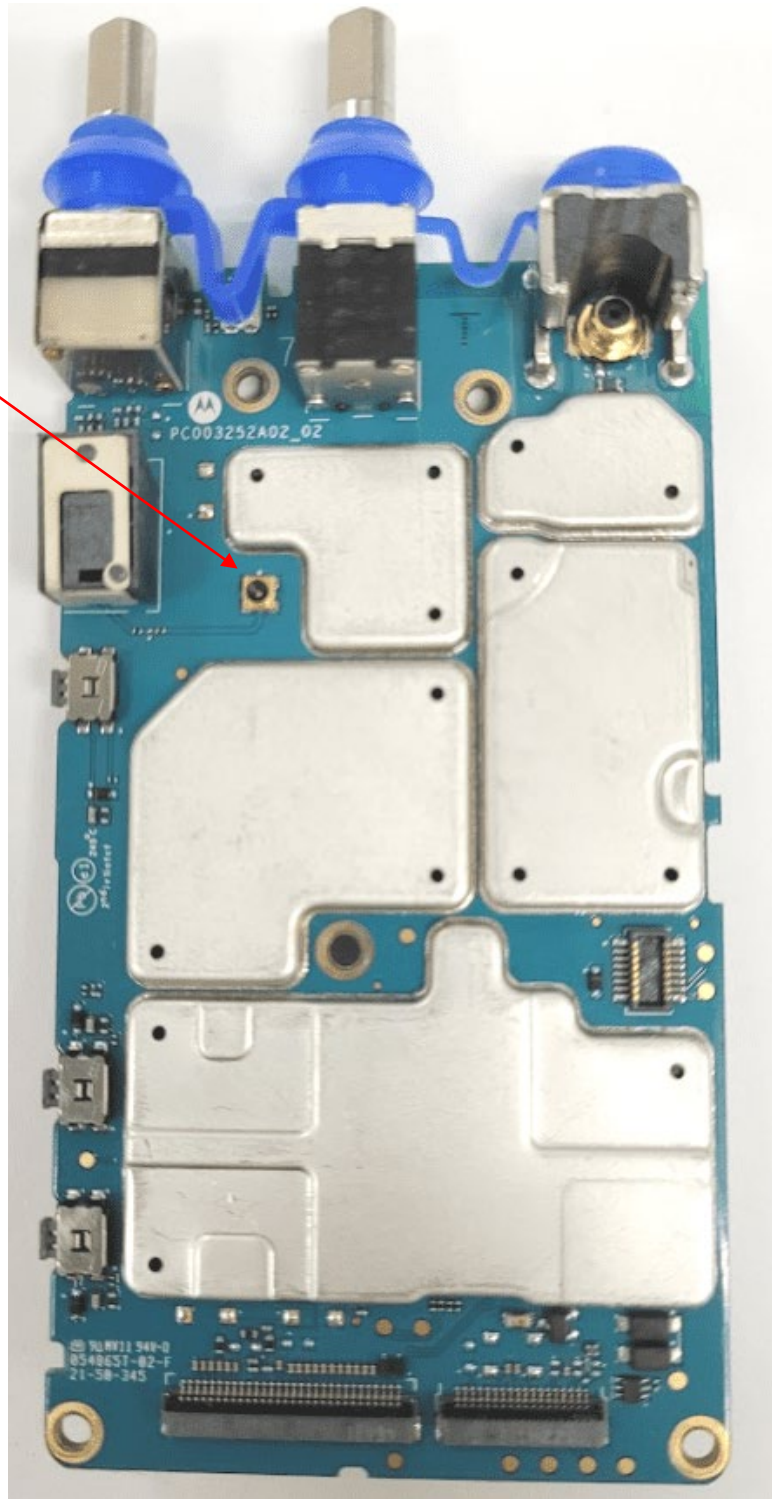
The following photographs are attached.

Exhibit

- |  |    |
|--|----|
| 1. RF board <u>with</u> Shields (Top) Non-TIA4950                          | 9A |
| 2. RF board <u>without</u> Shields (Top) Non-TIA4950                       | 9B |
| 3. RF board <u>with</u> Shields (Top) TIA4950                              | 9C |
| 4. RF board <u>without</u> Shields (Top) TIA4950                           | 9D |
| 5. RF board <u>with</u> Shields (Bottom) Non-TIA4950                       | 9E |
| 6. RF board <u>without</u> Shields (Bottom) Non-TIA4950                    | 9F |
| 7. RF board <u>with</u> Shields (Bottom) TIA4950                           | 9G |
| 8. RF board <u>without</u> Shields (Bottom) TIA4950                        | 9H |
| 9. RF boards <u>with</u> chassis and housing (Front Side) LKP Non-TIA4950  | 9I |
| 10. Chassis and Housing (Back Side) LKP Non-TIA4950                        | 9J |
| 11. RF boards <u>with</u> chassis and housing (Front Side) LKP TIA4950     | 9K |
| 12. Chassis and housing (Back Side) LKP TIA4950                            | 9L |
| 13. RF boards <u>with</u> chassis and housing (Front Side) NKP Non-TIA4950 | 9M |
| 14. Chassis and housing (Back Side) NKP Non-TIA4950                        | 9N |
| 15. RF boards <u>with</u> chassis and housing (Front Side) NKP TIA4950     | 9O |
| 16. Chassis and housing (Back Side) NKP TIA4950                            | 9P |
| 17. Limited Keypad Board (Top)   | 9Q |
| 18. Limited Keypad Board (Bottom)  | 9R |

**Exhibit 9A**

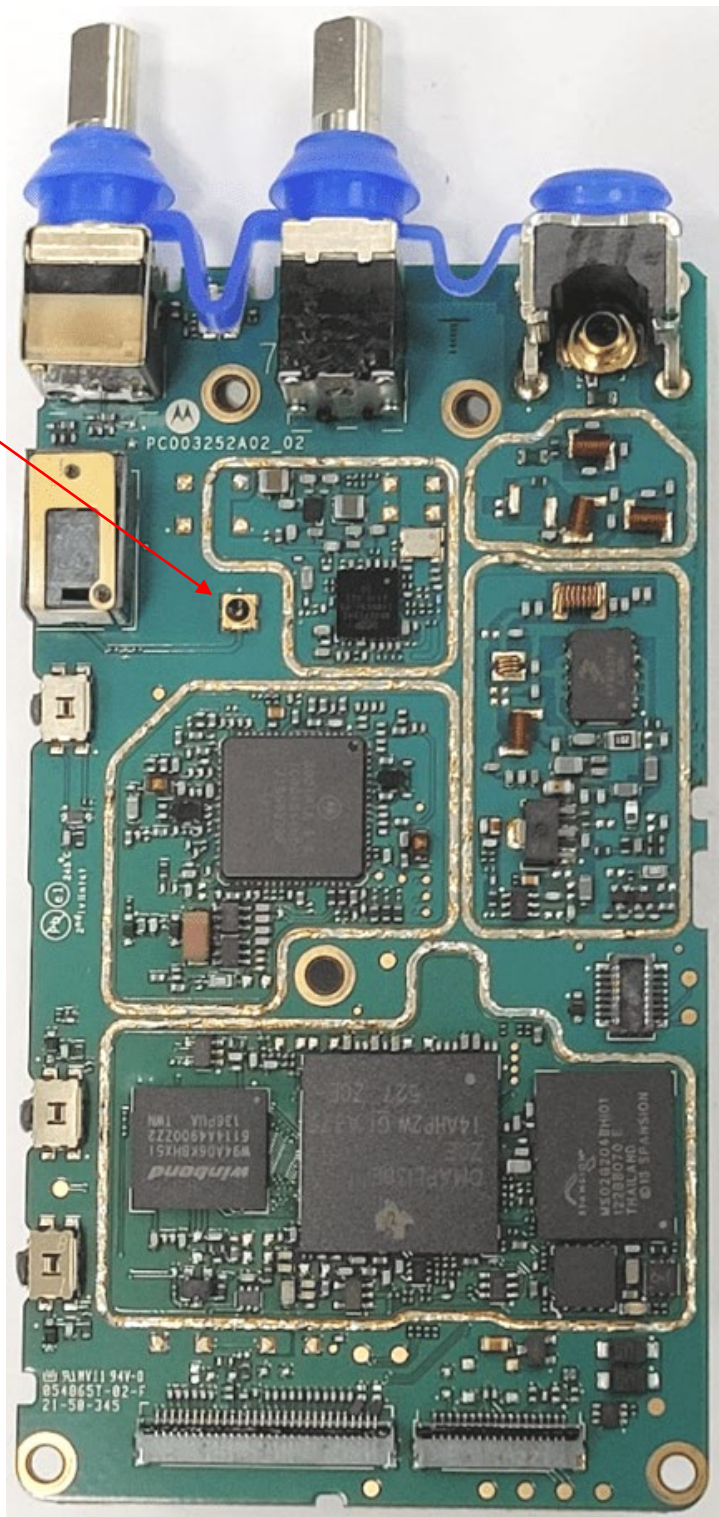
BT/WIFI  
RF port



**RF board with Shields (Top) Non-TIA4950**

**Exhibit 9B**

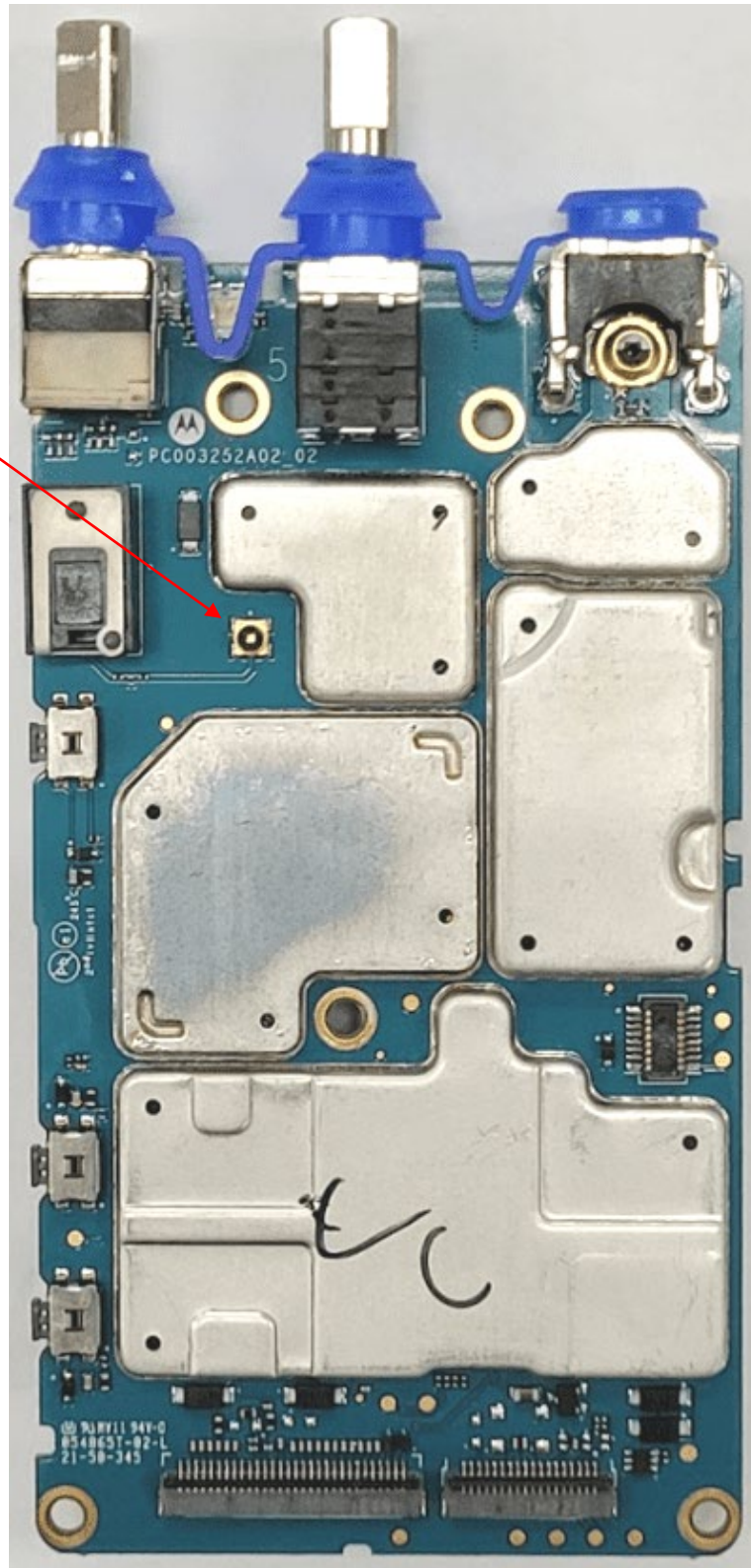
BT/WIFI  
RF port



**RF board without Shields (Top) Non-TIA4950**

**Exhibit 9C**

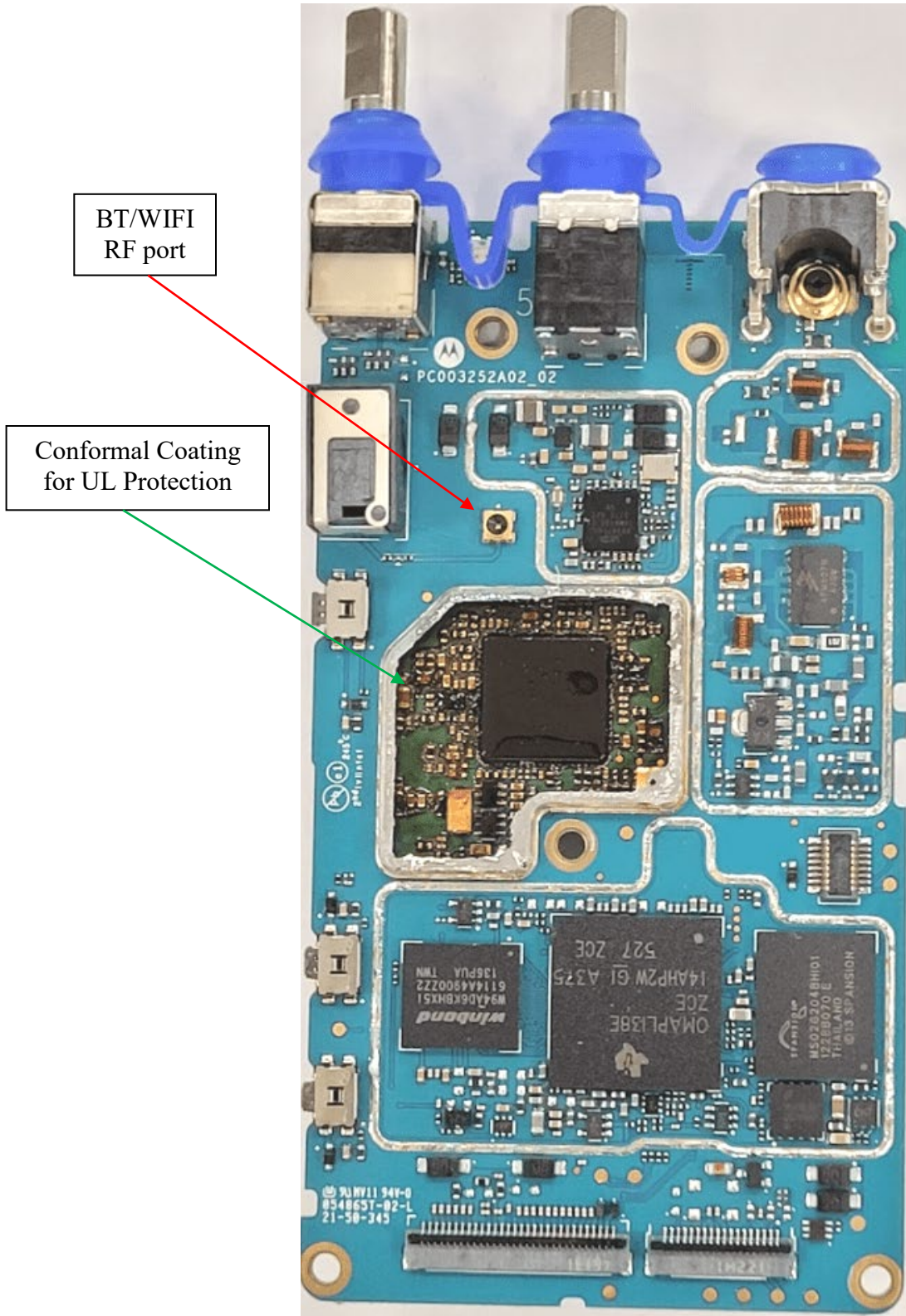
BT/WIFI  
RF port



RF board with Shields (Top) TIA4950

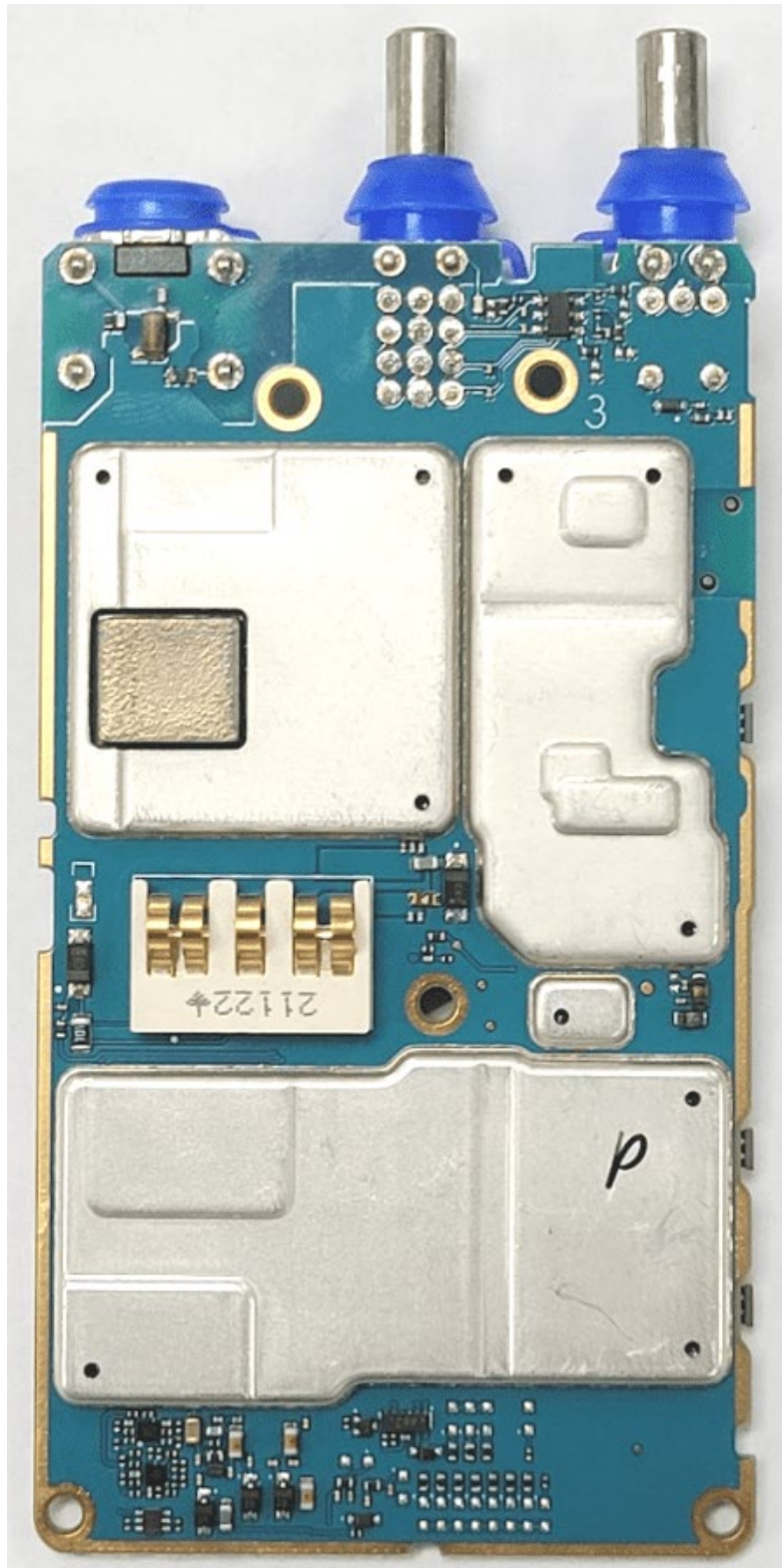


**Exhibit 9D**



**RF board without Shields (Top) TIA4950**

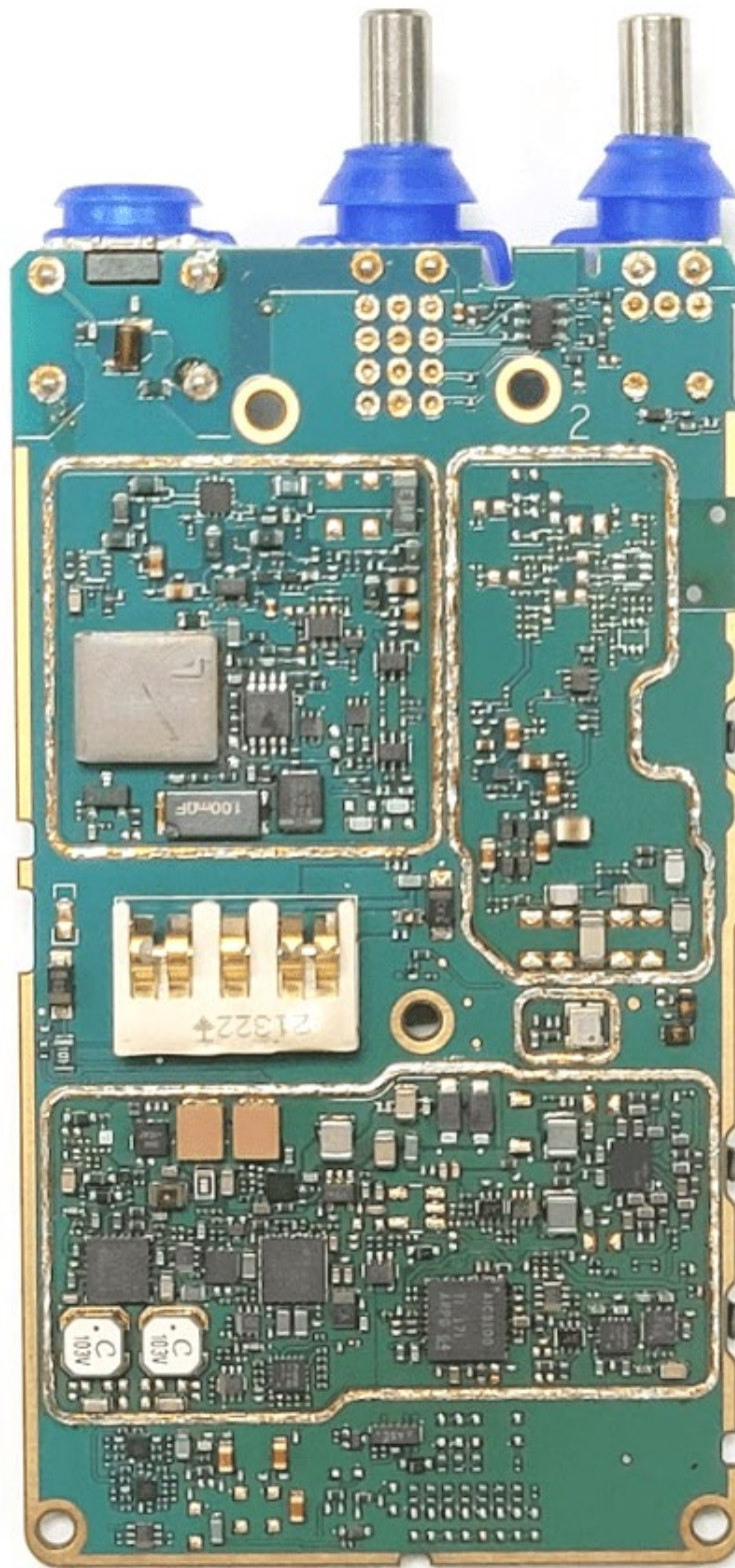
**Exhibit 9E**



RF board with Shields (Bottom) Non-TIA4950

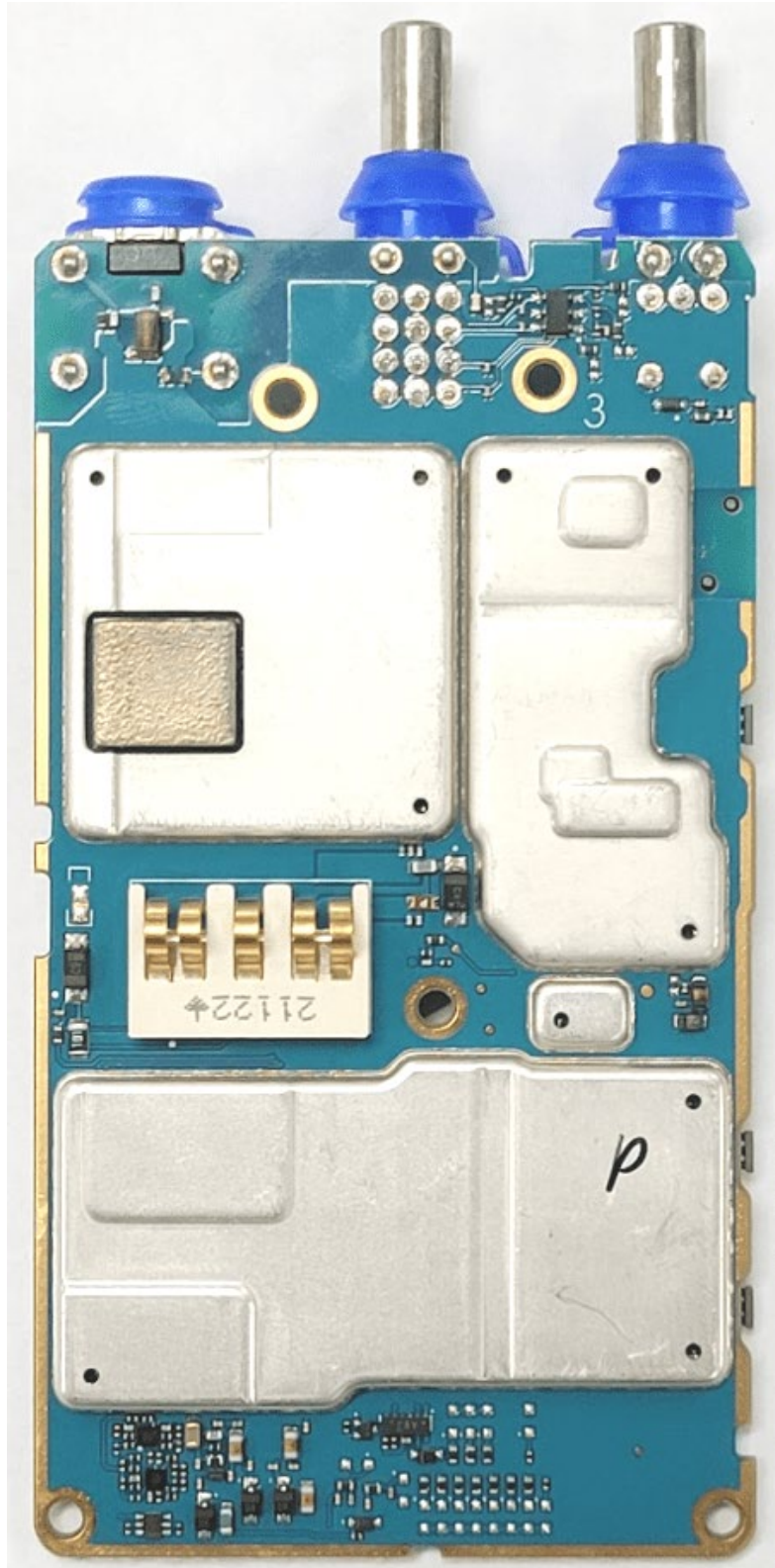


**Exhibit 9F**



**RF board without Shields (Bottom) Non-TIA4950**

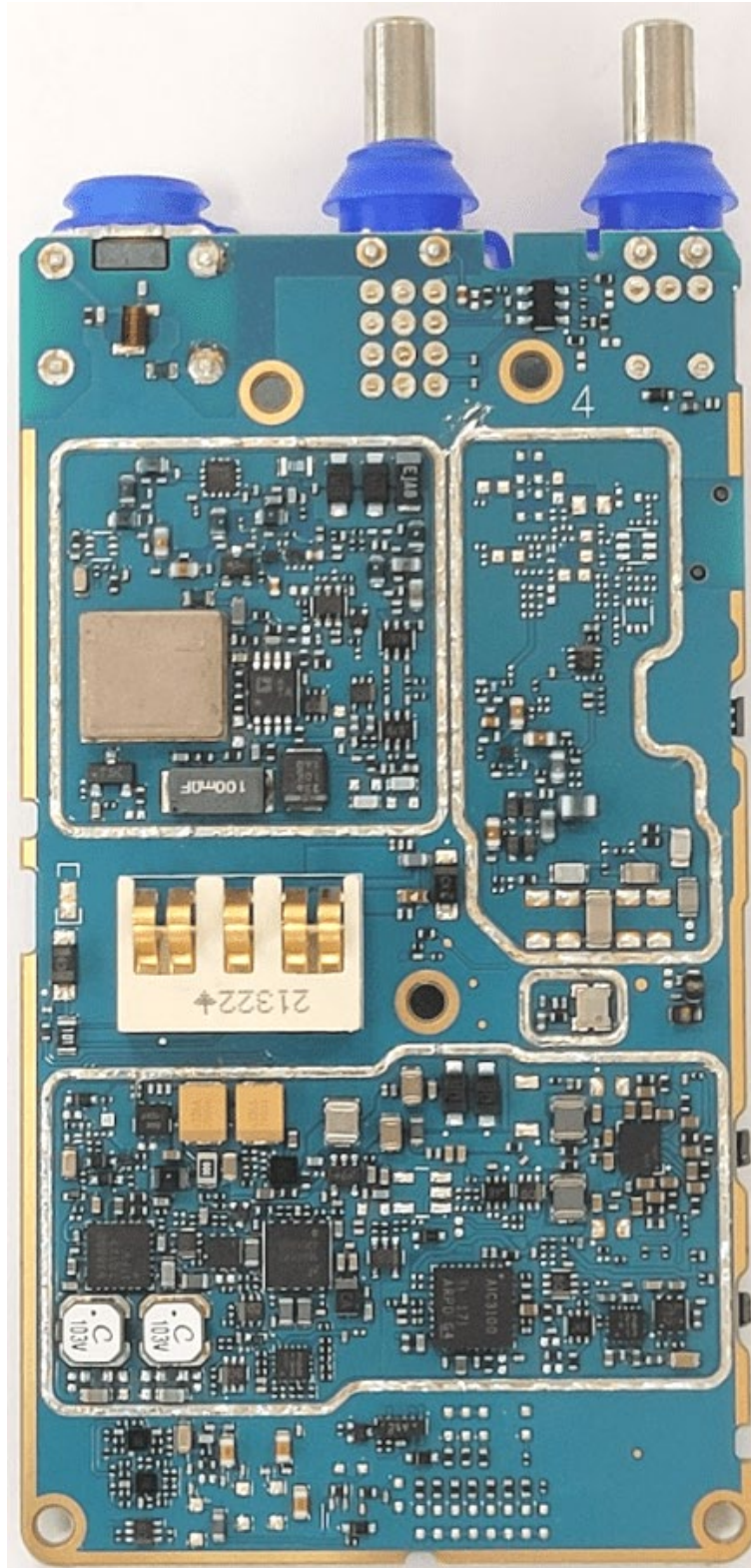
**Exhibit 9G**



**RF board with Shields (Bottom) TIA4950**



**Exhibit 9H**



**RF board without Shields (Bottom) TIA4950**

**Exhibit 9!**



**RF boards with chassis and housing (Front Side) LKP Non-TIA4950**



**Exhibit 9J**



**Chassis and housing (Back Side) LKP Non-TIA4950**



**Exhibit 9K**



**RF boards with chassis and housing (Front Side) LKP TIA4950**

**Exhibit 9L**



**Chassis and housing (Back Side) LKP TIA4950**



**Exhibit 9M**



**RF boards with chassis and housing (Front Side) NKP Non-TIA4950**



**Exhibit 9N**



**Chassis and housing (Back Side) NKP Non-TIA4950**

**Exhibit 90**



**RF boards with chassis and housing (Front Side) NKP TIA4950**



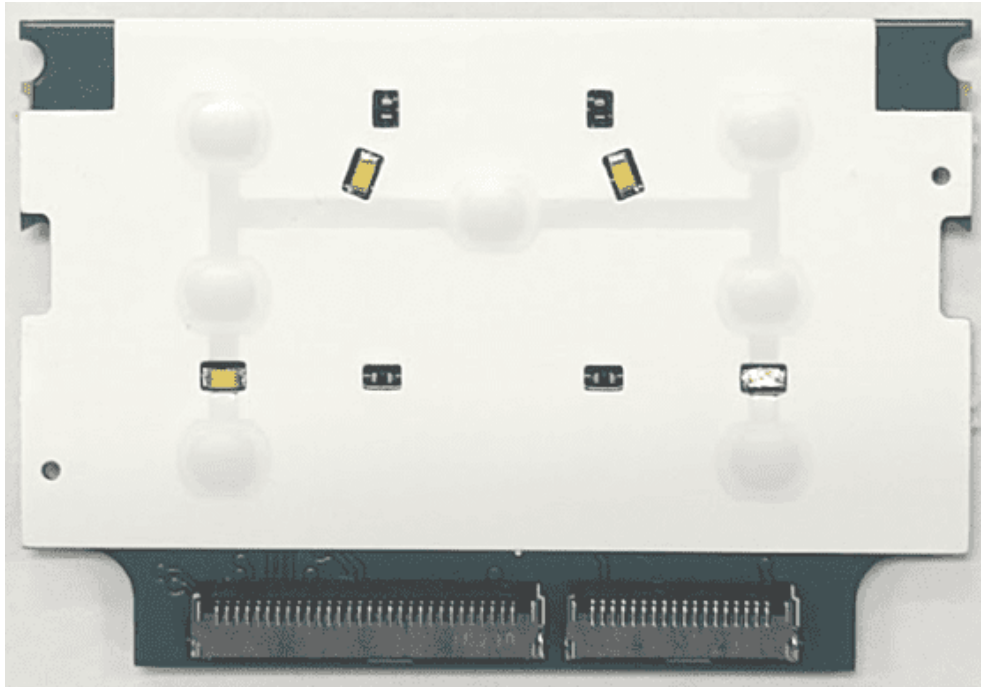
**Exhibit 9P**



**Chassis and housing (Back Side) NKP TIA4950**

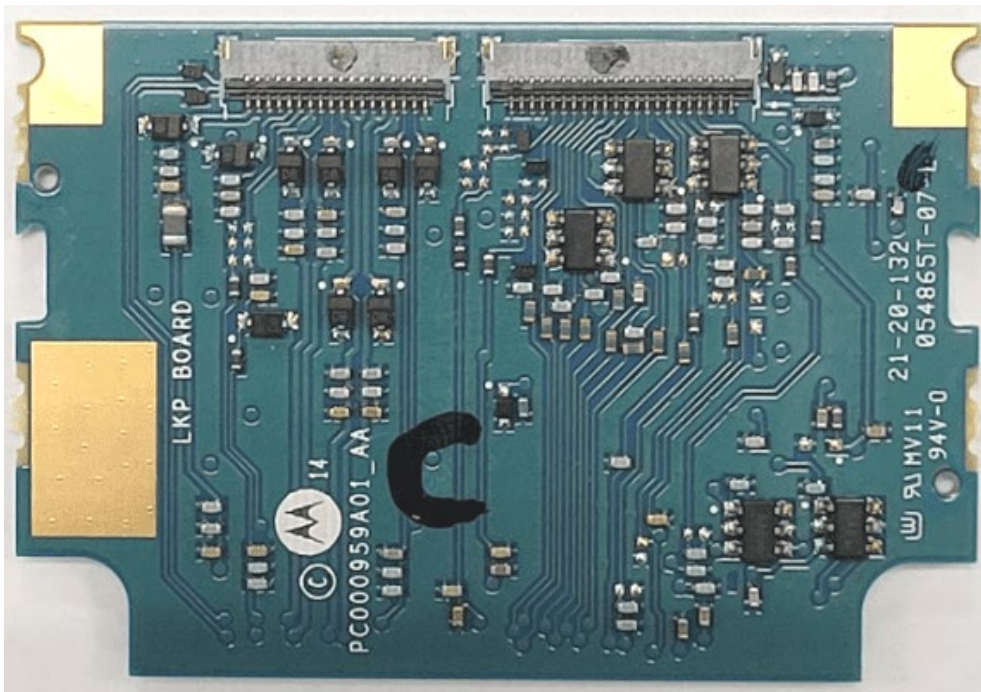


**Exhibit 9Q**



**Limited Keypad Board (Top)**

**Exhibit 9R**



**Limited Keypad Board (Bottom)**

**\*\*\* END \*\*\***