

<p>MOTOROLA PENANG ADV. COMM. LABORATORY Motorola Solutions Malaysia Sdn Bhd, Plot 2A Medan Bayan Lepas, Mukim 12 S.W.D, 11900 Bayan Lepas, Penang, Malaysia.</p>	<p>FCC Part 15 Subpart E, 15.407</p> <p>Report Revision : Rev.A Report ID : 29844-RF-00048 Service Request ID : 29844</p>
<p>Date/s Tested : 3-May-2023 Manufacturer/Location : Motorola Solutions Malaysia Sdn Bhd Manufacturer Address : Plot 2A Medan Bayan Lepas, Mukim 12 SWD, 11900 Bayan Lepas, Penang, Malaysia Requestor : TANG, GARY Product Type : Hand-held Tested Basic Function : Transmit / Receive External Model Name (PMN) : APX N50 Sales Model Number (HVIN) : H25KDF9PW6AN Frequency Band : 5180-5320MHz; 5500-5825MHz Max RF Output Power : 28.20mW Applicant Name : Motorola Solutions Inc Applicant Address : 8000 West Sunrise Boulevard, Fort Lauderdale, Florida 33322 FCC Registrations : 461337 ISED Registrations : MY0001 Firmware Version (FVIN) : D30.80.88</p> <p>The equipment was tested to the standard(s) listed below with the following result :</p> <p>- FCC Part 15 Subpart E 15.407 PASS ISED RSS-247, Issue 2</p>	
<p>This report shall not be reproduced without written approval from an officially designated representative of the Motorola Penang Adv. Comm. Laboratory. The results and statements contained in this report pertain only to the device(s) evaluated.</p>	
<p>Prepared By:</p>  <hr/> <p>Gan Boon Teong Technician</p>	<p>Approved Signatory:</p> <hr/> <p>Vincent Foong Chuen Kit Responsible Engineer</p>

TABLE OF CONTENTS

1. Introduction and Overview3

2. Test Laboratory Status3

3. Test Environmental Conditions.....3

3.1. Temperature and Humidity3

3.2. Tolerance.....3

3.3. Measurement Uncertainty3

4. Test Results Summary3

5. Technical Data of Device Under Test.....4

5.1. Operating Frequency Bands and Mode of EUT.....4

5.2. List of antennas and their corresponding gains4

5.3. Modifications and deviation from standard4

5.4. EUT Maximum Output Power4

5.5. Channel loading messages or sequences.....4

5.6. Transmit Power Control (TPC)5

5.7. Time required for master or client device to complete power cycle5

5.8. System Architecture.....5

5.9. Master device identification.....5

6. Test setup and list of equipment6

6.1. Setup block diagram6

6.2. List of Equipment.....7

6.3. Test Setup Photos7

7. Test Requirements.....8

7.1. DFS Requirements / Limits.....8

7.2. DFS Detection Threshold8

8. Test Procedure and Test Data.....9

8.1. Test Method9

8.2. Test Data9

REVISION HISTORY

Revision History	Description	Date	Originator
Rev. A	Initial report	8-July-2023	Gan Boon Teong

1. Introduction and Overview

This report details the utilization, technical data of device under test, test equipment, and test results of the measurements performed at the Motorola Penang Advanced Communication Laboratory in accordance to the standards specified on page 1.

This test report is only valid in its original form.

The test results herein refer only to the tested sample. Motorola Penang Advanced Communication Laboratory is not responsible for any generalizations or conclusions drawn from these test results and concerning further samples.

2. Test Laboratory Status

Motorola Penang Advanced Communication Laboratory is an ISO/IEC17025:2005 accredited laboratory. The laboratory was accredited by SAMM, with SAMM Cert No #0825

3. Test Environmental Conditions

3.1. Temperature and Humidity

Ambient Temperature	Rel. Air Humidity
15 °C to 35 °C	20 %RH to 75%RH

3.2. Tolerance

Chamber Temperature Tolerance	Chamber Humidity Tolerance
± 0.3 °c	± 3 %

3.3. Measurement Uncertainty

The measurement uncertainty represents an expanded uncertainty expressed at approximately the 95% confidence level using a coverage factor of k=1.96

4. Test Results Summary

The table below summarizes the test results for the test completed. For detailed test data, refer to section 7.

Section	Test Parameters	Results	Serial number
7.1.1	FCC Part 15.407 / RSS-247 Non Occupancy Period	PASS	287TZH0057
7.1.2	FCC Part 15.407 / RSS-247 Channel Move Time	PASS	287TZH0057
7.1.3	FCC Part 15.407 / RSS-247 Channel Closing Transmission Time	PASS	287TZH0057

NOTE:

NA → Not Applicable

5. Technical Data of Device Under Test

5.1. Operating Frequency Bands and Mode of EUT

Operational Mode	Operating Frequency Range	
	5250-5350MHz	5470-5725MHz
Client without radar detection and ad hoc function	Yes	Yes

5.2. List of antennas and their corresponding gains

Antenna #	Type	Frequency Range	Max Gain (dBi)
1	WiFi Antenna	4900-5900MHz	4.88

5.3. Modifications and deviation from standard

There is no deviation between the test carried out compared to the standard test method

5.4. EUT Maximum Output Power

802.11a

Antenna #	Frequency Range	Output Power (dBm)	Max EIRP including duty cycle correction
1	5250-5350MHz	13.457	18.337
1	5470-5725MHz	13.332	18.212

802.11n (20MHz)

Antenna #	Frequency Range	Output Power (dBm)	Max EIRP including duty cycle correction
1	5250-5350MHz	12.168	17.048
1	5470-5725MHz	12.074	16.954

5.5. Channel loading messages or sequences

Channel loading was achieved by using iPerf software to control throughput.

5.6. Transmit Power Control (TPC)

U-NII devices operating in the 5.25-5.35GHz band and the 5.47-5.725GHz band shall employ a TPC mechanism. The U-NII device is required to have the capability to operate at least 6dB below the EIRP value of 30dBm. A TPC mechanism is not required for systems with an EIRP of less than 500mW.

Maximum EIRP for this device is 17.457 dBm which is 55.68 mW, therefore TPC is not required.

5.7. Time required for master or client device to complete power cycle

The master device took 1 minute and 15 seconds to complete its power cycle. The client device does not have radar detection and therefore its power on time is not applicable.

5.8. System Architecture

The EUT utilizes IP based system architecture

5.9. Master device identification

The DFS compliant master device used for testing was a Linksys WRT3200ACM with serial number 19810625700081, and FCC ID Q87-WRT3200ACM and IC ID 3839A-WRT3200ACM

6. Test setup and list of equipment

6.1. Setup block diagram

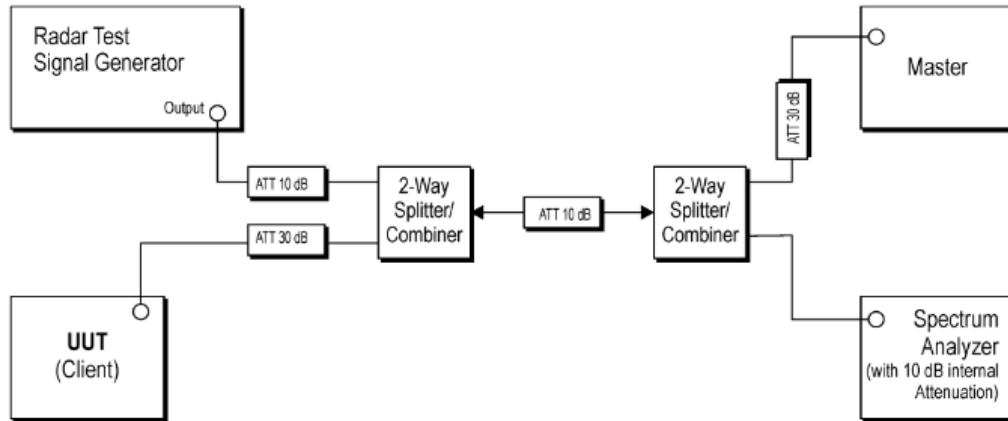

6.2. List of Equipment

Description	Model #	Serial Number	Calibration Date	Calibration Due Date
OPEN SWITCH & CONTROL UNIT	OSP120	101256	Not Required	Not Required
SIGNAL ANALYZER	FSV	101515	10-Aug-22	10-Aug-23
BASIC 8-CHANNEL SWITCH MODULE	OSP-B157W8	101073	11-Aug-21	11-Aug-23
VECTOR SIGNAL GENERATOR	SMBV100A	261962	21-Apr-21	21-Apr-24
WIDEBAND RADIO COMMUNICATION TESTER	CMW500	154549	11-Aug-22	11-Aug-23
SIGNAL GENERATOR	SMB100A	177677	4-Aug-21	4-Aug-24

6.3. Test Setup Photos

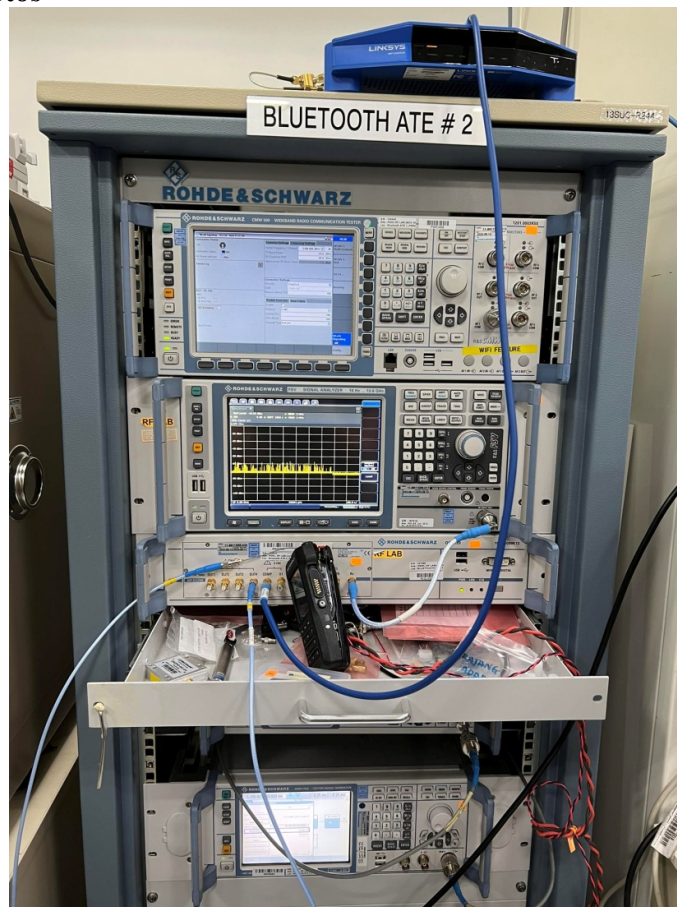

7. Test Requirements

7.1. DFS Requirements / Limits

Requirement	Limit
Channel Move Time	10 seconds
Channel Closing Transmission Time	200ms + an aggregate 60ms over following 10 seconds
Non-Occupancy Period	30 minutes

7.2. DFS Detection Threshold

The calibrated conducted DFS detection threshold level was set at -63 dBm. This level exceeds the specification for the stipulated detection level of -64dBm and ensures there is margin to the limit to ensure successful detection.

8. Test Procedure and Test Data

8.1. Test Method

DFS testing was performed using the conducted test methods defined in 905462 D02 UNII DFS Compliance Procedures New Rules v02. The device was a client only device without radar detection capability. The Rohde & Schwarz TS8997 test system in conjunction with WMS32 software was used for the automation of the testing.

8.2. Test Notes

DFS test data is inherited from FCC ID AZ492FT7124 as the subsection is identical to that of this filing.

8.3. Test Data

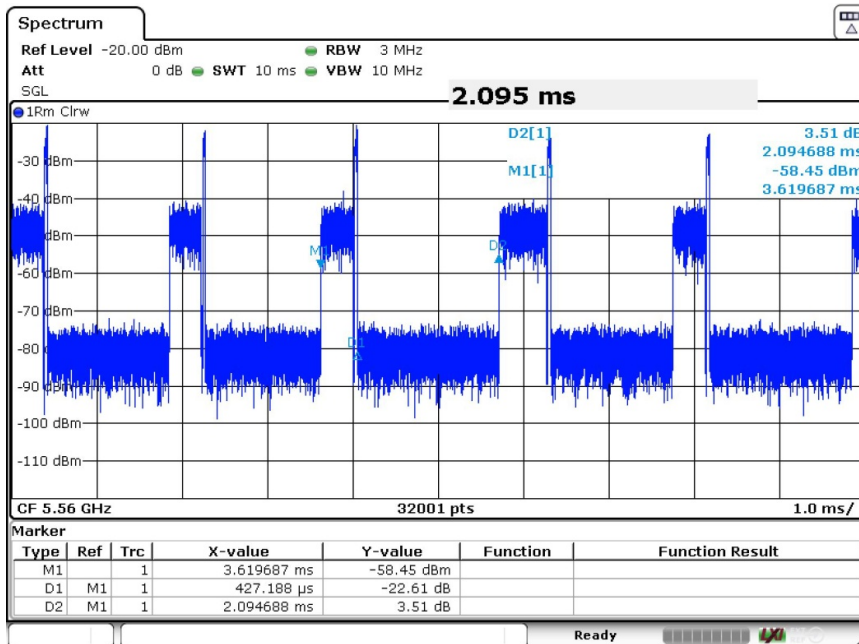

The resulting plot data was extracted and post processed, giving a duty cycle of 20.4%.

DFS Detection Threshold

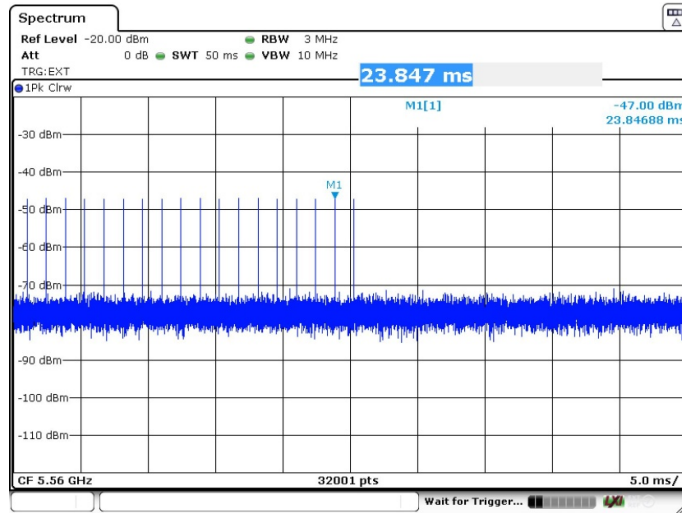

Peak of -47.00dBm, with losses at combiners factoring antenna gain to be 15.81dB, therefore level going into antenna port is -62.81dBm which exceeds threshold level of -64dBm for successful detection.

Channel Move and Closing Time

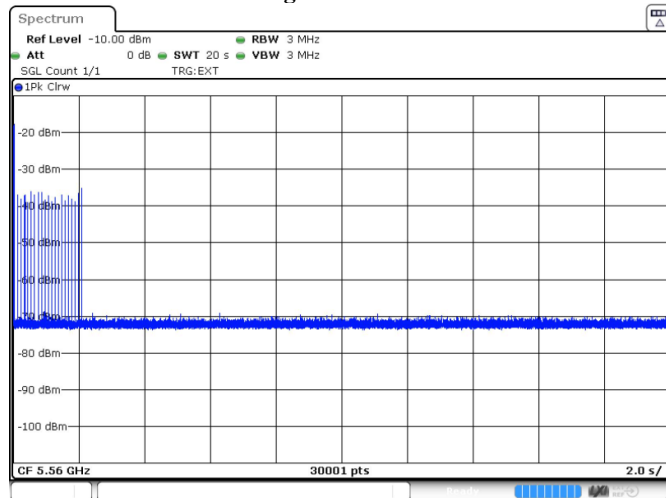

Channel Closing and Channel Move Time

Detailed Results

DUT Frequency (MHz)	Radar Type No.	Time duration	No of pulses found	Tx time (ms)	Tx Time Limit (ms)
5560	0	200ms	2	0.800	200
5560	0	remaining 9.8s period	20	8.056	60

Last transmission after injection of radar is 2.051 seconds, therefore meeting channel closing time 10s requirement.

Non-Occupancy Period

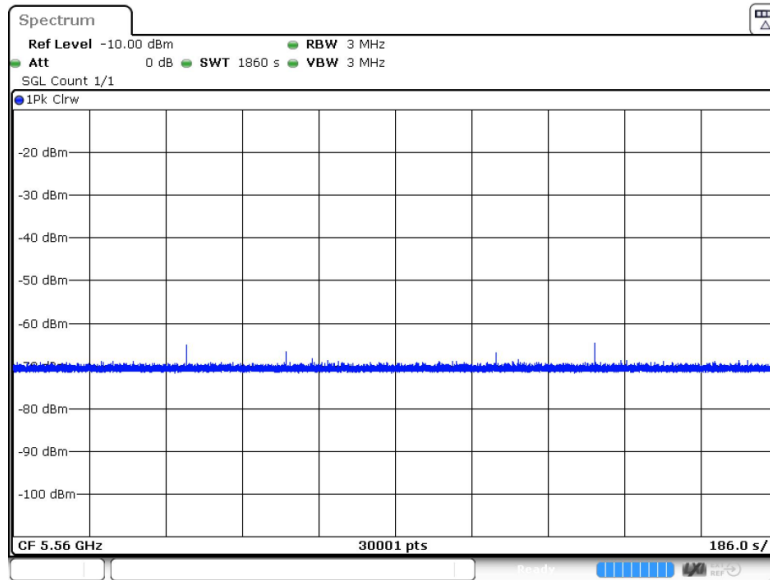

No pulses were detected in the 30 minutes that followed after channel move time, meeting non-occupancy 30 minute requirement.

END OF TEST REPORT