

Not for IC review

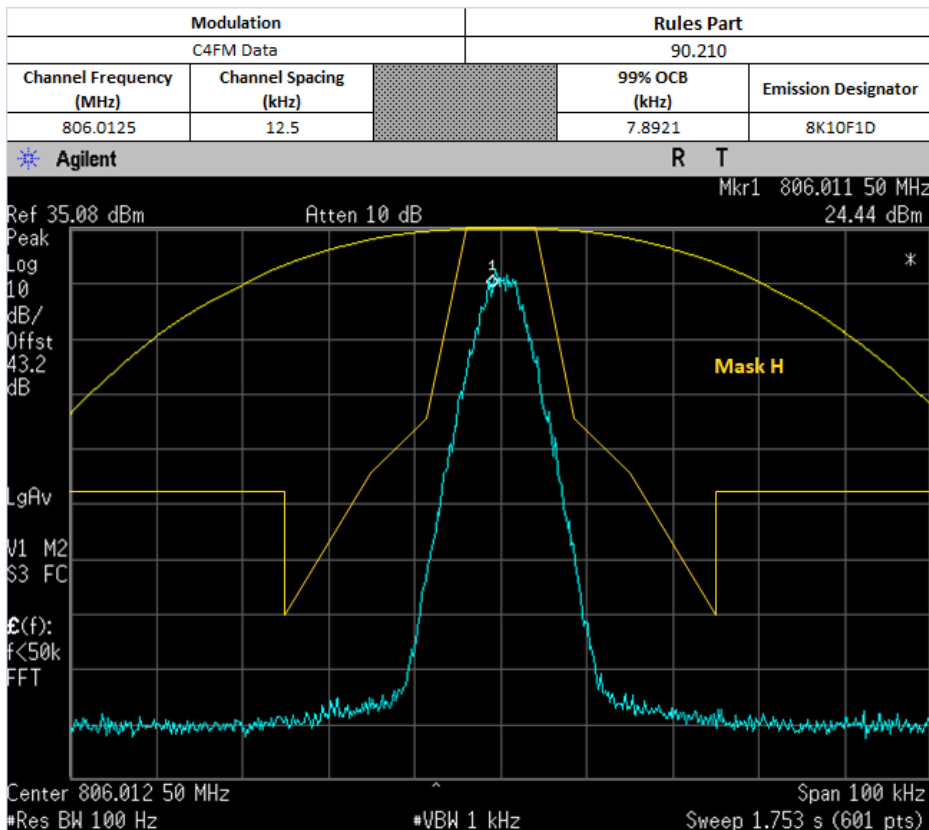

Not for IC review

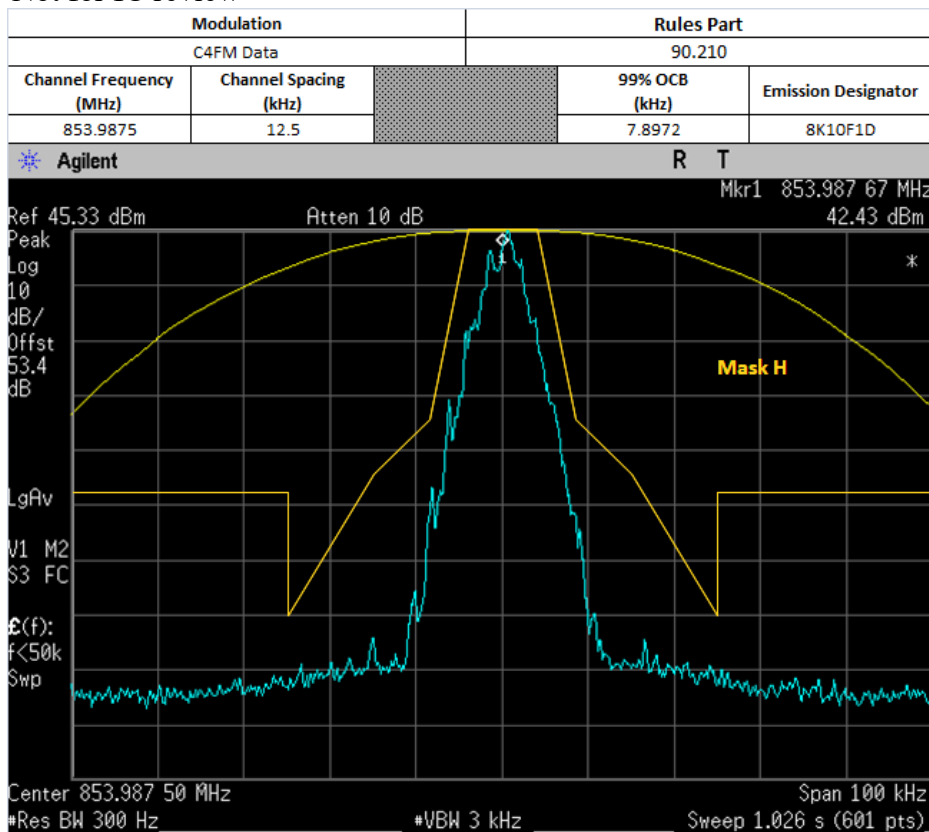

Not for IC review

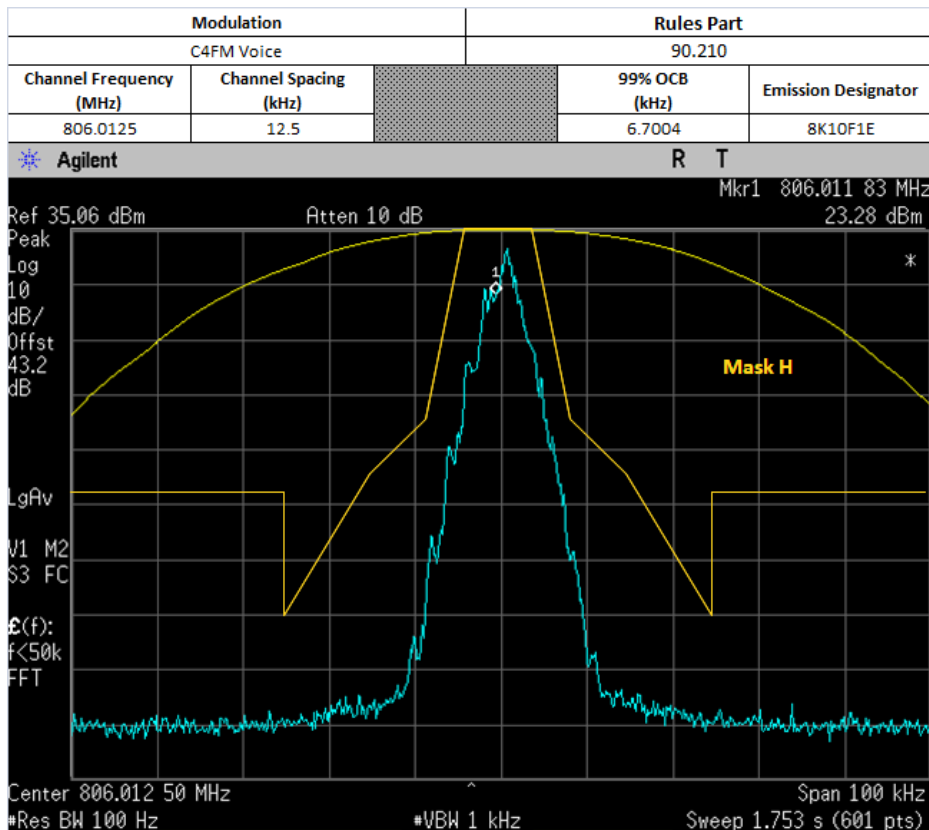

Not for IC review

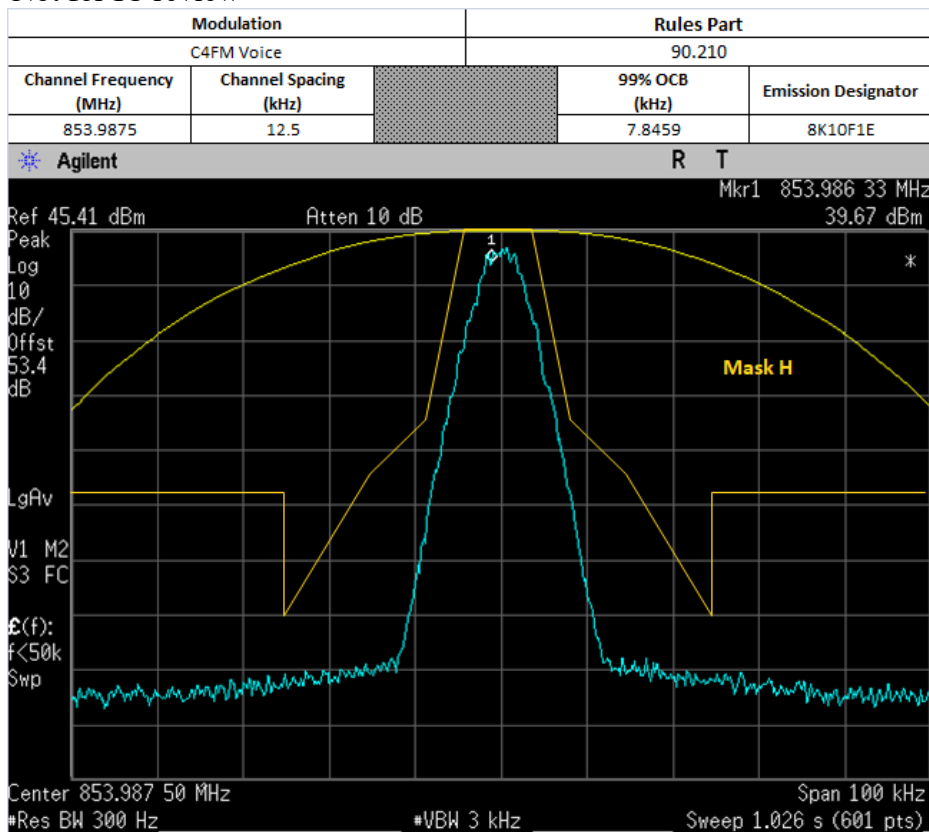

Not for IC review

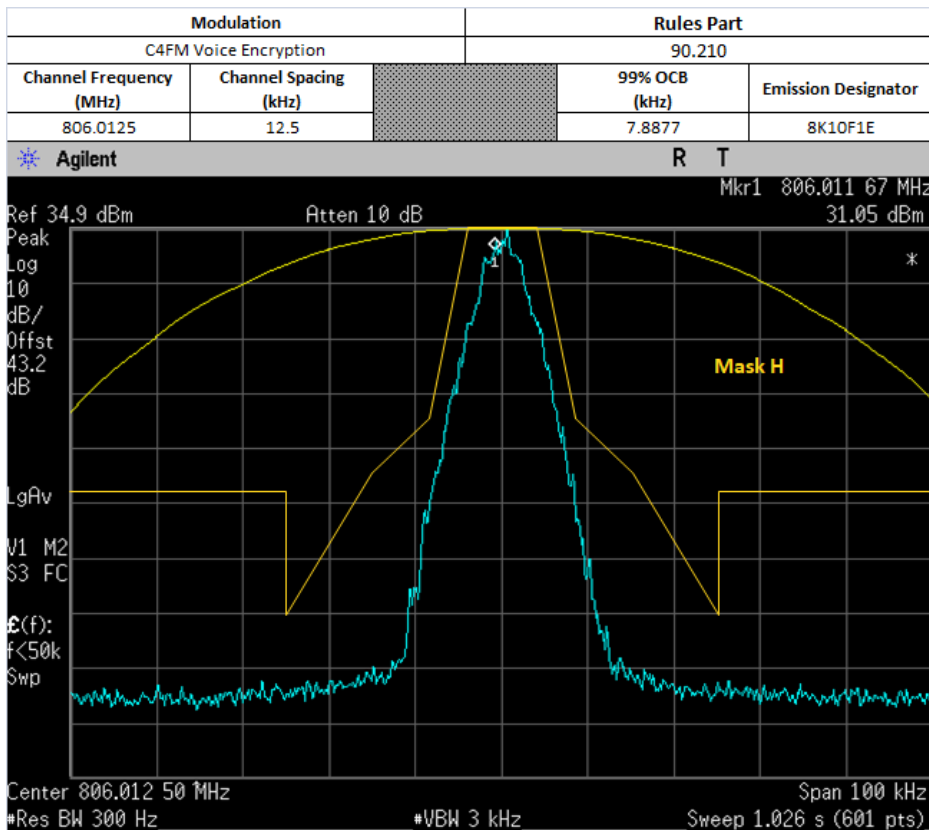

Not for IC review

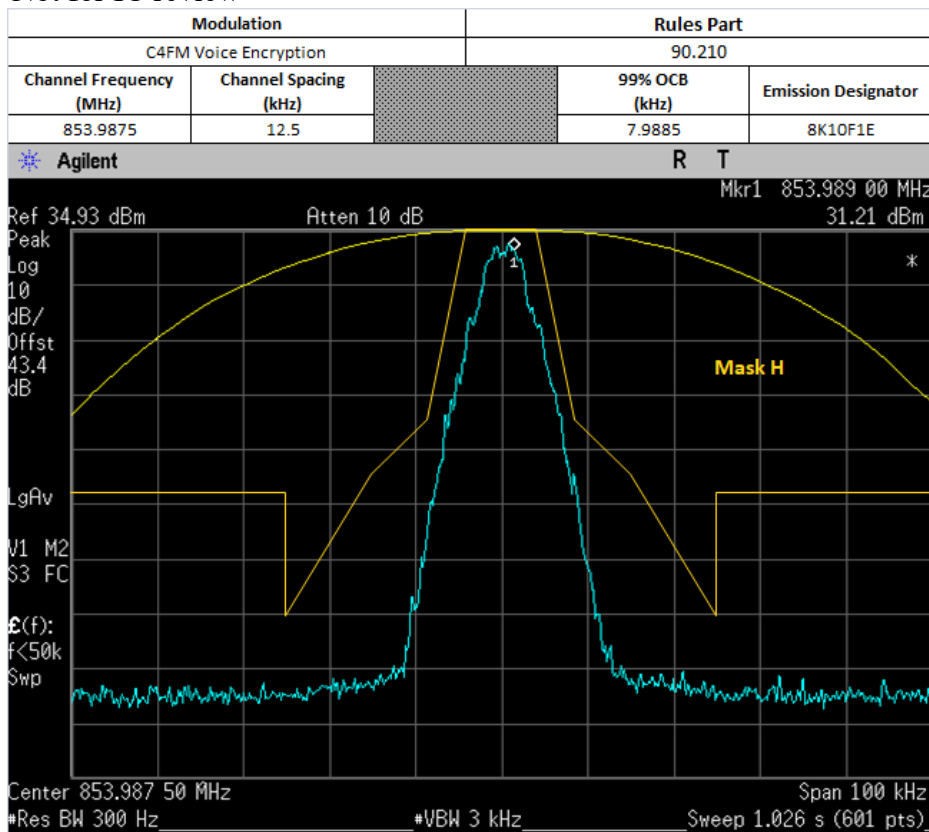

Not for IC review

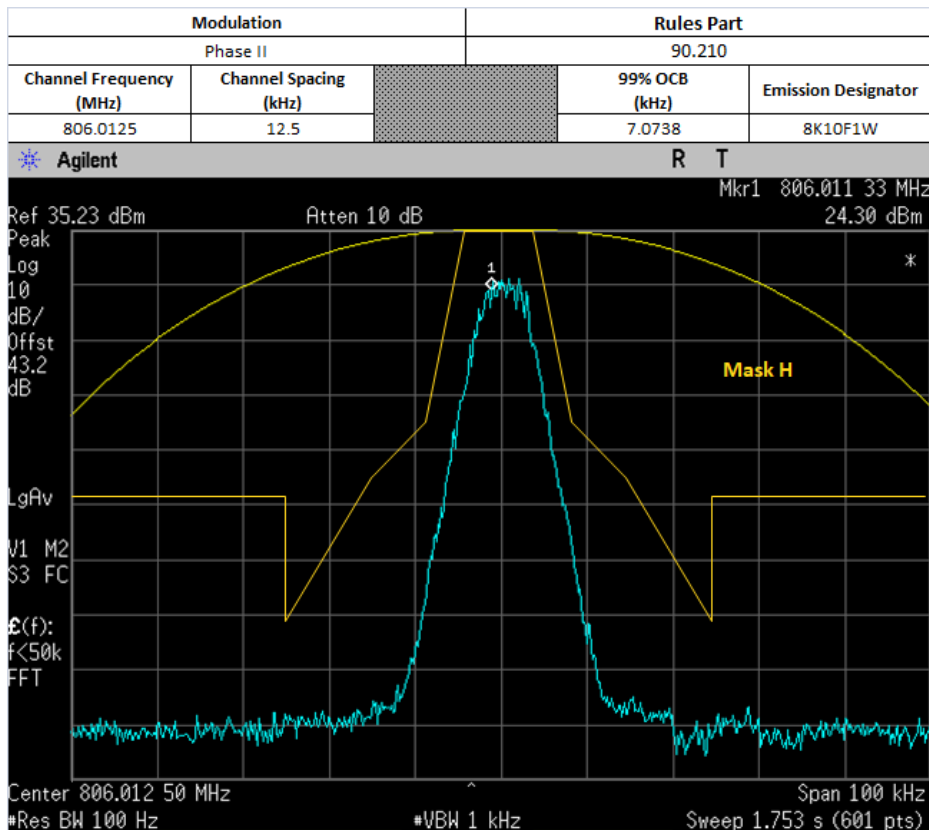

Not for IC review

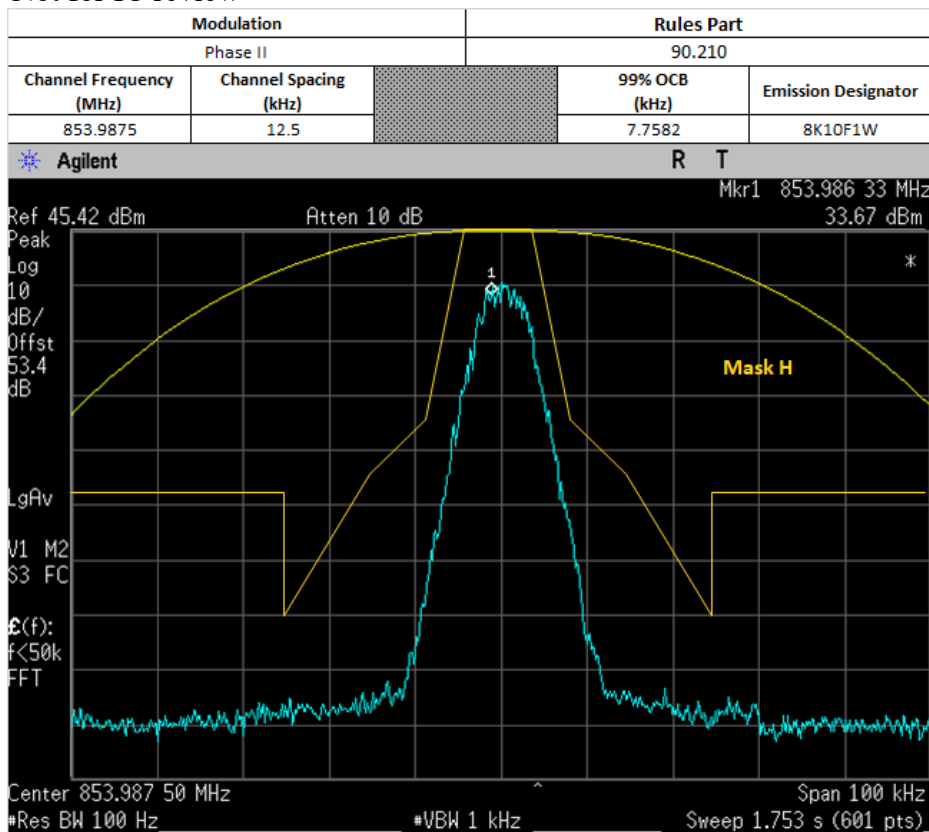

Not for IC review

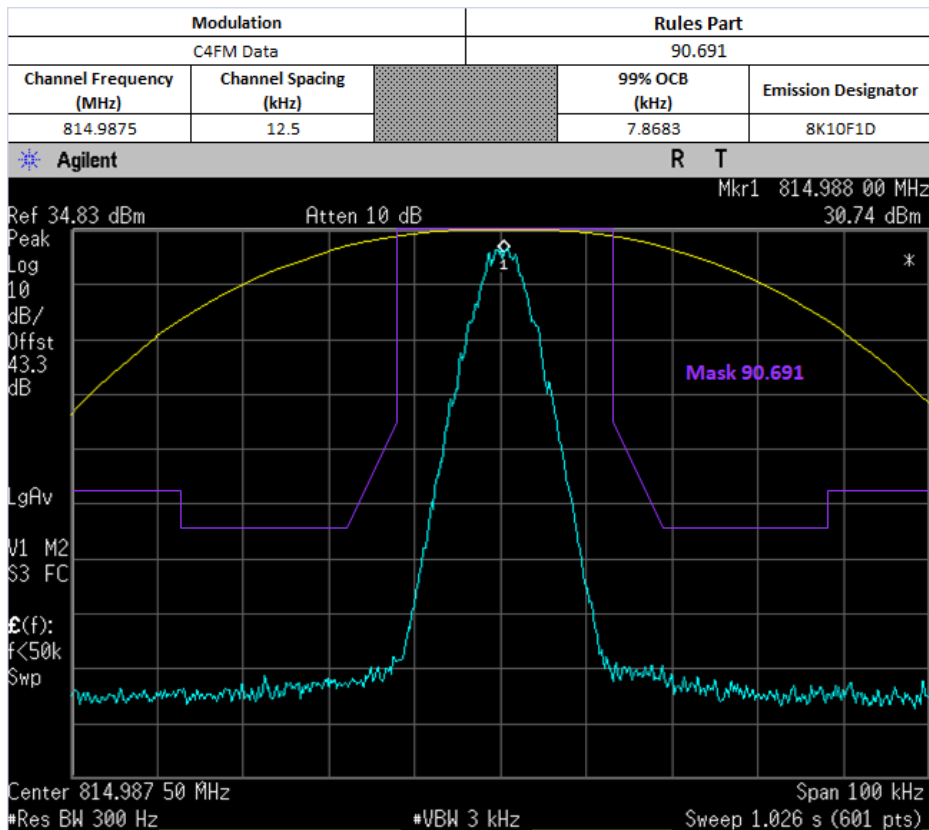

Not for IC review

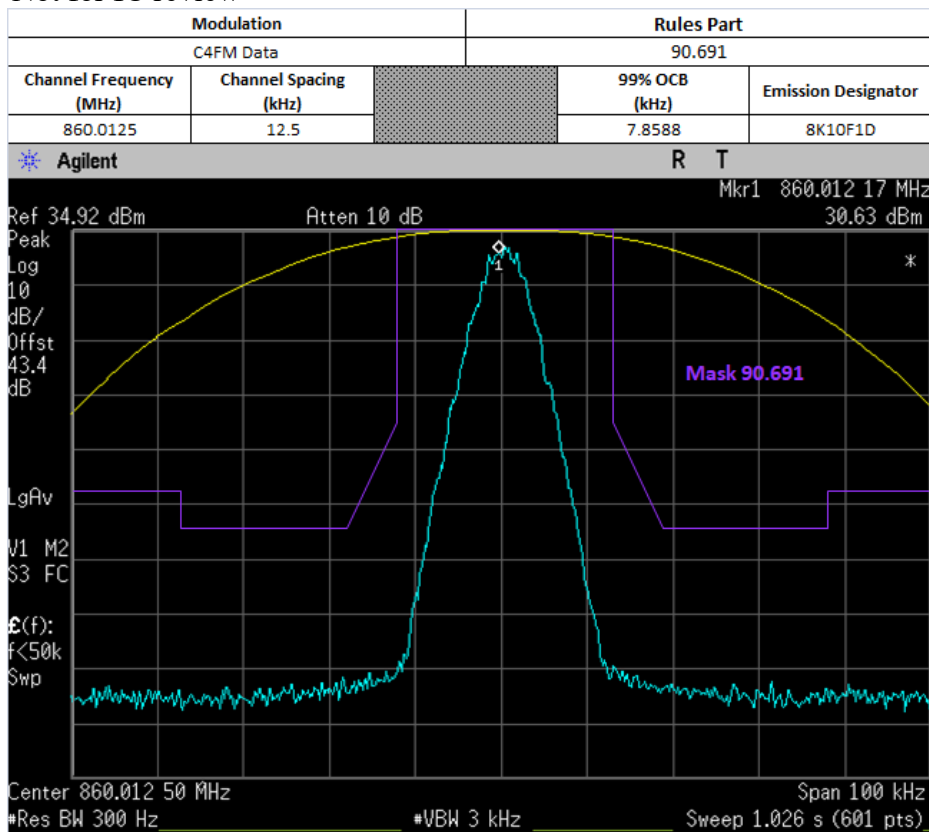

Not for IC review

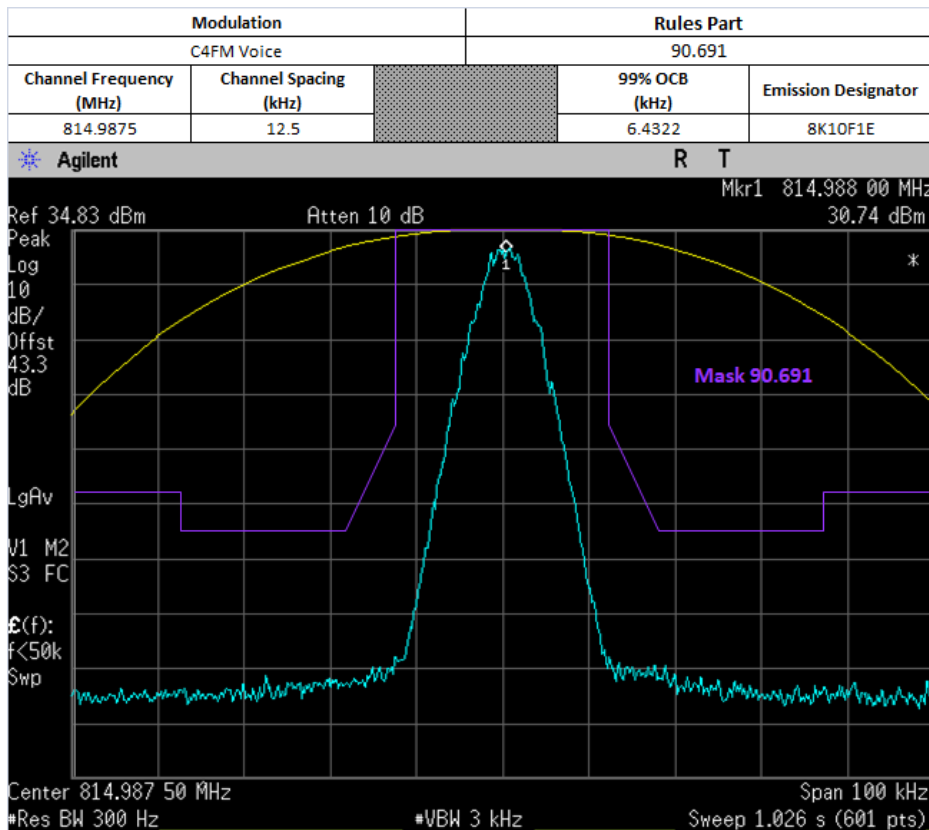

Not for IC review

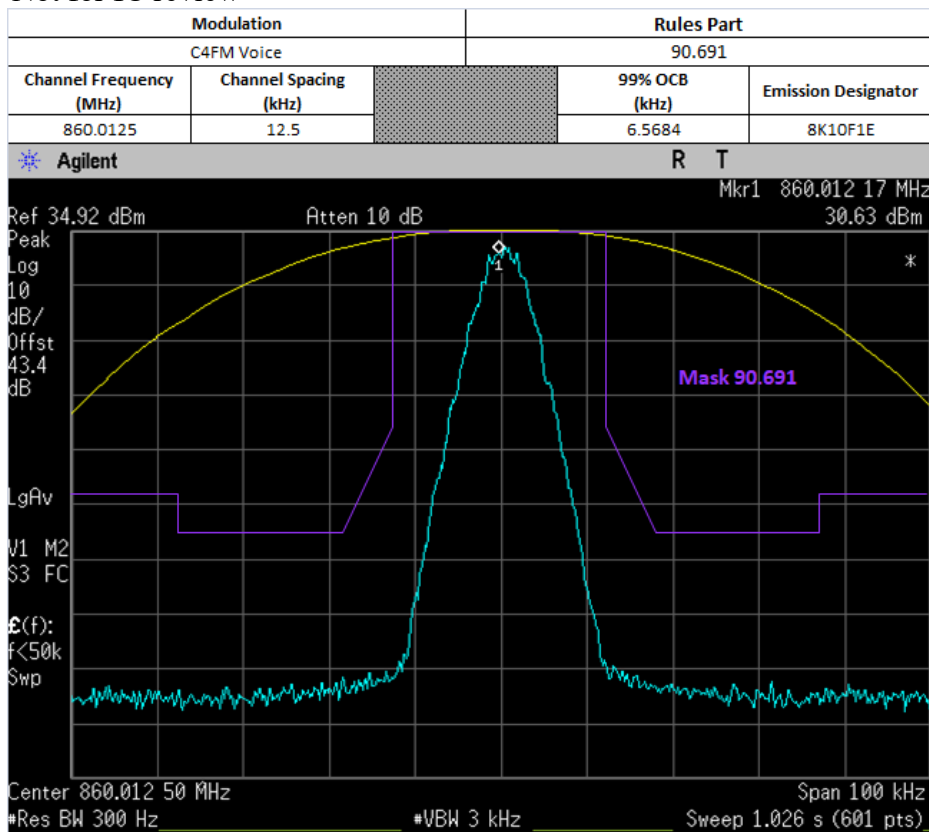

Not for IC review

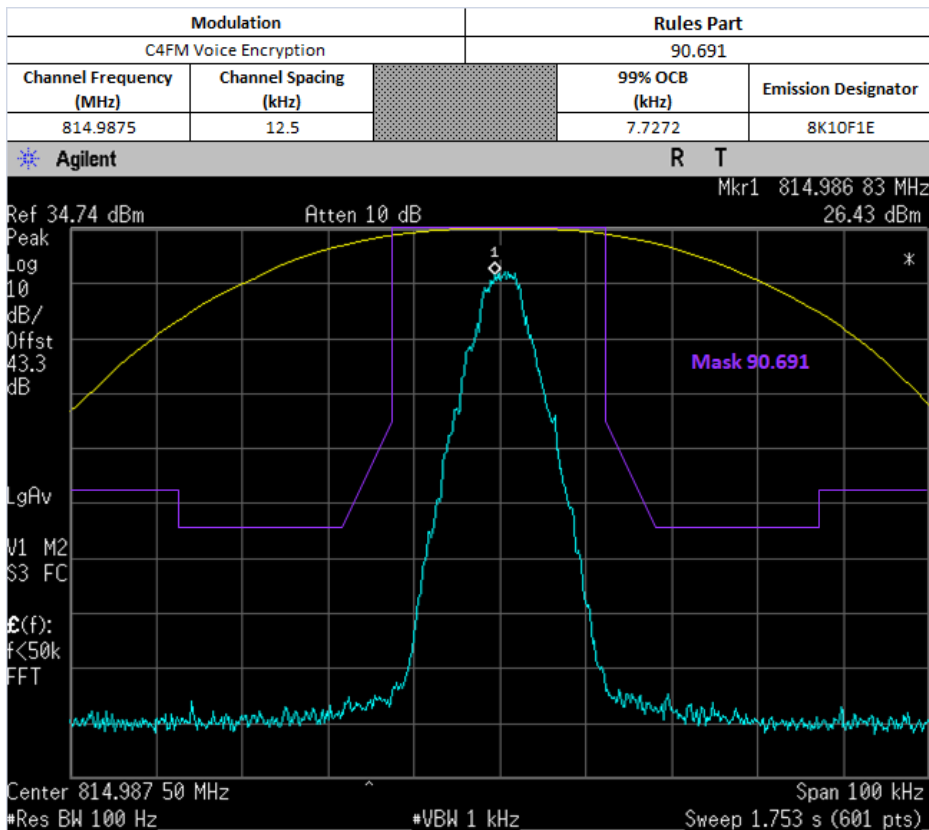

Not for IC review

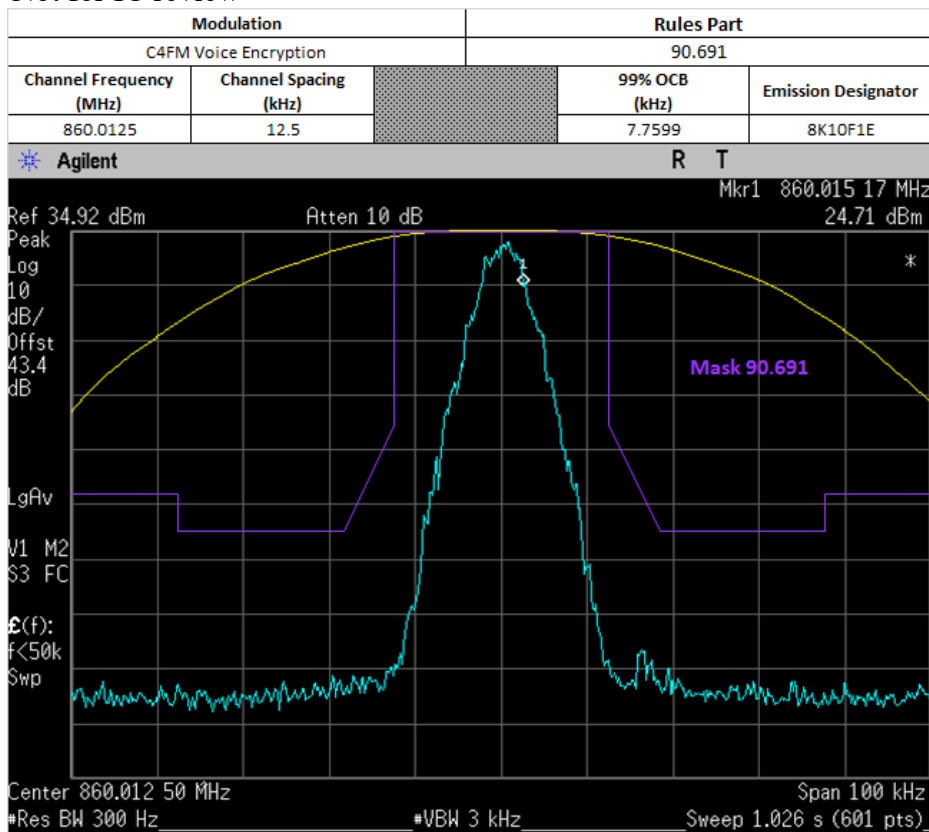

Not for IC review

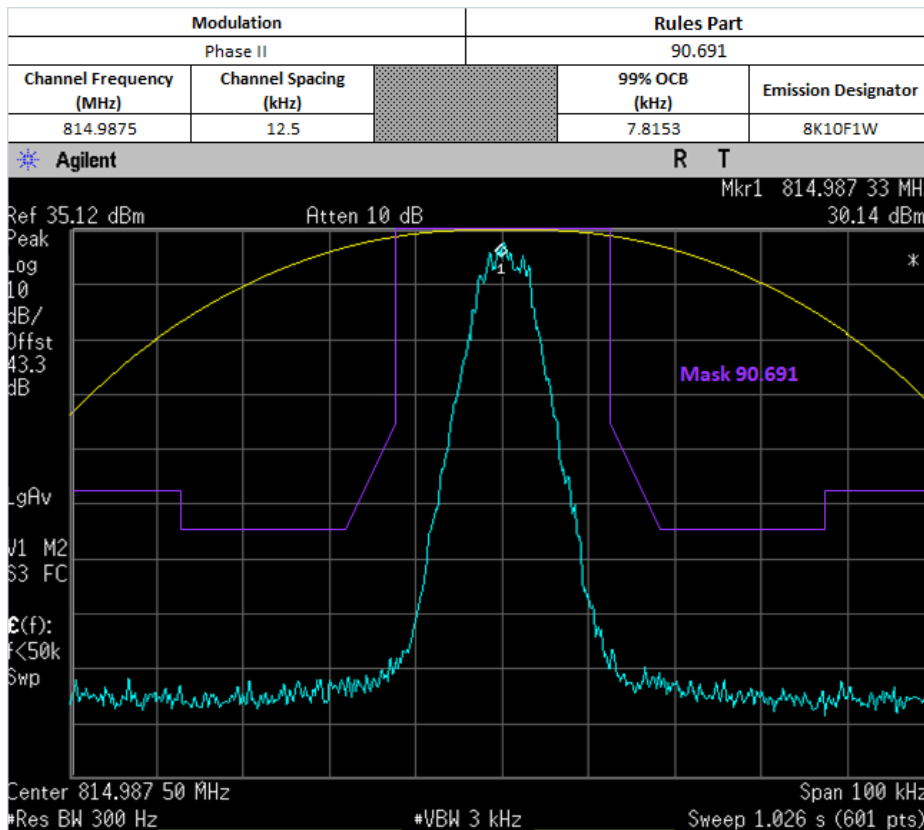

Not for IC review

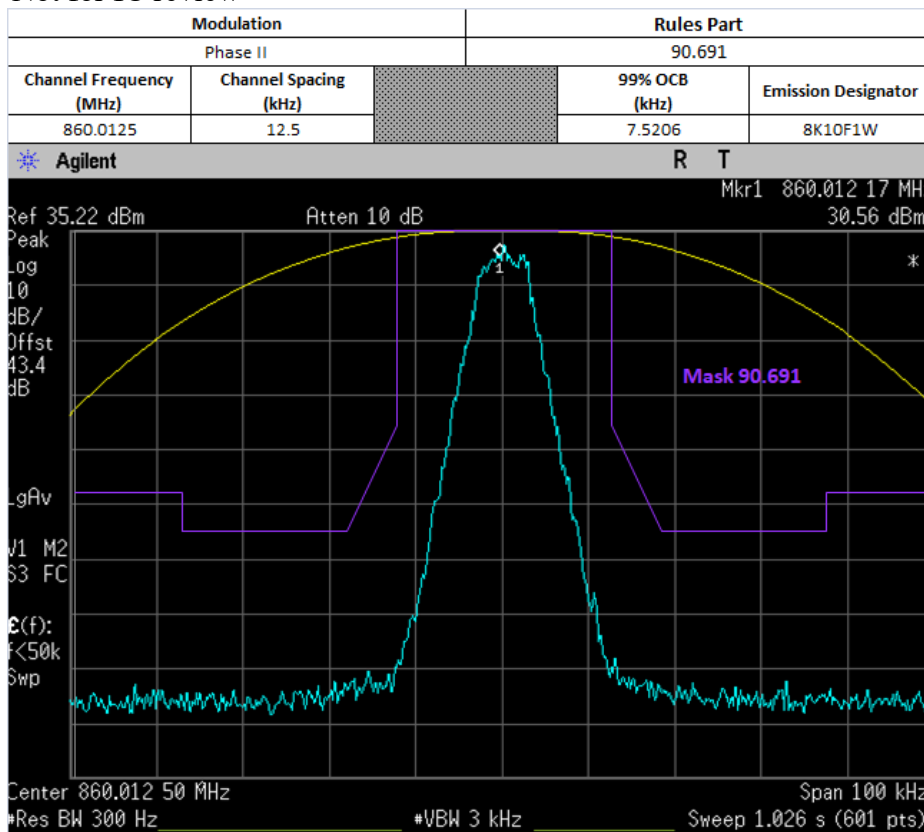

6.6.5. Test Limit

The 99% occupied bandwidth is the width of a frequency band such that, below the lower and above the upper frequency limits, the mean powers emitted are each equal to a specified percentage 0.5% of the total mean transmitted power.

6.7. Band Edge Conducted Spurious Emission (Part 22)

6.7.1. Test Setup (Analog)

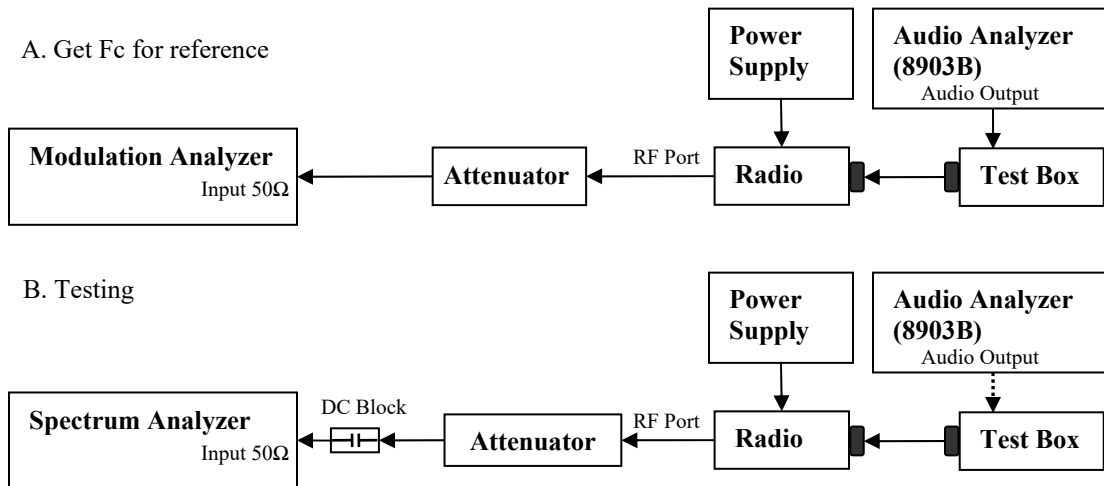

- 1) The DUT transmitter output port was connected to Modulation Analyzer.
- 2) Set the audio bandwidth filter to 15 kHz low pass filter and 50 kHz high pass filter.
- 3) Transmit the radio and set the audio analyzer to 2.5 kHz audio frequency and 50% of the rated deviation. Up the amplitude by 16 dB. Dekey the DUT.
- 4) Path loss for the measurement included.
- 5) Select the Occupied Bandwidth measurement for 99% and 26dB Emissions Bandwidth Measurement.
- 6) Key in the Fc and Resolution Bandwidth.
- 7) Transmit the DUT and record the occupied Bandwidth frequencies.
- 8) Preset the spectrum analyzer for band edge measurement.
- 9) The band edges of lowest and highest channels were measured.
- 10) Key in the Lowest and highest channel frequency, span is 60 kHz and Resolution Bandwidth is at least 1% of Emission Bandwidth.
- 11) Save the screen shot as modulated signal.
- 12) Remove the audio tone from audio analyzer to capture unmodulated signal.

*Note:

- For emission designator ending with F3E, 16K0F3E is the worst case and therefore only 16K0F3E will be shown.

6.7.2. Test Result (Analog)

Not Applicable

6.7.3. Test Setup (Digital)

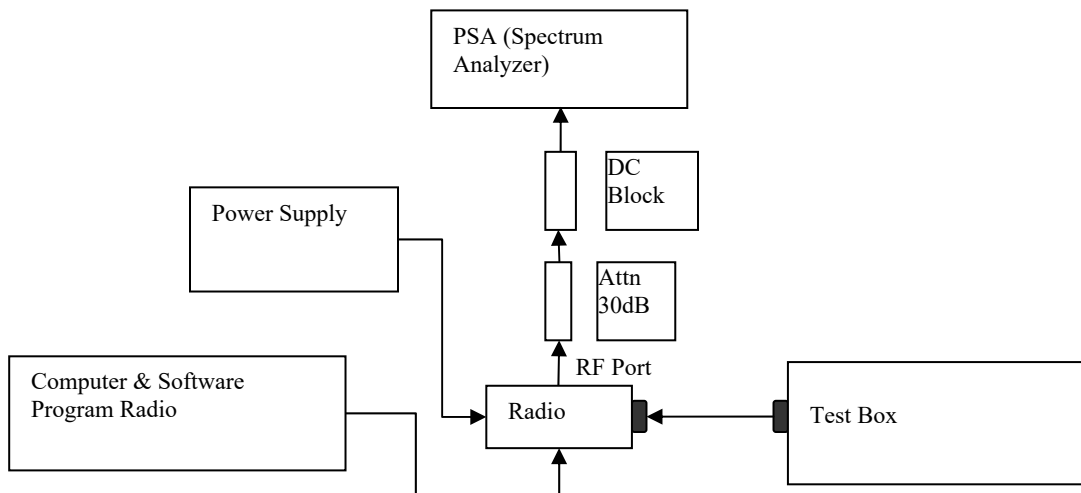

- 1) Program and set radio to operate in desire test frequency and digital mode with modulation. (*4FSK, C4FM or other digital modulation form).
- 2) Path loss for the measurement included.
- 3) Select the Occupied Bandwidth measurement for 99% and 26dB Emissions Bandwidth Measurement.
- 4) Key in the Fc and Resolution Bandwidth.
- 5) Transmit radio record the occupied Bandwidth frequencies.
- 6) Preset the spectrum analyzer for band edge measurement.
- 7) Key in the lowest and highest channels frequency, span is 60 kHz and Resolution Bandwidth is at least 1% of Emission Bandwidth.
- 8) Save the screen shot.

*Note:

- For Digital Modulation, 12.5 kHz Data F1D & FXD would be the same. Therefore only measurements with F1D modulation shown below.
- For Digital Modulation, 12.5 kHz Data F1E & FXE would be the same. Therefore only measurements with F1E modulation shown below.

6.7.4. Test Result (Digital)

Not Applicable

6.7.5. Test Limit

The power of any emission outside of the authorized operating frequency ranges must be attenuated below the transmitting power (P) by a factor of at least $43 + 10 \log(P)$ dB.

6.8. Transient Frequency Behavior

6.8.1. Test Setup

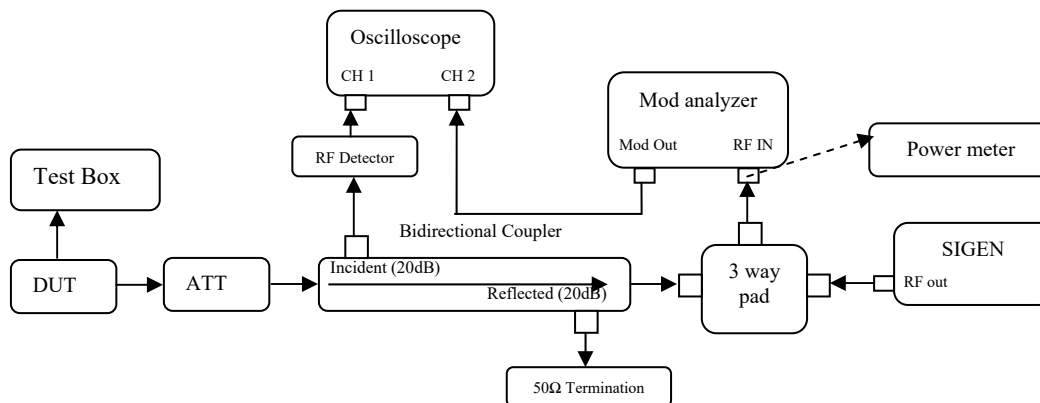

- 1) Connect the setup as figure above.
- 2) Path loss for the measurement included.
- 3) Set on Siggen with the assigned center frequency, internal 1 kHz FM tone.
FM Deviation: Analog 25kHz Channel Spacing = 25 kHz
Analog 12.5 kHz Channel Spacing = 12.5 kHz
C4FM = 12.5 kHz
- 4) Turn on 50 kHz high pass filter and 15 kHz low pass filter on modulation analyzer.
- 5) Supply sufficient attenuation ATT to provide the output power of ≤ -11 dBm into power meter when DUT is keying up.
- 6) Note the power level on power meter and dekey the DUT.
- 7) Adjust the amplitude of the signal generator to the level power meter, maintained the amplitude throughout the rest of the measurement.
- 8) Connect the output to modulation analyzer.
- 9) Reduce 30dB attenuation and transmit the radio to get the trigger line.
- 10) Capture the screen shot for key-up (rising edge) and de-key (falling edge) mode.

6.8.2. Test Result

Not Applicable

6.8.3. Test Limit

Transmitters designed to operate in the 150-174 MHz and 421-512 MHz frequency bands must maintain transient frequencies within the maximum frequency difference limits during the time intervals indicated:

Time intervals ^{1 2}	Maximum frequency difference ³	All equipment	
		150 to 174 MHz	421 to 512 MHz
Transient Frequency Behavior for Equipment Designed to Operate on 25 kHz Channels			
t ₁ ⁴	±25.0 kHz	5.0 ms	10.0 ms
t ₂	±12.5 kHz	20.0 ms	25.0 ms
t ₃ ⁴	±25.0 kHz	5.0 ms	10.0 ms
Transient Frequency Behavior for Equipment Designed to Operate on 12.5 kHz Channels			
t ₁ ⁴	±12.5 kHz	5.0 ms	10.0 ms
t ₂	±6.25 kHz	20.0 ms	25.0 ms
t ₃ ⁴	±12.5 kHz	5.0 ms	10.0 ms
Transient Frequency Behavior for Equipment Designed to Operate on 6.25 kHz Channels			
t ₁ ⁴	±6.25 kHz	5.0 ms	10.0 ms
t ₂	±3.125 kHz	20.0 ms	25.0 ms
t ₃ ⁴	±6.25 kHz	5.0 ms	10.0 ms

¹ t_{on} is the instant when a 1 kHz test signal is completely suppressed, including any capture time due to phasing.

t₁ is the time period immediately following t_{on}.

t₂ is the time period immediately following t₁.

t₃ is the time period from the instant when the transmitter is turned off until t_{off}.

t_{off} is the instant when the 1 kHz test signal starts to rise.

² During the time from the end of t₂ to the beginning of t₃, the frequency difference must not exceed the limits specified in §90.213.

³ Difference between the actual transmitter frequency and the assigned transmitter frequency.

⁴ If the transmitter carrier output power rating is 6 watts or less, the frequency difference during this time period may exceed the maximum frequency difference for this time period.

6.9. Adjacent Channel Power

6.9.1. Test Setup (Analog)

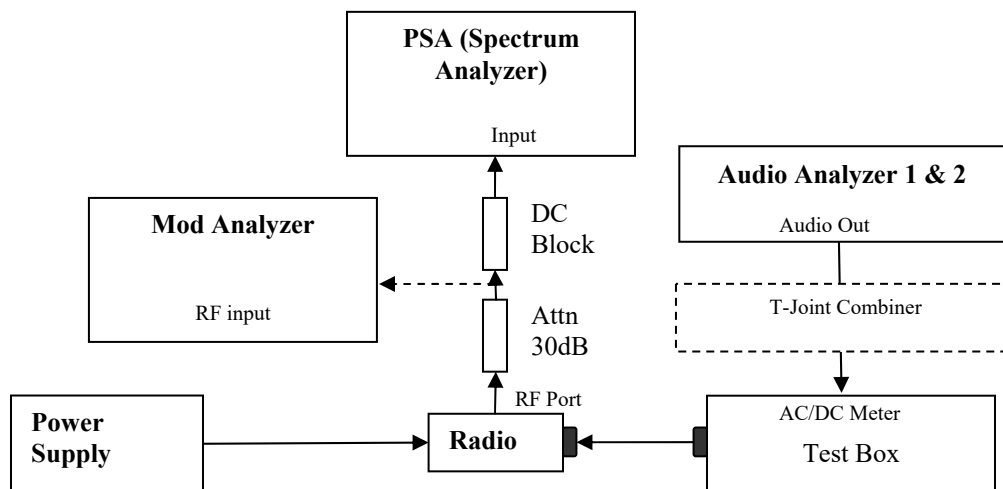

- 1) The DUT transmitter output port was connected to modulation analyzer.
- 2) Transmit the radio and turn on 1st audio analyzer with audio frequency 650Hz, 50% rated deviation, and record the amplitude value as AmpT1.
- 3) Turn off Audio analyzer 1 and turn on audio analyzer 2, set the audio frequency to 2.2 kHz and 50% deviation. Record the amplitude as AmpT2.
- 4) Turn both audio analyzers ON and up 10dB amplitude level.
- 5) Connect the output to PSA and set to assigned center frequency.
- 6) Set Span, Resolution Bandwidth and Video Bandwidth per rules part.
- 7) Transmit the radio and record the Adjacent Channel Power value in dBc.

6.9.2. Test Result

Not Applicable

6.9.3. Test Setup (Digital)

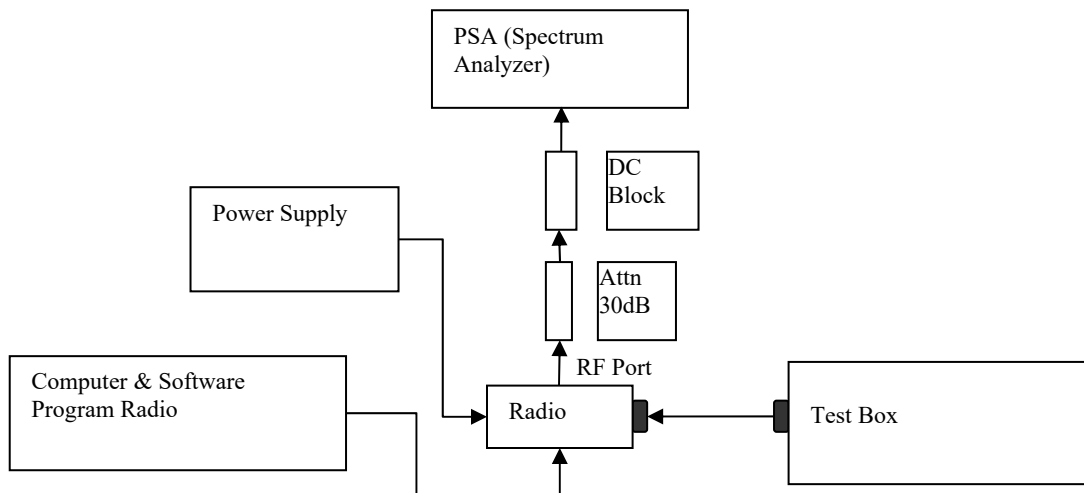

- 1) Program and set radio to operate in desire test frequency and digital mode with modulation. (4FSK, C4FM or other digital modulation form).
- 2) Prepare setup as per picture.
- 3) Turn on the ACP Measurement – Press Measure, ACP.
- 4) Set Span, Resolution Bandwidth and Video Bandwidth as per rules part.
- 5) Transmit the radio and record the Adjacent Channel Power value in dBc.

6.9.4. Test Result

Not Applicable

6.9.5. Test Limit

12.5 kHz MOBILE TRANSMITTER ACP REQUIREMENTS

Offset from center frequency (kHz)	Measurement bandwidth (kHz)	Maximum ACP relative (dBc)
9.375	6.25	-40
15.625	6.25	-60
21.875	6.25	-60
37.50	25.00	-60
62.50	25.00	-65
87.50	25.00	-65
150.00	100	-65
250.00	100	-65
350.00	100	-65
>400 to 12 MHz	30 (s)	-75
12 MHz to paired receive band	30 (s)	-75
In the paired receive band	30 (s)	-100

25 kHz MOBILE TRANSMITTER ACP REQUIREMENTS

Offset from center frequency (kHz)	Measurement bandwidth (kHz)	Maximum ACP relative (dBc)
15.625	6.25	-40
21.875	6.25	-60
37.50	25	-60
62.50	25	-65
87.50	25	-65
150.00	100	-65
250.00	100	-65
350.00	100	-65
>400 kHz to 12 MHz	30 (s)	-75
12 MHz to paired receive band	30 (s)	-75
In the paired receive band	30 (s)	-100

12.5 kHz BASE TRANSMITTER ACP REQUIREMENTS

Offset from center frequency (kHz)	Measurement bandwidth (kHz)	Maximum ACP (dBc)
9.375	6.25	-40
15.625	6.25	-60
21.875	6.25	-60
37.5	25	-60
62.5	25	-65
87.5	25	-65
150	100	-65
250	100	-65
350.00	100	-65
>400 kHz to 12 MHz	30 (s)	-80
12 MHz to paired receive band	30 (s)	-80
In the paired receive band	30 (s)	¹ -85

25 kHz BASE TRANSMITTER ACP REQUIREMENTS

Offset from center frequency (kHz)	Measurement bandwidth (kHz)	Maximum ACP (dBc)
15.625	6.25	-40
21.875	6.25	-60
37.5	25	-60
62.5	25	-65
87.5	25	-65
150	100	-65
250	100	-65
350	100.00	-65
>400 kHz to 12 MHz	30 (s)	-80
12 MHz to paired receive band	30 (s)	-80
In the paired receive band	30 (s)	¹ -85

6.10. Conducted Spurious Emission

6.10.1. Test Setup

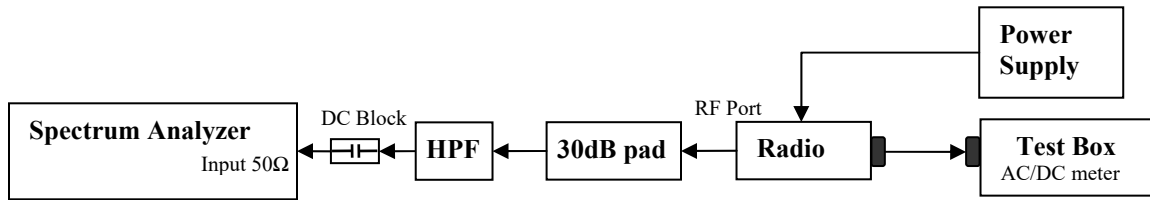

- 1) The DUT transmitter output port was connected to Spectrum Analyzer with above setup.
- 2) Program and set radio to operate in desire test frequency and mode. (Analog / digital modulation form).
- 3) Path loss for the measurement included.
- 4) Set the PSA Resolution Bandwidth as per rules part.
- 5) Set the Ref offset from the pathloss offset calibration file.
- 6) Adjust the center frequency of the spectrum analyzer for incremental coverage of the range from:
 - a. 9 KHz to $F_c - \text{Test Bandwidth}$
 - b. $F_c + \text{Test Bandwidth}$ to $2F_c - 5\text{MHz}$.
- 7) Key up the DUT, Peak Search the highest Spur and record the levels of spurious emissions
- 8) Dekey the DUT.
- 9) Turn On High Pass Filter path and Key up the DUT.
- 10) Adjust the PSA Freq for incremental coverage of range from $2F_c$ to $10F_c$
- 11) Key up the DUT and record the highest spur levels of spurious emissions.

6.10.2. Test Result (Analog)

Analog: 806.0125MHz, 25kHz Channel Spacing, Max. Power

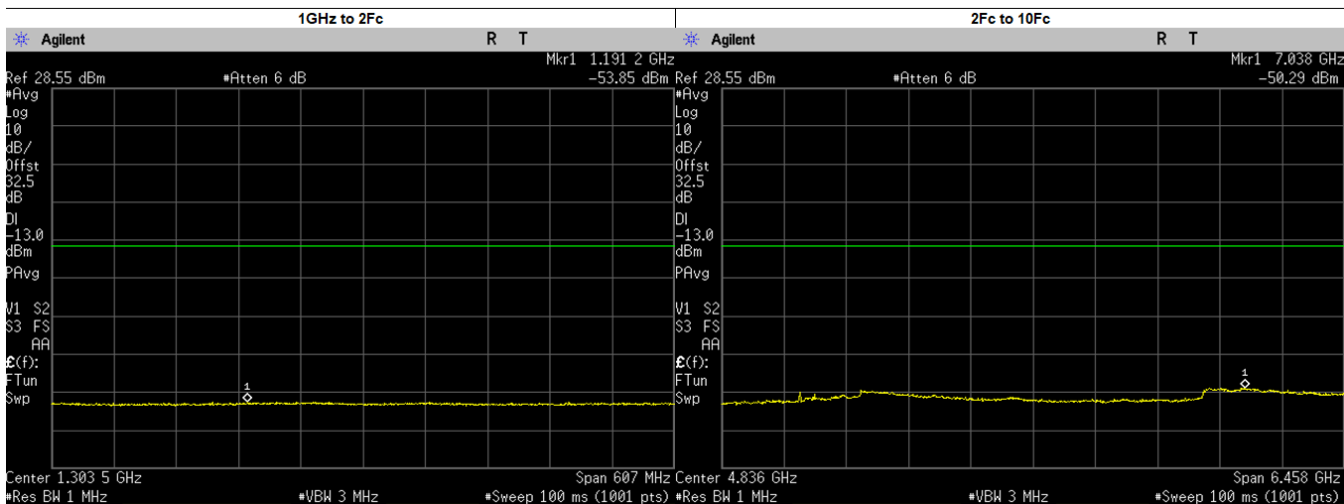
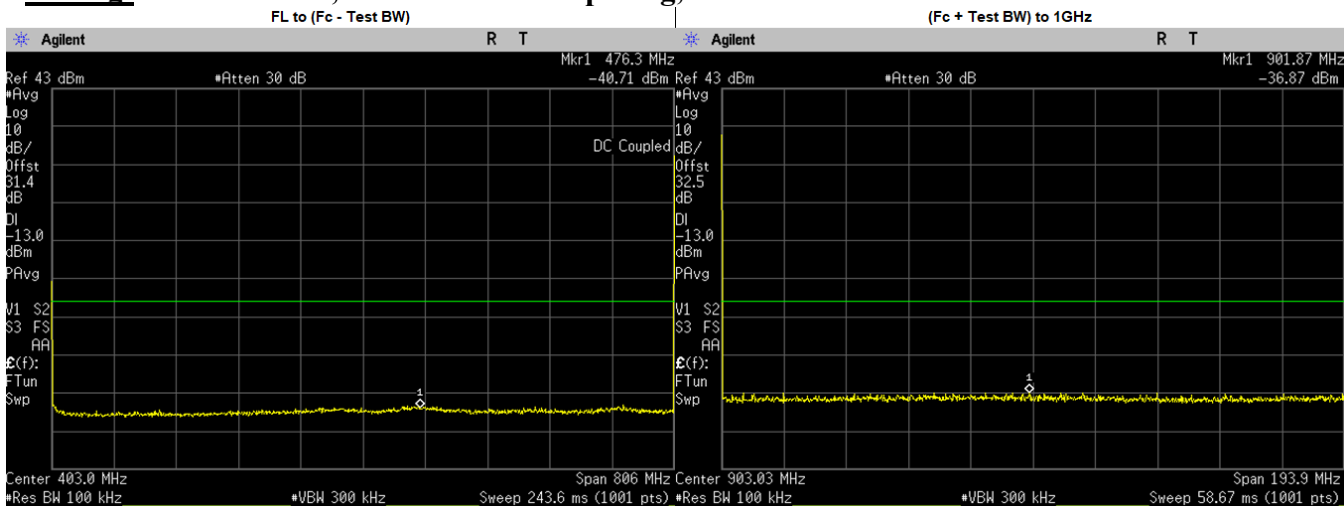

Frequency Range	Highest Spur Frequency (MHz)	Spurious Level (dBm)	Failing Limit (dBm)	Results
FL to (Fc - Test BW)	476.3000	-40.7100	-13.00	PASS
(Fc + Test BW) to 1GHz	901.8676	-36.8700	-13.00	PASS
1GHz to 2Fc	1191.2130	-53.8500	-13.00	PASS
2Fc to 10Fc	7038.2870	-50.2900	-13.00	PASS
	1612.0250	-54.5716	-13.00	PASS
	2418.0370	-52.0312	-13.00	PASS
	3224.0500	-51.3941	-13.00	PASS
	4030.0620	-53.0642	-13.00	PASS
	4836.0750	-53.5420	-13.00	PASS
	5642.0870	-53.7409	-13.00	PASS
	6448.1000	-53.3602	-13.00	PASS
	7254.1130	-51.2382	-13.00	PASS
8060.1250	-51.7537	-13.00	PASS	

Analog: 814.9875MHz, 25kHz Channel Spacing, Max. Power

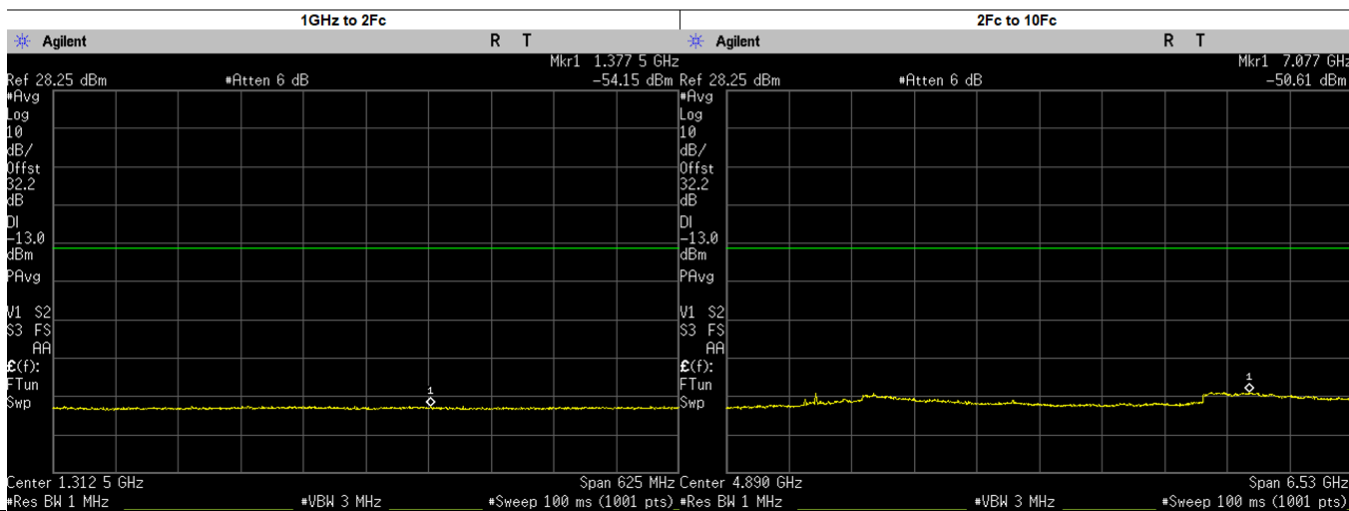
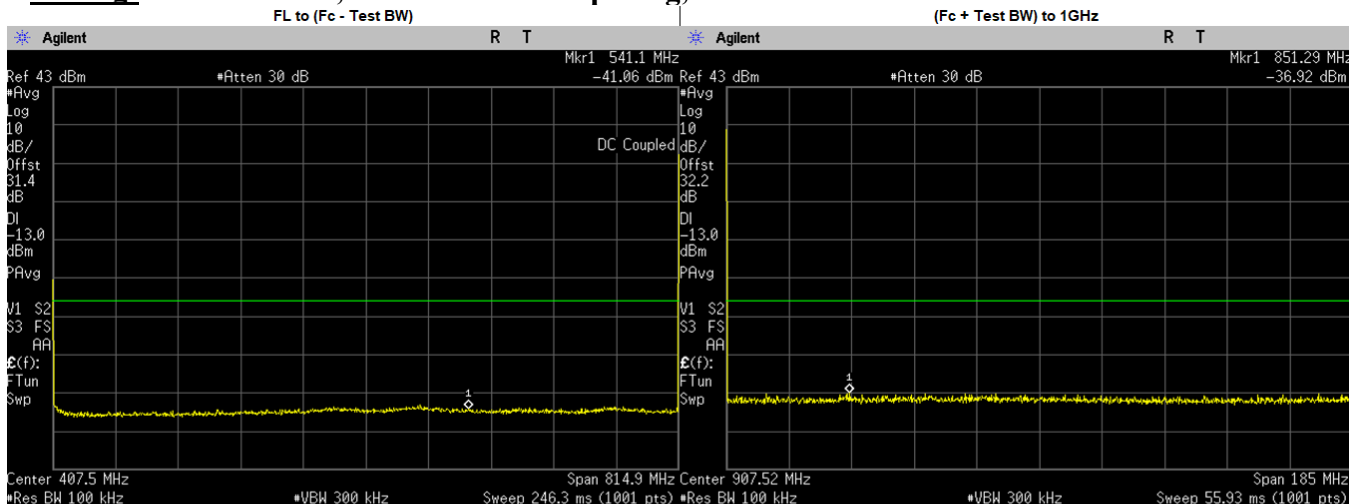

Frequency Range	Highest Spur Frequency (MHz)	Spurious Level (dBm)	Failing Limit (dBm)	Results
FL to (Fc - Test BW)	541.1000	-41.0600	-13.00	PASS
(Fc + Test BW) to 1GHz	851.2902	-36.9200	-13.00	PASS
1GHz to 2Fc	1377.4850	-54.1500	-13.00	PASS
2Fc to 10Fc	7077.4410	-50.6100	-13.00	PASS
	1629.9750	-54.6876	-13.00	PASS
	2444.9630	-52.9770	-13.00	PASS
	3259.9500	-51.9498	-13.00	PASS
	4074.9370	-53.2289	-13.00	PASS
	4889.9250	-54.0260	-13.00	PASS
	5704.9130	-54.0613	-13.00	PASS
	6519.9000	-53.5812	-13.00	PASS
	7334.8870	-51.4138	-13.00	PASS
8149.8750	-52.4021	-13.00	PASS	

Analog: 823.9875MHz, 25kHz Channel Spacing, Max. Power

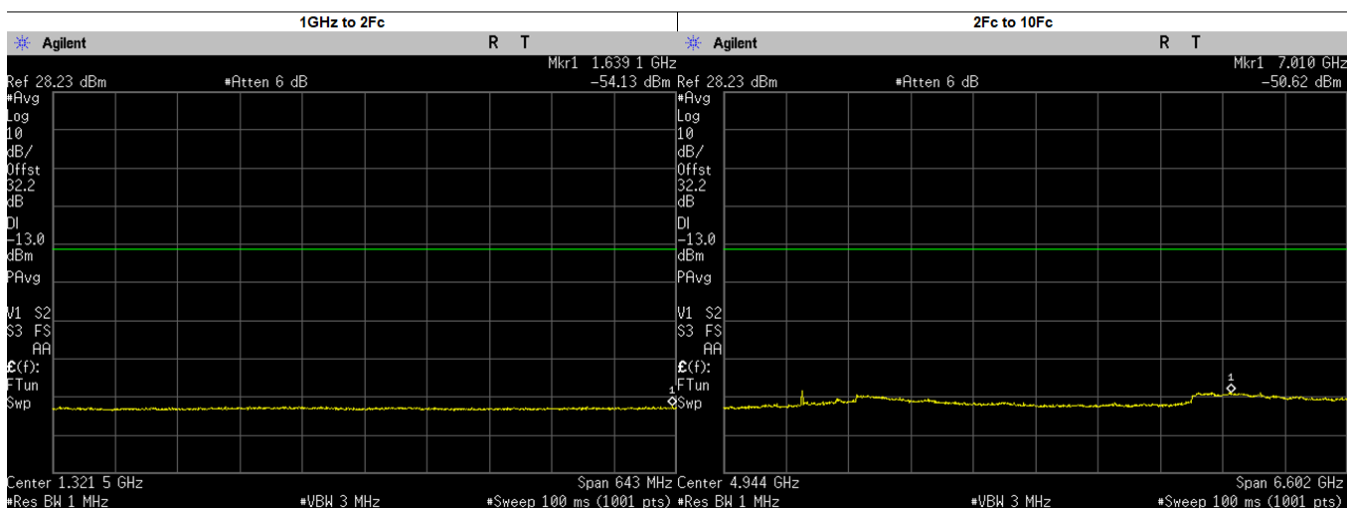
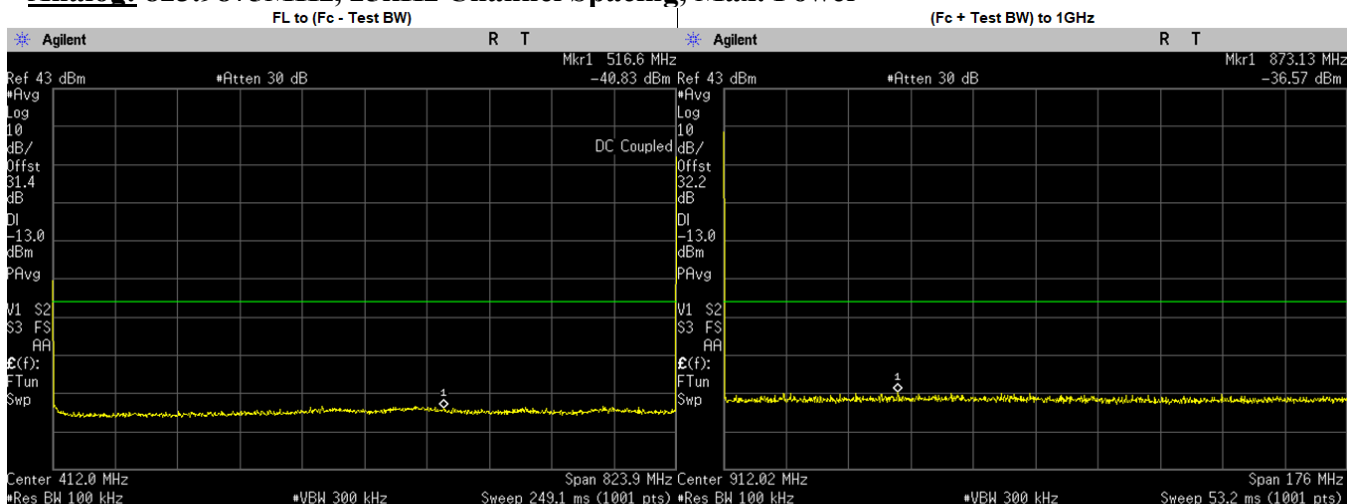

Frequency Range	Highest Spur Frequency (MHz)	Spurious Level (dBm)	Failing Limit (dBm)	Results
FL to (Fc - Test BW)	516.6000	-40.8300	-13.00	PASS
(Fc + Test BW) to 1GHz	873.1310	-36.5700	-13.00	PASS
1GHz to 2Fc	1639.1170	-54.1300	-13.00	PASS
2Fc to 10Fc	7010.3200	-50.6200	-13.00	PASS
	1647.9750	-54.6916	-13.00	PASS
	2471.9630	-51.3228	-13.00	PASS
	3295.9500	-51.9740	-13.00	PASS
	4119.9370	-53.3965	-13.00	PASS
	4943.9250	-54.0430	-13.00	PASS
	5767.9130	-53.7384	-13.00	PASS
	6591.9000	-53.2107	-13.00	PASS
7415.8870	-51.9285	-13.00	PASS	
8239.8750	-52.1968	-13.00	PASS	

Analog: 851.0125MHz, 25kHz Channel Spacing, Max. Power

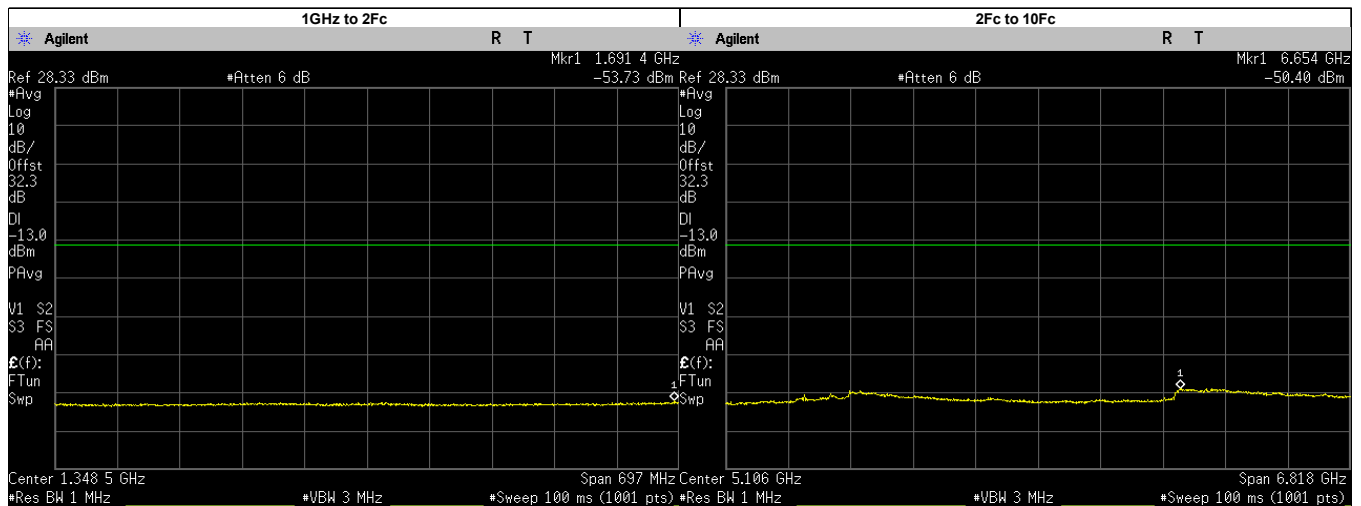
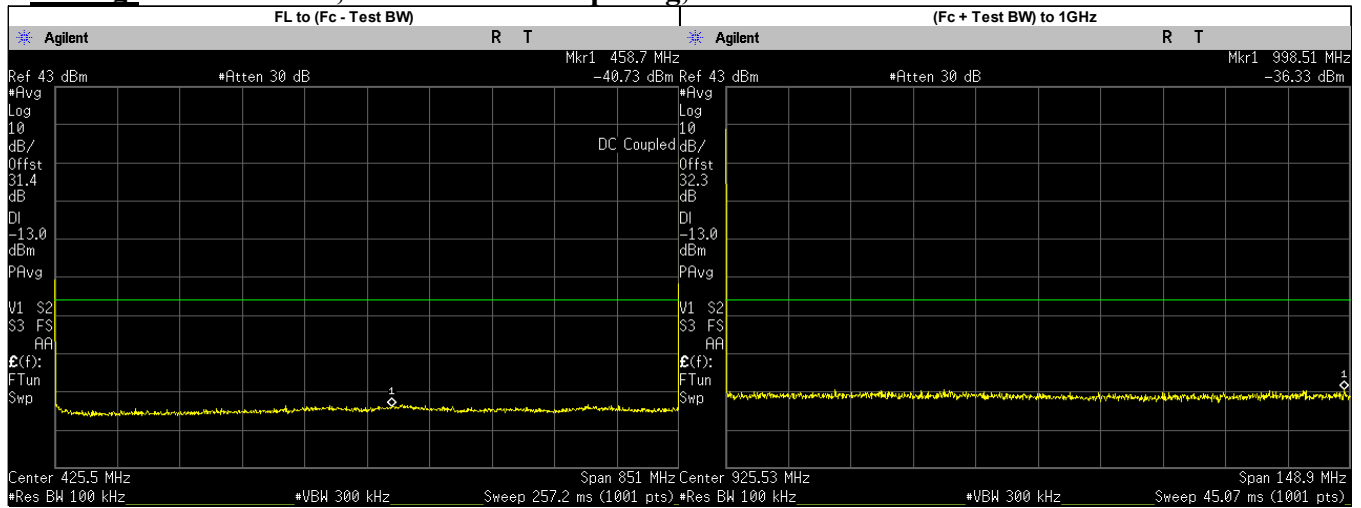

Frequency Range	Highest Spur Frequency (MHz)	Spurious Level (dBm)	Failing Limit (dBm)	Results
FL to (Fc - Test BW)	458.7000	-40.7270	-13.00	PASS
(Fc + Test BW) to 1GHz	998.5106	-36.3300	-13.00	PASS
1GHz to 2Fc	1691.4490	-53.7300	-13.00	PASS
2Fc to 10Fc	6653.7840	-50.4100	-13.00	PASS
	1702.0250	-54.2809	-13.00	PASS
	2553.0370	-52.5426	-13.00	PASS
	3404.0500	-52.2054	-13.00	PASS
	4255.0620	-53.6087	-13.00	PASS
	5106.0750	-53.9750	-13.00	PASS
	5957.0870	-53.9559	-13.00	PASS
	6808.1000	-50.8957	-13.00	PASS
	7659.1130	-51.8070	-13.00	PASS
	8510.1250	-52.6441	-13.00	PASS

Analog: 860.0125MHz, 25kHz Channel Spacing, Max. Power

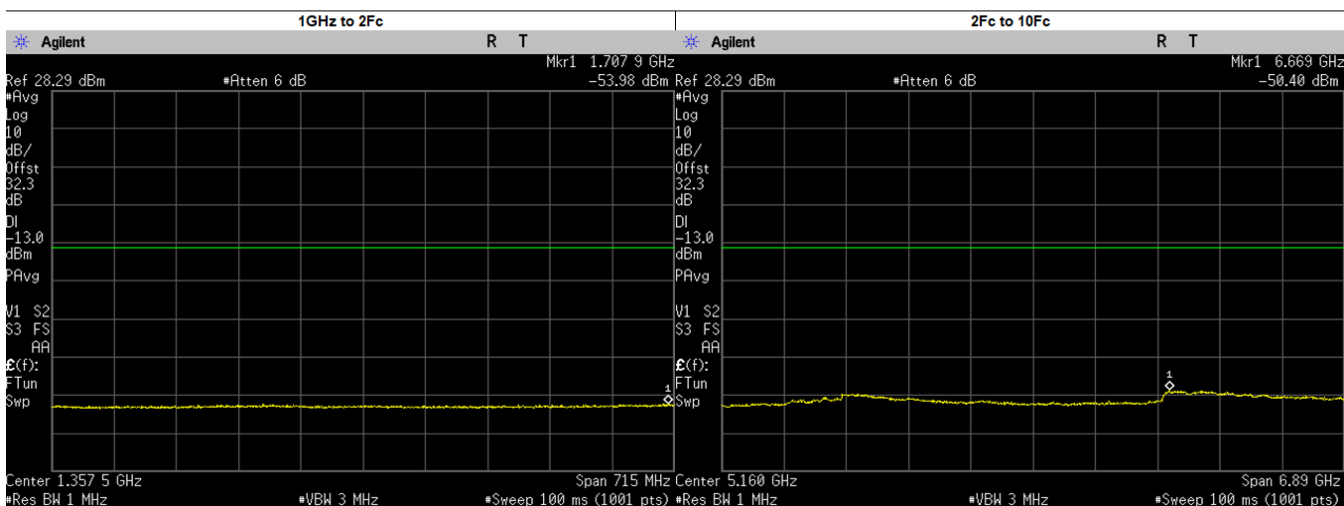
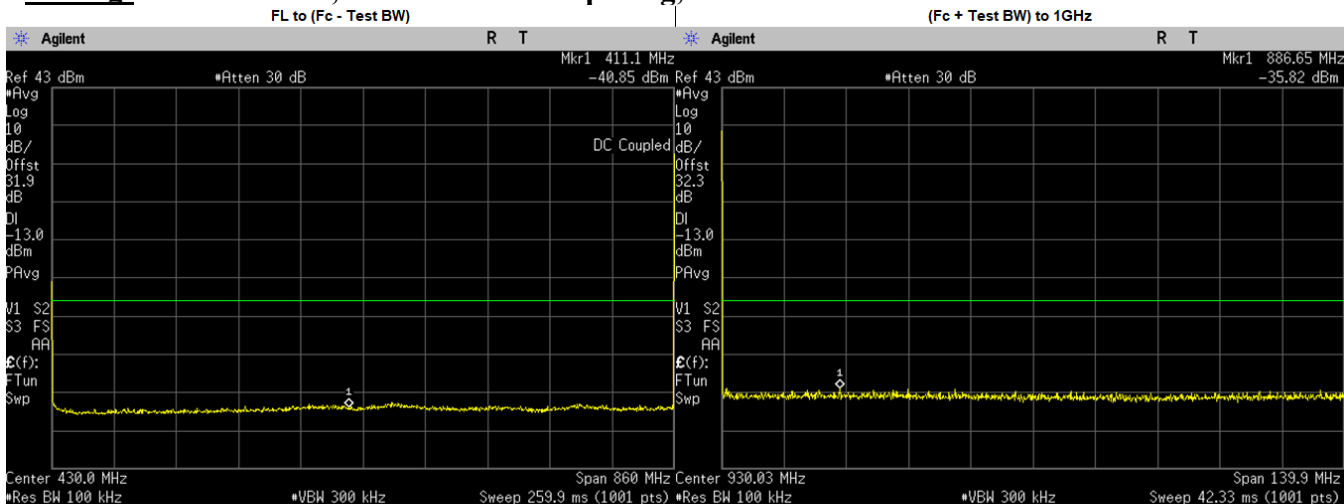

Frequency Range	Highest Spur Frequency (MHz)	Spurious Level (dBm)	Failing Limit (dBm)	Results
FL to (Fc - Test BW)	411.1000	-40.8500	-13.00	PASS
(Fc + Test BW) to 1GHz	886.6506	-35.8200	-13.00	PASS
1GHz to 2Fc	1707.8750	-53.9800	-13.00	PASS
2Fc to 10Fc	6669.0070	-50.4000	-13.00	PASS
	1720.0250	-54.3916	-13.00	PASS
	2580.0370	-53.0350	-13.00	PASS
	3440.0500	-52.2551	-13.00	PASS
	4300.0620	-53.6232	-13.00	PASS
	5160.0750	-54.0630	-13.00	PASS
	6020.0870	-53.9288	-13.00	PASS
	6880.1000	-51.3267	-13.00	PASS
	7740.1130	-51.9115	-13.00	PASS
8600.1250	-52.6857	-13.00	PASS	

Analog: 868.8875MHz, 25kHz Channel Spacing, Max. Power

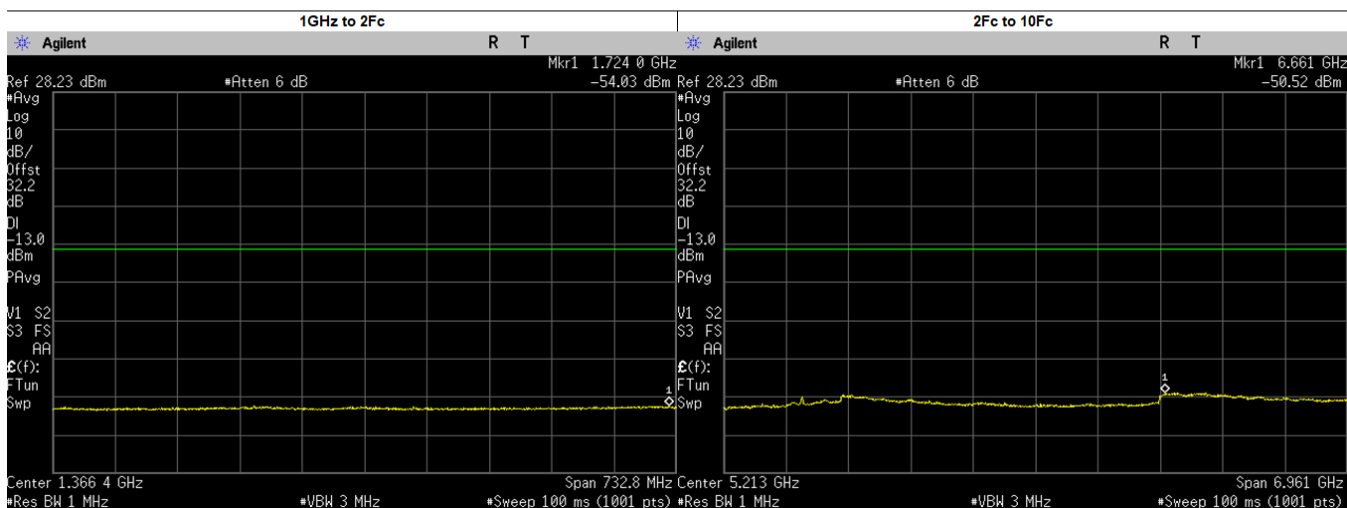
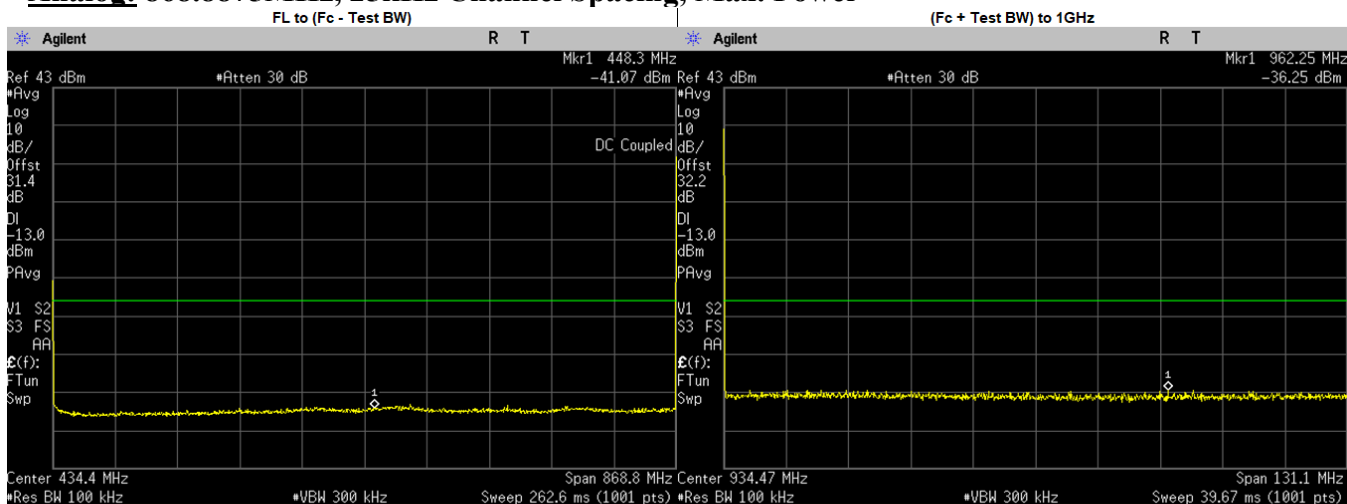

Frequency Range	Highest Spur Frequency (MHz)	Spurious Level (dBm)	Failing Limit (dBm)	Results
FL to (Fc - Test BW)	448.3000	-41.0700	-13.00	PASS
(Fc + Test BW) to 1GHz	962.2540	-36.2500	-13.00	PASS
1GHz to 2Fc	1723.9820	-54.0300	-13.00	PASS
2Fc to 10Fc	6661.2340	-50.5200	-13.00	PASS
	1737.7750	-54.5474	-13.00	PASS
	2606.6620	-51.9337	-13.00	PASS
	3475.5500	-52.2057	-13.00	PASS
	4344.4370	-53.7050	-13.00	PASS
	5213.3250	-53.9700	-13.00	PASS
	6082.2120	-53.9679	-13.00	PASS
	6951.1000	-51.1100	-13.00	PASS
	7819.9880	-52.4493	-13.00	PASS
8688.8750	-52.5808	-13.00	PASS	

6.10.3. Test Result (Digital)

Digital: 806.0125MHz, 12.5 kHz Channel Spacing, Max Power

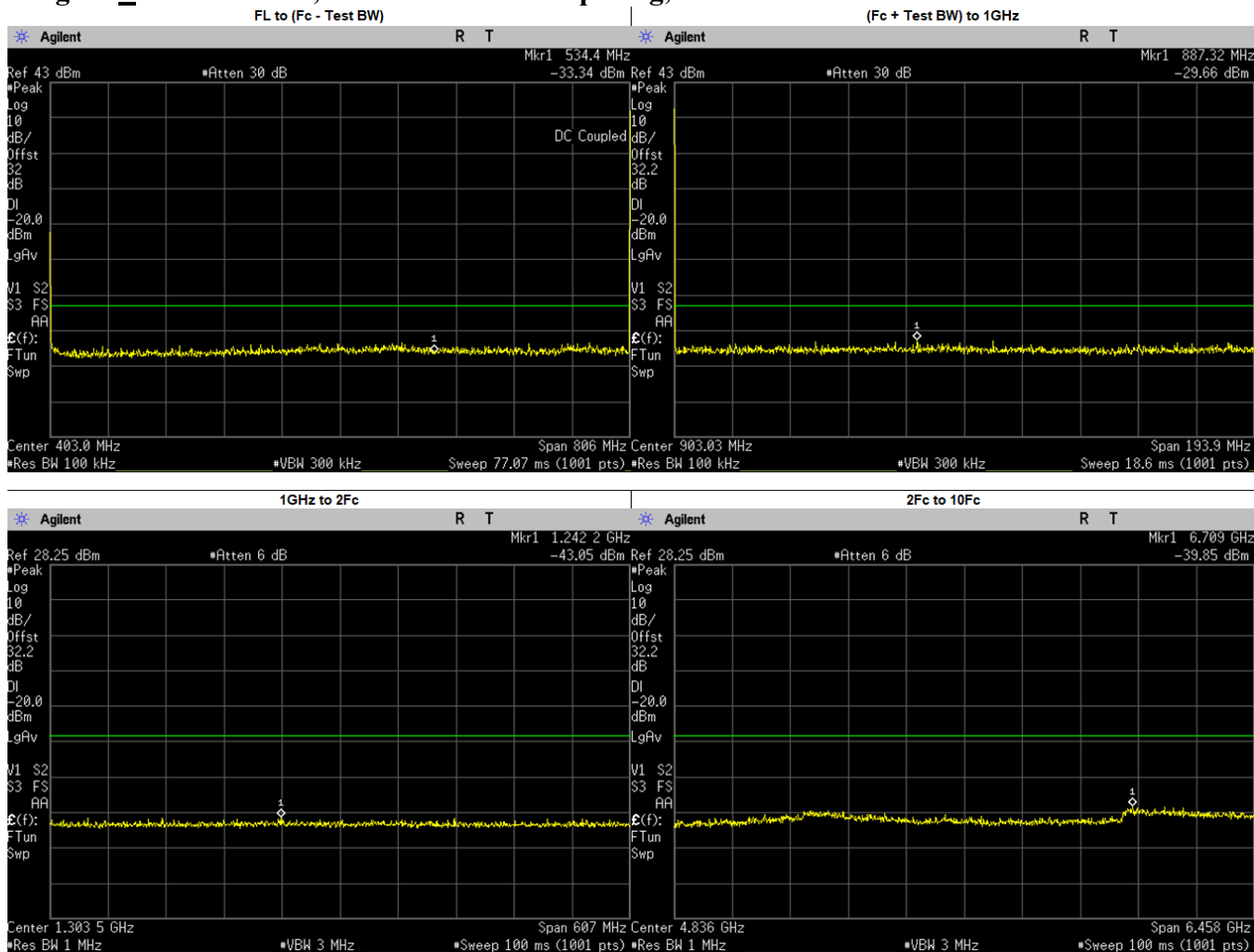

Frequency Range	Highest Spur Frequency (MHz)	Spurious Level (dBm)	Failing Limit (dBm)	Results
FL to (Fc - Test BW)	534.4000	-33.3400	-20.00	PASS
(Fc + Test BW) to 1GHz	887.3223	-29.6600	-20.00	PASS
1GHz to 2Fc	1242.2030	-43.0500	-20.00	PASS
2Fc to 10Fc	1612.0250	-45.0847	-20.00	PASS
	2418.0370	-44.2405	-20.00	PASS
	3224.0500	-42.6023	-20.00	PASS
	4030.0620	-43.2210	-20.00	PASS
	4836.0750	-44.6310	-20.00	PASS
	5642.0870	-44.1881	-20.00	PASS
	6448.1000	-44.2242	-20.00	PASS
	7254.1130	-41.9936	-20.00	PASS
	8060.1250	-42.6425	-20.00	PASS
6708.9240	-39.8500	-20.00	PASS	

Digital: 814.9875MHz, 12.5 kHz Channel Spacing, Max Power

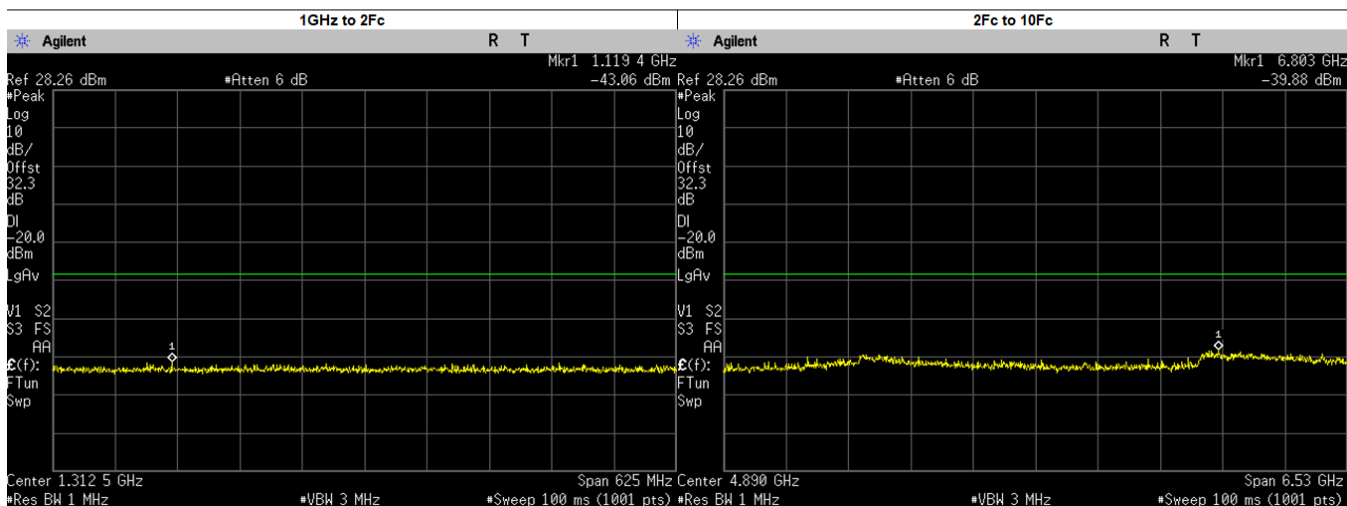
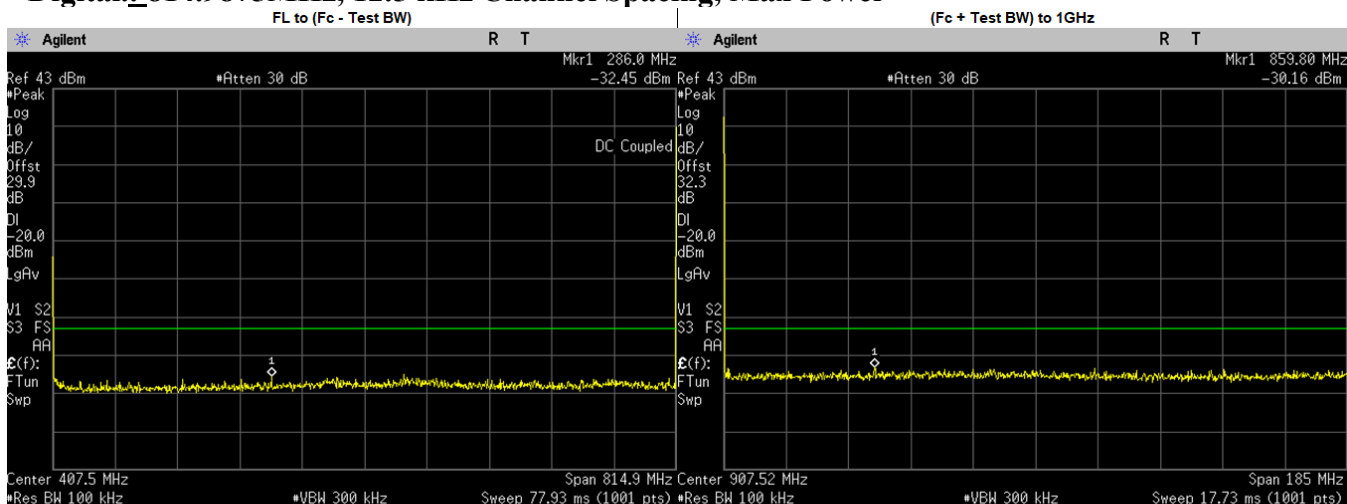

Frequency Range	Highest Spur Frequency (MHz)	Spurious Level (dBm)	Failing Limit (dBm)	Results
FL to (Fc - Test BW)	286.0000	-32.4480	-20.00	PASS
(Fc + Test BW) to 1GHz	859.7984	-30.1600	-20.00	PASS
1GHz to 2Fc	1119.3700	-43.0600	-20.00	PASS
2Fc to 10Fc	1629.9750	-44.9703	-20.00	PASS
	2444.9630	-44.5887	-20.00	PASS
	3259.9500	-41.9931	-20.00	PASS
	4074.9370	-44.1005	-20.00	PASS
	4889.9250	-44.0080	-20.00	PASS
	5704.9130	-44.5181	-20.00	PASS
	6519.9000	-43.9052	-20.00	PASS
	7334.8870	-42.0404	-20.00	PASS
	8149.8750	-43.2368	-20.00	PASS
	6803.1860	-39.8800	-20.00	PASS

Digital; 823.9875 MHz, 12.5 kHz Channel Spacing, Max Power

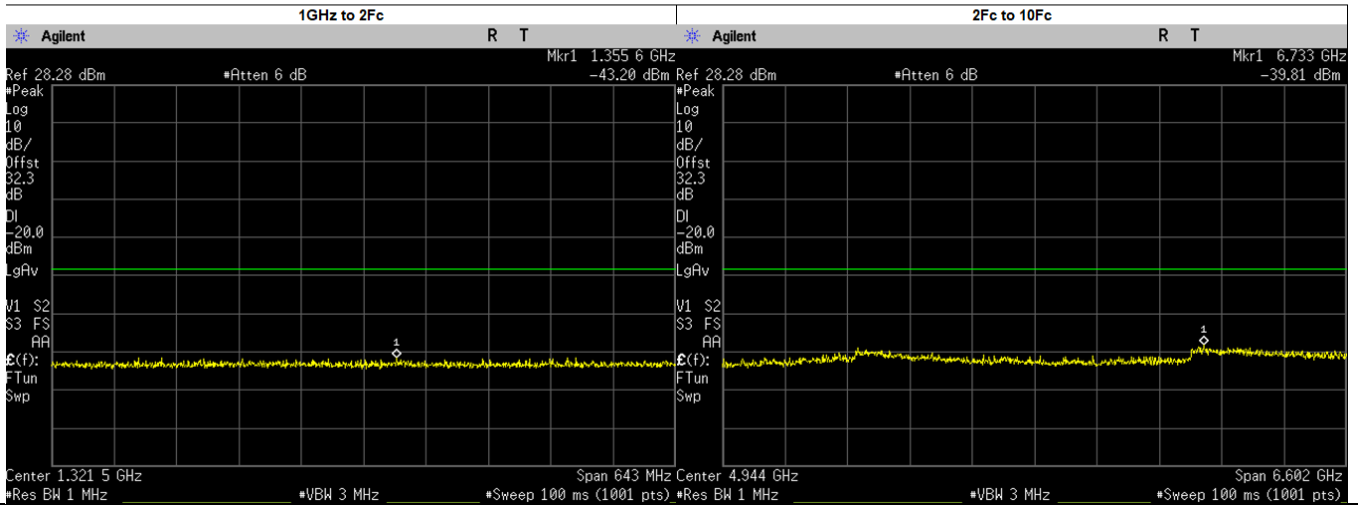
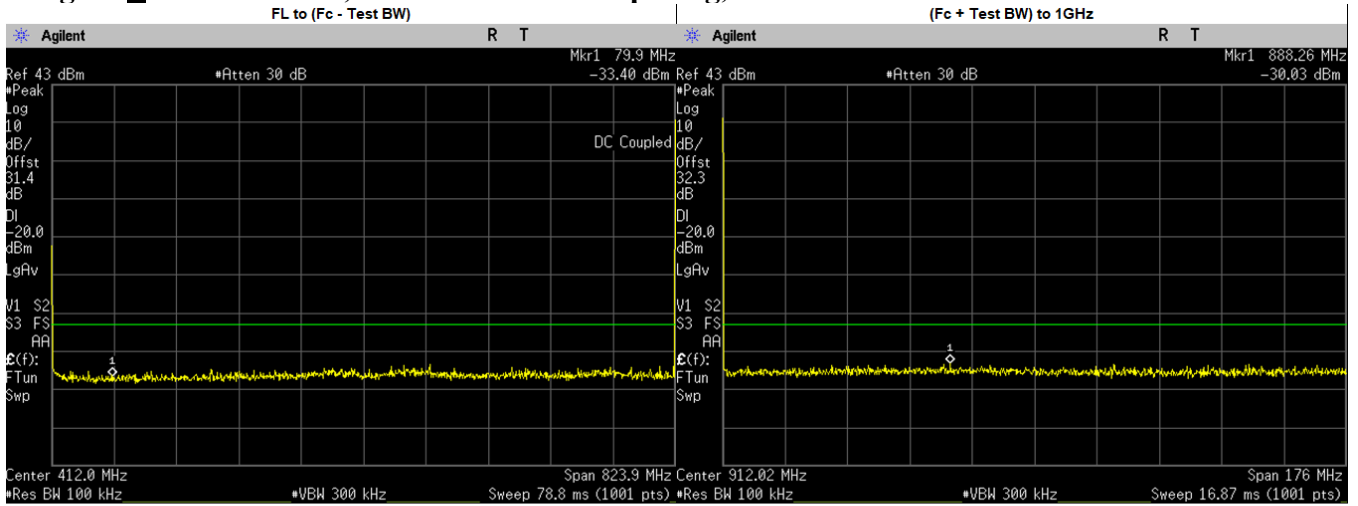

Frequency Range	Highest Spur Frequency (MHz)	Spurious Level (dBm)	Failing Limit (dBm)	Results
FL to (Fc - Test BW)	79.9000	-33.4030	-20.00	PASS
(Fc + Test BW) to 1GHz	888.2638	-30.0300	-20.00	PASS
1GHz to 2Fc	1355.5650	-43.2000	-20.00	PASS
2Fc to 10Fc	1647.9750	-44.0445	-20.00	PASS
	2471.9630	-44.1332	-20.00	PASS
	3295.9500	-41.7362	-20.00	PASS
	4119.9370	-43.6523	-20.00	PASS
	4943.9250	-44.5740	-20.00	PASS
	5767.9130	-44.5915	-20.00	PASS
	6591.9000	-43.7221	-20.00	PASS
	7415.8870	-42.2806	-20.00	PASS
8239.8750	-42.9905	-20.00	PASS	
6733.0400	-39.8100	-20.00	PASS	

Digital: 851.0125 MHz, 12.5 kHz Channel Spacing, Max Power

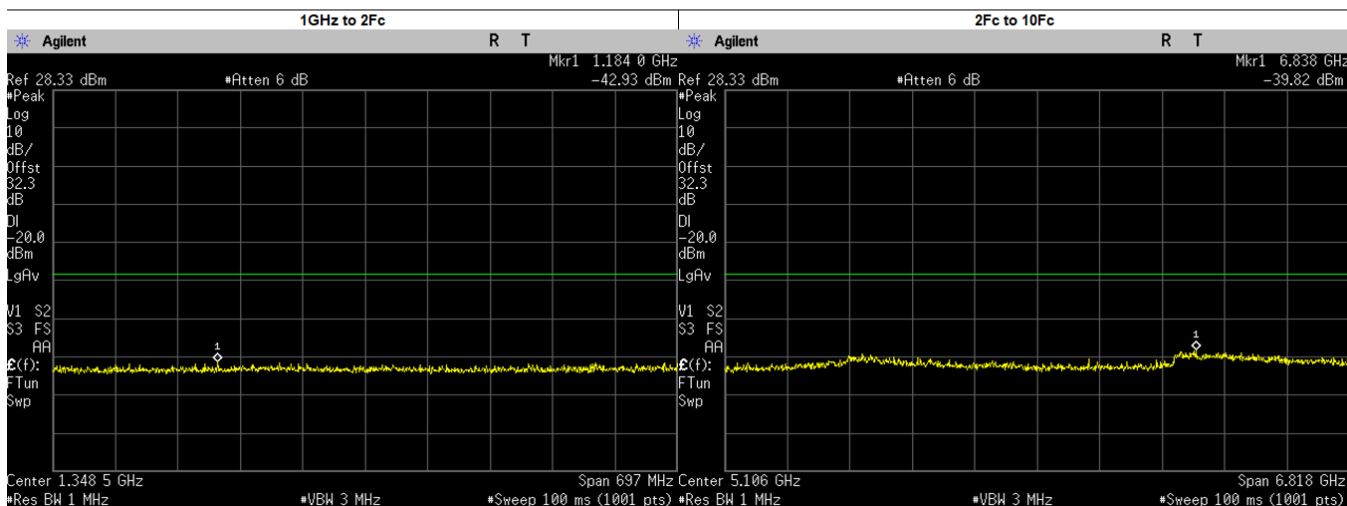
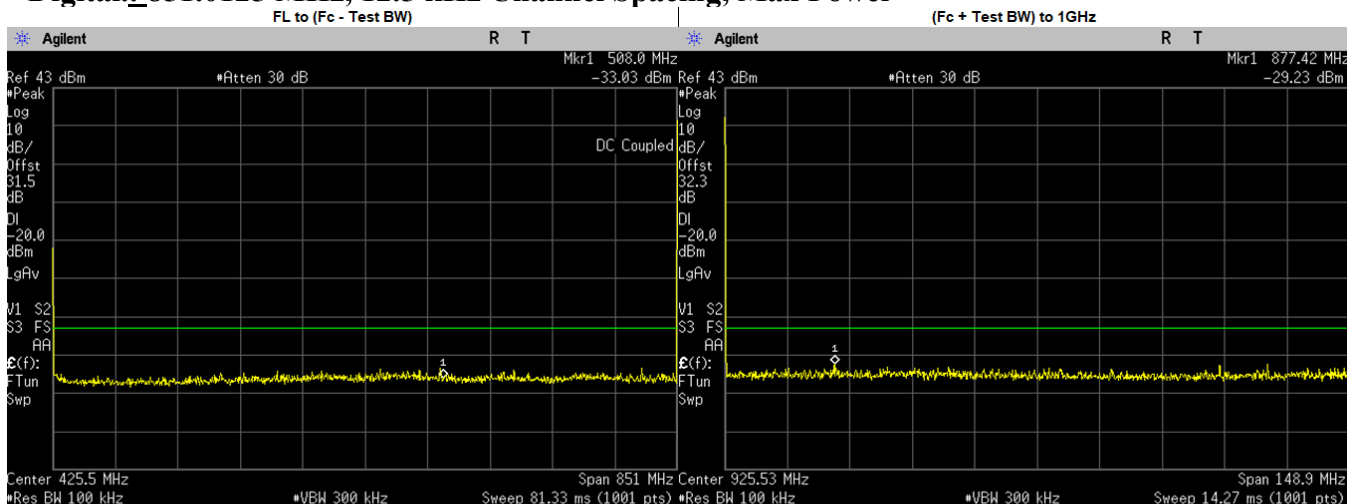

Frequency Range	Highest Spur Frequency (MHz)	Spurious Level (dBm)	Failing Limit (dBm)	Results
FL to (Fc - Test BW)	531.9000	-33.0330	-20.00	PASS
(Fc + Test BW) to 1GHz	877.4244	-29.2300	-20.00	PASS
1GHz to 2Fc	1184.0150	-42.9300	-20.00	PASS
2Fc to 10Fc	1702.0250	-45.0339	-20.00	PASS
	2553.0370	-44.1432	-20.00	PASS
	3404.0500	-43.3649	-20.00	PASS
	4255.0620	-43.8615	-20.00	PASS
	5106.0750	-45.2730	-20.00	PASS
	5957.0870	-44.4007	-20.00	PASS
	6808.1000	-41.0338	-20.00	PASS
	7659.1130	-42.3405	-20.00	PASS
8510.1250	-43.1603	-20.00	PASS	
6837.8720	-39.8200	-20.00	PASS	

Digital: 860.0125MHz, 12.5 kHz Channel Spacing, Max Power

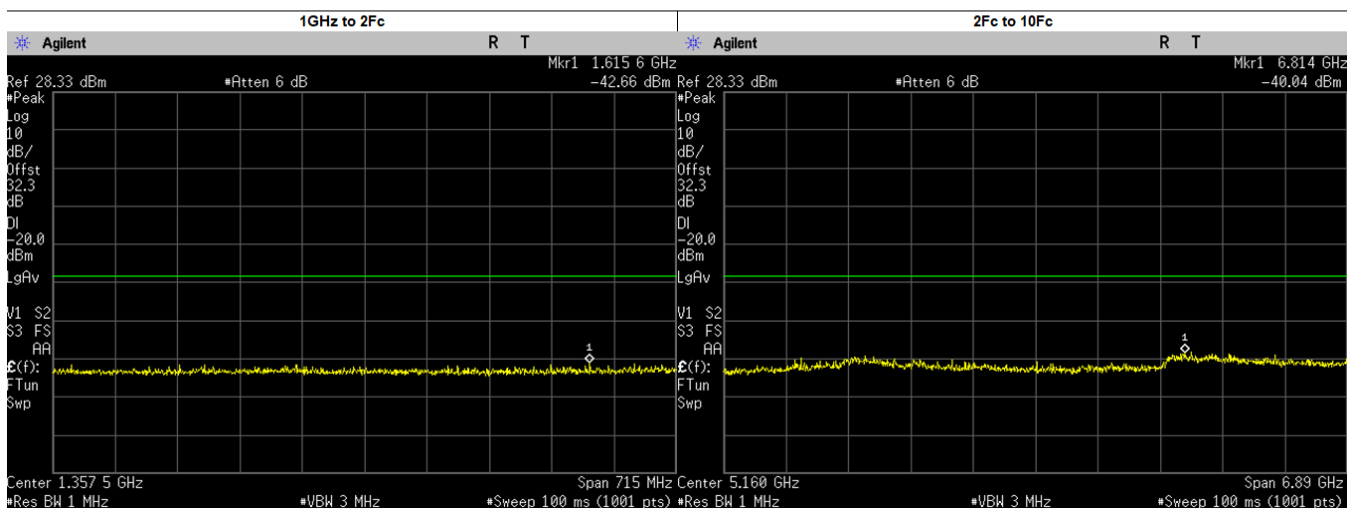
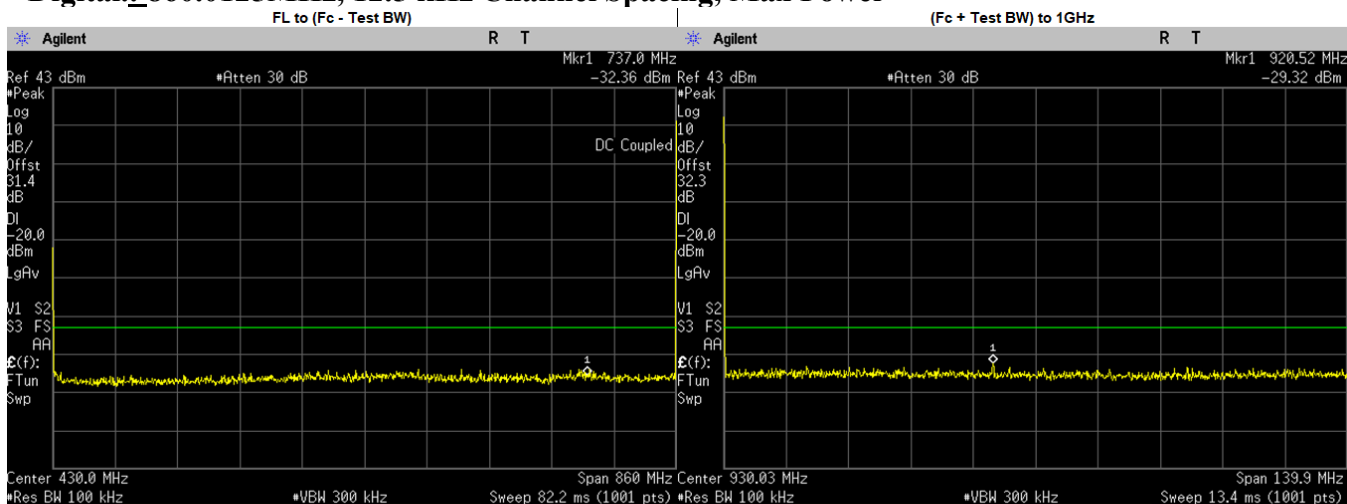

Frequency Range	Highest Spur Frequency (MHz)	Spurious Level (dBm)	Failing Limit (dBm)	Results
FL to (Fc - Test BW)	737.0000	-32.3590	-20.00	PASS
(Fc + Test BW) to 1GHz	920.5155	-29.3200	-20.00	PASS
1GHz to 2Fc	1615.6370	-42.6600	-20.00	PASS
2Fc to 10Fc	6813.6990	-40.0400	-20.00	PASS
	1720.0250	-44.5223	-20.00	PASS
	2580.0370	-44.1824	-20.00	PASS
	3440.0500	-42.1552	-20.00	PASS
	4300.0620	-44.5632	-20.00	PASS
	5160.0750	-44.1230	-20.00	PASS
	6020.0870	-43.8769	-20.00	PASS
	6880.1000	-40.1902	-20.00	PASS
	7740.1130	-42.1621	-20.00	PASS
8600.1250	-41.8432	-20.00	PASS	

Digital: 868.8875MHz, 12.5 kHz Channel Spacing, Max Power

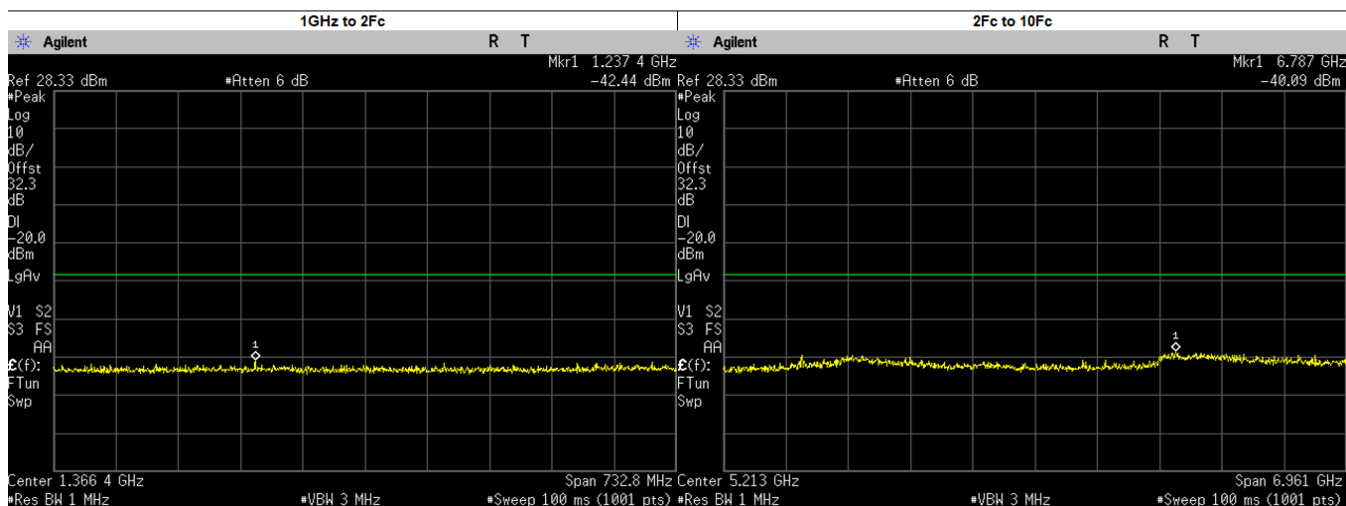
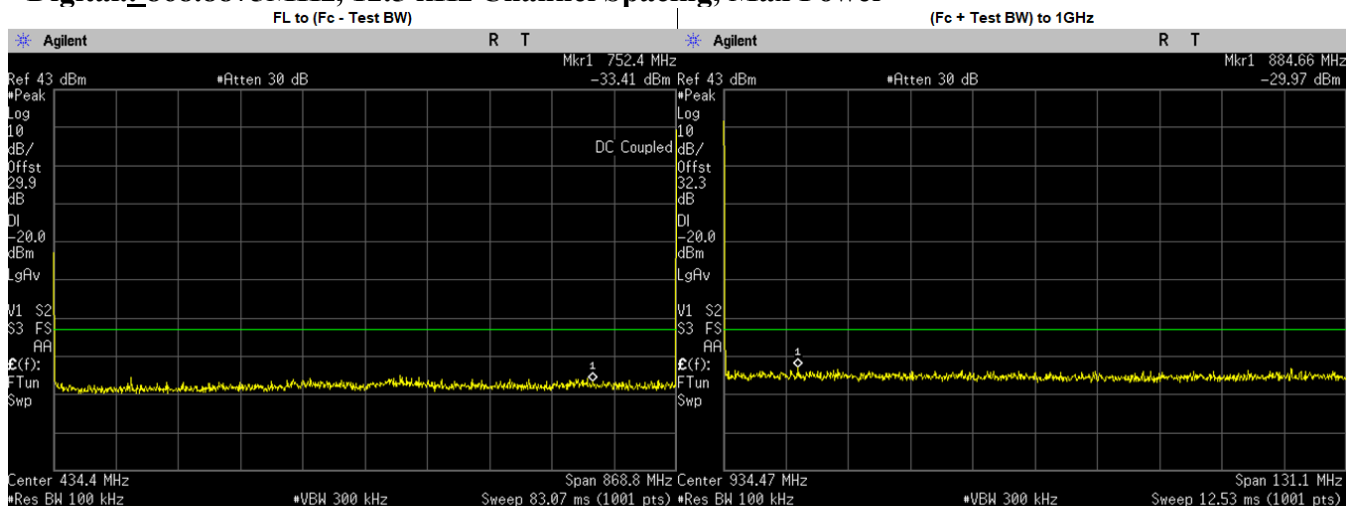

Frequency Range	Highest Spur Frequency (MHz)	Spurious Level (dBm)	Failing Limit (dBm)	Results
FL to (Fc - Test BW)	752.4000	-33.4090	-20.00	PASS
(Fc + Test BW) to 1GHz	884.6650	-29.9700	-20.00	PASS
1GHz to 2Fc	1237.4190	-42.4400	-20.00	PASS
2Fc to 10Fc	6786.5340	-40.0900	-20.00	PASS
	1737.7750	-44.2822	-20.00	PASS
	2606.6620	-41.5891	-20.00	PASS
	3475.5500	-42.6745	-20.00	PASS
	4344.4370	-43.4251	-20.00	PASS
	5213.3250	-44.8060	-20.00	PASS
	6082.2120	-44.2107	-20.00	PASS
	6951.1000	-41.9613	-20.00	PASS
7819.9880	-42.2686	-20.00	PASS	
8688.8750	-42.3929	-20.00	PASS	

Phase II.: 806.0125 MHz, 12.5 kHz Channel Spacing, Max Power

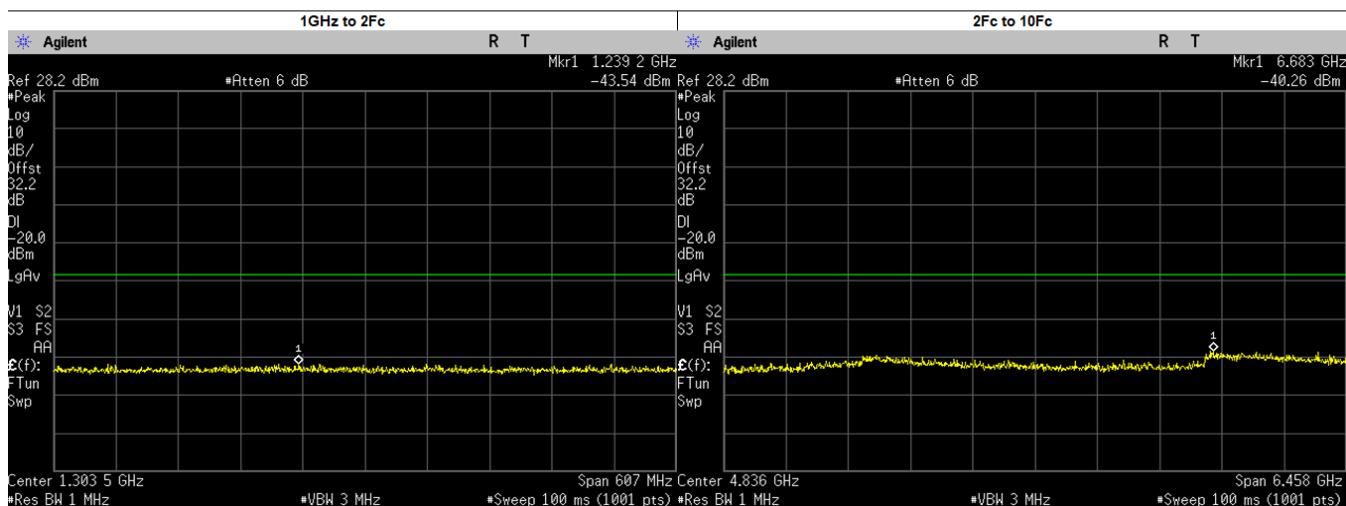
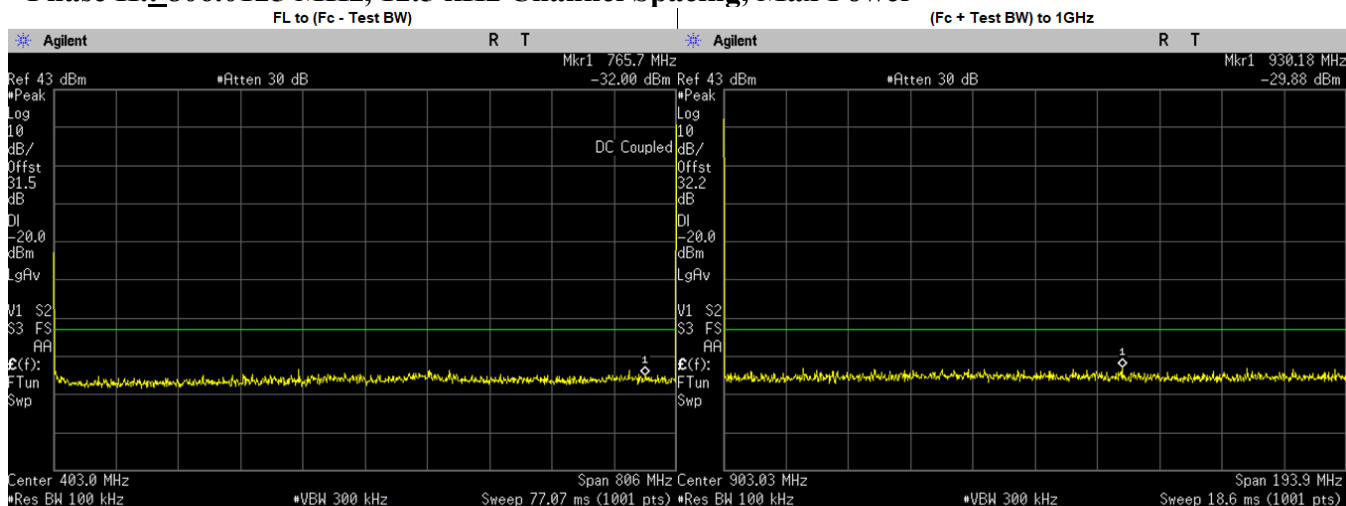

Frequency Range	Highest Spur Frequency (MHz)	Spurious Level (dBm)	Failing Limit (dBm)	Results
FL to (Fc - Test BW)	765.7000	-32.0020	-20.00	PASS
(Fc + Test BW) to 1GHz	930.1825	-29.8800	-20.00	PASS
1GHz to 2Fc	1239.1680	-43.5400	-20.00	PASS
2Fc to 10Fc	6683.0920	-40.2600	-20.00	PASS
	1612.0250	-45.5992	-20.00	PASS
	2418.0370	-45.1605	-20.00	PASS
	3224.0500	-42.2903	-20.00	PASS
	4030.0620	-44.0185	-20.00	PASS
	4836.0750	-44.6710	-20.00	PASS
	5642.0870	-43.5800	-20.00	PASS
	6448.1000	-44.5195	-20.00	PASS
	7254.1130	-42.0437	-20.00	PASS
8060.1250	-42.2308	-20.00	PASS	

Phase II.: 814.9875 MHz, 12.5 kHz Channel Spacing, Max Power

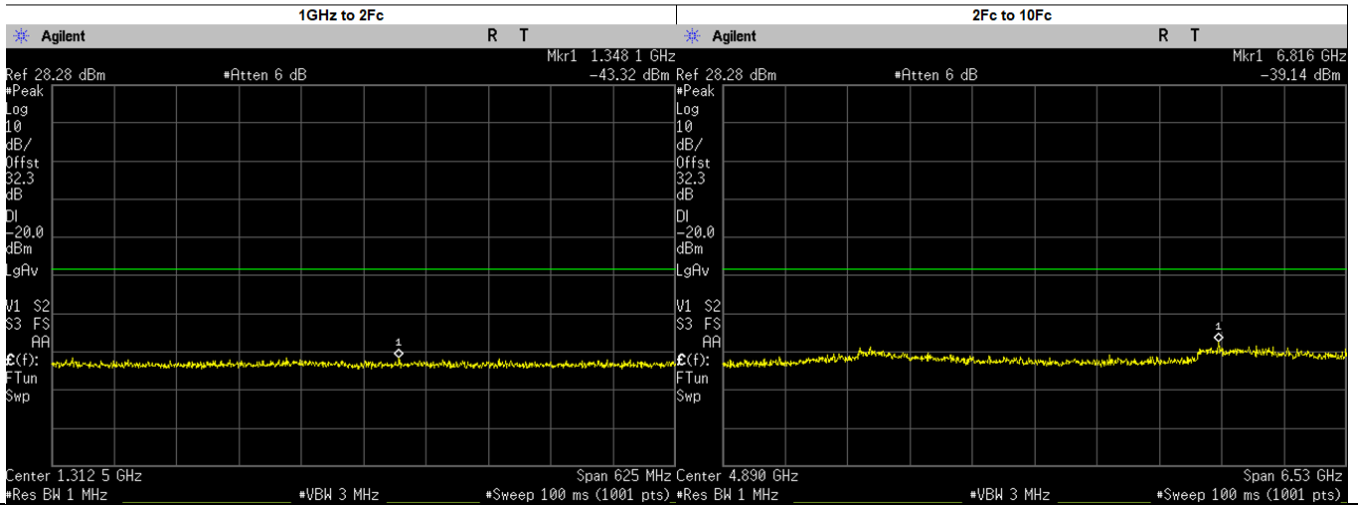
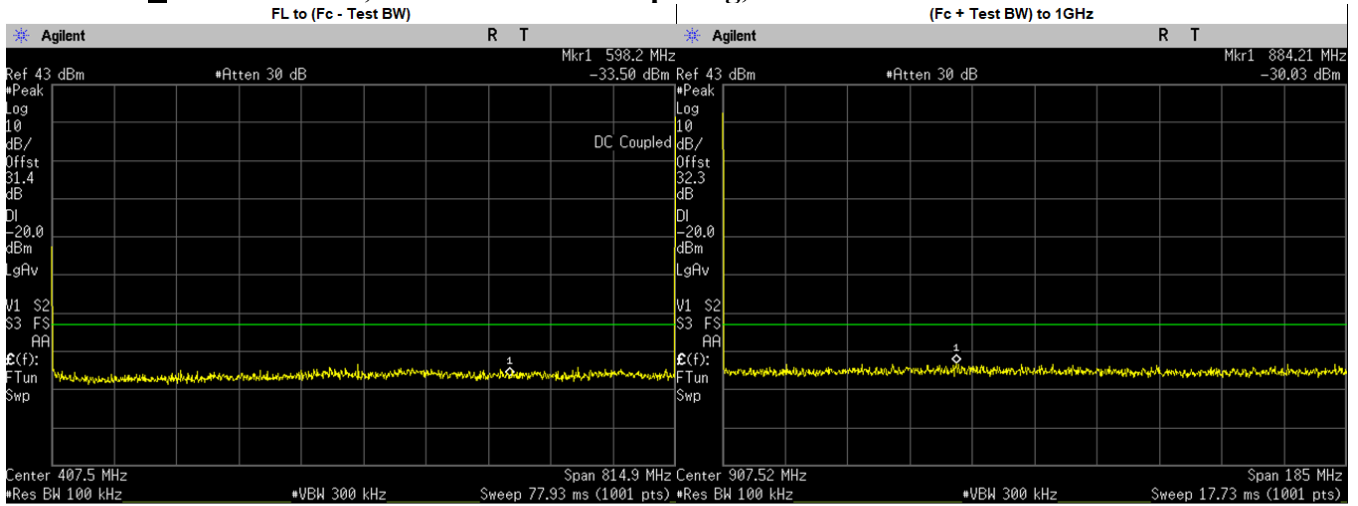

Frequency Range	Highest Spur Frequency (MHz)	Spurious Level (dBm)	Failing Limit (dBm)	Results
FL to (Fc - Test BW)	598.2000	-33.5020	-20.00	PASS
(Fc + Test BW) to 1GHz	884.2135	-30.0300	-20.00	PASS
1GHz to 2Fc	1348.1110	-43.3200	-20.00	PASS
2Fc to 10Fc	1629.9750	-44.6031	-20.00	PASS
	2444.9630	-43.9665	-20.00	PASS
	3259.9500	-42.2354	-20.00	PASS
	4074.9370	-43.3996	-20.00	PASS
	4889.9250	-44.7490	-20.00	PASS
	5704.9130	-43.8404	-20.00	PASS
	6519.9000	-43.7821	-20.00	PASS
	7334.8870	-40.8941	-20.00	PASS
8149.8750	-41.2618	-20.00	PASS	
	6816.2450	-39.1400	-20.00	PASS

Phase II.: 823.9875. MHz, 12.5 kHz Channel Spacing, Max Power

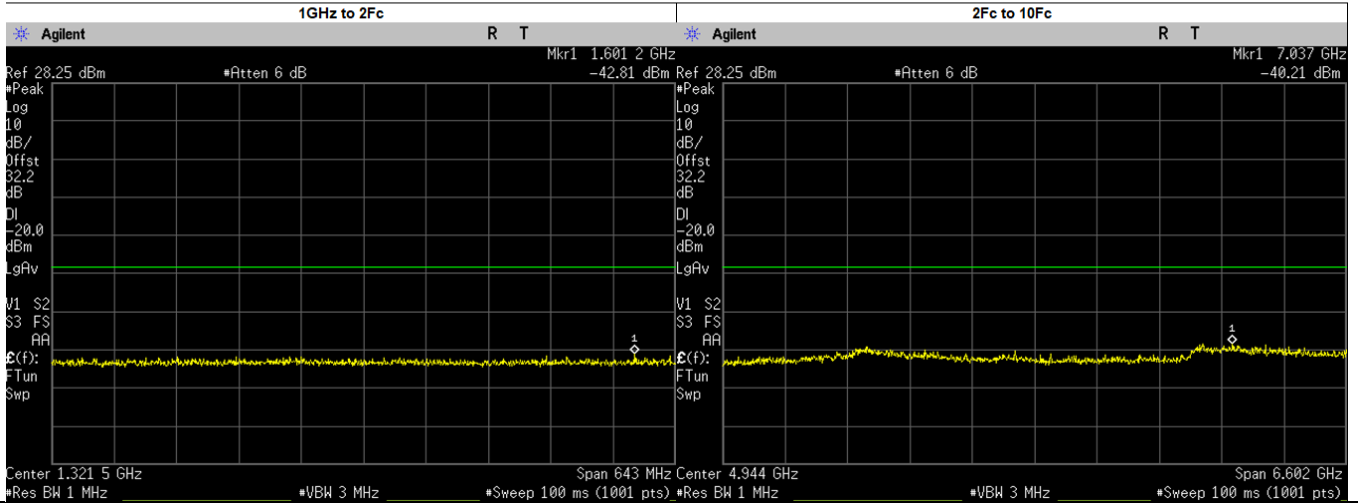
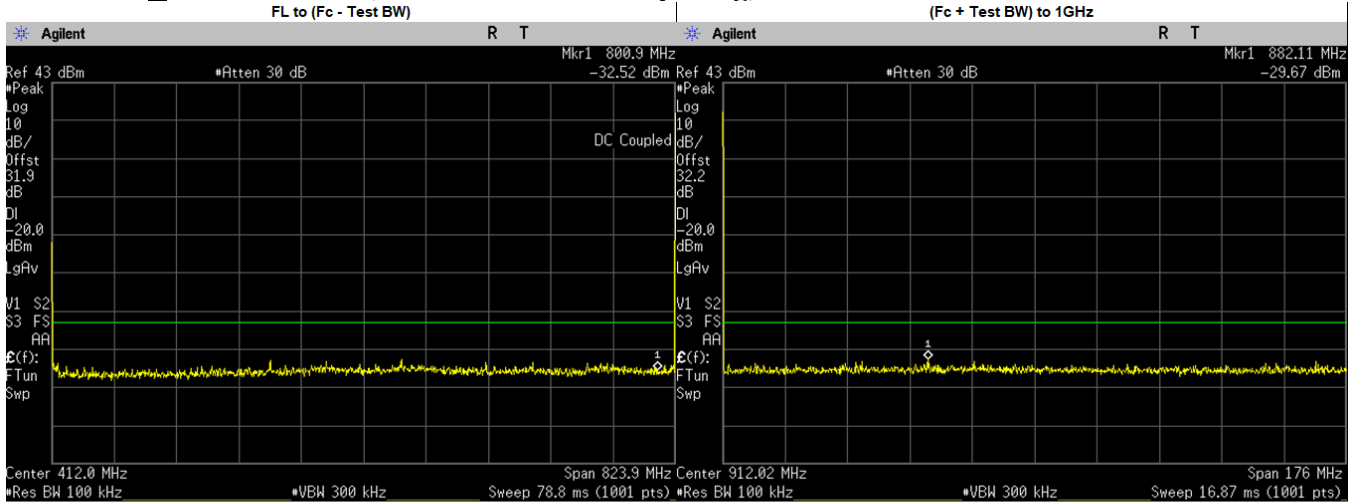

Frequency Range	Highest Spur Frequency (MHz)	Spurious Level (dBm)	Failing Limit (dBm)	Results
FL to (Fc - Test BW)	800.9000	-32.5240	-20.00	PASS
(Fc + Test BW) to 1GHz	882.1051	-29.6700	-20.00	PASS
1GHz to 2Fc	1601.1820	-42.8000	-20.00	PASS
2Fc to 10Fc	7036.7270	-40.2100	-20.00	PASS
	1647.9750	-45.4258	-20.00	PASS
	2471.9630	-44.1869	-20.00	PASS
	3295.9500	-42.2646	-20.00	PASS
	4119.9370	-43.4553	-20.00	PASS
	4943.9250	-44.4640	-20.00	PASS
	5767.9130	-44.6739	-20.00	PASS
	6591.9000	-43.6189	-20.00	PASS
7415.8870	-42.5301	-20.00	PASS	
8239.8750	-43.1242	-20.00	PASS	

Phase II.: 851.0125. MHz, 12.5 kHz Channel Spacing, Max Power

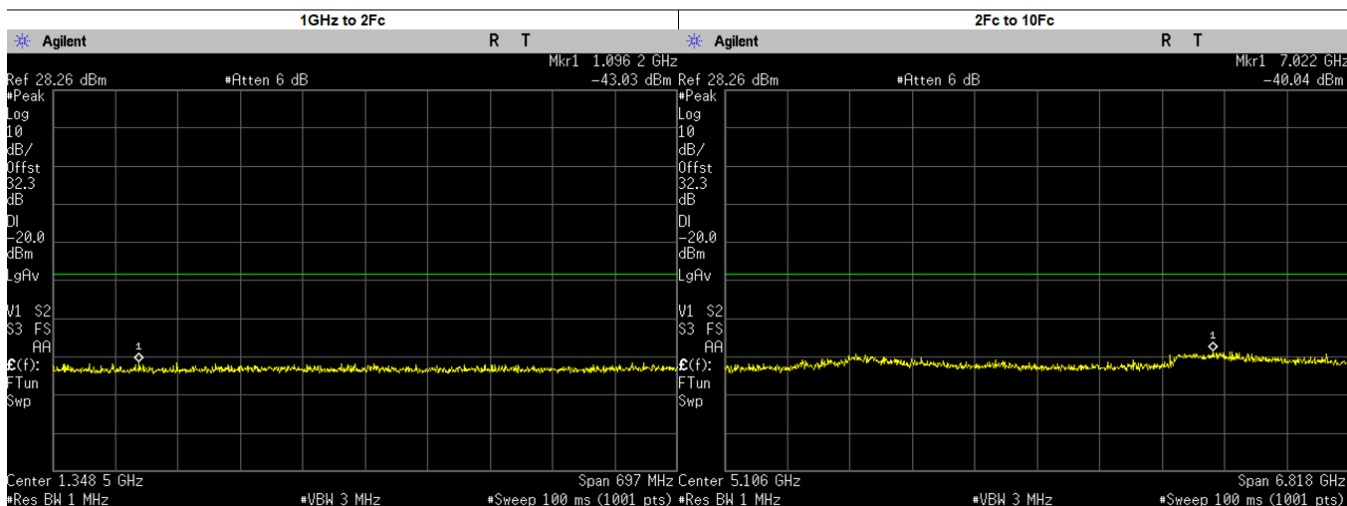
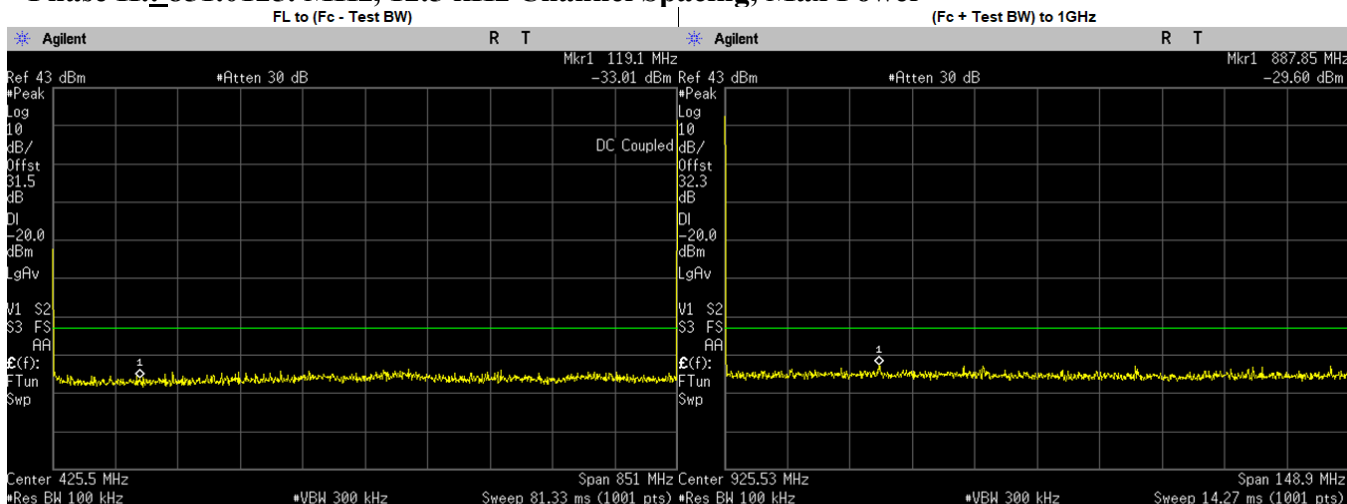

Frequency Range	Highest Spur Frequency (MHz)	Spurious Level (dBm)	Failing Limit (dBm)	Results
FL to (Fc - Test BW)	119.1000	-33.0150	-20.00	PASS
(Fc + Test BW) to 1GHz	887.8501	-29.6000	-20.00	PASS
1GHz to 2Fc	1096.1890	-43.0300	-20.00	PASS
2Fc to 10Fc	7021.9610	-40.0400	-20.00	PASS
	1702.0250	-44.8869	-20.00	PASS
	2553.0370	-43.2377	-20.00	PASS
	3404.0500	-43.1920	-20.00	PASS
	4255.0620	-43.8981	-20.00	PASS
	5106.0750	-45.2100	-20.00	PASS
	5957.0870	-44.6223	-20.00	PASS
	6808.1000	-41.3228	-20.00	PASS
	7659.1130	-42.5735	-20.00	PASS
8510.1250	-42.3545	-20.00	PASS	

Phase II.: 860.0125MHz, 12.5 kHz Channel Spacing, Max Power

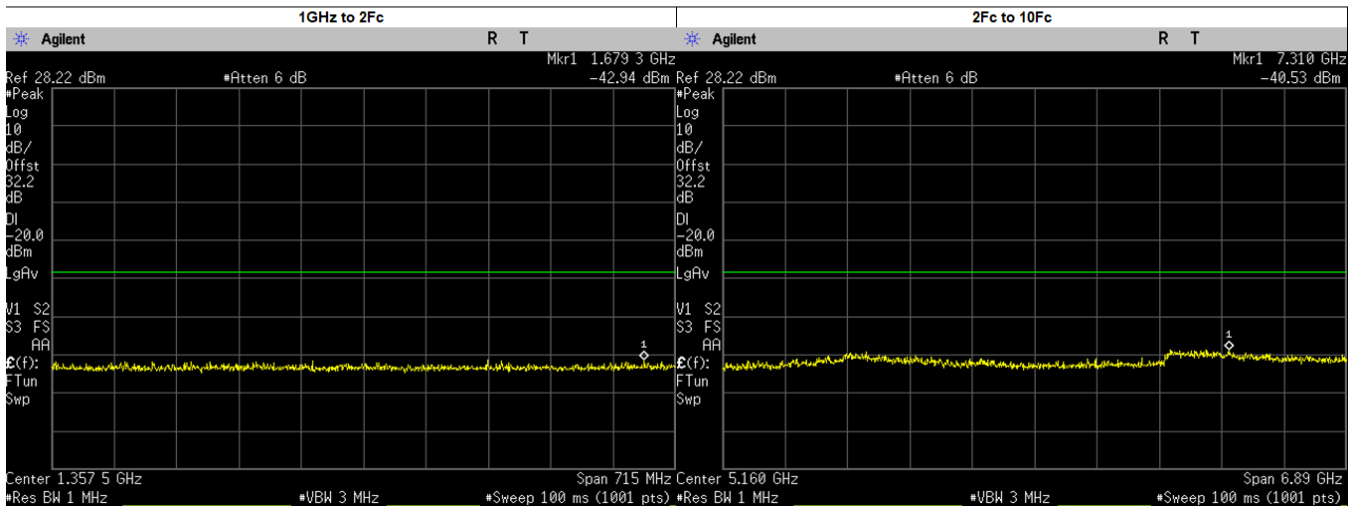
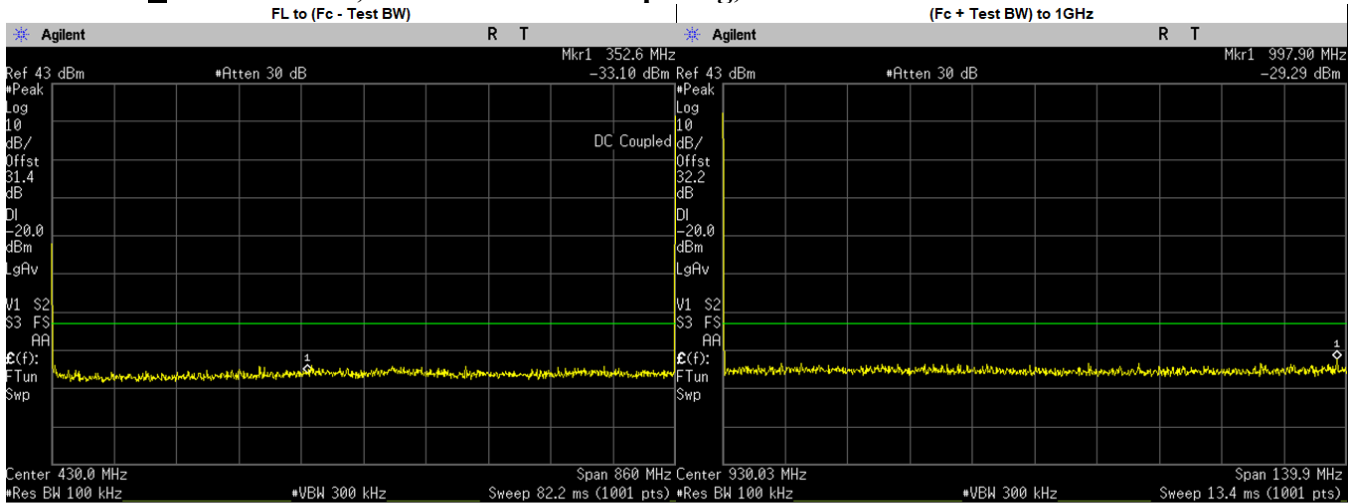

Frequency Range	Highest Spur Frequency (MHz)	Spurious Level (dBm)	Failing Limit (dBm)	Results
FL to (Fc - Test BW)	352.6000	-33.1020	-20.00	PASS
(Fc + Test BW) to 1GHz	997.9009	-29.2900	-20.00	PASS
1GHz to 2Fc	1679.2740	-42.9400	-20.00	PASS
2Fc to 10Fc	7309.7860	-40.5200	-20.00	PASS
	1720.0250	-45.2903	-20.00	PASS
	2580.0370	-44.1984	-20.00	PASS
	3440.0500	-42.1462	-20.00	PASS
	4300.0620	-43.5645	-20.00	PASS
	5160.0750	-44.3870	-20.00	PASS
	6020.0870	-44.5923	-20.00	PASS
	6880.1000	-41.7082	-20.00	PASS
	7740.1130	-42.4512	-20.00	PASS
8600.1250	-43.5057	-20.00	PASS	

Phase II.: 868.8875MHz, 12.5 kHz Channel Spacing, Max Power

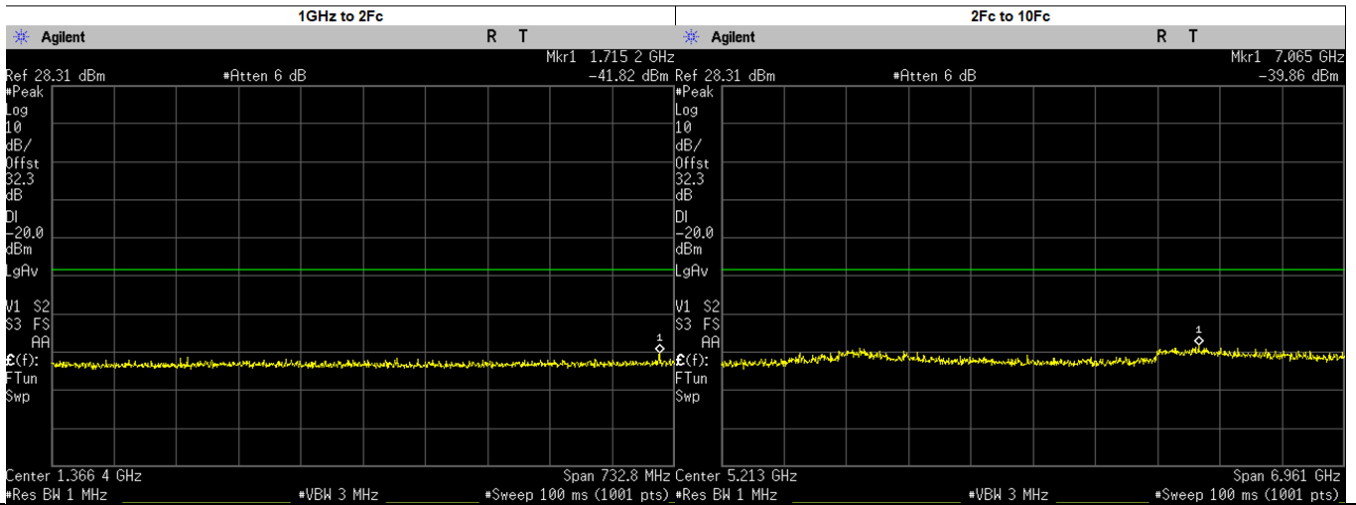
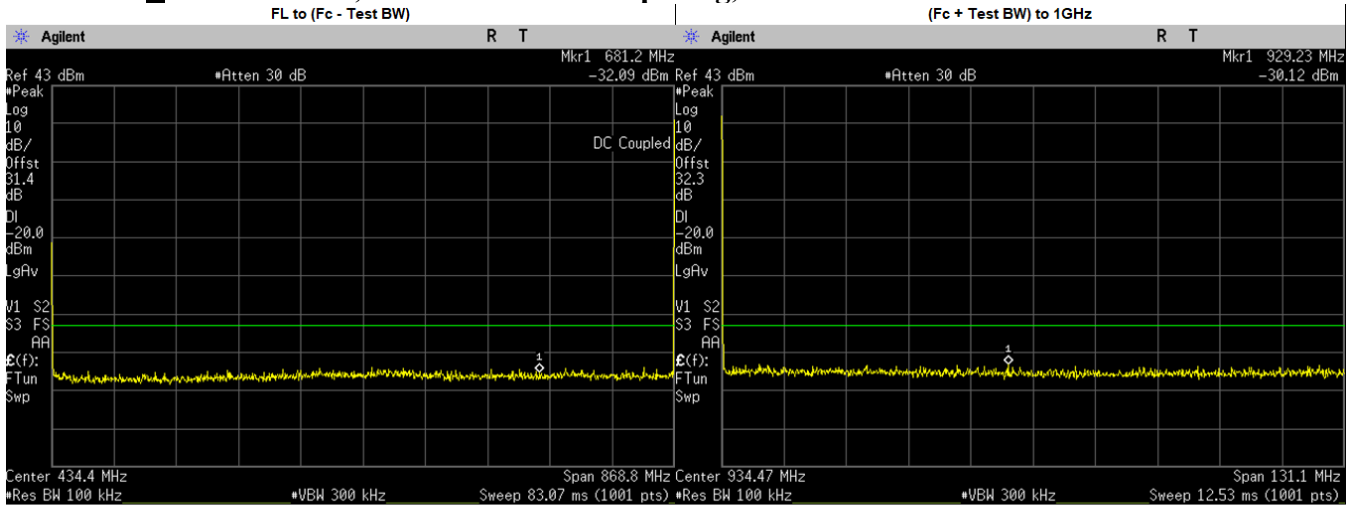

Frequency Range	Highest Spur Frequency (MHz)	Spurious Level (dBm)	Failing Limit (dBm)	Results
FL to (Fc - Test BW)	681.2000	-32.0940	-20.00	PASS
(Fc + Test BW) to 1GHz	929.2263	-30.1200	-20.00	PASS
1GHz to 2Fc	1715.1880	-41.8200	-20.00	PASS
2Fc to 10Fc	1737.7750	-44.4491	-20.00	PASS
	2606.6620	-42.2313	-20.00	PASS
	3475.5500	-42.1080	-20.00	PASS
	4344.4370	-44.2662	-20.00	PASS
	5213.3250	-44.1240	-20.00	PASS
	6082.2120	-44.7740	-20.00	PASS
	6951.1000	-41.7642	-20.00	PASS
	7819.9880	-42.0262	-20.00	PASS
	8688.8750	-43.1767	-20.00	PASS
	7064.9780	-39.8600	-20.00	PASS

6.10.4. Test Limit

Table below summarized the power of any emission outside a licensee's frequency block shall be attenuated below the transmitter power (P) by at least

Channel Spacing	Part 22	Part 24D	Part 74	Part 80	Part 90 (UHF, VHF, 800, 900)	Part 90 (700)
12.5kHz	43 + log ₁₀ (P) (-13 dBm)	43 + log ₁₀ (P) (-13 dBm)	43 + log ₁₀ (P) (-13 dBm)	Not Applicable	50 + log ₁₀ (P) (-20 dBm)	43 + log ₁₀ (P) (-13 dBm)
25kHz		Not Applicable		43 + log ₁₀ (P) (-13 dBm)	43 + log ₁₀ (P) (-13 dBm)	43 + log ₁₀ (P) (-13 dBm)

Channel Spacing	RSS 134	RSS 182	RSS 119 (UHF, VHF, 800, 900)	RSS 119 (700)
12.5kHz	43 + log ₁₀ (P) (-13 dBm)	Not Applicable	50 + log ₁₀ (P) (-20 dBm)	43 + log ₁₀ (P) (-13 dBm)
25kHz	Not Applicable	43 + log ₁₀ (P) (-13 dBm)	43 + log ₁₀ (P) (-13 dBm)	43 + log ₁₀ (P) (-13 dBm)

6.11. Radiated Spurious Emission

6.11.1. Test Setup

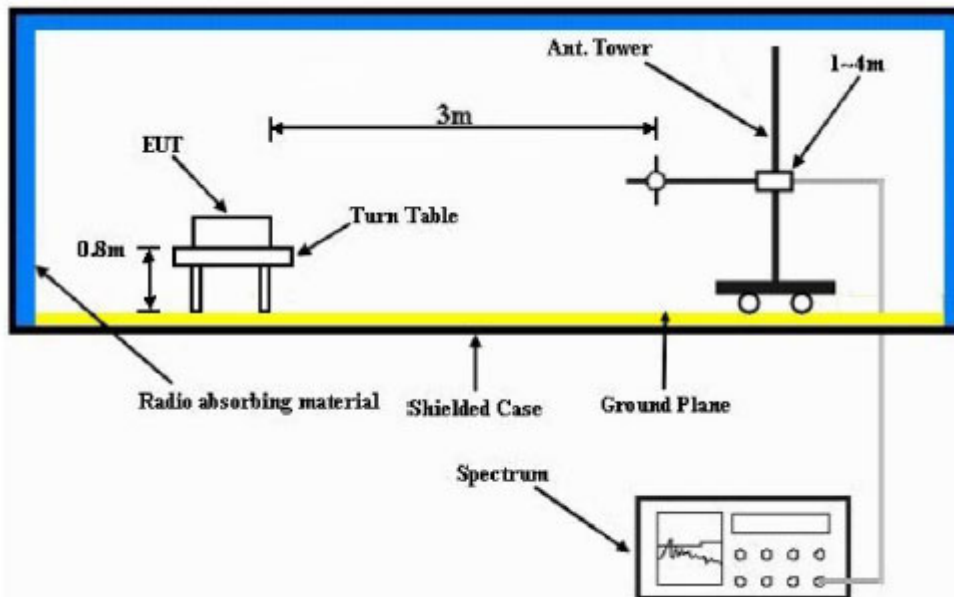

- 1) The Resolution Bandwidth for scanning Radiated Emission below 1 GHz is 100 kHz with Video Bandwidth = 300 kHz and Resolution Bandwidth for above 1 GHz is 1 MHz with Video Bandwidth = 3 MHz. Detector mode is positive peak.
- 2) In the semi- anechoic chamber, setup as illustrated above the DUT placed on the 0.8m height (for $F_c < 1\text{GHz}$) or 1.5m height (for $F_c > 1\text{GHz}$) of Turn Table, rotated the table around 360 degrees to search the maximum radiation power and receiver antenna shall be rotated vertical and horizontal polarization and moved height from 1m to 4m to find the maximum polar radiated power. The “Read Value” is the spectrum reading the maximum power value.
- 3) The substitution antenna is substituted for DUT at the same position and signals generator (S.G) export the CW signal to the substitution antenna via a TX cable. The receiver antenna shall be rotated vertical and horizontal polarization and moved height from 1m to 4m to find the maximum radiation power. Record the power level of maximum radiation power from spectrum. So, the measured substitution value = Ref level of S.G + TX cables loss – Substituted Antenna Gain.
- 4) Final Radiated Spurious Emission = “Read Value” + Measured substitution value.

6.11.2. Test Result (Analog)

SAC Transmitter Radiated Emission:

Model Number: H25UCF9PW6AN S/N: 657TYB0716 SR:26860-EMC-00073
 Battery Part No: PMNN4813A Accy Part No: NA
 Test Mode: TX Analog
 806.012500 MHz 25 kHz 3.600 Watt(s) /Max Power

Frequency (MHz)	Limit	Horizontal Measured Emission Equip Pwr Into Ideal Dipole (dBm)	Vertical Measured Emission Equip Pwr Into ideal Dipole (dBm)
1612.0250	-13.0000	-59.4432 **	-58.9355 **
2418.0375	-13.0000	-54.4362 **	-54.6192 **
3224.0500	-13.0000	-52.1412 **	-51.2071 **
4030.0625	-13.0000	-49.8538 **	-50.6642 **
4836.0750	-13.0000	-48.1953 **	-48.7622 **
5642.0875	-13.0000	-47.5272 **	-47.5469 **
6448.1000	-13.0000	-44.1561 **	-45.7975 **
7254.1125	-13.0000	-42.7453 **	-42.7826 **
8060.1250	-13.0000	-42.7795 **	-42.8290 **

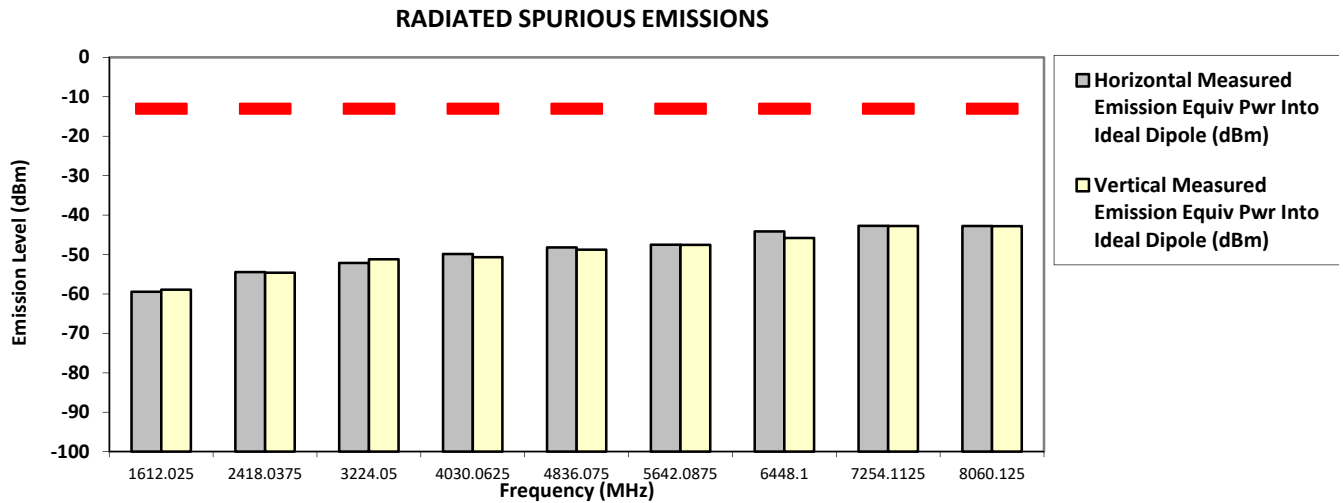

The data presented here was taken using the substitution method as found in the ANSI C63.26-2015 document.
 Motorola Penang EMC Lab - Test Performed by: Qawiman,Nazrin&Azil Sat, 5 Feb, 2022

Remarks: ** Indicates the spurious emission could not be detected due to noise limitations or ambient.
 *Pursuant to CFR 47 Part 2.1057 (c), emissions attenuated more than 20 dB below the permissible limit are not reported
 Temp(Deg): 23.3 Hum(%RH): 69.4

Remarks: Passed Results Marginal Results Failed Results

SAC Transmitter Radiated Emission:

Model Number: H25UCF9PW6AN

S/N: 657TYB0716

SR:26860-EMC-00073

Battery Part No: PMNN4813A

Accy Part No: NA

814.987500 MHz

**Test Mode: TX Analog
 25 kHz**

3.600 Watt(s) /Max Power

Frequency (MHz)	Limit	Horizontal Measured Emission Equiv Pwr Into Ideal Dipole (dBm)	Vertical Measured Emission Equiv Pwr Into ideal Dipole (dBm)
1629.9750	-13.0000	-58.7016 **	-58.7158 **
2444.9625	-13.0000	-54.2519 **	-54.8990 **
3259.9500	-13.0000	-50.5346 **	-52.0529 **
4074.9375	-13.0000	-51.7057 **	-51.4089 **
4889.9250	-13.0000	-47.3179 **	-48.1434 **
5704.9125	-13.0000	-47.3662 **	-48.5120 **
6519.9000	-13.0000	-44.6297 **	-45.1446 **
7334.8875	-13.0000	-42.5924 **	-43.3627 **
8149.8750	-13.0000	-43.6273 **	-43.7256 **

RADIATED SPURIOUS EMISSIONS

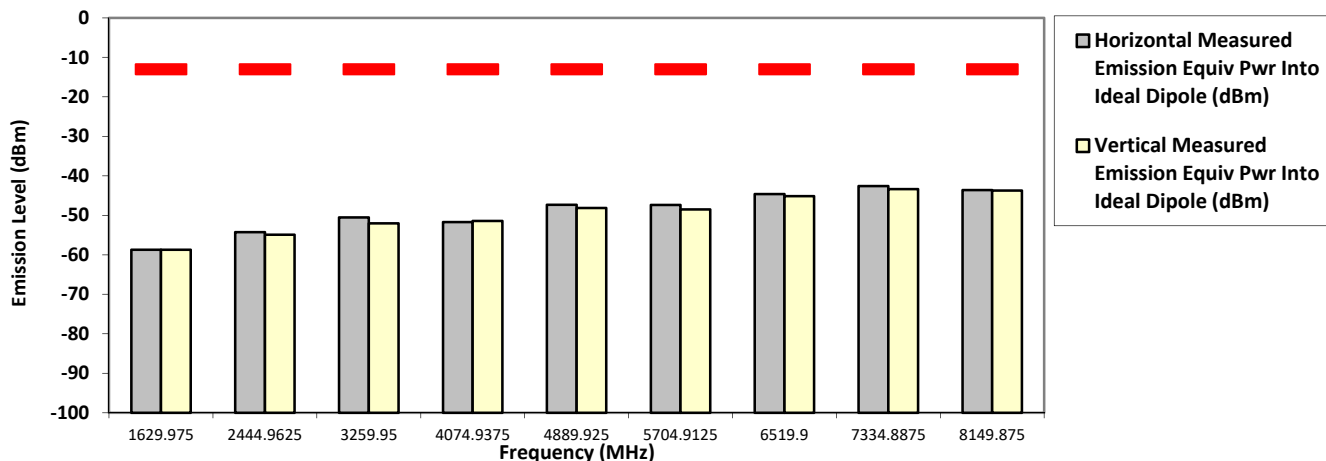

The data presented here was taken using the substitution method as found in the ANSI C63.26-2015 document.
 Motorola Penang EMC Lab - Test Performed by: Qawiman,Nazrin&Azil Sat, 5 Feb, 2022

Remarks: ** Indicates the spurious emission could not be detected due to noise limitations or ambient.
 *Pursuant to CFR 47 Part 2.1057 (c), emissions attenuated more than 20 dB below the permissible limit are not reported
 Temp(Deg): 23.3 Hum(%RH): 69.4

Remarks: Passed Results Marginal Results Failed Results

SAC Transmitter Radiated Emission:

Model Number: H25UCF9PW6AN

S/N: 657TYB0716

SR:26860-EMC-00073

Battery Part No: PMNN4813A

Accy Part No: NA

823.987500 MHz

**Test Mode: TX Analog
 25 kHz**

3.600 Watt(s) /Max Power

Frequency (MHz)	Limit	Horizontal Measured Emission Equiv Pwr Into Ideal Dipole (dBm)	Vertical Measured Emission Equiv Pwr Into ideal Dipole (dBm)
1647.9750	-13.0000	-59.3969 **	-59.1847 **
2471.9625	-13.0000	-54.4771 **	-54.2293 **
3295.9500	-13.0000	-51.7106 **	-50.6105 **
4119.9375	-13.0000	-50.7499 **	-51.1288 **
4943.9250	-13.0000	-47.1305 **	-48.0083 **
5767.9125	-13.0000	-44.3123 **	-47.3332 **
6591.9000	-13.0000	-44.2741 **	-43.9966 **
7415.8875	-13.0000	-43.1451 **	-43.0089 **
8239.8750	-13.0000	-44.1445 **	-42.8841 **

RADIATED SPURIOUS EMISSIONS

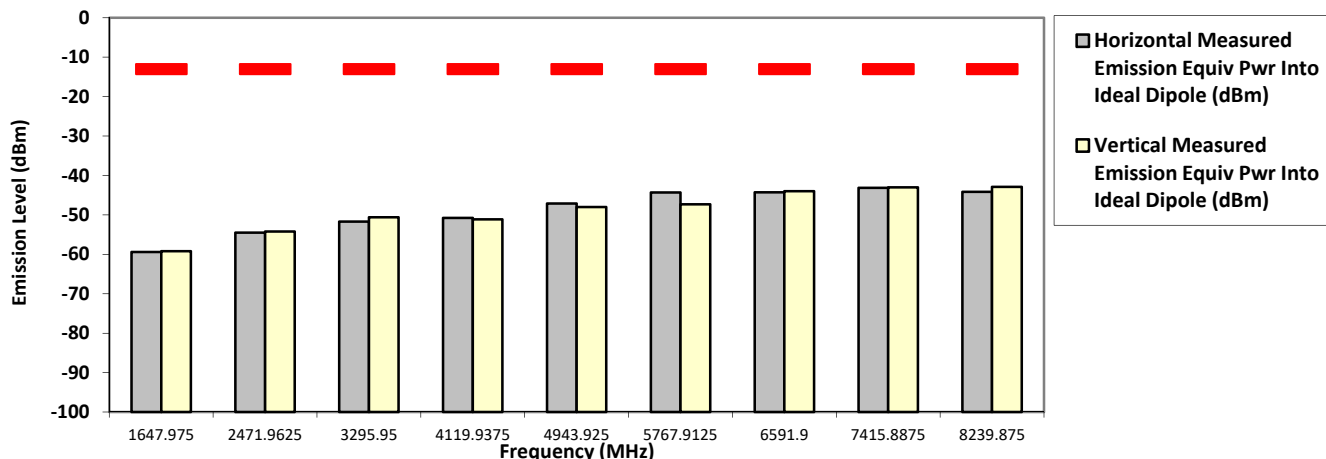

The data presented here was taken using the substitution method as found in the ANSI C63.26-2015 document.
 Motorola Penang EMC Lab - Test Performed by: Qawiman,Nazrin&Azil Sat, 5 Feb, 2022

Remarks: ** Indicates the spurious emission could not be detected due to noise limitations or ambient.
 *Pursuant to CFR 47 Part 2.1057 (c), emissions attenuated more than 20 dB below the permissible limit are not reported
 Temp(Deg): 23.3 Hum(%RH): 69.4

Remarks: Passed Results Marginal Results Failed Results

SAC Transmitter Radiated Emission:

Model Number: H25UCF9PW6AN

S/N: 657TYB0716

SR:26860-EMC-00073

Battery Part No: PMNN4813A

Accy Part No: NA

851.012500 MHz

Test Mode: TX Analog
 25 kHz

3.600 Watt(s) /Max Power

Frequency (MHz)	Limit	Horizontal Measured Emission Equiv Pwr Into Ideal Dipole (dBm)	Vertical Measured Emission Equiv Pwr Into ideal Dipole (dBm)
1702.0250	-13.0000	-59.5346 **	-59.2305 **
2553.0375	-13.0000	-53.7678 **	-53.6984 **
3404.0500	-13.0000	-51.3867 **	-52.1768 **
4255.0625	-13.0000	-50.5299 **	-49.4796 **
5106.0750	-13.0000	-47.3576 **	-46.8186 **
5957.0875	-13.0000	-46.2905 **	-45.8829 **
6808.1000	-13.0000	-44.2286 **	-44.1640 **
7659.1125	-13.0000	-43.0456 **	-41.7879 **
8510.1250	-13.0000	-42.8002 **	-43.3849 **

RADIATED SPURIOUS EMISSIONS

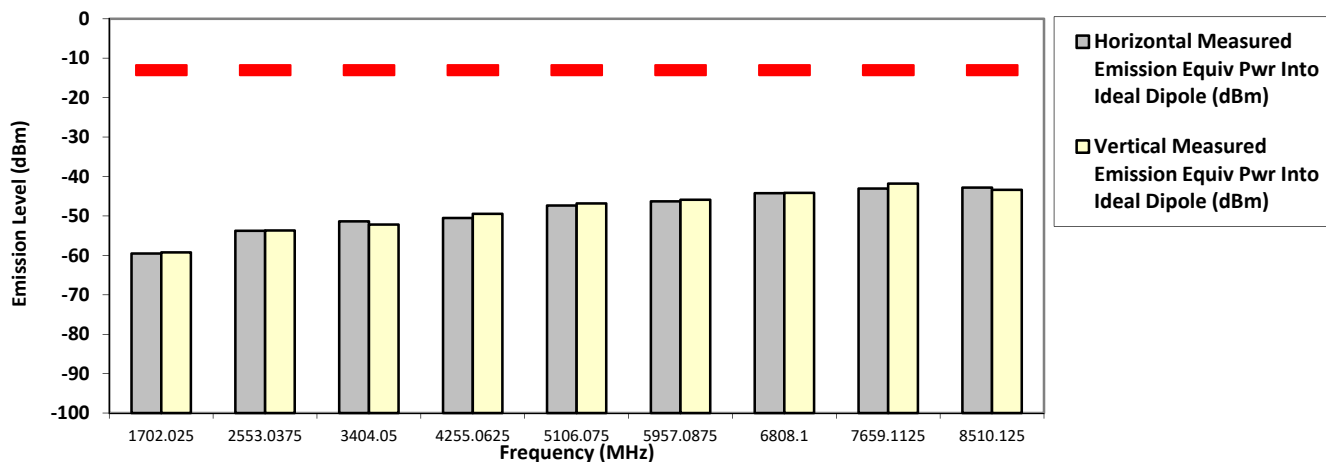

The data presented here was taken using the substitution method as found in the ANSI C63.26-2015 document.
 Motorola Penang EMC Lab - Test Performed by: Qawiman,Nazrin&Azil Sat, 5 Feb, 2022

Remarks: ** Indicates the spurious emission could not be detected due to noise limitations or ambient.

*Pursuant to CFR 47 Part 2.1057 (c), emissions attenuated more than 20 dB below the permissible limit are not reported
 Temp(Deg): 23.3 Hum(%RH): 69.4

Remarks:

Passed Results	Marginal Results	Failed Results
----------------	------------------	----------------

SAC Transmitter Radiated Emission:

Model Number: H25UCF9PW6AN

S/N: 657TYB0716

SR:26860-EMC-00073

Battery Part No: PMNN4813A

Accy Part No: NA

Test Mode: TX Analog
 25 kHz

860.012500 MHz

3.600 Watt(s) /Max Power

Frequency (MHz)	Limit	Horizontal Measured Emission Equiv Pwr Into Ideal Dipole (dBm)	Vertical Measured Emission Equiv Pwr Into ideal Dipole (dBm)
1720.0250	-13.0000	-55.5581 **	-56.3356 **
2580.0375	-13.0000	-53.2968 **	-54.1332 **
3440.0500	-13.0000	-52.0999 **	-52.0670 **
4300.0625	-13.0000	-50.1903 **	-49.7969 **
5160.0750	-13.0000	-46.9841 **	-46.2338 **
6020.0875	-13.0000	-46.0718 **	-45.7429 **
6880.1000	-13.0000	-43.5051 **	-44.4942 **
7740.1125	-13.0000	-42.7883 **	-43.3297 **
8600.1250	-13.0000	-40.8601 **	-42.2350 **

RADIATED SPURIOUS EMISSIONS

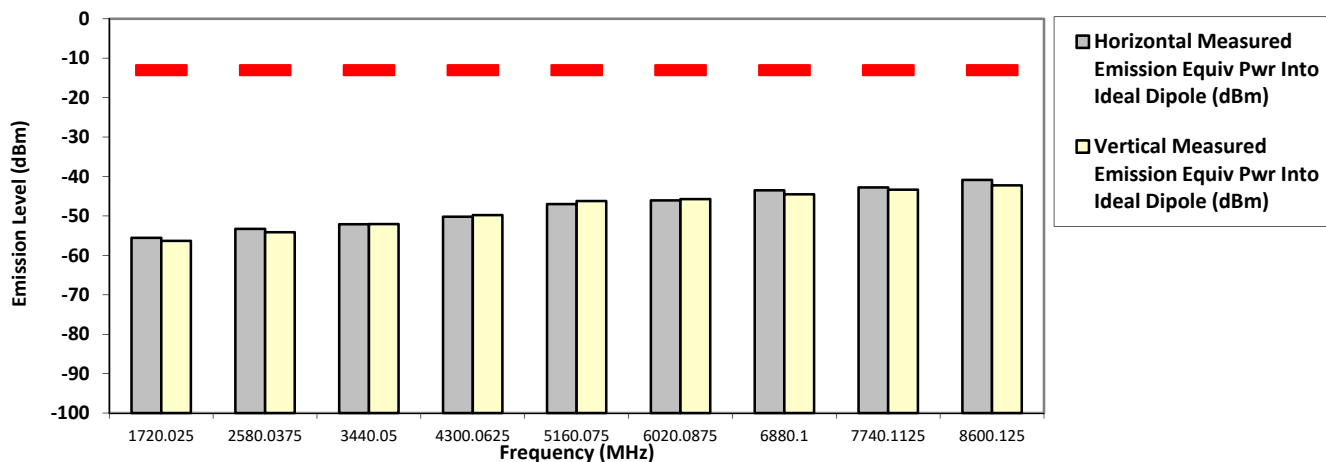

The data presented here was taken using the substitution method as found in the ANSI C63.26-2015 document.
 Motorola Penang EMC Lab - Test Performed by: Qawiman, Nazrin & Azil Sat, 5 Feb, 2022

Remarks: ** Indicates the spurious emission could not be detected due to noise limitations or ambient.

*Pursuant to CFR 47 Part 2.1057 (c), emissions attenuated more than 20 dB below the permissible limit are not reported
 Temp(Deg): 23.3 Hum(%RH): 69.4

Remarks:

Passed Results	Marginal Results	Failed Results
----------------	------------------	----------------

SAC Transmitter Radiated Emission:

Model Number: H25UCF9PW6AN

S/N: 657TYB0716

SR:26860-EMC-00073

Battery Part No: PMNN4813A

Accy Part No: NA

868.887500 MHz

Test Mode: TX Analog
 25 kHz

3.600 Watt(s) /Max Power

Frequency (MHz)	Limit	Horizontal Measured Emission Equiv Pwr Into Ideal Dipole (dBm)	Vertical Measured Emission Equiv Pwr Into ideal Dipole (dBm)
1737.7750	-13.0000	-54.4190 **	-56.5780 **
2606.6625	-13.0000	-52.8768 **	-53.3499 **
3475.5500	-13.0000	-52.4965 **	-51.6543 **
4344.4375	-13.0000	-50.4869 **	-50.4497 **
5213.3250	-13.0000	-45.9778 **	-47.8152 **
6082.2125	-13.0000	-46.3068 **	-45.1619 **
6951.1000	-13.0000	-44.2421 **	-42.9102 **
7819.9875	-13.0000	-43.0772 **	-43.0983 **
8688.8750	-13.0000	-41.7627 **	-42.0041 **

RADIATED SPURIOUS EMISSIONS

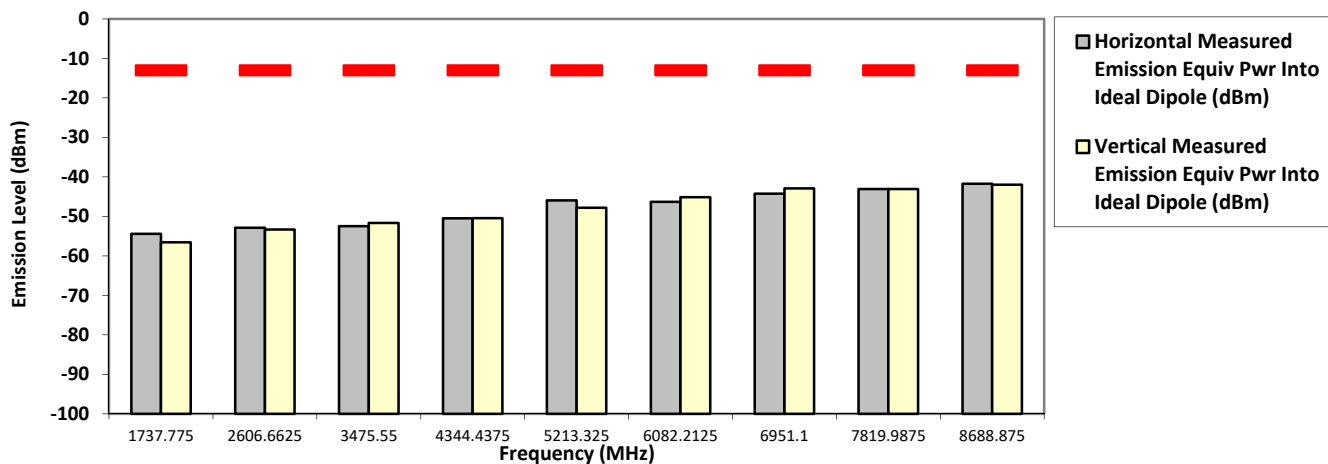

The data presented here was taken using the substitution method as found in the ANSI C63.26-2015 document.
 Motorola Penang EMC Lab - Test Performed by: Qawiman, Nazrin & Azil Sat, 5 Feb, 2022

Remarks: ** Indicates the spurious emission could not be detected due to noise limitations or ambient.
 *Pursuant to CFR 47 Part 2.1057 (c), emissions attenuated more than 20 dB below the permissible limit are not reported
 Temp(Deg): 23.3 Hum(%RH): 69.4

Remarks: Passed Results Marginal Results Failed Results

6.11.3. Test Result (Digital)

SAC Transmitter Radiated Emission:

Model Number: H25UCF9PW6AN S/N: 657TYB0463 SR:26860-EMC-00136
 Battery Part No: PMNN4813A Accy Part No: NA
 Test Mode: TX APCO Digital C4FM
 806.012500 MHz (For FCC only) 12.5 kHz 3.600 Watt(s) /Max Power

Frequency (MHz)	Limit	Horizontal Measured Emission Equip Pwr Into Ideal Dipole (dBm)	Vertical Measured Emission Equip Pwr Into ideal Dipole (dBm)
1612.0250	-13.0000	-59.2730 **	-59.6241 **
2418.0375	-13.0000	-54.2598 **	-54.3372 **
3224.0500	-13.0000	-50.3351 **	-51.5413 **
4030.0625	-13.0000	-49.5337 **	-50.0736 **
4836.0750	-13.0000	-48.0614 **	-47.3175 **
5642.0875	-13.0000	-47.8547 **	-46.8570 **
6448.1000	-13.0000	-45.1920 **	-45.8172 **
7254.1125	-13.0000	-42.4558 **	-41.9308 **
8060.1250	-13.0000	-42.8860 **	-42.8124 **

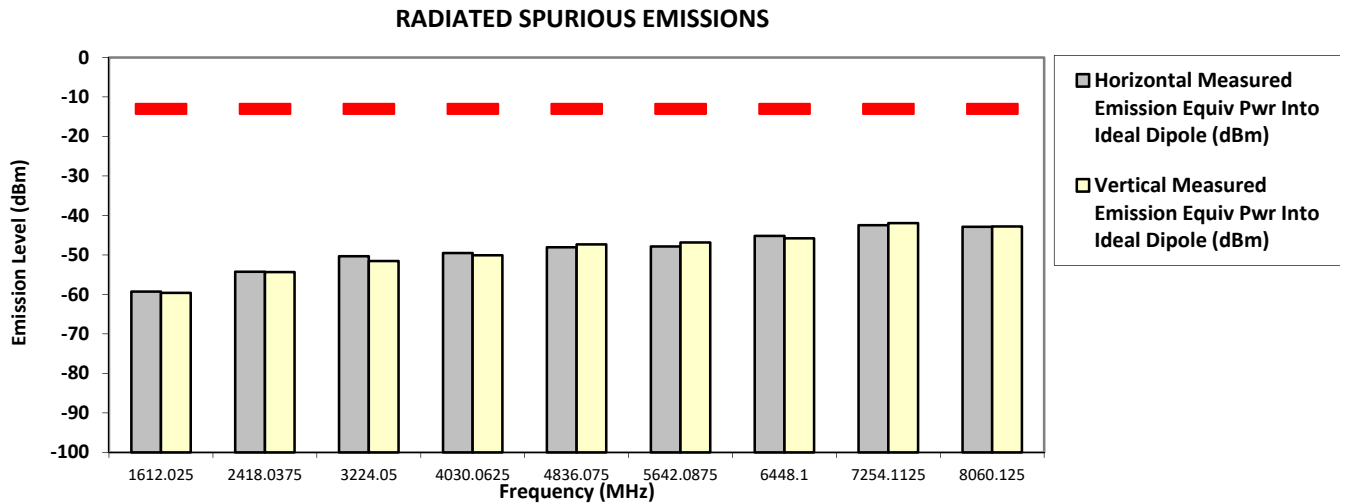

The data presented here was taken using the substitution method as found in the ANSI C63.26-2015 document.
 Motorola Penang EMC Lab - Test Performed by: Qawiman&Azil Fri, 18 Feb, 2022

Remarks: ** Indicates the spurious emission could not be detected due to noise limitations or ambient.
 *Pursuant to CFR 47 Part 2.1057 (c), emissions attenuated more than 20 dB below the permissible limit are not reported
 Temp(Deg): 22.1 Hum(%RH): 67.9

Remarks: Passed Results Marginal Results Failed Results

SAC Transmitter Radiated Emission:

Model Number: H25UCF9PW6AN **S/N: 657TYB0463** **SR:26860-EMC-00136**
Battery Part No: PMNN4813A **Accy Part No: NA**
Test Mode: TX APCO Digital C4FM
806.012500 MHz (For IC only) **12.5 kHz** **3.600 Watt(s) /Max Power**

Frequency (MHz)	Limit	Horizontal Measured Emission Equiv Pwr Into Ideal Dipole (dBm)	Vertical Measured Emission Equiv Pwr Into ideal Dipole (dBm)
1612.0250	-20.0000	-59.2730 **	-59.6241 **
2418.0375	-20.0000	-54.2598 **	-54.3372 **
3224.0500	-20.0000	-50.3351 **	-51.5413 **
4030.0625	-20.0000	-49.5337 **	-50.0736 **
4836.0750	-20.0000	-48.0614 **	-47.3175 **
5642.0875	-20.0000	-47.8547 **	-46.8570 **
6448.1000	-20.0000	-45.1920 **	-45.8172 **
7254.1125	-20.0000	-42.4558 **	-41.9308 **
8060.1250	-20.0000	-42.8860 **	-42.8124 **

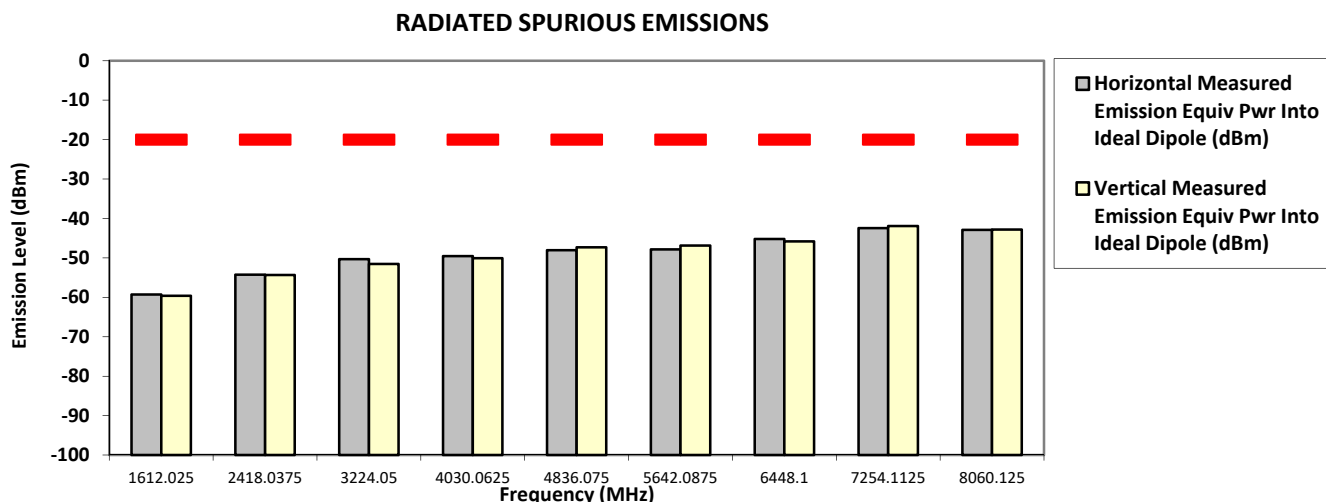

The data presented here was taken using the substitution method as found in the ANSI C63.26-2015 document.
 Motorola Penang EMC Lab - Test Performed by: Qawiman&Azil Fri, 18 Feb, 2022

Remarks: ** Indicates the spurious emission could not be detected due to noise limitations or ambient.
 *Pursuant to CFR 47 Part 2.1057 (c), emissions attenuated more than 20 dB below the permissible limit are not reported
 Temp(Deg): 22.1 Hum(%RH): 67.9

Remarks: Passed Results Marginal Results Failed Results

SAC Transmitter Radiated Emission:

Model Number: H25UCF9PW6AN **S/N: 657TYB0463** **SR:26860-EMC-00136**
Battery Part No: PMNN4813A **Accy Part No: NA**
Test Mode: TX APCO Digital C4FM
814.987500 MHz (For FCC only) **12.5 kHz** **3.600 Watt(s) /Max Power**

Frequency (MHz)	Limit	Horizontal Measured Emission Equiv Pwr Into Ideal Dipole (dBm)	Vertical Measured Emission Equiv Pwr Into ideal Dipole (dBm)
1629.9750	-13.0000	-59.1376 **	-58.8124 **
2444.9625	-13.0000	-53.7804 **	-54.5315 **
3259.9500	-13.0000	-51.0238 **	-51.1045 **
4074.9375	-13.0000	-50.5368 **	-49.9904 **
4889.9250	-13.0000	-48.1161 **	-47.9000 **
5704.9125	-13.0000	-47.8627 **	-47.7082 **
6519.9000	-13.0000	-45.9137 **	-44.2561 **
7334.8875	-13.0000	-43.7019 **	-42.9560 **
8149.8750	-13.0000	-41.9578 **	-42.3584 **

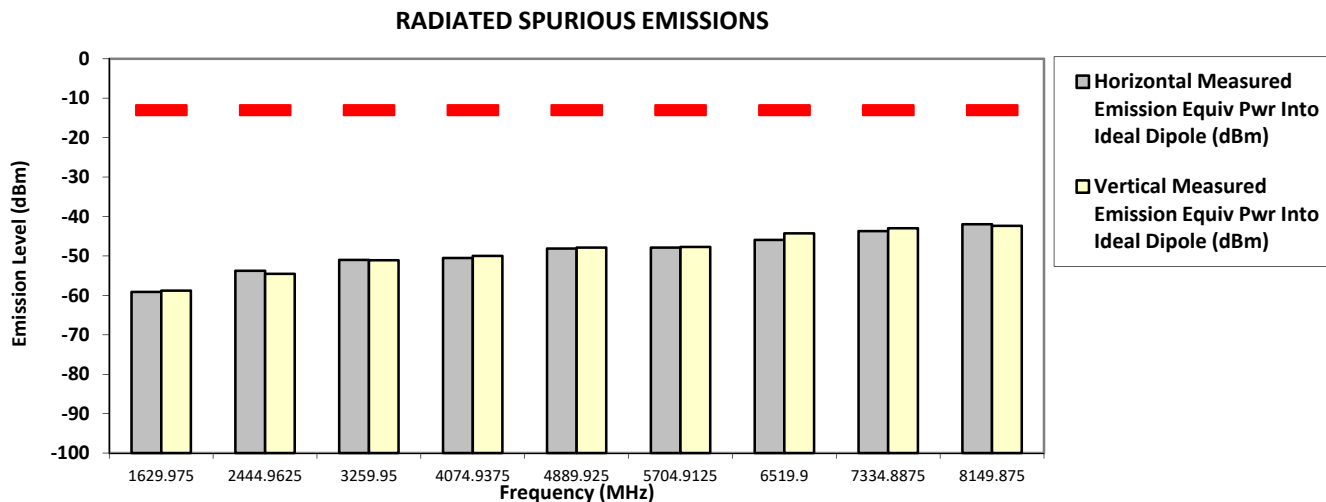

The data presented here was taken using the substitution method as found in the ANSI C63.26-2015 document.
 Motorola Penang EMC Lab - Test Performed by: Qawiman&Azil Fri, 18 Feb, 2022

Remarks: ** Indicates the spurious emission could not be detected due to noise limitations or ambient.
 *Pursuant to CFR 47 Part 2.1057 (c), emissions attenuated more than 20 dB below the permissible limit are not reported
 Temp(Deg): 22.1 Hum(%RH): 67.9

Remarks: Passed Results Marginal Results Failed Results

SAC Transmitter Radiated Emission:

Model Number: H25UCF9PW6AN **S/N: 657TYB0463** **SR:26860-EMC-00136**
Battery Part No: PMNN4813A **Accy Part No: NA**
Test Mode: TX APCO Digital C4FM
814.987500 MHz (For IC only) **12.5 kHz** **3.600 Watt(s) /Max Power**

Frequency (MHz)	Limit	Horizontal Measured Emission Equiv Pwr Into Ideal Dipole (dBm)	Vertical Measured Emission Equiv Pwr Into ideal Dipole (dBm)
1629.9750	-20.0000	-59.1376 **	-58.8124 **
2444.9625	-20.0000	-53.7804 **	-54.5315 **
3259.9500	-20.0000	-51.0238 **	-51.1045 **
4074.9375	-20.0000	-50.5368 **	-49.9904 **
4889.9250	-20.0000	-48.1161 **	-47.9000 **
5704.9125	-20.0000	-47.8627 **	-47.7082 **
6519.9000	-20.0000	-45.9137 **	-44.2561 **
7334.8875	-20.0000	-43.7019 **	-42.9560 **
8149.8750	-20.0000	-41.9578 **	-42.3584 **

RADIATED SPURIOUS EMISSIONS

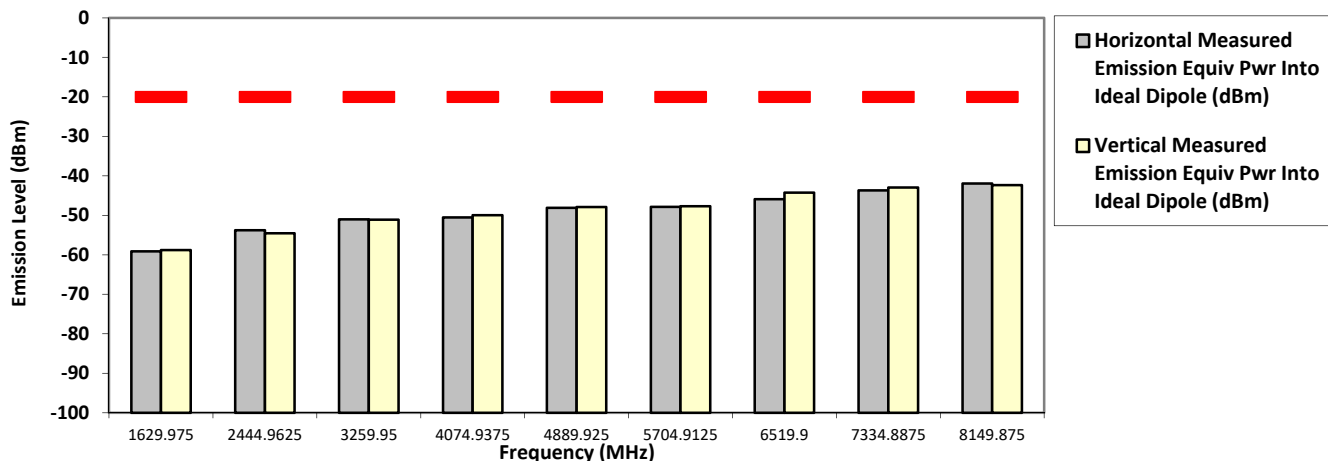

The data presented here was taken using the substitution method as found in the ANSI C63.26-2015 document.
 Motorola Penang EMC Lab - Test Performed by: Qawiman&Azil Fri, 18 Feb, 2022

Remarks: ** Indicates the spurious emission could not be detected due to noise limitations or ambient.
 *Pursuant to CFR 47 Part 2.1057 (c), emissions attenuated more than 20 dB below the permissible limit are not reported
 Temp(Deg): 22.1 Hum(%RH): 67.9

Remarks: Passed Results Marginal Results Failed Results

SAC Transmitter Radiated Emission:

Model Number: H25UCF9PW6AN S/N: 657TYB0463 SR:26860-EMC-00136
 Battery Part No: PMNN4813A Accy Part No: NA
 Test Mode: TX APCO Digital C4FM
 823.987500 MHz (For FCC only) 12.5 kHz 3.600 Watt(s) /Max Power

Frequency (MHz)	Limit	Horizontal Measured Emission Equiv Pwr Into Ideal Dipole (dBm)	Vertical Measured Emission Equiv Pwr Into ideal Dipole (dBm)
1647.9750	-13.0000	-59.4928 **	-57.1940 **
2471.9625	-13.0000	-54.6999 **	-54.1126 **
3295.9500	-13.0000	-51.3809 **	-51.3645 **
4119.9375	-13.0000	-50.6749 **	-50.5047 **
4943.9250	-13.0000	-47.1824 **	-48.0694 **
5767.9125	-13.0000	-46.3069 **	-46.4731 **
6591.9000	-13.0000	-43.7538 **	-44.9634 **
7415.8875	-13.0000	-43.3904 **	-43.7818 **
8239.8750	-13.0000	-43.8868 **	-42.9371 **

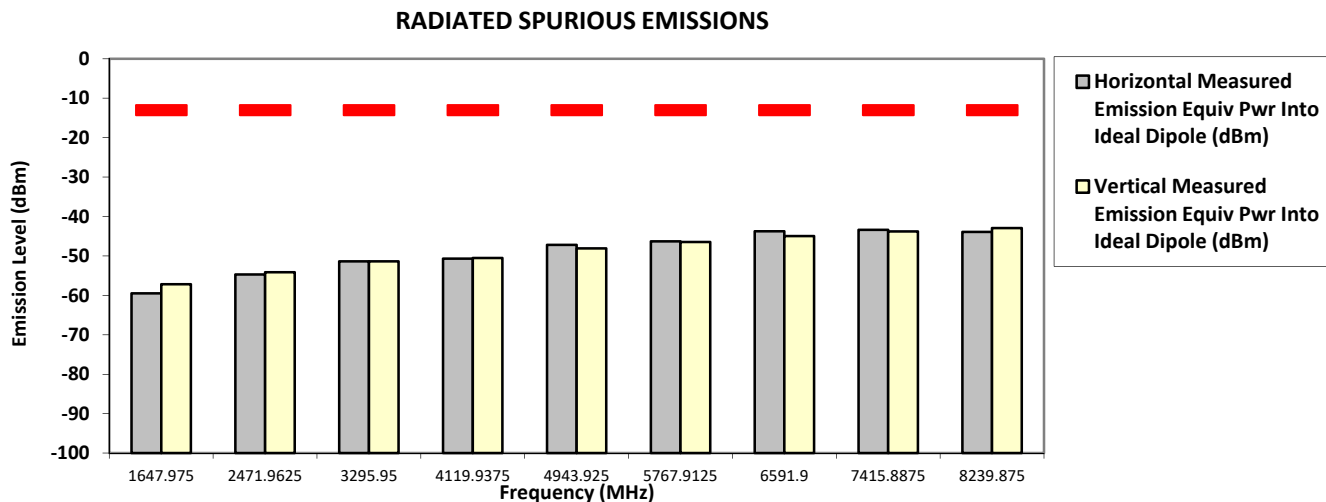

The data presented here was taken using the substitution method as found in the ANSI C63.26-2015 document.
 Motorola Penang EMC Lab - Test Performed by: Qawiman&Azil Fri, 18 Feb, 2022

Remarks: ** Indicates the spurious emission could not be detected due to noise limitations or ambient.
 *Pursuant to CFR 47 Part 2.1057 (c), emissions attenuated more than 20 dB below the permissible limit are not reported
 Temp(Deg): 22.1 Hum(%RH): 67.9

Remarks: Passed Results Marginal Results Failed Results

SAC Transmitter Radiated Emission:

Model Number: H25UCF9PW6AN **S/N: 657TYB0463** **SR:26860-EMC-00136**
Battery Part No: PMNN4813A **Accy Part No: NA**
Test Mode: TX APCO Digital C4FM
823.987500 MHz (For IC only) **12.5 kHz** **3.600 Watt(s) /Max Power**

Frequency (MHz)	Limit	Horizontal Measured Emission Equiv Pwr Into Ideal Dipole (dBm)	Vertical Measured Emission Equiv Pwr Into ideal Dipole (dBm)
1647.9750	-20.0000	-59.4928 **	-57.1940 **
2471.9625	-20.0000	-54.6999 **	-54.1126 **
3295.9500	-20.0000	-51.3809 **	-51.3645 **
4119.9375	-20.0000	-50.6749 **	-50.5047 **
4943.9250	-20.0000	-47.1824 **	-48.0694 **
5767.9125	-20.0000	-46.3069 **	-46.4731 **
6591.9000	-20.0000	-43.7538 **	-44.9634 **
7415.8875	-20.0000	-43.3904 **	-43.7818 **
8239.8750	-20.0000	-43.8868 **	-42.9371 **

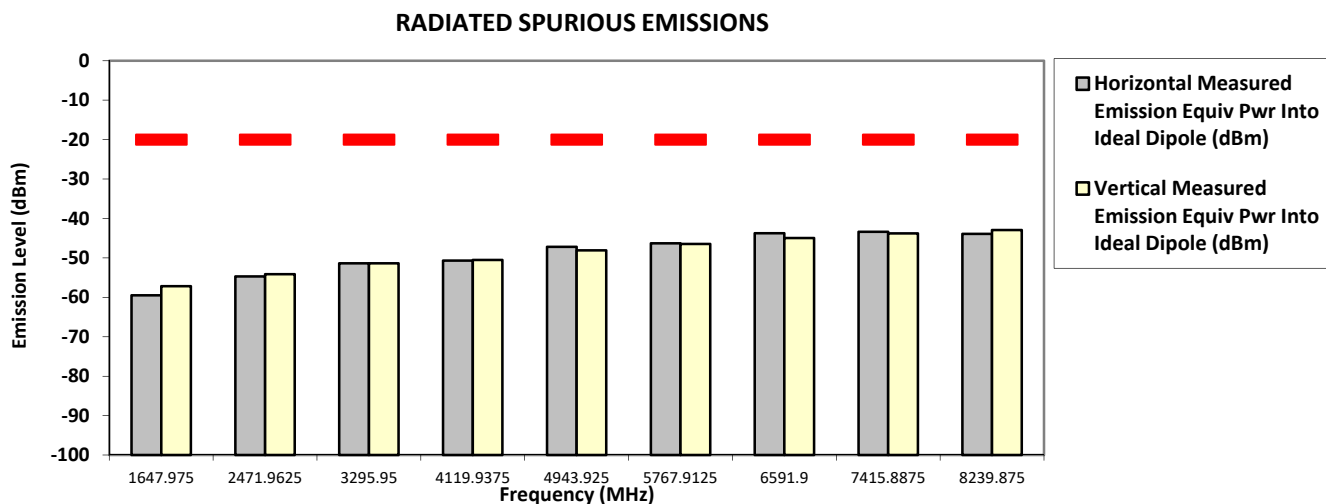

The data presented here was taken using the substitution method as found in the ANSI C63.26-2015 document.
 Motorola Penang EMC Lab - Test Performed by: Qawiman&Azil Fri, 18 Feb, 2022

Remarks: ** Indicates the spurious emission could not be detected due to noise limitations or ambient.
 *Pursuant to CFR 47 Part 2.1057 (c), emissions attenuated more than 20 dB below the permissible limit are not reported
 Temp(Deg): 22.1 Hum(%RH): 67.9

Remarks: Passed Results Marginal Results Failed Results

SAC Transmitter Radiated Emission:

Model Number: H25UCF9PW6AN S/N: 657TYB0463 SR:26860-EMC-00136
 Battery Part No: PMNN4813A Accy Part No: NA
 Test Mode: TX APCO Digital C4FM
 851.012500 MHz (For FCC only) 12.5 kHz 3.600 Watt(s) /Max Power

Frequency (MHz)	Limit	Horizontal Measured Emission Equiv Pwr Into Ideal Dipole (dBm)	Vertical Measured Emission Equiv Pwr Into ideal Dipole (dBm)
1702.0250	-13.0000	-59.3527 **	-59.6126 **
2553.0375	-13.0000	-54.0526 **	-54.3357 **
3404.0500	-13.0000	-52.0619 **	-52.2725 **
4255.0625	-13.0000	-49.9804 **	-50.1351 **
5106.0750	-13.0000	-47.8072 **	-45.7143 **
5957.0875	-13.0000	-45.7148 **	-45.8412 **
6808.1000	-13.0000	-44.8546 **	-44.7859 **
7659.1125	-13.0000	-41.7123 **	-43.3251 **
8510.1250	-13.0000	-41.2520 **	-41.1041 **

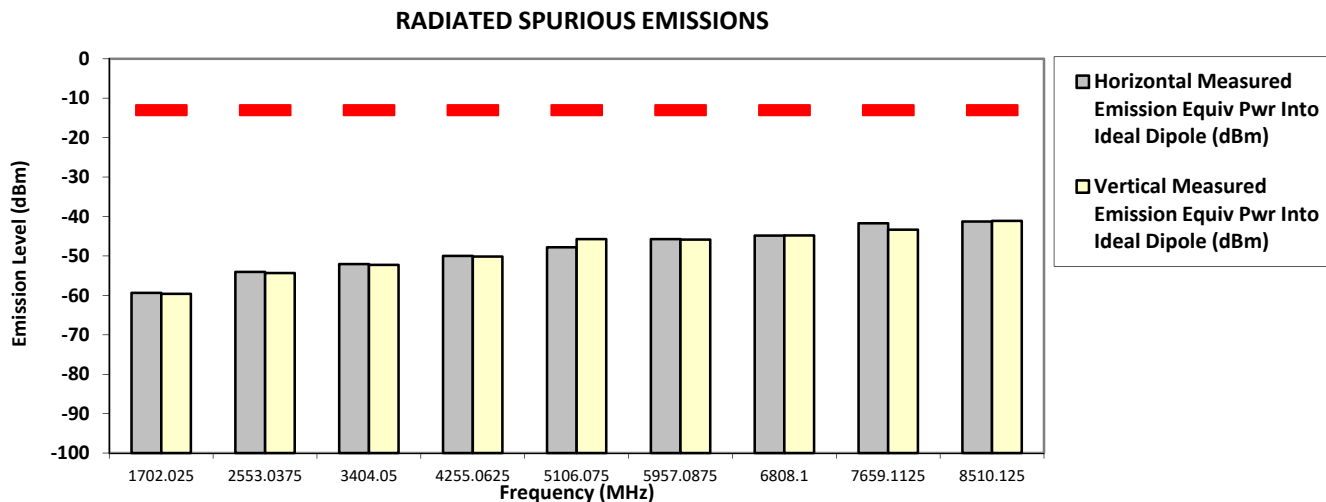

The data presented here was taken using the substitution method as found in the ANSI C63.26-2015 document.
 Motorola Penang EMC Lab - Test Performed by: Qawiman&Azil Fri, 18 Feb, 2022

Remarks: ** Indicates the spurious emission could not be detected due to noise limitations or ambient.
 *Pursuant to CFR 47 Part 2.1057 (c), emissions attenuated more than 20 dB below the permissible limit are not reported
 Temp(Deg): 22.1 Hum(%RH): 67.9

Remarks: Passed Results Marginal Results Failed Results

SAC Transmitter Radiated Emission:

Model Number: H25UCF9PW6AN **S/N: 657TYB0463** **SR:26860-EMC-00136**
Battery Part No: PMNN4813A **Accy Part No: NA**
Test Mode: TX APCO Digital C4FM
851.012500 MHz (For IC only) **12.5 kHz** **3.600 Watt(s) /Max Power**

Frequency (MHz)	Limit	Horizontal Measured Emission Equip Pwr Into Ideal Dipole (dBm)	Vertical Measured Emission Equip Pwr Into ideal Dipole (dBm)
1702.0250	-20.0000	-59.3527 **	-59.6126 **
2553.0375	-20.0000	-54.0526 **	-54.3357 **
3404.0500	-20.0000	-52.0619 **	-52.2725 **
4255.0625	-20.0000	-49.9804 **	-50.1351 **
5106.0750	-20.0000	-47.8072 **	-45.7143 **
5957.0875	-20.0000	-45.7148 **	-45.8412 **
6808.1000	-20.0000	-44.8546 **	-44.7859 **
7659.1125	-20.0000	-41.7123 **	-43.3251 **
8510.1250	-20.0000	-41.2520 **	-41.1041 **

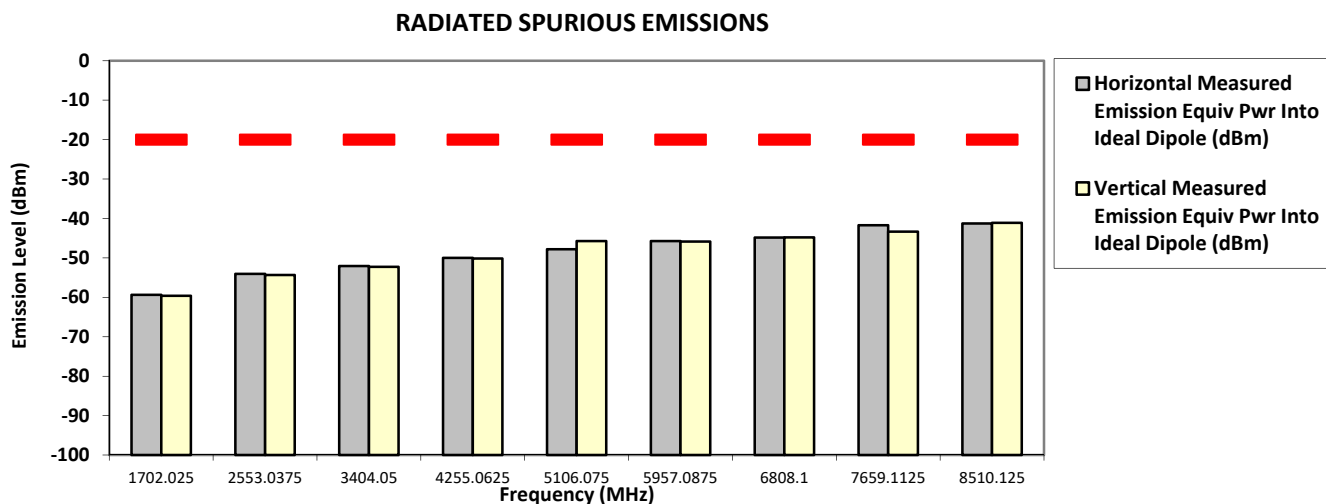

The data presented here was taken using the substitution method as found in the ANSI C63.26-2015 document.
 Motorola Penang EMC Lab - Test Performed by: Qawiman&Azil Fri, 18 Feb, 2022

Remarks: ** Indicates the spurious emission could not be detected due to noise limitations or ambient.
 *Pursuant to CFR 47 Part 2.1057 (c), emissions attenuated more than 20 dB below the permissible limit are not reported
 Temp(Deg): 22.1 Hum(%RH): 67.9

Remarks: Passed Results Marginal Results Failed Results

SAC Transmitter Radiated Emission:

Model Number: H25UCF9PW6AN **S/N: 657TYB0463** **SR:26860-EMC-00136**
Battery Part No: PMNN4813A **Accy Part No: NA**
Test Mode: TX APCO Digital C4FM
860.012500 MHz (For FCC only) **12.5 kHz** **3.600 Watt(s) /Max Power**

Frequency (MHz)	Limit	Horizontal Measured Emission Equiv Pwr Into Ideal Dipole (dBm)	Vertical Measured Emission Equiv Pwr Into ideal Dipole (dBm)
1720.0250	-13.0000	-59.2092 **	-59.3250 **
2580.0375	-13.0000	-54.0378 **	-53.2134 **
3440.0500	-13.0000	-51.7810 **	-52.6474 **
4300.0625	-13.0000	-48.9971 **	-48.5750 **
5160.0750	-13.0000	-47.2547 **	-47.5456 **
6020.0875	-13.0000	-46.4003 **	-45.2387 **
6880.1000	-13.0000	-43.2378 **	-43.5569 **
7740.1125	-13.0000	-43.2970 **	-42.9697 **
8600.1250	-13.0000	-40.1788 **	-42.6121 **

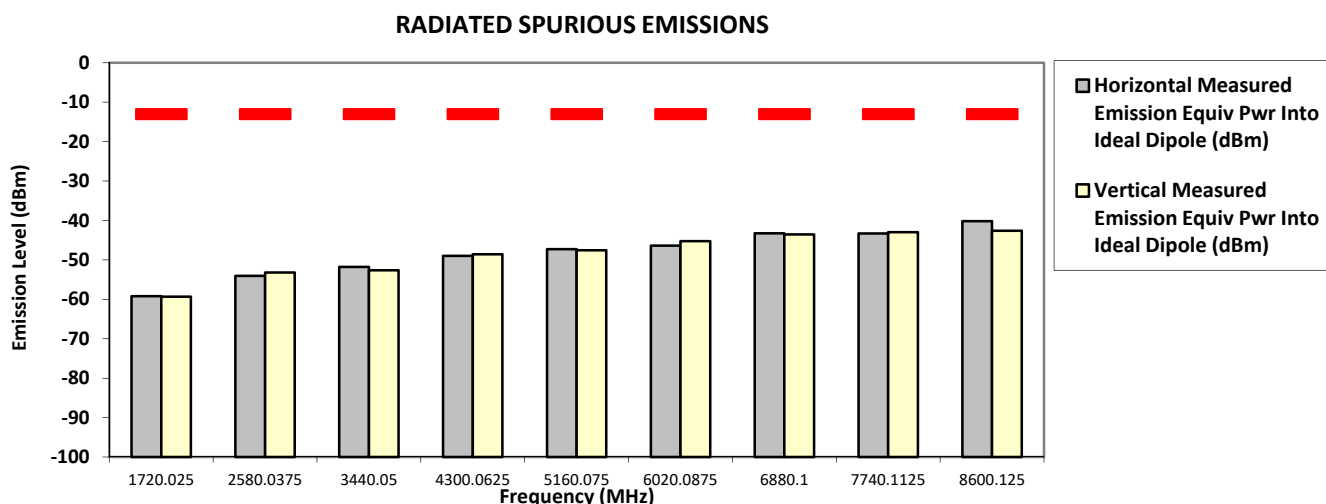

The data presented here was taken using the substitution method as found in the ANSI C63.26-2015 document.
 Motorola Penang EMC Lab - Test Performed by: Qawiman&Azil Fri, 18 Feb, 2022

Remarks: ** Indicates the spurious emission could not be detected due to noise limitations or ambient.
 *Pursuant to CFR 47 Part 2.1057 (c), emissions attenuated more than 20 dB below the permissible limit are not reported
 Temp(Deg): 22.1 Hum(%RH): 67.9

Remarks: Passed Results Marginal Results Failed Results

SAC Transmitter Radiated Emission:

Model Number: H25UCF9PW6AN S/N: 657TYB0463 SR:26860-EMC-00136
 Battery Part No: PMNN4813A Accy Part No: NA
 Test Mode: TX APCO Digital C4FM
 860.012500 MHz (For IC only) 12.5 kHz 3.600 Watt(s) /Max Power

Frequency (MHz)	Limit	Horizontal Measured Emission Equiv Pwr Into Ideal Dipole (dBm)	Vertical Measured Emission Equiv Pwr Into ideal Dipole (dBm)
1720.0250	-20.0000	-59.2092 **	-59.3250 **
2580.0375	-20.0000	-54.0378 **	-53.2134 **
3440.0500	-20.0000	-51.7810 **	-52.6474 **
4300.0625	-20.0000	-48.9971 **	-48.5750 **
5160.0750	-20.0000	-47.2547 **	-47.5456 **
6020.0875	-20.0000	-46.4003 **	-45.2387 **
6880.1000	-20.0000	-43.2378 **	-43.5569 **
7740.1125	-20.0000	-43.2970 **	-42.9697 **
8600.1250	-20.0000	-40.1788 **	-42.6121 **

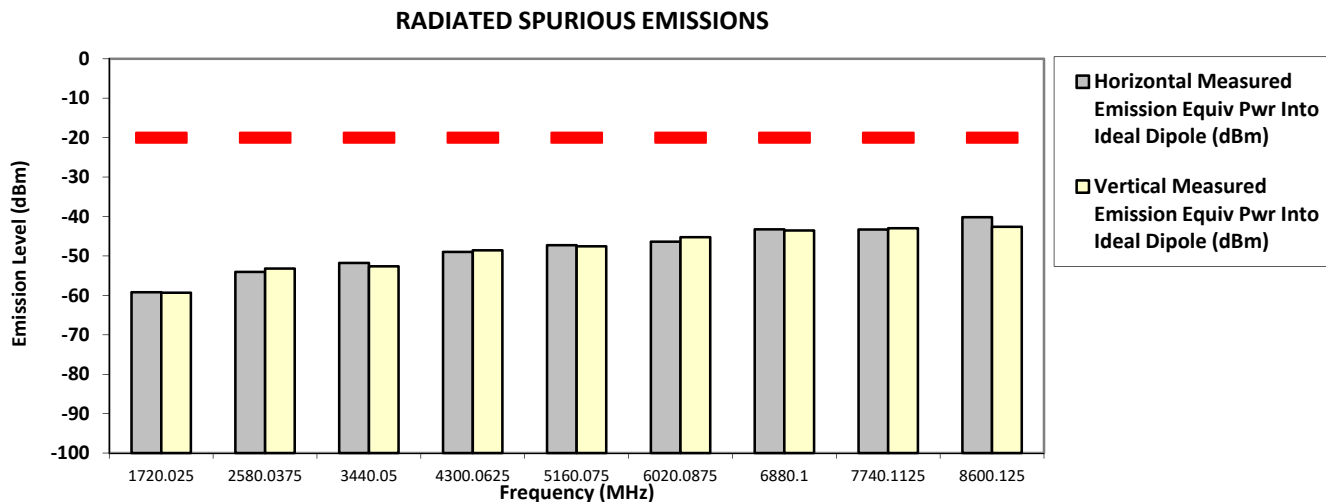

The data presented here was taken using the substitution method as found in the ANSI C63.26-2015 document.
 Motorola Penang EMC Lab - Test Performed by: Qawiman&Azil Fri, 18 Feb, 2022

Remarks: ** Indicates the spurious emission could not be detected due to noise limitations or ambient.
 *Pursuant to CFR 47 Part 2.1057 (c), emissions attenuated more than 20 dB below the permissible limit are not reported
 Temp(Deg): 22.1 Hum(%RH): 67.9

Remarks: Passed Results Marginal Results Failed Results

SAC Transmitter Radiated Emission:

Model Number: H25UCF9PW6AN **S/N: 657TYB0463** **SR:26860-EMC-00136**
Battery Part No: PMNN4813A **Accy Part No: NA**
Test Mode: TX APCO Digital C4FM
868.887500 MHz (For FCC only) **12.5 kHz** **3.600 Watt(s) /Max Power**

Frequency (MHz)	Limit	Horizontal Measured Emission Equiv Pwr Into Ideal Dipole (dBm)	Vertical Measured Emission Equiv Pwr Into ideal Dipole (dBm)
1737.7750	-13.0000	-56.6300 **	-57.2458 **
2606.6625	-13.0000	-53.4930 **	-53.2629 **
3475.5500	-13.0000	-52.0787 **	-52.2372 **
4344.4375	-13.0000	-49.6915 **	-50.4229 **
5213.3250	-13.0000	-47.6014 **	-47.5300 **
6082.2125	-13.0000	-45.3338 **	-45.8338 **
6951.1000	-13.0000	-44.3334 **	-44.1020 **
7819.9875	-13.0000	-41.5861 **	-43.1001 **
8688.8750	-13.0000	-42.6945 **	-41.7805 **

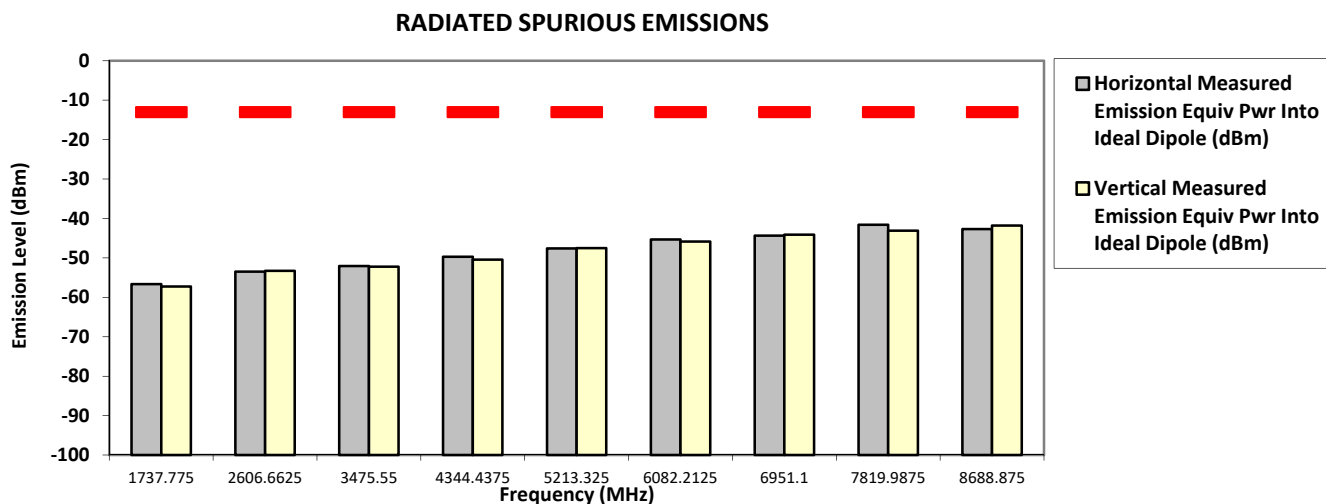

The data presented here was taken using the substitution method as found in the ANSI C63.26-2015 document.
 Motorola Penang EMC Lab - Test Performed by: Qawiman&Azil Fri, 18 Feb, 2022

Remarks: ** Indicates the spurious emission could not be detected due to noise limitations or ambient.
 *Pursuant to CFR 47 Part 2.1057 (c), emissions attenuated more than 20 dB below the permissible limit are not reported
 Temp(Deg): 22.1 Hum(%RH): 67.9

Remarks: Passed Results Marginal Results Failed Results

SAC Transmitter Radiated Emission:

Model Number: H25UCF9PW6AN **S/N: 657TYB0463** **SR:26860-EMC-00136**
Battery Part No: PMNN4813A **Accy Part No: NA**
Test Mode: TX APCO Digital C4FM
868.887500 MHz (For IC only) **12.5 kHz** **3.600 Watt(s) /Max Power**

Frequency (MHz)	Limit	Horizontal Measured Emission Equiv Pwr Into Ideal Dipole (dBm)	Vertical Measured Emission Equiv Pwr Into ideal Dipole (dBm)
1737.7750	-20.0000	-56.6300 **	-57.2458 **
2606.6625	-20.0000	-53.4930 **	-53.2629 **
3475.5500	-20.0000	-52.0787 **	-52.2372 **
4344.4375	-20.0000	-49.6915 **	-50.4229 **
5213.3250	-20.0000	-47.6014 **	-47.5300 **
6082.2125	-20.0000	-45.3338 **	-45.8338 **
6951.1000	-20.0000	-44.3334 **	-44.1020 **
7819.9875	-20.0000	-41.5861 **	-43.1001 **
8688.8750	-20.0000	-42.6945 **	-41.7805 **

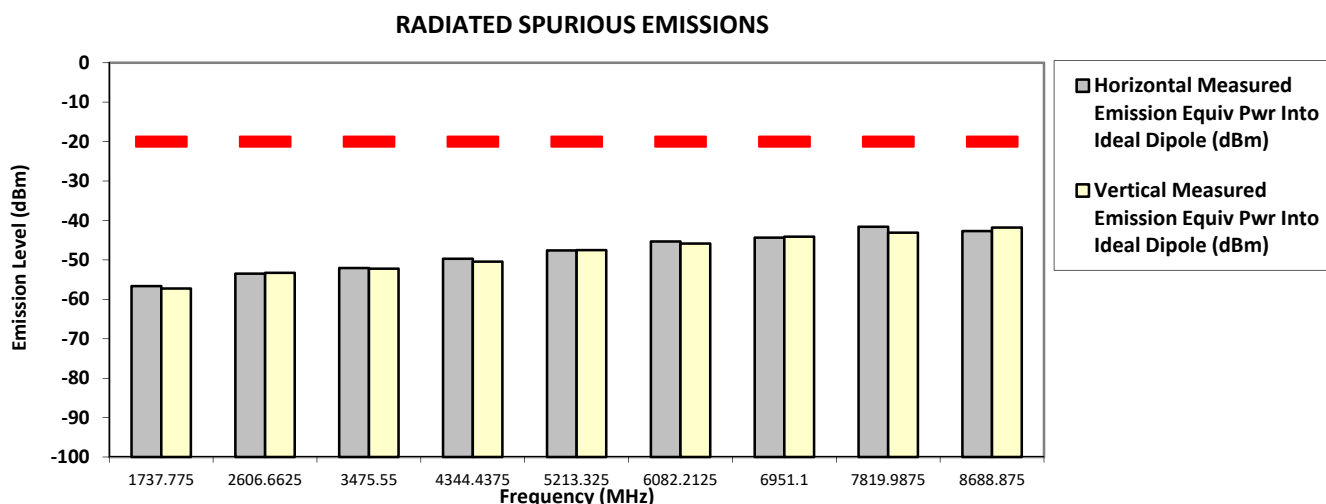

The data presented here was taken using the substitution method as found in the ANSI C63.26-2015 document.
 Motorola Penang EMC Lab - Test Performed by: Qawiman&Azil Fri, 18 Feb, 2022

Remarks: ** Indicates the spurious emission could not be detected due to noise limitations or ambient.
 *Pursuant to CFR 47 Part 2.1057 (c), emissions attenuated more than 20 dB below the permissible limit are not reported
 Temp(Deg): 22.1 Hum(%RH): 67.9

Remarks: Passed Results Marginal Results Failed Results

SAC Transmitter Radiated Emission:

Model Number: H25UCF9PW6AN **S/N: 657TYB0716** **SR:26860-EMC-00073**
Battery Part No: PMNN4813A **Accy Part No: NA**
Test Mode: TX APCO Digital Phase II
806.012500 MHz (For FCC only) **12.5 kHz** **3.600 Watt(s) /Max Power**

Frequency (MHz)	Limit	Horizontal Measured Emission Equiv Pwr Into Ideal Dipole (dBm)	Vertical Measured Emission Equiv Pwr Into ideal Dipole (dBm)
1612.0250	-13.0000	-58.4959 **	-58.6575 **
2418.0375	-13.0000	-54.8489 **	-54.8239 **
3224.0500	-13.0000	-50.7621 **	-51.0926 **
4030.0625	-13.0000	-51.3257 **	-49.4138 **
4836.0750	-13.0000	-47.6185 **	-48.6675 **
5642.0875	-13.0000	-47.2576 **	-47.9189 **
6448.1000	-13.0000	-45.4092 **	-46.5893 **
7254.1125	-13.0000	-43.1317 **	-43.4792 **
8060.1250	-13.0000	-42.9235 **	-42.5663 **

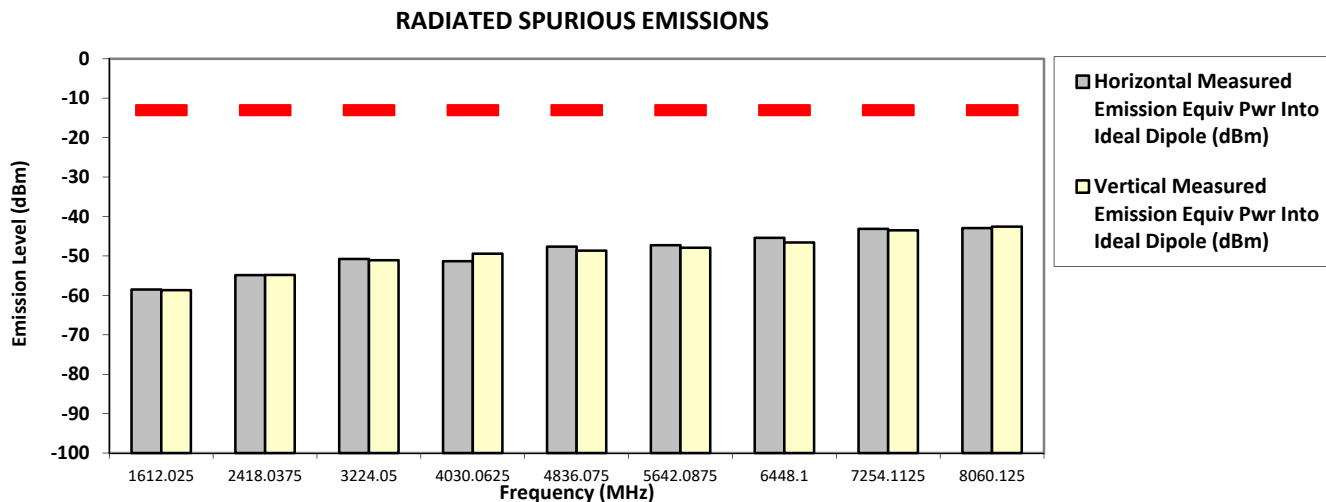

The data presented here was taken using the substitution method as found in the ANSI C63.26-2015 document.
 Motorola Penang EMC Lab - Test Performed by: Qawiman,Nazrin&Azil Sat, 5 Feb, 2022

Remarks: ** Indicates the spurious emission could not be detected due to noise limitations or ambient.
 *Pursuant to CFR 47 Part 2.1057 (c), emissions attenuated more than 20 dB below the permissible limit are not reported
 Temp(Deg): 23.3 Hum(%RH): 69.4

Remarks: Passed Results Marginal Results Failed Results

SAC Transmitter Radiated Emission:

Model Number: H25UCF9PW6AN **S/N: 657TYB0716** **SR:26860-EMC-00073**
Battery Part No: PMNN4813A **Accy Part No: NA**
Test Mode: TX APCO Digital Phase II
806.012500 MHz (For IC only) **12.5 kHz** **3.600 Watt(s) /Max Power**

Frequency (MHz)	Limit	Horizontal Measured Emission Equiv Pwr Into Ideal Dipole (dBm)	Vertical Measured Emission Equiv Pwr Into ideal Dipole (dBm)
1612.0250	-20.0000	-58.4959 **	-58.6575 **
2418.0375	-20.0000	-54.8489 **	-54.8239 **
3224.0500	-20.0000	-50.7621 **	-51.0926 **
4030.0625	-20.0000	-51.3257 **	-49.4138 **
4836.0750	-20.0000	-47.6185 **	-48.6675 **
5642.0875	-20.0000	-47.2576 **	-47.9189 **
6448.1000	-20.0000	-45.4092 **	-46.5893 **
7254.1125	-20.0000	-43.1317 **	-43.4792 **
8060.1250	-20.0000	-42.9235 **	-42.5663 **

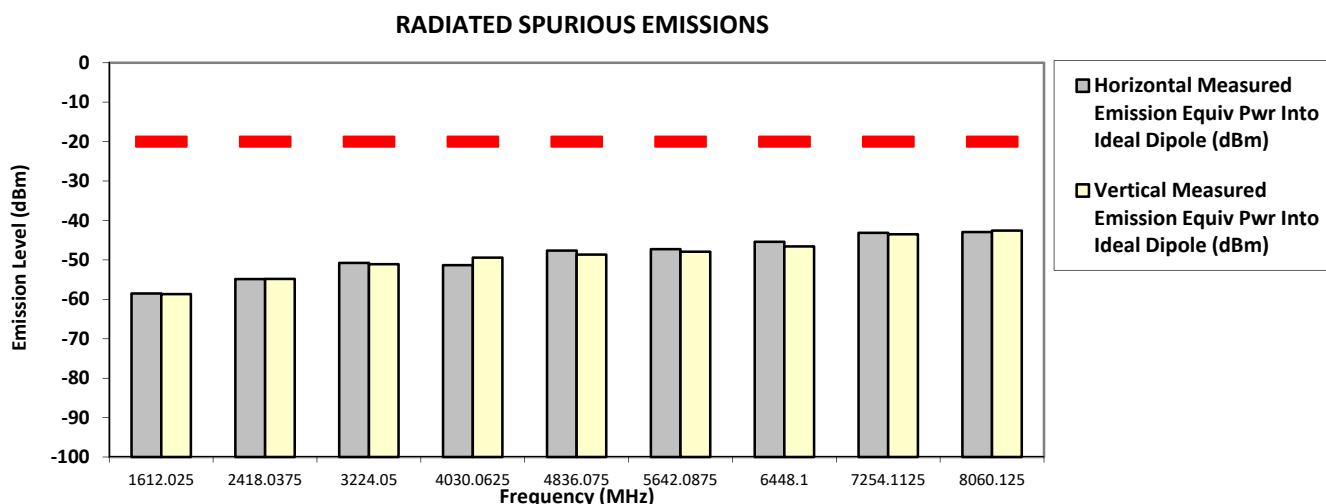

The data presented here was taken using the substitution method as found in the ANSI C63.26-2015 document.
 Motorola Penang EMC Lab - Test Performed by: Qawiman, Nazrin & Azil Sat, 5 Feb, 2022

Remarks: ** Indicates the spurious emission could not be detected due to noise limitations or ambient.
 *Pursuant to CFR 47 Part 2.1057 (c), emissions attenuated more than 20 dB below the permissible limit are not reported
 Temp(Deg): 23.3 Hum(%RH): 69.4

Remarks: Passed Results Marginal Results Failed Results

SAC Transmitter Radiated Emission:

Model Number: H25UCF9PW6AN **S/N: 657TYB0716** **SR:26860-EMC-00073**
Battery Part No: PMNN4813A **Accy Part No: NA**
Test Mode: TX APCO Digital Phase II
814.987500 MHz (For FCC only) **12.5 kHz** **3.600 Watt(s) /Max Power**

Frequency (MHz)	Limit	Horizontal Measured Emission Equiv Pwr Into Ideal Dipole (dBm)	Vertical Measured Emission Equiv Pwr Into ideal Dipole (dBm)
1629.9750	-13.0000	-59.0289 **	-58.7053 **
2444.9625	-13.0000	-54.7070 **	-54.6155 **
3259.9500	-13.0000	-51.9354 **	-51.3187 **
4074.9375	-13.0000	-51.8726 **	-50.4107 **
4889.9250	-13.0000	-48.0266 **	-46.7818 **
5704.9125	-13.0000	-47.0845 **	-47.5879 **
6519.9000	-13.0000	-45.0802 **	-44.9993 **
7334.8875	-13.0000	-43.7649 **	-43.8895 **
8149.8750	-13.0000	-43.0133 **	-42.2256 **

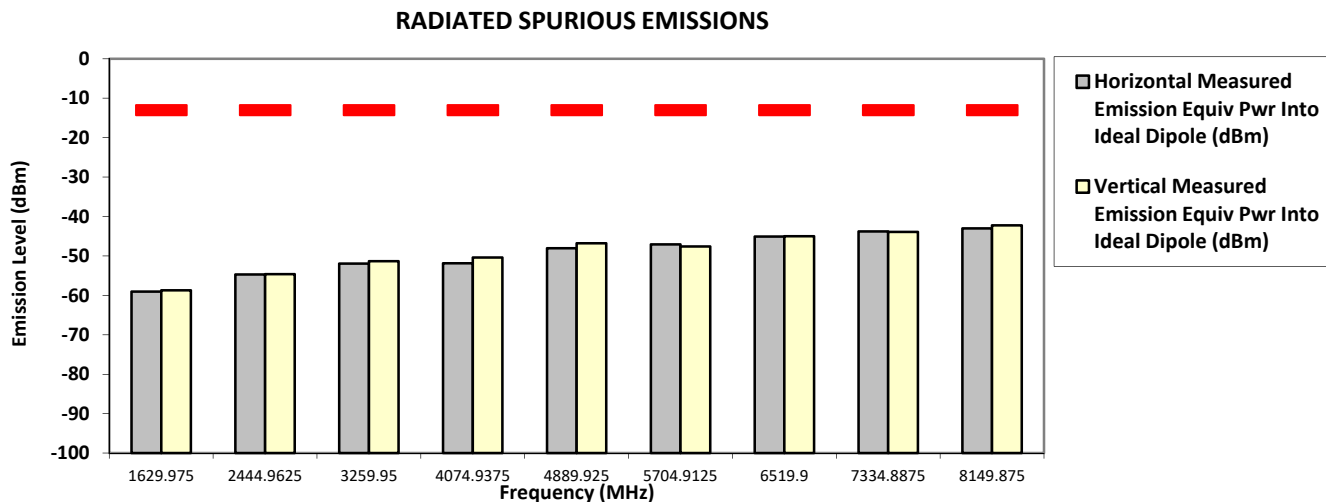

The data presented here was taken using the substitution method as found in the ANSI C63.26-2015 document.
 Motorola Penang EMC Lab - Test Performed by: Qawiman, Nazrin & Azil Sat, 5 Feb, 2022

Remarks: ** Indicates the spurious emission could not be detected due to noise limitations or ambient.
 *Pursuant to CFR 47 Part 2.1057 (c), emissions attenuated more than 20 dB below the permissible limit are not reported
 Temp(Deg): 23.3 Hum(%RH): 69.4

Remarks: Passed Results Marginal Results Failed Results

SAC Transmitter Radiated Emission:

Model Number: H25UCF9PW6AN **S/N: 657TYB0716** **SR:26860-EMC-00073**
Battery Part No: PMNN4813A **Accy Part No: NA**
Test Mode: TX APCO Digital Phase II
814.987500 MHz (For IC only) **12.5 kHz** **3.600 Watt(s) /Max Power**

Frequency (MHz)	Limit	Horizontal Measured Emission Equiv Pwr Into Ideal Dipole (dBm)	Vertical Measured Emission Equiv Pwr Into ideal Dipole (dBm)
1629.9750	-20.0000	-59.0289 **	-58.7053 **
2444.9625	-20.0000	-54.7070 **	-54.6155 **
3259.9500	-20.0000	-51.9354 **	-51.3187 **
4074.9375	-20.0000	-51.8726 **	-50.4107 **
4889.9250	-20.0000	-48.0266 **	-46.7818 **
5704.9125	-20.0000	-47.0845 **	-47.5879 **
6519.9000	-20.0000	-45.0802 **	-44.9993 **
7334.8875	-20.0000	-43.7649 **	-43.8895 **
8149.8750	-20.0000	-43.0133 **	-42.2256 **

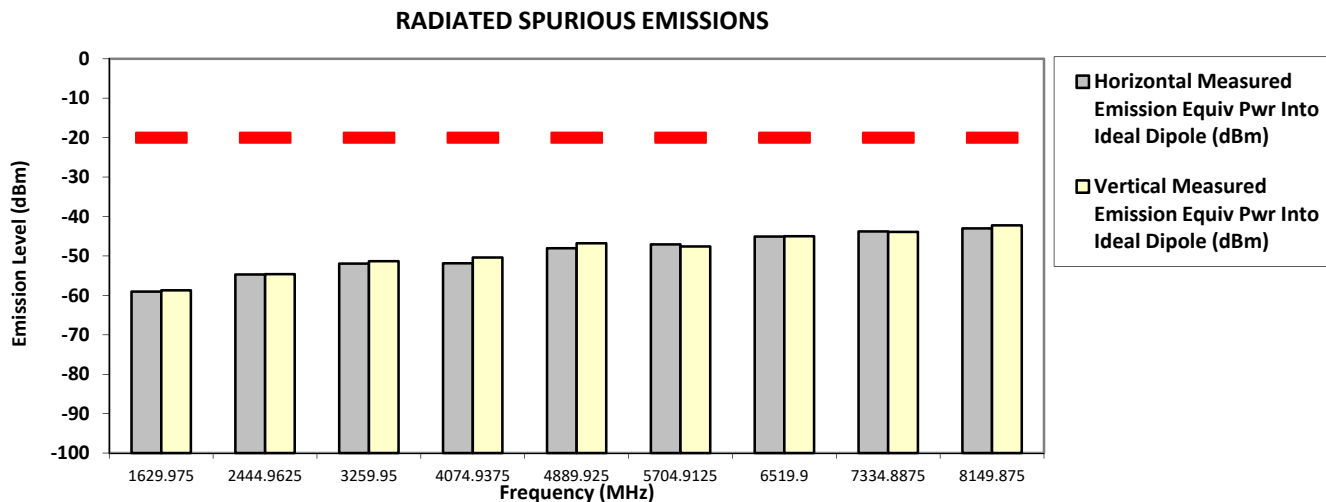

The data presented here was taken using the substitution method as found in the ANSI C63.26-2015 document.
 Motorola Penang EMC Lab - Test Performed by: Qawiman,Nazrin&Azil Sat, 5 Feb, 2022

Remarks: ** Indicates the spurious emission could not be detected due to noise limitations or ambient.
 *Pursuant to CFR 47 Part 2.1057 (c), emissions attenuated more than 20 dB below the permissible limit are not reported
 Temp(Deg): 23.3 Hum(%RH): 69.4

Remarks: Passed Results Marginal Results Failed Results

SAC Transmitter Radiated Emission:

Model Number: H25UCF9PW6AN **S/N: 657TYB0716** **SR:26860-EMC-00073**
Battery Part No: PMNN4813A **Accy Part No: NA**
Test Mode: TX APCO Digital Phase II
823.987500 MHz (For FCC only) **12.5 kHz** **3.600 Watt(s) /Max Power**

Frequency (MHz)	Limit	Horizontal Measured Emission Equiv Pwr Into Ideal Dipole (dBm)	Vertical Measured Emission Equiv Pwr Into ideal Dipole (dBm)
1647.9750	-13.0000	-60.4825 **	-59.8479 **
2471.9625	-13.0000	-53.9608 **	-55.1574 **
3295.9500	-13.0000	-49.8794 **	-51.6058 **
4119.9375	-13.0000	-49.9425 **	-51.4275 **
4943.9250	-13.0000	-47.6081 **	-47.7777 **
5767.9125	-13.0000	-46.9010 **	-46.6487 **
6591.9000	-13.0000	-43.4225 **	-45.3083 **
7415.8875	-13.0000	-43.1215 **	-41.1849 **
8239.8750	-13.0000	-42.5210 **	-42.6315 **

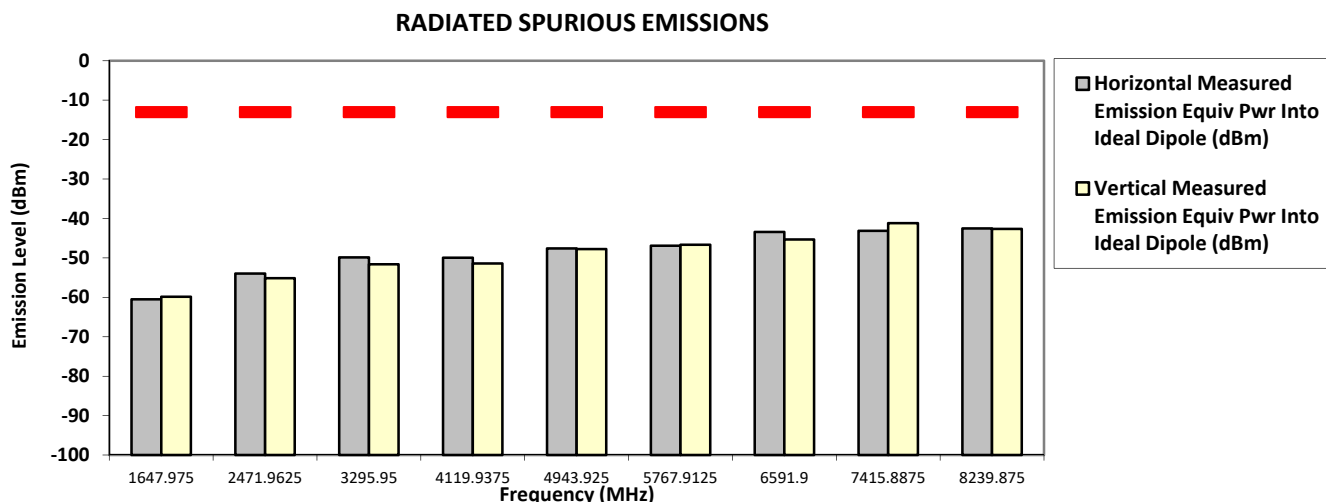

The data presented here was taken using the substitution method as found in the ANSI C63.26-2015 document.
 Motorola Penang EMC Lab - Test Performed by: Qawiman, Nazrin & Azil Sat, 5 Feb, 2022

Remarks: ** Indicates the spurious emission could not be detected due to noise limitations or ambient.
 *Pursuant to CFR 47 Part 2.1057 (c), emissions attenuated more than 20 dB below the permissible limit are not reported
 Temp(Deg): 23.3 Hum(%RH): 69.4

Remarks: Passed Results Marginal Results Failed Results

SAC Transmitter Radiated Emission:

Model Number: H25UCF9PW6AN **S/N: 657TYB0716** **SR:26860-EMC-00073**
Battery Part No: PMNN4813A **Accy Part No: NA**
Test Mode: TX APCO Digital Phase II
823.987500 MHz (For IC only) **12.5 kHz** **1.000 Watt(s) /Low Power**

Frequency (MHz)	Limit	Horizontal Measured Emission Equiv Pwr Into Ideal Dipole (dBm)	Vertical Measured Emission Equiv Pwr Into ideal Dipole (dBm)
1647.9750	-20.0000	-58.4789 **	-59.1597 **
2471.9625	-20.0000	-54.4209 **	-53.6982 **
3295.9500	-20.0000	-51.4407 **	-51.6119 **
4119.9375	-20.0000	-50.7899 **	-51.4195 **
4943.9250	-20.0000	-47.8937 **	-47.4769 **
5767.9125	-20.0000	-47.2718 **	-46.5219 **
6591.9000	-20.0000	-44.2115 **	-45.2711 **
7415.8875	-20.0000	-43.3335 **	-42.9203 **
8239.8750	-20.0000	-43.7570 **	-42.7976 **

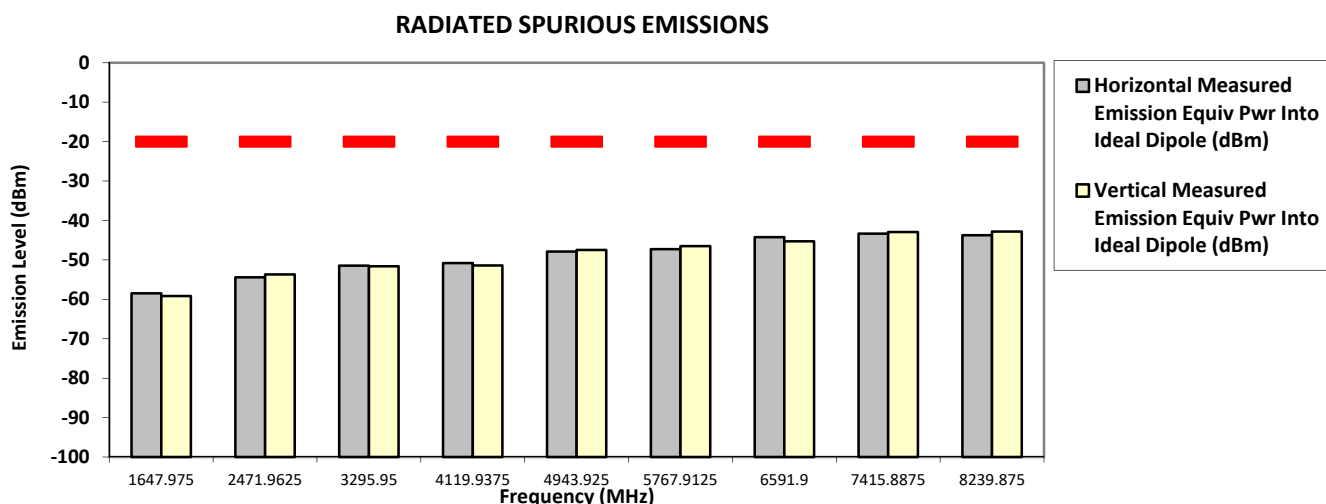

The data presented here was taken using the substitution method as found in the ANSI C63.26-2015 document.
 Motorola Penang EMC Lab - Test Performed by: Qawiman, Nazrin & Azil Sat, 5 Feb, 2022

Remarks: ** Indicates the spurious emission could not be detected due to noise limitations or ambient.
 *Pursuant to CFR 47 Part 2.1057 (c), emissions attenuated more than 20 dB below the permissible limit are not reported
 Temp(Deg): 23.3 Hum(%RH): 69.4

Remarks: Passed Results Marginal Results Failed Results

SAC Transmitter Radiated Emission:

Model Number: H25UCF9PW6AN **S/N: 657TYB0716** **SR:26860-EMC-00073**
Battery Part No: PMNN4813A **Accy Part No: NA**
Test Mode: TX APCO Digital Phase II
851.012500 MHz (For FCC only) **12.5 kHz** **3.600 Watt(s) /Max Power**

Frequency (MHz)	Limit	Horizontal Measured Emission Equiv Pwr Into Ideal Dipole (dBm)	Vertical Measured Emission Equiv Pwr Into ideal Dipole (dBm)
1702.0250	-13.0000	-59.2745 **	-58.8880 **
2553.0375	-13.0000	-53.4756 **	-54.1951 **
3404.0500	-13.0000	-51.6841 **	-51.7703 **
4255.0625	-13.0000	-49.7175 **	-49.8147 **
5106.0750	-13.0000	-47.9678 **	-46.3112 **
5957.0875	-13.0000	-44.3565 **	-45.5756 **
6808.1000	-13.0000	-44.7534 **	-44.3437 **
7659.1125	-13.0000	-42.0071 **	-43.6633 **
8510.1250	-13.0000	-42.8129 **	-42.0699 **

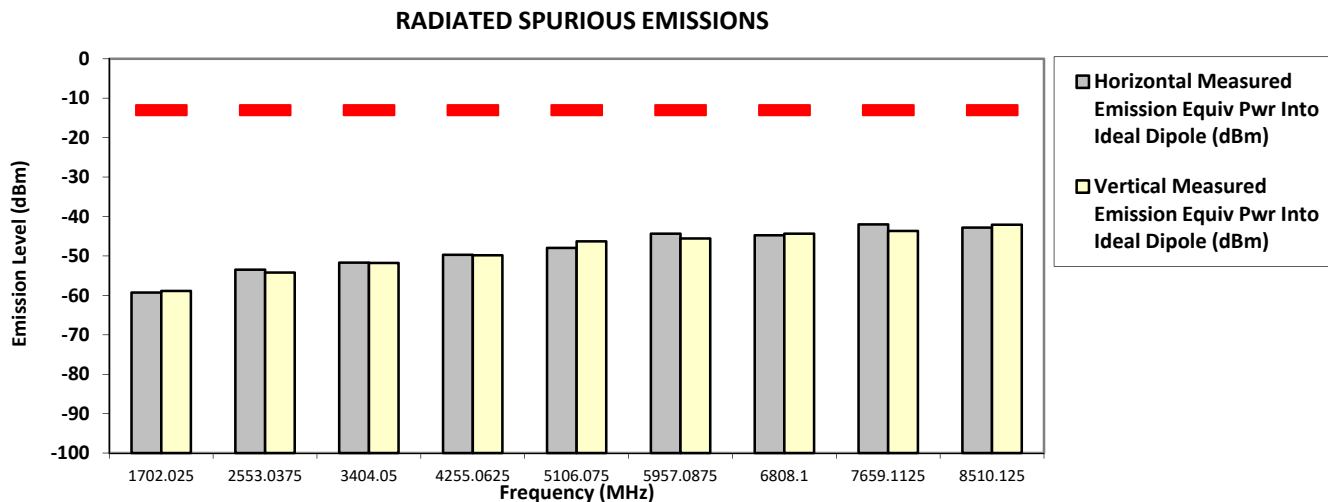

The data presented here was taken using the substitution method as found in the ANSI C63.26-2015 document.
 Motorola Penang EMC Lab - Test Performed by: Qawiman, Nazrin & Azil Sat, 5 Feb, 2022

Remarks: ** Indicates the spurious emission could not be detected due to noise limitations or ambient.
 *Pursuant to CFR 47 Part 2.1057 (c), emissions attenuated more than 20 dB below the permissible limit are not reported
 Temp(Deg): 23.3 Hum(%RH): 69.4

Remarks: Passed Results Marginal Results Failed Results

SAC Transmitter Radiated Emission:

Model Number: H25UCF9PW6AN **S/N: 657TYB0716** **SR:26860-EMC-00073**
Battery Part No: PMNN4813A **Accy Part No: NA**
Test Mode: TX APCO Digital Phase II
851.012500 MHz (For IC only) **12.5 kHz** **3.600 Watt(s) /Max Power**

Frequency (MHz)	Limit	Horizontal Measured Emission Equiv Pwr Into Ideal Dipole (dBm)	Vertical Measured Emission Equiv Pwr Into ideal Dipole (dBm)
1702.0250	-20.0000	-59.2745 **	-58.8880 **
2553.0375	-20.0000	-53.4756 **	-54.1951 **
3404.0500	-20.0000	-51.6841 **	-51.7703 **
4255.0625	-20.0000	-49.7175 **	-49.8147 **
5106.0750	-20.0000	-47.9678 **	-46.3112 **
5957.0875	-20.0000	-44.3565 **	-45.5756 **
6808.1000	-20.0000	-44.7534 **	-44.3437 **
7659.1125	-20.0000	-42.0071 **	-43.6633 **
8510.1250	-20.0000	-42.8129 **	-42.0699 **

RADIATED SPURIOUS EMISSIONS

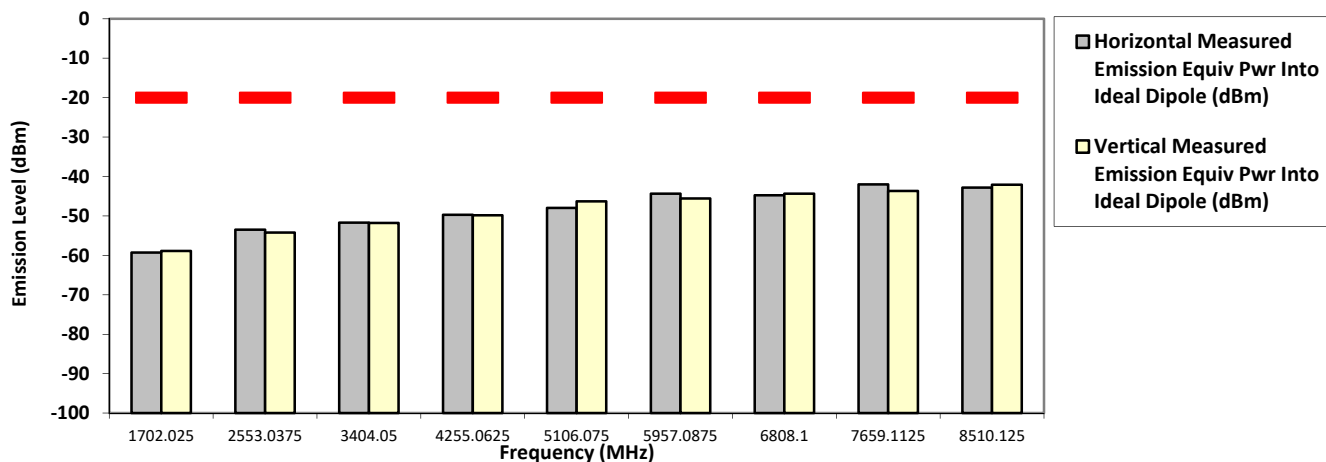

The data presented here was taken using the substitution method as found in the ANSI C63.26-2015 document.
 Motorola Penang EMC Lab - Test Performed by: Qawiman, Nazrin & Azil Sat, 5 Feb, 2022

Remarks: ** Indicates the spurious emission could not be detected due to noise limitations or ambient.
 *Pursuant to CFR 47 Part 2.1057 (c), emissions attenuated more than 20 dB below the permissible limit are not reported
 Temp(Deg): 23.3 Hum(%RH): 69.4

Remarks: Passed Results Marginal Results Failed Results

SAC Transmitter Radiated Emission:

Model Number: H25UCF9PW6AN **S/N: 657TYB0716** **SR:26860-EMC-00073**
Battery Part No: PMNN4813A **Accy Part No: NA**
Test Mode: TX APCO Digital Phase II
860.012500 MHz (For FCC only) **12.5 kHz** **3.600 Watt(s) /Max Power**

Frequency (MHz)	Limit	Horizontal Measured Emission Equiv Pwr Into Ideal Dipole (dBm)	Vertical Measured Emission Equiv Pwr Into ideal Dipole (dBm)
1720.0250	-13.0000	-58.9164 **	-57.4864 **
2580.0375	-13.0000	-53.9403 **	-54.0858 **
3440.0500	-13.0000	-51.7413 **	-51.7038 **
4300.0625	-13.0000	-48.8159 **	-50.0871 **
5160.0750	-13.0000	-46.5080 **	-48.0573 **
6020.0875	-13.0000	-45.5103 **	-46.1056 **
6880.1000	-13.0000	-45.0520 **	-43.4720 **
7740.1125	-13.0000	-43.7906 **	-42.5850 **
8600.1250	-13.0000	-40.6759 **	-42.4659 **

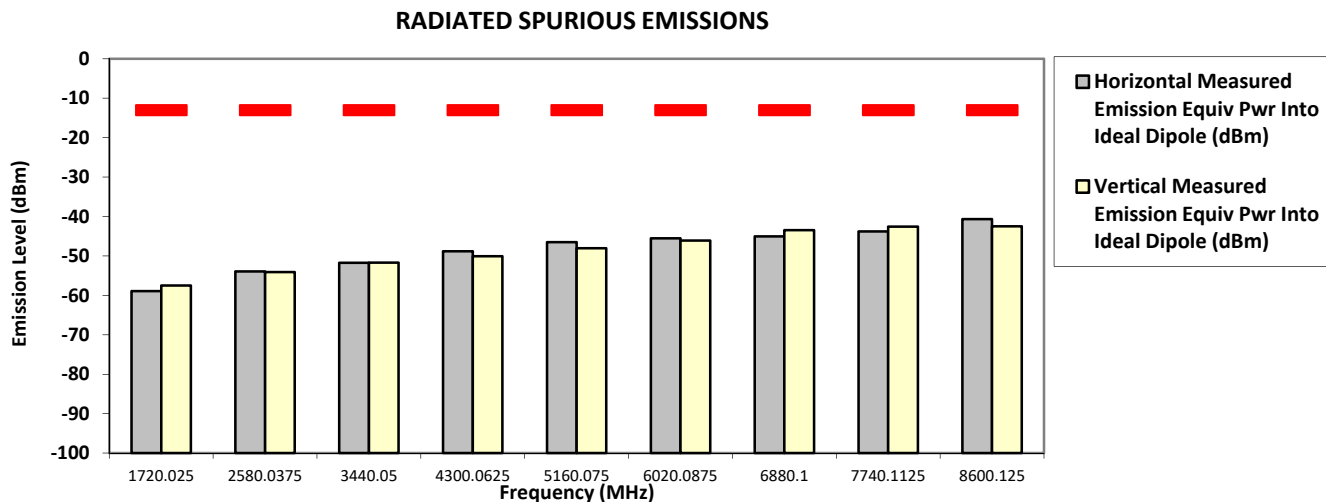

The data presented here was taken using the substitution method as found in the ANSI C63.26-2015 document.
 Motorola Penang EMC Lab - Test Performed by: Qawiman, Nazrin & Azil Sat, 5 Feb, 2022

Remarks: ** Indicates the spurious emission could not be detected due to noise limitations or ambient.
 *Pursuant to CFR 47 Part 2.1057 (c), emissions attenuated more than 20 dB below the permissible limit are not reported
 Temp(Deg): 23.3 Hum(%RH): 69.4

Remarks: Passed Results Marginal Results Failed Results

SAC Transmitter Radiated Emission:

Model Number: H25UCF9PW6AN **S/N: 657TYB0716** **SR:26860-EMC-00073**
Battery Part No: PMNN4813A **Accy Part No: NA**
Test Mode: TX APCO Digital Phase II
860.012500 MHz (For IC only) **12.5 kHz** **3.600 Watt(s) /Max Power**

Frequency (MHz)	Limit	Horizontal Measured Emission Equiv Pwr Into Ideal Dipole (dBm)	Vertical Measured Emission Equiv Pwr Into ideal Dipole (dBm)
1720.0250	-20.0000	-58.9164 **	-57.4864 **
2580.0375	-20.0000	-53.9403 **	-54.0858 **
3440.0500	-20.0000	-51.7413 **	-51.7038 **
4300.0625	-20.0000	-48.8159 **	-50.0871 **
5160.0750	-20.0000	-46.5080 **	-48.0573 **
6020.0875	-20.0000	-45.5103 **	-46.1056 **
6880.1000	-20.0000	-45.0520 **	-43.4720 **
7740.1125	-20.0000	-43.7906 **	-42.5850 **
8600.1250	-20.0000	-40.6759 **	-42.4659 **

RADIATED SPURIOUS EMISSIONS

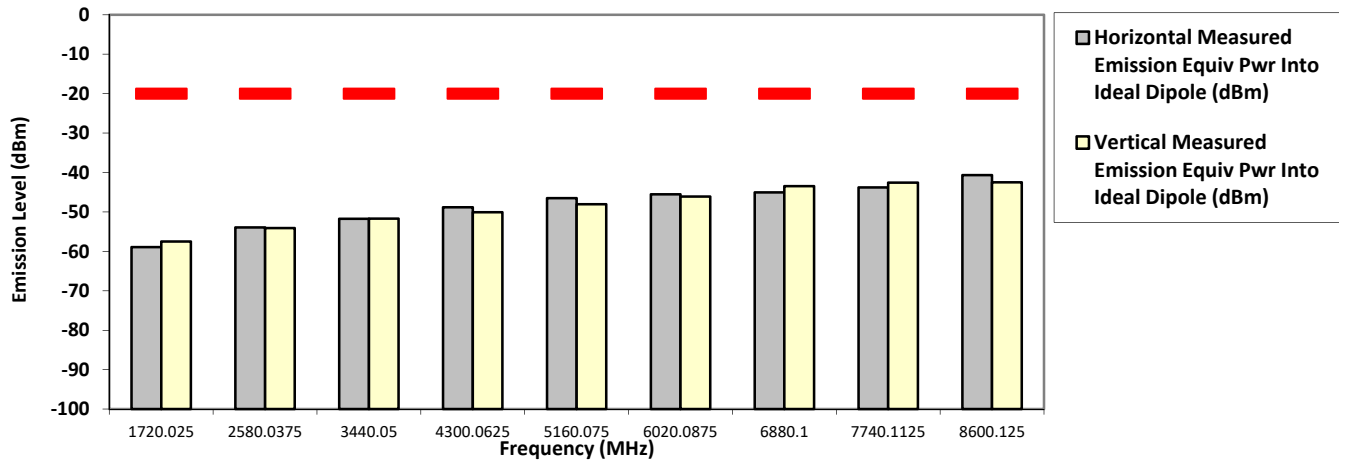

The data presented here was taken using the substitution method as found in the ANSI C63.26-2015 document.
 Motorola Penang EMC Lab - Test Performed by: Qawiman, Nazrin & Azil Sat, 5 Feb, 2022

Remarks: ** Indicates the spurious emission could not be detected due to noise limitations or ambient.
 *Pursuant to CFR 47 Part 2.1057 (c), emissions attenuated more than 20 dB below the permissible limit are not reported
 Temp(Deg): 23.3 Hum(%RH): 69.4

Remarks: Passed Results Marginal Results Failed Results

SAC Transmitter Radiated Emission:

Model Number: H25UCF9PW6AN **S/N: 657TYB0716** **SR:26860-EMC-00073**
Battery Part No: PMNN4813A **Accy Part No: NA**
Test Mode: TX APCO Digital Phase II
868.887500 MHz (For FCC only) **12.5 kHz** **3.600 Watt(s) /Max Power**

Frequency (MHz)	Limit	Horizontal Measured Emission Equiv Pwr Into Ideal Dipole (dBm)	Vertical Measured Emission Equiv Pwr Into ideal Dipole (dBm)
1737.7750	-13.0000	-58.2343 **	-57.6950 **
2606.6625	-13.0000	-54.0570 **	-53.5871 **
3475.5500	-13.0000	-51.8504 **	-52.6777 **
4344.4375	-13.0000	-50.5767 **	-49.6456 **
5213.3250	-13.0000	-47.7457 **	-47.6452 **
6082.2125	-13.0000	-46.7946 **	-45.9655 **
6951.1000	-13.0000	-43.9772 **	-43.3906 **
7819.9875	-13.0000	-43.0490 **	-42.4996 **
8688.8750	-13.0000	-41.8519 **	-42.4055 **

RADIATED SPURIOUS EMISSIONS

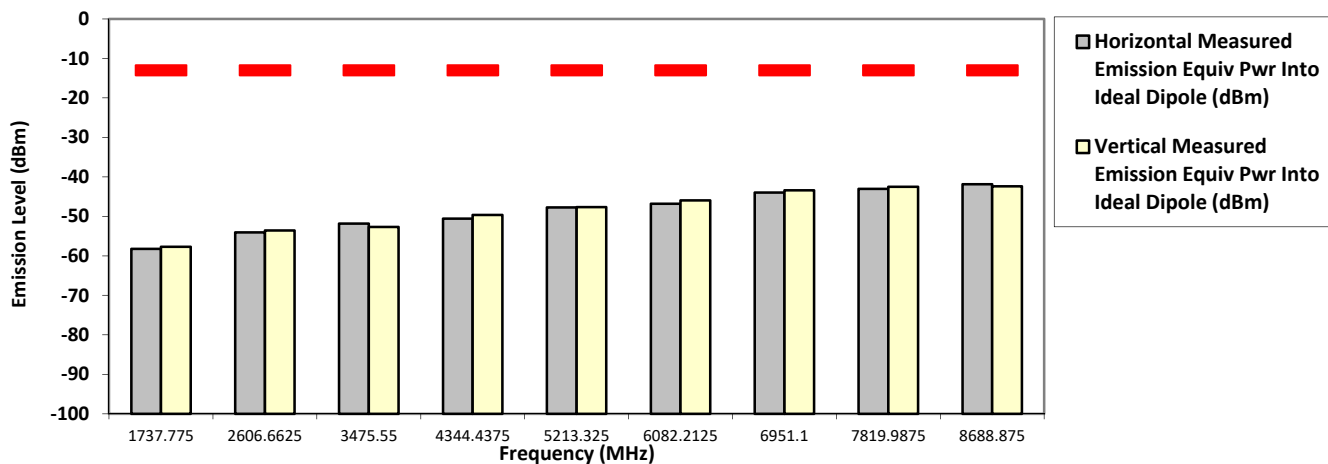

The data presented here was taken using the substitution method as found in the ANSI C63.26-2015 document.
 Motorola Penang EMC Lab - Test Performed by: Qawiman, Nazrin & Azil Sat, 5 Feb, 2022

Remarks: ** Indicates the spurious emission could not be detected due to noise limitations or ambient.
 *Pursuant to CFR 47 Part 2.1057 (c), emissions attenuated more than 20 dB below the permissible limit are not reported
 Temp(Deg): 23.3 Hum(%RH): 69.4

Remarks: Passed Results Marginal Results Failed Results

SAC Transmitter Radiated Emission:

Model Number: H25UCF9PW6AN **S/N: 657TYB0716** **SR:26860-EMC-00073**
Battery Part No: PMNN4813A **Accy Part No: NA**
Test Mode: TX APCO Digital Phase II
868.887500 MHz (For IC only) **12.5 kHz** **3.600 Watt(s) /Max Power**

Frequency (MHz)	Limit	Horizontal Measured Emission Equiv Pwr Into Ideal Dipole (dBm)	Vertical Measured Emission Equiv Pwr Into ideal Dipole (dBm)
1737.7750	-20.0000	-58.2343 **	-57.6950 **
2606.6625	-20.0000	-54.0570 **	-53.5871 **
3475.5500	-20.0000	-51.8504 **	-52.6777 **
4344.4375	-20.0000	-50.5767 **	-49.6456 **
5213.3250	-20.0000	-47.7457 **	-47.6452 **
6082.2125	-20.0000	-46.7946 **	-45.9655 **
6951.1000	-20.0000	-43.9772 **	-43.3906 **
7819.9875	-20.0000	-43.0490 **	-42.4996 **
8688.8750	-20.0000	-41.8519 **	-42.4055 **

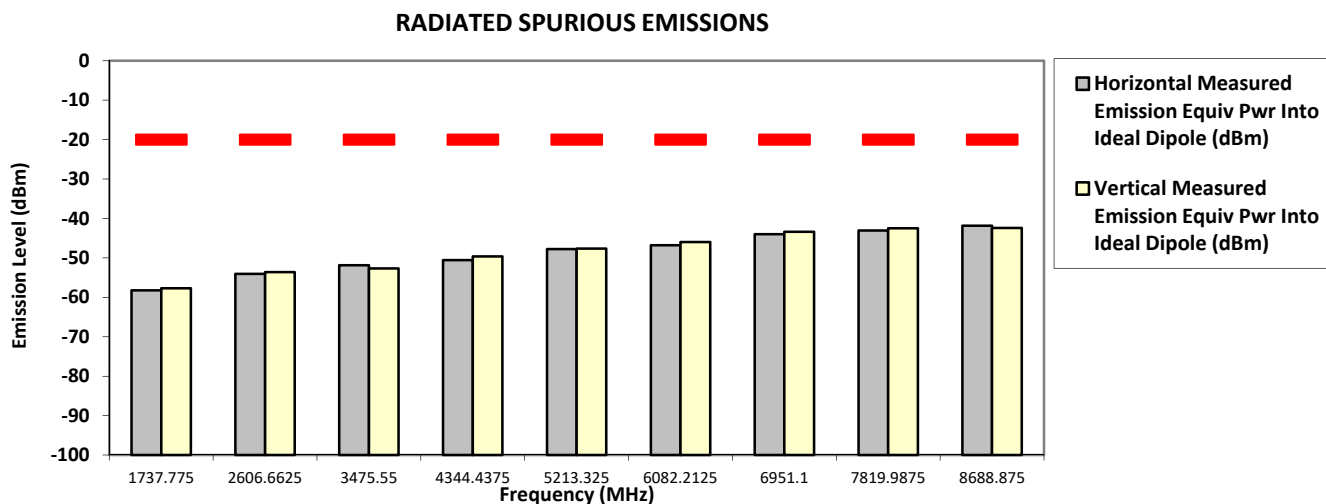

The data presented here was taken using the substitution method as found in the ANSI C63.26-2015 document.
 Motorola Penang EMC Lab - Test Performed by: Qawiman, Nazrin & Azil Sat, 5 Feb, 2022

Remarks: ** Indicates the spurious emission could not be detected due to noise limitations or ambient.
 *Pursuant to CFR 47 Part 2.1057 (c), emissions attenuated more than 20 dB below the permissible limit are not reported
 Temp(Deg): 23.3 Hum(%RH): 69.4

Remarks: Passed Results Marginal Results Failed Results

6.11.4. Test Limit

Table below summarized the power of any emission outside a licensee’s frequency block shall be attenuated below the transmitter power (P) by at least

Channel Spacing	Part 22	Part 24D	Part 74	Part 80	Part 90 (UHF, VHF, 800, 900)	Part 90 (700)
12.5kHz	43 + log ₁₀ (P) (-13 dBm)	43 + log ₁₀ (P) (-13 dBm)	43 + log ₁₀ (P) (-13 dBm)	Not Applicable	50 + log ₁₀ (P) (-20 dBm)	43 + log ₁₀ (P) (-13 dBm)
25kHz		Not Applicable		43 + log ₁₀ (P) (-13 dBm)	43 + log ₁₀ (P) (-13 dBm)	43 + log ₁₀ (P) (-13 dBm)

Channel Spacing	RSS 134	RSS 182	RSS 119 (UHF, VHF, 800, 900)	RSS 119 (700)
12.5kHz	43 + log ₁₀ (P) (-13 dBm)	Not Applicable	50 + log ₁₀ (P) (-20 dBm)	43 + log ₁₀ (P) (-13 dBm)
25kHz	Not Applicable	43 + log ₁₀ (P) (-13 dBm)	43 + log ₁₀ (P) (-13 dBm)	43 + log ₁₀ (P) (-13 dBm)

6.12. Effective Radiated Power (ERP)

6.12.1. Test Setup

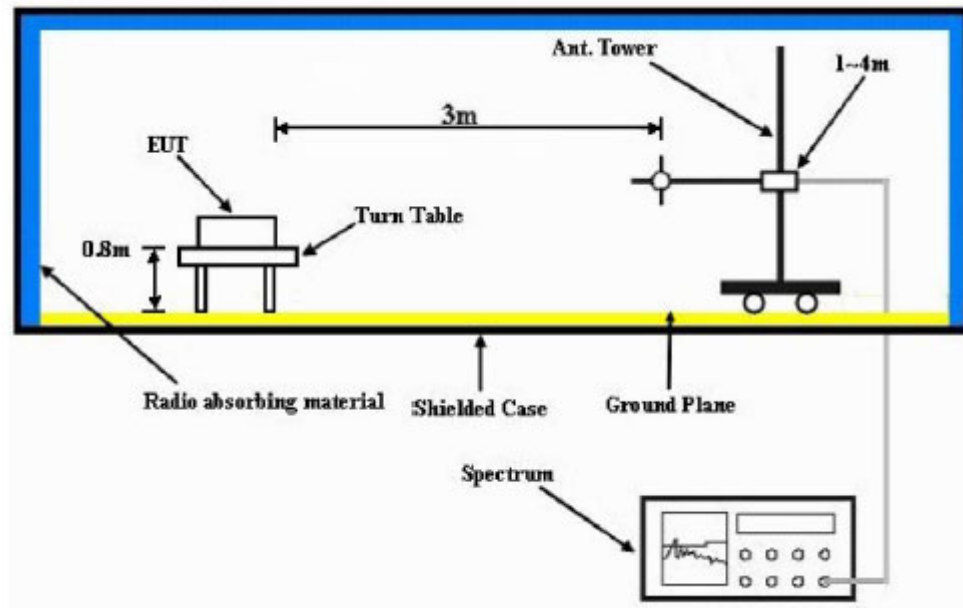

- 1) The Resolution Bandwidth for Equivalent Radiated Power (ERP) below 1 GHz is 100 kHz with Video Bandwidth = 300 kHz and Resolution Bandwidth for EIRP above 1 GHz is 1 MHz with Video Bandwidth = 3 MHz. Detector Mode is RMS.
- 2) In the semi-anechoic chamber, setup as illustrated above the DUT placed on the 0.8m height (for $f_c < 1\text{GHz}$) or 1.5m (for $f_c > 1\text{GHz}$) of Turn Table, rotated the table 45 degree each interval to search the maximum radiation power and receiver antenna shall be rotated vertical and horizontal polarization and moved height from 1m to 4m to find the maximum polar radiated power for each degree interval. The “Read Value” is the spectrum reading of maximum power value.
- 3) The substitution antenna is substituted for DUT at the same position and signals generator (S.G) export the CW signal to the substitution antenna via a TX cable. The receiver antenna shall be rotated vertical and horizontal polarization and moved height from 1m to 4m to find the maximum radiation power. Record the power level of maximum radiation power from spectrum. So, the Measured substitution value = Ref level of S.G + TX cables loss – Substituted Antenna Gain.

6.12.2. Test Result

Not Applicable

6.12.3. Test Limit

The maximum output power of the transmitter for mobile stations is 100 watts (20 dB). Power is given in terms of effective radiated power (ERP).

6.13. GNSS (EIRP for 1559 - 1610MHz)

6.13.1. Test Setup

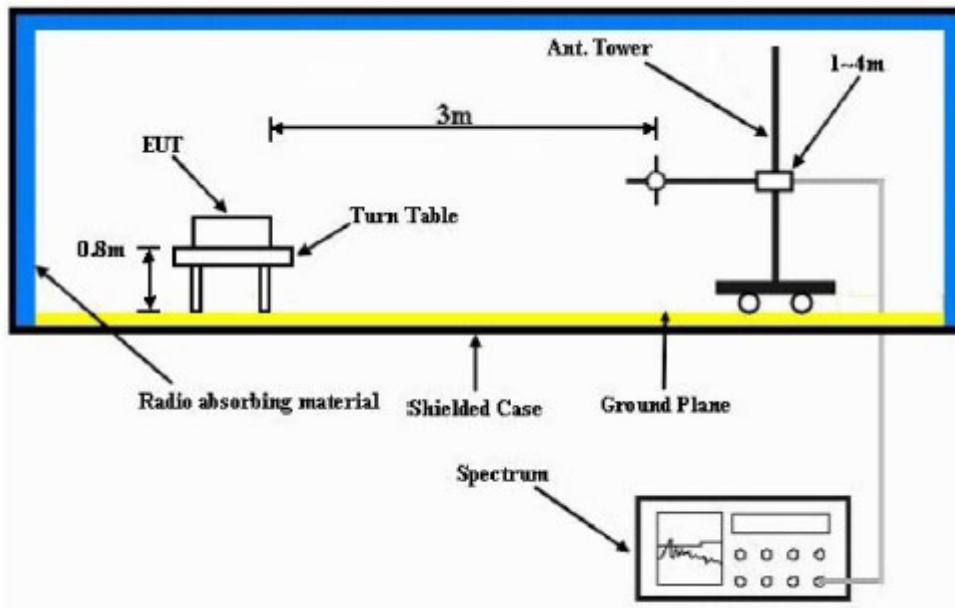

- 4) The Resolution Bandwidth for Equivalent Isotropically Radiated Power (EIRP) below 1 GHz is 100 kHz with Video Bandwidth = 300 kHz and Resolution Bandwidth for EIRP above 1 GHz is 1 MHz with Video Bandwidth = 3 MHz. Detector Mode is RMS.
- 5) In the semi-anechoic chamber, setup as illustrated above the DUT placed on the 0.8m height of Turn Table, rotated the table 45 degree each interval to search the maximum radiation power and receiver antenna shall be rotated vertical and horizontal polarization and moved height from 1m to 4m to find the maximum polar radiated power for each degree interval. The “Read Value” is the spectrum reading of maximum power value.
- 6) The substitution antenna is substituted for DUT at the same position and signals generator (S.G) export the CW signal to the substitution antenna via a TX cable. The receiver antenna shall be rotated vertical and horizontal polarization and moved height from 1m to 4m to find the maximum radiation power. Record the power level of maximum radiation power from spectrum. So, the Measured substitution value = Ref level of S.G + TX cables loss – Substituted Antenna Gain.
- 7) $EIRP = \text{“Read Value”} + \text{Measured substitution value} + 2.15$.

6.13.1. Test Result

Not Applicable

6.13.2. Test Limit

For operations in the 758-775 MHz and 788-805 MHz bands, all emissions including harmonics in the band 1559-1610 MHz shall be limited to -70 dBW/MHz equivalent isotropically radiated power (EIRP) for wideband signals, and -80 dBW EIRP for discrete emissions of less than 700 Hz bandwidth.

~ End of Test Report ~