

**EXHIBIT 9****Internal Photographs**

(Pursuant to FCC Part 2.1033(b)(7), 2.1033(c)(12) and RSP 100 Annex C)

The following photographs are attached.

	<u>Exhibit</u>
1. RF board <u>with</u> Shields (Top) Non-TIA4950	9A
2. RF board <u>without</u> Shields (Top) Non-TIA4950	9B
3. RF board <u>with</u> Shields (Bottom) Non-TIA4950	9C
4. RF board <u>without</u> Shields (Bottom) Non-TIA4950	9D
5. RF boards <u>with</u> chassis and housing (Front Side), FKP Non-TIA4950	9E
6. Chassis and Housing (Back Side), FKP Non-TIA4950	9F
7. RF boards <u>with</u> chassis and housing (Front Side), NKP Non-TIA4950	9G
8. Chassis and Housing (Back Side), NKP Non-TIA4950	9H
9. RF board <u>with</u> Shields (Top) TIA4950	9I
10. RF board <u>without</u> Shields (Top) TIA4950	9J
11. RF board <u>with</u> Shields (Bottom) TIA4950	9K
12. RF board <u>without</u> Shields (Bottom) TIA4950	9L
13. RF boards <u>with</u> chassis and housing (Front Side), FKP TIA4950	9M
14. Chassis and Housing (Back Side), FKP TIA4950	9N
15. RF boards <u>with</u> chassis and housing (Front Side), NKP TIA4950	9O
16. Chassis and Housing (Back Side), NKP TIA4950	9P
17. Keypad Board (Top)	9Q
18. Keypad Board (Bottom)	9R
19. Interface Board (Top)	9S
20. Interface Board (Bottom)	9T
21. GOB board with Shields (Top)	9U
22. GOB board without Shields (Top)	9V
23. GOB board (Bottom)	9W

Exhibit 9A

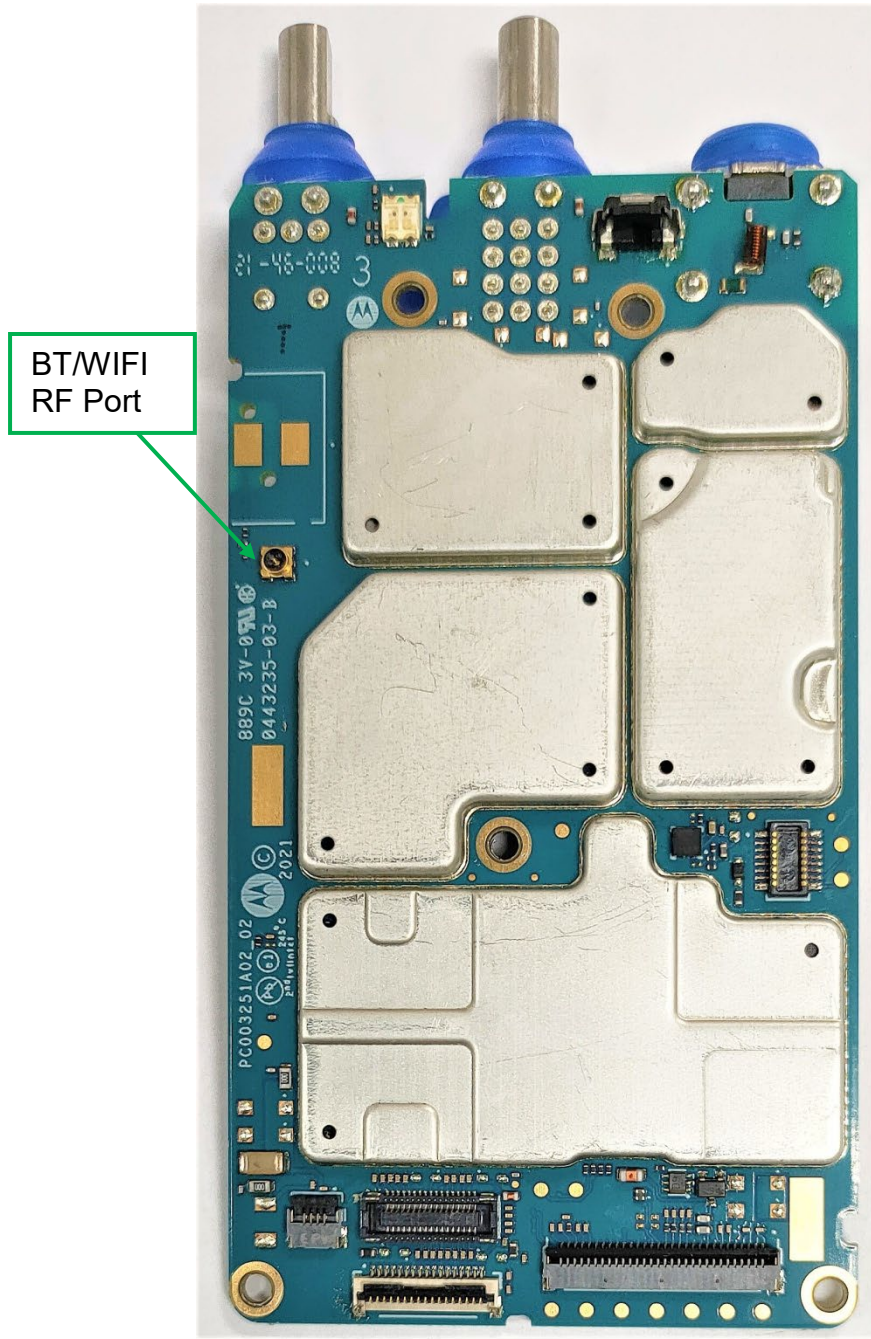

RF Board With Shields (Top) Non-TIA4950

Exhibit 9B

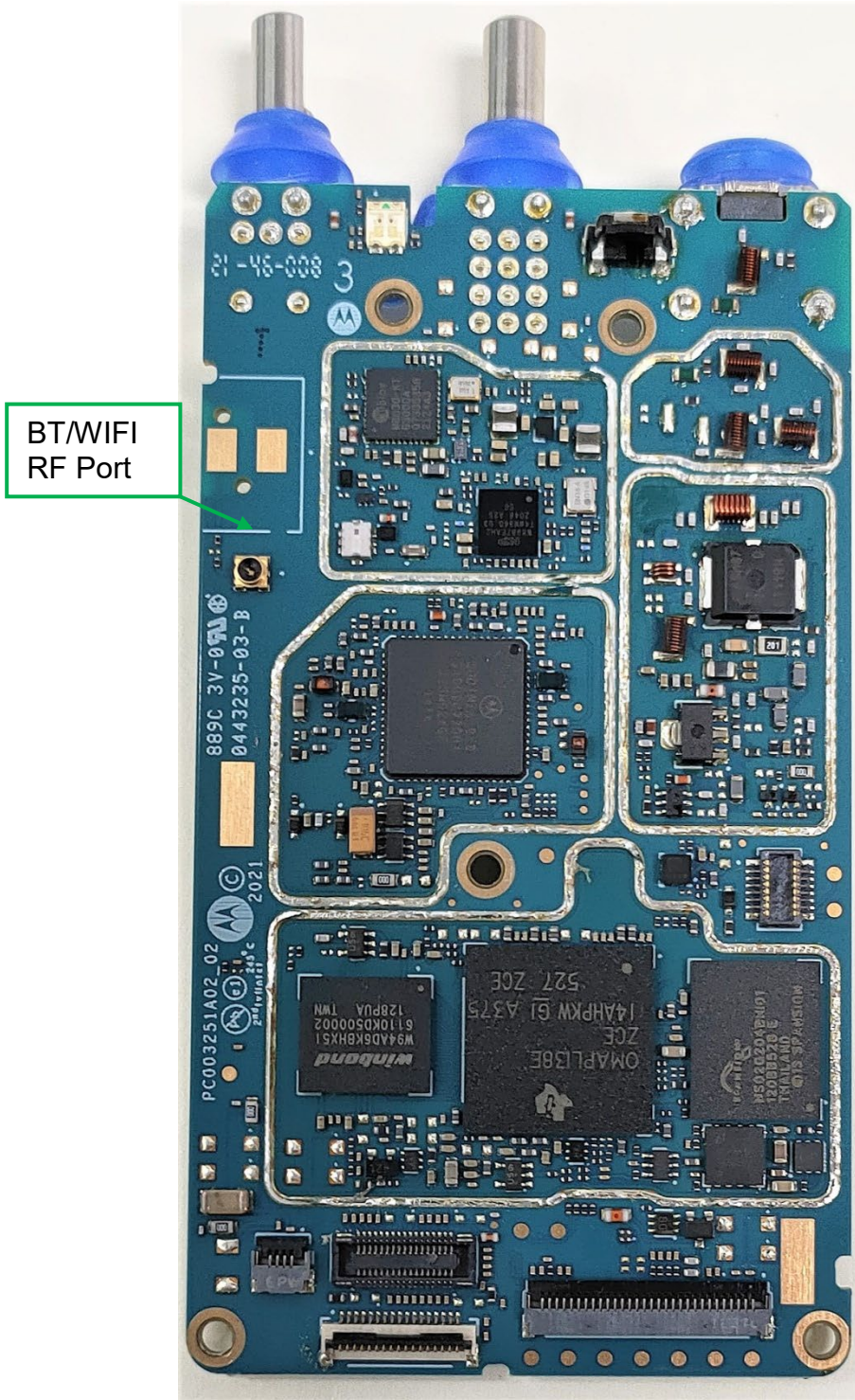

RF Board Without Shields (Top) Non-TIA4950

Exhibit 9C

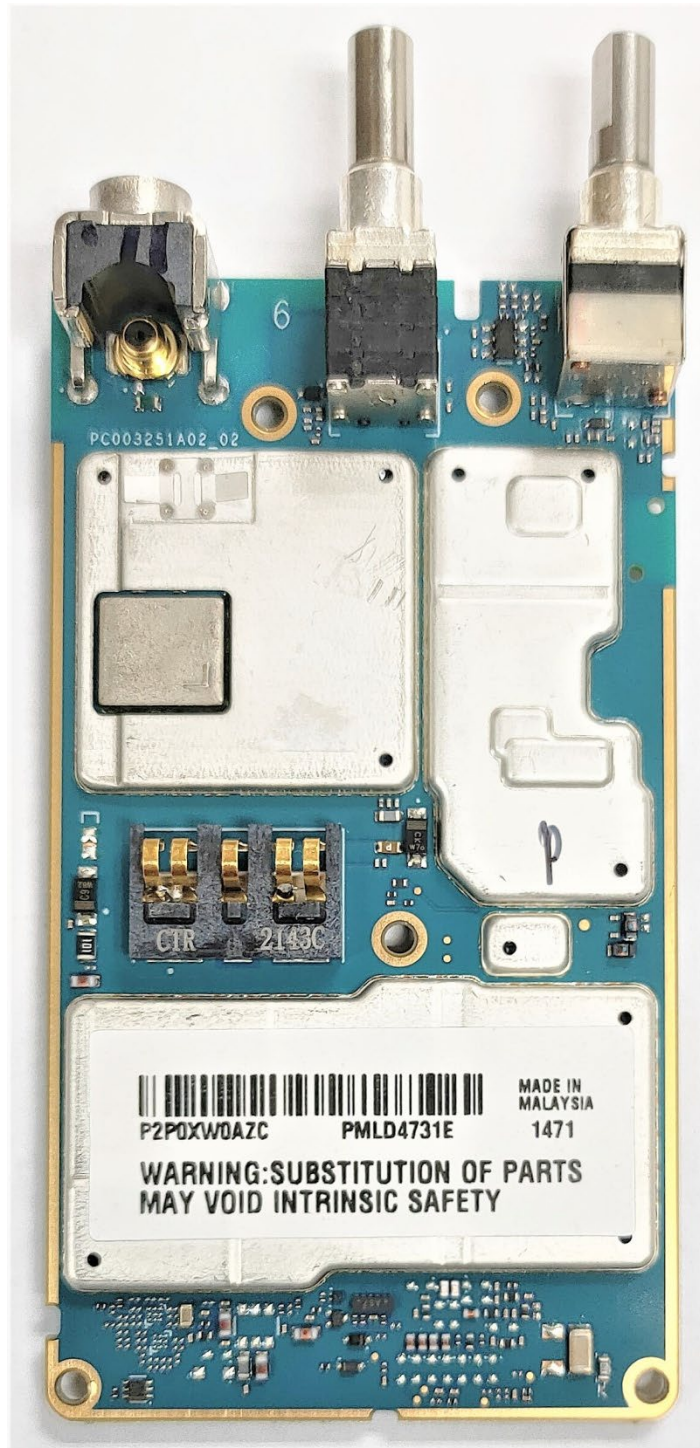

**RF Board With Shields (Bottom) Non-TIA4950**

Exhibit 9D

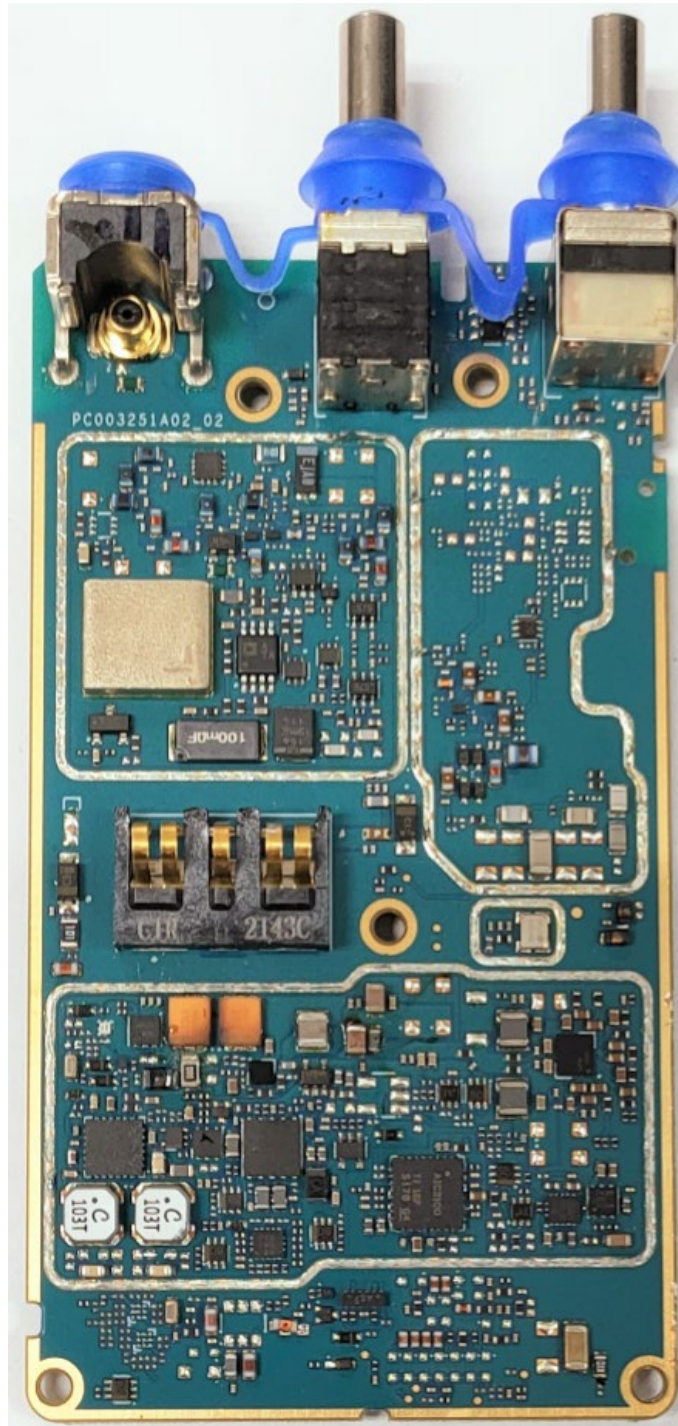

RF Board Without Shields (Bottom) Non-TIA4950

Exhibit 9E



RF Board With Chassis and Housing (Front Side) FKP Non-TIA4950



Exhibit 9G

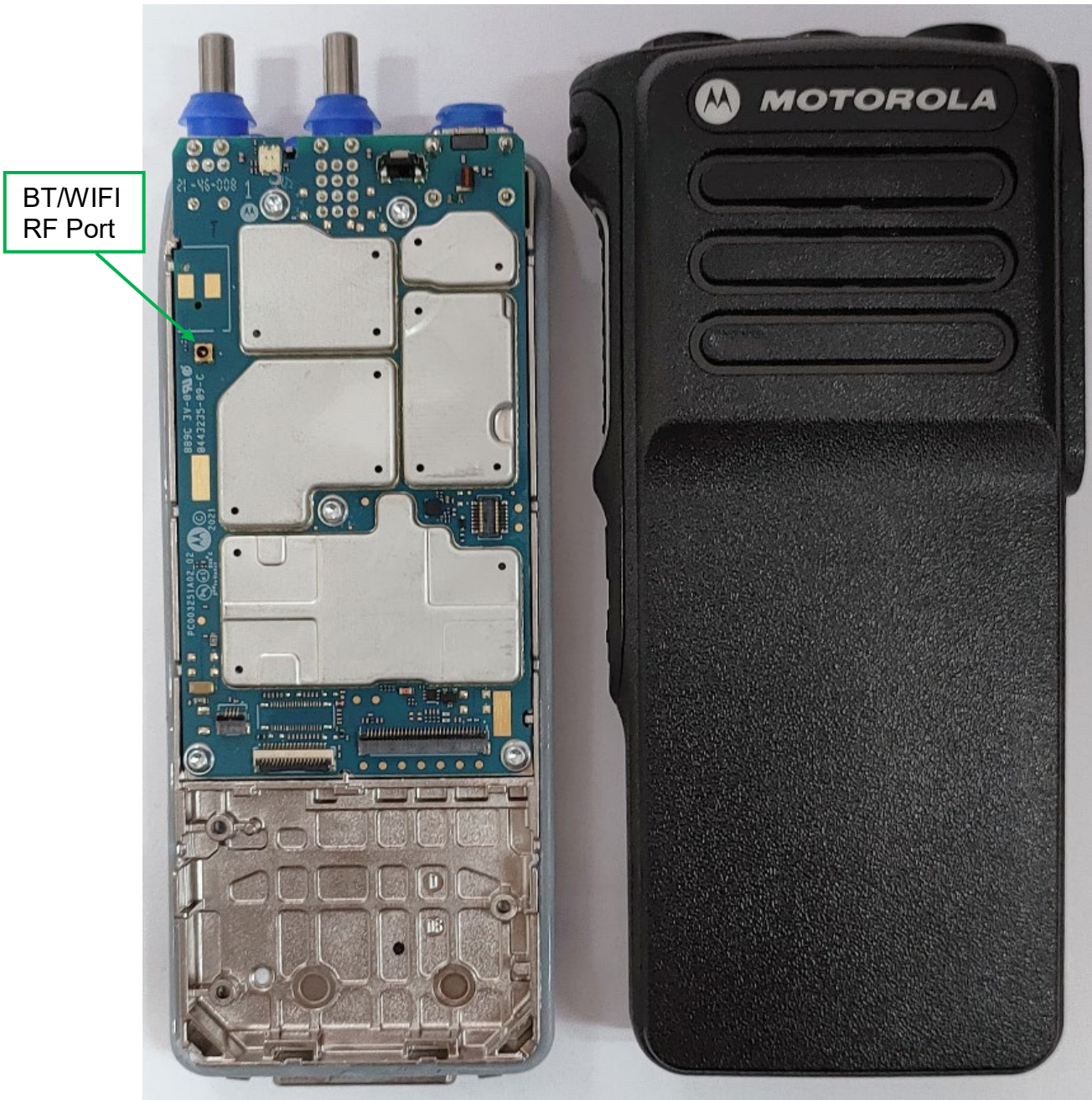

**RF Board With Chassis and Housing (Front Side) NKP Non-TIA4950**

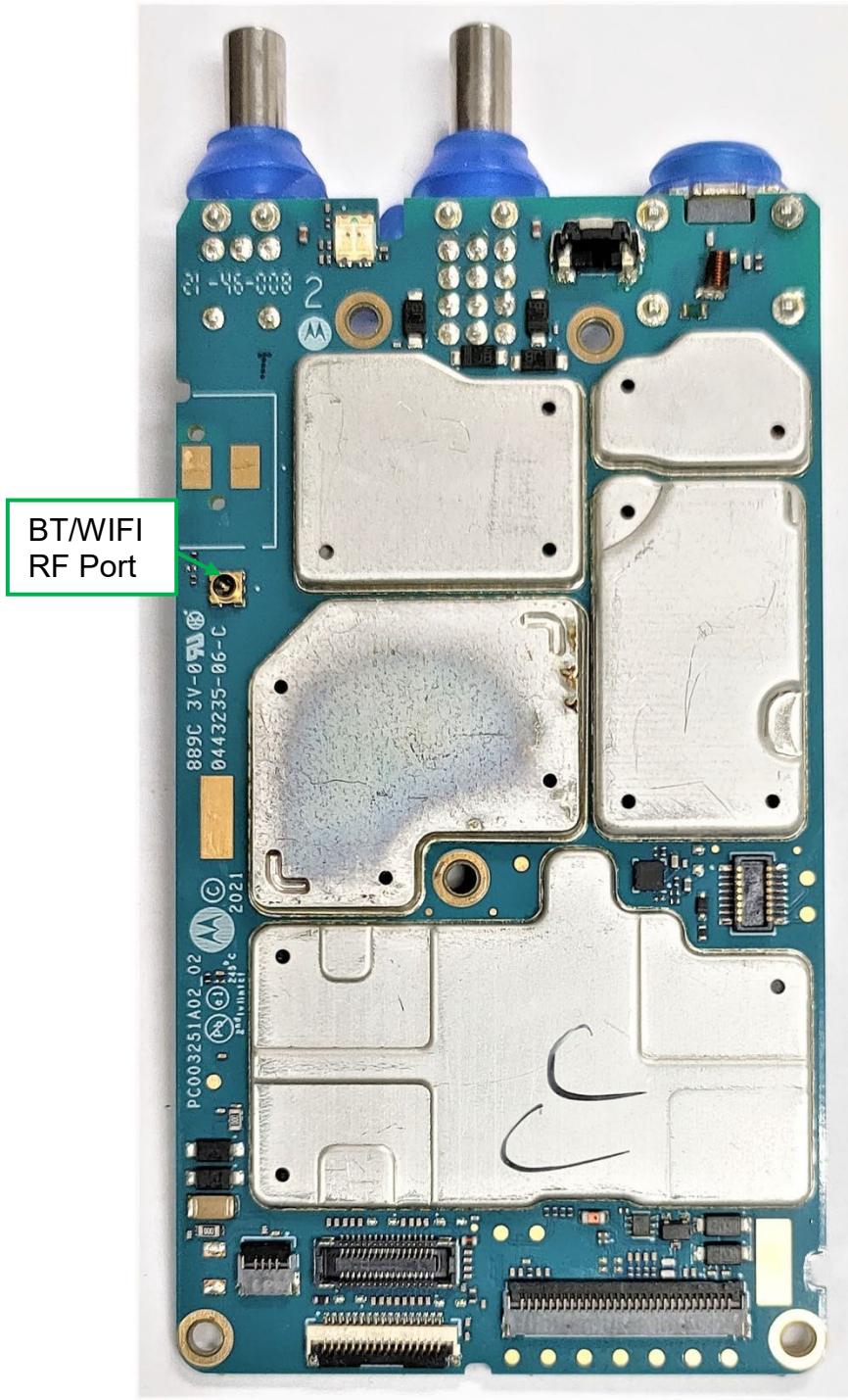

Exhibit 9H



**Chassis and Housing (Back Side) NKP Non-TIA4950**

Exhibit 9



BT/WIFI  
RF Port

**RF Board With Shields (Top) TIA4950**

Exhibit 9J

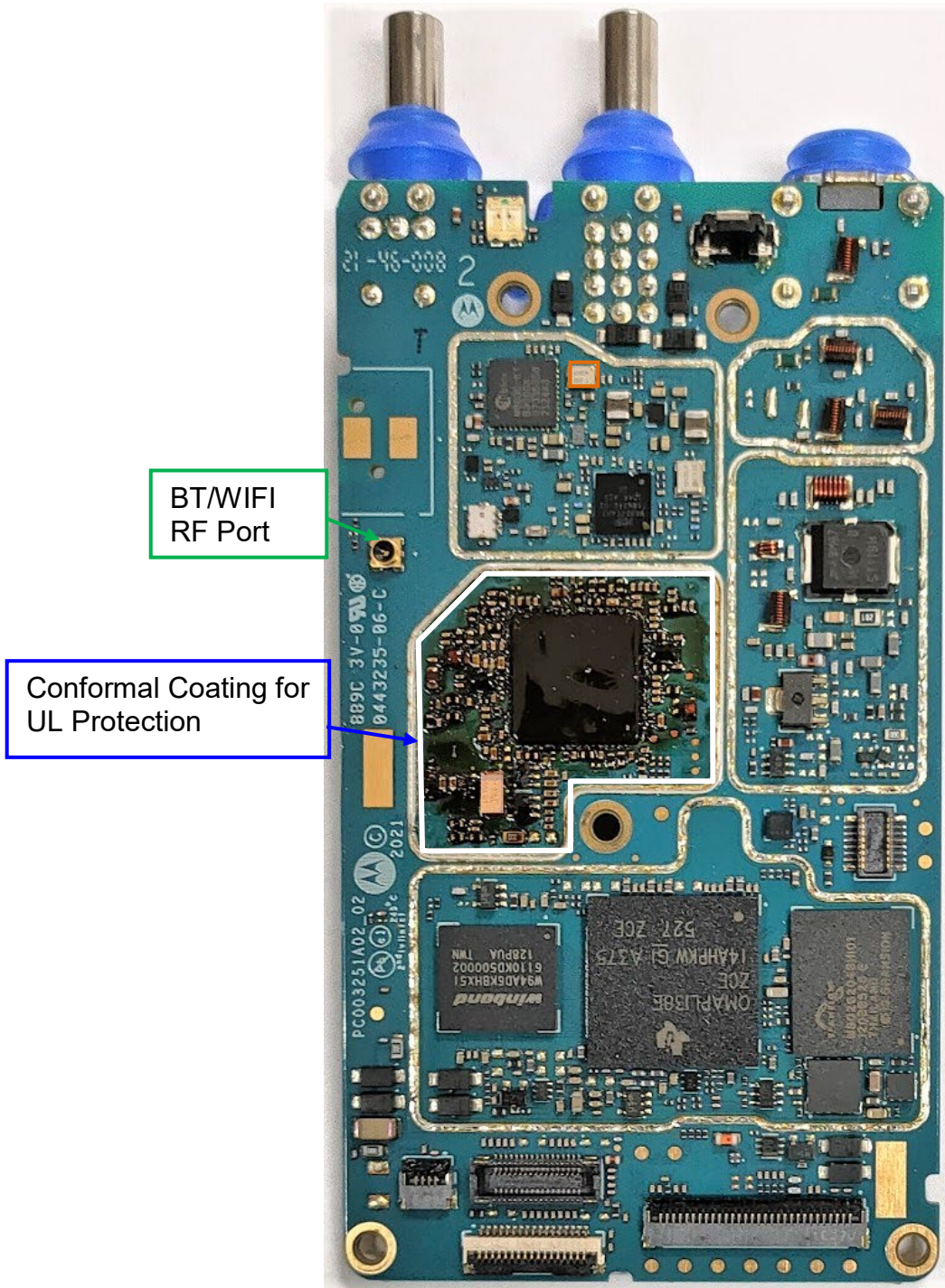

RF Board Without Shields (Top) TIA4950

Exhibit 9K



**RF Board With Shields (Bottom) TIA4950**

Exhibit 9L

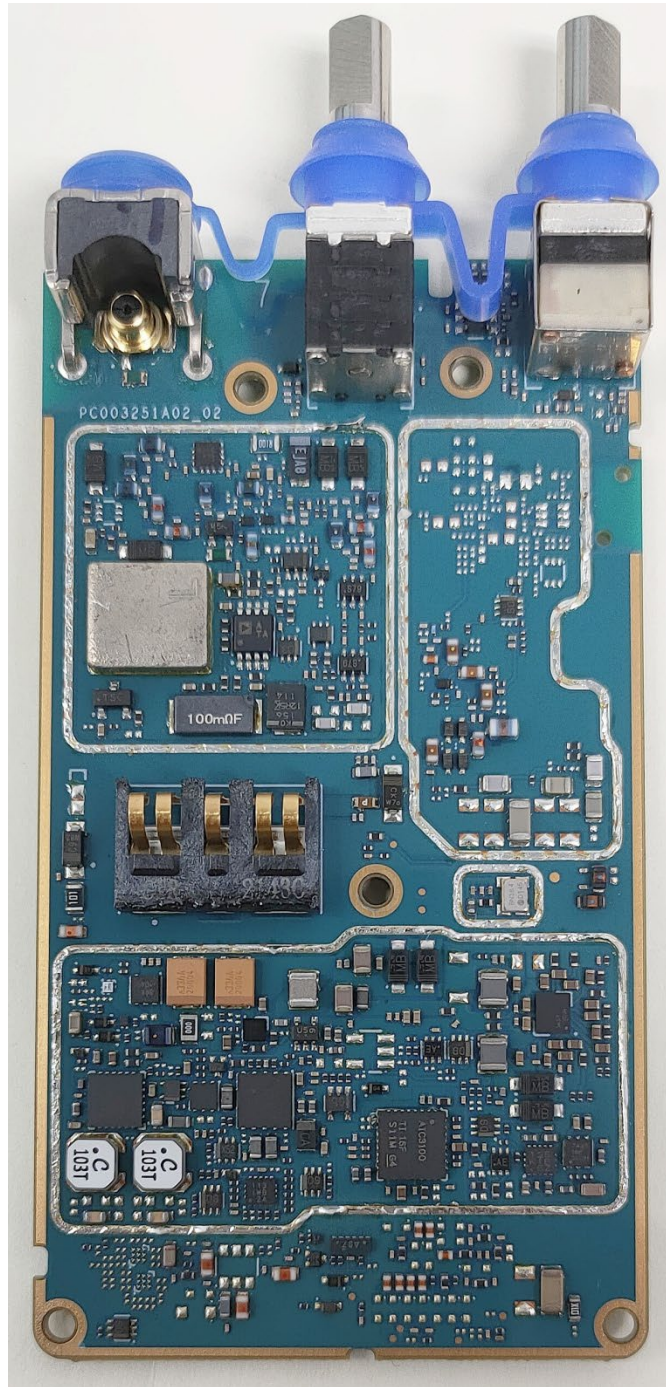

**RF Board Without Shields (Bottom) TIA4950**

Exhibit 9M



RF Board With Chassis and Housing (Front Side) FKP TIA4950

Exhibit 9N



**Chassis and Housing (Back Side) FKP TIA4950**

Exhibit 9O



**RF Board With Chassis and Housing (Front Side) NKP TIA4950**

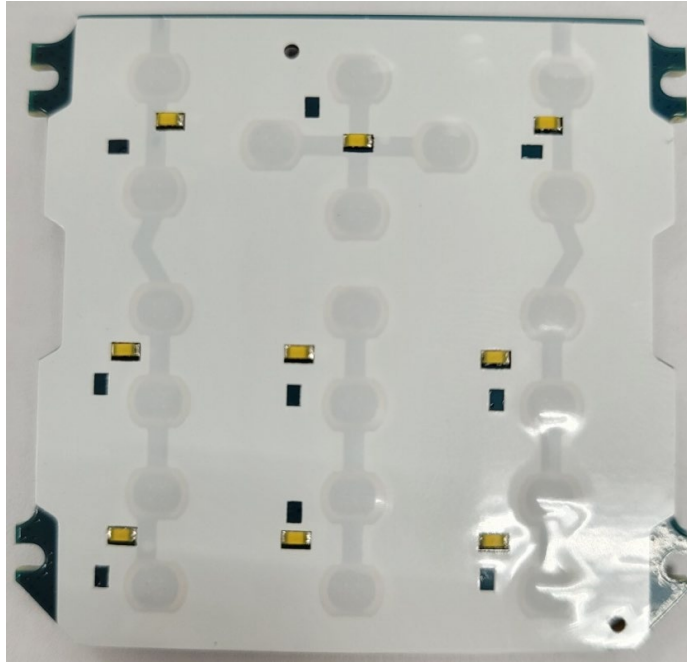

Exhibit 9P



**Chassis and Housing (Back Side) NKP TIA4950**

Exhibit 9Q



**Keypad board (Top)**

Exhibit 9R

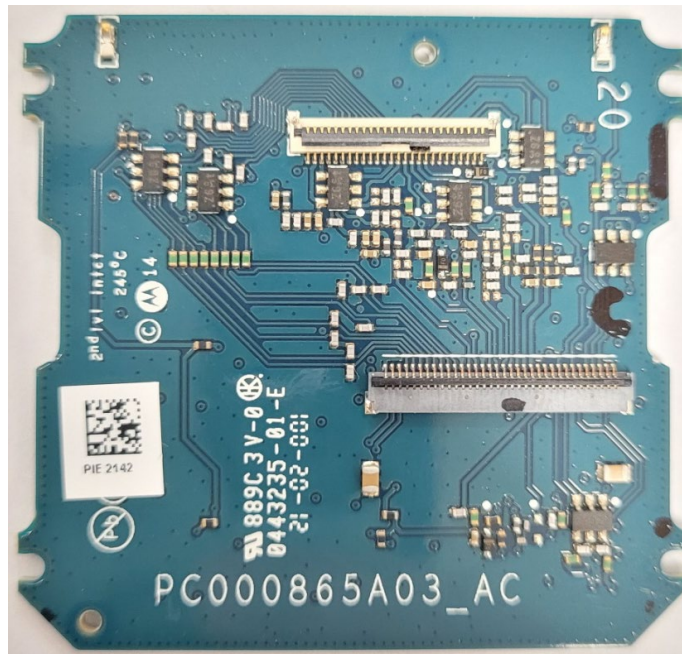

**Keypad board (Bottom)**

Exhibit 9S

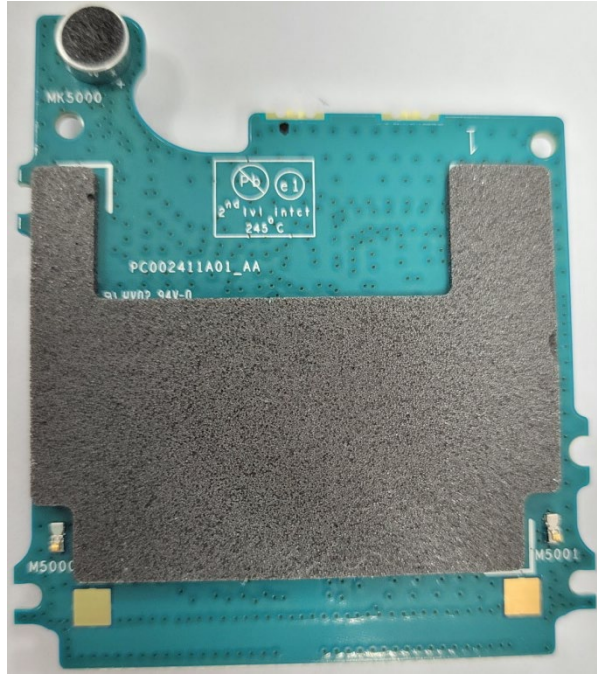

**Interface board (Top)**

Exhibit 9T

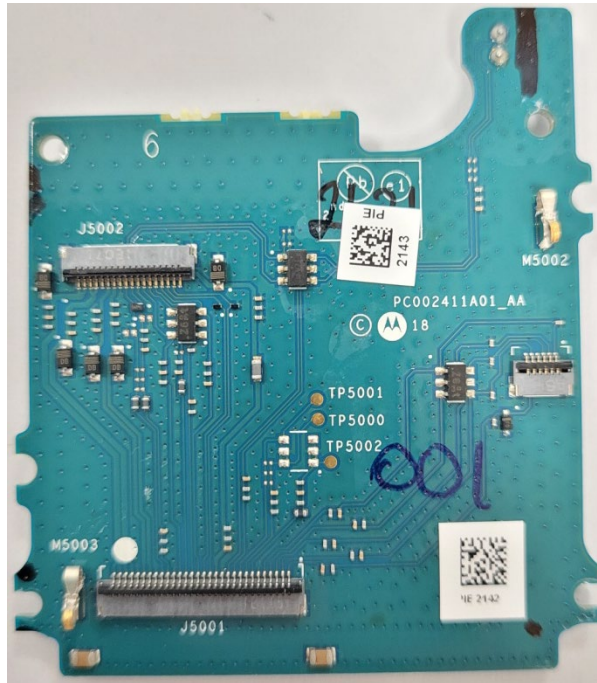

**Interface board (Bottom)**

Exhibit 9U



**GOB board with Shields (Top)**

Exhibit 9V

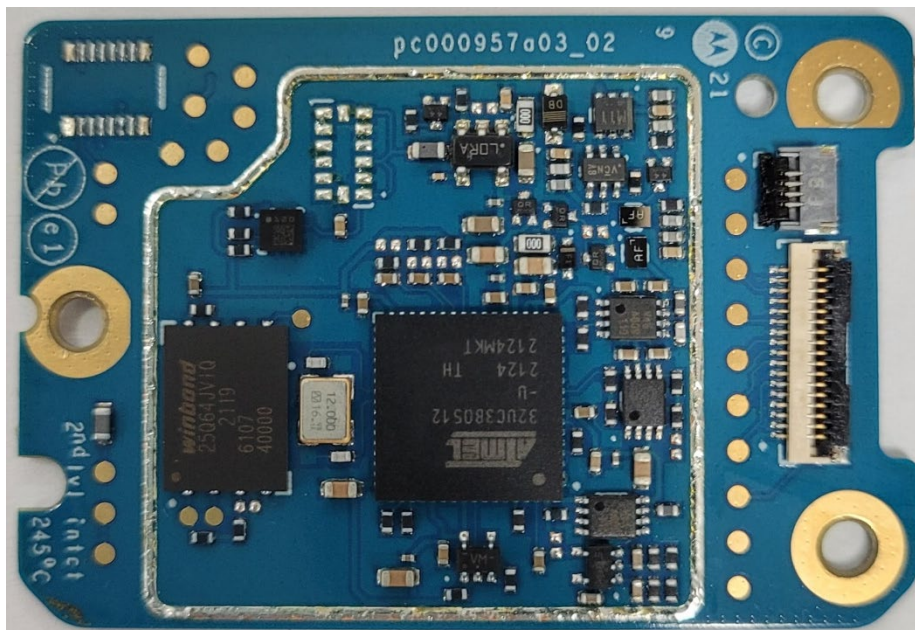

**GOB board without shields (Top)**

Exhibit 9W



**GOB board (Bottom)**